

KENWOOD

SIRIUS 

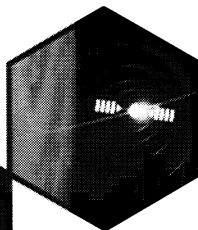

Here₂Anywhere™

KTC-H2A1

Portable SIRIUS® Tuner Instruction Manual

CONGRATULATIONS!

Your Here₂Anywhere™ Portable SIRIUS® Satellite Tuner lets you enjoy SIRIUS Satellite's digital entertainment streams anywhere you've installed one of our KPA-H2H Home Docking Kits or KPA-H2C Car Docking Kits (available separately). Use this manual to familiarize yourself with all of Here₂Anywhere's features and capabilities.

For the latest information about this and other Kenwood products, visit the Kenwood USA Corporation Web site at: www.kenwoodusa.com



Table of contents

Congratulations.....	2	Removing Here ₂ Anywhere from the dock	14
Box contents	3	Basic operation	15
Safety precautions	3	Selecting music	16
Installation in a vehicle.....	6	Setting and using stream presets	18
Mounting the antenna.....	8	Saving and recalling music information	20
Installation in a home.....	10	Display options	20
Front panel controls and features	12	Setup mode	21
Remote control functions.....	13	Troubleshooting guide	26
Activating your SIRIUS subscription.....	14	Specifications	27

Box contents

Unpack your Here₂Anywhere carefully and make sure that everything listed here is present:

1 x Here₂Anywhere main unit



1 x Remote control



2 x AAA batteries



If anything is missing or damaged, or if your Here₂Anywhere fails to operate, notify your dealer immediately. If your Here₂Anywhere was shipped to you directly, notify your shipper immediately. Kenwood recommends that you retain the original carton and packing materials in case you need to ship your Here₂Anywhere in the future.

Safety precautions

Warning

Take the following precautions to prevent traffic accidents and avoid personal injury:

- Installation must be performed according to this installation manual. Kenwood is not responsible for issues arising from installations not performed according to the procedures in this manual.
- Do not install the unit where it may obstruct your view through the windshield or of your vehicle's indicator displays.
- Do not install the unit where it may hinder the function of safety devices such as an airbag. Doing so may prevent the airbag from functioning properly in the event of an accident.
- The installation and use suggestions contained in this manual are subject to any restrictions or limitations that may be imposed by applicable law—the purchaser should check applicable law for any restrictions or limitations before installing and/or operating this unit.
- Failure to follow these safety instructions and warnings may result in a serious accident.

Warning

Take the following precautions to prevent fire and avoid personal injury:

- To avoid short circuits, never put or leave any metallic objects (coins, tools, etc.) inside the unit.
- If the unit emits smoke or strange smells, turn the power off immediately and consult your Kenwood dealer.
- Do not drop the unit or subject it to strong shocks.
- If the LCD display becomes damaged or broken, do not touch the liquid crystal fluid. The fluid may be dangerous to your health or even fatal. If the liquid crystal fluid contacts your body or clothing, immediately wash it off with soap and water.

Caution

Take the following precautions to keep the unit in proper working order:

- Be sure the unit is connected to a 12V DC power supply with a negative ground connection.
- Do not open the unit.
- Do not install the unit where it will be exposed to high levels of humidity, moisture, or dust.

- When replacing a fuse, use only a new one with the proper rating. Using a fuse with the wrong rating may cause the unit to malfunction.
- To prevent a short circuit when replacing a fuse, first disconnect the wiring harness.
- When drilling holes to mount the unit, make sure not to damage wiring or other systems on the other side.

Note

If the unit doesn't seem to be working properly:

- Turn the unit's power off, wait 5 – 10 seconds, then turn the power on again.
- If the unit still mis-operates, turn the unit's power off, remove it from the cradle, wait 5 – 10 seconds, replace it in the cradle and turn the power back on.

If the problem persists, consult your Kenwood dealer.

FCC Warning

This equipment may generate or use radio frequency energy. Changes or modifications to this equipment may cause harmful interference unless the modifications are expressly approved in this

instruction manual. The user could lose the authority to operate this equipment if an unauthorized change or modification is made.

Note

This equipment has been tested and found to comply with the limits for a Class B digital device, pursuant to Part 15 of the FCC Rules. These limits are designed to provide reasonable protection against harmful interference in a residential installation. This equipment may cause harmful interference to radio communications if it is not installed and used in accordance with these instructions. However, there is no guarantee that interference will not occur in a particular installation. If this equipment does cause harmful interference to radio or television reception, which can be determined by turning the equipment off and on, the user is encouraged to try to correct the interference by one of more of the following measures:

- Reorient or relocate the receiving antenna
- Increase the separation between the equipment and receiver

- Connect the equipment into an outlet on a circuit different from that to which the receiver is connected
- Consult the dealer or an experienced radio/TV technician for help

Cleaning the unit

If the unit becomes dirty, turn its power off and wipe it clean with a soft dry cloth.

Do not use hard cloths or paint thinner, alcohol, or other volatile solvents to clean the unit. These may cause damage or remove indicator characters.



Warning

Do not operate the unit in a way that might divert your attention from driving safely. As a driver, you alone are responsible for safely operating your vehicle in accordance with traffic safety laws at all times.

Installation in a vehicle with the KPA-H2C kit (available separately)

Note: Do not put Here₂Anywhere in the docking station until you have completed the installation.

1. Determine where you want to mount Here₂Anywhere.
2. You can bend the leaves on the base to conform to curved mounting surfaces.

- Do not install Here₂Anywhere where it may obstruct your view through the windshield or your view of your vehicle's indicator displays.
- Do not install Here₂Anywhere where it will hinder your access to the vehicle's controls.
- Do not install Here₂Anywhere where it may hinder the function of safety devices such as an airbag. Doing so may prevent the air-bag from functioning properly in the event of an accident.
- Find a location that provides good visibility of and access to Here₂Anywhere's front panel.
- Kenwood strongly recommends that you mount Here₂Anywhere in a location where the base can be attached with the provided screws.

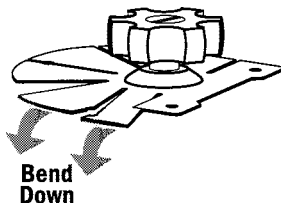

3. Peel the covering away from the adhesive on the bottom of the base and adhere it to the mounting surface. Use the provided screws to securely attach the base to the surface.
- If using screws, be sure that you do not damage wiring or other systems on the other side of the mounting surface.

4. Using the provided screw, assemble the docking station cradle to the base.

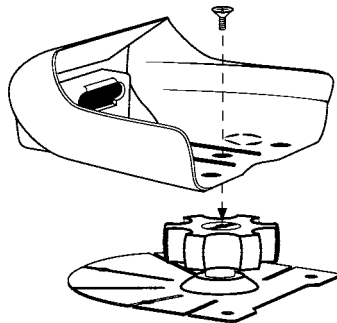

Installation in a vehicle (continued)

5. Plug the cigarette lighter adapter into the back of the cradle, as shown. Don't plug the adapter into the cigarette lighter until the installation is completed (see pg. 8, Step 4).

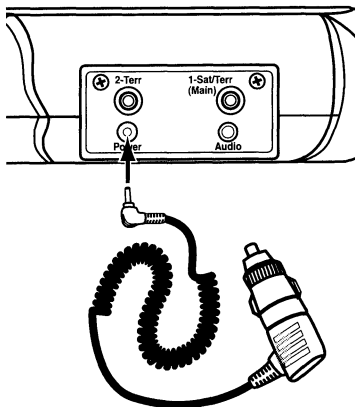

6A. Plug the cassette adapter into the back of the cradle, as shown.

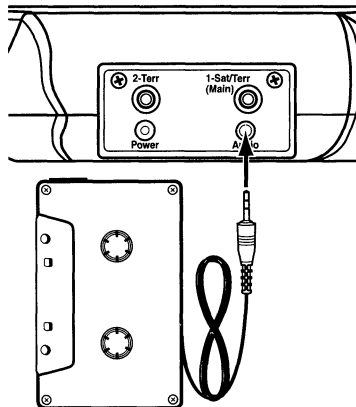

6B. If your car stereo has an aux input, plug the supplied audio cable into the back of the cradle instead of the cassette adapter. Plug the audio cable's white (L ch.) and red (R ch.) connectors into your car stereo.

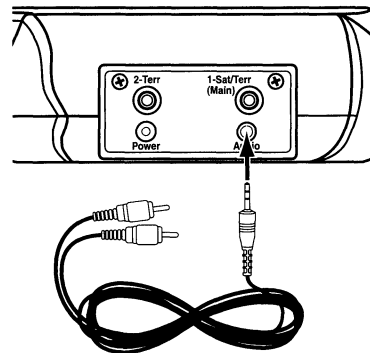

Installation in a vehicle: Mounting the antenna

1. Temporarily plug the antenna into the “1-Sat/Terr (Main)” connector on the back of the cradle until it is firmly seated, as shown.

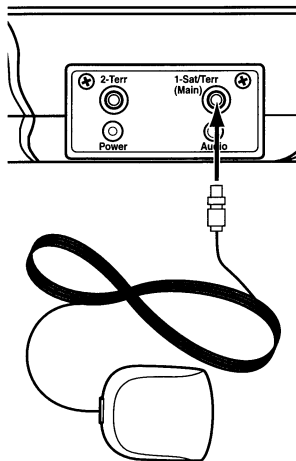

Note: If you're using the Kenwood CX-SR10 SIRIUS antenna, you'll need to remove the plastic housings from the antenna connectors—we recommend labeling the wires with their respective colors. (See pg. 9, figure 16 of the CX-SR10 Installation Manual for details). Once you've removed the housings, connect the wire that had the yellow connector to the connector on the cradle labeled “1-Sat/Terr (Main)”, and connect the other one to the connector labeled “2-Terr”.

2. Find an antenna location on a metal surface at least 12” x 12”, and at least 6” from a window.
 - Best reception is achieved with the antenna mounted on the roof; mounting on the trunk lid will work for convertibles.
 - If the vehicle has a roof rack or skid ribs, it may be necessary to mount the antenna off-center.
3. The antenna's powerful magnet will secure it to the metal surface.
 - Before routing the antenna cable, confirm that the antenna is mounted in a good location:
4. Temporarily plug the cigarette lighter adapter into the cigarette lighter.
5. Slide Here₂Anywhere all the way into the cradle so that the connector at the rear of the unit makes proper contact in the cradle. Press the POWER button to turn Here₂Anywhere on.
6. Aim the remote control at Here₂Anywhere, press the DIRECT button, then enter the number “1-8-4”, and press the SELECT button. If your Here₂Anywhere has been properly connected and the antenna is receiving the SIRIUS signal you will hear audio. If you do not hear audio, the display will read “Acquiring Signal”. Re-orient the antenna until you hear audio. (See *Antenna Signal*, on page 25 to use the ANTENNA SIGNAL screen to aim the antenna.)
 - Make sure the vehicle is not in garage, or somewhere the satellite signal could be blocked
7. Turn Here₂Anywhere's power off and remove it from the cradle; unplug the cigarette lighter adapter from the cigarette lighter; unplug the antenna from the cradle.

Installation in a vehicle: Routing the cable

8. Route the cable from the antenna to the vehicle's interior by tucking it underneath the rubber molding around rear window, as shown below.

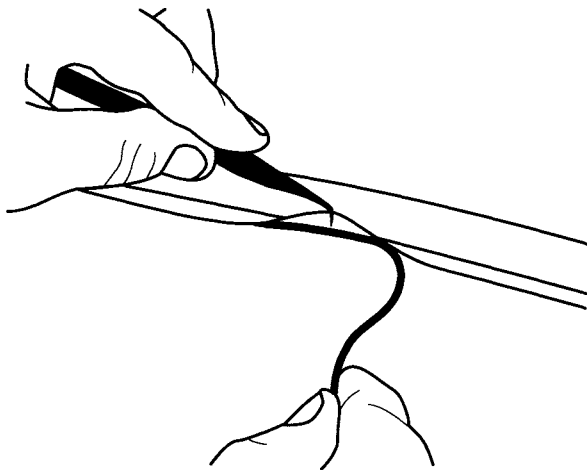

9. Route the cable from the lowest point of the rear window into the trunk. Take advantage of any existing cable channels or wiring conduits.

- For SUVs, minivans & 5-door vehicles, bring the cable into the vehicle under the rubber molding for the tailgate, and continue under the interior trim.

10. From the trunk, route the cable around the passenger compartment and to the back of the cradle.

- Do not pull the wire across sharp edges that could damage it.
- Keep the wire away from areas where it could become tangled in driver's and passenger's feet.

11. Plug the antenna into the back of cradle (see pg. 8, Step 1).

12. Plug the cigarette lighter adapter into the cigarette lighter.

- **KENWOOD RECOMMENDS UNPLUGGING THE CIGARETTE LIGHTER ADAPTER AFTER YOU TURN THE VEHICLE'S IGNITION OFF.** (In some vehicles, the cigarette lighter remains active after the ignition has been turned off, and leaving Here₂Anywhere's cigarette lighter adapter plugged-into the cigarette lighter could drain the vehicle's battery.)

Installation in a home with the KPA-H2H kit (available separately)

Note: Do not put Here₂Anywhere in the docking station until you have completed the installation.

1. Using the provided screw, assemble the docking station cradle to the base.

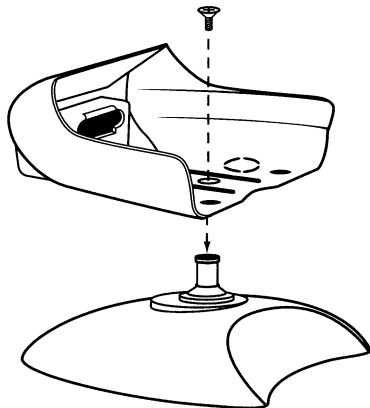

2A. Plug the audio cable's mini connector into the back of the cradle, as shown.

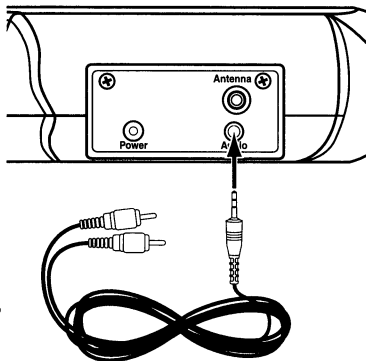

2B. Plug the audio cable's white (L ch.) and red (R ch.) connectors into your audio system.

3. Plug the AC cord into the power supply, then plug the power supply into the back of the cradle, as shown. Don't plug the AC cord into a wall outlet until the installation is completed.

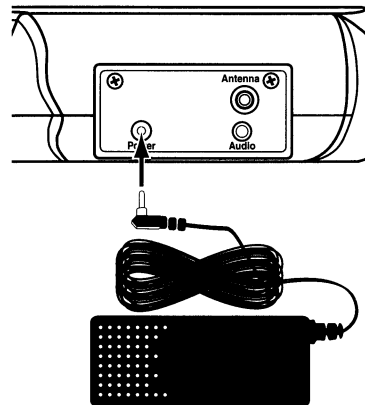

Installation in a home (continued)

4. Plug the antenna into the back of the cradle until it is firmly seated, as shown.

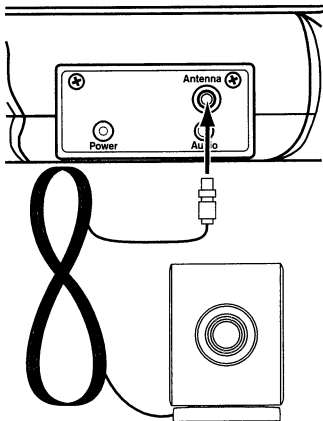

5. Due to the paths of SIRIUS satellites over the US, the best location for the antenna in your home depends on where you live. Use the map below as a general placement guideline—some experimentation may be needed to obtain the best results. In major US cities, you may also be able to receive the signal from SIRIUS ground repeaters, which may allow you to place the antenna away from a window. In all cases, since the antenna is weather-proof if necessary you can also locate it outside, clear of any overhead obstructions. (This is especially important if your house has an extended roof or extended window frame structures.) See pg. 25, *Antenna Signal*, for more information about using the ANTENNA SIGNAL screen to aim the antenna.

Section 1: Place the antenna at an *EAST-FACING window*

Section 2: Place the antenna *OUTSIDE, away from any overhead obstructions*

Section 3: Place the antenna a *WEST-FACING window*

Section 4: Place the antenna a *NORTH- or EAST-FACING window*

Section 5: Place the antenna a *NORTH-FACING window*

Section 6: Place the antenna a *WEST- or NORTH-FACING window*

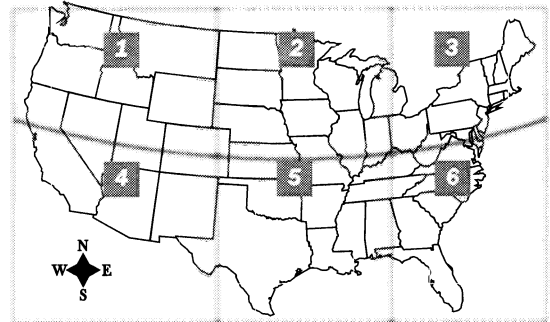

Front-panel controls and features

Up/Down/Left/Right Arrow Buttons: Navigates through display screens

Display: Shows information about streams, categories, artists, songs and setup information

Remote Control Receiver: Receives signals from the included wireless remote control

POWER Button: Turns Here₂Anywhere on and off; enters & exits the Setup Mode, and exits the Stream, Category, Song & Artist List modes

SELECT Button: Makes selections of items highlighted on the display

Preset Number Buttons: Sets and selects preset streams

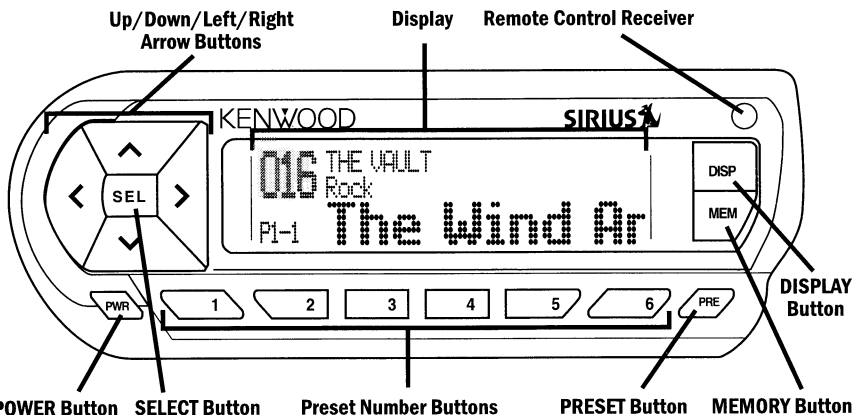

PRESET Button: Cycles-through the 4 banks of presets; enters & exits the Preset Tune Mode

MEMORY Button: Saves & recalls song & artist information; sets Parental Lock code number

DISPLAY Button: Switches the display between different modes

Remote control functions

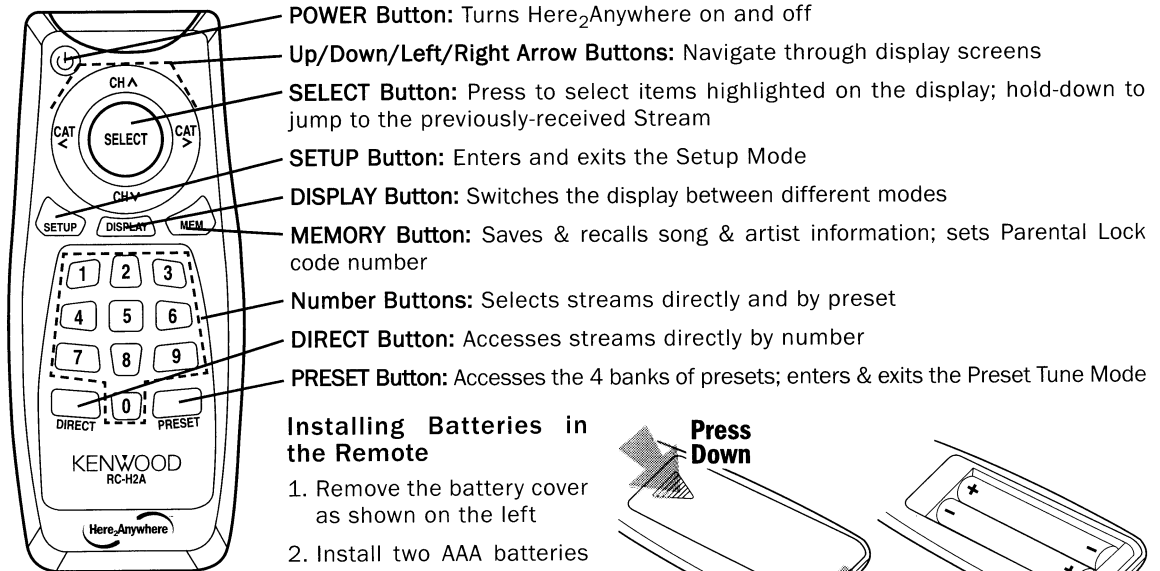

Installing Batteries in the Remote

1. Remove the battery cover as shown on the left
2. Install two AAA batteries as shown on the right
3. Replace the battery cover

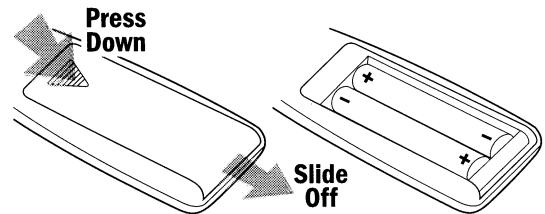

Activating your SIRIUS subscription

Before you can listen to Here₂Anywhere, you must subscribe to SIRIUS Satellite's service.

1. Make sure that Here₂Anywhere is properly connected and that its antenna is oriented to receive the SIRIUS satellite signal (see *Installation* sections for details).
2. Press the power button to turn Here₂Anywhere on. After displaying the Kenwood and SIRIUS logos, the display will read "Acquiring Signal". Once the SIRIUS satellite signal is received, the display will change to "Call 1-888-539-SIRIUS to Subscribe".
3. Aim the remote control at Here₂Anywhere, press the DIRECT button, enter the number "1-8-4", and press the SELECT button. If your Here₂Anywhere has been properly connected and the antenna is receiving the SIRIUS signal you will hear audio. If you do not hear audio, re-orient the antenna until you do. (See *Antenna Signal*, on page 25 to use the ANTENNA SIGNAL screen.)
 - Channel 184 is the SIRIUS preview channel. You will not be able to tune to any other channels until you activate your SIRIUS subscription.

4. Hold the POWER button for at least 1 second to enter the Setup Mode.
5. Your unit's unique 12-digit SIRIUS ID Number will be displayed (right). Write the number down and have your credit card handy.
6. Contact SIRIUS on the Internet at: <https://customercommand.siriusradio.com/consumerWeb/index.jsp>. Follow the prompts to activate your subscription.
 - You can also call SIRIUS toll-free at 1-888-539-SIRIUS (7474). The operator will instruct you.

Removing Here₂Anywhere from the dock

To remove Here₂Anywhere from the docking station, press the button on the underside of the unit and gently slide Here₂Anywhere out of the cradle.

Replace it by sliding the unit all the way into the cradle so that the connector at the rear of the unit makes proper contact in the cradle.

Basic operation

After you have successfully activated your SIRIUS subscription, the Normal Operation screen will appear (*top right*):

Use the up & down arrow buttons to select streams

- The selected stream will automatically play

The name and artist of the currently-playing song will scroll across the display

If you want to listen to a different entertainment category, press the left & right arrow buttons to activate the Category Select screen (*bottom right*):

1. Use the left & right arrow buttons to select entertainment categories
2. When the category you want is highlighted, use the up & down arrow buttons to highlight the stream you want to hear
3. When the stream you want is highlighted, press the SELECT button to listen to the stream. The display will revert to the Normal Operation screen for that stream.

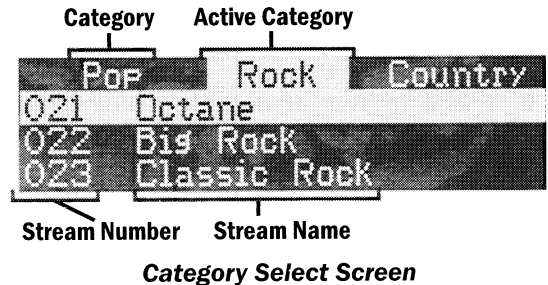
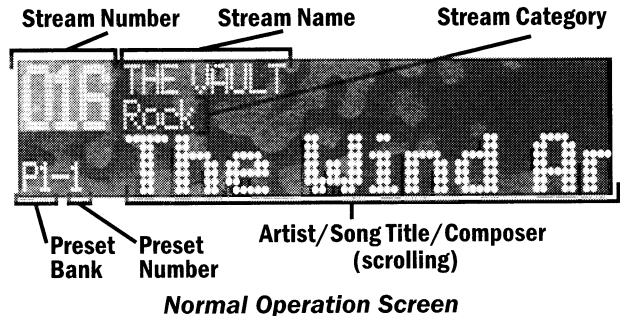

- If you decide not to select another stream, press the POWER button to exit the mode. The display will revert to the Normal Operation screen for the active stream.
 - You can switch to the previously-selected stream by holding the SELECT button for at least 1 second. Holding the SELECT button for 1 second again switches back to the original stream.
 - If no streams are available in a category, or if all of the streams are set to be skipped or locked, the display will read “No Channels Available” when that category is highlighted. (See *Channel Skip/Lock* on pg 21–22.)

Selecting music

In addition to the Normal Operation and Category Select screens, Here₂Anywhere has three ways to search for and select music: by stream, by artist, and by song.

Selecting music by stream (Stream List Mode)

- Press the Select button while in the Normal Operation mode. The Stream List screen will appear, showing all available streams regardless of category (*right*):
- Use the up & down arrow buttons to move through the streams. If you stop on a stream it will play.
- When the stream you want is highlighted, press the SELECT button to return to the Normal Operation screen.

Stream Number	Stream Name
120	ESPN Radio Network
121	ESPNews
123	Sports Byline USA
124	Speed Channel Radio

Stream List Screen

Selecting music by artist (Artist List Mode)

1. While the Normal Operation screen is active, press the DISPLAY button twice. The Artist List screen will appear, showing all currently-playing artists regardless of category (*top, right*):
 - If composer information is available for a stream, it will be displayed along with the artist information
2. Use the up & down arrow buttons to move through the list of artists
3. When the artist you want to hear is highlighted, press the SELECT button to listen to them
 - After you make your selection, the display will revert to the Normal Operation screen

Stream Number	Artist Name
020	Ernie Bledsoe
021	Jusalbandi
022	The Cheaters
023	Scott Miller

Artist List Screen

Selecting music by song (Song List Mode)

1. While the Normal Operation screen is active, press the DISPLAY button three times. The Song List screen will appear, showing all currently-playing songs regardless of category (*bottom, right*):
 - Song titles too long to fit on the highlight bar will scroll
2. Use the up & down arrow buttons to move through the list of songs
3. When the song you want to hear is highlighted, press the SELECT button to listen to it

Stream Number	Song Title
020	Quittin' Time
021	Uncle Sun
022	Breaking Glass
023	Sally's Eyes

Song List Screen

- After you make your selection, the display will revert to the Normal Operation screen

Note: In the Stream List, Artist List and Song List modes, if you don't want to make a selection, press the POWER button to exit the mode and return to the Normal Operation screen for the active stream.

Setting/using stream presets

Setting stream presets

You can store up to 24 of your favorite streams as presets, for quick access. Presets are stored in 4 banks, each containing 6 stream presets.

1. Press the PRE (Preset) button to activate the preset bank you want. The selected bank is shown in the lower left corner of the Normal Operation Screen (*right*).
2. Select the stream you want to preset (see *Basic Operation* and *Selecting Music*, pg. 15–16)
3. Hold the number button you want to store the stream in for at least 2 seconds
 - The selected preset number will flash and then remain lit on the display to show that it has been memorized.
 - If the preset button already has a stream stored in it, it will be replaced with the new stream

Tuning stream presets

The 6 presets in the active bank can be selected by pressing the “1” – “6” buttons

1. Press the PRE button to cycle through the four banks of preset stations. The display will show the current preset bank and active preset number in the lower left corner.



**Normal Operation Screen, showing
Preset Bank and Preset Number
Readout**

2. When the desired preset bank is displayed, use the “1” – “6” buttons to tune the desired preset stream

Searching for a stream preset (Preset List Screen)

There are two ways you can search for a stream preset.

For both, hold the PRE button for at least 1 second to enter the Preset Tune mode. The Normal Operation Screen will change so that the preset bank and preset number will be highlighted (*top, right*).

Option 1: Use the up & down arrow buttons to move through the presets. Each time you change a preset its number will appear on the display and the stream will play.

Option 2: Press the SELECT button. The Preset List Screen will appear on the display, listing all of the stream presets that have been programmed (*bottom, right*)

- Use the cursor up & down buttons to scroll through the list. Press the SELECT button when the desired stream is highlighted on the display to select it.

In either mode, when you're finished searching for a preset, press the POWER button to exit and return to the Normal Operation Screen.



Preset Tune Screen

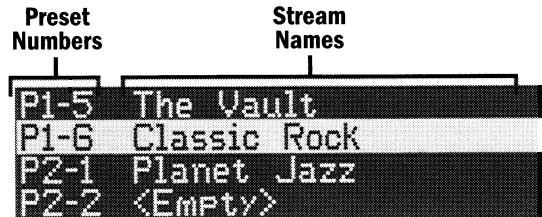

Preset List Screen

Saving/recalling music information

Saving music information

You can store the name of the currently-playing song and artist (and composer, if the data is available) into memory for recall later.

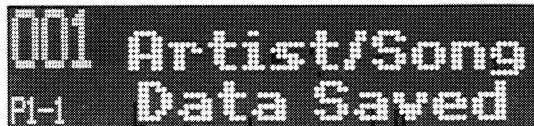

Press the MEM button to save the data. The screen will display the following message (above):

- You can save data for up to 24 songs. Once all 24 places have been filled, any new artist/song data you save will replace the oldest data.

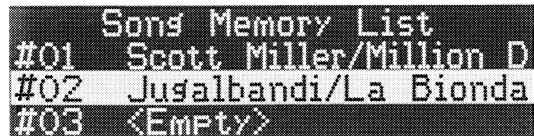

Song Memory List Screen

Recalling music information

1. Hold the MEM button for more than 1 second. The Song Memory List screen will appear (right):
2. Use the up & down arrow buttons to scroll through the list

Display options

Changing display modes

The Normal Operation

Screen has two display modes, Normal and Large Font.

Press the DISPLAY button to cycle the display between the two modes (above).



Normal Operation Screen

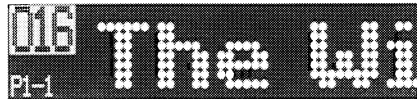

Large Font Screen

Adjusting the display brightness

Hold the DISPLAY button down for over 1 second to enter the Display Brightness mode (*right*):

1. Use the up & down arrow buttons to select the desired brightness level (high/medium/low)
2. Press the SELECT button to save your selection
 - Press the DISPLAY button to exit this mode

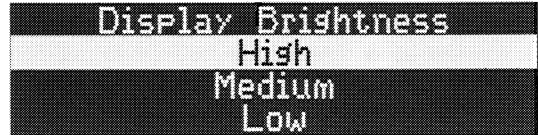

Display Brightness Screen

Setup Mode

The Setup Mode lets you access and set up the following features: SID (SIRIUS ID Number), Channel Skip/Lock, Lock Code Setup, Startup Mode, Output Level, and Antenna Signal.

To enter the Setup Mode, hold the POWER button for at least 1 second. Use the left & right arrow buttons to move to the setup feature you want, and press the SELECT button to select the feature. To exit the Setup Mode and return to the previous operation mode, press the POWER button at any time while the Setup Mode is active.

SID

When you first enter the Setup Mode, the unit's unique 12-digit SIRIUS ID Number will be displayed (*right*):



SIRIUS ID Screen

Channel Skip/Lock

This allows you to select streams that you want to skip when scanning up and down the Channel List and Category List screens, or simply when you're pressing the cursor up & down buttons.

1. While in the Setup Mode, press the left or right arrow button until the Channel Skip screen appears (*right*):
2. Use the up & down arrow buttons to highlight the stream you want. (The highlighted stream will automatically play.)
3. Press the SELECT button to change the highlighted stream's status from "available" (+) to "skip" (-).
 - To exit the Channel Skip function, press the left or right arrow button. The screen will display the next Setup Menu item.

You can further lock a stream by placing it in the Channel Lock mode. Locked streams will be unavailable during all tuning modes, and cannot be directly accessed via the remote control.

To lock a stream, in Step 3 above, instead of momentarily pressing the SELECT button, hold the button for more than 1 second. A "-" and a padlock will be displayed next to the stream number.

Lock Code Setup

If you have locked any streams in the Channel Lock mode, you will need to enter a 4-digit lock code to unlock them. The factory default lock code is "1 1 1 1".

You can change the Lock Code to your own preference:

1. While in the Setup Mode, press the left or right arrow button until the Lock Code Setup screen appears (*right*):

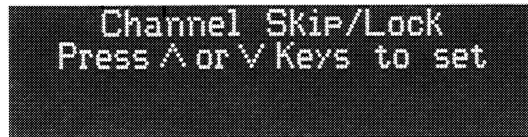

Channel Skip Screen

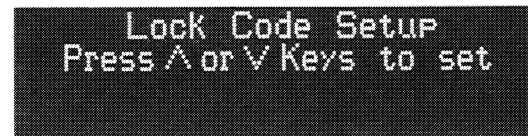

Lock Code Setup Screen

2. Press the up or down arrow button. The Lock Code screen appears (*top, right*):
3. Using the preset 1 – 6 buttons, enter the factory default code “1 1 1 1”. The screen’s second line will change from “_ _ _ _” to “* * * *”.
 - If you enter an incorrect number, use the left arrow button to delete the incorrect number; then re-enter the correct one.
4. Press the Memory button. The Enter New Lock Code screen appears (*middle, right*).
 - If you entered the code incorrectly, “Code Error” will be displayed, and the Enter New Lock Code screen reappears. Repeat Steps 3 – 4.
5. Using the preset 1 – 6 buttons, enter your new 4-digit code. The screen’s second line will change from “_ _ _ _” to “* * * *”.
6. Press the MEMORY button. The Confirm Number screen appears (*bottom, right*).
7. Re-enter your new 4-digit code. The screen’s second line will change from “_ _ _ _” to “* * * *”.



```
Lock Code
Enter Lock Code and
Press MEM Key
```

Lock Code Screen



```
Enter New Lock Code
Enter Code using 1-6 and
Press MEM Key
```

Enter New Lock Code Screen



```
Confirm number
Enter Code using 1-6 and
Press MEM Key
```

Confirm Number Screen

8. Press the MEMORY button. The display will change to “New Code Confirmed”

- If you entered the code incorrectly, “Code Error” will be displayed, and the Enter New Lock Code screen reappears. Repeat Steps 5 – 8.

Startup Mode

You can select which screen is displayed when you turn Here₂Anywhere’s power on.

1. While in the Setup Mode, press the left or right arrow button until the Startup Mode screen appears (*right*):
2. Use the up & down arrow buttons to highlight the screen you want for Startup: Normal Operation, Channel List (Stream List) or Category List:

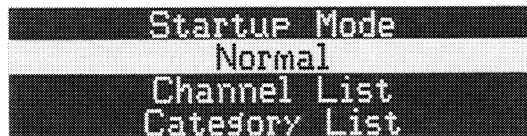

Startup Mode Screen

3. Press the SELECT button.



Normal Screen



Stream List Screen

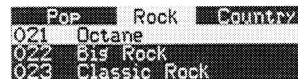

Category List Screen

Output Level

You can adjust Here₂Anywhere’s output level so it matches other sources in your audio system.

1. While in the Setup Mode, press the left or right arrow button until the Output Level screen appears (*right*):
2. Use the up & down arrow buttons to select the desired output level.

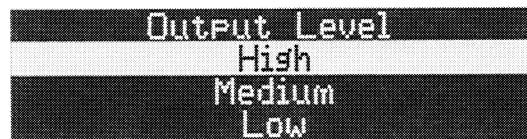

Output Level Screen

- “High” is 0dB, “Medium” is -3dB and “Low” is -6dB.

Note: To avoid distortion with some cassette car stereos, you may have to lower the output level when using the cassette adapter.

Antenna Signal

This screen shows the quality of the SIRIUS satellite signal that’s being received, to help you find the best location for the antenna.

1. While in the Setup Mode, press the left or right arrow button until the Antenna Signal screen appears (*right*):

- After a few seconds the signal quality bars will indicate how well the antenna is receiving the SIRIUS satellite signal.



Antenna Signal Screen

2. Find a location for the antenna that illuminates the maximum number of bars.
 - After moving the antenna, wait at least 2 seconds before moving it again, to enable the unit to process the signal.
3. Due to the moving paths of the SIRIUS satellites, it is possible for the signal to change over time. In most cases, signal should be available continuously, however, it may be temporarily blocked in some antenna locations in home installations. Be sure to check the the Antenna Signal screen if there is a loss of signal or audio. Experimentation with antenna placement in the home or outside may be necessary to ensure continuous reception.
 - See pg. 11, Step 5 for information about locating the SIRIUS antenna in a home installation.

Troubleshooting guide

Problem	Possible Cause	Solution
No power on Here ₂ Anywhere (power indicator /display not illuminated)	Power supply/cigarette lighter adapter not properly connected	Make sure power supply/adapter is properly connected
	Blown fuse in cigarette lighter adapter	Check the fuse; if blown, replace with supplied spare fuse
No sound	Audio cable/cassette adapter not properly connected	Make sure cable/adapter is properly connected
Display reads "Acquiring Signal"	Signal is weak or can't be found	Check the <i>Antenna Signal</i> screen (see page 25); Change the antenna/vehicle location to maximize signal quality
Display reads "Antenna Error"	The antenna is not connected	Verify antenna connections
	The antenna or cable is faulty	Replace antenna
Display reads "Call 1-888-539-SIRIUS to Subscribe"	SIRIUS subscription has not been activated	Call SIRIUS to activate your subscription
Display reads "Invalid Channel"	Stream entered is invalid	Select a different SIRIUS stream

Troubleshooting Guide (continued)

<i>Problem</i>	<i>Possible Cause</i>	<i>Solution</i>
Here, Anywhere operates erroneously	Microprocessor error	Turn the power off (press the POWER button), wait 5 - 10 seconds, then turn the power on again.
		Turn the unit's power off, remove it from the dock, wait 5 - 10 seconds, replace it in the dock and turn the power back on.
		If the problem persists, consult your Kenwood dealer.

Specifications:

Audio output (100 ~ 250 ohms)950mV RMS
Fuse3A fast blow
Power supply requirements9 ~ 16V, negative ground
Dimensions5"(W) x 4 ⁵ / ₁₆ "(D) x 1 ³ / ₄ "(H)

The Kenwood logo consists of the word "KENWOOD" in a white, bold, sans-serif font, centered within a solid black rectangular background.

www.kenwoodusa.com

www.kenwoodusa.com/inquiry

1-800-KENWOOD

Main Office

P.O. Box 22745

Long Beach, CA 90801-5745

©2003 Kenwood USA Corporation.
All Rights Reserved.

KENWOOD

LIMITED WARRANTY CERTIFICATE



RETAIN THIS CERTIFICATE FOR YOUR RECORDS

Note: We suggest that you attach your original sales receipt to this certificate as proof of warranty coverage

Name of purchaser, to whom warranty runs

Model number

Serial number

**SEE REVERSE SIDE FOR TERMS AND CONDITIONS.
PLEASE READ THEM CAREFULLY.**

USE THIS CERTIFICATE WHEN:

- Inquiring about warranty service and information
- Obtaining warranty service

To find your nearest KENWOOD
Authorized Service Center, call:

IN THE CONTINENTAL UNITED STATES
1-800-536-9663

24 HOURS A DAY, 7 DAYS A WEEK

This warranty will be honored only in the U.S.A.

KENWOOD LIMITED WARRANTY FOR HERE₂ANYWHERE™ PRODUCTS

HOW LONG IS THE WARRANTY

Kenwood USA Corporation ("Kenwood") warrants this product for a period of one (1) year from the date of original purchase.

WHAT IS COVERED AND WHAT IS NOT COVERED

Except as specified below, this warranty covers all defects in material and workmanship in Kenwood Here₂Anywhere™ products.

The following are not covered by the warranty:

1. Any product which is not distributed in the USA by Kenwood or which is not purchased in the USA from an authorized Kenwood dealer, unless the product is purchased through the U.S.A Military Exchange Service.
2. Any product on which the serial number has been defaced, modified or removed.
3. Damage, deterioration or malfunction resulting from:
 - a. Any shipment of the product (claims must be presented to the carrier).
 - b. Installation or removal of the product.
 - c. Accident, acts of nature, misuse, abuse, neglect, unauthorized product modification or failure to follow instructions contained in the instruction or Installation Manual.
 - d. Repair or attempted repair by anyone not authorized by Kenwood.
 - e. Any other cause which does not relate to a product defect.

WHO IS PROTECTED

This warranty is enforceable only by the original purchaser.

WHAT WE WILL PAY FOR

We will pay for all labor and material expenses for covered items. Payment of shipping charges is discussed in the next section of this warranty.

HOW TO OBTAIN WARRANTY SERVICE

If your KENWOOD product ever needs service:

1. Take or ship it to any KENWOOD Authorized Service Center in the USA along with a complete description of the problem. (If you are uncertain as to whether a Service Center is authorized, please call **1-800-KENWOOD (1-800-526-9663)** for the nearest Service Center.
2. Although you must pay any shipping charges if it is necessary to ship the product for warranty service, we will pay the return shipping charges if the repairs are covered by the warranty within the United States.
3. Whenever your units are taken or sent for warranty service, you must include a copy of the original dated sales receipt as proof of warranty coverage.

LIMITATION OF IMPLIED WARRANTIES

ALL IMPLIED WARRANTIES, INCLUDING WARRANTIES OF MERCHANTABILITY AND FITNESS FOR A PARTICULAR PURPOSE, ARE LIMITED IN DURATION TO THE LENGTH OF THIS WARRANTY.

EXCLUSION OF DAMAGES

KENWOOD'S LIABILITY FOR ANY DEFECTIVE PRODUCT IS LIMITED TO THE REPAIR OR REPLACEMENT OF THE PRODUCT. AT OUR OPTION, KENWOOD SHALL NOT BE LIABLE FOR:

1. INSTALLATION OR REMOVAL CHARGES, DAMAGE TO OTHER PROPERTY CAUSED BY ANY DEFECTS IN KENWOOD CAR STEREO COMPONENTS, DAMAGES BASED UPON INCONVENIENCE, LOSS OF USE OF THE PRODUCT; OR
2. ANY OTHER DAMAGES, WHETHER INCIDENTAL, CONSEQUENTIAL OR OTHERWISE.

SOME STATES DO NOT ALLOW LIMITATIONS ON HOW LONG AN IMPLIED WARRANTY LASTS AND/OR DO NOT THE EXCLUSION OR LIMITATION OF INCIDENTAL OR CONSEQUENTIAL DAMAGES, SO THE ABOVE LIMITATIONS AND EXCLUSIONS MAY NOT APPLY TO YOU.

This warranty gives you specific legal rights, and you may also have other rights which vary from state to state.

If a problem develops during or after the Limited Warranty Period, or if you have any questions regarding the operation of the product, you should contact your KENWOOD Authorized Dealer or Authorized Service Center. If the problem or your question is not handled to your satisfaction, please contact our Customer Relations Department at the address listed below:

KENWOOD USA CORPORATION

P.O Box 22745, 2201 East Dominguez Street, Long Beach CA 90801-5745

Tel: (310) 639-5300

ANTENNA PLACEMENT GUIDE FOR Here₂Anywhere HOME KITS



Antenna Placement Map

Section 1: Place antenna at an *EAST-FACING* window

Section 2: Place antenna *OUTSIDE*, away from any overhead obstructions

Section 3: Place antenna at a *WEST-FACING* window

Section 4: Place antenna at a *NORTH or EAST-FACING* window

Section 5: Place antenna at a *NORTH-FACING* window

Section 6: Place antenna at a *WEST or NORTH-FACING* window

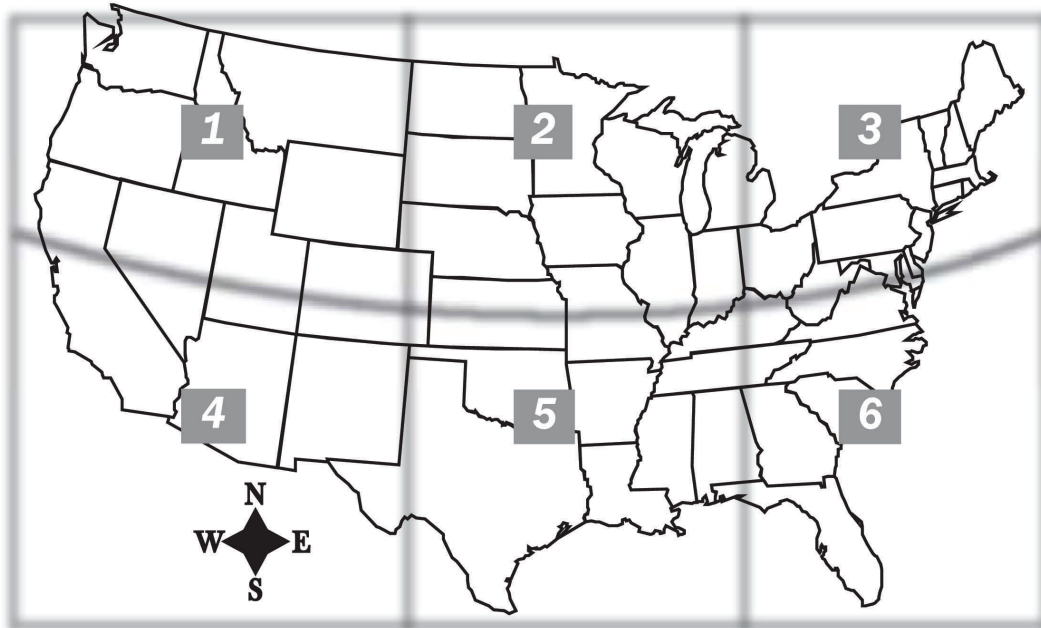

- In Major cities with heavy repeater signal, antenna may receive SIRIUS away from window
- Antenna is weather-proof and can safely be used outside
- SIRIUS satellites are moving so signal strength can fluctuate over time

Using the Antenna Signal Screen

1. Enter Setup Mode by holding the POWER button for 2 seconds
2. Use the left or right arrow buttons to access the Antenna Signal Screen (below)



3. Wait a few seconds for the signal quality bars to indicate your signal strength
4. Find an antenna location that illuminates the maximum number of bars

NOTE: After moving the antenna, wait at least 2 seconds before moving it again, to enable the unit to process the signal.

Free Manuals Download Website

<http://myh66.com>

<http://usermanuals.us>

<http://www.somanuals.com>

<http://www.4manuals.cc>

<http://www.manual-lib.com>

<http://www.404manual.com>

<http://www.luxmanual.com>

<http://aubethermostatmanual.com>

Golf course search by state

<http://golfingnear.com>

Email search by domain

<http://emailbydomain.com>

Auto manuals search

<http://auto.somanuals.com>

TV manuals search

<http://tv.somanuals.com>