

# KENWOOD

## KDC-2021S

CD-RECEIVER

### INSTRUCTION MANUAL

CD RECEIVER

### GEBRUIKSAANWIJZING

REPRODUCTOR DE DISCOS COMPACTOS RECEPTOR DE FM/AM

### MANUAL DE INSTRUCCIONES

CD-RECEIVER

### BRUKSANVISNING

CD-VASTAANOTTIMEN

### KÄYTTÖOHJE

KENWOOD CORPORATION



© B64-2232-00 (EY)

## Contents

<b>Safety precautions.....</b>	<b>3</b>	<b>CD player features.....</b>	<b>11</b>
<b>About CDs.....</b>	<b>5</b>	Playing CD	
<b>General features .....</b>	<b>6</b>	Fast Forwarding and Reversing	
Power		Track Search	
Selecting the Source		Track Repeat	
Volume		Track Scan	
Attenuator		Random Play	
Loudness		<b>Accessories.....</b>	<b>13</b>
System Q		<b>Installation Procedure .....</b>	<b>13</b>
Audio Control		<b>Connecting Wires to Terminals</b>	<b>14</b>
Speaker Setting		<b>Installation .....</b>	<b>15</b>
Clock Display		<b>Troubleshooting Guide .....</b>	<b>17</b>
Adjusting Clock		<b>Specifications .....</b>	<b>19</b>
DSI (Disabled System Indicator)			
Theft Deterrent Faceplate			
TEL Mute			
<b>Tuner features.....</b>	<b>9</b>		
Tuning Mode			
Tuning			
Monaural Reception			
Station Preset Memory			
Auto Memory Entry			
Preset Tuning			

## Safety precautions

---

### **▲WARNING**

**To prevent injury and/or fire, take the following precautions:**

- Insert the unit all the way until it is fully locked in place. Otherwise it may fly out of place during collisions and other jolts.
- When extending the ignition, battery or ground wires, make sure to use automotive-grade wires or other wires with an area of 0.75mm<sup>2</sup> (AWG18) or more to prevent wire deterioration and damage to the wire coating.
- To prevent short circuits, never put or leave any metallic objects (e.g., coins or metal tools) inside the unit.
- If the unit starts to emit smoke or strange smells, turn off the power immediately and consult your Kenwood dealer.
- Make sure not to get your fingers caught between the faceplate and the unit.
- Be careful not to drop the unit or subject it to strong shock.  
The unit may break or crack because it contains glass parts.
- Do not touch the liquid crystal fluid if the LCD is damaged or broken due to shock. The liquid crystal fluid may be dangerous to your health or even fatal.  
If the liquid crystal fluid from the LCD contacts your body or clothing, wash it off with soap immediately.

### **▲CAUTION**

**To prevent damage to the machine, take the following precautions:**

- Make sure to ground the unit to a negative 12V DC power supply.
- Do not open the top or bottom covers of the unit.
- Do not install the unit in a spot exposed to direct sunlight or excessive heat or humidity. Also avoid places with too much dust or the possibility of water splashing.
- Do not set the removed faceplate or the faceplate case in areas exposed to direct sunlight, excessive heat or humidity. Also avoid places with too much dust or the possibility of water splashing.
- To prevent deterioration, do not touch the terminals of the unit or faceplate with your fingers.
- Do not subject the faceplate to excessive shock, as it is a piece of precision equipment.
- When replacing a fuse, only use a new one with the prescribed rating. Using a fuse with the wrong rating may cause your unit to malfunction.
- To prevent short circuits when replacing a fuse, first disconnect the wiring harness.
- Do not place any object between the faceplate and the unit.
- During installation, do not use any screws except for the ones provided. The use of improper screws might result in damage to the main unit.

### **Do Not Load 8-cm (3-in.) CDs in the CD slot**

If you try to load an 8-cm CD with its adapter into the unit, the adapter might separate from the CD and damage the unit.

## Safety precautions

### NOTE

- If you experience problems during installation, consult your Kenwood dealer.
- If the unit does not seem to be working right, try pressing the reset button first. If that does not solve the problem, consult your Kenwood dealer.

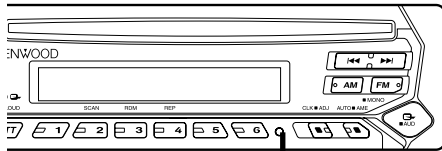

Reset button

- Characters in the LCD may become difficult to read in temperatures below 41 °F (5 °C).
- The illustrations of the display and the panel appearing in this manual are examples used to explain more clearly how the controls are used. Therefore, what appears on the display in the illustrations may differ from what appears on the display on the actual equipment, and some of the illustrations on the display may represent something impossible in actual operation.

### Lens Fogging

Right after you turn on the car heater in cold weather, dew or condensation may form on the lens in the CD player of the unit. Called lens fogging, CDs may be impossible to play. In such a situation, remove the disc and wait for the condensation to evaporate. If the unit still does not operate normally after a whilst, consult your Kenwood dealer.

### Cleaning the Faceplate Terminals

If the terminals on the unit or faceplate get dirty, wipe them with a dry, soft cloth.

### Cleaning the Unit

If the faceplate of this unit is stained, wipe it with a dry soft cloth such as a silicon cloth. If the faceplate is stained badly, wipe the stain off with a cloth moistened with neutral cleaner, then wipe neutral detergent off.



Applying spray cleaner directly to the unit may affect its mechanical parts. Wiping the faceplate with a hard cloth or using a volatile liquid such as thinner or alcohol may scratch the surface or erases characters.

### Cleaning the CD Slot

As dust can accumulate in the CD slot, clean it occasionally. Your CDs can get scratched if you put them in a dusty CD slot.

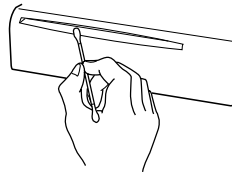

### The marking of products using lasers (Except for some areas)

## CLASS 1 LASER PRODUCT

The label is attached to the chassis/case and says that the component uses laser beams that have been classified as Class 1. It means that the unit is utilizing laser beams that are of a weaker class. There is no danger of hazardous radiation outside the unit.

## About CDs

### Handling CDs

- Don't touch the recording surface of the CD.

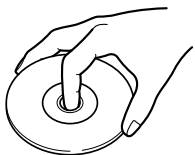

- CD-R and CD-RW are easier to damage than a normal music CD. Use a CD-R or a CD-RW after reading the caution items on the package etc.
- Don't stick tape etc. on the CD. Also, don't use a CD with tape stuck on it.

### When using a new CD

If the CD center hole or outside rim has burrs, use it after removing them with a ball pen etc.

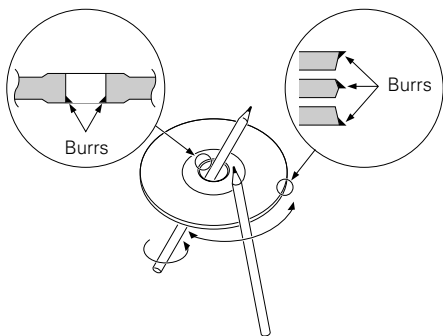

### CD accessories

Don't use disc type accessories.

### CD cleaning

Clean from the center of the disc and move outward.

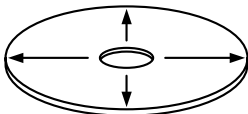



### Removing CDs

When removing CDs from this unit pull them out horizontally.

### CDs that can't be used

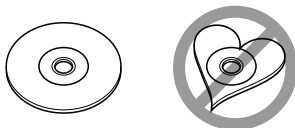
- CDs that aren't round can't be used.



- CDs with coloring on the recording surface or that are dirty can't be used.
- Don't use CDs without disc mark  

- A CD-R or CD-RW that hasn't been finalized can't be played. (For the finalization process refer to your CD-R/CD-RW writing software, and your CD-R/CD-RW recorder instruction manual.)

### CD storage

- Don't place them in direct sunlight (On the seat or dashboard etc.) and where the temperature is high.
- Store CDs in their cases.

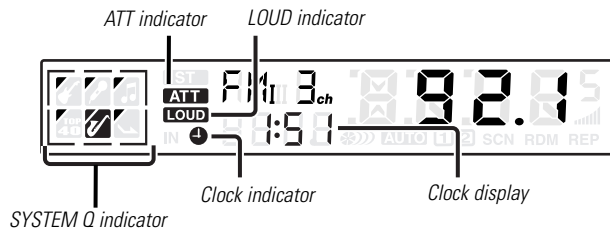
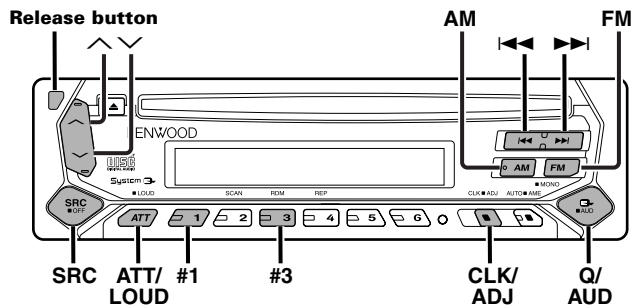
## General features



### Power

#### Turning ON the Power

Press the [SRC] button.

#### Turning OFF the Power

Press the [SRC] button for at least 1 second.

### Selecting the Source

Press the [SRC] button.

#### Source required

#### Display

Tuner

"TUnE"

CD

"CD"

Standby (Illumination only mode)

"OFF"

### Volume

#### Increasing Volume

Press the [^] button.

#### Decreasing Volume

Press the [v] button.

### Attenuator

Turning the volume down quickly.

Press the [ATT] button.

Each time the button is pressed the Attenuator turns ON or OFF. When it's ON, the "ATT" indicator blinks.

## Loudness

Compensating for low and high tones during low volume.

Press the [LOUD] button for at least 1 second.

Each time the button is pressed for at least 1 second the Loudness turns ON or OFF.

When it's ON, "LOUD" indicator is ON.

## System Q

You can recall the best sound setting preset for different types of the music.

### 1 Select the source to set

Press the [SRC] button.

### 2 Select the Sound type

Press the [Q] button.

Each time the button is pressed the sound setting switches.

Sound setting	Display
Flat	"SQ-1"
Rock	"SQ-2"
Top 40	"SQ-3"
Pops	"SQ-4"
Jazz	"SQ-5"
Easy	"SQ-6"
Scan of Flat — Easy	"SCAN"



- Each setting value is changed with the <Speaker setting> (page 8).  
First, select the speaker type with the Speaker setting.
- When the System Q setting is changed, the Bass, Middle, and Treble set in audio control replace the System Q values.

## Audio Control

### 1 Select the source for adjustment

Press the [SRC] button.

### 2 Enter Audio Control mode

Press the [AUD] button for at least 1 second.

### 3 Select the Audio item for adjustment

Press the [FM] or [AM] button.

Each time the button is pressed the items that can be adjusted switch as shown below.

### 4 Adjust the Audio item

Press the [◀◀] or [▶▶] button.

Adjustment Item	Display	Range
Bass level	"BAS"	-8 — +8
Middle level	"MID"	-8 — +8
Treble level	"TRE"	-8 — +8
Balance	"BL"	Left 15 — Right 15
Fader	"FD"	Rear 15 — Front 15

### 5 Exit Audio Control mode

Press the [AUD] button.

## General features

### Speaker Setting

Fine-tuning so that the System Q value is optimal when setting the speaker type.

#### 1 Enter Standby

Press the [SRC] button.  
Select the "OFF" display.

#### 2 Enter Speaker Setting mode

Press the [Q] button.

#### 3 Select the Speaker type

Press the [◀◀] or [▶▶] button.

Each time the button is pressed the setting switches as shown below.

Speaker type	Display
OFF	"SP-F"
For the OEM speaker	"SP-O"
For 6 & 6x9 in. speaker	"SP-6"
For 5 & 4 in. speaker	"SP-5"

#### 4 Exit Speaker Setting mode

Press the [Q] button.

### Clock Display

Press the [CLK] button.

Each time the button is pressed the clock display turns ON or OFF.

When it's ON, the clock indicator is ON.

### Adjusting Clock

#### 1 Select the clock display

Press the [CLK] button.

#### 2 Enter clock adjustment mode

Press the [CLK] button for at least 2 seconds.  
The clock display blinks.

#### 3 Adjust the hours

Press the [FM] or [AM] button.

#### Adjust the minutes

Press the [◀◀] or [▶▶] button.

#### 4 Exit clock adjustment mode

Press the [CLK] button.

### DSI (Disabled System Indicator)

A red indicator will blink on the unit after the faceplate is removed, warning potential thieves.

#### 1 Turn the power OFF

Press the [SRC] button for at least 1 second.

#### 2 Set the DSI

While pressing the [#1] and [#3] button, press the [SRC] button.

Each time the step 1 and 2 operation is done the DSI turns ON or OFF.

### Theft Deterrent Faceplate

The faceplate of the unit can be detached and taken with you, helping to deter theft.

#### Removing the Faceplate

Press the Release button.

The faceplate is unlocked, allowing you to detach it.



- The faceplate is a precision piece of equipment and can be damaged by shocks or jolts. For that reason, keep the faceplate in



its special storage case while detached.

- Do not expose the faceplate or its storage case to direct sunlight or excessive heat or humidity. Also avoid places with too much dust or the possibility of water splashing.

### Reattaching the Faceplate

- 1 Align the projections on the unit with the grooves on the faceplate.

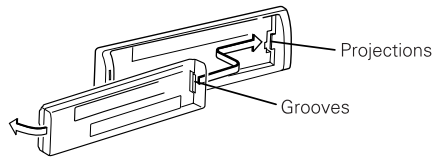

- 2 Push the faceplate in until it clicks.  
The faceplate is locked in place, allowing you to use the unit.

## Tuner features

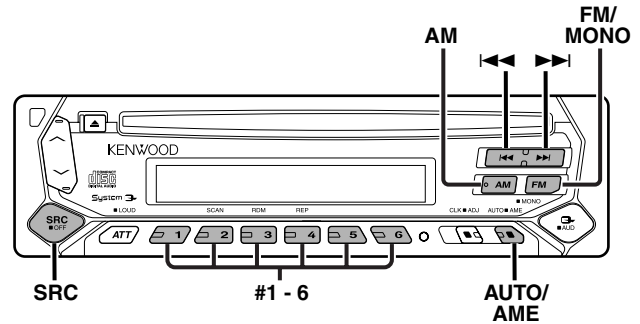

### TEL Mute

The audio system automatically mutes when a call comes in.

#### When a call comes in

"CALL" is displayed.  
The audio system pauses.

#### Listening to the audio during a call

Press the [SRC] button.  
The "CALL" display disappears and the audio system comes back ON.

#### When the call ends

Hang up the phone.  
The "CALL" display disappears and the audio system comes back ON.

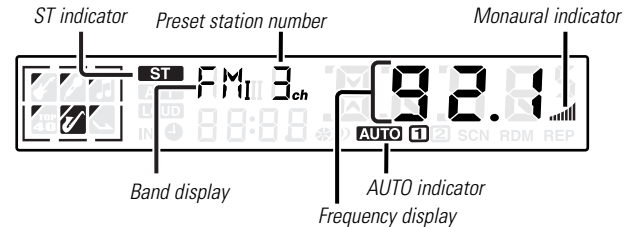

## Tuner features

### Tuning Mode

Choose the tuning mode.

Press the [AUTO] button.

Each time the button is pressed the Tuning mode switches as shown below.

Tuning mode	Display	Operation
Auto seek	"AUTO 1" indicator	Automatic search for a station.
Preset station seek	"AUTO 2" indicator	Search in order of the stations in the Preset memory.
Manual	—	Normal manual tuning control.

### Tuning

Selecting the station.

#### 1 Select tuner source

Press the [SRC] button.  
Select the "TUNE" display.

#### 2 Select the band

Press the [FM] or [AM] button.

Each time the [FM] button is pressed it switches between the FM1, FM2, and FM3 bands.

#### 3 Tune up or down band

Press the [◀◀] or [▶▶] button.



During reception of stereo stations the "ST" indicator is ON.

### Monaural Reception

Press the [MONO] button for at least 1 second.

Each time the button is pressed for at least 1 second the

Monaural Reception turns ON or OFF.

When it's ON, the Monaural indicator is ON.

### Station Preset Memory

Putting the station in the memory.

#### 1 Select the band

Press the [FM] or [AM] button.

#### 2 Select the frequency to put in the memory

Press the [◀◀] or [▶▶] button.

#### 3 Put the frequency in the memory

Press the [#1] — [#6] button for at least 2 seconds.

The preset number display blinks 1 time.

On each band, 1 station can be put in the memory on each [#1]

— [#6] button.

### Auto Memory Entry

Putting stations with good reception in the memory automatically.

#### 1 Select the band for Auto Memory Entry

Press the [FM] or [AM] button.

#### 2 Open Auto Memory Entry

Press the [AME] button for at least 2 seconds.

When 6 stations that can be received are put in the memory Auto Memory Entry closes.

### Preset Tuning

Calling up the stations in the memory.

## CD player features

### 1 Select the band

Press the [FM] or [AM] button.

### 2 Call up the station

Press the [#1] — [#6] button.

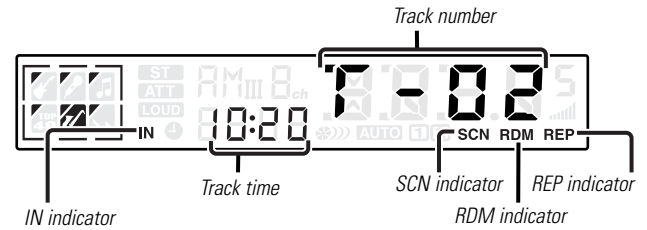
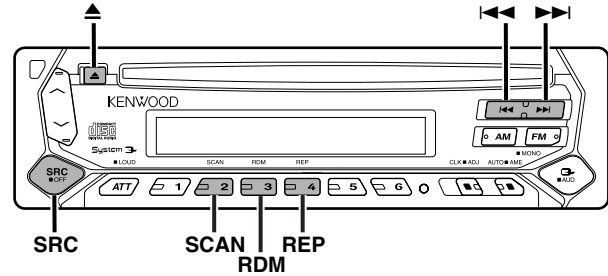

## CD player features

### Playing CD

#### When a CD is inserted

Press the [SRC] button.  
Select the "CD" display.



When a CD is inserted, the "IN" indicator is ON.

#### Eject the CD

Press the [▲] button.



3 in. (8cm) CD cannot be played. Using an adapter and inserting them into this unit can cause damage.

### Fast Forwarding and Reversing

#### Fast Forwarding

Hold down on the [▶▶] button.  
Release your finger to play the disc at that point.

#### Reversing

Hold down on the [◀◀] button.  
Release your finger to play the disc at that point.

### Track Search

Selecting the song you want to hear.

Press the [◀◀] or [▶▶] button.

### Track Repeat

Replaying the song you're listening to.

Press the [REP] button.

Each time the button is pressed the Track Repeat turns ON or OFF.

When it's ON, the "REP" indicator is ON.

### Track Scan

Playing the first part of each song on the disc you are listening to and searching for the song you want to listen to.

#### 1 Start Track Scan

Press the [SCAN] button.  
"SCN" indicator is ON.

#### 2 Release it when the song you want to listen to is played

Press the [SCAN] button.

### Random Play

Playing all the songs on the disc in random order.



Press the [RDM] button.

Each time the button is pressed Random Play turns ON or OFF. When it's ON, the "RDM" indicator is ON and the track number blinks.

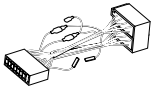
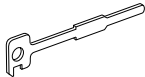

When the [▶▶] button is pressed, the next song select starts.

## Accessories

	External view	Number of items
①		.....1
②		.....2
③		.....1

 The use of any accessories except for those provided might result in damage to the unit. Make sure only to use the accessories shipped with the unit, as shown above.

## Installation Procedure

1. To prevent short circuits, remove the key from the ignition and disconnect the  $\ominus$  terminal of the battery.
2. Make the proper input and output wire connections for each unit.
3. Connect the wire on the wiring harness.
4. Take Connector B on the wiring harness and connect it to the speaker connector in your vehicle.
5. Take Connector A on the wiring harness and connect it to the external power connector on your vehicle.
6. Connect the wiring harness connector to the unit.
7. Install the unit in your car.
8. Reconnect the  $\ominus$  terminal of the battery.
9. Press the reset button.

### CAUTION

- If your car is not prepared for this special connection-system, consult your Kenwood dealer.
- Only use antenna conversion adapters (ISO-JASO) when the antenna cord has an ISO plug.
- Make sure that all wire connections are securely made by inserting jacks until they lock completely.
- If your vehicle's ignition does not have an ACC position, or if the ignition wire is connected to a power source with constant voltage such as a battery wire, the power will not be linked with the ignition (i.e., it will not turn on and off along with the ignition). If you want to link the unit's power with the ignition, connect the ignition wire to a power source that can be turned on and off with the ignition key.
- If the fuse blows, first make sure that the wires have not caused a short circuit, then replace the old fuse with one with the same rating.
- Insulate unconnected wires with vinyl tape or other similar material. To prevent short circuits, also do not remove the caps on the ends of the unconnected wires or the terminals.
- Connect the speaker wires correctly to the terminals to which they correspond. The unit may receive damage or fail to work if you share the  $\ominus$  wires and/or ground them to any metal part in the car.
- After the unit is installed, check whether the brake lamps, indicators, wipers, etc. on the car are working properly.
- If the console has a lid, make sure to install the unit so that the faceplate does not hit the lid when closing and opening.
- Mount the unit so that the mounting angle is 30° or less.

## Connecting Wires to Terminals

Connector Function Guide		
Pin Numbers for ISO Connectors	Wire Color	Functions
<b>External Power Connector</b>		
A-4	Yellow	Battery
A-5	Blue/White	Power Control
A-7	Red	Ignition (ACC)
A-8	Black	Earth (Ground) Connection
<b>Speaker Connector</b>		
B-1	Purple	Rear Right (+)
B-2	Purple/Black	Rear Right (-)
B-3	Gray	Front Right (+)
B-4	Gray/Black	Front Right (-)
B-5	White	Front Left (+)
B-6	White/Black	Front Left (-)
B-7	Green	Rear Left (+)
B-8	Green/Black	Rear Left (-)

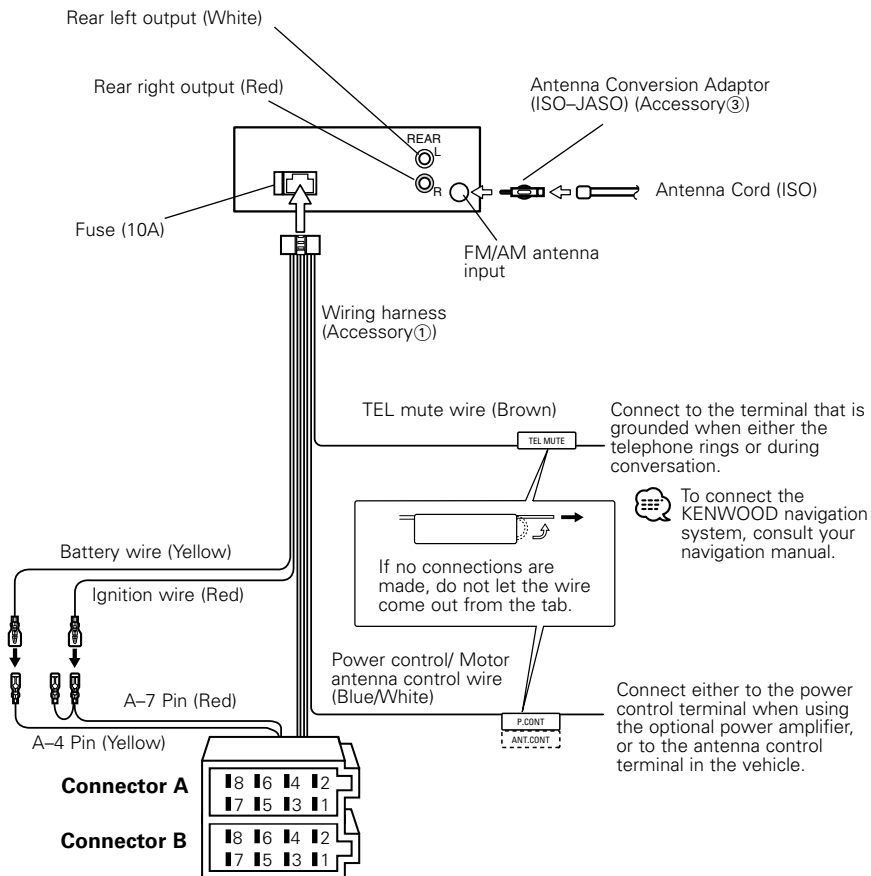

**⚠ WARNING** Connecting the ISO Connector (see p.14)

The pin arrangement for the ISO connectors depends on the type of vehicle you drive. Make sure to make the proper connections to prevent damage to the unit.

The default connection for the wiring harness is described in [1] below. If the ISO connector pins are set as described in [2] or [3], make the connection as illustrated.

- [1] (Default setting) The A-7 pin (red) of the vehicle's ISO connector is linked with the ignition, and the A-4 pin (yellow) is connected to the constant power supply.

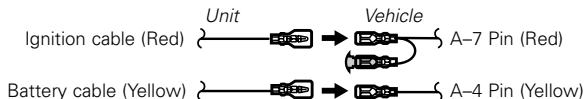

- [2] The A-7 pin (red) of the vehicle's ISO connector is connected to the constant power supply, and the A-4 pin (yellow) is linked to the ignition.

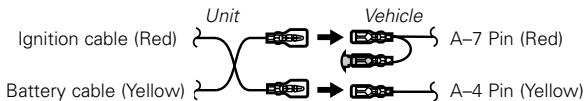

- [3] The A-4 pin (yellow) of the vehicle's ISO connector is not connected to anything, while the A-7 pin (red) is connected to the constant power supply (or both the A-7 (red) and A-4 (yellow) pins are connected to the constant power supply).

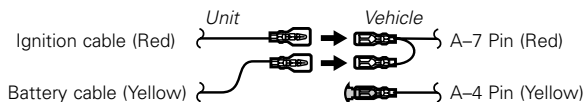

ⓘ When the connection is made as in [3] above, the unit's power will not be linked to the ignition key. For that reason, always make sure to turn off the unit's power when the ignition is turned off.

To link the unit's power to the ignition, connect the ignition cable (ACC...red) to a power source that can be turned on and off with the ignition key.

## Installation

### ■ Installation

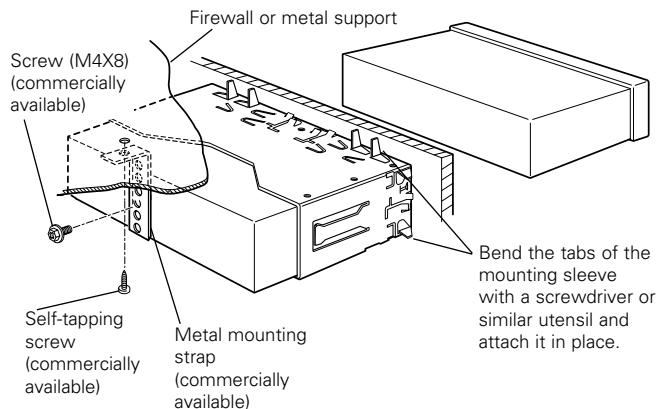

ⓘ Make sure that the unit is installed securely in place. If the unit is unstable, it may malfunction (eg, the sound may skip).

## Installation

### ■ Removing the hard rubber frame

- 1 Engage the catch pins on the removal tool and remove the two locks on the lower level.  
Lower the frame and pull it forward as shown in the figure.

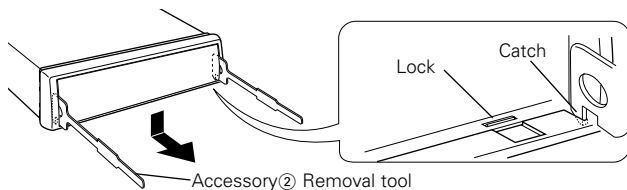

- 2 When the lower level is removed, remove the upper two locations.

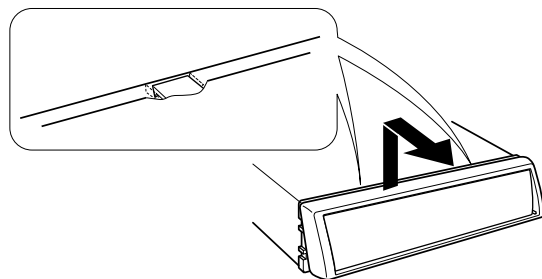

 The frame can be removed from the top side in the same manner.

### ■ Removing the Unit

- 1 Refer to the section "Removing the hard rubber frame" and then remove the hard rubber frame.
- 2 Remove the screw (M4x8) on the back panel.
- 3 Insert the two removal tools deeply into the slots on each side, as shown.

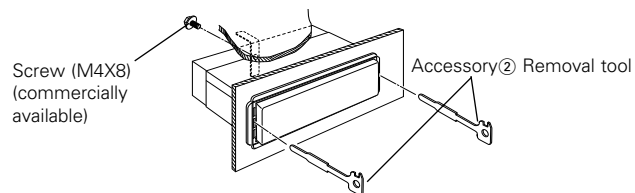

- 4 Lower the removal tool toward the bottom, and pull out the unit halfway while pressing towards the inside.

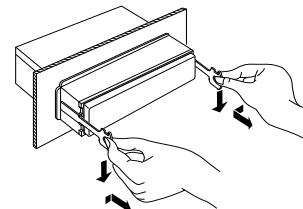

 Be careful to avoid injury from the catch pins on the removal tool.

- 5 Pull the unit all the way out with your hands, being careful not to drop it.

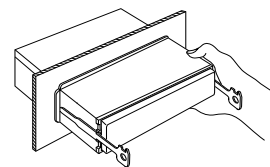



## Troubleshooting Guide

---

**What might seem to be a malfunction in your unit may just be the result of slight misoperation or miswiring. Before calling service, first check the following table for possible problems.**

### General

#### ? The power does not turn ON.

- ✓ The fuse has blown.
    - ☞ After checking for short circuits in the wires, replace the fuse with one with the same rating.
  - ✓ No ACC position on vehicle ignition.
    - ☞ Connect the same wire to the ignition as the battery wire.
- 

#### ? Nothing happens when the buttons are pressed.

- ✓ The computer chip in the unit is not functioning normally.
    - ☞ Press the reset button on the unit (page 4).
- 

#### ? There's a source you can't switch.

- ✓ There's no CD inserted.
    - ☞ Set the media you want to listen to. If there's no media in this unit, you can't switch to each source.
- 

#### ? The memory is erased when the ignition is turned OFF.

- ✓ The battery wire has not been connected to the proper terminal.
    - ☞ Connect the wire correctly, referring to the section on <Connecting Wires to Terminals>.
  - ✓ The ignition and battery wire are incorrectly connected.
    - ☞ Connect the wire correctly, referring to the section on <Connecting Wires to Terminals>.
- 

#### ? The TEL mute function does not work.

- ✓ The TEL mute wire is not connected properly.
    - ☞ Connect the wire correctly, referring to the section on <Connecting Wires to Terminals>.
- 

#### ? The TEL mute function turns ON even though the TEL mute wire is not connected.

- ✓ The TEL mute wire is touching a metal part of the car.
    - ☞ Pull the TEL mute wire away from the metal part of the car.
- 

#### ? Even if Loudness is turned ON, high-pitched tone isn't compensated for.

- ✓ Tuner source is selected.
    - ☞ High-pitched tone isn't compensated for when in Tuner source.
- 

#### ? No sound can be heard, or the volume is low.

- ✓ The fader or balance settings are set all the way to one side.
    - ☞ Center the fader and balance settings.
  - ✓ The input/output wires or wiring harness are connected incorrectly.
    - ☞ Reconnect the input/output wires or the wiring harness correctly. See the section on "Connecting Wires to Terminals".
- 

#### ? The sound quality is poor or distorted.

- ✓ One of the speaker wires is being pinched by a screw in the car.
    - ☞ Check the speaker wiring.
  - ✓ The speakers are not wired correctly.
    - ☞ Reconnect the speaker wires so that each output terminal is connected to a different speaker.
- 

#### ? The Touch Sensor Tone doesn't sound.

- ✓ The preout jack is being used.
    - ☞ The Touch Sensor Tone can't be output from the preout jack.
- 

### Tuner source

#### ? Radio reception is poor.

- ✓ The car antenna is not extended.
    - ☞ Pull the antenna out all the way.
  - ✓ The antenna control wire is not connected.
    - ☞ Connect the wire correctly, referring to the section on <Connecting Wires to Terminals>.
-

## Troubleshooting Guide

### Disc source

#### ? The specified disc does not play, but another one plays instead.

- ✓ The specified CD is quite dirty.
  - ☞ Clean the CD.
- ✓ The CD is upside-down.
  - ☞ Load the CD with the labeled side up.
- ✓ The disc is severely scratched.
  - ☞ Try another disc instead.

#### ? The specified track will not play.

- ✓ Random play has been selected.
  - ☞ Turn off random play.

#### ? Track repeat, disc repeat, track scan, and random play, start by themselves.

- ✓ The setting is not canceled.
  - ☞ The settings for these functions remain on until the setting to off or the disc ejected, even if the power is turned off or the source changed.

#### ? Cannot play CD-R or CD-RW.

- ✓ Finalization processing is not being conducted for CD-R/CD-RW.
  - ☞ Conduct finalization processing with CD recorder.

#### ? A CD ejects as soon as it is loaded.

- ✓ The CD is upside-down.
  - ☞ Load the CD with the labeled side up.
- ✓ The CD is quite dirty.
  - ☞ Clean the CD, referring to the section on <CD cleaning> (page 5).

#### ? Can't remove disc.

- ✓ The cause is that more than 10 minutes has elapsed since the vehicle ACC switch was turned OFF.
  - ☞ The disc can only be removed within 10 minutes of the ACC switch being turned OFF. If more than 10 minutes has elapsed, turn the ACC switch ON again and press the Eject button.

#### ?The disc won't insert.

- ✓ There's already another disc inserted.
  - ☞ Press the [▲] button and remove the disc.

#### ?Track Search can't be done.

- ✓ For the albums first or last song.
  - ☞ For each album, Track Search can't be done in the backward direction for the first song or in the forward direction for the last song.

### The messages shown below display your systems condition.

- E-04: The CD is quite dirty. The CD is upside-down. The CD is scratched a lot.  
 ⇨ Clean the CD and load it correctly.
- IN (Blink): The CD player section is not operating properly.  
 ⇨ Reinsert the CD. If the CD cannot be ejected or the display continues to flash even when the CD has been properly reinserted, please switch off the power and consult your nearest service center.

## Specifications

---

### Specifications subject to change without notice.

#### **FM tuner section**

Frequency range (50 kHz space) .....	87.5 MHz – 108.0 MHz
Usable sensitivity (S/N = 26dB) .....	0.7 $\mu$ V/75 $\Omega$
Quieting Sensitivity (S/N = 46dB) .....	1.6 $\mu$ V/75 $\Omega$
Frequency response ( $\pm$ 3 dB) .....	30 Hz – 15 kHz
Signal to Noise ratio (MONO) .....	65 dB
Selectivity (DIN) ( $\pm$ 400 kHz) .....	$\geq$ 80 dB
Stereo separation (1 kHz) .....	35 dB

#### **MW tuner section**

Frequency range (9 kHz space) .....	531 kHz – 1611 kHz
Usable sensitivity (S/N = 20dB) .....	25 $\mu$ V

#### **LW tuner section**

Frequency range .....	153 kHz – 281 kHz
Usable sensitivity (S/N = 20dB) .....	45 $\mu$ V

#### **CD player section**

Laser diode .....	GaAlAs ( $\lambda$ =780 nm)
Digital filter (D/A) .....	8 Times Over Sampling
D/A Converter .....	1 Bit
Spindle speed .....	500 – 200 rpm (CLV)
Wow & Flutter .....	Below Measurable Limit
Frequency response ( $\pm$ 1 dB) .....	10 Hz – 20 kHz
Total harmonic distortion (1 kHz) .....	0.01 %
Signal to Noise ratio (1 kHz) .....	96 dB
Dynamic range .....	93 dB
Channel separation .....	85 dB

#### **Audio section**

Maximum output power .....	45 W x 4
Output power (DIN 45324, +B=14.4V) .....	28 W x 4
Tone action	
Bass : .....	100 Hz $\pm$ 10 dB
Middle : .....	1 kHz $\pm$ 10 dB
Treble : .....	10 kHz $\pm$ 10 dB
Preout level / Load (during disc play) .....	1800 mV/10 k $\Omega$
Preout impedance (during disc play) .....	$\leq$ 600 $\Omega$

#### **General**

Operating voltage (11 – 16V allowable) .....	14.4 V
Current consumption .....	10 A
Installation Size (W x H x D) .....	182 x 53 x 157 mm
	7-3/16 x 2-1/16 x 6-3/16 inch
Weight .....	3.1 lbs (1.4 kg)

## Free Manuals Download Website

<http://myh66.com>

<http://usermanuals.us>

<http://www.somanuals.com>

<http://www.4manuals.cc>

<http://www.manual-lib.com>

<http://www.404manual.com>

<http://www.luxmanual.com>

<http://aubethermostatmanual.com>

Golf course search by state

<http://golfingnear.com>

Email search by domain

<http://emailbydomain.com>

Auto manuals search

<http://auto.somanuals.com>

TV manuals search

<http://tv.somanuals.com>