

KENWOOD

CD-RECEIVER

KDC-X7533U
KDC-MP5033U

INSTRUCTION MANUAL

Kenwood Corporation



PHATNOISE

© B64-3344-00/00 (MW)

Contents

Safety precautions **3**

Notes **4**

About CDs **6**

About USB device **7**

About AAC, MP3 and WMA **8**

General features **10**

Power
Selecting the Source
Volume
Attenuator
System Q
Audio Control
Adjusting the detail of Audio Control
Audio Setup
Speaker Setting
Subwoofer Output
Switching Display
Theft Deterrent Faceplate
TEL Mute

Tuner/TV control features **16**

Tuning
Tuning Mode
Direct Access Tuning
Station Preset Memory
Auto Memory Entry
Preset Tuning
Frequency Step Setting
TV Tuning
TV channel Preset Memory
Preset TV Tuning
Direct TV Tuning

CD/USB device/Audio file/External disc control features **19**

Playing CD & Audio file
Playing USB device
Playing External Disc
Fast Forwarding and Reversing
Track/File Search
Disc Search/Folder Search
Direct Track/File Search
Direct Disc Search
Track/File/Disc/Folder Repeat
Scan Play
Random Play
Magazine Random Play

All Random Play
Select mode
File Select mode
Folder Select 1 mode
Folder Select 2 mode
Switching the Play mode
Letter Seek
Text/Title Scroll

Menu system **26**

Menu System
Security Code
Touch Sensor Tone
Manual Clock Adjustment
DSI (Disabled System Indicator)
Selectable Illumination
Display Illumination Control
Dimmer
Built-in Amp Setting
Dual Zone System Setting
B.M.S. (Bass Management System)
B.M.S. Frequency Offset
AMP Control
CRSC (Clean Reception System Circuit)
Auxiliary Input Display Setting
Text Scroll
CD Read Setting
Voice Index
Firmware version display
Unique ID display
Audio Preset Memory
Audio Preset Recall

Basic Operations of remote control **33**

Accessories/ Installation Procedure **35**

Connecting Wires to Terminals **36**

Installation **38**

Removing the Unit **40**

Troubleshooting Guide **41**

Specifications **44**

Safety precautions

⚠ WARNING

To prevent injury or fire, take the following precautions:

- To prevent a short circuit, never put or leave any metallic objects (such as coins or metal tools) inside the unit.
- Mounting and wiring this product requires skills and experience. For safety's sake, leave the mounting and wiring work to professionals.

Attach the panel while you are on the vehicle

The panel lock arm appears when the panel is removed. Therefore, the panel must be attached while the electrical system of the car is operating.

⚠ CAUTION

To prevent damage to the machine, take the following precautions:

- Make sure to ground the unit to a negative 12V DC power supply.
- Do not install the unit in a spot exposed to direct sunlight or excessive heat or humidity. Also avoid places with too much dust or the possibility of water splashing.
- Do not place the faceplate (and the faceplate case) in areas exposed to direct sunlight, excessive heat or humidity. Also avoid places with too much dust or the possibility of water splashing.
- To prevent deterioration, do not touch the terminals of the unit or faceplate with your fingers.
- Do not subject the faceplate to excessive shock, as it is a piece of precision equipment.
- When replacing a fuse, only use a new fuse with the prescribed rating. Using a fuse with the wrong rating may cause your unit to malfunction.
- Do not apply excessive force to the open faceplate or place objects on it. Doing so will cause damage or breakdown.
- Do not use your own screws. Use only the screws provided. If you use the wrong screws, you could damage the unit.

Do Not Load 8 cm (3 in.) CDs in the CD slot

If you try to load a 8 cm (3 in.) CD with its adapter into the unit, the adapter might separate from the CD and damage the unit.

About CD players/disc changers connected to this unit

Kenwood disc changers/ CD players released in 1998 or later can be connected to this unit.

Refer to the catalog or consult your Kenwood dealer for connectable models of disc changers/ CD players.

Note that any Kenwood disc changers/ CD players released in 1997 or earlier and disc changers made by other makers cannot be connected to this unit. Connecting unsupported disc changers/CD players to this unit may result in damage.

Set the "O-N" Switch to the "N" position for the applicable Kenwood disc changers/ CD players.

The functions you can use and the information that can be displayed may differ depending on the models being connected.



- You can damage both your unit and the CD changer if you connect them incorrectly.

Lens Fogging

When you turn on the car heater in cold weather, dew or condensation may form on the lens in the CD player of the unit. Called lens fogging, this condensation on the lens may not allow CDs to play. In such a situation, remove the disc and wait for the condensation to evaporate. If the unit still does not operate normally after a while, consult your Kenwood dealer.

The "AAC" logo is trademark of Dolby Laboratories.

Notes

- No USB device comes with this unit. You need to purchase a commercially available USB device. For the types of available USB devices, refer to <About USB device> (page 7).
- If you experience problems during installation, consult your Kenwood dealer.
- When you purchase optional accessories, check with your Kenwood dealer to make sure that they work with your model and in your area.
- The characters which can be displayed by this unit are A-Z 0-9 @ " ' ` % & * + - = , . / \ < > [] () ; : ^ - { } | ~ .
- The illustrations of the display and the panel appearing in this manual are examples used to explain more clearly how the controls are used. Therefore, what appears on the display in the illustrations may differ from what appears on the display on the actual equipment, and some of the illustrations on the display may be inapplicable.

How to reset your unit

- If the unit fails to operate properly, press the Reset button. The unit returns to factory settings when the Reset button is pressed.
- Remove the USB device before pressing the Reset button. Pressing the Reset button with the USB device installed can damage the data contained in the USB device. For how to remove the USB device, refer to <Playing USB device> (page 20).
- Press the Reset button if the disc auto changer fails to operate correctly. Normal operation should be restored.

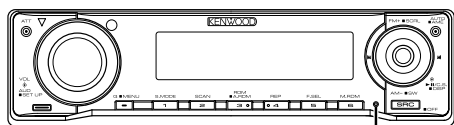

Reset button

Cleaning the Unit

If the faceplate of this unit is stained, wipe it with a dry soft cloth such as a silicon cloth.

If the faceplate is stained badly, wipe the stain off with a cloth moistened with neutral cleaner, then wipe it again with a clean soft dry cloth.



- Applying spray cleaner directly to the unit may affect its mechanical parts. Wiping the faceplate with a hard cloth or using a volatile liquid such as thinner or alcohol may scratch the surface or erase characters.

Cleaning the Faceplate Terminals

If the terminals on the unit or faceplate get dirty, wipe them with a dry, soft cloth.

About "Media Manager" of PC application attached to KDC- KDC-X7533U

- "Media Manager" is recorded in the CD-ROM attached to this unit.
- Refer to the attached installation manual for the installation method of "Media Manager".
- Refer to the user's manual recorded in the installation CD-ROM and Help of "Media Manager" for the operation method of "Media Manager".
- The unit can play CD/ USB device (hereafter called "ACDrive media") created by "Media Manager".
- Refer to the following site for the updated information of "Media Manager".
<http://www.kenwood.mediamanager.jp>
- Contact Kenwood for the function and operation of the "Media Manager".
- "Media Manager" is a product of PhatNoise.

About DAB Tuner control

Refer to [A] group on the Instruction manual of DAB Tuner KTC-9090DAB (optional accessory) for the control method of DAB Tuner function.

However, the following control methods of the function for this unit may be differed from the Instruction manual; therefore, refer to the following supplemental instruction.

<Auto Ensemble Memory Entry>

1. Select the preset band for Auto Ensemble Memory Entry.
2. Press the [AME] button for at least 2 seconds. Open Auto Ensemble Memory Entry. After memory storage is finished, the number of the pre-set buttons and the ensemble label are displayed.

<Searching by programme type and language>

and <Languages to be displayed> in

<Programme Type (PTY) Function>

At the operation to press [DISP] button, use [AUTO] button instead.

<Automatic Switching DAB priority>

This function cannot be used.

The marking of products using lasers (Except for some areas)



**CLASS 1
LASER PRODUCT**

The label is attached to the chassis/case and says that the component uses laser beams that have been classified as Class 1. This means that the unit is utilizing laser beams that are of a weaker class. There is no danger of hazardous radiation outside the unit

About CDs

Handling CDs

- Do not touch the recording surface of the CD.



- CD-R and CD-RW are easier to damage than a normal music CD. Use a CD-R or a CD-RW after reading the caution items on the package etc.
- Do not stick tape etc. on the CD, or use a CD with tape stuck on it.

When using a new CD

If the CD center hole or outside rim has burrs, use the CD only after removing the burrs with a ballpoint pen, etc.

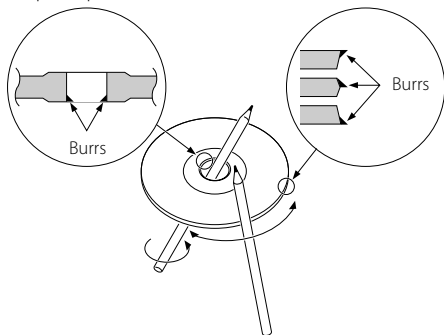

CD accessories

Do not use disc type accessories.

CD cleaning

Clean from the center of the disc and move outward.

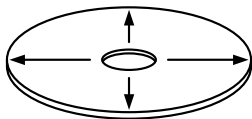



Removing CDs

When removing CDs from this unit, pull them out horizontally.

CDs that cannot be used

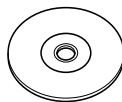
- CDs that are not round cannot be used.



- CDs with coloring on the recording surface or CDs that are dirty cannot be used.
- This unit can only play the CDs with . This unit may not correctly play discs which do not have the mark.
- You cannot play a CD-R or CD-RW that has not been finalized. (For the finalization process refer to your CD-R/CD-RW writing software, and your CD-R/CD-RW recorder instruction manual.)

CD storage

- Do not place CDs in direct sunlight (On the seat or dashboard etc.) or where the temperature is high.
- Store CDs in their cases.

About USB device

Notes on Use of the USB device

This unit can play audio files stored in the flash memory and digital audio player that have a USB port (these devices are referred to as USB devices in this document).

The following restrictions are placed on the types and usage of available USB devices:

Available USB devices

- USB devices belonging to the USB mass storage class.
- USB devices whose maximum current consumption is 500 mA or less.
For the supported formats and USB device types, refer to <http://www.kenwood.mediamanager.jp/>.



• USB Mass Storage Class:

- USB devices that the PC can recognize as an external storage without using any special driver or application software.
- Contact the sales agent as to whether your USB device conforms to the USB mass storage class specs.
- Using an unsupported USB device can result in abnormal playback or display of the audio file. Even if you use the USB device conforming to the above specs, audio files cannot be played normally depending on the type or condition of the USB device.

About the Connection of the USB device

- When connecting the USB device, usage of the CA-U1EX (option) is recommended. Normal playback is not guaranteed when a cable other than the USB compatible cable is used. Connecting a cable whose total length is longer than 5 m can result in abnormal playback.



- You cannot connect a USB device via a USB hub.



- Install the USB device in the place where it will not prevent you from driving your vehicle properly.
- Do not leave the USB device in the vehicle for a long time. It can deform or damage due to direct sunlight, high temperature, etc.
- Take backups of the audio files used with this unit. The files can be erased depending on the operating conditions of the USB device. We shall have no compensation for any damage arising out of erasure of the stored data.

About USB device Operation

- USB device operation is the same as audio file operation unless otherwise some notice is indicated.
- USB source is recognized as CD source on the connected unit.

About AAC, MP3 and WMA

The playable AAC/MP3/WMA file (hereafter called Audio file) and the media format has the following limitation. The Audio file, which is not conforming to the specification, may not play normally, or the file and folder names may not display correctly.

Playable Audio file

- AAC, MP3, WMA



- Attach the correct extension for the Audio file. (AAC: ".M4A", MP3: ".MP3", WMA: ".WMA")
- Do not attach the extensions to files other than the Audio file. If the extension is attached, the file, which is not the Audio file, will play and outputs a loud noise, causing damage to the speaker.
- The files with copy protection cannot be played.
- Audio files cannot be played depending on the encoding software setting, USB device type, and/or recording conditions.
- The unit may not be compatible with upgrade of compression format standard and additional specifications.
- For details on the formats used for USB devices and restrictions, refer to <http://www.kenwood.mediamanager.jp/>.

Playable AAC file

- ".m4a" file encoded by AAC-LC format. Refer to <http://www.kenwood.mediamanager.jp> for the details.

Playable MP3 file

- MPEG 1/2 Audio Layer 3 file
- Transfer bit rate: 8-320 kbps
- Sampling frequency: 16, 22.05, 24, 32, 44.1, 48 kHz

Playable WMA file

- The file in accordance with Windows Media Audio (Except for the file for Windows Media Player 9 or after which applies the new functions)
- Transfer bit rate: 48-192 kbps
- Sampling frequency: 32, 44.1, 48 kHz

Playable Storage media

- CD-ROM, CD-R, CD-RW
- USB device



- CD-RW discs which are quick formatted by the writing software cannot be used.
- When recording to the maximum CD-R/RW media capacity at once, the writing software is set to "Disc at once".
- For details on the available USB devices, refer to <About USB device> (page 7).

Playable CD-R/RW format

- ISO 9660 Level 1/2
- Joliet
- Romeo
- Long file name.

Playable file format of USB device

- For the formats supported by USB devices, refer to <http://www.kenwood.mediamanager.jp/>.

The maximum number of characters for display (CD-R/RW)

File/Folder name: 128 characters

MP3 ID3 Tag/ WMA Contents property:
30 characters

AAC song information: 60 characters



- File/Folder name is the number of the characters including the extensions.
- This unit can display the following versions of MP3 ID3 tag: version 1.0/ 1.1/ 2.2/ 2.3
- AAC ID3 Tag cannot be displayed.

Limitation of structure for the file and the folder (CD-R/RW)

- Maximum number of directory levels: 8
- Maximum number of folders: 100
- Maximum number of files per folder: 4096

About partition of the USB device

- While using the USB device, virtual folders are created to control the partition in the USB device. These folders appear in the first level (root) directory as "#:". "#" is an alphabet to identify each partition.
- Even when the USB device does not have partition, "A:" folder is created, and audio files are controlled inside this folder.

Playing order of the Audio file

- The Audio file plays in the order which is written by CD writing software. You may be able to set the playing order by writing the play sequence numbers such as "01" to "99" at the beginning of the file name.
- Audio files are played in the order the files are written. You can specify the order of playback by numbering files in a folder and writing them by folder. (USB device)

Example

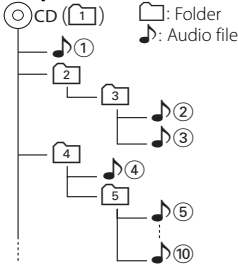

• Playing order

Playing order after 1 play.

➔ 2, 3, 4, 5...

• File search

Forward file search during 2 play.

Push the Control knob towards ➔ 3

• Folder search

Forward folder search during 2 play.

Push the Control knob towards [FM] ➔ 4, 5...

• File select

When the selection is set to file 5.

Push the Control knob towards

➔ 5...10, 5...

• Folder select 1

When the selection is set to directory 4, and you want to skip to the folder 2 at the same level.

Push the Control knob towards ➔ 2

When the selection is set to directory 3, moves the level up by folder select.

Push the Control knob towards [AM] ➔ 2

• Folder select 2

When the selection is set to directory 1, and you want to skip to the folder 4.

Push the Control knob towards ➔ 3, 4...

General features

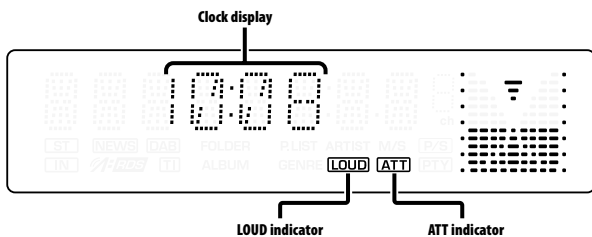
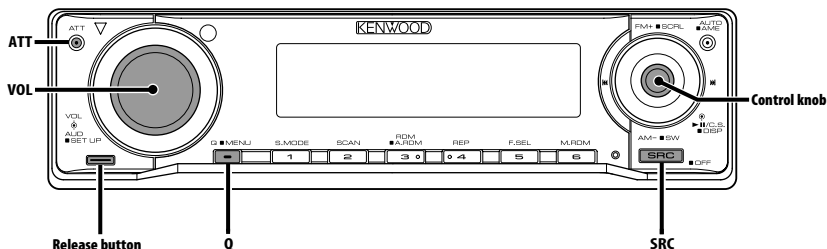

Power

Turning ON the Power

Press the [SRC] button.



- When the power is ON, the <Security Code> (page 27) is displayed as "CODE ON" or "CODE OFF".

Turning OFF the Power

Press the [SRC] button for at least 1 second.

Selecting the Source

Press the [SRC] button.

Source required	Display
Tuner	"TUNER"
USB device	"USB"
CD	"CD"
TV* (Optional accessory)	"TV"
External disc (Optional accessory)	"CD CH"
Auxiliary input (Optional accessory)	"AUX EXT"
Standby (Illumination only mode)	"STANDBY"



- * Function of the KDC-X7533U.

Volume

Increasing Volume

Turn the [VOL] knob clockwise.

Decreasing Volume

Turn the [VOL] knob counterclockwise.

Attenuator

Turning the volume down quickly.

Press the [ATT] button.

Each time you press the button, the Attenuator turns ON and OFF.

When the Attenuator is ON, the "ATT" indicator blinks.

System Q

Selecting the best sound setting preset for different types of music.

1 Select the source to set

Press the [SRC] button.

2 Select the Sound type

Press the [Q] button.

When you press the button once, the current sound setting is displayed.

Each time you press the button, the sound setting alternates.

Sound setting	Display
User memory*	"USER"
Rock	"ROCK"
Pops	"POPS"
Easy	"EASY"
Top 40	"TOP 40"
Jazz	"JAZZ"
Natural	"NATURAL"



- * User memory: The values set on the <Audio Control> (page 11). KDC-MP5033U does not have the User memory function so the values of Bass, Middle, and Treble set in audio control are replaced to the System Q values and "USER" is not displayed when the System Q setting is changed.
- Change each setting value with the <Speaker Setting> (page 13). First, select the speaker type with the Speaker setting.

Audio Control

1 Select the source to adjust

Press the [SRC] button.

2 Enter Audio Control mode

Press the [VOL] knob.

3 Select the Basic Audio item to adjust

Press the [VOL] knob.

Each time you press the knob, the item to be adjusted alternates between the items shown in the table below.

4 Adjust the Basic Audio item

Turn the [VOL] knob.

Adjustment Item	Display	Range
Rear Volume *1,2	"R-VOL"	0 — 35
Subwoofer level*1,3,4	"SW L"	-15 — +15
Bass level*5	"BAS L"	-8 — +8
Middle level*5	"MID L"	-8 — +8
Treble level*5	"TRE L"	-8 — +8
Balance	"BAL"	Left 15 — Right 15
Fader*4	"FAD"	Rear 15 — Front 15

Exit Audio Control mode (Volume control mode)



- *1 Function of the KDC-X7533U.
- *2 You can control this item when "2ZON" of <Audio Setup> (page 12) is set to "ON".
- *3 You can control this item when <Subwoofer Output> (page 13) is set to "SW ON".
- *4 You can control this item when "2ZON" of <Audio Setup> (page 12) is set to "OFF".
- *5 You can adjust these items in detail. Refer to <Adjusting the detail of Audio Control>(Page12). (Function of the KDC-X7533U)
- *5 Source tone memory: Puts the set up value in the memory per source. (Detail Audio item is included : KDC-X7533U only)

5 Exit Audio Control mode

Press any button.

Press a button other than the [VOL] knob and [ATT] button.

General features

Function of the KDC-X7533U

Adjusting the detail of Audio Control

Among the Basic Audio items, you can adjust the Bass level, Middle level, and Treble level in detail.

1 Select the Basic Audio item

Select the desired item to be set in detail from followings;

- Bass level
- Middle level
- Treble level

For how to select Basic Audio items, see <Audio Control> (page 11).

2 Enter Detail adjustment mode of Audio Control

Press the [VOL] knob for at least 1 second.

3 Select the Detail Audio item to adjust

Press the [VOL] knob.

Each time you press the knob, the item to be adjusted alternates between the items shown in the table below.

4 Adjust the Detail Audio item

Turn the [VOL] knob.

Bass level

Adjustment Item	Display	Range
Bass Center Frequency	"BAS F"	40/50/60/70/80/100/120/150 Hz
Bass Q Factor	"BAS Q"	1.00/1.25/1.50/2.00
Bass Extend	"B EX"	OFF/ON

Middle level

Adjustment Item	Display	Range
Middle Center Frequency	"MID F"	0.5/1.0/1.5/2.0 kHz
Middle Q Factor	"MID Q"	1.0/2.0

Treble level

Adjustment Item	Display	Range
Treble Center Frequency	"TRE"	10.0/12.5/15.0/17.5 kHz

5 Exit the Detail Audio Control mode

Press the [VOL] knob for at least 1 second.



- When you set the Bass Extend to ON, low frequency response is extended by 20%.
- You can exit the Audio Control mode at anytime by pressing any button except for [VOL] and [ATT] buttons.

Audio Setup

Setting the Sound system, such as Cross over Network.

1 Select the source to adjust

Press the [SRC] button.

2 Enter Audio Setup mode

Press the [VOL] knob for at least 1 second.

3 Select the Audio Setup item to adjust

Press the [VOL] knob.

Each time you press the knob, the item to be adjusted alternates between the items shown in the table below.

4 Setup the Audio item

Turn the [VOL] knob.

Adjustment Item	Display	Range
Front High Pass Filter*1,3	"HPF"	Through/40/60/80/100/120/150/180/220 Hz
Rear High Pass Filter*1,3 "HPR"	"HPR"	Through/40/60/80/100/120/150/180/220 Hz
Low Pass Filter*1,2,3	"LPF"	50/60/80/100/120/Through Hz
Subwoofer Phase*1,2,3,4	"PHAS"	Reverse (180°)/ Normal (0°)
Volume offset	"V-OFF"	-8 — ±0
Loudness	"LOUD"	OFF/ON
Dual Zone System*1	"2ZON"	OFF/ON



- Volume offset: Sets each source's volume as a difference from the basic volume.
- Loudness: Compensates for low and high tones during low volume.
- *1 Function of the KDC-X7533U.
- *2 You can control this item when <Subwoofer Output> (page 13) is set to "SW ON".
- *3 You can control this item when "2ZON" of <Audio Setup> (page 12) is set to "OFF".
- *4 You can control this item when Low Pass Filter is not set to Through.
- Dual Zone System
Main source and sub source (Auxiliary input) output Front channel and Rear channel separately.
 - Set up the channel of sub source by <Dual Zone System Setting> (page 29).
 - Select Main source by [SRC] button.
 - Adjust the volume of Front channel by [VOL] knob.
 - Adjust the volume of Rear channel by <Audio Control> (page 11).
 - The Audio Control has no effect on sub source.

- You can use the Dual Zone System with the Auxiliary input sources listed below.
 - Option CA-C1AX/ CA-C2AX

5 Exit Audio Setup mode

Press the [VOL] knob for at least 1 second.

Speaker Setting

Fine-tuning so that the System Q value is optimal when setting the speaker type.

1 Enter Standby

Press the [SRC] button.

Select the "STANDBY" display.

2 Enter Speaker Setting mode

Press the [VOL] knob.

3 Select the Speaker type

Turn the [VOL] knob.

Each time you turn the knob, the setting alternates between the settings shown in the table below.

Speaker type	Display
OFF	"SP OFF"
For 5 & 4 in. speaker	"SP 5/4"
For 6 & 6x9 in. speaker	"SP 6*9/6"
For the OEM speaker	"SP OEM"

4 Exit Speaker Setting mode

Press the [VOL] knob.

Function of the KDC-X7533U

Subwoofer Output

Turning the Subwoofer output ON or OFF.

Push the Control knob toward [AM] for at least 2 seconds.

Each time you push the knob, Subwoofer output switches ON and OFF.

When it is ON, "SW ON" is displayed.



- You can control this function when "2 ZONE" of <Audio Setup> (page 12) is set to "OFF".

General features

Switching Display

Changing the information displayed.

1 Enter Switching Display mode

Press the Control knob for at least 1 second.

"DISP SEL" is displayed.

2 Select the Display item

Push the Control knob towards [◀◀] or [▶▶].

In Tuner source

Information	Display
Frequency	"FREQ"
Clock	"CLOCK"

In CD & External disc source

Information	Display
Disc title	"D-TITLE"*
Track title	"T-TITLE"*
Track number & Play time	"P-TIME"
Clock	"CLOCK"

In Audio file source

Information	Display
Song title & Artist name	"TITLE"*
Album name & Artist name	"ALBUM"*
Folder name	"FOLDER"
File name	"FILE"
Track number & Play time	"P-TIME"
Clock	"CLOCK"

In Standby/ Auxiliary input source

Information	Display
Source name	"SRC NAME"
Clock	"CLOCK"

3 Exit Switching Display mode

Press the Control knob.



- When LX-AMP is connected, the item setup by the Display mode of LX-AMP is displayed. (KDC-X7533U only)
- * If the contents of the information cannot be displayed, Play time is displayed.
- Track number at Audio file displays the last 3 digits when it exceeds 1000 songs.
- When you select the clock display, the display setting of each source will be changed to the clock display.

Theft Deterrent Faceplate

The faceplate of the unit can be detached and taken with you, helping to deter theft.

Removing the Faceplate

1 Press the Release button.

Drop open the faceplate.

2 Drawing the faceplate to left side pull it to forward and remove it.

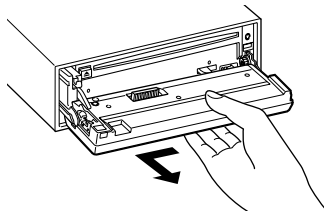

- The faceplate is a precision piece of equipment and can be damaged by shocks or jolts.
- Keep the faceplate in its faceplate case while detached.
- Do not expose the faceplate (and the faceplate case) to direct sunlight or excessive heat or humidity. Also avoid places with too much dust or the possibility of water splashing.

Reattaching the Faceplate

1 Align the shaft on the unit with the depression on the faceplate.

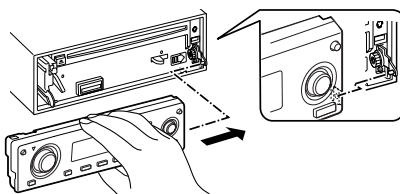

2 Push the faceplate in until it clicks.

The faceplate is locked in place, allowing you to use the unit.

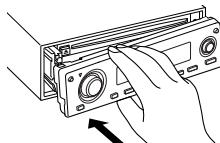

TEL Mute

The audio system automatically mutes when a call comes in.

When a call comes in

"CALL" is displayed.

The audio system pauses.

Listening to the audio during a call

Press the [SRC] button.

The "CALL" display disappears and the audio system comes back ON.

When the call ends

Hang up the phone.

The "CALL" display disappears and the audio system comes back ON.



- To use the TEL Mute feature, you need to hook up the MUTE wire to your telephone using a commercial telephone accessory. Refer to <Connecting Wires to Terminals> (page 36, 37).

Tuner/TV control features

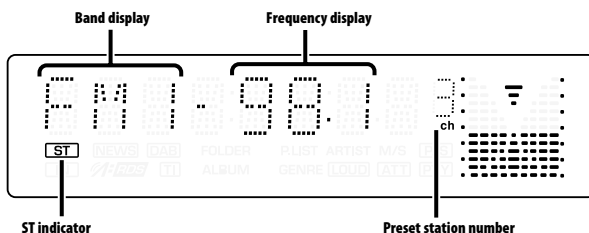
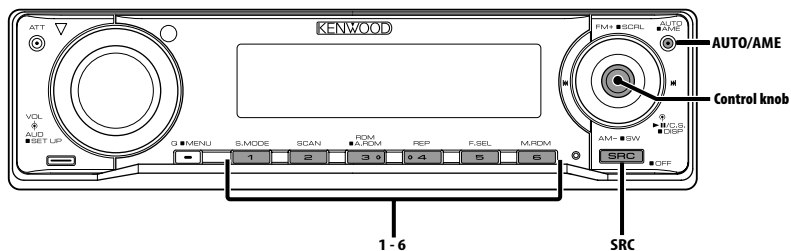

Tuning

Selecting the station.

1 Select tuner source

Press the [SRC] button.

Select the "TUNER" display.

2 Select the band

Push the Control knob towards [FM] or [AM].

Each time you push the knob toward [FM], it switches between the FM1, FM2, and FM3 bands.

3 Tune up or down band

Push the Control knob towards [◀◀] or [▶▶].



- During reception of stereo stations the "ST" indicator is ON.

Tuning Mode

Choose the tuning mode.

Press the [AUTO] button.

Each time you press the button, the Tuning mode alternates between the modes shown in the table below.

Tuning mode	Display	Operation
Auto seek	"AUTO 1"	Automatic search for a station.
Preset station seek	"AUTO 2"	Search in order of the stations in the Preset memory.
Manual	"MANUAL"	Normal manual tuning control.

Function of the KDC-X7533U

Function of remote control

Direct Access Tuning

Entering the frequency and tuning.

1 Select the band

Press the [FM] or [AM] button.

2 Enter Direct Access Tuning mode

Press the [DIRECT] button on the remote control.

"- - - -" is displayed.

3 Enter the frequency

Press the number buttons on the remote control.

Example:

Desired frequency	Press button
92.1 MHz (FM)	[0], [9], [2], [1]
810 kHz (AM)	[0], [8], [1], [0]

Canceling Direct Access Tuning

Press the [DIRECT] button on the remote control.

Station Preset Memory

Putting a station in the memory.

1 Select the band

Push the Control knob towards [FM] or [AM].

2 Select the frequency to put in the memory

Push the Control knob towards [◀◀] or [▶▶].

3 Put the frequency in the memory

Press the desired [1] — [6] button for at least 2 seconds.

The preset number display blinks 1 time.

On each band, 1 station can be put in the memory on each [1] — [6] button.

Auto Memory Entry

Putting stations with good reception in the memory automatically.

1 Select the band for Auto Memory Entry

Push the Control knob towards [FM] or [AM].

2 Open Auto Memory Entry

Press the [AME] button for at least 2 seconds.

"A-MEMORY" is displayed.

When 6 stations that can be received are put in the memory, Auto Memory Entry closes.

Preset Tuning

Recalling the stations in the memory.

1 Select the band

Push the Control knob towards [FM] or [AM].

2 Recall the station

Press the desired [1] — [6] button.

Frequency Step Setting

Changing the tuning frequency step.

The original setting is FM band 50 kHz, and AM band 9 kHz.

1 Turn the power OFF

Press the [SRC] button for at least 1 second.

2 Switch the frequency step

While pressing the [1] and [5] buttons, press the [SRC] button.

Release the [SRC] button first, after the display appears, release your fingers from the [1] and [5] buttons.

The frequency step changes to FM band 200 kHz, and AM band 10 kHz.



- When the same operation is repeated, the frequency step returns to the original setting.
- When the frequency step is changed, the frequencies in the memory are deleted.

Tuner/TV control features

Function of the KDC-X7533U
Function of LX BUS Television

TV Tuning

Selecting the TV channel of a connected LX BUS Television (optional accessory).

The action depends on the setting of the connected LX BUS Television. Refer to the user instruction of the LX BUS Television for details.

1 Select TV source

Press the [SRC] button.

Select the "TV" display.

2 Select the TV band and Video input

Push the Control knob toward [FM].

Each time you push the knob to [FM], TV bands and Video input alternate.

3 Select the TV channel

Push the Control knob towards [◀◀] or [▶▶].

Function of the KDC-X7533U
Function of LX BUS Television

TV channel Preset Memory

Putting the TV channels in the memory.

1 Select the TV band

Push the Control knob toward [FM].

2 Select the TV channel to put in the memory

Push the Control knob towards [◀◀] or [▶▶].

3 Put the TV channel in the memory

Press the desired [1] — [6] button for at least 2 seconds.

The preset number display blinks 1 time.

On each band, 1 TV channel can be put in the memory on each [1] — [6] button.

Function of the KDC-X7533U
Function of LX BUS Television

Preset TV Tuning

Recalling the TV channels in the memory.

1 Select the TV band

Push the Control knob toward [FM].

2 Recall the TV channel

Press the desired [1] — [6] button.

Function of the KDC-X7533U
Function of remote control

Direct TV Tuning

Entering the TV channel and tuning.

1 Select the TV band

Press the [FM] button.

2 Enter Direct TV Tuning mode

Press the [DIRECT] button on the remote control.

"- -" is displayed.

3 Enter the TV channel

Press the number buttons on the remote control.

Example:

Desired channel	Press button
8 ch	[0], [8]

Canceling Direct TV Tuning

Press the [DIRECT] button on the remote control.

CD/USB device/Audio file/External disc control features

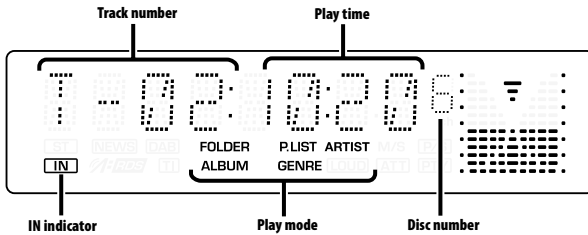
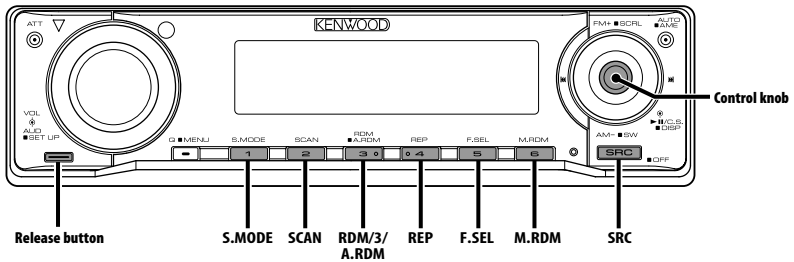

Playing CD & Audio file

When there is no disc inserted

- 1 Drop open the faceplate
Press the Release button.
- 2 Insert a disc.
- 3 Push the faceplate on the left side, and return it to its former position.



- When the faceplate has been dropped open, it might interfere with the shift lever or other vehicle function. If this happens, pay attention to safety and move the shift lever or take an appropriate action to remove the obstacle, then operate the unit.
- Do not use the unit with the faceplate in the open condition. If it's used in the open position dust can enter the inside part and cause damage.



- When a disc is inserted, the "IN" indicator is ON.
- You can cancel the announcement when selecting the folder by <Voice Index> (page 31) during the play of the ACDrive media. (KDC-X7533U only)

When a disc is inserted

Press the [SRC] button.
Select the "CD" display.

Pause and play

Press the Control knob.
Each time you press the knob, the audio pauses or plays.

Eject the disc

- 1 Drop open the faceplate
Press the Release button.
- 2 Eject the disc
Press the [▲] button.

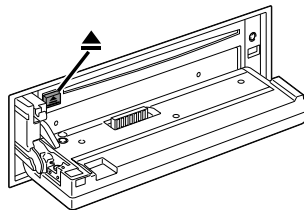

- 3 Press the faceplate on the left side, and return it to its former position.

CD/USB device/Audio file/External disc control features

Playing USB device

Playing USB device

1 Select a source other than the USB device

Press the [SRC] button.

2 Connect the USB device.

3 Select USB source

Press the [SRC] button.

Select the "USB" display.



- For the types of available USB devices and how to connect USB devices, refer to <About USB device> (page 7).
- After you stopped playing a file contained in the USB device, you can restart playing the file from the point where you stopped its playback.
Even after removing the USB device, you can restart playing the file from the point where you stopped its playback as long as the files contained in the USB device are all the same.
- Be sure to insert the USB device connector as far as it will go.
- You can play the disc (ACDrive media) made by Media Manager by the same operation. (KDC-X7533U only)
- You can cancel the announcement when selecting the folder by <Voice Index> (page 31) during the play of the ACDrive media. (KDC-X7533U only)

Pause and play

Press the Control knob.

Each time you press the knob, the audio pauses or plays.

Removing the USB device

1 Select a source other than the USB device

Press the [SRC] button.

2 Remove the USB device.



- Removing the USB device with it selected as a source can damage the data stored in the USB device.



- You can remove the USB device safely with the unit power turned off.

Playing External Disc

Playing discs set in the optional accessory disc player connected to this unit.

Press the [SRC] button.

Select the display for the disc player you want.

Display examples:

Display	Disc player
"CD CH"	CD changer
"MD CH"	MD changer

Pause and play

Press the Control knob.

Each time you press the knob, the audio pauses or plays.



- Disc 10 is displayed as "0".
- The functions that can be used and the information that can be displayed will differ depending on the external disc players being connected.

Fast Forwarding and Reversing

Fast Forwarding

Hold down toward [▶▶] with the Control knob.

Release to resume the playback.

Reversing

Hold down toward [◀◀] with the Control knob.

Release to resume the playback.



- There is no sound while the Audio file is being searched.
- You cannot fast Forwarding and Reversing depending on AAC file format.

Track/File Search

Searching for a song on the disc or in the Audio file folder.

Push the Control knob towards [◀◀] or [▶▶].

Function of disc changer/ Audio file

Disc Search/Folder Search

Selecting the disc set in the Disc changer or the folder recorded on the Audio file media.

Push the Control knob towards [FM] or [AM].

Function of remote control

Direct Track/File Search

Doing Track/File Search by entering the track/file number.

1 Enter the track/file number

Press the number buttons on the remote control.



- You can select Direct File Search up to 999.

2 Do Track/File Search

Press the [◀◀] or [▶▶] button.

Cancelling Direct Track/File Search

Press the [▶II] button.

Function of disc changers with remote control

Direct Disc Search

Doing Disc Search by entering the disc number.

1 Enter the disc number

Press the number buttons on the remote control.

2 Do Disc Search

Press the [+] or [-] button.

Cancelling Direct Disc Search

Press the [▶II] button.



- Input "0" to select disc 10.

Track/File/Disc/Folder Repeat

Replaying the song, disc in the Disc changer or Audio file folder you are listening to.

Press the [REP] button.

Each time you press the button, the Repeat Play alternates between the modes shown in the tables below.

In CD & External disc source

Repeat play	Display
Track Repeat	"TRAC REP"
Disc Repeat (In Disc Changer)	"DISC REP"
OFF	"REP OFF"

In Audio file source

Repeat play	Display
File Repeat	"FILE REP"
Folder Repeat	"FOLD REP"
OFF	"REP OFF"

Scan Play

Playing the first part of each song on the disc or Audio file folder you are listening to and searching for the song you want to hear.

1 Start Scan Play

Press the [SCAN] button.

"TRAC SCN"/"FILE SCN"/"SCAN ON" is displayed.

2 Release it when the song you want to listen to is played

Press the [SCAN] button.

Random Play

Play all the songs on the disc or Audio file folder in random order.

Press the [RDM] button.

Each time you press the button, Random Play turns ON or OFF.

When the Random mode is ON, "DISC RDM"/"FOLD RDM"/"RDM ON" is displayed.



- When you push the Control knob toward [▶▶], the next random song starts.

CD/USB device/Audio file/External disc control features

Function of disc changer

Magazine Random Play

Play the songs on all the discs in the disc changer in random order.

Press the [M.RDM] button.

Each time you press the button, the Magazine Random Play turns ON or OFF.

When the Magazine Random mode is ON, "MGZN RDM" is displayed.



- When you push the Control knob toward [▶▶], the next random song starts.

Function of Audio file

All Random Play

Playing randomly from all of the Audio files recorded in the media.

Press the [A.RDM] button for at least 1 second.

When the random mode is ON, "ALL RDM" is displayed.

Canceling the All Random Play

Press the [A.RDM] button.



- When you push the Control knob toward [▶▶], the next random song starts.

Function of Audio file

Select mode

Quickly selecting the file or folder you want to hear.

1 Select the Select mode

Press the [F.SEL] button.

Display	Select mode
"FILE SEL"*1	Refer to <File Select mode> (page 23).
"FLD SEL1"/"FLD SEL"	Refer to <Folder Select 1 mode> (page 23).
"FLD SEL2"*2	Refer to <Folder Select 2 mode> (page 24).

Exit the Select mode



- The Select mode does not function when <All Random Play> (page 22) is ON.
- *1 You cannot operate this function when <Random Play> (page 21) is set to "ON".
- *2 You cannot operate this function when <Switching the Play mode> (page 24) is set to other than "FOLDER" while playing ACDrive media.

2 Select the file/ folder

Refer to the explanation of the procedure performed in each select mode.

Scrolling the file/ folder name display

Push the Control knob toward [FM] for at least 2 seconds.



- You can cancel the announcement when selecting the folder by <Voice Index> (page 31) during the play of the ACDrive media. (KDC-X7533U only)
- In the File Select mode, the <Voice Index> (page 31) announcement is not made. (KDC-X7533U only)

Function of Audio file

File Select mode

You can select an audio file in the folder currently being played by file name.

1 Enter File Select mode

Press the [F.SEL] button.

Select the "FILE SEL" display.

Refer to <Select mode> (page 22).

File name display

Displays the current file name.

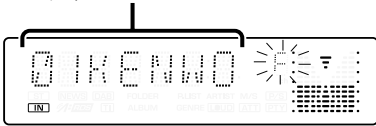

2 Select the file

Push the Control knob towards [◀◀] or [▶▶].

Switching between files in units of 10 songs
Push the Control knob towards [FM] or [AM].

With the [FM] button, you move 10 songs up and with the [AM] button, 10 songs down.



• You can select File Select mode up to 999.

3 Decide the file to play

Press the Control knob.

The File Select mode releases, and the Audio file being displayed plays.

Function of Audio file

Folder Select 1 mode

Select the target folder by tracing the hierarchical levels of folders. This is convenient when managing audio files by folder.

1 Enter Folder Select 1 mode

Press the [F.SEL] button.

Select the "FLD SEL1"/"FLD SEL" display.

Refer to <Select mode> (page 22).

Folder name display

Displays the current folder name.

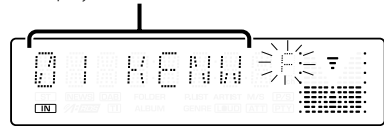

2 Select the folder level*

Push the Control knob towards [FM] or [AM].

With the [FM] button, you move 1 level down and with the [AM] button, 1 level up.

Selecting a folder in the same level

Push the Control knob towards [◀◀] or [▶▶].

With the [◀◀] of the Control knob, you move to the previous folder, and with the [▶▶] of the Control knob, to the next folder.

Returning to the top level*

Press the [3] button.



• * You cannot operate this function when <Switching the Play mode> (page 24) is set to other than "FOLDER" while playing ACDrive media.

3 Decide the folder to play

Press the Control knob.

The Folder Select mode releases, and the Audio file in the folder being displayed plays.

CD/USB device/Audio file/External disc control features

Function of Audio file

Folder Select 2 mode

Select the target folder within the folders containing audio files. The folder which contains playable audio files is only displayed.

1 Enter Folder Select 2 mode

Press the [F.SEL] button.

Select the "FLD SEL2" display.

Refer to <Select mode> (page 22).

Folder name display

Displays the current folder name.

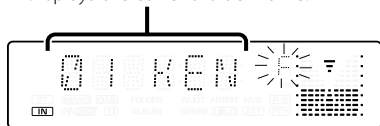

2 Select the folder

Push the Control knob towards [◀◀] or [▶▶].

Each time you push the knob, the folders containing audio files are displayed one after another.

Check the name of upper level folder

Push the Control knob towards [FM] or [AM].

With the [FM] button, the folder name in the upper level is displayed.

With the [AM] button, the folder name in the lower level is displayed.

" " " is displayed while the upper level folder is displayed.

3 Decide the folder to play

Press the Control knob.

The Folder Select mode releases, and the Audio file in the folder being displayed plays.

Function of the KDC-X7533U

Function of ACDrive media

Switching the Play mode

Arrange the playing orders of the songs by categories.

Press the [S.MODE] button.

Each time you press the button, the Play mode alternates between the modes shown in the table below.

The Play mode indicator is ON.

Play mode	Category which is to be arranged
"P. LIST"	Play list order.
"GENRE"	By genre.
"ARTIST"	By artist.
"ALBUM"	By album.
"FOLDER"	By the folder recorded in media



- The category information of each song is the data registered in Media Manager when ACDrive media is being generated.
- You can cancel the announcement made when the mode is changed by <Voice Index> (page 31).
- You can select the advancement of the Play mode information by [AM] and [FM] knob.

Function of the KDC-X7533U
Function of ACDrive media

Letter Seek

You can search for the song, you want to play, by selecting the initial of Genre name, Artist name, or Album name.

1 Enter the Letter Seek mode

Press the [S.MODE] button for at least 1 second.



- This operation does not function when <All Random Play> (page 22) is ON.
- This function is available only when the Play mode is set Genre, Artist, or Album.

Canceling the Letter Seek

Press the [S.MODE] button.

2 Start the Letter Seek

Push the Control knob towards [◀◀] or [▶▶].

The initial of Genre name, Artist name, or Album name is displayed and announced in order.



- The announcement of the initial can be canceled by <Voice Index> (page 31).
- When you push the Control knob to the reverse [◀◀] or [▶▶] during Letter Seek, the initial is displayed and announced in the reversed order.
- Once Letter Seek starts, it cannot be cancelled.

3 Select the song to play

Press the Control knob when the initial of the song you are searching is displayed and announced.

The selected initial group plays.

Text/Title Scroll

Scrolling the displayed CD text or MD title.

Push the Control knob toward [FM] for at least 2 seconds.



- When the <Display Illumination Control> (page 28) is set to OFF, the display may black out while scrolling.

Menu system

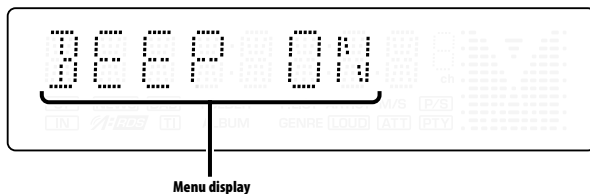
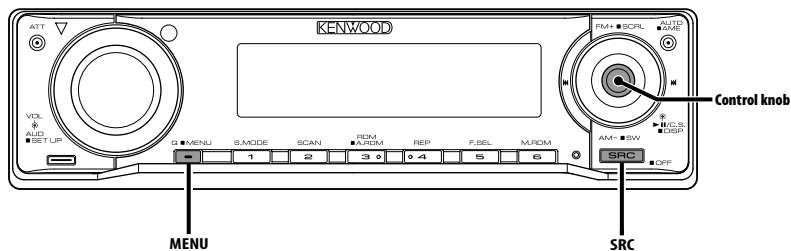

Menu System

Setting beep sound during operation, etc. functions.

The Menu system basic operation method is explained here. The reference for the Menu items and their setting content is after this operation explanation.

1 Enter Menu mode

Press the [MENU] button for at least 1 second.

"MENU" is displayed.

2 Select the menu item

Push the Control knob towards [FM] or [AM].

Example: When you want to set the beep sound, select the "BEEP" display.

3 Set the menu item

Push the Control knob towards [◀◀] or [▶▶].

Example: When you select "BEEP", each time you push the knob it alternates between "BEEP ON" or "BEEP OFF". Select 1 of them as the setting.

You can continue by returning to step 2 and setting other items.

4 Exit Menu mode

Press the [MENU] button.



- When other items those applicable to the basic operation method above are displayed, their setting content chart is entered. (Normally the setting listed at the top of the chart is the original setting.) Also, the explanation for items that are not applicable (<Manual Clock Adjustment> etc.) are entered step by step.

In Standby mode

Security Code

Activating the Security Code disables the usage of audio unit by someone else. Once the Security Code is activated, the entry of authorized Security Code is required to turn on the audio unit when it is removed from the vehicle. Indication of this Security Code activation prevents your precious audio unit from stealing.



- When you activate the Security Code function, it cannot be released.
Note, your Security Code is the 4 digit number entered in your "Car Audio Passport" in this package.

1 Enter Standby

Press the [SRC] button.

Select the "STANDBY" display.

2 Enter Menu mode

Press the [MENU] button for at least 1 second.

When "MENU" is displayed, "CODE SET" is also displayed.

3 Enter Security Code mode

Press the Control knob for at least 1 second.

When "ENTER" is displayed, "CODE" is also displayed.

4 Select the digits to enter

Push the Control knob towards [◀◀] or [▶▶].

5 Select the Security Code numbers

Push the Control knob towards [FM] or [AM].

6 Repeat steps 4 and 5, and complete the Security Code.

7 Confirm the Security Code

Press the Control knob for at least 3 seconds.

When "RE-ENTER" is displayed, "CODE" is also displayed.

8 Do the step 4 through 7 step operation, and reenter the security code.

"APPROVED" is displayed.

The Security Code function activates.



- If you enter a code different from your Security Code, you have to start over from step 4.

Resetting the Security Code function when the audio unit is first used after removed from the battery power source or the Reset button is pressed

1 Turn the power ON.

2 Do the step 4 through 7 step operation, and reenter the security code.

"APPROVED" is displayed.

Now, you can use the unit.



- If an incorrect code is entered, "WAITING" is displayed, and the input prohibition periods shown in the table below is generated.
After the input prohibition time lapses, "CODE" is displayed, and you can reenter the code.

Number of times the incorrect code was input	Input prohibited time
1	—
2	5 minutes
3	1 hour
4	24 hours

In Standby mode

Touch Sensor Tone

Setting the operation check sound (beep sound) ON/OFF.

Display	Setting
"BEEP ON"	Beep is heard.
"BEEP OFF"	Beep canceled.

Menu system

In Standby mode

Manual Clock Adjustment

1 Select Clock Adjustment mode

Push the Control knob towards [FM] or [AM].
Select the "CLK ADJ" display.

2 Enter Clock Adjust mode

Press the Control knob for at least 1 second.
The clock display blinks.

3 Adjust the hours

Push the Control knob towards [FM] or [AM].

Adjust the minutes

Push the Control knob towards [◀◀] or [▶▶].

4 Exit Clock adjustment mode

Press the [MENU] button.

In Standby mode

DSI (Disabled System Indicator)

A red indicator will blink on the unit after the faceplate is removed, warning potential thieves.

Display	Setting
"DSI ON"	LED flashes.
"DSI OFF"	LED OFF.

Function of the KDC-X7533U

In Standby mode

Selectable Illumination

Selecting the button illumination color as green or red.

Display	Setting
"KEY GRN"	The illumination color is green.
"KEY RED"	The illumination color is red.

Display Illumination Control

This function turns off the display when you perform no operation for 5 seconds. This function is effective when you are driving at night.

Display	Setting
"DISP ON"	Keeps the display on.
"DISP OFF"	Turns off the display when you perform no operation for 5 seconds.



- When the display is off, pressing any key will turn on the display.
- When the display is off, you cannot perform any operation except for the following:
 - Volume
 - Attenuator
 - Selecting the source
 - Ejecting the disc
 - Turning off the power
- During function control, such as the Menu System, the display stays on.

In Standby mode

Dimmer

Dimming this unit's display automatically when the vehicle light switch is turned ON.

Display	Setting
"DIM ON"	The display dims.
"DIM OFF"	The display doesn't dim.

Function of the KDC-X7533U
In Standby mode

Built-in Amp Setting

Controlling the built-in amplifier.
Turning OFF this control enhances the preout quality.

Display	Setting
"AMP ON"	The built-in amplifier activates.
"AMP OFF"	The built-in amplifier deactivates.

Function of the KDC-X7533U
Other than Standby mode/
When the Dual Zone System is ON

Dual Zone System Setting

Setting the Front channel and Rear channel sound in the Dual Zone System.

Display	Setting
"ZONE2 R"	Sub source (Auxiliary input source) is to be rear channel.
"ZONE2 F"	Sub source (Auxiliary input source) is to be front channel.

Function of the KDC-X7533U
Other than Standby mode

B.M.S. (Bass Management System)

Adjust the bass boost level of the external amplifier using the main unit.

Display	Setting
"BMS FLT"	Bass boost level is flat.
"BMS +6"	Bass boost level is low (+6dB).
"BMS +12"	Bass boost level is mid (+12dB).
"BMS +18"	Bass boost level is high (+18dB).



- Refer to the catalog or instruction manual for power amplifiers that can be controlled from this unit.
- For amplifiers, there are the models you can set from Flat to +18 dB, and the models you can set from Flat to +12 dB.

When an amplifier that can only be set to +12 is connected to the unit, "BMS +18" will not work correctly even if it is selected.

Function of the KDC-X7533U
Other than Standby mode

B.M.S. Frequency Offset

Setting the central frequency, boosted by B.M.S.

Display	Setting
"BMSF NML"	Boost with the normal central frequency.
"BMSF LOW"	Drop the normal central frequency 20%.

Function of the KDC-X7533U
When LX AMP unit connecting

AMP Control

You can control the LX AMP connected to the unit.

1 Select AMP Control mode

Push the Control knob towards [FM] or [AM].
Select the "AMP CTRL" display.

2 Enter AMP Control mode

Press the Control knob for at least 1 second.

3 Select the AMP Control item for adjustment

Push the Control knob towards [FM] or [AM].



- For the details on the AMP Control item, see the Instruction manual attached to the LX AMP.

4 Adjust the AMP Control item

Push the Control knob towards [◀◀] or [▶▶].

5 Exit AMP Control mode

Press the [MENU] button.



- You cannot use the LX AMP operation during standby mode.

Menu system

In FM reception

CRSC (Clean Reception System Circuit)

Temporarily have reception alternate from stereo to mono to reduce multi-path noise when listening to the FM station.

Display	Setting
"CRSC ON"	The CRSC is ON.
"CRSC OFF"	The CRSC is OFF.



- Strong electrical fields (such as from power lines) may cause unstable sound quality when CRSC is turned ON. In such a situation, turn it OFF.

Auxiliary Input Display Setting

Selecting the display when alternating to Auxiliary input source.

1 Select Auxiliary input source

Press the [SRC] button.

Select the "AUX EXT" display.

2 Enter Menu mode

Press the [MENU] button for at least 1 second.

"MENU" is displayed.

3 Select Auxiliary input display setting mode

Push the Control knob towards [FM] or [AM].

Select the "NAME SET" display.

4 Enter Auxiliary input display setting mode

Press the Control knob for at least 1 second.

The selected Auxiliary input display is displayed.

5 Select the Auxiliary input display

Push the Control knob towards [◀◀] or [▶▶].

Each time you push the knob, the display alternates as listed below.

- "AUX EXT"
- "DVD"
- "PORTABLE"
- "GAME"
- "VIDEO"
- "TV"

6 Exit Auxiliary input display setting mode

Press the [MENU] button.



- When operation stops for 10 seconds, the name at that time is registered, and the Auxiliary input display setting mode closes.
- You can only set the Auxiliary input display when the auxiliary input of optional KCA-S210A is used.

Text Scroll

Setting the displayed text scroll.

Display	Setting
"SCL AUTO"	Repeats scroll.
"SCL MANU"	Scrolls when the display changes.



- The text scrolled is listed below.
 - CD text
 - Folder name/ File name/ Song title/ Artist name/ Album name
 - MD title

In Standby mode

CD Read Setting

When there is a problem with playing a CD with special format, this setting plays the CD by force.

Display	Setting
"CD READ1"	Play CD and Audio file.
"CD READ2"	Play CD by force.



- Setting "CD READ2" cannot play Audio file. Some music CDs may not play even in the "CD READ2" mode.

Function of the KDC-X7533U

Function of ACDrive media

Voice Index

Setting the announcement during the play of ACDrive media.

Display	Setting
"V-ID ON"	Guide is announced.
"V-ID OFF"	Not be announced.

In CD/ USB mode

Firmware version display

Displaying the firmware version with the unit.

1 Select the firmware version display mode

Push the Control knob towards [FM] or [AM].

Select the "ACD VER"/"F/W VER" display.

2 Display the firmware version

Push the Control knob towards [◀◀] or

[▶▶].

Function of the KDC-X7533U

In CD/ USB mode

Unique ID display

Displaying the serial number for each product.

1 Select the unique ID display mode

Push the Control knob towards [FM] or [AM].

Select the "ACD ID" display.

2 Display the unique ID

Push the Control knob towards [◀◀] or

[▶▶].

Function of the KDC-X7533U

Other than Standby mode

Audio Preset Memory

Registering the value setup by Sound Control. The memory cannot be erased by the Reset button.

1 Setup Sound Control

Refer to the following operations to setup the Sound Control.

- <Audio Control> (page 11)

- <Audio Setup> (page 12)

2 Enter Menu mode

Press the [MENU] button for at least 1 second.

"MENU" is displayed.

3 Select Audio Preset mode

Push the Control knob towards [FM] or [AM].

Select the "A-PRESET" display.

4 Enter Audio Preset mode

Press the Control knob for at least 1 second.

5 Select the Audio Preset Memory

Push the Control knob towards [FM] or [AM].

Select the "MEMORY" display.

6 Put the Audio Preset in the memory

Press the Control knob for at least 2 seconds.

The "MEMORY" display blinks 1 time.

7 Exit Audio Preset mode

Press the [MENU] button.



- Register 1 pair of Audio Preset Memory. You cannot register by the source.
- When you press the Reset, all the sources will be the setting value which is registered.
- The following items cannot be registered. Volume, Balance, Fader, Loudness, Volume offset, Dual Zone System, Rear Volume

Menu system

Function of the KDC-X7533U

Other than Standby mode

Audio Preset Recall

Recalling the sound setup registered by <Audio Preset Memory> (page 31).

1 Select the source

Press the [SRC] button.

2 Enter Menu mode

Press the [MENU] button for at least 1 second.

"MENU" is displayed.

3 Select Audio Preset mode

Push the Control knob towards [FM] or [AM].

Select the "A-PRESET" display.

4 Enter Audio Preset mode

Press the Control knob for at least 1 second.

5 Select the Audio Preset Recall

Push the Control knob towards [FM] or [AM].

Select the "RECALL" display.

6 Recall the Audio Preset

Press the Control knob for at least 2 seconds.

The "RECALL" display blinks 1 time.

7 Exit Audio Preset mode

Press the [MENU] button.



- The User memory of <System Q> (page 11) is changed to the value which was recalled.
- The source tone memory item of <Audio Control> (page 11) is changed to the value which was recalled by the selected source.

Basic Operations of remote control

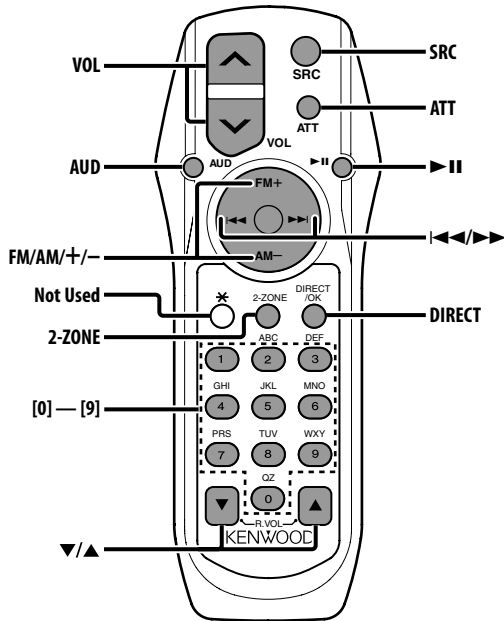

Loading and Replacing the battery

Use two "AA"/ "R6"-size batteries.
Slide the cover while pressing downwards to remove it as illustrated.
Insert the batteries with the + and - poles aligned properly, following the illustration inside the case.

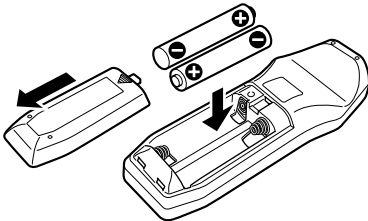

▲WARNING

- Store unused batteries out of the reach of children.
Contact a doctor immediately if the battery is accidentally swallowed.



- Do not set the remote control in hot places such as on the dashboard.

Basic operations

[VOL] buttons

Adjusts the volume.

[SRC] button

Each time you press the button, the source alternates.

For the source alternating order refer to <Selecting the Source> (page 10).

[ATT] button

Turns the volume down quickly.

When the button is pressed again, the volume returns to the previous level.

Basic Operations of remote control

Audio Control

[AUD] button

Selects the Audio item to be adjusted.

[VOL] buttons

Adjusts the Audio item.



- Refer to <Audio Control> (page 11) for the operation method, such as the procedures for Audio control and others operations.
- The remote control can only select and adjust the Basic Audio item. Selecting and adjusting of the Detail Audio item cannot be done.

Function of the KDC-X7533U

Dual Zone System

[2-ZONE] button

Each time you press the button, "2ZON" of <Audio Setup> (page 12) is turned ON or OFF.

[▲]/ [▼] buttons

Adjusts the volume of the rear channel.
The rear channel activates while the Dual Zone System is ON.

In Tuner source

[FM]/ [AM] buttons

Selects the band.
Each time you press the [FM] button, the band alternates between the FM1, FM2, and FM3 bands.

[◀◀]/ [▶▶] buttons

Tune up or down band.

[0] — [9] buttons

Press buttons [1] — [6] to recall preset stations.

[DIRECT] button

Enters and cancels the <Direct Access Tuning> (page 17) mode.

In Disc/USB source

[◀◀]/ [▶▶] buttons

Going forwards and backwards between track/ files.

[+]/ [-] buttons

Going forwards and backwards between disc/ folders.

[▶II] button

Each time you press the button, the song pauses or plays.

[0] — [9] buttons

When in <Direct Track/File Search> (page 21) and <Direct Disc Search> (page 21), enters the track/ file/disc number.

Function of the KDC-X7533U

In TV source

[FM] button

Selects the TV band and Video input.
Each time you press the [FM] button, TV bands and Video input alternates.

[◀◀]/ [▶▶] buttons

Selects the TV channel.

[0] — [9] buttons

Press buttons [1] — [6] to recall preset TV channels.

[DIRECT] button

Enters and cancels the <Direct TV Tuning> (page 18) mode.

Accessories/ Installation Procedure

Accessories

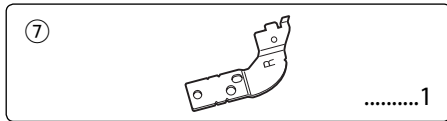
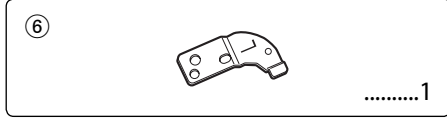
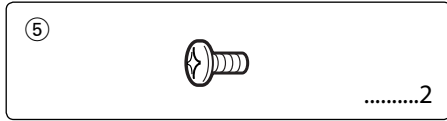
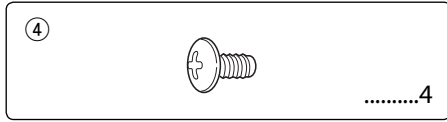
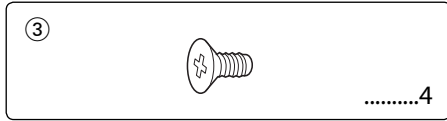
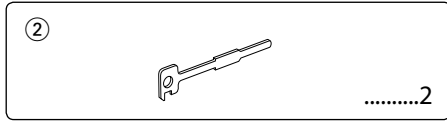
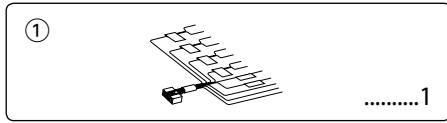

Installation Procedure

1. To prevent a short circuit, remove the key from the ignition and disconnect the \ominus battery.
2. Make the proper input and output wire connections for each unit.
3. Connect the speaker wires of the wiring harness.
4. Connect the wiring harness wires in the following order: ground, battery, ignition.

5. Connect the wiring harness connector to the unit.
6. Install the unit in your car.
7. Reconnect the \ominus battery.
8. Press the reset button.

▲WARNING

If you connect the ignition wire (red) and the battery wire (yellow) to the car chassis (ground), you may cause a short circuit, that in turn may start a fire. Always connect those wires to the power source running through the fuse box.



- If the power is not turned ON (or it is ON, but will be OFF immediately), the speaker wire may have a short-circuit or touched the chassis of the vehicle and the protection function may have been activated. Therefore, the speaker wire should be checked.
- If your car's ignition does not have an ACC position, connect the ignition wires to a power source that can be turned on and off with the ignition key. If you connect the ignition wire to a power source with a constant voltage supply, as with battery wires, the battery may die.
- If the console has a lid, make sure to install the unit so that the faceplate will not hit the lid when closing and opening.
- If the fuse blows, first make sure the wires aren't touching to cause a short circuit, then replace the old fuse with one with the same rating.
- Insulate unconnected wires with vinyl tape or other similar material. To prevent a short circuit, do not remove the caps on the ends of the unconnected wires or the terminals.
- Connect the speaker wires correctly to the terminals to which they correspond. The unit may be damaged or fail to work if you share the \ominus wires or ground them to any metal part in the car.
- When only two speakers are being connected to the system, connect the connectors either to both the front output terminals or to both the rear output terminals (do not mix front and rear). For example, if you connect the \oplus connector of the left speaker to a front output terminal, do not connect the \ominus connector to a rear output terminal.
- After the unit is installed, check whether the brake lamps, blinkers, wipers, etc. on the car are working properly.
- Mount the unit so that the mounting angle is 30° or less.

Connecting Wires to Terminals (KDC-X7533U)

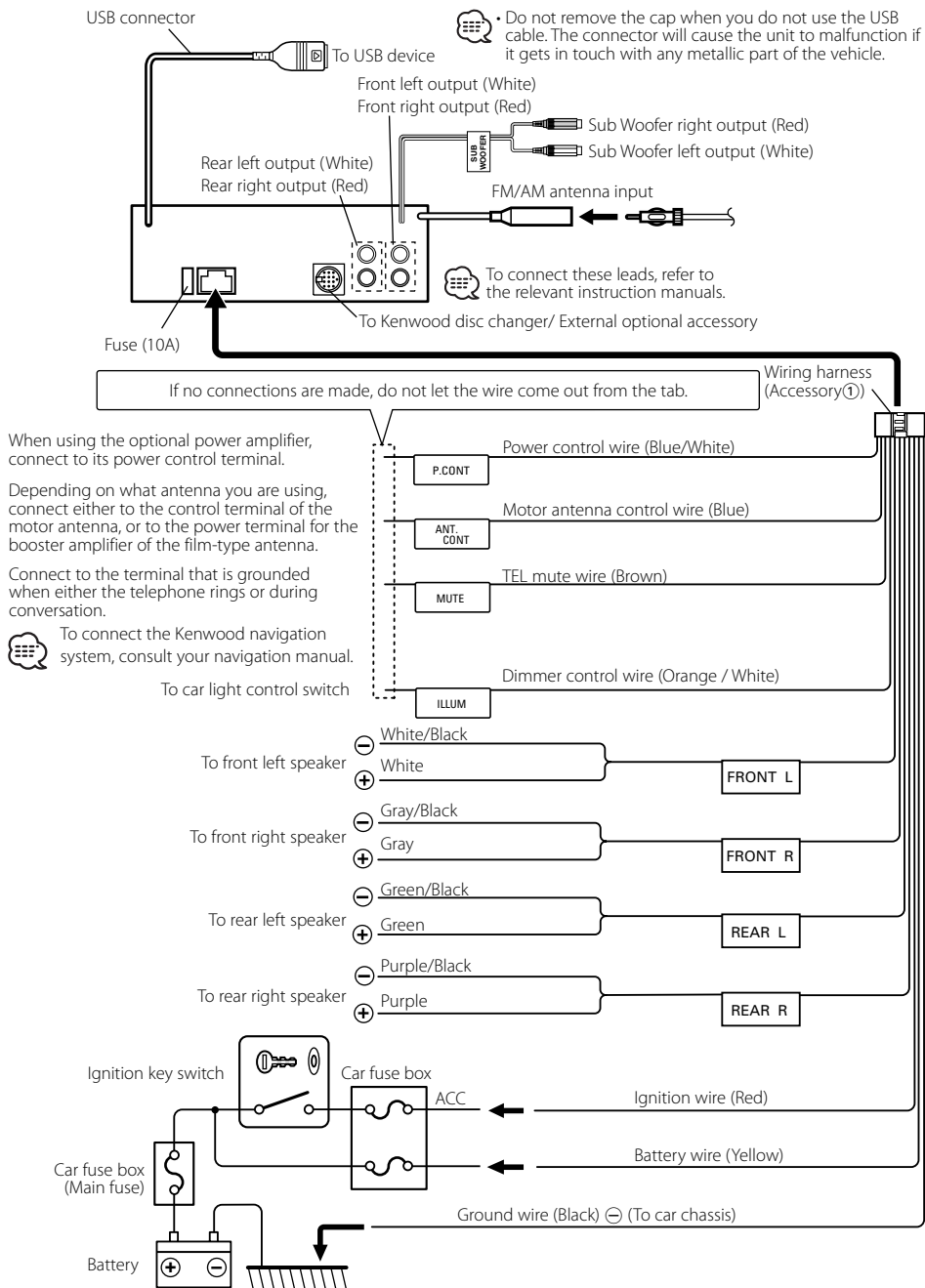

Connecting Wires to Terminals (KDC-MP5033U)

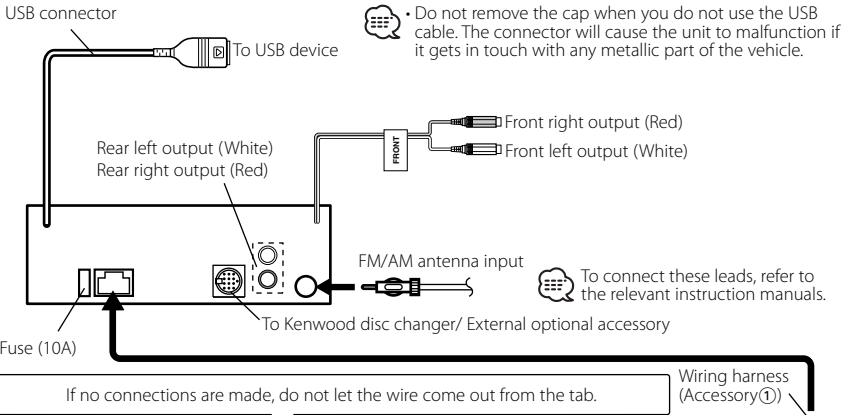

When using the optional power amplifier, connect to its power control terminal.

Depending on what antenna you are using, connect either to the control terminal of the motor antenna, or to the power terminal for the booster amplifier of the film-type antenna.

Connect to the terminal that is grounded when either the telephone rings or during conversation.

To connect the Kenwood navigation system, consult your navigation manual.

To car light control switch

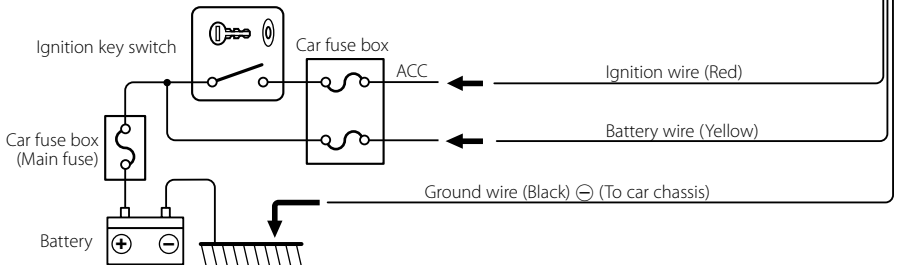
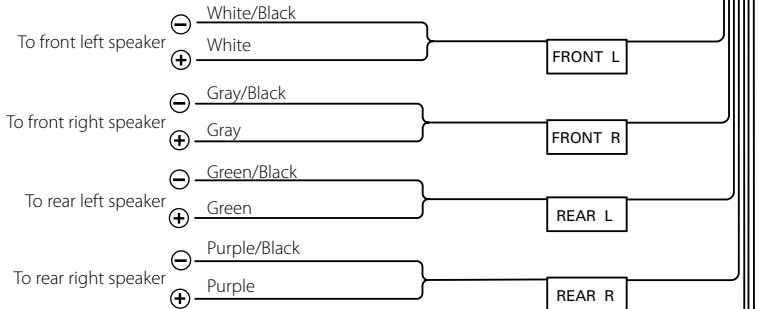
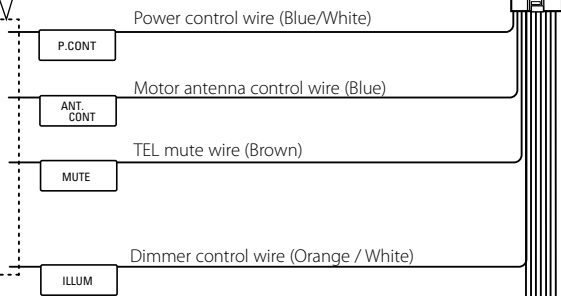

Installation

non-Japanese cars

Metal mounting strap
(commercially available)

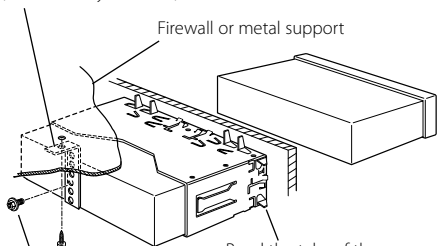

Firewall or metal support

Bend the tabs of the mounting sleeve with a screwdriver or similar utensil and attach it in place.

Self-tapping screw
(commercially available)

Screw (M4X8)
(commercially available)



- Make sure that the unit is installed securely in place. If the unit is unstable, it may malfunction (for example, the sound may skip).

Japanese cars

- 1 Refer to the section <Removing the hard rubber frame> (page 40) and then remove the hard rubber frame.
- 2 Align the holes in the unit (two locations on each side) with the vehicle mounting bracket and secure the unit with the accessory screws.

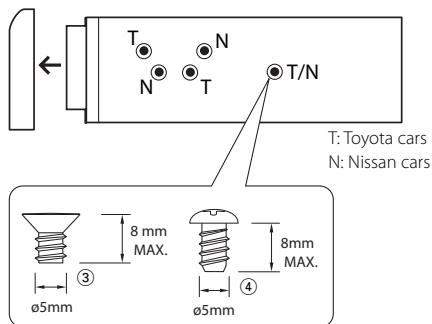

T: Toyota cars
N: Nissan cars

Accessory ③...for Nissan car

Accessory ④...for Toyota car



- During installation, do not use any screws except for those provided. The use of different screws might result in damage to the main unit.
- Damage may occur if a screwdriver or similar tool is used with excessive force during the installations.

Screwing the Faceplate on the Unit

If you want to fasten the faceplate to the main unit so that it does not fall off.

- 1** Refer to the section <Removing the hard rubber frame> (page 40) and then remove the hard rubber frame.
- 2** Drop open the faceplate by pressing the Release button.

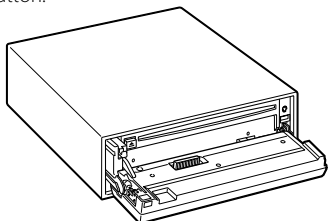

- 3** Tighten the screw ($\varnothing 2 \times 5$ mm) (Accessory⑤) and bracket (Accessory⑥) in the hole shown on the diagram.

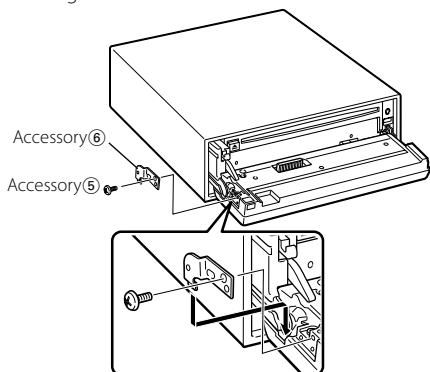

- 4** Tighten the screw ($\varnothing 2 \times 5$ mm) (Accessory⑤) and bracket (Accessory⑦) in the hole shown on the diagram.

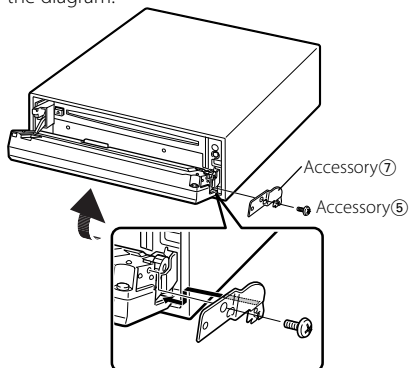

- Never insert the screws in any other screw hole than the one specified. If you screw them in another hole, it will contact and may cause damage to the mechanical parts inside the unit.

Removing the Unit

Removing the hard rubber frame

- 1 Engage the catch pins on the removal tool and remove the two locks on the upper level. Upper the frame and pull it forward as shown in the figure.

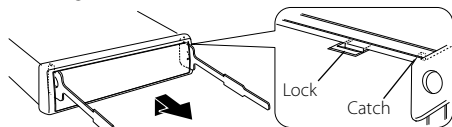

Accessory②
Removal tool

- 2 When the upper level is removed, remove the lower two locations.

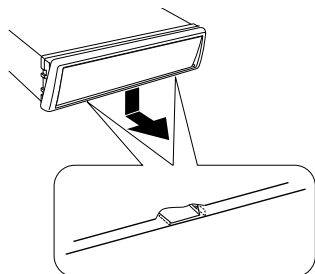

- The frame can be removed from the bottom side in the same manner.

Removing the Unit

- 1 Refer to the section <Removing the hard rubber frame> (page 40) and then remove the hard rubber frame.
- 2 Remove the screw (M4 × 8) on the back panel.
- 3 Insert the two removal tools deeply into the slots on each side, as shown.

Screw (M4X8)
(commercially available)

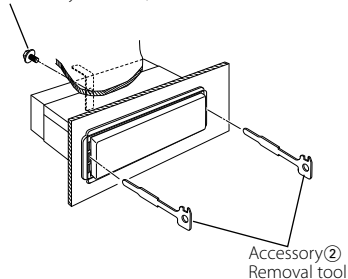

- 4 Lower the removal tool toward the bottom, and pull out the unit halfway while pressing towards the inside.

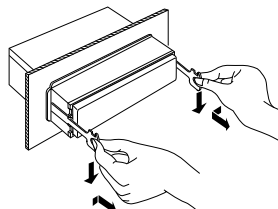

- Be careful to avoid injury from the catch pins on the removal tool.

- 5 Pull the unit all the way out with your hands, being careful not to drop it.

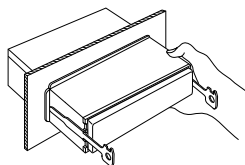

Troubleshooting Guide

What might seem to be a malfunction in your unit may just be the result of slight misoperation or miswiring. Before calling service, first check the following table for possible problems.

General

? The power does not turn ON.

- ✓ The fuse has blown.
 - ⓘ After checking for short circuits in the wires, replace the fuse with one with the same rating.
-

? There's a source you can't switch.

- ✓ There's no media inserted.
 - ⓘ Set the media you want to listen to. If there's no media in this unit, you can't switch to each source.
 - ✓ The Disc changer isn't connected.
 - ⓘ Connect the Disc changer. If the Disc changer isn't connected to its input terminal, you can't switch to an external disc source.
-

? The memory is erased when the ignition is turned OFF.

- ✓ The ignition and battery wire are incorrectly connected.
 - ⓘ Connect the wire correctly, referring to the section on <Connecting Wires to Terminals> (page 36, 37).
-

? The TEL mute function does not work.

- ✓ The TEL mute wire is not connected properly.
 - ⓘ Connect the wire correctly, referring to the section on <Connecting Wires to Terminals> (page 36, 37).
-

? The TEL mute function turns ON even though the TEL mute wire is not connected.

- ✓ The TEL mute wire is touching a metal part of the car.
 - ⓘ Pull the TEL mute wire away from the metal part of the car.
-

? Even if Loudness is turned ON, high-pitched tone isn't compensated for.

- ✓ Tuner source is selected.
 - ⓘ High-pitched tone isn't compensated for when in Tuner source.
-

? No sound can be heard, or the volume is low.

- ✓ The fader or balance settings are set all the way to one side.
 - ⓘ Center the fader and balance settings.
 - ✓ The input/output wires or wiring harness are connected incorrectly.
 - ⓘ Reconnect the input/output wires or the wiring harness correctly. See the section on <Connecting Wires to Terminals> (page 36, 37).
 - ✓ The values of Volume offset are low.
 - ⓘ Turn up the Volume offset, referring to the section on <Audio Setup> (page 12).
 - ✓ The <Built-in Amp Setting> (page 29) is OFF.
 - ⓘ Turn it ON.
-

? The sound quality is poor or distorted.

- ✓ One of the speaker wires is being pinched by a screw in the car.
 - ⓘ Check the speaker wiring.
 - ✓ The speakers are not wired correctly.
 - ⓘ Reconnect the speaker wires so that each output terminal is connected to a different speaker.
-

? The Touch Sensor Tone doesn't sound.

- ✓ The preout jack is being used.
 - ⓘ The Touch Sensor Tone can't be output from the preout jack.
-

? The Dimmer function doesn't work.

- ✓ The Dimmer wire isn't connected correctly.
 - ⓘ Check the Dimmer wire connection.
 - ✓ The <Dimmer> (page 28) is OFF.
 - ⓘ Turn it ON.
-

? The display blacks out while scrolling.

- ✓ <Display Illumination Control> is set to OFF.
 - ⓘ Refer to <Display Illumination Control> (page 28).
-

? The sound is not output from Subwoofer or it outputs the different sound.

- ✓ When "2 ZONE" of <Audio Setup> is set to ON.
 - ⓘ Set "2 ZONE" of <Audio Setup> (page 12) to OFF.
-

? Cannot set Dual Zone System of <Audio Setup> (page 12).

- ✓ CA-C1AX/ CA-C2AX is connected to KCA-S210A or other units.
 - ⓘ Connect the CA-C1AX/ CA-C2AX directly to this unit.
-

Troubleshooting Guide

Tuner source

? Radio reception is poor.

- ✓ The car antenna is not extended.
 - ☞ Pull the antenna out all the way.
- ✓ The antenna control wire is not connected.
 - ☞ Connect the wire correctly, referring to the section on <Connecting Wires to Terminals> (page 36, 37).

? The desired frequency can't be entered with the Direct Access Tuning.

- ✓ A station that can't be received is being entered.
 - ☞ Enter a station that can be received.
- ✓ You're trying to enter a frequency with a 0.01 MHz unit.
 - ☞ What can be designated in the FM band is to 0.1 MHz.

Disc source

? "AUX EXT" is displayed without achieving External disc control mode.

- ✓ Unsupported disc changer is connected.
 - ☞ Use the disc changer mentioned in the <About CD players/disc changers connected to this unit> (page 3) of the section on <Safety precautions>.

? The specified disc does not play, but another one plays instead.

- ✓ The specified CD is quite dirty.
 - ☞ Clean the CD.
- ✓ The disc is loaded in a different slot from that specified.
 - ☞ Eject the disc magazine and check the number for the specified disc.
- ✓ The disc is severely scratched.
 - ☞ Try another disc instead.

? Can't remove disc.

- ✓ The cause is that more than 10 minutes has elapsed since the vehicle ACC switch was turned OFF.
 - ☞ The disc can only be removed within 10 minutes of the ACC switch being turned OFF. If more than 10 minutes has elapsed, turn the ACC switch ON again and press the Eject button.

? The disc won't insert.

- ✓ There's already another disc inserted.
 - ☞ Press the [▲] button and remove the disc.

? Direct Search can't be done.

- ✓ Another function is ON.
 - ☞ Turn Random Play or other functions OFF.

? Track Search can't be done.

- ✓ For the discs/folders first or last song.
 - ☞ For each disc/folder, Track Search can't be done in the backward direction for the first song or in the forward direction for the last song.

Audio file source

? Cannot play an Audio file.

- ✓ The media is scratched or dirty.
 - ☞ Clean the media, referring to the CD cleaning of the section on <About CDs> (page 6).

? The sound skips when an Audio file is being played.

- ✓ The media is scratched or dirty.
 - ☞ Clean the media, referring to the CD cleaning of the section on <About CDs> (page 6).
- ✓ The recording condition is bad.
 - ☞ Record the media again or use another media.

? The Audio file track time isn't displayed correctly.

- ✓ ---
 - ☞ There are times when it isn't displayed correctly according to the Audio file recording conditions.

USB device source

? The USB device is not detected.

- ✓ The USB connector is disconnected.
 - ☞ Connect the connector of the USB device properly.

? The USB device does not play its audio files.

- ✓ The USB connector is disconnected.
 - ☞ Connect the connector of the USB device properly.

The messages shown below display your systems condition.

EJECT:	No disc magazine has been loaded in the changer. The disc magazine is not completely loaded. ↳ Load the disc magazine properly. No CD in the unit. ↳ Insert the CD.
NO DISC:	No disc has been loaded in the disc magazine. ↳ Load a disc into the disc magazine.
TOC ERR:	No disc has been loaded in the disc magazine. ↳ Load a disc into the disc magazine. The CD is quite dirty. The CD is upside-down. The CD is scratched a lot. ↳ Clean the CD and load it correctly.
READ ERR:	<ul style="list-style-type: none"> • The number of files or folders which are stored in the connected USB device is above the limitation. • The file system of the connected USB device is broken. ↳ Copy the files and folders for the USB device again referring to www.kenwood.mediamanager.jp . If the error message is still displayed, initialize the USB device or use other USB devices.
E-05:	The CD is upside-down. ↳ Load the CD correctly.
BLANK:	Nothing has been recorded on the MD.
NO TRACK:	No tracks are recorded on the MD, although it has a title.
NO PANEL:	The faceplate of the slave unit being connected to this unit has been removed. ↳ Replace it.
E-77:	The unit is malfunctioning for some reason. ↳ Press the reset button on the unit. If the "E-77" code does not disappear, consult your nearest service center.
E-99:	Something is wrong with the disc magazine. Or the unit is malfunctioning for some reason. ↳ Check the disc magazine. And then press the reset button on the unit. If the "E-99" code does not disappear, consult your nearest service center.
LOAD:	Discs are being exchanged in the Disc changer.
READING:	The unit is reading the data on the disc.

HOLD:	The protective circuit in the unit activates when the temperature inside the automatic disc changer exceeds 60°C (140°F), stopping all operation. ↳ Cool down the unit by opening the windows or turning on the air conditioner. As the temperature falls below 60°C (140°F), the disc will start playing again.
IN (Blink):	The CD player section is not operating properly. ↳ Reinsert the CD. If the CD cannot be ejected or the display continues to flash even when the CD has been properly reinserted, please switch off the power and consult your nearest service center.
PROTECT:	The speaker wire has a short-circuit or touches the chassis of the vehicle, and then the protection function is activated. ↳ Wire or insulate the speaker cable properly and press the reset button.
NA FILE:	An Audio file is played with a format that this unit can't support. ↳ ----
COPY PRO:	A copy-protected file is played. ↳ ----
NO DEVICE:	The USB device is selected as a source although no USB device is connected. ↳ Change the source to any source other than USB. Connect an USB device, and change the source to USB again.
NA DEVICE:	An unsupported USB device is connected. ↳ For the supported USB devices, refer to <About USB device> (page 7).
NO MUSIC/ E-15:	<ul style="list-style-type: none"> • Media was played that doesn't have data recorded that the unit can play. • The connected USB device contains no playable audio file. ↳ Use media that has data recorded that the unit can play.
USB ERR:	The connected USB device is rated a current capacity higher than the allowable limit. ↳ Check the USB device with reference to <About USB device> (page 7). Some trouble may have occurred to the connected USB device. ↳ Remove the USB device and then reconnect it. When the same message displays again, use another USB device.

Specifications

Specifications subject to change without notice.

FM tuner section

- Frequency range (50 kHz space)
 - : 87.5 MHz – 108.0 MHz
- Frequency range (200 kHz space)
 - : 87.9 MHz – 107.9 MHz
- Usable sensitivity (S/N = 30dB)
 - : 9.3dBf (0.8 μ V /75 Ω)
- Quieting Sensitivity (S/N = 50dB)
 - : 15.2dBf (1.6 μ V /75 Ω)
- Frequency response (\pm 3.0 dB)
 - : 30 Hz – 15 kHz
- Signal to Noise ratio (MONO)
 - : 70 dB
- Selectivity (\pm 400 kHz)
 - : \geq 80 dB
- Stereo separation (1 kHz)
 - : 40 dB

AM tuner section

- Frequency range (9 kHz space)
 - : 531 kHz – 1611 kHz
- Frequency range (10 kHz space)
 - : 530 kHz – 1700 kHz
- Usable sensitivity (S/N = 20dB)
 - : 28 dB μ (25 μ V)

CD player section

- Laser diode
 - : GaAlAs
- Digital filter (D/A)
 - : 8 Times Over Sampling
- D/A Converter
 - : 1 Bit
- Spindle speed
 - : 1000 – 400 rpm (CLV 2times)
- Wow & Flutter
 - : Below Measurable Limit
- Frequency response (\pm 1 dB)
 - : 10 Hz – 20 kHz
- Total harmonic distortion (1 kHz)
 - : 0.008 %
- Signal to Noise ratio (1 kHz)
 - : 110 dB
- Dynamic range
 - : 93 dB
- MP3 decode
 - : Compliant with MPEG-1/2 Audio Layer-3
- WMA decode
 - : Compliant with Windows Media Audio
- AAC decode
 - : AAC-LC ".m4a" files

Audio section

- Maximum output power
 - : 50 W x 4
- Full Bandwidth Power (at less than 1% THD)
 - : 22 W x 4
- Speaker impedance
 - : 4 - 8 Ω
- Tone action
 - Bass : 100 Hz \pm 8 dB
 - Middle : 1 kHz \pm 8 dB
 - Treble : 10 kHz \pm 8 dB
- Preout level / Load (during disc play)
 - : 4000 mV/10 k Ω (KDC-X7533U)
 - : 2000 mV/10 k Ω (KDC-MP5033U)
- Preout impedance
 - : \leq 600 Ω

USB Interface

- USB Standard
 - : USB1.1/ 2.0
- File System
 - : FAT16/ 32
- Maximum Supply current
 - : 500 mA
- MP3 decode
 - : Compliant with MPEG-1/2 Audio Layer-3
- WMA decode
 - : Compliant with Windows Media Audio
- AAC decode
 - : AAC-LC ".m4a" files

General

- Operating voltage (11 – 16V allowable)
 - : 14.4 V
- Current consumption
 - : 10 A
- Installation Size (W x H x D)
 - : 182 x 53 x 155 mm
- Weight
 - : 1.40 kg

Free Manuals Download Website

<http://myh66.com>

<http://usermanuals.us>

<http://www.somanuals.com>

<http://www.4manuals.cc>

<http://www.manual-lib.com>

<http://www.404manual.com>

<http://www.luxmanual.com>

<http://aubethermostatmanual.com>

Golf course search by state

<http://golfingnear.com>

Email search by domain

<http://emailbydomain.com>

Auto manuals search

<http://auto.somanuals.com>

TV manuals search

<http://tv.somanuals.com>