

KENWOOD

DDX7035BT DDX7035BTM DDX5035BT DDX5035BTM

MONITOR WITH DVD RECEIVER
INSTRUCTION MANUAL

JVCKENWOOD Corporation

This instruction manual is used to describe models listed below. Model availability and features (functions) may differ depending on the country and sales area.

- Region 2 (DVD Region Code 2 area)
- Region 3 (DVD Region Code 3 area)
- Region 4 (DVD Region Code 4 area)



CONTENTS

BEFORE USE	2	BLUETOOTH	29
How to reset your unit.....	3	SETTINGS	37
INITIAL SETTINGS	4	Settings for using applications of the iPod/ iPhone/Android	37
BASICS	6	Sound adjustment	38
Component names and functions	6	Adjustment for video playback.....	40
Common operations.....	7	Changing display design.....	42
Common screen operations.....	8	Customizing the <TOP MENU> screen	43
Selecting the playback source.....	9	Customizing the system settings	43
DISCS	10	Setting menu items.....	45
USB	15	REMOTE CONTROLLER	48
iPod/iPhone	16	CONNECTION/INSTALLATION	53
APPS	19	REFERENCES	58
Pandora® (Only for DDX7035BT Region 4/ DDX5035BT Region 4)	20	Maintenance	58
TUNER	22	More information	58
OTHER EXTERNAL COMPONENTS	26	Error message list	62
Using external audio/video players—AV-IN	26	Troubleshooting.....	63
Using a rear view camera	26	Specifications.....	65
Using a smartphone—HDMI/MHL.....	27		
Watching a TV.....	27		
Using the external navigation unit	28		

BEFORE USE

⚠ **WARNINGS: (To prevent accidents and damage)**

- DO NOT install any unit or wire any cable in a location where;
 - it may obstruct the steering wheel and gearshift lever operations.
 - it may obstruct the operation of safety devices such as air bags.
 - it may obstruct visibility.
- DO NOT operate the unit while driving. If you need to operate the unit while driving, be sure to look around carefully.
- The driver must not watch the monitor while driving.

The marking of products using lasers



The label is attached to the chassis/case and says that the component uses laser beams that have been classified as Class 1. It means that the unit is utilizing laser beams that are of a weaker class. There is no danger of hazardous radiation outside the unit.

For Kazakhstan (DDX7035BTM/DDX5035BTM)



**Дата изготовления (месяц/год)
находится на этикетке устройства.**

How to read this manual:

- Illustrations of DDX7035BT Region 3 are mainly used for explanation. The displays and panels shown in this manual are examples used to provide clear explanations of the operations. For this reason, they may be different from the actual displays or panels.
- This manual mainly explains operations using the buttons on the monitor panel and touch panel. For operations using the remote controller (RC-DV340: supplied only for DDX7035BT Region 3/DDX7035BTM/DDX5035BT Region 3/DDX5035BTM), see page 48.
- < > indicates the various screens/menus/operations/settings that appear on the touch panel.
- [] indicates the buttons on the touch panel.
- **Indication language:** English indications are used for the purpose of explanation. You can select the indication language from the <Setup> menu. (Page 47)

BEFORE USE

For DDX7035BTM/DDX5035BTM



Declaration of Conformity with regard to the EMC Directive 2004/108/EC

Declaration of Conformity with regard to the R&TTE Directive 1999/5/EC

Declaration of Conformity with regard to the RoHS Directive 2011/65/EU

Manufacturer:

JVC KENWOOD Corporation
3-12 Moriya-cho, Kanagawa-ku, Yokohama-shi,
Kanagawa, 221-0022, Japan

EU Representative:

JVCKENWOOD NEDERLAND B.V.
Amsterdamseweg 37, 1422 AC UITHOORN, The
Netherlands

English

Hereby, JVC KENWOOD declares that this unit "DDX7035BTM/DDX5035BTM" is in compliance with the essential requirements and other relevant provisions of Directive 1999/5/EC.

Türkçe

Bu vesileyle JVC KENWOOD, "DDX7035BTM/DDX5035BTM" ünitesinin, 1999/5/EC Direktifinin başlıca gereksinimleri ve diğer ilgili hükümleri ile uyumlu olduğunu beyan eder.

For Turkey

Bu ürün 28300 sayılı Resmi Gazete'de yayımlanan Atık Elektrikli ve Elektronik Eşyaların Kontrolü Yönetmeliğe uygun olarak üretilmiştir.

Eski Elektrik ve Elektronik Ekipmanların İmha Edilmesi Hakkında Bilgi (ayrı atık toplama sistemlerini kullanan ülkeleri için uygulanabilir)



Sembollü (üzerinde çarpı işareti olan çöp kutusu) ürünler ev atıkları olarak atılamaz. Eski elektrik ve elektronik ekipmanlar, bu ürünleri ve ürün atıklarını geri dönüştürebilecek bir tesiste değerlendirilmelidir. Yaşadığınız bölgeye en yakın geri dönüşüm tesisinin yerini öğrenmek için yerel makamlara müracaat edin. Uygun geri dönüşüm ve atık imha yöntemi sağladığımız ve çevremiz üzerindeki zararlı etkileri önlerken kaynakların korunmasına da yardımcı olacaktır.

⚠ Cautions on the monitor:

- The monitor built into this unit has been produced with high precision, but it may have some ineffective dots. This is inevitable and is not considered defective.
- Do not expose the monitor to direct sunlight.
- Do not operate the touch panel using a ball-point pen or similar tool with a sharp tip. Touch the buttons on the touch panel with your finger directly (if you are wearing a glove, take it off).

- When the temperature is very cold or very hot...
 - Chemical changes occur inside, causing malfunction.
 - Pictures may not appear clearly or may move slowly. Pictures may not be synchronized with the sound or picture quality may decline in such environments.

Fors afety...

- Do not raise the volume level too much, as this will make driving dangerous by blocking outside sounds, and may cause hearing loss.
- Stop the car before performing any complicated operations.

Temperature inside the car...

If you have parked the car for a long time in hot or cold weather, wait until the temperature in the car becomes normal before operating the unit.

📄 How to reset your unit

DDX7035BT/DDX7035BTM

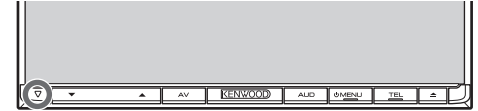

DDX5035BT/DDX5035BTM



If the unit fails to operate properly, press the Reset button. The unit returns to factory settings when the Reset button is pressed (except the registered Bluetooth devices).

INITIAL SETTINGS

Initials etup

When you power on the unit for the first time or reset the unit, the initial setting screen appears.

- You can also change the settings on the **<Setup>** screen. (Page 45)

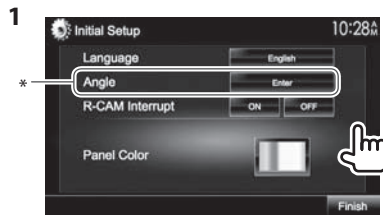

<Language> Select the text language used for on-screen information. (Page 47)

- Set **<GUI Language>** to display the operation buttons and menu items in the selected language (**[Local]**: initially selected) or English (**[English]**).

<Angle>* Adjust the panel angle. (Page 7)

<R-CAM Interrupt> Select **[ON]** when connecting the rear view camera. (Page 46)

<Panel Color> Select the color of the buttons on the monitor panel. (Page 42)

2 Finish the procedure.



The **<TOP MENU>** screen is displayed.

- * Onlyfor DDX7035BT/DDX7035BTM.

Setting the security function

You can set a security code to protect your receiver system against theft.

Registering the security code

1 Display the **<TOP MENU>** screen. On the source control screen:



2 Display the **<System>** setting screen.



3 Display the **<Security Code Set>** screen.

- Press **[▼]** repeatedly to change the page on the **<System>** menu screen.



- To clear the registered security code, perform steps 1 and 2, then press **[CLR]** in **<Security Code>**.

4 Enter a four-digit number (①), then confirm the entry (②).



- Press **[Clear]** to delete the last entry.
- Press **[Cancel]** to cancel the setting.

5 Repeat step 4 to confirm your security code.

Now, your security code is registered.

- When the unit is being reset or disconnected from the battery, you are required to enter the security code. Enter the correct security code, then press **[Enter]**.

INITIAL SETTINGS

❑ Activating the security function

You can activate the security function to protect your receiver system against theft.

- 1 Display the <System> setting screen.
On the <TOP MENU> screen:

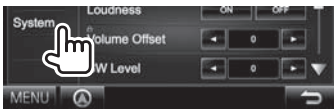

- Press [▼] repeatedly to change the page on the <System> menu screen.



The security indicator on the monitor panel flashes when the vehicle ignition is off.

To deactivate the security function: Select [OFF] for <SI>.

Clock settings

- 1 Display the <TOP MENU> screen.
On the source control screen:



- 2 Display the <Setup> screen.



- 3 Display the <Clock> screen.



- 4 Set the clock time.



- <NAV>* Synchronizes the clock time with the connected navigation unit.
- <Radio Data System> Synchronizes the clock time with FM Radio Data System.
- <OFF> Sets the clock manually. (See below.)

When selecting <OFF>:
Adjust the hour (①), then adjust the minute (②).

- Press [Reset] to set the minute to "00".



- 5 Finish the procedure.





* Appears only when the navigation unit is connected.

BASICS

Component names and functions

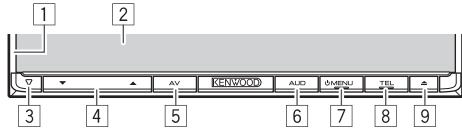
DDX7035BT/DDX7035BTM





- 1 Monitor panel*
- 2 Screen (touch panel)
- 3 Reset button/Power indicator/Security indicator
 - Resets the unit. (Page 3)
 - Lights up while the unit is turned on.
 - Flashes when the security function is activated. (Page 5)
- 4 Volume ▼/▲ button
 - Adjusts the audio volume. (Page 7)
- 5 AV/AV OUT button
 - Displays the current source screen. (Press)
 - The function of the button when held varies depending on the <AV Key Long Press> setting. (Page 47)
- 6 AUD/R-CAM button
 - Displays the <Equalizer> screen. (Press) (Page 38)
 - The function of the button when held varies depending on the <AUD Key Long Press> setting. (Page 47)
- 7  MENU button
 - Displays the <TOP MENU> screen. (Press) (Page 8)
 - Turns off the power. (Hold) (Page 7)
 - Turns on the power. (Press) (Page 7)

- 8 TEL/VOICE button
 - Displays the phone control screen. (Press) (Page 33)
 - Activates voice dialing. (Hold) (Page 34)
- 9  (Eject) button
 - Ejects the disc. (Tilts the monitor panel fully.)
 - Opens/closes the monitor panel.

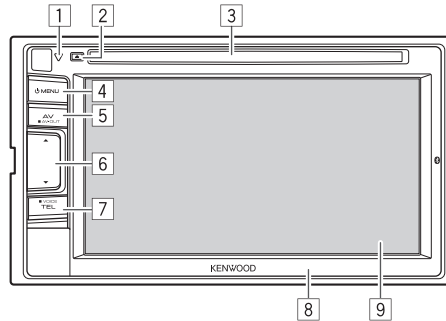
DDX5035BT/DDX5035BTM



- 1 Reset button/Power indicator/Security indicator
 - Resets the unit. (Page 3)
 - Lights up while the unit is turned on.
 - Flashes when the security function is activated. (Page 5)
- 2  (Eject) button
 - Ejects the disc.
- 3 Loading slot

- 4  MENU button
 - Displays the <TOP MENU> screen. (Press) (Page 8)
 - Turns off the power. (Hold) (Page 7)
 - Turns on the power. (Press) (Page 7)
- 5 AV/AV OUT button
 - Displays the current source screen. (Press)
 - The function of the button when held varies depending on the <AV Key Long Press> setting. (Page 47)
- 6 Volume ▼/▲ button
 - Adjusts the audio volume. (Page 7)
- 7 TEL/VOICE button
 - Displays the phone control screen. (Press) (Page 33)
 - The function of the button when held varies depending on the <TEL Key Long Press> setting. (Page 47)
- 8 Monitor panel*
- 9 Screen (touch panel)

* You can change the color of the buttons on the monitor panel. (Page 42)

 **Caution on the volume setting:**
Digital devices produce very little noise compared with other sources. Lower the volume before playing these digital sources to avoid damaging the speakers by sudden increase of the output level.

BASICS

Common operations

Turning on the power

DDX7035BT
DDX7035BTM



DDX5035BT
DDX5035BTM



Turning off the power

DDX7035BT
DDX7035BTM



(Hold)

DDX5035BT
DDX5035BTM

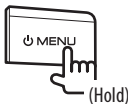

(Hold)

Adjusting the volume

To adjust the volume (00 to 35)

DDX7035BT
DDX7035BTM

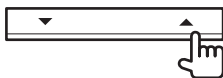

Press ▲ to increase, and press ▼ to decrease.

- Holding the button increases/decreases the volume continuously.

DDX5035BT
DDX5035BTM

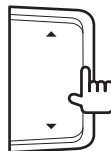

Press ▲ to increase, and press ▼ to decrease.

- Holding the button increases/decreases the volume continuously.

Adjusting the panel angle (only for DDX7035BT/DDX7035BTM)

- 1 Display the <Angle Adjust> screen.
On the <TOP MENU> screen:
 - Press [▼] repeatedly to change the page on the <Display> menu screen.

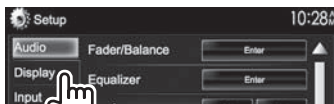

- 2 Select an angle (0 – 6).

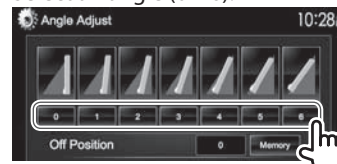

- To set the current position as the power off position, select [Memory].

Putting the unit in standby

- 1 Display all <TOP MENU> items.
On the <TOP MENU> screen:



- 2

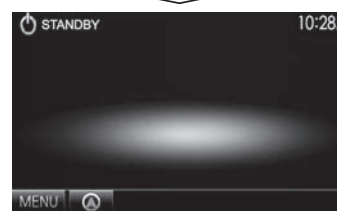

BASICS

Turning off the screen

DDX7035BT
DDX7035BTM*1

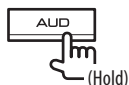

DDX5035BT
DDX5035BTM*2



To turn on the screen: Press MENU on the monitor panel, or touch the display.

*1 This operation works only when <AUD Key Long Press> is set to [V-OFF]. (Page 47)

*2 This operation works only when <TEL Key Long Press> is set to [V-OFF]. (Page 47)

Common screen operations

Common screen descriptions

You can display other screens any time to change the source, show the information, or change the settings, etc.

Source control screen

Performs source playback operations.

- The operation buttons vary depending on the selected source.



Common operation buttons:

- Displays other operation buttons.
 - Disabled when there are no other buttons.
- Switches between the normal source control screen and easy control screen. (See below.)
- Displays the <TOP MENU> screen. (See the right column.)
 - Pressing MENU on the monitor panel also displays the <TOP MENU> screen.
- Displays the screen of the connected navigation unit.* (Page 28)

Easy control screen

Pressing switches between the normal source control screen and easy control screen. The easy control screen allows you to control the source easily with simple buttons.

- The displayed buttons vary depending on the selected source.



<TOP MENU> screen

Displays the source control screen and settings screen.



Common operating buttons:

- Changes the playback source. (Page 9)
 - Press [ALL SRC] to display all <TOP MENU> items. (Page 9)
 - You can arrange the items to display on the <TOP MENU> screen. (Page 43)
- Displays the phone control screen. (Page 33)
- Displays the <Setup> screen. (See below.)

<Setup> screen

Changes the detailed settings. (Page 45)



Common operating buttons:

- Selects the menu category.
- Displays the <TOP MENU> screen.
- Changes the page.
- Returns to the previous screen.

* Appears only when a navigation unit is connected.

BASICS

Touch screen operations

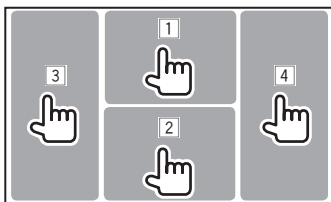

- 1 Displays the video control menu while playing a video.



- 2 Displays the source control screen while playing a video.



- The operation buttons disappear when the screen is touched or when no operation is done for about 5 seconds.

- 3 Goes to the previous chapter/track.*
4 Goes to the next chapter/track.*

* Not available for video from an external component.

Selecting the playback source

On the <TOP MENU> screen:

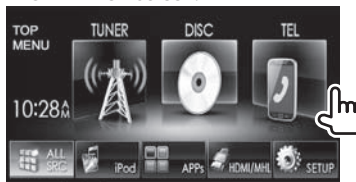

- You can change the items (other than [SETUP]) to display on the <TOP MENU> screen. (Page 43)

- [NAV]*¹ Displays the navigation screen when a navigation unit is connected. (Page 28)
- [DISC] Plays a disc. (Page 10)
- [TUNER] Switches to the radio broadcast. (Page 22)
- [iPod] Plays an iPod/iPhone. (Page 16)
- [USB] Plays files on a USB device. (Page 15)
- [HDMI/MHL] Plays a device connected to the HDMI/MHL input terminal. (Page 27)
- [PANDORA]*² Switches to the Pandora broadcast. (Page 20)
- [Bluetooth] Plays a Bluetooth audio player. (Page 35)
- [APPS] Switches to the screen of App from the connected iPod touch/iPhone. (Page 19)
- [TEL] Displays the phone control screen. (Page 33)

[AV-IN1][AV-IN2]

Switches to an external component connected to the AV-IN1 or iPod/AV-IN2 input terminal. (Page 26)

- *¹ When no navigation unit is connected, "No Navigation" appears.
*² Only for DDX7035BT Region 4/DDX5035BT Region 4.

To display all sources and items on the <TOP MENU> screen

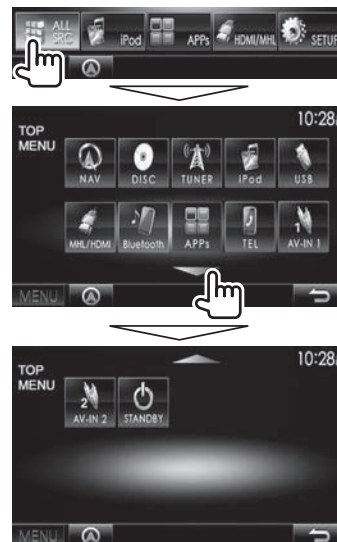

- You can change the page to display more items by pressing [▲]/[▼].

DISCS

Playing a disc

- If a disc does not have a disc menu, all tracks on it will be played repeatedly until you change the source or eject the disc.
- For playable disc types/file types, see page 59.

Inserting a disc

Insert a disc with the label side facing up.

DDX7035BT/DDX7035BTM

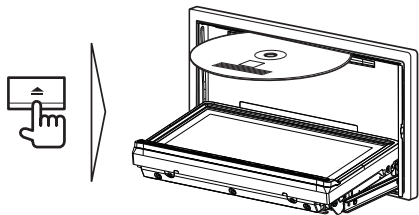

DDX5035BT/DDX5035BTM

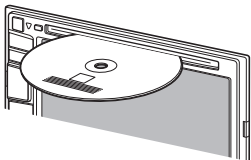

The source changes to "DISC" and playback starts.

- The IN indicator lights up while a disc is inserted.

- If "⊘" appears on the screen, the unit cannot accept the operation you have tried to do.
 - In some cases, without showing "⊘," operations will not be accepted.
- When playing back a multi-channel encoded disc, the multi-channel signals are downmixed to stereo.

Ejecting a disc

**DDX7035BT
DDX7035BTM**



- When removing a disc, pull it horizontally.
- You can eject a disc when playing another AV source.
- If the ejected disc is not removed within 60 seconds, the disc is automatically inserted again into the loading slot to protect it from dust.

**DDX5035BT
DDX5035BTM**



Closing the monitor panel (only for DDX7035BT/DDX7035BTM)

After removing the disc, press  on the monitor panel. The monitor panel closes.

Playback operations

When the operation buttons are not displayed on the screen, touch the area shown on the illustration.

- To change settings for video playback, see page 40.

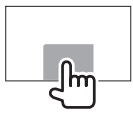

Indications and buttons on the source control screen

For DVD/DVD-VR/VCD/DivX/MPEG1/MPEG2



Playback information

- 1 Media type
- 2 Current playback item information
 - DVD Video: Title no./Chapter no.
 - DVD-VR: Program no. (or Playlist no.)/Chapter no.*
 - DivX/MPEG1/MPEG2: Folder no./Track no.
 - VCD: Scene no. (with PBC) or Track no. (without PBC)
- 3 Playing time
- 4 Playback mode (Page 13)
- 5 File type (for DivX/MPEG1/MPEG2)
- 6 IN indicator

* To display the Original Program/Playlist screen, see page 11.

DISCS

Operation buttons

- [] Displays the easy control screen. (Page 8)
- []*¹ Displays the folder/track list. (Page 12)
- [] • Reverse/forward search during playback.*²
- [] • Selects a chapter/track. (Press)
• Reverse/forward search.*² (Hold)
- [] Starts/pauses playback.
- [] Stops playback.
- [] Displays other operation buttons.
• Disabled when there are no other buttons.
- [**MODE**] Changes the settings for disc playback on the <DISC Mode> screen. (Page 14)
- [] []*³ Selects playback mode. (Page 13)
- [**Playlist**]*⁴ Displays an Original Program/Playlist screen.
- []*⁵ Plays in frame-by-frame.
- [] []*¹ Selects a folder.
- [**PBC**]*⁶ Activates or deactivates the VCD PBC (Playback Control) function.
- [**MENU**] Displays the <TOP MENU> screen.

- *¹ Does not appear for DVD/DVD-VR/VCD.
- *² Search speed varies depending on the type of disc or file.
- *³ Does not appear for DVD/DVD-VR.
- *⁴ Appears only for DVD-VR.
- *⁵ Appears only for DVD/DVD-VR.
- *⁶ Appears only for VCD.

For C D/MP3/WMA/AAC



Playback information

- 1 Media type
- 2 Track/file information
 - Pressing [**<**] scrolls the text if not all of the text is shown.
- 3 Current playback item information
 - MP3/WMA/AAC: Folder no./Track no.
 - CD: Track no.
- 4 Playback status
- 5 Playing time
- 6 Playback mode (Page 13)
- 7 File type
- 8 IN indicator

Operation buttons

- [] Displays the easy control screen. (Page 8)
- []*¹ Displays the folder/track list. (Page 12)
- [] Selects a track.
- [] Reverse/forward search.*²
- [] Starts/pauses playback.
- [] Displays other operation buttons.
• Disabled when there are no other buttons.
- [**MODE**] Changes the settings for disc playback on the <DISC Mode> screen. (Page 14)
- [] []*¹ Selects a folder.
- [] [] Selects playback mode. (Page 13)
- [] Stops playback.
- [**MENU**] Displays the <TOP MENU> screen.

*¹ Does not appear for CDs.

*² Search speed varies depending on the type of disc or file.

DISCS

❑ Selecting a folder/track on the list

1



2 Select the folder (①), then the item in the selected folder (②).

- Repeat the procedure until you select the desired track.

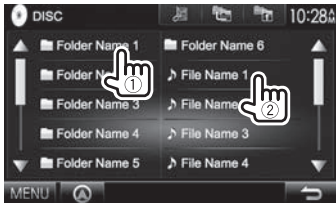

- You can change the page to display more items by pressing [▲]/[▼].
- Press [⏪] to open the folder containing the current track.
- Press [⏩] to return to the root folder.
- Press [⏪] to return to the upper layer.

❑ Video menu operations

You can display the video menu screen during video playback.

- Available items on the screen differ depending on the types of the loaded disc and playback files.
- The operation buttons disappear when the screen is touched or when no operation is done for about 5 seconds.

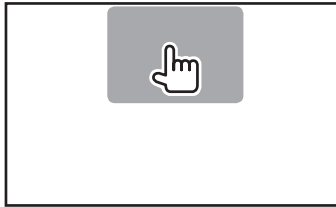

[ZOOM]*

Displays the picture size selecting screen. (Page 41)

[Aspect]

Selects the aspect ratio. (Page 41)

[PictureAdjust]

Displays the picture adjustment screen. (Page 40)

[Audio]*

Selects the audio type (or channel for DVD-VR).

[Subtitle]*

Selects the subtitle type.

[Angle]*

Selects the view angle.

[MENU]*

Displays the disc menu.

[T MENU]*

Displays the menu/scene

[CUR]*

selecting screen.

- [▲] [▼] [◀] [▶]: Selects an item.
- **[Enter]**: Confirms the selection.
- **[Return]**: Returns to the previous screen.

[Highlight]*

Switches to the direct disc menu mode. Touch the target item to select.

- To restore the screen, press AV on the monitor panel.

* May not appear depending on the media/file etc.

DISCS

For VCD

1



2



- [ZOOM]** Displays the picture size selecting screen. (Page 41)
- [Aspect]** Selects the aspect ratio. (Page 41)
- [PictureAdjust]** Displays the picture adjustment screen. (Page 40)
- [Audio]** Selects the audio channel (ST: stereo, LL: left, RR: right).
- [Return]** Displays the previous screen or menu.
- [Direct]** Displays/hides the direct selecting buttons. (See the right column.)

- To select a track directly, press **[Direct]** to display the direct selecting buttons, then...



- When you enter a wrong number, press **[CLR]** to delete the last entry.

Selecting playback mode



- [Repeat]** Selects Repeat playback mode.
 - [Random]** Selects Random playback mode.
- For DVD/DVD-VR: Repeat play is available. For VCD (without PBC)/CD/DivX/MPEG1/MPEG2/MP3/WMA/AAC: Repeat and Random play are available.
 - You cannot activate the repeat mode and the random mode at the same time.
 - Each time you press the button, the playback mode changes. (The corresponding indicator lights up.)
 - Available items differ depending on the types of loaded disc and playback file.
- | | |
|---------------|---|
| C-REP | Repeats current chapter. |
| T-REP | Repeats current title/program. |
| REP | Repeats current track. |
| FO-REP | Repeats all tracks of the current folder. |
| FO-RDM | Randomly plays all tracks of the current folder, then tracks of the next folders. |
| RDM | Randomly plays all tracks. |

To cancel Repeat/Random playback: Press the button repeatedly until the indicator disappears.

DISCS

Settings for disc playback



- The items available on the <DISC Mode> screen are different depending on the discs/files played back.

Setting items

<Menu Language>*	Select the initial disc menu language. (Initial: English) (Page 61)
<Audio Language>*	Select the initial audio language. (Initial: Original) (Page 61)
<Subtitle Language>*	Select the initial subtitle language or turn subtitles off (Off). (Initial: English) (Page 61)
<Dynamic Range Control>*	You can change the dynamic range while playing Dolby Digital software. <ul style="list-style-type: none"> Wide: Select this to enjoy a powerful sound at a low volume level with its full dynamic range. Normal: Select this to reduce the dynamic range a little. Dialog (initial): Select this to reproduce movie dialog more clearly.
<Angle Mark>	Select whether to display the angle mark. <ul style="list-style-type: none"> ON (initial): Select this to display the angle mark. OFF: Select this to hide the angle mark.

<Screen Ratio>*	Select the monitor type to watch a wide screen picture on the external monitor. 16:9 (Initial) 4:3 LB 4:3 PS 
<Parental Level>*	Set the parental level. (See below.)
<CD Read>	Select the files to play back a disc containing music files. You cannot change the setting when a disc is inserted. <ul style="list-style-type: none"> 1 (initial): Automatically distinguishes between audio file discs and music CDs. 2: Forces to play as a music CD. No sound can be heard if an audio file disc is played.

* You can change these settings only while playback is stopped.

Setting the parental lock

The parental lock cannot be set during DVD playback.

- Display the <Parental Pass> screen. On the <DISC Mode> screen:
 - Press [▼] repeatedly to change the page on the <DISC Mode> screen.



- Enter the 4-digit parental pass code (①), and press [Enter] (②).



- To clear the entry, press [Clear].
- To cancel setting the code, press [Cancel].

- Adjust the parental level (**OFF**, **Level 1** to **Level 8**).



To deactivate the parental lock: Select [OFF] for <Parental Level>.

USB

Connecting a USB device

You can connect a USB mass storage class device such as a USB memory, Digital Audio Player etc. to the unit.

- For details about connecting USB devices, see page 56.
- You cannot connect a computer or portable HDD to the USB input terminal.
- For playable file types and notes on using USB devices, see page 60.

When a USB device is connected...

The source changes to “USB” and playback starts.

- All tracks in the USB device will be played repeatedly until you change the source.

To disconnect the USB device safely:

- Press [▲], then disconnect the USB device after “No Device” appears.

Playback operations

When the operation buttons are not displayed on the screen, touch the area shown on the illustration.

- To change settings for video playback, see page 40.

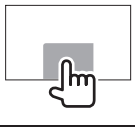

Indications and buttons on the source control screen

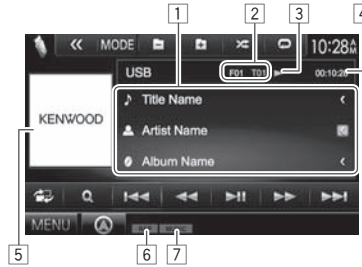

Playback information

- 1 Track/file information (for MP3/WMA/WAV/AAC/FLAC)
 - Pressing [◀] scrolls the text if not all of the text is shown.
- 2 Current playback item information
 - MPEG1/MPEG2/H.264/WMV: Folder no., Track no., etc.
 - MP3/WMA/WAV/AAC/FLAC: Folder no., Track no., etc.
 - JPEG/BMP/PNG: Folder no./File no.
- 3 Playback status
- 4 Playing time
- 5 Jacket picture (Shown while playing if the file has tag data that includes the jacket picture)
- 6 Playback mode (See the right column.)
- 7 File type

Operation buttons

- [🏠] Displays the easy control screen. (Page 8)
- [Q] Displays the list selection screen. (Page 16)
- [◀▶] Selects a track.

- [◀▶] Reverse/forward search.*1
- [⏮] Starts/pauses playback.
- [⏪] Displays other operation buttons.
 - Disabled when there are no other buttons.
- [MODE] Changes the picture display time setting on the <USB Mode> screen. (Page 16)
- [📁] Selects a folder.
- [🔄] Selects repeat playback mode.*2*3
 - **REP**: Repeats the current track/file.
 - **FO-REP**: Repeats all tracks/files in the current folder or specified category.
- [🔀] Selects random playback mode.*2*3
 - **RDM**:
 - When selecting the track/file from the folder, randomly plays all tracks/files of the current folder, then the tracks/files of the next folder.
 - When selecting the track/file from the category, randomly plays all tracks/files of the specified category.
- [▲] Disconnects the USB device safely.
- [MENU] Displays the <TOP MENU> screen.

*1 Search speed varies depending on the file type.

*2 To cancel random or repeat mode, press the button repeatedly until the indicator disappears.

*3 You cannot activate the repeat mode and the random mode at the same time.

USB

❑ Setting <Picture Display Time>

Set the interval between slides during slide-shows of the picture files.

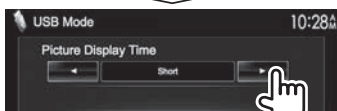

❑ Selecting a track in a list



2 Select the list.

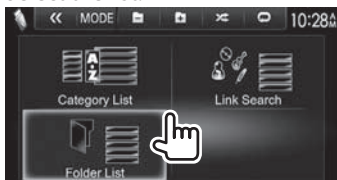

3 Select the track.

- You can change the page to display more items by pressing [▲]/[▼].
- Press [⏪] to return to the root folder.
- Press [⏩] to return to the upper layer.
- Press [⏴] to open the folder containing the current track.
- If you want to play all tracks in the folder, press [▶] on the right of the desired folder.

- On the <Category List>/<Folder List>: You can switch the file type to list: Press [🎵] to list audio files, [📺] to list video files, or [🖼️] to list still picture files.
- On the <Category List>/<Link Search>: To list the items in alphabetical order, press [A-Z], then select the first character.

From <Category List>:

Select the category (①), then the item in the selected category (②).

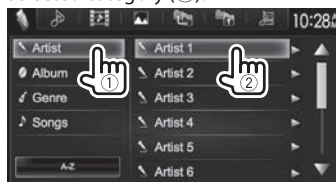

From <Link Search>:

Select the tag type to display the list of contents containing the same tag as the track/file currently played back (①), then the item (②).

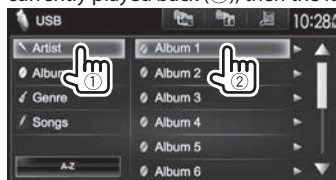

From <Folder List>:

Select the folder (①), then the item in the selected folder (②).

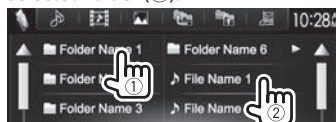

iPod/iPhone

Preparation

❑ Connecting iPod/iPhone

- For details about connecting iPod/iPhone, see page 56.
- For playable iPod/iPhone types, see page 61.

Connect your iPod/iPhone according to your purpose or the type of the iPod/iPhone.

Wired connection

• To listen to music:

- For iPod/iPhone except for iPhone 5/iPod touch (5th Generation)/iPod nano (7th Generation), use USB Audio cable for iPod/iPhone—KCA-iP102 (optional accessory)
- For iPhone 5/iPod touch (5th Generation)/iPod nano (7th Generation), use USB 2.0 cable (accessory of the iPod/iPhone)

• To watch video and listen to music:

- For iPod/iPhone except for iPhone 5/iPod touch (5th Generation)/iPod nano (7th Generation), use USB Audio and Video cable for iPod/iPhone—KCA-iP202 (optional accessory)
- For iPhone 5/iPod touch (5th Generation)/iPod nano (7th Generation), use the HDMI cable KCA-HD100 (optional accessory) and USB 2.0 cable (accessory of the iPod/iPhone) through Lightning-Digital AV adapter (accessory of the iPod/iPhone)

iPod/iPhone

Bluetooth connection

Pair the iPod/iPhone through Bluetooth. (Page 29)

- For iPhone 5/iPod touch (5th Generation)/iPod nano (7th Generation): To watch the video, connect your iPod/iPhone to HDMI/MHL input terminal using KCA-HD100 (optional accessory). (Page 56)
- For iPod/iPhone except for iPhone 5/iPod touch (5th Generation)/iPod nano (7th Generation): You cannot watch the video with Bluetooth connection.

❑ Selecting the iPod/iPhone device to play and connection method

When connecting the iPod/iPhone device for first time, the setup screen (for connection, etc.) appears. Follow the procedure on the setup screen to configure the settings.

1 Display the <iPod Settings> screen.

On the <TOP MENU> screen:

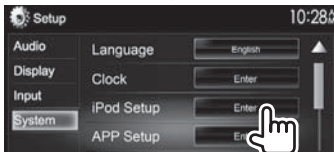

- 2 If [Enter] for <iPod Setup> cannot be selected, put the unit in standby. (Page 7)
- 3 Select the connection method (①), then press [Next] (②).



• If you do not need to change the setting, press [OK] to exit from the setup screen.

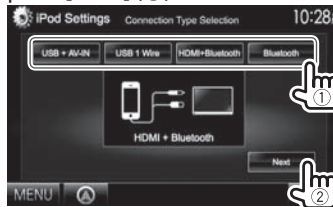

<USB + AV-IN>

Select this when the iPod/iPhone is connected using KCA-iP202 (optional accessory).

<USB 1 Wire>

Select this when the iPod/iPhone is connected using KCA-iP102 or USB 2.0 cable (accessory of the iPod/iPhone).

<HDMI + Bluetooth>

Select this when the iPod/iPhone is connected using HDMI cable KCA-HD100 (optional accessory) and USB 2.0 cable (accessory of the iPod/iPhone) through Lightning-Digital AV adapter (accessory of the iPod/iPhone).

<Bluetooth>

Select this when the iPod/iPhone is connected via Bluetooth.

- When selecting <USB + AV-IN> or <USB 1 Wire>, go to step 5.
- 4 When selecting <HDMI + Bluetooth> or <Bluetooth> as the connection method, the device selection screen appears. Search for the available iPod/iPhone devices (①), then select the target device from the list (②).



- You can change the page to display more items by pressing [▲]/[▼].
- If the device is already listed, skip the step ①.
- To stop searching, press [Cancel].

5 Confirm the settings.



iPod/iPhone

❑ Selecting preference settings for iPod/iPhone playback

When the source is "iPod"...



<Audiobooks> Select the speed of audio books.

<Wide Screen>*

- **[ON]:** Select this to display the video compatible with wide-screen display in wide-screen.
- **[OFF]:** Select this to deactivate.

* You cannot change the setting when iPod/iPhone is connected.

Playback operations

When the operation buttons are not displayed on the screen, touch the area shown on the illustration.

- To change settings for video playback, see page 40.

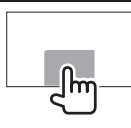

❑ Indications and buttons on the source control screen



Playback information

- 1 Song/video information
 - Pressing [**<**] scrolls the text if not all of the text is shown.
- 2 Track no./Total track number
- 3 Playback status
- 4 Playing time
- 5 Artwork (Shown if the song contains artwork)

Operation buttons

- [**Easy Control**] Displays the easy control screen. (Page 8)
 - [**Q**] Displays the audio/video file list. (Page 19)
 - [**Reverse/Forward**] Selects an audio/video file.
 - [**Reverse/Forward**] Reverse/forward search.
 - [**Play/Pause**] Starts/pauses playback.
 - [**Other Operations**] Displays other operation buttons.
 - Disabled when there are no other buttons.
 - [**MODE**] Changes the settings for iPod/iPhone playback on the <iPod Mode> screen. (See the far left column.)
 - [**Repeat**] Selects repeat playback mode.
 - **Repeat One**: Functions the same as "Repeat One."
 - **Repeat All**: Functions the same as "Repeat All."
 - [**Random**] Selects random playback mode.*
 - **Shuffle Songs**: Functions the same as "Shuffle Songs."
 - **Shuffle Albums**: Functions the same as "Shuffle Albums."
 - [**MENU**] Displays the <TOP MENU> screen.
- * To cancel random mode, press the button repeatedly until the indicator disappears.

iPod/iPhone

❑ Selecting an audio/video file from the menu

1

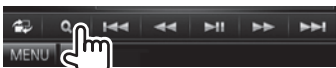

2 Select the menu (1): audio or (2) video (3), a category (2), then a desired item (3).

- Select the item in the selected layer until the desired file starts playing.
- You can change the page to display more items by pressing [▲]/[▼].
- Press [All ▶] to play all songs/videos.
- Press [⏪] to return to the top layer.
- Press [⏩] to return to the upper layer.

Audio menu:



- Press [A-Z] to sort the list in alphabetical order.

Video menu:



- Available categories differ depending on the type of your iPod/iPhone.

APPS

You can use an App of the connected iPod touch/iPhone/Android on this unit.

Preparation

- 1 Connect the iPod touch/iPhone/Android.
 - For wired connection, see page 56 for iPod touch/iPhone or page 57 for Android.
 - To view the video, connect the device by using KCA-iP202 or KCA-HD100 (optional accessory).
 - For Bluetooth connection, see page 31.
- 2 Select the iPod touch/iPhone/Android device to use and connection method on the <APP Setup> screen. (Page 37)

When connecting the device for first time, the setup screen (for connection, etc.) appears. Follow the procedure on the setup screen to configure the settings.

Using an App

❑ Playback operations

- 1 Start the App on your iPod touch/iPhone/Android.
- 2 Select "APPS" as the source. (Page 9)

❑ Operation buttons on the source control screen



- [⏪] [⏩] Selects an audio/video file.
- [⏪] [⏩] Reverse/forward search.
- [⏸] Starts/pauses playback.
- [MENU] Displays the <TOP MENU> screen.

For some applications such as navigation applications, the operating buttons and information are not shown. You can perform the operations on the touch panel, such as scrolling the map.

You can also play back the audio/video using iPod/iPhone instead of the unit.

- When you are using Garmin StreetPilot® Onboard, the screen appears. For Garmin StreetPilot® Onboard for iPhone, visit the Garmin web site: www.garmin.com

Garmin App:



- The current position of your vehicle appears on the map. When the vehicle moves, the map scrolls.
- The screens of the iPhone and unit are not the same.

❑ Switching to the App screen while listening to another source

Press and hold AV on the monitor panel.

- This operation works only when <AV Key Long Press> is set to [APPS]. (Page 47)

You can stream Pandora from iPod touch/iPhone, Android or BlackBerry devices.

- Install the latest version of the Pandora application on your iPod touch/iPhone/Android/BlackBerry.

Preparation

Connect the device, then start the Pandora application.

For Android/BlackBerry

- 1 Pair the Android/BlackBerry device through Bluetooth. (Page 29)
- 2 Select the device to use and connection method on the <APP Setup> screen. (Page 37)
- 3 Select "PANDORA" as the source. On the <TOP MENU> screen:



The Pandora application is started.

For iPod touch/iPhone

- 1 Connect the iPod touch/iPhone. (Page 16)
- 2 Select the iPod touch/iPhone device to use and connection method on the <APP Setup> screen. (Page 37)
- 3 Start the Pandora application on the connected iPod touch/iPhone. The "PANDORA" source control screen is displayed.
 - You can also display the "PANDORA" source control screen by connecting the iPod touch/iPhone using KCA-IP202 or KCA-HD100 after starting the Pandora application.

Playback operations

You can operate Pandora using the remote controller. Only playing, pausing, and skipping are available.

Indications and buttons on the source control screen

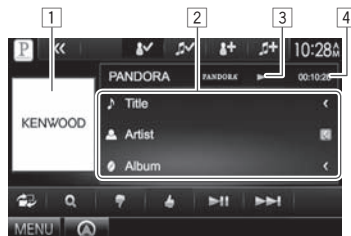

Playback information

- 1 Picture data
- 2 Track information
 - Pressing [<] scrolls the text if not all of the text is shown.
- 3 Playback status
- 4 Playing time

Operation buttons

- [🎛️] Displays the easy control screen. (Page 8)
- [🔍] Displays the list selecting screen. (Page 21)
- [🔻] Thumbs down to the current track and skips to the next track.
- [👍] Registers the current track as a favorite.
- [⏸️] Starts/pauses playback.
- [⏭️] Skips the current track.
 - Not available when the Pandora skip reaches its limit.
- [⏮️] Displays other operation buttons.
 - Disabled when there are no other buttons.
- [👤] Bookmarks the artist.
- [🎵] Bookmarks the current track.
- [👤+] Adds the current artist to the Station List.
- [🎵+] Adds the current track to the Station List.

Pandora®

❑ Adding a station from the Genre List to the Station List

The screen shows the genres sent by the connected device. Select a genre and station to add to the Station List.

1 Display the list selecting screen.

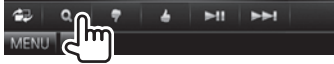

2

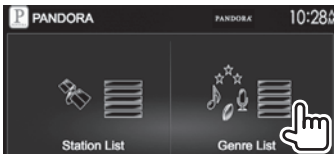

3 Select a genre (①), then a station (②).

- You can change the page to display more items by pressing [▲]/[▼].



The selected station is added to the Station List.

❑ Selecting a station from the list

1 Display the list selecting screen. (See above.)

2





3 Select a station from the list.



[Shuffle] Plays all the songs in the registered stations randomly.

[By Date] Sorts the list in reverse chronological order.

[By Name] Sorts the list in alphabetical order.

- The  indicator appears on the left of the item when Shuffle is activated. (All songs on the registered stations are played randomly.)
- The  indicator appears on the right of the item when the station is shared.

Requirements for Pandora®

iPhone or iPod touch

- Install the latest version of the Pandora application on your iPhone or iPod touch. (Search for “Pandora” in the Apple iTunes App Store to find and install the most current version.)
- Connect iPod touch/iPhone to this unit with cable or via Bluetooth.
 - When connecting with cable: Use KCA-iP202, KCA-HD100, KCA-iP102 (optional accessory) or USB 2.0 cable (accessory of the iPod/iPhone).
 - When connecting via Bluetooth, following profiles must be supported.
 - SPP (Serial Port Profile)
 - A2DP (Advanced Audio Distribution Profile)

Android™

- Visit Google play and search for Pandora to install.
- Bluetooth must be built in and the following profiles must be supported.
 - SPP (Serial Port Profile)
 - A2DP (Advanced Audio Distribution Profile)

BlackBerry®

- Visit www.pandora.com from the built in browser to download the Pandora application.
- Bluetooth must be built in and the following profiles must be supported.
 - SPP (Serial Port Profile)
 - A2DP (Advanced Audio Distribution Profile)

NOTE

- Ensure you are logged in to your smartphone application. If you do not have a Pandora account, you can create one for free from your smartphone or at www.pandora.com.
- Pandora is available only in the U.S./Australia/New Zealand.
- Because Pandora is a third-party service, the specifications are subject to change without prior notice. Accordingly, compatibility may be impaired or some or all of the services may become unavailable.
- Some functions of Pandora cannot be operated from this unit.
- For issues using the application, contact Pandora at pandora-support@pandora.com
- Establish an Internet connection using LTE, 3G, EDGE, or WiFi.

TUNER

Listening to the radio

Indications and buttons on the source control screen



Tuner reception information

- 1 Band
- 2 Preset no.
- 3 The station frequency currently tuned in
- 4 ST/MONO indicator
 - The ST indicator lights up when receiving an FM stereo broadcast with sufficient signal strength.
- 5 AF indicator
- 6 Seek mode
- 7 LO.S indicator (Page 23)
- 8 RDS indicator
- 9 EON indicator: Lights up when a Radio Data System station is sending EON signals.
- 10 Text information
 - Pressing [**<**] scrolls the text if not all of the text is shown.
 - Pressing [**Radio Text**] switches the information between Radio Text, Radio Text Plus, and PTY code.
- 11 Standby reception indicators

Operation buttons

- [P1] – [P6]
 - Selects a stored station. (Press)
 - Stores the current station. (Hold)
- [MODE] Changes the settings for tuner reception on the **<Tuner Mode>** screen. (Page 23)
- [TI] Activates/deactivates TI standby reception mode. (Page 24)
- [AME] Presets stations automatically. (Page 23)
- [MONO]* Activates/deactivates monaural mode for better FM reception. (Stereo effect will be lost.)
 - The MONO indicator lights up while monaural mode is activated.
- Changes the display information. (See the right column.)
- Displays the easy control screen. (Page 8)
- [PTY]* Enters PTY search mode. (Page 24)
- [AM] Selects the AM band.
- [FM] Selects the FM band.
→ FM1 → FM2 → FM3
- [SEEK] Changes the seek mode.
 - **AUTO1**: Auto Search
 - **AUTO2**: Tunes in the stations in the memory one after another.
 - **MANU**: Manual Search
- [<<<] [>>>] Searches for a station.
 - The search method differs according to the selected seek mode. (See above.)
- [MENU] Displays the **<TOP MENU>** screen.

* Appears only when FM is selected as the source.

Changing the display information

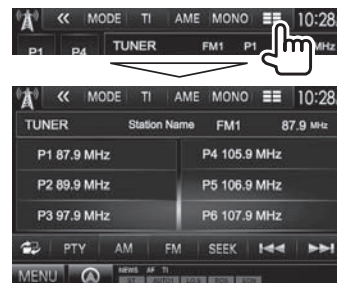

The preset list and the station name for FM Radio Data System (when PS signal is coming in) are displayed.

- Pressing again displays the text information for the station currently being received.

TUNER

❑ Setting the antenna control

You can store the antenna automatically when the source is changed from the tuner to another source.

- The antenna is extended regardless of the setting when the source is the tuner.



[ON] Select this to keep the antenna extended even when the source is not the tuner.

[OFF] Select this to store the antenna automatically.

❑ Tuning in FM stations only with strong signals—Local Seek



[ON] Select this to tune in only to stations with sufficient signal strength. The LO.S indicator lights up.

[OFF] Deactivate the function.

Presetting stations

❑ Storing stations in the memory

You can preset 6 stations for each band.

Automatic presetting—AME(A toMem ory)



Local stations with the strongest signals are found and stored automatically.

Manual resetting

- 1 Tune in to a station you want to preset. (Page 22)
- 2 Select a preset number.



The station selected in step 1 is stored.

TUNER

❑ Selecting a preset station



FM Radio Data System features

❑ Searching for FM Radio Data System programs—PTY Search

You can search for your favorite programs being broadcast by selecting the PTY code.

1



2 Select a PTY code.

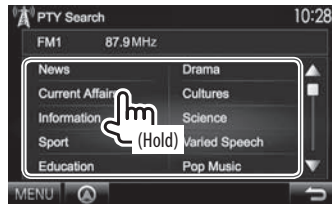

- You can change the page to display more items by pressing [▲]/[▼].

PTY Search starts.

If there is a station broadcasting a program of the same PTY code as you have selected, that station is tuned in.

- Only English/Spanish/French/German/Dutch/Portuguese are available for the text language here. If another language has been selected in <Language> (Page 47), the text language is set to English.

❑ Activating/deactivating TI/News Standby Reception

TI Standby Reception



The unit is in standby to switch to Traffic Information (TI) if available. (The TI indicator lights up in white.)

- If the TI indicator is lit in orange, tune into another station providing Radio Data System signals.

To deactivate TI Standby Reception: Press [TI]. (The TI indicator goes off.)

- The volume adjustment for Traffic Information is automatically memorized. The next time the unit switches to Traffic Information, the volume is set to the previous level.

TUNER

News Standby Reception

1



2



[00min] - Activate News Standby Reception (the NEWS indicator lights up).

[90min] Select the period of time to disable interruption.

[OFF] Deactivate the function.

- The volume adjustment while receiving News is automatically memorized. The next time the unit switches to News, the volume is set to the previous level.

Tracing the same program—Network-Tracking Reception

When driving in an area where FM reception is not sufficient enough, this unit automatically tunes in to another FM Radio Data System station of the same network, possibly broadcasting the same program with stronger signals.

- When shipped from the factory, Network-Tracking Reception is deactivated.

To change the Network-Tracking Reception setting

1



2

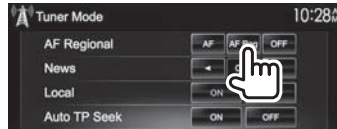

[AF] Switch to another station. The program may differ from the one currently received (the AF indicator lights up).

[AF Reg] Switch to another station broadcasting the same program (the AF indicator lights up).

[OFF] Deactivate the function.

- The RDS indicator lights up when the Network-Tracking Reception is activated and an FM Radio Data System station is found.

Automatic TI station seek—Auto TP Seek

When traffic information station reception is poor, the unit automatically searches for another station that can be received better.

To activate Auto TP Seek

1



2



To deactivate Auto TP Seek: Press **[OFF]**.

OTHER EXTERNAL COMPONENTS

Using external audio/video players—AV-IN

When the operation buttons are not displayed on the screen, touch the area shown on the illustration.

- To change settings for video playback, see page 40.

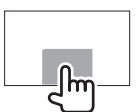

You can connect an external component to the AV-IN1 and iPod/AV-IN2 input terminals. (Page 57)

Preparation:

Select the appropriate source (<AV-IN1> or <AV-IN2>) for <AV-OUT> setting. (Page 47)

Indications and buttons on the source control screen

AV-IN name



Operation buttons

- [MODE]** Changes the AV-IN name.
- Press [◀] or [▶] to select an AV-IN name.
 - This setting does not affect the source name "AV-IN 1"/"AV-IN 2" displayed on <TOP MENU>.
- [MENU]** Displays the <TOP MENU> screen.

Starting playback

- 1 Connect an external component to the AV-IN1 and iPod/AV-IN2 input terminals. (Page 57)
- 2 Select "AV-IN1" or "AV-IN2" as the source.

On the <TOP MENU> screen:



To select "AV-IN1"



To select "AV-IN2"



- 3 Turn on the connected component and start playing the source.

Using a rear view camera

- To connect a rear view camera, see page 57.
- To use a rear view camera, a REVERSE lead connection is required. (Page 55)

Activating the rear view camera

- 1 Display the <Input> setting screen. On the <TOP MENU> screen:

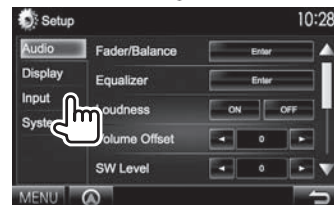

2

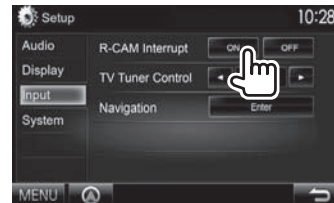

To deactivate: Select [OFF] for <R-CAM Interrupt>.

OTHER EXTERNAL COMPONENTS

❑ Displaying the picture from the rear view camera

The rear view screen is displayed when you shift the gear to the reverse (R) position.

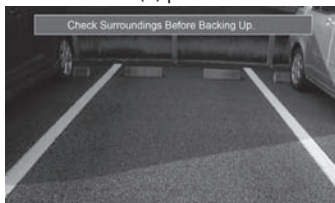

- To erase the caution message, touch the screen.

To display the picture from the rear view camera manually

DDX7035BT
DDX7035BTM*1

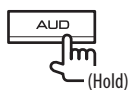

(Hold)

DDX5035BT
DDX5035BTM*2



(Hold)

- When displaying the picture from the rear view camera manually, you can change the setting of the picture using **[Aspect]/[PictureAdjust]**. (Page 40)

To exit the rear view screen: Press and hold the same button again.

*1 This operation works only when **<AUD Key Long Press>** is set to **[R-CAM]**. (Page 47)

*2 This operation works only when **<TEL Key Long Press>** is set to **[R-CAM]**. (Page 47)

Using a smartphone—HDMI/MHL

❑ What is HDMI/MHL?

HDMI stands for High Definition Multi-media Interface. An HDMI connection can transfer a digital video source signal (such as from a DVD player) without conversion to analog.

A new feature that has been added to HDMI that extends its capabilities further is MHL, or Mobile High-definition Link.

Both interfaces allow your smartphone to connect to the device. When it is connected, you can see your smartphone's screen on the monitor.

❑ Displaying the screen of the smartphone

You can display the screen of your smartphone connected via HDMI/MHL input terminal.

- 1 Connect your smartphone to the HDMI/MHL input terminal. (Page 57)
 - Use HDMI cable KCA-HD100 (optional accessory) or MHL cable KCA-MH100 (optional accessory).
- 2 Select **"HDMI/MHL"** as the source. On the **<TOP MENU>** screen:



- 3 Start an application or playback on your smartphone.

Watching a TV

Preparation

- Connect the TV tuner box to AV-IN1 input terminal and TV tuner remote control output terminal. (Page 57)
- Select **[ON]** for **<TV Tuner Control>**. (Page 46)

❑ Displaying the TV screen

- 1 Select **"AV-IN1"** as the source. (Page 9)
- 2 Turn on the TV.

❑ Operation buttons on the source control screen



[CH ▼] Changes the channel.

[CH ▲]

[MENU] Displays the **<TOP MENU>** screen.

OTHER EXTERNAL COMPONENTS

Using the external navigation unit

You can connect a navigation unit (KNA-G630: optional accessory) to the navigation input terminal so that you can view the navigation screen. (Page 57)

- The navigation guidance comes out of the front speakers even when you listen to an audio source.

❑ Viewing the navigation screen

On the <TOP MENU> screen:

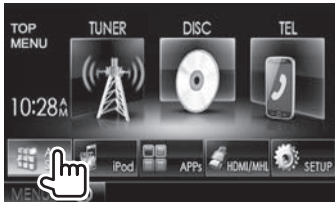

On the any screen:



- While the navigation screen is displayed, the touch panel operations are available only for navigation.
- The aspect ratio of the navigation screen is fixed to <Full> regardless of the <Aspect> setting (Page 41).

To exit the navigation screen

DDX7035BT
DDX7035BTM



DDX5035BT
DDX5035BTM



❑ Settings for the navigation unit

1 Display the <Input> setting screen.

On the <TOP MENU> screen:



2 Display the <Navigation> screen.



3



- <Guidance> Select which front speakers are used for the navigation guidance.
- <Volume> Adjust the volume of the navigation guidance. (0 to 35)
- <NAV Mute> Select [ON] to attenuate the sound coming out of speakers other than the front speakers during navigation guidance.
 - To cancel the attenuation, select [OFF].
- <NAV Setup> Press [Enter] to display the setup screen for the navigation unit. See the instruction manual supplied for the navigation unit.

BLUETOOTH

Information for using Bluetooth® devices



Bluetooth is a short-range wireless radio communication technology for mobile devices such as mobile phones, portable PCs, and other devices. Bluetooth devices can be connected without cables and communicate with each other.

Notes

- While driving, do not perform complicated operations such as dialing numbers, using the phone book, etc. When you perform these operations, stop your car in a safe place.
- Some Bluetooth devices may not connect to this unit depending on the Bluetooth version of the device.
- This unit may not work for some Bluetooth devices.
- Connecting conditions may vary depending on your environment.
- For some Bluetooth devices, the device is disconnected when the unit is turned off.

About mobile phones compatible with Phone book Access Profile (PBAP)

If your mobile phone supports PBAP, you can display the phone book and call lists on the touch panel screen when the mobile phone is connected.

- Phone book: up to 600 entries
- Dialed calls, received calls, and missed calls: up to 10 entries each

Connecting Bluetooth devices

❑ Registering a new Bluetooth device

When you connect a Bluetooth device to the unit for the first time, pair the unit and the device. Pairing allows Bluetooth devices to communicate with each other.

- The pairing method differs depending on the Bluetooth version of the device.
 - For devices with Bluetooth 2.1: You can pair the device and the unit using SSP (Secure Simple Pairing) which only requires confirmation.
 - For devices with Bluetooth 2.0: You need to enter a PIN code both on the device and unit for pairing.
- Once the connection is established, it is registered in the unit even if you reset the unit. Up to 5 devices can be registered in total.
- Two devices for Bluetooth phone and one for Bluetooth audio can be connected at a time.
- To use the Bluetooth function, you need to turn on the Bluetooth function of the device.
- To use the registered device, you need to connect the device to the unit. (Page 31)

Auto pairing

When <Auto Pairing> is set to [ON], iPhone is automatically paired when connected via USB. (Page 36)

Pairing a Bluetooth device using SSP (for Bluetooth 2.1)

When the Bluetooth device is compatible with Bluetooth 2.1, a pairing request is sent from an available device.

- 1 Search the unit (“DDX****”) from your Bluetooth device.
- 2 Confirm the request both on the device and the unit.

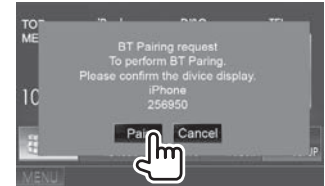

- Press [Cancel] to reject the request.

BLUETOOTH

Pairing a Bluetooth device from the target device using a PIN code (for Bluetooth 2.0)

1 Display the <Bluetooth Setup> screen.

On the <TOP MENU> screen:



- You can also display the <Bluetooth Setup> screen by pressing [] on the phone control screen. (Page 33)



2 Change the PIN code.

- If you wish to skip changing the PIN code, go to step 3.
- The PIN code is initially set to "0000".
- The maximum number of digits in the PIN code is 15.

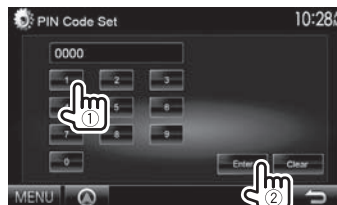

- Press [Clear] to delete the last entry.
- #### 3 Search the unit ("DDX****") from your Bluetooth device.

- #### 4 Select the unit ("DDX****") on your Bluetooth device.
- If a PIN code is required, enter "0000" (initial).

When pairing is complete, the device is listed on the <Paired Device List>.



- To use the paired device, connect the device on the <Paired Device List>. (Page 31)

BLUETOOTH

Pairing a Bluetooth device from this unit using a PIN code (for Bluetooth 2.0)

1 Display the <Bluetooth Setup> screen.
(Page 30)



3 Search for the available devices.

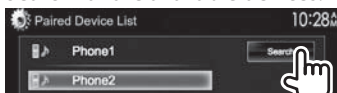

• To cancel searching devices, press **[Cancel]**.

4 Select the device you want to pair.



A confirmation message appears. Press **[Pair]**.

Connecting/disconnecting a registered Bluetooth device

Two devices can be connected simultaneously.

1 Display the <Bluetooth Setup> screen.
(Page 30)



3 Select the device you want to connect (①), then press **[Connection]** (②).



4 Select **[ON]** or **[OFF]** for the target.

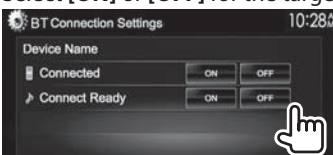

📱: Mobile phone

🎧: Audio device

- The status is shown as follows:
 - “Connected”: A connection has been established.
 - “Connect Ready”: A connection can be established.
 - “Disconnected”: No connection is established.

Deleting a registered Bluetooth device

1 Display the <Bluetooth Setup> screen.
(Page 30)

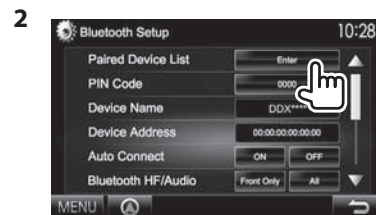

3 Select a device to delete (①), then press **[Remove]** (②).



A confirmation message appears. Press **[Yes]**.

BLUETOOTH

Using the Bluetooth mobile phone

❑ Receiving a call

When a call comes in...

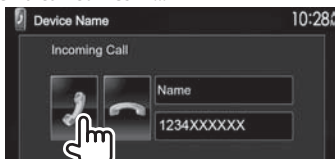

- Call information is displayed if acquired.
- Phone operation is not available while the picture from the rear view camera is displayed. (Page 26)

To reject a call

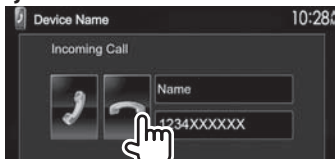

When **<Auto Response>** is set to **[On]** (Page 36)
The unit answers the incoming call automatically.

❑ Ending a call

While talking...



❑ Adjusting the volume of calls/earpiece/microphone

While talking...





- You can adjust the volume level between 0 to 15 (initial: 3).
- This adjustment does not affect the volume level of the other sources.
- Use the monitor panel to adjust the call/earpiece volume. (Page 7)

❑ Switching between handsfree mode and phone mode

While talking...



Each time you press the button, the talking method is switched ( : handsfree mode /  : phone mode).

❑ Reducing noise/adjusting the echo cancel level

While talking...



- **To adjust the echo volume (between -1 to +1, initial: 0):** Adjust **<EC LEVEL>**.
- **To adjust the noise reduction volume (between 0 to -20, initial: -10):** Adjust **<NR LEVEL>**.

BLUETOOTH

❑ Sending text during a call

You can send text during a call using the DTMF (Dual Tone Multi Frequency) function.

While talking...

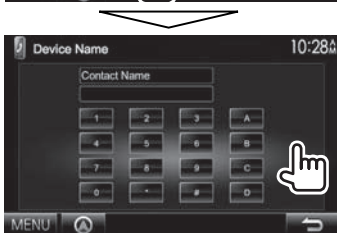

❑ Switching between the two devices connected

When 2 devices are connected, you can change the device to use.

On the phone control screen:



- The name of the active device appears. The devices are switched each time the button is pressed.

❑ Making a call

- 1 Display the phone control screen. On the <TOP MENU> screen:

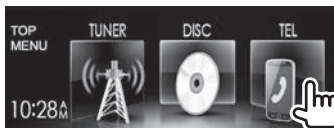

- You can also display the phone control screen by pressing TEL on the monitor panel.

- 2 Select a method to make a call.

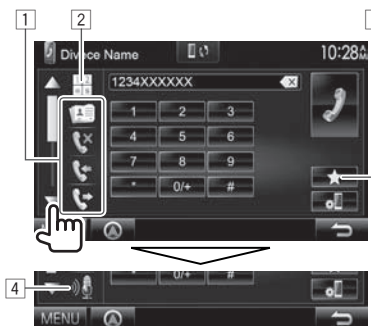

- You can show more items by pressing [▲]/[▼].

- 1 From the phone book*/call lists
- 2 Direct number entry
- 3 From the preset list
 - To preset, see page 35.
- 4 Voice dialing

- * When the mobile phone is not compatible with Phone Book Access Profile (PBAP), the phone book is not displayed.

From the preset list/phone book/call lists

1



- [★] From the preset list
- [📖] From the phone book
- [📞] From the missed call list
- [📞] From the received call list
- [📞] From the dialed call list

- 2 Select the target (①), then make a call (②).

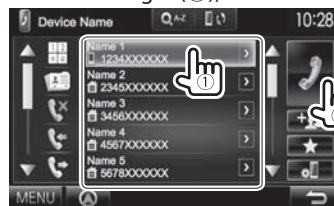

- You can change the page to display more items by pressing [▲]/[▼].

BLUETOOTH

- To use the A to Z search on phone book:
When the phone book list is displayed, you can search by initial.



2 Select the initial.

- If the initial is a number, press [1,2,3...] and then select the number.



3 Select a phone number from the list.



- To display the details of an entry:
When the phone book list is displayed, you can display the details of an entry and select a phone number if several phone numbers are registered.

1 Display the details of the desired entry.



2 Select a phone number to call.

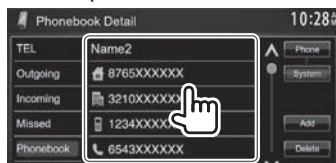

Direct number entry

You can enter up to 31 numbers.



- Press [X] to delete the last entry.
- Press and hold [0/+] to add "+" to the phone number.

Voicedialing

- Available only when the connected mobile phone has a voice recognition system.

1 Activate voice dialing.

On the phone control screen:

- Press [▼] repeatedly to change the page on the phone control screen.



On the monitor panel:

DDX7035BT
DDX7035BTM

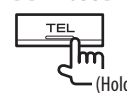

(Hold)

DDX5035BT
DDX5035BTM*



(Hold)

2 Say the name of the person you want to call.

- If the unit cannot find the target, the following screen appears. Press [Start], then say the name again.



To cancel voice dialing: Press [Cancel].

* This operation works only when <TEL Key Long Press> is set to [VOICE]. (Page 47)

BLUETOOTH

❑ Presetting phone numbers

You can preset up to 5 phone numbers.

- 1 Display the phone control screen.
(Page 33)
- 2 Enter the numbers on the direct number entry screen, then display the preset list.



- 3 Select a preset number to store into.



- To display the preset list, press [★] on the phone control screen.

Using the Bluetooth audio player

- To register a new device, see page 29.
- To connect/disconnect a device, see page 31.

❑ Indications and buttons on the source control screen

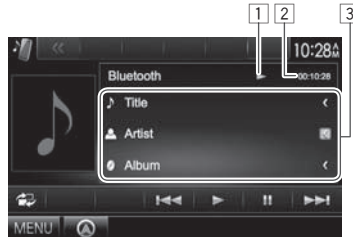

- The operation buttons, indications and information displayed on the screen differ depending on the connected device.

Playback information

- 1 Playback status*
- 2 Playing time*
- 3 Tag data (current track title/artist name/album title)*
 - Pressing [<] scrolls the text if not all of the text is shown.

Operation buttons

- [Easy Control] Displays the easy control screen.
(Page 8)
- [<<] [>>] • Selects a track. (Press)
 - Reverse/forward search.* (Hold)
- [▶] Starts playback.
- [⏸] Pauses playback.
- [MENU] Displays the <TOP MENU> screen.

* Available only for the devices compatible with AVRCP 1.3.

BLUETOOTH

Settings for Bluetooth devices

You can change various settings for using Bluetooth devices on the **<Bluetooth Setup>** screen.

- 1 Display the **<Bluetooth Setup>** screen. On the **<TOP MENU>** screen:

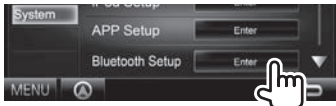
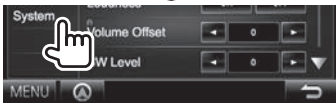

- You can also display the **<Bluetooth Setup>** screen by pressing [**Q**] on the phone control screen. (Page 33)



- 2 Configure the Bluetooth settings.



Setting items

<Paired Device List>	Press [Enter] to show the list of registered devices. You can connect a device or delete registered devices. (Page 31)
<PIN Code>	Changes the PIN code of the unit. (Page 30)
<Device Name>	Shows the device name to be shown on the Bluetooth device — DDX****.
<Device Address>	Shows the device address of the unit.
<Auto Connect>	<ul style="list-style-type: none"> • ON (Initial): The connection is automatically established with the last connected Bluetooth device when the unit is turned on. • OFF: Cancels.
<Bluetooth HF/Audio>	Select the speakers used for Bluetooth (both phone and audio player). <ul style="list-style-type: none"> • Front Only: Front speakers only. • All (Initial): All speakers.
<Auto Response>	<ul style="list-style-type: none"> • ON: The unit answers the incoming calls automatically in 5 seconds. • OFF (Initial): The unit does not answer the calls automatically. Answer the calls manually.

<AutoPai ring>	<ul style="list-style-type: none"> • ON (initial): Establishes pairing automatically with the connected iOS device (such as iPhone) even if the Bluetooth function is deactivated on the device. (Auto pairing may not work for some devices depending on the iOS version.) • OFF: Cancels.
<Ring Mode>	<ul style="list-style-type: none"> • System (Initial): The ring tone set on the unit is used. • Phone: The ring tone set on the mobile phone is used. (This function may not work depending on the mobile phone.)
<Ring Tone Change>	When <Ring Mode> is set to <System> , select the ring tone for received calls and SMS from [Tone1] (Initial), [Tone2] , [Tone3] .
<Initialize>	Hold [Enter] to reset all settings you have made for using Bluetooth mobile phone and Bluetooth audio player.

SETTINGS

Settings for using applications of the iPod/iPhone/Android

Before using applications of the iPod/iPhone/Android such as Pandora, select the device to use and connection method.

When connecting the device for first time, the setup screen (for connection, etc.) appears. Follow the procedure on the setup screen to configure the settings.

- 1 Pair the iPod/iPhone/Android device through Bluetooth. (Page 29)
- 2 Display the **<APP Setup>** screen. On the **<TOP MENU>** screen:

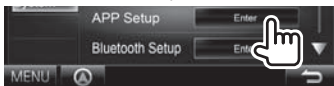
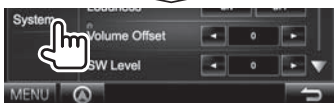

- If **[Enter]** for **<APP Setup>** cannot be selected, put the unit in standby. (Page 7)

- 3 Display the **<APP Connection Setup>** screen.



- If you do not need to change the setting, press **[OK]** to exit from the setup screen.

- 5 Select the device type (①), then press **[Next]** (②).



- 6 Select the connection method (①), then press **[Next]** (②).



For Android:

<HDMI/MHL + Bluetooth> Select this when the Android is connected both by cable to HDMI/MHL input terminal and via Bluetooth.

<Bluetooth> Select this when the device is connected via Bluetooth.

For iPod/iPhone:

<USB + AV-IN> Select this when the iPod/iPhone is connected using KCA-iP202 (optional accessory).

<USB 1 Wire> Select this when the iPod/iPhone is connected using USB 2.0 cable (accessory of the iPod/iPhone).

<HDMI + Bluetooth> Select this when the iPod/iPhone is connected using HDMI cable KCA-HD100 (optional accessory) and USB 2.0 cable (accessory of the iPod/iPhone) through Lightning-Digital AV adapter (accessory of the iPod/iPhone).

<Bluetooth> Select this when the iPod/iPhone is connected via Bluetooth.

- When selecting **<USB + AV-IN>** or **<USB 1 Wire>**, go to step 8.

- 7 When selecting **<HDMI + Bluetooth>** or **<Bluetooth>** as the connection method, the device selection screen appears. Search for the available iPod/iPhone devices (①), select the target device from the list (②), then press **[Next]**.



- You can change the page to display more items by pressing **[▲]/[▼]**.
- If the device is already listed, skip the step ①.
- To stop searching, press **[Cancel]**.

- 8 Confirm the settings.

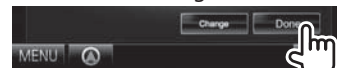

SETTINGS

Sound adjustment

Using the sound equalization

- The adjustment is memorized for each source until you adjust the sound again. If the source is a disc, the adjustment is stored for each of the following categories.
 - DVD/DVD-VR/VCD
 - CD
 - DivX/MPEG1/MPEG2/H.264/WMV/MP3/WMA/WAV/AAC/FLAC
- You cannot adjust the sound when the unit is in standby.

Selecting a preset sound mode

- 1 Display the **<Equalizer>** screen.
On the **<TOP MENU>** screen:

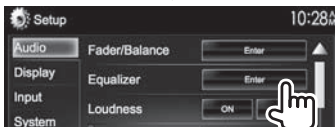

- 2 Select a sound mode.

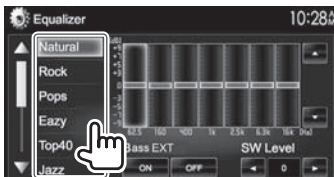

- You can change the page to display more items by pressing [▲]/[▼].

- For DDX7035BT/DDX7035BTM: You can also display the **<Equalizer>** screen by pressing AUD on the monitor panel.

Storing your own adjustment—Adjusting the sound precisely

- 1 Select a sound mode. (See the left column.)
- 2 Select a band and adjust the level of the selected band.
 - The number of bands depends on the model.
 - You can adjust the level by dragging the control or using [▲]/[▼].
 - Repeat this step to adjust the level of other bands.

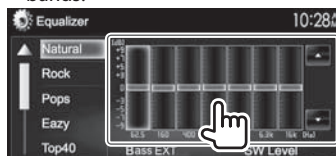

The adjustments are stored and **<User>** is activated.

- 3 Activate (**[ON]**) or deactivate (**[OFF]**) the bass (**<Bass EXT>**) (①), and then adjust the subwoofer level (②).

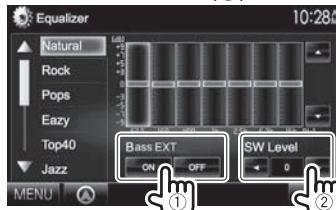

Setting the car type and speakers

- 1 Display the **<Car Setting>** screen.
On the **<TOP MENU>** screen:
 - Press [▼] repeatedly to change the page on the **<Audio>** menu screen.

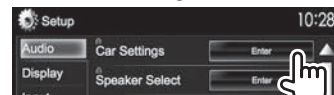

- 2 Select a car type (①), and then select the location of the speakers (②).



SETTINGS

❑ Setting the speakers—speaker size and crossover frequency

1 Display the <Speaker Select> screen.

On the <TOP MENU> screen:

- Press [▼] repeatedly to change the page on the <Audio> menu screen.

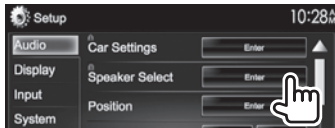

2 Select the speaker type (front speakers, rear speakers, or subwoofer).



3 Select the size of the selected speaker.

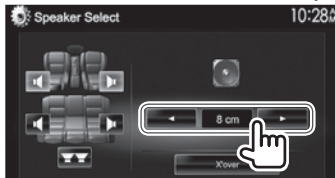

4 Adjust the crossover frequency of the selected speaker.

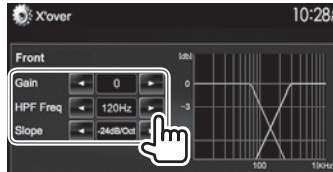

- <Gain> Adjusts the output volume of the selected speaker.
- <HPF Freq> Adjusts the crossover frequency for the front or rear speakers (high pass filter).^{*1}
- <LPF Freq> Adjusts the crossover for the subwoofer (low pass filter).^{*2}
- <Slope> Adjusts the crossover slope.
- <Phase> Selects the phase for the subwoofer.^{*2}

^{*1} Appears only when the front or rear speakers are selected.

^{*2} Appears only when the subwoofer is selected.

❑ Setting the listening position

You can adjust the sound effects according to your listening position.

1 Display the <Position> screen.

On the <TOP MENU> screen:

- Press [▼] repeatedly to change the page on the <Audio> menu screen.

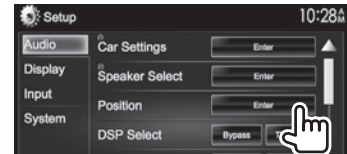

2 Select the listening position ([All], [Front L], [Front R] or [Front All]).



SETTINGS

Adjusting the Digital Time Alignment (DTA)

Make fine adjustment of the delay time of the speaker output to have a more suitable environment for your vehicle.

- 1 Display the **<Position>** screen. (Page 39)
- 2 Display the **<Position DTA>** screen.



- 3 Select the speaker you want to adjust (①), and then adjust each item (②).

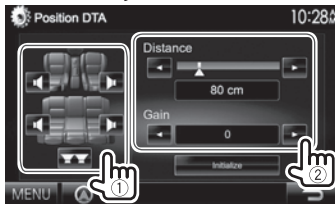

<Distance> Adjusts the Digital Time Alignment (DTA) value.

<Gain> Adjusts the output volume of the selected speaker.

- To determine the adjustment value, see the right column.
- To initialize the setting value, press **[Initialize]**.

Determining the value for <Position DTA> adjustment

If you specify the distance from the center of the currently set listening position to every speaker, the delay time will be automatically computed and set.

- ① Determine the center of the currently set listening position as the reference point.
- ② Measure the distances from the reference point to the speakers.
- ③ Calculate the differences between the distance of the furthest speaker and other speakers.
- ④ Set the DTA value calculated in step ③ for individual speakers.
- ⑤ Adjust gain for individual speakers. A sound image will be shifted to the speaker with increased gain.

Example: When **[Front LR]** is selected as the listening position

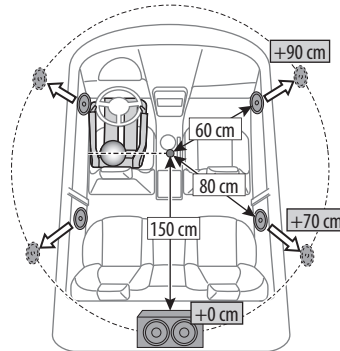

Adjustment for video playback

Adjusting the picture

You can adjust the picture quality.

- 1 Display the adjustment menu.

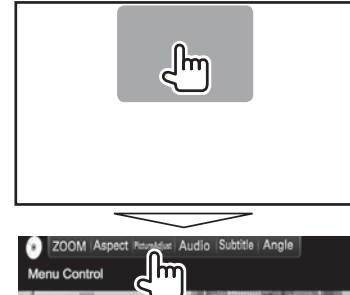

- 2 Select **[DIM ON]** (dimmer on) or **[DIM OFF]** (dimmer off).



SETTINGS

3 Adjust the picture.

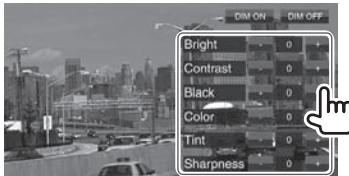

- <Bright>** Adjusts the brightness. (-15 to +15)
- <Contrast>** Adjusts the contrast. (-10 to +10)
- <Black>** Adjusts the blackness. (-10 to +10)
- <Color>** Adjusts the color. (-10 to +10)
- <Tint>** Adjusts the tint. (-10 to +10)
- <Sharpness>** Adjusts the sharpness. (-2 to +2)

❑ Changing the aspect ratio







You can change the aspect ratio for video playback.

1 Display the adjustment menu.



2 Select the aspect ratio.



- <FULL>*** For 16:9 original pictures
- | | |
|---|---|
| 4:3 signal | 16:9 signal |
|  |  |
- <Normal>*** For 4:3 original pictures
- | | |
|---|---|
| 4:3 signal | 16:9 signal |
|  |  |
- <JUST>** For viewing 4:3 pictures naturally on the wide screen
- | | |
|---|---|
| 4:3 signal | 16:9 signal |
|  |  |
- <Zoom1>** –
- <Zoom3>** –
- Changes the magnification.
 - The aspect ratio is automatically selected to match the video source.

* While DivX is played back with **<Screen Ratio>** set to [16:9] (Page 14), the aspect ratio is not set correctly.

❑ Zooming the picture

You can zoom the picture. Zooming is available only when disc is played back.

1 Display the adjustment menu.

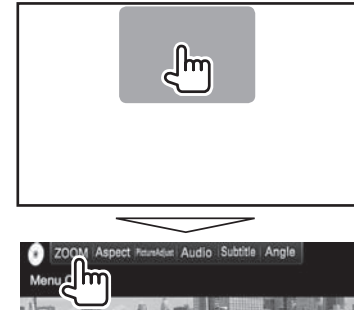

2 Change the magnification (①), then move the zooming frame (②).



- The zoom function cannot be used for some video sources.

SETTINGS

Changing display design

You can change the background and panel color.

- 1 Display the **<User Customize>** screen.
On the **<TOP MENU>** screen:

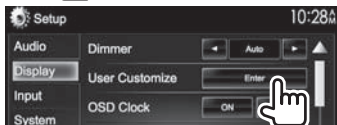
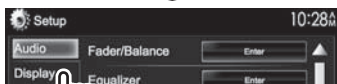

- 2 Select an item to change ([**Background**] or [**Panel Color**]).

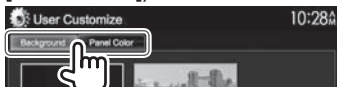

- 3 Select a background/panel color.
To select a background



To select a panel color



- Selecting [**Scan**] changes the illumination color gradually.

- *1 Store your own scene beforehand. (See the right column.)
- *2 Store your own color adjustment beforehand. (See below.)

❑ Making your own color adjustment

- 1 Select [**Panel Color**] on the **<User Customize>** screen. (See the left column.)



- 3 Select the dimmer setting for the color (①), then adjust the color (②).



❑ Storing your favorite image for the background

You can set your favorite image (JPEG/PNG/BMP file) stored on the connected USB device.

- Use the JPEG/PNG/BMP file that the resolution is 800 x 480 pixels.
- The color of the captured image may look different from that of the actual scene.

- 1 Connect the USB device with the image stored. (Page 56)
- 2 Display the **<User Customize>** screen. (See the far left column.)
- 3 Display the file selecting screen.



- 4 Select the folder (①), then the file for the background image in the selected folder (②).



- You can change the page to display more items by pressing [▲]/[▼].

A confirmation message appears. Press [**OK**] to store the newly captured image. (The existing image is replaced with the new one.)

SETTINGS

Customizing the <TOP MENU> screen

You can arrange the items to display on the <TOP MENU> screen.

- 1 Display the <Menu Customize> screen. On the <TOP MENU> screen:

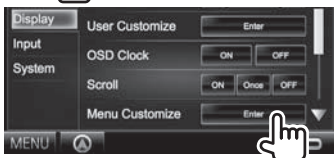

- 2 Select the position to place the icon (1), then select the item you want to display on the selected position (2).

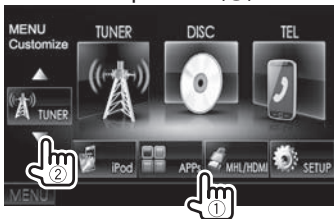

Repeat this step to place icons for other items.

Customizing the system settings

Memorizing/recalling the settings

- You can memorize the settings changed in the <Setup> menu and recall the memorized settings anytime.
- The memorized settings are kept even when the unit is reset.

- 1 Display the <SETUP Memory> screen. On the <TOP MENU> screen:
 - Press [▼] repeatedly to change the page on the <System> menu screen.

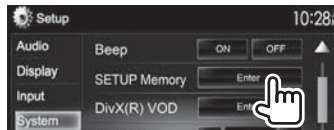
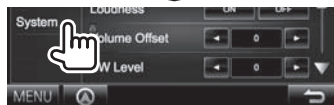

2



- To cancel, press [No].

- 3 Select an operation.



- [Recall]** Recalls the memorized settings.
- [Memory]** Memorizes the current settings.
- [Clear]** Clears the currently memorized settings.

- To cancel, press [Cancel].

A confirmation message appears. Press [Yes].

SETTINGS

❑ Locking the settings

You can lock the settings to prevent them from being changed.

-  is shown beside the settings that can be locked.

1 Display the **<SETUP Memory>** screen.
(Page 43)



To unlock the setting: Press [**Unlock**].

❑ Updating the system

You can update the system by connecting a USB device containing an update file.

- To update the system, visit <http://www2.jvckenwood.com/cs/ce/>.

1 Create an update file, copy it to a USB device, and connect it to the unit.

- To connect a USB device, see page 56.

2 Display the **<System Information>** screen.

On the **<TOP MENU>** screen:

- Press [**▼**] repeatedly to change the page on the **<System>** menu screen.

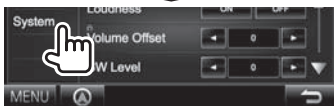

<Application Version> Updates the system application.

<System Version> Updates the system.

<Bluetooth Version> Updates the Bluetooth application.

It may take a while.

If the update has been completed successfully, "Update Completed" appears. Reset the unit.

- If the update has failed, turn the power off and then on, and retry the update.
- Even if you have turned off the power during the update, you can restart the update after the power is turned on. The update will be performed from the beginning.

❑ Adjusting the touch position

You can adjust the touch position on the touch panel if the position touched and the operation performed do not match.

1 Display the **<Setup>** setting screen. (See the far left column.)

2 Display the **<Touch Panel Adjust>** screen.
• Press [**▼**] repeatedly to change the page on the **<System>** menu screen.

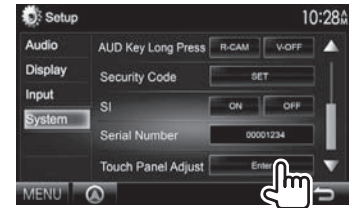

3 Touch the center of the marks at the lower left and at the upper right as instructed.

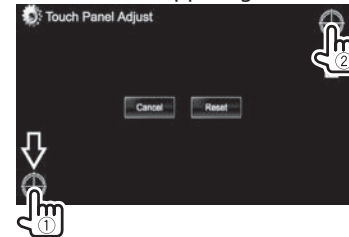

- To reset the touch position, press [**Reset**].
- To cancel the current operation, press [**Cancel**].

SETTINGS

Setting menu items

❑ Displaying the <Setup> menu screen



- You can change the page to display more items by pressing [▲]/[▼].
- **You cannot change the <Audio> settings screen when [STANDBY] is selected on the <TOP MENU>.** (page 7)

❑ <Audio> setting screen

<Fader/Balance>



Fader: Adjust the front and rear speaker output balance.

- **F6 to R6** (Initial: **0**)
 - When using a two-speaker system, set the fader to the center (**0**).

Balance: Adjust the left and right speaker output balance.

- **L6 to R6** (Initial: **0**)
 - Press [▲]/[▼]/[◀]/[▶] or drag [⊕] to adjust.
 - To clear the adjustment, press [Center].

<Equalizer>

Change the sound mode or adjust and store the equalization for each source. (Page 38)

- **Natural** (Initial)/**Rock/Pops/Easy/Top40/Jazz/iPod*1/Powerful/User**

<Loudness>

You can activate/deactivate loudness.

- **ON** (Initial): Boost low and high frequencies to produce a well-balanced sound at a low volume level.
- **OFF:** Cancels.

<Volume Offset>

Adjust and store the auto-adjustment volume level for each source. (For discs, the adjustment is stored for each of the following categories: DVD/DVD-VR/VCD, CD, and DivX/MPEG1/MPEG2/H.264/WMV/MP3/WMA/WAV/AAC/FLAC.) The volume level will automatically increase or decrease when you change the source.

- **-15 to +6** (Initial: **0**)

<SW Level>

Adjust the subwoofer level.

- **-50 to +10** (Initial: **0**)

<Car Setting>

Select a car type and speaker location. (Page 38)

- Car type: **Off** (initial)/**Compact/Full Size Car/Wagon/Minivan/SUV/Minivan (Long)**
- **Speaker Location:** Select the location of the speaker on your car.
 - **Front Speaker: Door** (initial)/**On Dash/Under Dash**
 - **Rear Speaker*2: Door/ Rear Deck/2nd Row 3rd Row**

<Speaker Select>

Select the speaker size and adjust the crossover frequency. (Page 39)

<Position>

Adjust the sound effects according to your listening position. (Page 39)

<DSP Select>

Select whether to use the Digital Signal Processor (DSP) system.

- **Bypass:** Invalidates all the settings for the DSP.
- **Through** (Initial): Uses the DSP.

<Drive Equalizer>

You can reduce the driving noise by raising the bandwidth.

- **ON:** Activates the Drive EQ.
- **OFF** (Initial): Cancels.

*1 Appears only when iPod is selected as the source.

*2 The initial setting varies depending on the car type setting.

SETTINGS

<Display> setting screen

<Dimmer>

- **Auto** (Initial): Dims the screen and button illumination when you turn on the headlights.
 - The ILLUMI lead connection is required. (Page 55)
- **ON**: Activates dimmer.
- **OFF**: Cancels.
- **NAV**: Activates or deactivates dimmer according to the day/night display setting of the connected navigation unit.

<UserC ustomize>

Change the display design (background and panel color). (Page 42)

<OSD Clock>

- **ON**: Displays the clock while a video source is playing.
- **OFF** (Initial): Cancels.

<Scroll>

- **ON** (Initial): Scrolls the displayed information repeatedly.
- **Once**: Scrolls the displayed information once.
- **OFF**: Cancels.

Pressing [**<**] scrolls the text regardless of this setting.

<Menu Customize>

Change the items to display on the <TOP MENU> screen. (Page 43)

<Screen Adjust>

Adjust the brightness and blackness of the screen. Press [**Enter**] to display the setting screen, select [**DIM ON**] (Dimmer On)/[**DIM OFF**] (Dimmer Off), then change the following settings:

- **Bright**: Adjusts brightness.
 - **-15** to **+15** (Initial: **0** for dimmer on/**+15** for dimmer off)
- **Black**: Adjusts blackness.
 - **-10** to **+10** (Initial: **0**)

<Angle>*

Adjust the panel angle. (Page 7)

* Onlyfor DDX7035BT/DDX7035BTM.

<Input> setting screen

<R-CAMI interrupt>

- **ON**: Displays the picture from the rear view camera when you shift the gear to the reverse (R) position.
- **OFF** (Initial): Select this when no camera is connected.

<TV Tuner Control>

- **ON**: Enables to control TV operation on the “**AV-IN 1**”.
- **OFF** (Initial): Select this to use “**AV-IN 1**” with the other component than TV Tuner.

<Navigation>

Change the navigation settings. (Page 28)

SETTINGS

☐ <System> setting screen

<Language>

Select the text language used for on-screen information.

- **English** (initial)/**Spanish/French/German/Italian/Dutch/Russian/Portuguese/Chinese-Simplified/Chinese-Traditional/Thai/Turkish/Arabic/Persian/Hebrew/Greek/Indonesia/Korean**
 - For external monitors, only English/Spanish/French/German/Italian/Dutch/Russian/Portuguese are available. If another language has been selected, the text language for external monitors will be set to English.
- **GUI Language:** Select a language used for displaying operation buttons and menu items.
 - **English** (Initial)/**Local** (the language selected above)

<Clock>

Adjust the clock time. (Page 5)

<iPod Setup>

Configure the settings of iPod. (Page 17)

<APP Setup>

- **APP Connection Setup:** Configure the Apps settings. (Page 37)
- **APP Interrupt Volume:** Adjust the volume of App.
 - **00 to 35** (Initial: **17**)

<Bluetooth Setup>

Configure settings for using a Bluetooth device, such as connection and other general operations. (Page 36)

<Beep>

- **ON** (Initial): Activates the key-touch tone.
- **OFF:** Cancels.

<SETUP Memory>

You can memorize, recall, or clear the settings you have made. (Page 43)

<DivX(R) VOD>

This unit has its own Registration Code. Once you have played back a file with the Registration Code recorded, this unit's Registration Code is overwritten for copyright protection.

- Press [**Enter**] to display the information.
- To return to the previous screen, press [**OK**].

<TEL Key Long Press>*2

Assigns the function of the TEL button when held.

- **R-CAM:** Displays the picture from the rear view camera. (Page 27)
- **V-OFF:** Turns off the screen. (Page 8)
- **VOICE** (initial): Activates voice dialing. (Page 34)

<AV-OUT>

You can determine the use of the external component connected to the AV-OUT terminal.

- **OFF** (Initial)/**AV-IN1/AV-IN2/DVD**

<AV Key Long Press>

Assigns the function of the AV button when held.

- **AV-OUT** (initial): Selects the AV source for extra monitor or amplifier.
- **APPs:** Displays the Apps screen. (Page 19)

<AUD Key Long Press>*3

Assigns the function of the AUD button when held.

- **V-OFF** (initial): Turns off the screen. (Page 8)
- **R-CAM:** Displays the picture from the rear view camera. (Page 27)

<Security Code>

Register the security code for the unit. (Page 4)

<SI>

Activate or deactivate the security function. (Page 5)

<Serial Number>

Displays the serial number.

<Touch Panel Adjust>

Adjust the touch position of the buttons on the screen. (Page 44)

<Steering Remote Controller>

Assign the functions to the keys on the remote controller of the steering wheel. (Page 52)

<System Information>

Displays the version information of the software. You can update the software. (Page 44)

*2 Only for DDX5035BT/DDX5035BTM.

*3 Only for DDX7035BT/DDX7035BTM.

REMOTEC ONTROLLER

Overview

DDX7035BT Region 3/DDX7035BTM/DDX5035BT Region 3/DDX5035BTM:

This unit can be operated using the Remote Controller (RC-DV340) supplied with this unit.

DDX7035BT Region 4/DDX5035BT Region 4:

Optional Remote Controller KNA-RCDV331 is designed for controlling this unit. Refer to the instruction manual that comes with the remote controller.

⚠ Caution:

- Put the Remote Controller in a place where it will not move during braking or other operations. A dangerous situation could result if the Remote Controller falls down and gets wedged under the pedals while driving.
- Do not leave the battery near fire or under direct sunlight. A fire, explosion or excessive heat generation may result.
- Do not recharge, short, break up or heat the battery or place it in an open fire. Such actions may cause the battery to leak fluid. If spilled fluid comes in contact with your eyes or on clothing, immediately rinse with water and consult a physician.
- Place the battery out of reach of children. In the unlikely event that a child swallows the battery, immediately consult a physician.

❑ Battery installation

Use two "AAA"/"R03"-size batteries. Insert the batteries with the + and - poles aligned properly, following the illustration inside the case.

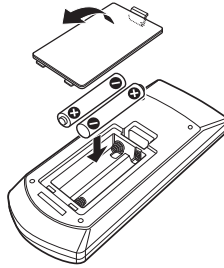

- If the Remote Controller operates only over shorter distances or does not operate at all, it is possible that the batteries are depleted. In such instances, replace both batteries with new ones.

❑ Remote Controller mode switch

The functions operated from the remote controller differ depending on the position of the mode switch.

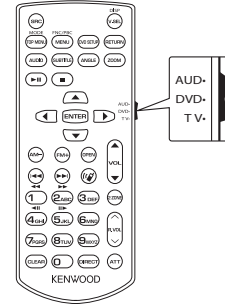

AUD mode: Switch to this mode when controlling a selected source or tuner source, etc.

DVD mode: Switch to this mode when playing DVDs or CDs etc. with the player integrated in this unit.

TV mode: Not used.

- The position of the remote control mode switch is indicated in the title of each mode, e.g., "(AUD mode)".
- When controlling a player that is not integrated in the unit, select "AUD" mode.

REMOTE CONTROLLER

Operations from the remote controller

Common operations (AUD mode)

Source switching

Switches to the source to be played.
Hangs up the incoming/current call.

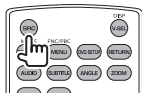

Volume control

Adjusts the volume.

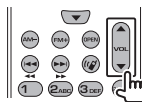

Volume attenuating

Press the key once to lower the volume. Press again to restore the previous volume.

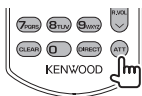

NAV/V.SEL

Switches to the navigation screen.

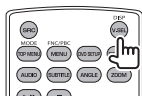

ENTER

Enters options.



Hands-free communication

When a call comes in, it answers the call.

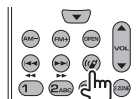

Function

Switches the control screen.

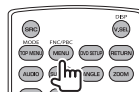

MODE

Switches the aspect ratio.
Aspect ratio changes each time you press this key.

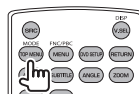

OPEN (Only for DDX7035BT/DDX7035BTM)

Adjusts the panel angle.
The panel angle changes each time you press this key.



DVD/DVD-VR/VCD (DVD mode)

Cursor key

Moves the cursor when displaying a menu.

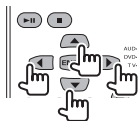

Track search and file search

Selects the track or file to be played.

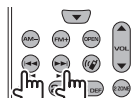

Play/Pause

Pauses the track.
Press again to resume playing.



Stop

Stops and memorizes the point where the disc stops.



Direct search

Pressing this key switches the features that can be searched for directly.

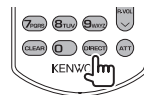

- DVD-VIDEO
 - Chapter number
 - Title number
 - Cancel
- DVD-VR
 - Chapter number
 - Original Program/Playlist
 - Cancel
- VCD 1.X, VCD 2.X (PBC OFF)
 - Track number
 - Cancel
- VCD 2.X (PBC ON)
 - Track number
 - Cancel

Once you have switched to the direct search feature, specify the search number from the numeric keypad, and then press the [ENTER] key.

REMOTE CONTROLLER

Numeric keypad

- Specify the number to search for in direct search.
- Press **1** **2** to fast forward/backward. Switches the fast forward/backward speed each time you press this key.
- Press **1** **2** to slow forward/backward during pause.

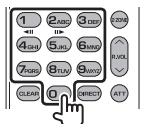

DVD Top Menu

Returns to the DVD top menu.

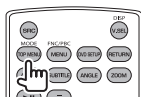

DVD Menu

Displays the DVD menu.

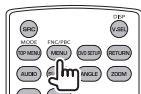

SUBTITLE

Switches the subtitle language.

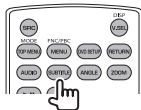

ZOOM

Switches the zoom ratio each time you press this key.

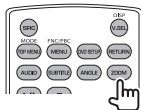

Picture Angle

Switches the picture angle each time you press this key.

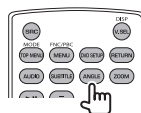

AUDIO

Switches the voice language each time you press this key.

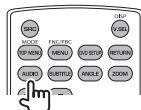

Music Disc/Audio file/Video file (AUD mode)

Folder search

Selects the folder to be played.



Track search and file search

Selects the track or file to be played.



Play/Pause

Pauses the track.
Press again to resume playing.



Direct search

Pressing this key switches the features that can be searched for directly.

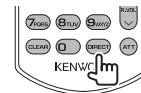

- Music Disc
 - Track number
 - Cancel
- Audio files in DVD/CD disc
 - Folder number
 - File number
 - Cancel

Once you have switched to the direct search feature, specify the search number from the numeric keypad, and then press the **[ENTER]** key.

Numeric keypad

Specify the number to search for in direct search.

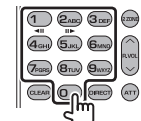

REMOTE CONTROLLER

❑ Radio (AUD mode)

Band switching

Switches to bands received by the unit.

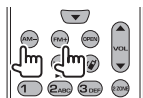

Station selection

Switches to broadcast stations received by the unit.

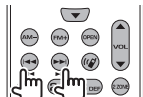

Seek mode switching

Switches the Seek mode (AUTO1, AUTO2, MANU).



Direct tuning

After pressing this key, use the keypad to specify the broadcast station you wish to receive.

Example: 92.1 MHz (FM)

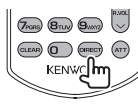

Numerick eypad

- To use preset tuning, press the number of a programmed broadcast station. (1 - 6MHz)
- Press the direct tuning key first, then specify the frequency of the station to receive.



❑ iPod (AUD mode)

Music/Video search

Selects the music/video to be played.



Play/Pause

Pauses the music/video. Press again to resume playing.



❑ USB (AUD mode)

Folder search

Selects the folder to be played.

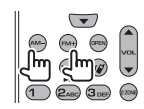

File search

Selects the file to be played.



Play/Pause

Pauses the file. Press again to resume playing.



REMOTE CONTROLLER

Using the steering remote controller

You can assign the functions to the keys of the remote controller on the steering wheel.

- This function is available only when your vehicle is equipped with the electrical steering remote controller.
- You can only register/change the functions while you are parked.
- If your steering remote controller is not compliant, learning may not be completed and an error message may appear.

□ Registering/Changing the functions

- 1 Display the <System> setting screen. On the <TOP MENU> screen:



- 2 Display the <Steering Remote Control Setting> screen.
 - Press [▼] repeatedly to change the page on the <System> menu screen.

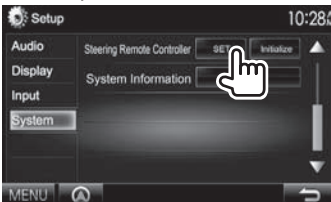

- 3 Press a steering remote controller button to register/change.
- 4 Select a function to assign.



- You can change the page to display more items by pressing [▲]/[▼].
- 5 Repeat steps 3 and 4 as necessary.
 - 6 Finish the procedure.



- The unit can register/change all of the button's functions at the same time. To do this, press each button in turn and after pressing all of them, press [Done] in the <Steering Remote Control Setting> screen. However, new functions cannot be learned after this operation.
- When changing the functions already learned, touch the button you want to change in step 3 and then touch to select the new function from the function list.
- Confirm the contents of the settable functions in the function list. You cannot edit the function list.

□ Initializing the settings

- 1 Display the <System> setting screen. (See the far left column.)
 - Press [▼] repeatedly to change the page on the <System> menu screen.



- To cancel the initialization, press [No].

CONNECTION/INSTALLATION

Before installing the unit

⚠ WARNING

- If you connect the ignition wire (red) and the battery wire (yellow) to the car chassis (ground), you may cause a short circuit, that in turn may start a fire. Always connect those wires to the power source running through the fuse box.
- Do not cut out the fuse from the ignition wire (red) and the battery wire (yellow). The power supply must be connected to the wires via the fuse.

⚠ Precautions on installation and connection

- Mounting and wiring this product requires skills and experience. For best safety, leave the mounting and wiring work to professionals.
- Make sure to ground the unit to a negative 12 V DC power supply.
- Do not install the unit in a spot exposed to direct sunlight or excessive heat or humidity. Also avoid places with too much dust or the possibility of water splashing.
- Do not use your own screws. Use only the screws provided. If you use the wrong screws, you could damage the unit.
- If the power is not turned on ("Miswiring DC Offset Error", "Warning DC Offset Error" is displayed), the speaker wire may have a short circuit or have touched the chassis of the vehicle and the protection function may have been activated. Therefore, the speaker wire should be checked.

- If your car's ignition does not have an ACC position, connect the ignition wires to a power source that can be turned on and off with the ignition key. If you connect the ignition wire to a power source with a constant voltage supply, such as with battery wires, the battery may be drained.
- Only for DDX7035BT/DDX7035BTM: If the console has a lid, make sure to install the unit so that the monitor panel will not hit the lid when closing and opening.
- If the fuse blows, first make sure the wires are not touching to cause a short circuit, then replace the old fuse with one with the same rating.
- Insulate unconnected wires with vinyl tape or other similar material. To prevent a short circuit, do not remove the caps on the ends of the unconnected wires or the terminals.
- Connect the speaker wires correctly to the terminals to which they correspond. The unit may be damaged or fail to work if you share the ⊖ wires or ground them to any metal part in the car.
- When only two speakers are being connected to the system, connect both connectors either to the front output terminals or to the rear output terminals (do not mix front and rear). For example, if you connect the ⊕ connector of the left speaker to a front output terminal, do not connect the ⊖ connector to a rear output terminal.
- After the unit is installed, check whether the brake lamps, blinkers, wipers, etc. on the car are working properly.
- Mount the unit so that the mounting angle is 30° or less.
- Do not press hard on the panel surface when installing the unit to the vehicle. Otherwise scars, damage, or failure may result.

- This unit has a cooling fan to decrease the internal temperature. Do not mount the unit in a place where the cooling fan of the unit is blocked. Blocking these openings will prevent the cooling of the internal temperature and result in malfunction.

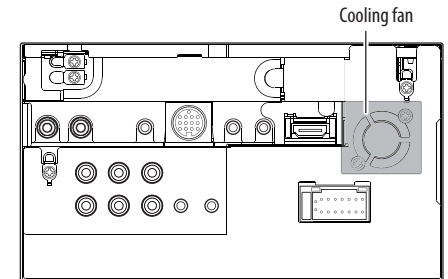

⚠ CAUTION

Install this unit in the console of your vehicle. Do not touch the metal part of this unit during and shortly after the use of the unit. Metal parts such as the heat sink and enclosure become hot.

CONNECTION/INSTALLATION

❑ Supplied accessories for installation

- ① Wiring harness x 1
- ② Trim plate* x 1
- ③ Extension wire x 1
- ④ Flat head screws (M5 x 7 mm) x 6
- ⑤ Round head screws (M5 x 6 mm) x 6
- ⑥ Steering Remote cable x 1
- ⑦ Microphone x 1
- ⑧ Fixture for HDMI/MHL connector x 1
- ⑨ Screws for fixture (M2.6 x 6 mm) x 1

* Only for DDX7035BT Region 4/DDX5035BT Region 4

❑ Installation procedure

- 1 To prevent a short circuit, remove the key from the ignition and disconnect the ⊖ battery.
- 2 Make the proper input and output wire connections for each unit.
- 3 Connect the speaker wires of the wiring harness.
- 4 Connect the wiring harness wires in the following order: ground, battery, ignition.
- 5 Connect the wiring harness connector to the unit.
- 6 Install the unit in your car.
 - Make sure that the unit is installed securely in place. If the unit is unstable, it may malfunction (eg, the sound may skip).
- 7 Reconnect the ⊖ battery.
- 8 Press the reset button.
- 9 Configure <Initial Setup>. (Page 4)

Installing the unit

❑ Installing the unit using the mounting bracket removed from the car

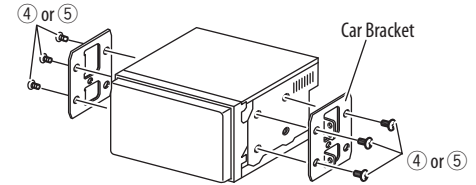

- Select the appropriate type of screw for the mounting bracket: flat head (④) or round head (⑤).

❑ Installing the trim plate (Only for DDX7035BT Region 4/DDX5035BT Region 4)

- 1 Attach the trim plate (②).

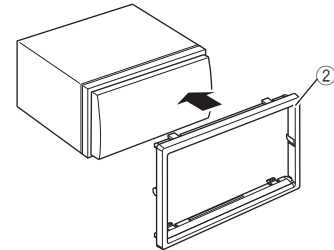

CONNECTION/INSTALLATION

Connection

Connecting wires to terminals

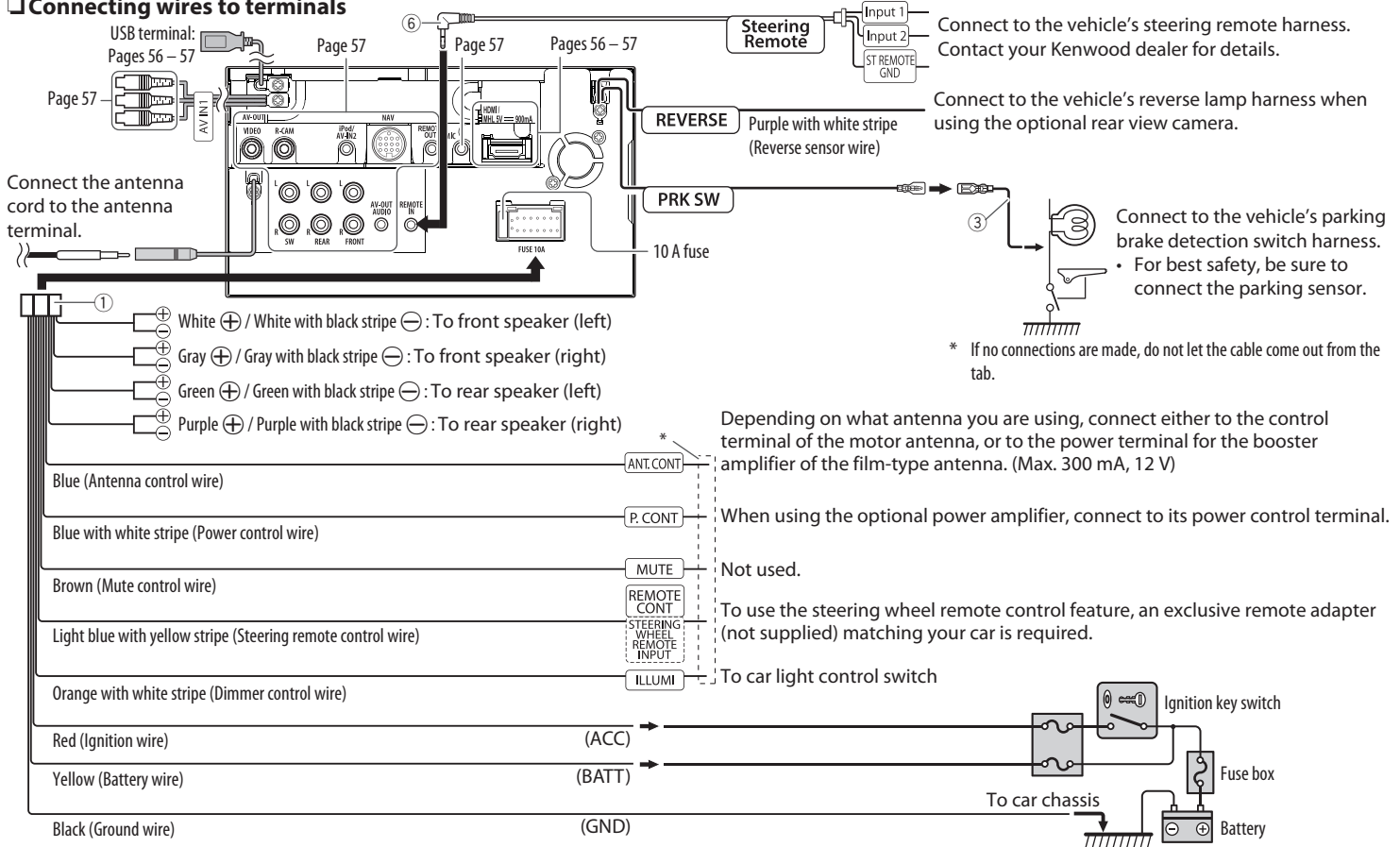

CONNECTION/INSTALLATION

❑ Connecting a USB device

USB device*
(commercially available)

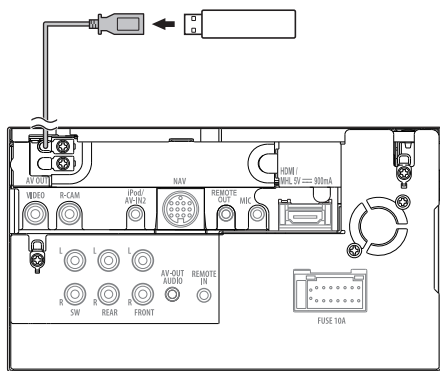

* Use CA-U1EX for extending the cable if necessary. (Max 500 mA, 5V)

❑ Connecting an iPod/iPhone

iPod/iPhone except for iPhone 5/iPod touch (5th Generation)/iPod nano (7th Generation)
(commercially available)

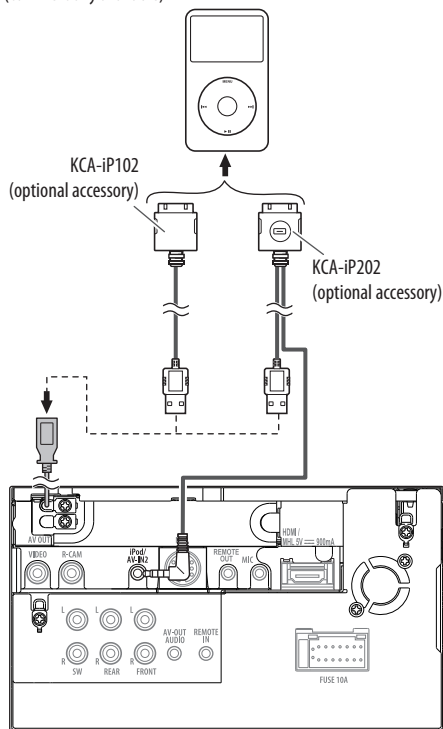

iPhone 5/iPod touch (5th Generation)/iPod nano (7th Generation)
(commercially available)

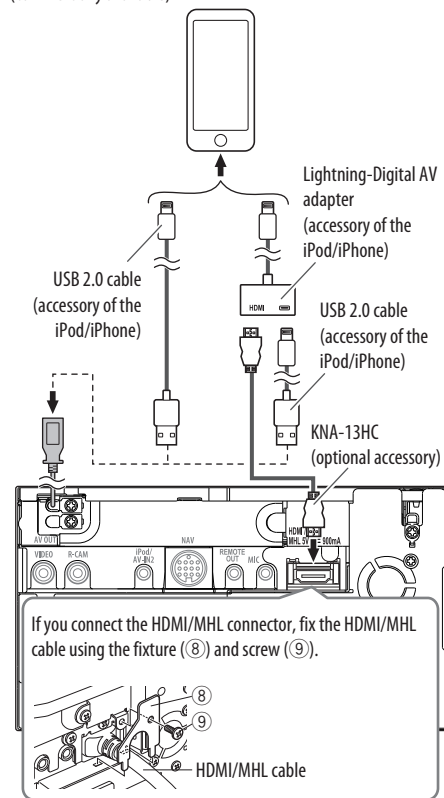

CONNECTION/INSTALLATION

❑ Connecting a Smartphone

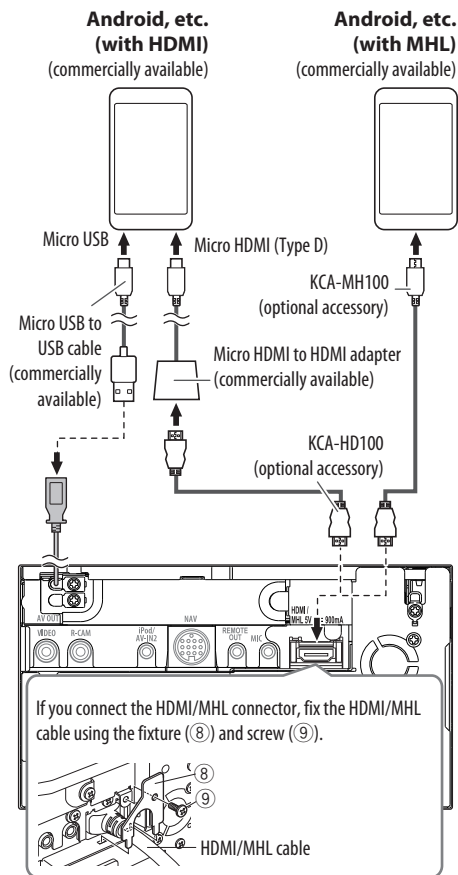

❑ Connecting external components

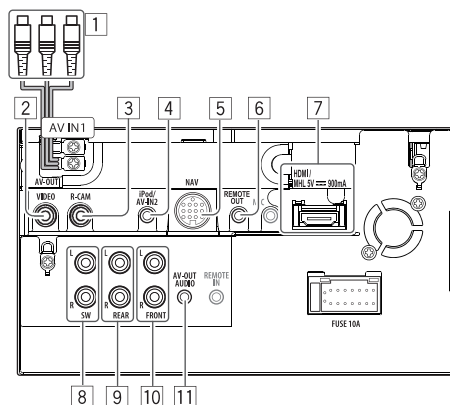

- 1 Audio Video input (AV-IN1)
 - Visual input (Yellow)
 - Audio left input (White)
 - Audio right input (Red)
- 2 AV-OUT/video output (Yellow)
- 3 Rear view camera input (Yellow)
- 4 iPod/Audio Visual input (iPod/AV-IN2)*
- 5 NAVI I/F input
- 6 TV tuner remote control output
- 7 HDMI/MHL input
- 8 Subwoofer preout (monaural output)
 - Subwoofer left output (White)
 - Subwoofer right output (Red)
- 9 Rear preout
 - Audio left output (White)
 - Audio right output (Red)
- 10 Front preout
 - Audio left output (White)
 - Audio right output (Red)

- 11 Audio output (ø3.5 mini jack)
Resistance-free stereo type mini plug

* When connecting the component to play on "AV-IN1" or "AV-IN2", use the Audio and Video cable CA-C3AV (optional accessory).

❑ Connecting microphone for Bluetooth

Connect the microphone (7) to the MIC terminal.

- To install the microphone, peel off the adhesive tape, fix on the installation position, then adjust the direction of the microphone to face the driver. After installing, fix the microphone cable to the car with clamps (commercially available).

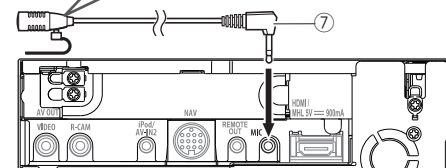
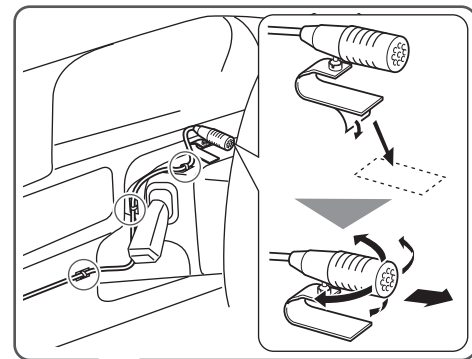

REFERENCES

Maintenance

❑ Caution on cleaning the unit

Do not use any solvent (for example, thinner, benzine, etc.), detergent, or insecticide. This may damage the monitor or the unit.

Recommended cleaning method:

Gently wipe the panel with a soft, dry cloth.

❑ Moisture condensation

Moisture may condense on the lens inside the unit in the following cases:

- After starting the heater in the car.
- If it becomes very humid inside the car.

Should this occur, the unit may malfunction. In this case, eject the disc and leave the unit turned on for a few hours until the moisture evaporates.

❑ How to handle discs

- When removing a disc from its case, press down the center holder of the case and lift the disc out, holding it by the edges.



- Always hold the disc by the edges. Do not touch its recording surface.
- When storing a disc in its case, gently insert the disc around the center holder (with the printed surface facing up).
 - Make sure to store discs in their cases after use.

❑ To keep discs clean

Dirty discs may not play correctly.

If a disc does become dirty, wipe it with a soft cloth in a straight line from the center to the edge.



- Do not use any solvents (for example, conventional record cleaner, spray, thinner, benzine, etc.) to clean discs.

❑ To play new discs

New discs may have some rough spots around the inner and outer edges. If such a disc is used, this unit may reject the disc.



- To remove these rough spots, rub the edges with a pencil or ball-point pen, etc.

More information

❑ File playback

Playing DivX files (for discs only)

- This unit can play back DivX files with the extension code <.divx>, <.div>, or <.avi> (regardless of the letter case—upper/lower).
- Audio streams should conform to MP3 or Dolby Digital.
- Files encoded in the interlaced scanning mode may not be played back correctly.
- The maximum bit rate for video signals (average) is 8 Mbps.

Playing MPEG1/MPEG2 files

- This unit can play back MPEG1/MPEG2 files with the extension code <.mpg> or <.mpeg>.
- The stream format should conform to MPEG system/program stream.
The file format should be MP@ML (Main Profile at Main Level)/SP@ML (Simple Profile at Main Level)/MP@LL (Main Profile at Low Level).
- Audio streams should conform to MPEG1 Audio Layer-2 or Dolby Digital.

Playing JPEG/BMP/PNG files (for USB only)

- This unit can play back picture files with the extension code <.jpg>, <.jpeg>, <.bmp> or <.png>.
- This unit can play back files that are at 32 x 32 to 8 192 x 7 680 (PNG: 800 x 480) resolution. It may take time to display the file depending on its resolution.
- This unit can play back baseline JPEG files. Progressive JPEG files or lossless JPEG files cannot be played.

REFERENCES

Playing audio files (for discs: MP3/WMA/AAC-LC, for USB: MP3/WMA/WAV/AAC-LC/FLAC)

- This unit can play back files with the extension code <.mp3>, <.wma>, <.wav>, <.m4a> or <.flac> (regardless of the letter case—upper/lower).
- This unit can play back files that meet the conditions below:
 - Bit rate:
 - MP3: 8 kbps – 320 kbps
 - WMA: 48 kbps – 192 kbps
 - AAC: For discs: 16 kbps – 320 kbps
 - For USB: 32 kbps – 320 kbps
 - Sampling frequency:
 - MP3: 8 kHz – 48 kHz
 - WMA: For discs: 32 kHz – 48 kHz
 - For USB: 8 kHz – 48 kHz
 - WAV: 44.1 kHz
 - AAC: 16 kHz – 48 kHz
 - FLAC : 8 kHz – 48 kHz
- This unit can show ID3 Tag Version 1.0/1.1/2.2/3/2.4 (for MP3).
- This unit can also show WMA/AAC/FLAC Tag.
- This unit can play back files recorded in VBR (variable bit rate).
- Files recorded in VBR have a discrepancy in elapsed time indication.

- This unit cannot play back the following files:
 - MP3 files encoded with MP3i and MP3 PRO format.
 - MP3 files encoded with Layer 1/2.
 - WMA files encoded with lossless, professional, and voice format.
 - WMA files which are not based upon Windows Media® Audio.
 - WMA/AAC files copy-protected with DRM.
 - AAC files encoded using any other application than iTunes.
 - AAC files copy-protected with FairPlay (except those stored on an iPod).
 - Files which have data such as AIFF, ATRAC3, etc.
- This unit can display jacket pictures that meet the conditions below:
 - Picture size: 32 x 32 to 1 232 x 672 resolution
 - Data size: less than 650 KB.
 - File type: JPEG/PNG/BMP

Playing H.264/WMV files (for USB only)

- This unit can play back files with the extension code <.mp4>, <.wmv> or <.mkv>.
- The stream format should conform to MPEG system/program stream.

Disc playback Playable disc types

Disc type	Recording format, file type, etc.
DVD	DVD Video*1
<ul style="list-style-type: none"> DTS sound cannot be reproduced or emitted from this unit. 	
DVD Recordable/Rewritable (DVD-R/-RW*2, +R/+RW*3)	<ul style="list-style-type: none"> DVD Video DVD-VR*4 DivX/MPEG1/MPEG2 MP3/WMA/AAC
<ul style="list-style-type: none"> DVD Video: UDF bridge DVD-VR DivX/MPEG1/MPEG2/MP3/WMA/AAC: ISO 9660 level 1, level 2, Romeo, Joliet 	
Dual Disc	DVD side
CD/VCD	<ul style="list-style-type: none"> VCD (Video CD) Audio CD/CD Text (CD-DA)
CD Recordable/Rewritable (CD-R/-RW)	<ul style="list-style-type: none"> VCD (Video CD) CD-DA MPEG1/MPEG2 MP3/WMA/AAC

*1 DVD Region code:

For DDX7035BT/DDX5035BT: 3/4 (depending on the country and sales area)

For DDX7035BTM/DDX5035BTM: 2

If you insert a DVD Video disc of an incorrect Region Code, "Region Code Error" appears on the screen.

*2 DVD-R recorded in multi-border format are also playable (except for dual layer discs). DVD-RW dual layer discs are not playable.

*3 It is possible to play back finalized +R/+RW (Video format only) discs. "DVD" is selected as the disc type when a +R/+RW disc is loaded. +RW double layer discs are not playable.

*4 This unit cannot play back content protected with CPM.

REFERENCES

Unplayable discs

- Unplayable disc types and formats are as follows:
 - DVD-Audio/DVD-ROM discs
 - MPEG4/JPEG/FLAC/MKV/DVD+VR/DVD-RAM recorded on DVD-R/RW or +R/+RW
 - SVCD (Super Video CD), CD-ROM, CD-I (CD-I Ready), DTS-CD
 - MPEG4/JPEG/FLAC/MKV recorded on CD-R/RW
- Discs that are not round.
- Discs with coloring on the recording surface or discs that are dirty.
- Recordable/ReWritable discs that have not been finalized.
- 8 cm discs. Attempting to insert these discs using an adapter may cause malfunction.

DualDisc playback

The Non-DVD side of a “DualDisc” does not comply with the “Compact Disc Digital Audio” standard. Therefore, the use of Non-DVD side of a DualDisc on this product cannot be recommended.

Playing Recordable/Rewritable discs

- This unit can recognize a total of 64 770 files and 254 folders (a maximum of 255 files per folder).
- Use only “finalized” discs.
- This unit can play back multi-session discs; however, unclosed sessions will be skipped while playing.
- Some discs or files may not be played back due to their characteristics or recording conditions.

□ About data stored in the connected USB device/iPod/iPhone

- We bear no responsibility for any loss of data in an iPod/iPhone and USB mass storage class device while using this unit.

□ USB playback

Playable files on a USB device

- This unit can play the following types of files stored in a USB mass storage class device.
 - JPEG/BMP/PNG/MPEG1/MPEG2/MP3/WMA/WAV/AAC/FLAC/H.264/WMV (VC-1)
- This unit can recognize a total of 5 000 files and 250 folders (a maximum of 999 files per folder).
- Make sure all important data has been backed up to avoid losing the data.

Notes on using a USB device:

- This unit may not play back files in a USB device properly when using a USB extension cable.
- USB devices equipped with special functions such as data security functions cannot be used with the unit.
- Do not use a USB device with 2 or more partitions.
- Depending on the shape of the USB devices and connection ports, some USB devices may not be attached properly or the connection might be loose.
- This unit may not recognize a memory card inserted into the USB card reader.
- When connecting with a USB cable, use the USB 2.0 cable.

- The maximum number of characters (when the characters are 1 byte):
 - Folder names: 128 characters
 - File names: 128 characters
- Avoid using the USB device if it might affect driving safety.
- Do not pull out and connect the USB device repeatedly while “Reading...” is shown on the screen.
- Electrostatic shock at connecting a USB device may cause abnormal playback of the device. In this case, disconnect the USB device then reset this unit and the USB device.
- Operation and power supply may not work as intended for some USB devices.
- Do not leave a USB device in the car, or expose to direct sunlight or high temperatures to prevent deformation or damage to the device.

REFERENCES

❑ Notes on playing iPod/iPhone

- iPod/iPhone that can be connected to this unit:
Made for
 - iPod with video
 - iPod classic
 - iPod nano (7th Generation)
 - iPod nano (6th Generation)
 - iPod nano (5th Generation)
 - iPod nano (4th Generation)
 - iPod nano (3rd Generation)
 - iPod touch (5th Generation)
 - iPod touch (4th Generation)
 - iPod touch (3rd Generation)
 - iPod touch (2nd Generation)
 - iPod touch (1st Generation)
 - iPhone 5
 - iPhone 4S
 - iPhone 4
 - iPhone 3GS
 - iPhone 3G
 - iPhone
- When operating an iPod/iPhone, some operations may not be performed correctly or as intended. In this case, visit the following KENWOOD web site: <www.kenwood.com/cs/ce/ipod>
- For some iPod/iPhone models, the performance may be abnormal or unstable during operation. In this case, disconnect the iPod/iPhone device, then check its condition.
If the performance is not improved or slow, reset your iPod/iPhone.
- When you turn on this unit, the iPod/iPhone is charged through the unit.
- The text information may not be displayed correctly.

❑ Language codes (for DVD/DVD-VR language selection)

AA	Afar	GL	Galician	MI	Maori	SO	Somali
AB	Abkhazian	GN	Guarani	MK	Macedonian	SQ	Albanian
AF	Afrikaans	GU	Gujarati	ML	Malayalam	SR	Serbian
AM	Ameharic	HA	Hausa	MN	Mongolian	SS	Siswati
AR	Arabic	HI	Hindi	MO	Moldavian	ST	Sesotho
AS	Assamese	HR	Croatian	MR	Marathi	SU	Sundanese
AY	Aymara	HU	Hungarian	MS	Malay (MAY)	SW	Swahili
AZ	Azerbaijani	HY	Armenian	MT	Maltese	TA	Tamil
BA	Bashkir	IA	Interlingua	MY	Burmese	TE	Telugu
BE	Byelorussian	IE	Interlingue	NA	Nauru	TG	Tajik
BG	Bulgarian	IK	Inupiak	NE	Nepali	TH	Thai
BH	Bihari	IN	Indonesian	NO	Norwegian	TI	Tigrinya
BI	Bislama	IS	Icelandic	OC	Occitan	TK	Turkmen
BN	Bengali, Bangla	IW	Hebrew	OM	(Afan) Oromo	TL	Tagalog
BO	Tibetan	JA	Japanese	OR	Oriya	TN	Setswana
BR	Breton	JL	Yiddish	PA	Panjabi	TO	Tonga
CA	Catalan	JW	Javanese	PL	Polish	TR	Turkish
CO	Corsican	KA	Georgian	PS	Pashto, Pushto	TS	Tsonga
CS	Czech	KK	Kazakh	QU	Quechua	TT	Tatar
CY	Welsh	KL	Greenlandic	RM	Rhaeto-Romance	TW	Twi
DZ	Bhutani	KM	Cambodian	RN	Kirundi	UK	Ukrainian
EL	Greek	KN	Kannada	RO	Rumanian	UR	Urdu
EO	Esperanto	KO	Korean (KOR)	RW	Kinyarwanda	UZ	Uzbek
ET	Estonian	KS	Kashmiri	SA	Sanskrit	VI	Vietnamese
EU	Basque	KU	Kurdish	SD	Sindhi	VO	Volapuk
FA	Persian	KY	Kirghiz	SG	Sangho	WO	Wolof
FI	Finnish	LA	Latin	SH	Serbo-Croatian	XH	Xhosa
FJ	Fiji	LN	Lingala	SI	Singhalese	YO	Yoruba
FO	Faroese	LO	Laothian	SK	Slovak	ZU	Zulu
FY	Frisian	LT	Lithuanian	SL	Slovenian		
GA	Irish	LV	Latvian, Lettish	SM	Samoan		
GD	Scots Gaelic	MG	Malagasy	SN	Shona		

REFERENCES

Error message list

If an error occurs while using the unit, a message appears. Take appropriate action according to the following message/remedy/cause list.

“No Signal”/“No Video Signal”:

- Start playback on the external component connected to the AV-IN1 or iPod/AV-IN2 input terminal.
- Start playback on the smartphone connected to HDMI/MHL input terminal.
- Check the cords and connections.
- Signal input is too weak.

“Miswiring DC Offset Error”/“Warning DC Offset Error”:

- A speaker cord has shorted or it has come into contact with the car chassis. Wire or insulate the speaker cord as appropriate, then reset the unit. (Pages 3 and 55)

“Parking off”:

- No playback picture is shown when the parking brake is not engaged.

“Authorization Error”:

- Check whether the connected iPod/iPhone is compatible with this unit. (Page 61)

“USB Device Error”:

- The USB power voltage is abnormal.
- Turn off and turn on the unit.
- Connect another USB device.

“Panel Mecha Error”:

- The panel does not work properly. Reset the unit.

“No Navigation”:

- No navigation unit is connected.

“ConnectionEr ror”:

- The device is registered but the connection has failed. Connect the registered device. (Page 31)

“Please Wait...”:

- The unit is preparing to use the Bluetooth function. If the message does not disappear, turn off and turn on the unit, then connect the device again (or reset the unit).

“No Voice Device”:

- The connected mobile phone does not have a voice recognition system.

“No Data”:

- No phone book data is contained in the connected Bluetooth phone.

“InitializeEr ror”:

- The unit has failed to initialize the Bluetooth module. Try the operation again.

“Dial Error”:

- Dialing has failed. Try the operation again.

“Hung Up Error”:

- The call has not ended yet. Park your car, and use the connected mobile phone to end the call.

“Pick Up Error”:

- The unit has failed to receive a call.

“Pandora upgrade required”:

- The Pandora application on your iPod touch/iPhone/Android/BlackBerry is not the latest version. Update the application.

“Check App”:

- The Pandora application on your iPod touch/iPhone/Android/BlackBerry is not started up.
- The Pandora application is not installed in the connected device.
- An error has occurred on the Pandora application.
- You have not signed in to Pandora.

REFERENCES

“Cannot Skip”:

- No more songs can be skipped.

“Rating Failed”:

- Thumb-up/down is prohibited.

“No Station”:

- No station is available.

“No Active Station”:

- No station is being played.

“Cannot create a station”:

- The registration of the stations to the Station List is full.

“Failed to save your bookmark”:

- The unit has failed to bookmark. Try the operation again.

Troubleshooting

What appears to be trouble is not always serious. Check the following points before calling a service center.

- For operations with the external components, refer also to the instructions supplied with the adapters used for the connections (as well as the instructions supplied with the external components).

□ General

No sound comes out of the speakers.

- Adjust the volume to the optimum level.
- Check the cords and connections.

No picture is displayed on the screen.

- Turn on the screen. (Page 8)

The unit does not work at all.

- Reset the unit. (Page 3)

The remote controller* does not work.

- Replace the battery.

* For DDX7035BT Region 4/DDX5035BT Region 4: Purchase KNA-RCOV331 separately.

□ Discs

Recordable/Rewritable discs cannot be played back.

- Insert a finalized disc.
- Finalize the discs with the component which you used for recording.

Tracks on the Recordable/Rewritable discs cannot be skipped.

- Insert a finalized disc.
- Finalize the discs with the component which you used for recording.

Playback does not start.

- The format of files is not supported by the unit.

No picture appears on the external monitor.

- Connect the video cord correctly.
- Select the correct input on the external monitor.

DivX/MPEG1/MPEG2/MP3/WMA/AAC disc cannot be played back.

- Record the tracks using a compliant application on the appropriate discs. (Page 59)
- Add appropriate extension codes to the file names.

Tracks on the Recordable/Rewritable discs are not played back as you have intended them to play.

- Playback order may differ from the one played back using other players.

REFERENCES

❑ USB

“Reading...” does not disappear from the screen.

- Turn the power off and on again.

While playing a track, sound is sometimes interrupted.

- The tracks are not properly copied into the USB device. Copy the tracks again, and try again.

Tracks are not played back as you have intended them to play.

- Playback order may differ from the one played back using other players.

❑ iPod/iPhone

No sound comes out of the speakers.

- Disconnect the iPod/iPhone, then connect it again.
- Select another source, then reselect “iPod”.

The iPod/iPhone does not turn on or does not work.

- Check the connecting cable and its connection.
- Update the firmware version.
- Charge the battery.
- Reset the iPod/iPhone.

Sound is distorted.

- Deactivate the equalizer either on this unit or the iPod/iPhone.

A lot of noise is generated.

- Turn off (uncheck) “VoiceOver” on the iPod/iPhone. For details, visit <<http://www.apple.com>>.

No operations are available when playing back a track containing Artwork.

- Operate the unit after the Artwork is loaded.

Videos cannot be played.

- Connect with USB Audio and Video cable KCA-iP202 for iPod/iPhone except for iPhone 5/iPod touch (5th Generation)/iPod nano (7th Generation) or KCA-HD100 and USB2.0 cable through Lightning-Digital AV adapter for iPhone 5/iPod touch (5th Generation)/iPod nano (7th Generation) . Other cables cannot be used.

No sound of videos comes out.

- Connect with USB Audio and Video cable KCA-iP202 for iPod/iPhone except for iPhone 5/iPod touch (5th Generation)/iPod nano (7th Generation) or KCA-HD100 and USB2.0 cable through Lightning-Digital AV adapter for iPhone 5/iPod touch (5th Generation)/iPod nano (7th Generation). Other cables cannot be used.

❑ Tuner

AME automatic presetting does not work.

- Store stations manually. (Page 23)

Static noise while listening to the radio.

- Connect the antenna firmly.

❑ AV-IN1/AV-IN2

No picture appears on the screen.

- Turn on the video component if it is not on.
- Connect the video component correctly.

❑ Pandora (Only for DDX7035BT Region 4/DDX5035BT Region 4)

The application does not work.

- The application on your iPod touch/iPhone/Android is not the latest version. Update the application.

❑ Bluetooth

Phone sound quality is poor.

- Reduce the distance between the unit and the Bluetooth mobile phone.
- Move the car to a place where you can get a better signal reception.

The sound is interrupted or skipped while using a Bluetooth audio player.

- Reduce the distance between the unit and the Bluetooth audio player.
- Disconnect the device connected for Bluetooth phone.
- Turn off, then turn on the unit.
- (When the sound is not yet restored) connect the player again.

REFERENCES

The connected audio player cannot be controlled.

- Check whether the connected audio player supports AVRCP (Audio Video Remote Control Profile).

Bluetooth device does not detect the unit.

- Search from the Bluetooth device again.

The unit does not pair with the Bluetooth device.

- For devices compatible with Bluetooth 2.1: Register the device using a PIN code. (Page 30)
- For devices compatible with Bluetooth 2.0: Enter the same PIN code for both the unit and target device. If the PIN code of the device is not indicated in its instructions, try "0000" or "1234."

Echo or noise occurs.

- Adjust the microphone unit position.
- Adjust the echo volume or noise reduction volume. (Page 32)

The unit does not respond when you try to copy the phone book to the unit.

- You may have tried to copy the same entries (as stored) to the unit.

Specifications

Monitor section

Picture Size (W x H)
DDX7035BT/DDX7035BTM:

6.95 inches (diagonal) wide
156.6 mm x 81.6 mm

DDX5035BT/DDX5035BTM:

6.1 inches (diagonal) wide
136.2 mm x 72 mm

Display System Transparent TN LCD panel

Drive System TFT active matrix system

Number of Pixels 1 152 000 (800H x 480V x RGB)

Effective Pixels 99.99%

Pixel Arrangement

RGB striped arrangement

Back Lighting LED

DVD player section

D/A Converter 24 bit

Audio Decoder Linear PCM/Dolby Digital/MP3/WMA/AAC

Video Decoder MPEG1/MPEG2/DivX

Wow & Flutter Below Measurable Limit

Frequency Response

96 kHz Sampling: 20 Hz to 20 000 Hz

48 kHz Sampling: 20 Hz to 20 000 Hz

44.1 kHz Sampling: 20 Hz to 20 000 Hz

Total Harmonic Distortion

0.010% (1 kHz)

Signal to Noise Ratio

94 dB (DVD-Video 96 kHz)

Dynamic Range

91 dB (DVD-Video 96 kHz)

Disc Format

DVD-Video/DVD-VR/VIDEO-CD/CD-DA

Sampling Frequency

44.1 kHz/48 kHz/96 kHz

Quantifying Bit Number

16/20/24 bit

REFERENCES

❑ USB interface section

USB Standard	USB 2.0 High Speed
File System	FAT 16/32
Maximum Power Supply Current	DC 5 V $\overline{\text{---}}$ 1 A
D/A Converter	24 bit
Video Decoder	MPEG1/MPEG2/H.264/WMV/ JPEG/BMP/PNG
Audio Decoder	MP3/WMA/AAC/WAV/FLAC

❑ HDMI interface section

Connector Type	TYPE-A
----------------	--------

❑ MHL interface section

Supported Version	MHL 2
Maximum Power Supply Current	DC 5 V $\overline{\text{---}}$ 900 mA

❑ Bluetooth section

Technology	Bluetooth 3.0 + EDR
Frequency	2.402 GHz to 2.480 GHz
Output Power	+4 dBm (MAX), 0 dBm (AVE), Power Class 2
Maximum Communication Range	Line of sight approx. 10 m
Audio Codec	SBC/AAC/MP3
Profile	HFP (Hands Free Profile) PBAP (Phonebook Access Profile) A2DP (Advanced Audio Distribution Profile) AVRCP (Audio/Video Remote Control Profile) GAP (Generic Access Profile) SDP (Service Discovery Profile) SPP (Serial Port Profile)

❑ DSP section

Graphics equalizer	
BAND	7 Band
Frequency (Hz) (BAND1-7)	62.5/160/400/1k/2.5k/6.3k/16k
Gain	-9/-8/-7/-6/-5/-4/-3/-2/ -1/0/1/2/3/4/5/6/7/8/9 dB

2 Way X'Over	
HIGH PASS FILTER frequency	Through/50/60/80/100/120/150/ 180/220
SLOPE	-6/-12/-18/-24 dB/Oct.
LOW PASS FILTER frequency	50/60/80/100/120/Through
SLOPE	-6/-12/-18/-24 dB/Oct.
Position	
Front/Rear/Subwoofer Delay	0 cm to 610 cm (2.0 cm Step)
Gain	-8 dB to 0 dB
Subwoofer Level	-50 dB to +10 dB

❑ FM tuner section

Frequency Range (50 kHz)	87.5 MHz to 108.0 MHz
Usable Sensitivity (S/N: 26 dB Dev 22.5 kHz)	9.3 dBf (0.8 μ V/75 Ω)
Quieting Sensitivity (S/N: 46 dB Dev 22.5 kHz)	15.2 dBf (1.6 μ V/75 Ω)
Frequency Response (\pm 3.0 dB)	30 Hz to 15 kHz
Signal to Noise Ratio	75 dB (MONO)
Selectivity (\pm 400 kHz)	\geq 80 dB
Stereo Separation	45 dB (1 kHz)

REFERENCES

❑ AM tuners action

Frequency Range

DDX7035BT Region 4/DDX5035BT Region 4:

AM (9 kHz): 531 kHz to 1 611 kHz

DDX7035BT Region 3/DDX7035BTM/

DDX5035BT Region 3/DDX5035BTM:

LW (9 kHz): 153 kHz – 279 kHz

MW (9 kHz): 531 kHz – 1 611 kHz

Usable Sensitivity

DDX7035BT Region 4/DDX5035BT Region 4:

AM: 28 dB μ

DDX7035BT Region 3/DDX7035BTM/

DDX5035BT Region 3/DDX5035BTM:

LW: 45 μ V

MW: 25 μ V

❑ Video section

Color System of External Video Input

NTSC/PAL

External Video Input Level (RCA/mini jack)

1 V_{p-p}/75 Ω

External Audio Max Input Level (RCA/mini jack)

2 V/25 k Ω

Video Input Level (RCA jacks)

1 V_{p-p}/75 Ω

Video Output Level (RCA jacks)

1 V_{p-p}/75 Ω

Audio Output Level (mini jacks)

1.2 V/10 k Ω

Analog RGB Input 0.7 V_{p-p}/75 Ω

❑ Audio section

Maximum Power (Front & Rear)

50 W \times 4

Full Bandwidth Power (Front & Rear)

(at less than 1% THD)

22 W \times 4

Preout Level

DDX7035BT/DDX7035BTM: 5 V/10 k Ω

DDX5035BT/DDX5035BTM: 4 V/10 k Ω

Preout Impedance

DDX7035BT/DDX7035BTM: \leq 250 Ω

DDX5035BT/DDX5035BTM: \leq 600 Ω

Speaker Impedance

4 Ω to 8 Ω

❑ General

Operating Voltage

14.4 V (10.5 V to 16 V allowable)

Maximum Current Consumption

10 A

Installation Dimensions (W \times H \times D)

178 mm \times 100 mm \times 159 mm

Operational Temperature Range

-10°C to +60°C

Weight

DDX7035BT/DDX7035BTM:

2.5 kg

DDX5035BT/DDX5035BTM:

2.0 kg

Design and specifications are subject to change without notice.

❑ Trademarks and licenses

- Manufactured under license from Dolby Laboratories. Dolby and the double-D symbol are trademarks of Dolby Laboratories.
- “DVD Logo” is a trademark of DVD Format/Logo Licensing Corporation registered in the US, Japan and other countries.
- The “AAC” logo is a trademark of Dolby Laboratories.
- Microsoft and Windows Media are either registered trademarks or trademarks of Microsoft Corporation in the United States and/or other countries.
- “Made for iPod,” and “Made for iPhone” mean that an electronic accessory has been designed to connect specifically to iPod, or iPhone, respectively, and has been certified by the developer to meet Apple performance standards. Apple is not responsible for the operation of this device or its compliance with safety and regulatory standards. Please note that the use of this accessory with iPod, or iPhone may affect wireless performance. iPhone, iPod, iPod classic, iPod nano, and iPod touch are trademarks of Apple Inc., registered in the U.S. and other countries.
- Lightning is a trademark of Apple Inc.
- This item incorporates copy protection technology that is protected by U.S. patents and other intellectual property rights of Rovi Corporation. Reverse engineering and disassembly are prohibited.
- Font for this product is designed by Ricoh.

REFERENCES

- DivX®, DivX Certified® and associated logos are trademarks of Rovi Corporation or its subsidiaries and are used under license.
 - ABOUT DIVX VIDEO: DivX® is a digital video format created by DivX, LLC, a subsidiary of Rovi Corporation. This is an official DivX Certified® device that plays DivX video. Visit divx.com for more information and software tools to convert your files into DivX videos.
 - ABOUT DIVX VIDEO-ON-DEMAND: This DivX Certified® device must be registered in order to play purchased DivX Video-on-Demand (VOD) movies. To obtain your registration code, locate the DivX VOD section in your device setup menu. Go to vod.divx.com for more information on how to complete your registration.
 - THIS PRODUCT IS LICENSED UNDER THE MPEG-4 VISUAL PATENT PORTFOLIO LICENSE FOR THE PERSONAL AND NON-COMMERCIAL USE OF A CONSUMER FOR (i) ENCODING VIDEO IN COMPLIANCE WITH THE MPEG-4 VISUAL STANDARD ("MPEG-4 VIDEO") AND/OR (ii) DECODING MPEG-4 VIDEO THAT WAS ENCODED BY A CONSUMER ENGAGED IN A PERSONAL AND NON-COMMERCIAL ACTIVITY AND/OR WAS OBTAINED FROM A VIDEO PROVIDER LICENSED BY MPEG LA TO PROVIDE MPEG-4 VIDEO. NO LICENSE IS GRANTED OR SHALL BE IMPLIED FOR ANY OTHER USE. ADDITIONAL INFORMATION INCLUDING THAT RELATING TO PROMOTIONAL, INTERNAL AND COMMERCIAL USES AND LICENSING MAY BE OBTAINED FROM MPEG LA, LLC. SEE [HTTP://WWW.MPEGLA.COM](http://www.mpegla.com).
 - THIS PRODUCT IS LICENSED UNDER THE AVC PATENT PORTFOLIO LICENSE FOR THE PERSONAL USE OF A CONSUMER OR OTHER USES IN WHICH IT DOES NOT RECEIVE REMUNERATION TO
 - (i) ENCODE VIDEO IN COMPLIANCE WITH THE AVC STANDARD ("AVC VIDEO") AND/OR (ii) DECODE AVC VIDEO THAT WAS ENCODED BY A CONSUMER ENGAGED IN A PERSONAL ACTIVITY AND/OR WAS OBTAINED FROM A VIDEO PROVIDER LICENSED TO PROVIDE AVC VIDEO. NO LICENSE IS GRANTED OR SHALL BE IMPLIED FOR ANY OTHER USE. ADDITIONAL INFORMATION MAY BE OBTAINED FROM MPEG LA, L.L.C. SEE [HTTP://WWW.MPEGLA.COM](http://www.mpegla.com)
 - Pandora, the Pandora logo, and the Pandora trade dress are trademarks or registered trademarks of Pandora Media, Inc., used with permission.
 - Android is a trademark of Google Inc.
 - BlackBerry®, RIM®, Research In Motion® and related trademarks, names and logos are the property of Research In Motion Limited and are registered and/or used in the U.S. and countries around the world. Used under license from Research In Motion Limited.
 - The Bluetooth® word mark and logos are registered trademarks owned by Bluetooth SIG, Inc. and any use of such marks by JVC KENWOOD Corporation is under license. Other trademarks and trade names are those of their respective owners.
 - The terms HDMI and HDMI High-Definition Multimedia Interface, and the HDMI logo are trademarks or registered trademarks of HDMI Licensing LLC in the United States and other countries.
 - MHL and the MHL logo are a trademark or registered trademark of MHL, LLC.
 - Incorporates MHL 2
 - libFLAC
 - Copyright (C) 2000,2001,2002,2003,2004,2005,2006,2007,2008,2009 Josh Coalson
- Redistribution and use in source and binary forms, with or without modification, are permitted provided that the following conditions are met:
- Redistributions of source code must retain the above copyright notice, this list of conditions and the following disclaimer.
 - Redistributions in binary form must reproduce the above copyright notice, this list of conditions and the following disclaimer in the documentation and/or other materials provided with the distribution.
 - Neither the name of the Xiph.org Foundation nor the names of its contributors may be used to endorse or promote products derived from this software without specific prior written permission.
- THIS SOFTWARE IS PROVIDED BY THE COPYRIGHT HOLDERS AND ONTRIBUTORS ``AS IS'' AND ANY EXPRESS OR IMPLIED WARRANTIES, INCLUDING, BUT NOT LIMITED TO, THE IMPLIED WARRANTIES OF MERCHANTABILITY AND FITNESS FOR A PARTICULAR PURPOSE ARE DISCLAIMED. IN NO EVENT SHALL THE FOUNDATION OR CONTRIBUTORS BE LIABLE FOR ANY DIRECT, INDIRECT, INCIDENTAL, SPECIAL, EXEMPLARY, OR CONSEQUENTIAL DAMAGES (INCLUDING, BUT NOT LIMITED TO, PROCUREMENT OF SUBSTITUTE GOODS OR SERVICES; LOSS OF USE, DATA, OR PROFITS; OR BUSINESS INTERRUPTION) HOWEVER CAUSED AND ON ANY THEORY OF LIABILITY, WHETHER IN CONTRACT, STRICT LIABILITY, OR TORT (INCLUDING NEGLIGENCE OR OTHERWISE) ARISING IN ANY WAY OUT OF THE USE OF THIS SOFTWARE, EVEN IF ADVISED OF THE POSSIBILITY OF SUCH DAMAGE.

Free Manuals Download Website

<http://myh66.com>

<http://usermanuals.us>

<http://www.somanuals.com>

<http://www.4manuals.cc>

<http://www.manual-lib.com>

<http://www.404manual.com>

<http://www.luxmanual.com>

<http://aubethermostatmanual.com>

Golf course search by state

<http://golfingnear.com>

Email search by domain

<http://emailbydomain.com>

Auto manuals search

<http://auto.somanuals.com>

TV manuals search

<http://tv.somanuals.com>