

KENWOOD

DDX7015BT DDX5902 DDX715WBT

MONITOR WITH DVD RECEIVER INSTRUCTION MANUAL

JVC KENWOOD Corporation



(((SiriusXM)))
READY

DIIX

HDMI™
HIGH-DEFINITION MULTIMEDIA INTERFACE

MHL
Mobile High-Definition Link



HD Radio®
This HD Radio receiver enables:

PSD

HD2/HD3

Digital Sound

Artist Experience

Take the time to read through this instruction manual.

Familiarity with installation and operation procedures will help you obtain the best performance from your new DVD-receiver.

For your records

Record the serial number, found on the back of the unit, in the spaces designated on the warranty card, and in the space provided below. Refer to the model and serial numbers whenever you call upon your Kenwood dealer for information or service on the product.

Model DDX7015BT/DDX5902/DDX715WBT Serial number _____

US Residents Only

Register Online

Register your Kenwood product at www.Kenwoodusa.com

CONTENTS

BEFORE USE	2	Using a smartphone—HDMI/MHL.....	43
How to reset your unit.....	3	Using an external component via ADS adapter— OEM Features (Only for DDX5902).....	43
INITIAL SETTINGS	4	BLUETOOTH	44
BASICS	6	SETTINGS	52
Component names and functions	6	Settings for using applications of iPod/iPhone/ Android	52
Common operations.....	8	Sound adjustment	53
Common screen operations.....	9	Adjustment for video playback.....	55
Selecting the playback source.....	11	Changing the display design.....	57
DISCS	12	Customizing the <TOP MENU> screen	58
USB	17	Customizing the system settings	58
iPod/iPhone	18	Setting menu items.....	60
APPS	22	REMOTE CONTROLLER	63
Pandora® (Only for DDX5902)	23	CONNECTION/INSTALLATION	66
iHeartRADIO (Only for DDX5902)	25	REFERENCES	73
AUPEO!	27	Maintenance	73
TUNER (Only for DDX7015BT/DDX715WBT)	29	More information.....	73
HD Radio™ tuner (Only for DDX5902)	31	Error message list.....	77
SiriusXM® Satellite Radio (Only for DDX5902)	34	Troubleshooting.....	78
OTHER EXTERNAL COMPONENTS	41	Specifications.....	80
Using external audio/video players—AV-IN	41		
Using a rear view camera	41		

How to read this manual:

- Illustrations of DDX5902 are mainly used for explanation. The displays and panels shown in this manual are examples used to provide clear explanations of the operations. For this reason, they may be different from the actual displays or panels.
- This manual mainly explains operations using the buttons on the monitor panel and touch panel. For operations using the remote controller (RC-DV340: supplied only for DDX7015BT/DDX715WBT), see page 63.
- < > indicates the various screens/menus/operations/settings that appear on the touch panel.
- [] indicates the buttons on the touch panel.
- **Indication language:** English indications are used for the purpose of explanation. You can select the indication language from the <Setup> menu. (Page 62)
- Updated information (the latest Instruction Manual, system updates, new functions, etc.) is available from <<http://www.kenwood.com/cs/ce/>>.

BEFORE USE

IMPORTANT

To ensure proper use, please read through this manual before using this product. It is especially important that you read and observe WARNINGS and CAUTIONS in this manual. Please keep the manual in a safe and accessible place for future reference.

⚠ **WARNINGS: (To prevent accidents and damage)**

- DO NOT install any unit or wire any cable in a location where;
 - it may obstruct the steering wheel and gearshift lever operations.
 - it may obstruct the operation of safety devices such as air bags.
 - it may obstruct visibility.
- DO NOT operate the unit while driving. If you need to operate the unit while driving, be sure to look around carefully.
- The driver must not watch the monitor while driving.

For DDX7015BT/DDX715WBT: The marking of products using lasers

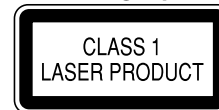

The label is attached to the chassis/case and says that the component uses laser beams that have been classified as Class 1. It means that the unit is utilizing laser beams that are of a weaker class. There is no danger of hazardous radiation outside the unit.

BEFORE USE

For DDX5902:

CAUTION

Use of controls or adjustments or performance of procedures other than those specified herein may result in hazardous radiation exposure. In compliance with Federal Regulations, the following are reproductions of labels on, or inside the product relating to laser product safety.

JVC KENWOOD Corporation
2967-3, ISHIKAWA-MACHI, HACHIOJI-SHI, TOKYO, JAPAN

THIS PRODUCT COMPLIES WITH DHHS RULES 21CFR
SUBCHAPTER J IN EFFECT AT DATE OF MANUFACTURE.

Location : Top plate

FCC WARNING

This equipment may generate or use radio frequency energy. Changes or modifications to this equipment may cause harmful interference unless the modifications are expressly approved in the instruction manual. The user could lose the authority to operate this equipment if an unauthorized change or modification is made.

FCC NOTE

This equipment has been tested and found to comply with the limits for a Class B digital device, pursuant to Part 15 of the FCC Rules. These limits are designed to provide reasonable protection against harmful interference in a residential installation.

This equipment may cause harmful interference to radio communications, if it is not installed and used in accordance with the instructions. However, there is no guarantee that interference will not occur in a particular installation. If this equipment does cause harmful interference to radio or television reception, which can be determined by turning the equipment off and on, the user is encouraged to try to correct the interference by one or more of the following measures:

- Reorient or relocate the receiving antenna.
- Increase the separation between the equipment and receiver.
- Connect the equipment into an outlet on a circuit different from that to which the receiver is connected.
- Consult the dealer or an experienced radio/TV technician for help.

For DDX5902:

IC (Industry Canada) Notice

This device complies with Industry Canada license-exempt RSS standard(s). Operation is subject to the following two conditions: (1) This device may not cause interference, and (2) this device must accept any interference, including interference that may cause undesired operation of the device. The term "IC:" before the certification/registration number only signifies that the Industry Canada technical specification were met.

CAUTION

This equipment complies with FCC/IC radiation exposure limits set forth for an uncontrolled environment and meets the FCC radio frequency (RF) Exposure Guidelines in Supplement C to OET65 and RSS-102 of the IC radio frequency (RF) Exposure rules. This equipment has very low levels of RF energy that it deemed to comply without maximum permissive exposure evaluation (MPE). But it is desirable that it should be installed and operated keeping the radiator at least 20 cm or more away from person's body (excluding extremities: hands, wrists, feet and ankles). Under Industry Canada regulations, this radio transmitter may only operate using an antenna of a type and maximum (or lesser) gain approved for the transmitter by Industry Canada. To reduce potential radio interference to other users, the antenna type and its gain should be so chosen that the equivalent isotropically radiated power (e.i.r.p.) is not more than that necessary for successful communication.

- Contains Transmitter Module
FCC ID : YZP-RBFAC21XX
- Contains Transmitter Module
IC: 7414A-RBFAC21XX

Cautions on the monitor:

- The monitor built into this unit has been produced with high precision, but it may have some ineffective dots. This is inevitable and is not considered defective.
- Do not expose the monitor to direct sunlight.

- Do not operate the touch panel using a ball-point pen or similar tool with a sharp tip. Touch the buttons on the touch panel with your finger directly (if you are wearing a glove, take it off).
- When the temperature is very cold or very hot...
 - Chemical changes occur inside, causing malfunction.
 - Pictures may not appear clearly or may move slowly. Pictures may not be synchronized with the sound or picture quality may decline in such environments.

For safety...

- Do not raise the volume level too much, as this will make driving dangerous by blocking outside sounds, and may cause hearing loss.
- Stop the car before performing any complicated operations.

Temperature inside the car...

If you have parked the car for a long time in hot or cold weather, wait until the temperature in the car becomes normal before operating the unit.

How to reset your unit

If the unit fails to operate properly, press the reset button.

DDX7015BT

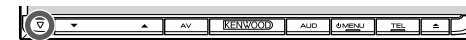

DDX5902



DDX715WB

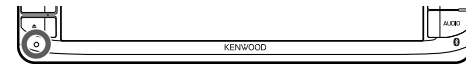

INITIAL SETTINGS

Initial setup

When you power on the unit for the first time or reset the unit, the initial setting screen appears.

- You can also change the settings on the **<Setup>** screen. (Page 60)

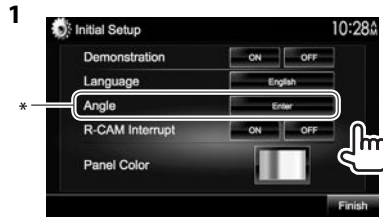

<Demonstration> Activate or deactivate the display demonstration. (Page 61)

<Language> Select the text language used for on-screen information.

- Set **<GUI Language>** to display the operation buttons and menu items in the selected language (**[Local]**) or English (**[English]**).

<Angle>* Adjust the panel angle. (Page 8)

<R-CAM Interrupt> Select **[ON]** when connecting the rear view camera. (Page 61)

<Panel Color> Select the color of the buttons on the monitor panel. (Page 57)

- Finish the procedure.



The **<TOP MENU>** screen is displayed.

- * Only for DDX7015BT/DDX715WBT.

Setting the security function

❑ Registering the security code (only for DDX7015BT/DDX715WBT)

You can set a security code to protect your receiver system against theft.

- Display the **<TOP MENU>** screen.

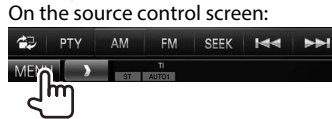

- Display the **<System>** setting screen.



- Display the **<Security Code Set>** screen.

- Press **[▼]** repeatedly to change the page on the **<System>** menu screen.



- To clear the registered security code, perform steps 1 and 2, then press **[CLR]** in **<Security Code>**.

- Enter a four-digit number (①), then confirm the entry (②).



- Press **[Clear]** to delete the last entry.
- Press **[Cancel]** to cancel the setting.

- Repeat step 4 to confirm your security code.

Now, your security code is registered.

- When the unit is being reset or disconnected from the battery, you are required to enter the security code. Enter the correct security code, then press **[Enter]**.

INITIAL SETTINGS

❑ Activating the security function

You can activate the security function to protect your receiver system against theft.

- 1 Display the <System> setting screen.
On the <TOP MENU> screen:

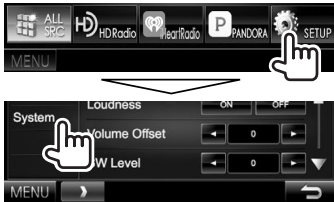

- Press [▼] repeatedly to change the page on the <System> menu screen.



The security indicator on the monitor panel flashes when the vehicle ignition is off.

To deactivate the security function: Select [OFF] for <SI>.

Clock settings

- 1 Display the <TOP MENU> screen.
On the source control screen:

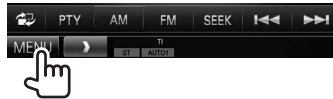

- 2 Display the <Setup> screen.



- 3 Display the <Clock> screen.



- 4 Set the clock time.



<Radio Data System> Synchronizes the clock time with FM RBDS.

<OFF> Sets the clock manually. (See below.)

When selecting <OFF>:
Adjust the hour (①), then adjust the minute (②).
• Press [Reset] to set the minute to "00".



- 5 Finish the procedure.



BASICS

Component names and functions



⚠ Caution on the volume setting:

Digital devices produce very little noise compared with other sources. Lower the volume before playing these digital sources to avoid damaging the speakers by sudden increase of the output level.

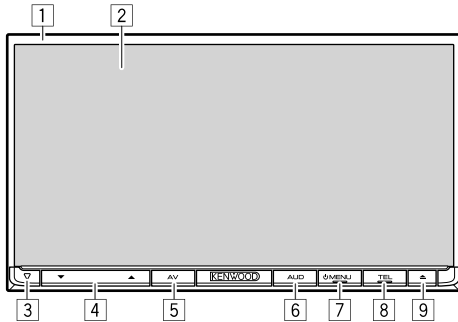
DDX7015BT





- 1 Monitor panel*
- 2 Screen (touch panel)
- 3 Reset button/Power indicator/Security indicator
 - Resets the unit. (Page 3)
 - Lights up while the unit is turned on.
 - Flashes when the security function is activated. (Page 5)
- 4 Volume ▼/▲ button
 - Adjusts the audio volume. (Page 8)

- 5 AV/AV OUT button
 - Displays the current source screen. (Press)
 - The function of the button when held varies depending on the <AV Key Long Press> setting. (Page 62)
- 6 AUD/R-CAM button
 - Displays the <Equalizer> screen. (Press) (Page 53)
 - The function of the button when held varies depending on the <AUD Key Long Press> setting. (Page 62)
- 7  MENU button
 - Displays the <TOP MENU> screen. (Press) (Page 10)
 - Turns on the power. (Press) (Page 8)
 - Turns off the power. (Hold) (Page 8)
- 8 TEL/VOICE button
 - Displays the phone control screen. (Press) (Page 48)
 - Activates voice dialing. (Hold) (Page 49)
- 9  (Eject) button
 - Ejects the disc. (Tilts the monitor panel fully.)
 - Opens/closes the monitor panel.

* You can change the color of the buttons on the monitor panel. (Page 57)

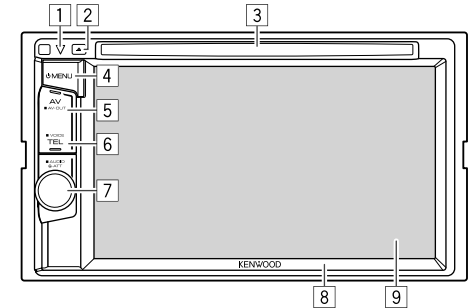
DDX5902



- 1 Reset button/Power indicator/Security indicator
 - Resets the unit. (Page 3)
 - Lights up while the unit is turned on.
 - Flashes when the security function is activated. (Page 5)
- 2  (Eject) button
 - Ejects the disc.
- 3 Loading slot



BASICS



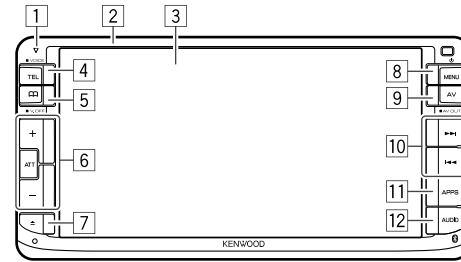

- 4  MENU button
- Displays the <TOP MENU> screen. (Press) (Page 10)
 - Turns on the power. (Press) (Page 8)
 - Turns off the power. (Hold) (Page 8)
- 5 AV/AV OUT button
- Displays the current source screen. (Press)
 - The function of the button when held varies depending on the <AV Key Long Press> setting. (Page 62)
- 6 TEL/VOICE button
- Displays the phone control screen. (Press) (Page 48)
 - The function of the button when held varies depending on the <TEL Key Long Press> setting. (Page 62)
- 7 Volume/ATT/AUDIO knob
- Attenuates the sound. (Press) (Page 8)
 - Adjusts the audio volume. (Turn) (Page 8)
 - Displays the <Equalizer> screen. (Hold) (Page 53)
- 8 Monitor panel*
- 9 Screen (touch panel)

* You can change the color of the buttons on the monitor panel. (Page 57)

DDX715WBT



- 1 Power indicator/Security indicator
- Lights up while the unit is turned on.
 - Flashes when the security function is activated. (Page 5)
- 2 Monitor panel*
- 3 Screen (touch panel)
- 4 TEL/VOICE button
- Displays the phone control screen. (Press) (Page 48)
 - Activates voice dialing. (Hold) (Page 49)
- 5  / V.OFF button
- Displays the phone book. (Press) (Page 48)
 - The function of the button when held varies depending on the <P.BOOK Key Long Press> setting. (Page 62)
- 6 Volume +/- button
- Adjusts the audio volume. (Page 8)
- ATT button
- Attenuates the sound. (Page 8)
- 7  (Eject) button
- Ejects the disc. (Tilts the monitor panel fully.)
 - Opens/closes the monitor panel.

- 8  MENU button
- Displays the <TOP MENU> screen. (Press) (Page 10)
 - Turns off the power. (Hold) (Page 8)
 - Turns on the power. (Press) (Page 8)
- 9 AV/AV OUT button
- Displays the current source screen. (Press)
 - Displays the screen of the external component connected to the AV-OUT terminal. (Hold) (Page 71)
- 10  button
- Functions the same as []/[] on the touch panel when playing a source.
- 11 APPS button
- Displays the App screen. (Page 22)
- 12 AUDIO button
- Displays the <Equalizer> screen. (Press) (Page 53)
- * You can change the color of the buttons on the monitor panel. (Page 57)

BASICS

Common operations

Turning on the power

DDX7015BT



DDX5902



DDX715WBT

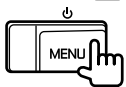

Turning off the power

DDX7015BT



DDX5902

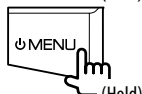

DDX715WBT

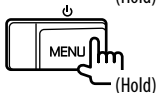

Adjusting the volume

To adjust the volume (00 to 35)

DDX7015BT

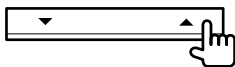

Press ▲ to increase, and press ▼ to decrease.

- Holding the button increases/decreases the volume continuously.

DDX5902

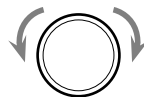

Turn to the right to increase, and turn to the left to decrease.

DDX715WBT



Press + to increase, and press – to decrease.

- Holding the button increases/decreases the volume continuously.

To attenuate the sound (only for DDX5902/ DDX715WBT)

DDX5902



DDX715WBT



The ATT indicator lights up.

To cancel the attenuation: Press the same button again.

Adjusting the panel angle (only for DDX7015BT/DDX715WBT)

1 Display the <Angle Adjust> screen.

On the <TOP MENU> screen:

- Press [▼] repeatedly to change the page on the <Display> menu screen.



2 Select an angle (0 – 6).

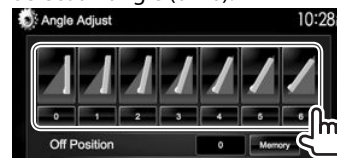

- To set the current position as the power off position, select [Memory].

BASICS

❑ Putting the unit in standby

1 Display all <TOP MENU> items.

On the <TOP MENU> screen:

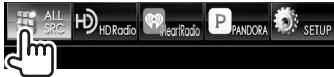

2

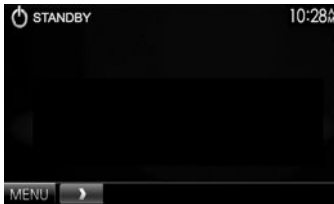
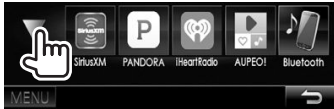

❑ Turning off the screen

DDX7015BT*1

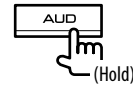

DDX5902*2



DDX715WBT*3

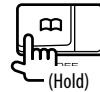

To turn on the screen: Press AV/AV OUT on the monitor panel, or touch the display.

*1 This operation works only when <AUD Key Long Press> is set to [V-OFF]. (Page 62)

*2 This operation works only when <TEL Key Long Press> is set to [V-OFF]. (Page 62)

*3 This operation works only when <P.BOOK Key Long Press> is set to [V-OFF]. (Page 62)

Common screen operations

❑ Common screen descriptions

You can display other screens any time to change the source, show the information, or change the settings, etc.

Source control screen

Performs source playback operations.

- The operation buttons vary depending on the selected source.



Common operation buttons:

- 1 Displays other operation buttons.
 - Disabled when there are no other buttons.
- 2 Switches between the normal source control screen and easy control screen. (Page 10)
- 3 Displays the <TOP MENU> screen. (Page 10)
 - Pressing MENU on the monitor panel also displays the <TOP MENU> screen.
- 4 Displays/hides short-cut buttons. (Page 11)

Continued on the next page...

BASICS

Easy control screen

Pressing [MENU] switches between the normal source control screen and easy control screen. The easy control screen allows you to control the source easily with simple buttons.

- The displayed buttons vary depending on the selected source.



<TOP MENU> screen

Displays the source control screen and settings screen.

- You can arrange the items to display on the <TOP MENU> screen. (Page 58)

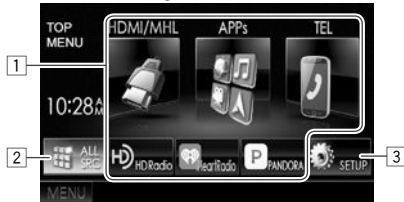

Common operating buttons:

- 1 Changes the playback source. (Page 11)
- 2 Displays all playback sources and items. (Page 11)
- 3 Displays the <Setup> screen. (See the right column.)

<Setup> screen

Changes the detailed settings. (Page 60)



Common operating buttons:

- 1 Selects the menu category.
- 2 Displays the <TOP MENU> screen.
- 3 Changes the page.
- 4 Returns to the previous screen.

Touch screen operations

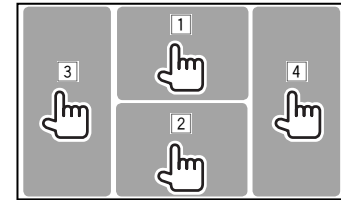

- 1 Displays the video control menu while playing a video.



- 2 Displays the source control screen while playing a video.



- The operation buttons disappear when the screen is touched or when no operation is done for about 5 seconds.
- 3 Goes to the previous chapter/track.*
 - 4 Goes to the next chapter/track.*

* Not available for video from an external component.

BASICS

Selecting the playback source

On the <TOP MENU> screen:



- You can change the page to display more items by pressing [▲]/[▼].

- [DISC]** Plays a disc. (Page 12)
- [HD Radio]*1** Switches to the HD Radio broadcast. (Page 31)
- [TUNER]*2** Switches to the conventional radio broadcast. (Page 29)
- [iPod]** Plays an iPod/iPhone. (Page 18)
- [USB]** Plays files on a USB device. (Page 17)
- [HDMI/MHL]** Plays a device connected to the HDMI/MHL input terminal. (Page 43)
- [SiriusXM]*1** Switches to the SiriusXM® radio broadcast. (Page 34)

- [PANDORA]*1** Switches to the Pandora broadcast. (Page 23)
- [iHeartRadio]*1** Switches to the iHeartRADIO broadcast. (Page 25)
- [AUPEO!]** Switches to the AUPEO! application. (Page 27)
- [Bluetooth]** Plays a Bluetooth audio player. (Page 50)
- [APPS]** Switches to the App screen from the connected iPod touch/iPhone/Android device. (Page 22)
- [TEL]** Displays the phone control screen. (Page 48)
- [OEM Features]*1** Switches to the source connected via ADS adapter. (Page 43)
- [AV-IN1][AV-IN2]** Switches to an external component connected to the AV-IN1 or iPod/AV-IN2 input terminal. (Page 41)

*1 Only for DDX5902.

*2 Only for DDX7015BT/DDX715WBT.

Selecting the playback source on the <TOP MENU> screen



- You can change the items (other than [SETUP]) to display on the <TOP MENU> screen. (Page 58)

Using short-cut buttons

While displaying the source control screen or the <Setup> screen, you can use the short-cut buttons to go to the items on the <TOP MENU> screen indicated below.



To display the short-cut buttons



On the source control screen:



On the <Setup> screen:



To hide the short-cut buttons: Press [◀].

DISCS

Playing a disc

- If a disc does not have a disc menu, all tracks on it will be played repeatedly until you change the source or eject the disc.
- For playable disc types/file types, see page 74.

❑ Inserting a disc

Insert a disc with the label side facing up.

DDX7015BT

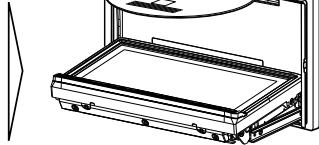

DDX5902

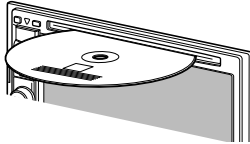

DDX715WBT

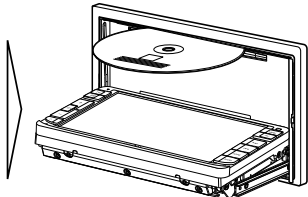

The source changes to "DISC" and playback starts.

- The IN indicator lights up while a disc is inserted.

- If "⊘" appears on the screen, the unit cannot accept the operation you have tried to do.
 - In some cases, without showing "⊘," operations will not be accepted.
- When playing back a multi-channel encoded disc, the multi-channel signals are downmixed to stereo.

❑ Ejecting a disc

DDX7015BT



DDX5902



DDX715WBT



- When removing a disc, pull it horizontally.
- You can eject a disc when playing another AV source.
- If the ejected disc is not removed within 60 seconds, the disc is automatically inserted again into the loading slot to protect it from dust.

Closing the monitor panel (only for DDX7015BT/ DDX715WBT)

After removing the disc, press ▲ on the monitor panel. The monitor panel closes.

Playback operations

When the operation buttons are not displayed on the screen, touch the area shown on the illustration.

- To change settings for video playback, see page 55.

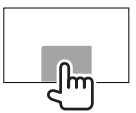

❑ Indications and buttons on the source control screen

For video playback

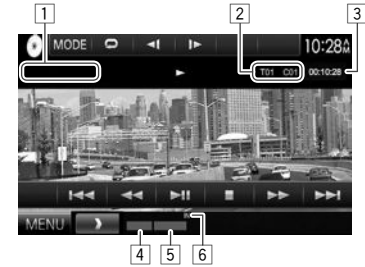

Playback information

- The information displayed on the screen differs depending on the type of disc/file being played back.

- 1 Media type
- 2 Current playback item information (title no./chapter no./folder no./file no./track no.)
- 3 Playing time
- 4 Playback mode (Page 15)
- 5 File type
- 6 IN indicator

DISCS

Operation buttons

- Available buttons on the screen and operations differ depending on the type of disc/file being played back.

- [Q] Displays the folder/track list. (Page 14)
- [◀▶] Reverse/forward search during playback.
- [◀▶] Selects a chapter/track. (Press)
- Reverse/forward search. (Hold)
- [▶] Starts/pauses playback.
- [■] Stops playback.
- [◀◀] Displays other operation buttons.
- Disabled when there are no other buttons.
- [MODE] Changes the settings for disc playback on the <DISC Mode> screen. (Page 16)
- [O] [X] Selects playback mode. (Page 15)
- [Playlist] Displays the Original Program/Playlist screen.
- [◀] [▶] Plays in frame-by-frame.
- [+] [-] Selects a folder.
- [PBC] Activates or deactivates the VCD PBC (Playback Control) function.
- [MENU] Displays the <TOP MENU> screen.

For audio playback



Playback information

- The information displayed on the screen differs depending on the type of disc/file being played back.
- 1 Media type
 - 2 Track/file information
 - Pressing [◀] scrolls the text if not all of the text is shown.
 - 3 Current playback item information (folder no./file no./track no.)
 - 4 Playback status
 - 5 Playing time
 - 6 Playback mode (Page 15)
 - 7 File type
 - 8 IN indicator

Operation buttons

- Available buttons on the screen and operations differ depending on the type of disc/file being played back.
- [EASY] Displays the easy control screen. (Page 10)
- [Q] Displays the folder/track list. (Page 14)
- [◀▶] Selects a track.
- [◀▶] Reverse/forward search.
- [▶] Starts/pauses playback.
- [◀◀] Displays other operation buttons.
- Disabled when there are no other buttons.
- [MODE] Changes the settings for disc playback on the <DISC Mode> screen. (Page 16)
- [+] [-] Selects a folder.
- [O] [X] Selects playback mode. (Page 15)
- [■] Stops playback.
- [MENU] Displays the <TOP MENU> screen.

DISCS

❑ Selecting a folder/track on the list

1



2 Select the folder (①), then the item in the selected folder (②).

- Repeat the procedure until you select the desired track.



- You can change the page to display more items by pressing [▲]/[▼].
- Press [Enter] to open the folder containing the current track.
- Press [Esc] to return to the root folder.
- Press [Up] to return to the upper layer.

❑ Video menu operations

You can display the video menu screen during video playback.

- The operation buttons disappear when the screen is touched or when no operation is done for about 5 seconds.



For video playback except VCD



- Available buttons on the screen and operations differ depending on the type of disc/file being played back.

[ZOOM]

Displays the picture size selection screen. (Page 56)

[Aspect]

Selects the aspect ratio. (Page 56)

[PictureAdjust]

Displays the picture adjustment screen. (Page 55)

[Audio]

Selects the audio type (or channel for DVD-VR).

[Subtitle]

Selects the subtitle type.

[Angle]

Selects the view angle.

[MENU]

Displays the disc menu. (DVD).

[T MENU]

Displays the disc menu (DVD).

[Highlight]

Switches to the direct disc menu mode. Touch the target item to select.

- To restore the screen, press AV on the monitor panel.

[CUR]

Displays the menu/scene selection screen.

- [▲] [▼] [◀] [▶]: Selects an item.
- [Enter]: Confirms the selection.
- [Return]: Returns to the previous screen.

DISCS

For VCD



- [ZOOM]** Displays the picture size selection screen. (Page 56)
- [Aspect]** Selects the aspect ratio. (Page 56)
- [PictureAdjust]** Displays the picture adjustment screen. (Page 55)
- [Audio]** Selects the audio channel (ST: stereo, LL: left, RR: right).
- [Return]** Displays the previous screen or menu.
- [Direct]** Displays/hides the direct selection buttons. (See the right column.)

To select a track directly on a VCD



- When you enter a wrong number, press **[CLR]** to delete the last entry.

Selecting playback mode



- [REPEAT]** Selects Repeat playback mode.
- [RANDOM]** Selects Random playback mode.
- Available playback modes differ depending on the type of disc/file being played back.
- You cannot activate the repeat mode and the random mode at the same time.
- Each time you press the button, the playback mode changes. (The corresponding indicator lights up.)
 - Available items differ depending on the type of disc/file being played back.
- C-REP** Repeats current chapter.
- T-REP** Repeats current title/program.
- REP** Repeats current track.
- FO-REP** Repeats all tracks of the current folder.
- FO-RDM** Randomly plays all tracks of the current folder, then tracks of the next folders.
- RDM** Randomly plays all tracks.

To cancel Repeat/Random playback: Press the button repeatedly until the indicator disappears.

DISCS

Settings for disc playback



- Available items shown on the <DISC Mode> screen differ depending on the type of disc/file being played back.

Setting items

<Menu Language>*	Select the initial disc menu language. (Initial: English) (Page 76)
<Subtitle Language>*	Select the initial subtitle language or turn subtitles off (Off). (Initial: English) (Page 76)
<Audio Language>*	Select the initial audio language. (Initial: Original) (Page 76)
<Dynamic Range Control>*	You can change the dynamic range while playing using Dolby Digital software. <ul style="list-style-type: none"> • Wide: Select this to enjoy a powerful sound at a low volume level with its full dynamic range. • Normal: Select this to reduce the dynamic range a little. • Dialog (Initial): Select this to reproduce movie dialog more clearly.

<Angle Mark>	Select whether to display the angle mark. <ul style="list-style-type: none"> • ON (Initial): Select this to display the angle mark. • OFF: Select this to hide the angle mark.
<Screen Ratio>*	Select the monitor type to watch a wide screen picture on the external monitor. 16:9 (Initial) 4:3 LB 4:3 PS 
<Parental Level>*	Set the parental level. (See the right column.)
<CD Read>	Select the files to play on a disc containing music files. You cannot change the setting when a disc is inserted. <ul style="list-style-type: none"> • 1 (Initial): Automatically distinguishes between audio file discs and music CDs. • 2: Forces to play as a music CD. No sound can be heard if an audio file disc is played.

* You can change these settings only while playback is stopped.

Setting the parental lock

The parental lock cannot be set during DVD playback.

- 1 Display the <Parental Pass> screen. On the <DISC Mode> screen:
 - Press [▼] repeatedly to change the page on the <DISC Mode> screen.



- 2 Enter the 4-digit parental pass code (①), and press [Enter] (②).



- To clear the entry, press [Clear].
- To cancel setting the code, press [Cancel].

- 3 Adjust the parental level (<OFF>, <Level 1> to <Level 8>).

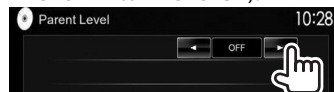

To deactivate the parental lock: Select [OFF] for <Parental Level>.

USB

Connecting a USB device

You can connect a USB mass storage class device such as a USB memory, Digital Audio Player etc. to the unit.

- For details about connecting USB devices, see page 70.
- You cannot connect a computer or portable HDD to the USB input terminal.
- For playable file types and notes on using USB devices, see page 75.

When a USB device is connected...

The source changes to “USB” and playback starts.

- All tracks in the USB device will be played repeatedly until you change the source.

To disconnect the USB device safely:

Press [▲], then disconnect the USB device after “No Device” appears.

Playback operations

When the operation buttons are not displayed on the screen, touch the area shown on the illustration.

- To change settings for video playback, see page 55.

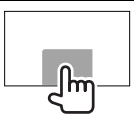

Indications and buttons on the source control screen

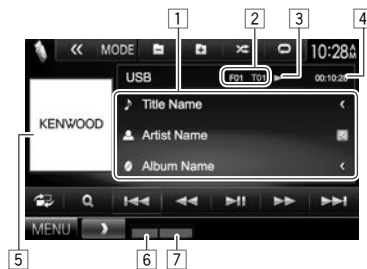

Playback information

- The information displayed on the screen differs depending on the type of file being played back.

- 1 Track/file information
 - Pressing [◀] scrolls the text if not all of the text is shown.
- 2 Current playback item information (folder no./file no.)
- 3 Playback status
- 4 Playing time
- 5 Jacket picture (Shown while playing if the file has tag data that includes the jacket picture)
- 6 Playback mode (See the right column.)
- 7 File type

Operation buttons

- Available buttons on the screen and operations differ depending on the type of file being played back.

- [🏠] Displays the easy control screen. (Page 10)
- [Q] Displays the list selection screen. (Page 18)
- [◀▶] Selects a track.

- [◀▶] Reverse/forward search.
- [⏮] Starts/pauses playback.
- [◀] Displays other operation buttons.
 - Disabled when there are no other buttons.
- [MODE] Changes the picture display time setting on the <USB Mode> screen. (Page 18)
- [+/-] Selects a folder.
- [🔄] Selects repeat playback mode.*1 *2
 - **REP**: Repeats the current track/file.
 - **FO-REP**: Repeats all tracks/files in the current folder or specified category.
- [🎲] Activates random playback mode.*1 *2
 - **RDM**:
 - When selecting the track/file from the folder, randomly plays all tracks/files of the current folder, then the tracks/files of the next folder.
 - When selecting the track/file from the category, randomly plays all tracks/files of the specified category.
- [▲] Disconnects the USB device safely.
- [MENU] Displays the <TOP MENU> screen.

*1 To cancel random or repeat mode, press the button repeatedly until the indicator disappears.

*2 You cannot activate the repeat mode and the random mode at the same time.

USB

❑ Setting <Picture Display Time>

Set the interval between slides during slide-shows of the picture files.

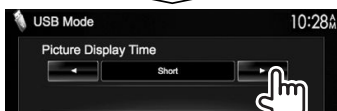

❑ Selecting a track in a list



2 Select the list.



3 Select the track.

- You can change the page to display more items by pressing [▲]/[▼].
- Press [⏪] to return to the root folder.
- Press [⏩] to return to the upper layer.
- Press [📁] to open the folder containing the current track.
- If you want to play all tracks in the folder, press [▶] on the right of the desired folder.

- On the <Category List>/<Folder List>: You can switch the file type to list: Press [🎵] to list audio files, [📺] to list video files, or [🖼️] to list still picture files.
- On the <Category List>/<Link Search>: To list the items in alphabetical order, press [A-Z], then select the first character.

From <Category List>:

Select the category (①), then the item in the selected category (②).



From <Link Search>:

Select the tag type (①) to display a list of content that contains the same tag as the track/file currently being played, then the item (②).



From <Folder List>:

Select the folder (①), then the item in the selected folder (②).

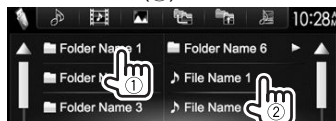

iPod/iPhone

Preparation

❑ Connecting iPod/iPhone

- For details about connecting iPod/iPhone, see page 70.
- For playable iPod/iPhone types, see page 76.

Connect your iPod/iPhone according to your purpose or the type of iPod/iPhone.

Wired connection

- **To listen to music:** USB Audio cable for iPod/iPhone
 - For iPod/iPhone except for iPod nano (7th Generation)/iPod touch (5th Generation)/iPhone 5S/iPhone 5C/iPhone 5: KCA-iP102 (optional accessory)
 - For iPod nano (7th Generation)/iPod touch (5th Generation)/iPhone 5S/iPhone 5C/iPhone 5: KCA-iP103 (optional accessory)
- **To watch video and listen to music:** USB Audio and Video cable for iPod/iPhone
 - For iPod/iPhone except for iPod nano (7th Generation)/iPod touch (5th Generation)/iPhone 5S/iPhone 5C/iPhone 5: KCA-iP202 (optional accessory)
 - For iPod nano (7th Generation)/iPod touch (5th Generation)/iPhone 5S/iPhone 5C/iPhone 5, use the HDMI cable KCA-HD100 (optional accessory) and KCA-iP103 (optional accessory) through a Lightning-Digital AV adapter (accessory of the iPod/iPhone)

iPod/iPhone

Bluetooth connection

Pair the iPod/iPhone through Bluetooth. (Page 44)

- For iPod nano (7th Generation)/iPod touch (5th Generation)/iPhone 5S/iPhone 5C/iPhone 5: To watch video, connect your iPod/iPhone to the HDMI/MHL input terminal using KCA-HD100 (optional accessory). (Page 70)
- For iPod/iPhone except for iPod nano (7th Generation)/iPod touch (5th Generation)/iPhone 5S/iPhone 5C/iPhone 5: You cannot watch video with a Bluetooth connection.

❑ Selecting the iPod/iPhone device to play and connection method

When connecting the iPod/iPhone device for first time, the setup screen (for connection, etc.) appears. Follow the procedure on the setup screen to configure the settings.

1 Display the <iPod Settings> screen.

On the <TOP MENU> screen:

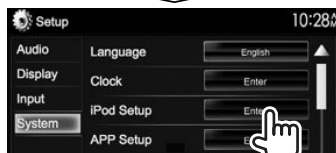
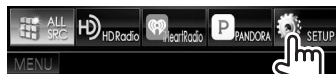

- If [Enter] for <iPod Setup> cannot be selected, put the unit in standby. (Page 9)

2



- If you do not need to change the settings, press [OK] to exit from the setup screen.

3 Select the connection method (①), then press [Next] (②).



<USB + AV-IN>

Select this when the iPod/iPhone is connected using KCA-iP202 (optional accessory).

<USB 1 Wire>

Select this when the iPod/iPhone is connected using KCA-iP102 (optional accessory) or KCA-iP103 (optional accessory).

<HDMI + Bluetooth>

Select this when the iPod/iPhone is connected using HDMI cable KCA-HD100 (optional accessory) and KCA-iP103 (optional accessory) through a Lightning-Digital AV adapter (accessory of the iPod/iPhone).

<Bluetooth>

Select this when the iPod/iPhone is connected via Bluetooth.

- When selecting <USB + AV-IN> or <USB 1 Wire>, go to step 5.

Continued on the next page...

iPod/iPhone

- 4 When selecting **<HDMI + Bluetooth>** or **<Bluetooth>** as the connection method, the device selection screen appears. Search for the available iPod/iPhone devices (①), select the target device from the list (②), then press **[Next]**.



- You can change the page to display more items by pressing [▲]/[▼].
- If the device is already listed, skip step ①.
- To stop searching, press **[Cancel]**.

- 5 Confirm the settings.



❑ Selecting preference settings for iPod/iPhone playback

When the source is "iPod"...



<Audiobooks> Select the speed of audio books.

<Wide Screen>*

- **[ON]**: Select this to display video compatible with wide-screen display in wide-screen.
- **[OFF]**: Select this to deactivate.

* You cannot change the setting when iPod/iPhone is connected.

Playback operations

When the operation buttons are not displayed on the screen, touch the area shown on the illustration.

- To change settings for video playback, see page 55.

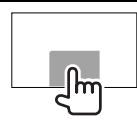

❑ Indications and buttons on the source control screen

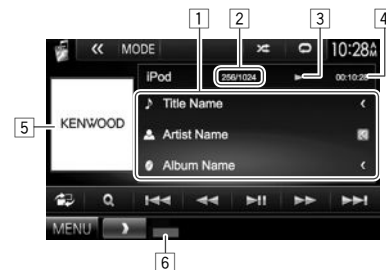

Playback information

- 1 Song/video information
 - Pressing [**<**] scrolls the text if not all of the text is shown.
- 2 Track no./Total track number
- 3 Playback status
- 4 Playing time
- 5 Artwork (Shown if the song contains artwork)
- 6 Playback mode (Page 21)

iPod/iPhone

Operation buttons

- [] Displays the easy control screen. (Page 10)
- [] Displays the audio/video file list. (See the right column.)
- [] [] Selects an audio/video file.
- [] [] Reverse/forward search.
- [] Starts/pauses playback.
- [] Displays other operation buttons.
- Disabled when there are no other buttons.
- [**MODE**] Changes the settings for iPod/iPhone playback on the <iPod Mode> screen. (Page 20)
- [] Selects repeat playback mode.
- ①: Functions the same as Repeat One.
 - All: Functions the same as Repeat All.
 - : Cancels the repeat mode.
- [] Selects random playback mode.*
- : Functions the same as Shuffle Songs.
 - Album: Functions the same as Shuffle Albums.
- [**MENU**] Displays the <TOP MENU> screen.

* To cancel random mode, press the button repeatedly until the indicator disappears.

□ Selecting an audio/video file from the menu

-  1
 - Select the menu (): audio or (): video (①), a category (②), then a desired item (③).
- Select an item in each layer until you reach and select the desired file.
 - You can change the page to display more items by pressing []/[].
 - Press [**All >**] to play all songs/videos.
 - Press [**A-Z**] to sort the list in alphabetical order.
 - Press [] to return to the top layer.
 - Press [] to return to the upper layer.

Audio menu:



Video menu:



- Available categories differ depending on the type of your iPod/iPhone.

APPs

You can use an App of the connected iPod touch/iPhone/Android on this unit.

- For Apps you can use on this unit, visit <<http://www.kenwood.com/cs/ce>>.

Preparation

- 1 Connect the iPod touch/iPhone/Android.
 - For wired connection, see page 70 for iPod touch/iPhone or page 71 for Android.
 - To view video, connect the device using KCA-iP202 or KCA-HD100 (optional accessory).
 - For Bluetooth connection, see page 46.
- 2 Select the iPod touch/iPhone/Android device to use and connection method on the <APP Settings> screen. (Page 52)

When connecting the device for the first time, the setup screen (for connection, etc.) appears. Follow the procedure on the setup screen to configure the settings.

Using an App

When the operation buttons are not displayed on the screen, touch the screen to show them.

- To change settings for video playback, see page 55.

❑ Playback operations

- 1 Start the App on your iPod touch/iPhone/Android.
- 2 Select “APPs” as the source. (Page 11)

❑ Operation buttons on the source control screen



- [▶] Starts playback.
- [||] Pauses playback.
- [◀◀] [▶▶] Selects an audio/video file.
- [◀◀] [▶▶] Reverse/forward search.
- [▶||] Starts/pauses playback.
- [MENU] Displays the <TOP MENU> screen.

- You can operate some functions of the App on the touch panel.
- For some applications such as navigation applications, the operation buttons and information are not shown. You can perform the operations on the touch panel, such as scrolling the map.
 - If “⊗” appears on the screen, the unit cannot accept the touch operation you have tried to do.
- You can also play back the audio/video using iPod/iPhone/Android itself instead of the unit.

❑ Switching to the App screen while listening to another source

DDX7015BT*

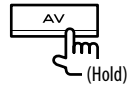

DDX5902*



DDX715WBT



To return to the source control screen: Press the same button again.

* This operation works only when <AV Key Long Press> is set to [APPs]. (Page 62)

You can stream Pandora from iPod touch/iPhone, Android or BlackBerry devices.

- Install the latest version of the Pandora application on your iPod touch/iPhone/Android/BlackBerry.

Preparation

Connect the device, then start the Pandora application.

- 1 Connect the device.
 - **For Android/BlackBerry:** Pair the Android/BlackBerry device through Bluetooth. (Page 44)
 - **For iPod touch/iPhone:** Connect iPod touch/iPhone. (Page 18)
- 2 Select the device to use and connection method on the <APP Settings> screen. (Page 52)
- 3 Select "PANDORA" as the source. On the <TOP MENU> screen:

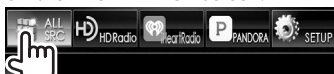

The Pandora application is started.

Playback operations

You can operate Pandora using the remote controller. Only playing, pausing, and skipping are available.

Indications and buttons on the source control screen



Playback information

- 1 Picture data
 - Pressing [-] scrolls the text if not all of the text is shown.
- 2 Track information
- 3 Playback status
- 4 Playing time

Operation buttons

- [] Displays the easy control screen. (Page 10)
- [Q] Displays the list selection screen. (Page 24)
- [] Thumbs down to the current track and skips to the next track.
- [] Registers the current track as a favorite.
- [] Starts/pauses playback.
- [] Skips the current track.
 - Not available when the Pandora skip reaches its limit.
- [] Displays other operation buttons.
 - Disabled when there are no other buttons.
- [] Bookmarks the artist.
- [] Bookmarks the current track.
- [] Adds the current artist to the Station List.
- [] Adds the current track to the Station List.
- [MENU] Displays the <TOP MENU> screen.

❑ Selecting a station from the list

1 Display the list selection screen.



2 Select the list type.



<Station List> Selects from the station names (Station List).

<Genre List> Selects from the genre names (Genre List).

3 Select a station from the list.

On the Station List





[Shuffle] Plays all the songs in the registered stations randomly.

[By Date] Sorts the list in reverse chronological order.

[By Name] Sorts the list in alphabetical order.

• You can change the page to display more items by pressing [▲]/[▼].

- The  indicator appears on the left of the item when Shuffle is activated. (All songs on the registered stations are played randomly.)
- The  indicator appears on the right of the item when the station is shared.

On the Genre List

Select a genre (①), then a station (②).

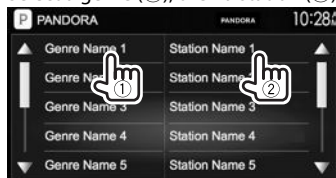

- You can change the page to display more items by pressing [▲]/[▼].
- The selected station is added to the Station List.

Requirements for Pandora®

iPhone or iPod touch

- Install the latest version of the Pandora application on your iPhone or iPod touch. (Search for “Pandora” in the Apple iTunes App Store to find and install the most recent version.)
- Connect iPod touch/iPhone to this unit with a cable or via Bluetooth.
 - When connecting with a cable: Use KCA-iP202, KCA-HD100, KCA-iP102 (optional accessory) or KCA-iP103 (optional accessory).
 - When connecting via Bluetooth, the following profiles must be supported.
 - SPP (Serial Port Profile)
 - A2DP (Advanced Audio Distribution Profile)

Android™

- Visit Google play and search for “Pandora” to install.
- Bluetooth must be built in and the following profiles must be supported.
 - SPP (Serial Port Profile)
 - A2DP (Advanced Audio Distribution Profile)

BlackBerry®

- Visit www.pandora.com from the built in browser to download the Pandora application.
- Bluetooth must be built in and the following profiles must be supported.
 - SPP (Serial Port Profile)
 - A2DP (Advanced Audio Distribution Profile)

NOTE

- Ensure you are logged in to your smartphone application. If you do not have a Pandora account, you can create one for free from your smartphone or at www.pandora.com.
- Pandora is available only in the U.S./Australia/New Zealand.
- Because Pandora is a third-party service, the specifications are subject to change without prior notice. Accordingly, compatibility may be impaired or some or all of the services may become unavailable.
- Some functions of Pandora cannot be operated from this unit.
- For issues using the application, contact Pandora at pandora-support@pandora.com
- Establish an Internet connection using LTE, 3G, EDGE, or WiFi.

iHeartRADIO (Only for DDX5902)

iHeartRADIO is a free, all-in-one digital radio service that lets you listen to your favorite Live Stations or create commercial-free, all-music Custom Stations featuring songs from the artists you select and similar music.

You can stream iHeartRADIO from iPod touch/iPhone or Android devices.

- Install the latest version of the iHeartRADIO application on your iPod touch/iPhone/Android.

Preparation

Connect the device, then start the iHeartRADIO application.

- 1 Connect the device.
 - **For Android:** Pair the Android device through Bluetooth. (Page 44)
 - **For iPod touch/iPhone:** Connect iPod touch/iPhone. (Page 18)
- 2 Select the device to use and connection method on the <APP Settings> screen. (Page 52)
- 3 Select "iHeartRADIO" as the source.

On the <TOP MENU> screen:



iHeartRADIO application is started.

Playback operations

You can operate iHeartRADIO using the remote controller. Only playing, pausing, and skipping are available.

Indications and buttons on the source control screen

Live station screen:



Custom station screen:

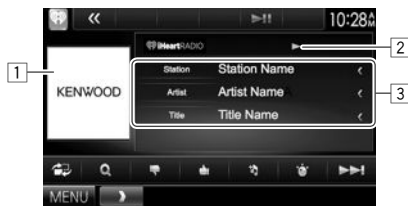

Playback information

- 1 Picture data
 - 2 Playback status
 - 3 Track information
- Pressing [<] scrolls the text if not all of the text is shown.

Operation buttons

- [<] Displays the easy control screen. (Page 10)
- [Q] Displays the <Station Search> screen or the station list. (Page 26)
- [<] Thumbs down to the current track and skips to the next track.
- [>] Registers the current track as a favorite.
- [+] Adds the current track to the <My Stations> list.
- [♥]*1 Saves the current station to the <My Stations> list.
- [SCAN]*1 Scans stations randomly.
- [<] *2 Displays the variety level selection screen. (Page 26)
- [>] *2 Skips the current track.
- [||] Starts/pauses playback.
- [MENU] Displays the <TOP MENU> screen.

*1 Appears only for the live station screen.

*2 Appears only for the custom station screen.

iHeartRADIO

❑ Selecting the variety level for your custom station

You can adjust the amount of lesser-known music that gets pushed into your custom station.

- 1 Display the variety type selection screen. On the custom station screen:



- 2 Select the variety type.



- <Familiar> Distributes well-known tracks.
- <Mixed> Distributes a mix of the artists and track names.
- <Less Familiar> Distributes a wide variety of tracks including lesser-known ones.

❑ Searching for a station

- 1 Display the <Station Search> screen.



- 2 Select a station.

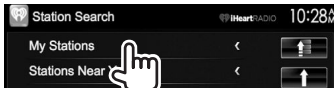

- Press [] to return to the top layer.
- Press [] to return to the upper layer.

❑ Editing the <My Stations> list

- 1 Select <My Stations> on the <Station Search> screen. (See the left column.)

- 2 Display the <Station Edit> screen.



- 3 Select stations (1), then press [] to delete the selected stations (2).



- Press [] to return to the top layer.
- Press [] to return to the upper layer.

Requirements for iHeartRADIO

iPhone or iPod touch

- Install the latest version of the iHeartRADIO application on your iPhone or iPod touch. (Search for "iHeartRADIO for Auto" in the Apple iTunes App Store to find and install the most recent version.)

- Connect iPod touch/iPhone to this unit with a cable or via Bluetooth. When connecting with a cable: Use KCA-iP202, KCA-HD100, KCA-iP102 (optional accessory) or KCA-iP103 (optional accessory).
 - When connecting via Bluetooth, the following profiles must be supported.
 - SPP (Serial Port Profile)
 - A2DP (Advanced Audio Distribution Profile)

Android™

- Visit Google play and search for "iHeartRADIO for Auto" to install.
- Bluetooth must be built in and the following profiles must be supported.
 - SPP (Serial Port Profile)
 - A2DP (Advanced Audio Distribution Profile)

NOTE

- Ensure you are logged in to your smartphone application. If you do not have an iHeartRADIO account, you can create one for free from your smartphone or at <http://www.iheart.com/>.
- Because iHeartRADIO is a third-party service, the specifications are subject to change without prior notice. Accordingly, compatibility may be impaired or some or all of the services may become unavailable.
- Some functions of iHeartRADIO cannot be operated from this unit.
- For issues using the application, contact iHeartRADIO at <http://www.iheart.com/>.
- Establish an Internet connection using LTE, 3G, EDGE, or WiFi.

AUPEO!

AUPEO! Personal Radio plays free music you really like. You can develop your own personalized Internet radio by rating or skipping tracks.

You can stream AUPEO! from connected iPod touch/iPhone or Android devices.

- Install the latest version of the AUPEO! application on your iPod touch/iPhone/Android and create an account.

Preparation

Connect the device, then start the AUPEO! application.

- 1 Connect the device.
 - **For Android:** Pair the Android device through Bluetooth. (Page 44)
 - **For iPod touch/iPhone:** Connect iPod touch/iPhone. (Page 18)
- 2 Select the device to use and connection method on the **<APP Settings>** screen. (Page 52)
- 3 Select **"AUPEO!"** as the source. On the **<TOP MENU>** screen:



The AUPEO! application is started.

Playback operations

You can operate AUPEO! using the remote controller. Only playing, pausing, and skipping are available.

Indications and buttons on the source control screen

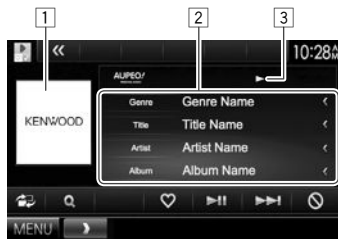

Playback information

- 1 Picture data
- 2 Track information
 - Pressing [**<**] scrolls the text if not all of the text is shown.
- 3 Playback status

Operation buttons

- [**📶**] Displays the easy control screen. (Page 10)
- [**🔍**] Displays the **<Station Search>** screen. (Page 28)
- [**❤️**] "Loves" and registers the current track as a favorite.
- [**▶️⏸️**] Starts/pauses playback.
- [**▶️⏩**] Skips the current track.
- [**🚫**] "Bans" the current track and skips to the next track.
- [**[MENU]**] Displays the **<TOP MENU>** screen.

AUPEO!

☐ Selecting a station

1 Display the <Station Search> screen.



2 Select the category, then the station.



- To return to the previous layer, press [↑].

Requirements for AUPEO!

iPhone or iPod touch

- Install the latest version of the AUPEO! application on your iPhone or iPod touch. (Search for “AUPEO!” in the Apple iTunes App Store to find and install the most recent version.)
- Connect iPod touch/iPhone to this unit with a cable or via Bluetooth.
 - When connecting with a cable: Use KCA-iP202, KCA-HD100, KCA-iP102 (optional accessory) or KCA-iP103 (optional accessory).
 - When connecting via Bluetooth, the following profiles must be supported.
 - SPP (Serial Port Profile)
 - A2DP (Advanced Audio Distribution Profile)

Android™

- Visit Google play and search for “AUPEO!” to install.
- Bluetooth must be built in and the following profiles must be supported.
 - SPP (Serial Port Profile)
 - A2DP (Advanced Audio Distribution Profile)

NOTE

- Ensure you are logged in to your smartphone application. If you do not have an AUPEO! account, you can create one for free from your smartphone or at www.aupeo.com.
- Because AUPEO! is a third-party service, the specifications are subject to change without prior notice. Accordingly, compatibility may be impaired or some or all of the services may become unavailable.
- Some functions of AUPEO! cannot be operated from this unit.
- For issues using the application, contact AUPEO! at www.aupeo.com.
- Establish an Internet connection using LTE, 3G, EDGE, or WiFi.

TUNER (Only for DDX7015BT/DDX715WBT)

Listening to the radio

Indications and buttons on the source control screen



Tuner reception information

- 1 Band
- 2 Preset no.
- 3 The station frequency currently tuned in
 - The ST indicator lights up when receiving an FM stereo broadcast with sufficient signal strength.
- 5 Seek mode
- 6 TI indicator
- 7 Text information
 - Pressing [**<**] scrolls the text if not all of the text is shown.
 - Pressing [**Radio Text**] switches the information between Radio Text, Radio Text Plus, and PTY code.

Operation buttons

- [P1] – [P6] • Selects a stored station. (Press)
• Stores the current station. (Hold)
Displays the easy control screen. (Page 10)
- [] Displays the easy control screen. (Page 10)
- [PTY]* Enters PTY search mode. (Page 30)
- [AM] Selects the AM band.
- [FM] Selects the FM band.
→ FM1 → FM2 → FM3
- [SEEK] Changes the seek mode.
 - **AUTO1**: Auto Search
 - **AUTO2**: Tunes in stations in the memory one after another.
 - **MANU**: Manual Search
- [] [] Searches for a station.
 - The search method differs according to the selected seek mode. (See above.)
- [] Displays other operation buttons.
 - Disabled when there are no other buttons.
- [TI]* Activates/deactivates TI standby reception mode. (Page 30)
- [AME] Presets stations automatically. (Hold) (See the right column.)
- [MONO]* Activates/deactivates monaural mode for better FM reception. (Stereo effect will be lost.)
 - The MONO indicator lights up while monaural mode is activated.
- [] Changes the display information. (See the right column.)
- [MENU] Displays the <TOP MENU> screen.

* Appears only when FM is selected as the source.

Changing the display information



- The preset list containing the station names for FM RBDS (when a PS signal is coming in) is displayed.
- Press [] again to display the text information for the station currently being received.

Presetting stations

Storing stations in the memory

You can preset 6 stations for each band.

Automatic presetting—AME (Auto Memory)



The local stations with the strongest signals are found and stored automatically.

Continued on the next page...

TUNER

Manual presetting

- 1 Tune in to a station you want to preset. (Page 29)
- 2 Select a preset number.



The station selected in step 1 is stored.

Selecting a preset station



FM RBDS features

Searching for FM RBDS programs—PTY Search

You can search for your favorite programs being broadcast by selecting the PTY code.

1



2 Select a PTY code.



- You can change the page to display more items by pressing [▲]/[▼].

PTY Search starts.

If there is a station broadcasting a program of the same PTY code as you have selected, that station is tuned in.

Activating/deactivating TI Standby Reception



The unit is in standby to switch to Traffic Information (TI) if available. (The TI indicator lights up in white.)

- If the TI indicator is lit in orange, tune into another station providing RBDS signals.

To deactivate TI Standby Reception: Press [TI]. (The TI indicator turns off.)

- The volume adjustment for Traffic Information is automatically memorized. The next time the unit switches to Traffic Information, the volume is set to the previous level.

HD Radio™ tuner (Only for DDX5902)

About HD Radio™ Technology



PSD

- Program Service Data provides the song name, artist, station ID, and other relevant data streams

HD2/HD3

- Adjacent to traditional main stations are HD2/HD3 Channels, providing new original formats on the FM dial

Digital Sound

- HD Radio broadcasts deliver crystal-clear, CD-like digital audio quality to consumers

Artist Experience

- Artist Experience is the synchronous transmission, delivery, and display of images on the HD Radio receiver that are related to the specific audio segment.

Listening to the HD Radio™ broadcast

Indications and buttons on the source control screen

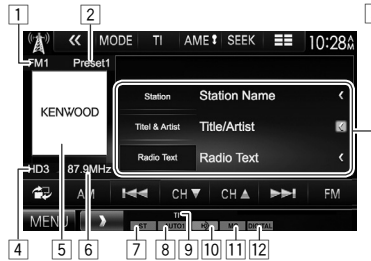

HD Radio reception information

- 1 Band
- 2 Preset no.
- 3 Text information
 - Pressing [**<**] scrolls the text if not all of the text is shown.
 - Pressing [**Radio Text**] switches the information between Radio Text, Message, PTY code and Station Name.
- 4 Channel no.
- 5 Picture or station logo if available
- 6 The station frequency currently tuned in
- 7 ST indicator: Lights up when receiving an FM stereo broadcast with sufficient signal strength.

- 8 Seek mode
- 9 TI indicator
- 10 HD indicator: Lights up when receiving an HD Radio broadcast.
- 11 MC indicator: Lights up when receiving an HD Radio multicast channel.
- 12 HD Radio reception mode (Page 32)
 - When digital signals are emitted, the DIGITAL indicator lights up.
 - When analog signals are emitted, the ANALOG indicator lights up.

HD Radio™ tuner

Operation buttons

- [] Displays the easy control screen. (Page 10)
- [**AM**] Selects the AM band.
- [**FM**] Selects the FM band.
→ FM1 → FM2 → FM3 →
- [] Searches for a station.
 - The search method differs according to the selected seek mode. (See below.)
- [] Searches for a station.
 - The search method differs according to the selected seek mode. (See below.)
- [**CH▼**] Selects a sub-channel when receiving an HD Radio multicast channel.
- [**CH▲**] Selects a sub-channel when receiving an HD Radio multicast channel.
- [] Displays other operation buttons.
 - Disabled when there are no other buttons.
- [**MODE**] Changes the settings for HD Radio tuner reception on the <Mode> screen. (See the right column.)
- [**TI**]* Activates/deactivates TI standby reception mode. (See the far right column.)
- [**AME**] Presets stations automatically. (Page 33)
- [**SEEK**] Changes the seek mode.
 - **AUTO1**: Auto Search
 - **AUTO2**: Tunes in stations in the memory one after another.
 - **MANU**: Manual Search
- [] Displays/hides the information of the current station. (See the right column.)
- [**PTY**]* Enters PTY search mode. (Page 33)
- [] Displays the <Preset List> screen. (Page 33)
- [**MENU**] Displays the <TOP MENU> screen.

* Appears only when FM is selected as the source.

Changing the display information



The preset list containing the station names is displayed.

- Press [] again to display the text information for the station currently being received.

Changing the HD Radio reception mode

While receiving an HD Radio broadcast, the unit tunes to digital or analog audio automatically according to the receiving condition.

1



2 Press [] [] to change the mode.



- <**Auto**> Switch between digital and analog audio automatically.
- <**Digital**> Select this to tune to digital audio only.
- <**Analog**> Select this to tune to analog audio only.

Activating/deactivating TI Standby Reception



The unit is in standby to switch to Traffic Information (TI) if available. (The TI indicator lights up in white.)

- If the TI indicator is lit in orange, tune into another station.

To deactivate TI Standby Reception: Press [**TI**]. (The TI indicator turns off.)

- The volume adjustment for Traffic Information is automatically memorized. The next time the unit switches to Traffic Information, the volume is set to the previous level.

HD Radio™ tuner

❑ Searching for FM HD Radio programs—PTY Search

You can search for your favorite programs being broadcast by selecting the PTY code.

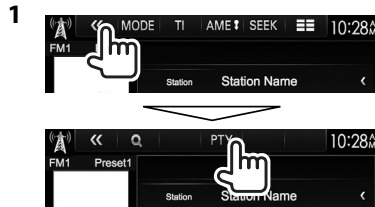

2 Select a PTY code.



- You can change the page to display more items by pressing [▲]/[▼].

PTY Search starts.

If there is a station broadcasting a program of the same PTY code as you have selected, that station is tuned in.

Presetting stations

❑ Storing stations in the memory

You can preset 6 stations for each band.

Automatic presetting—AME (Auto Memory)



Local stations with the strongest signals are found and stored automatically.

Manual presetting

- 1 Tune in to a station you want to preset. (Page 32)
- 2 Select a preset number.

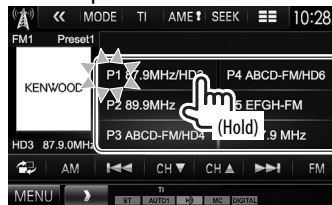

The station selected in step 1 is stored.

❑ Selecting a preset station from the list

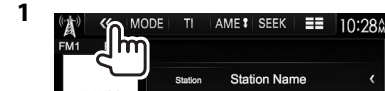

2 Select a station from the list.

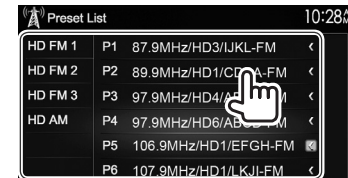

SiriusXM® Satellite Radio (Only for DDX5902)

Only SiriusXM® brings you more of what you love to listen to, all in one place. Get over 140 channels, including commercial-free music plus the best sports, news, talk, comedy and entertainment. Welcome to the world of satellite radio. A SiriusXM Vehicle Tuner and Subscription are required. For more information, visit www.siriusxm.com.

Activating subscription

1 Check your Radio ID.

The SiriusXM Satellite Radio ID is required for activation and can be found by tuning to Channel 0 as well as on the label found on the SiriusXM Connect tuner and its packaging.

- The Radio ID does not include the letters I, O, S or F.

2 Activate the SiriusXM Connect Vehicle Tuner using one of the two methods below:

- For users in the U.S.A:
 - Online:
Visit www.siriusxm.com/activatenow
 - Phone: Call SiriusXM Listener Care at 1-866-635-2349
- For users in Canada:
 - Online:
Visit www.siriusxm.ca/activatexm
 - Phone: Call XM customer Care at 1-877-438-9677

3 When the following screen appears, press [Return].

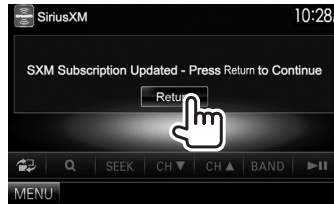

Listening to the SiriusXM® Satellite Radio

Indications and buttons on the source control screen



SiriusXM® Satellite Radio reception information

- 1 Band
- 2 Preset number
- 3 Information for the recorded data and the replay mode (Page 36)
- 4 Channel Logo or Channel number/Album art
- 5 Seek mode
- 6 Signal strength indicator
- 7 Text information
 - Pressing [**<**] scrolls the text if not all of the text is shown.

SiriusXM® Satellite Radio

Operation buttons

[Song Title]/ [Info]/ [Category]/ [Channel Description] Changes the displayed information each time this button is pressed.

[Easy Control] Displays the easy control screen. (Page 10)

[Q] Obtain information on channels or select a category and then a channel. (Page 36)

[SEEK] Changes the seek mode.

- **SEEK1:** Skip to another available channel.
- **SEEK2:** Skip to another preset channel.

[CH▼]/[CH▲] Selects the channel.

[BAND] Selects the band.
➤ SXM1 ➤ SXM2 ➤ SXM3 ➤ SXM4

[▶||] Starts/pauses the content replay. (Page 37)

[≡] Displays other operation buttons.

- Disabled when there are no other buttons.

[MODE] Changes the settings for SiriusXM Satellite Radio reception on the **<SiriusXM Mode>** screen. (Pages 37–40)

[Artist] Registers the artist of the current song as an alert content. (Page 38)

[Song] Registers the current song as an alert content. (Page 38)

[Alert] Activates/deactivates the content alert for traffic and weather information. (Page 39)

[Preset List] Displays the preset list. (See below.)

[◀◀]/[▶▶] Used while replaying content.

[SCAN]/[LIVE] (Page 37)

[MENU] Displays the **<TOP MENU>** screen.

Presetting channels

❑ Displaying the preset list

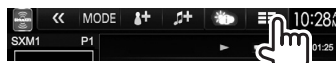

- Pressing **[≡]** again displays the text information for the station currently being received.

❑ Storing channels in the memory

You can preset 6 channels for each band.

- 1 Tune in to a channel you want to preset. (Page 34)
- 2 Display the preset list. (See the left column.)
- 3 Select a preset number.

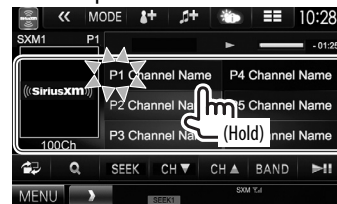

The channel selected in step 1 is stored.

❑ Selecting a preset channel

- 1 Display the preset list. (See the left column.)



SiriusXM® Satellite Radio

Selecting a channel

❑ Selecting a channel on the list

You can obtain information on channels or select a category and then a channel.

1 Display the **<List Type Select>** screen.



2 Select the list type.

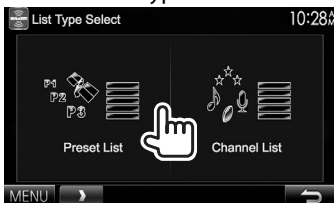

<Preset List>

Selects from the preset list.
• To preset the channels, see page 35.

<Channel List>

Selects from the channel names (Channel List).

3 Select a channel.

On the **<Preset List>** screen

Select a band (1), and then select a preset channel (2).



On the **<Channel List>** screen

Select a category (1), and then select a channel (2).



- You can change the page to display more items by pressing [▲]/[▼].
- To list all the channels, select **[All Channels]**.



- Pressing the info change button above the list displays information in the following order:
Channel Name, Artist Name, Song Title, Content Info



Replay

You can pause, rewind and replay content from the currently tuned channel.

- The SiriusXM Connect Vehicle Tuner continually buffers up to 60 minutes of audio.
- If you change to another channel during playback, the Replay buffer content will be lost.

❑ Indications on the source control screen



1 Playback status

2 Progress bar

Shows the remaining capacity (gray) and the amount of buffered content (blue). If the Replay buffer is full, the entire bar becomes blue.

- Updated every second.

3 Time code

Shows you the point in the Replay buffer you are listening to.

- Example: -5:00

– You are listening to audio that is 5 minutes behind the current broadcast.

- Updated every second.

SiriusXM® Satellite Radio

Replaying content

1 Display operations buttons for replay.

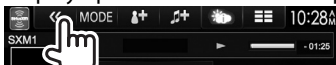

2

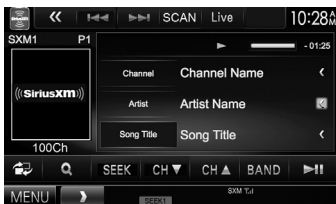

- To start/pause the playback, press [▶||].
- To skip the current track segment, press [◀◀]/[▶▶].
 - Pressing [◀◀] within 2 seconds of the beginning of the current track/segment returns to the previous track.
 - Pressing [◀◀] after 2 seconds or more of the track have been replayed returns to the beginning of the current track/segment.
- To rewind/fast forward, press and hold [◀◀]/[▶▶].
- To return to the live position, press [LIVE].

SmartFavorites

User stored channels (P1 to P6) are recognized as SmartFavorites channels. SiriusXM Connect Vehicle Tuner automatically buffers their broadcast content in the background. When you select a SmartFavorite channel, you can rewind and replay up to 30 minutes of any of the missed news, talk, sports or music content.

- SmartFavorites is available only when you connect an SXV200 or later SiriusXM Connect Vehicle Tuner.
- If you change to another band, the buffered content is cleared and new channels in the current band will start buffering.

TuneStart™

When you select a preset channel, you can listen to the current song from the beginning.

Activating TuneStart™

1



2

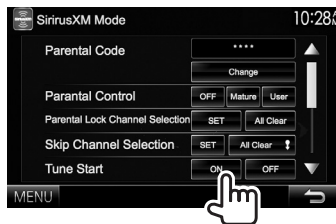

To deactivate TuneStart: Select [OFF] for <TuneStart>.

TuneScan™

When you activate TuneScan™, you will hear 6 seconds of the songs, which have not been listened to, from each of the music channel presets on the current Band.

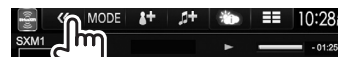

The unit starts scanning.

- To select the previous/next content, press [◀◀] or [▶▶].
- To end scanning and continue listening to the current song/content, press [SCAN].
- To exit scanning, press and hold [SCAN].

SiriusXM® Satellite Radio

Receiving alerts for desired content — Content Alert

The unit informs you when receiving the content you are interested in such as music, information about a sports team, weather and traffic information.

Registering content alerts

For artists/songs



Registers the artist of the current song.

Registers the current song.

For sports teams



- Press [▼] repeatedly to change the page on the <SiriusXM Mode> screen.



- 3
- Select the league (①) and the team (②) then register the content alert (③).



Selecting the content for the content alert

For artists/songs/sports teams



- Press [▼] repeatedly to change the page on the <SiriusXM Mode> screen.



- 3
- Select the category (①), then the item (②).

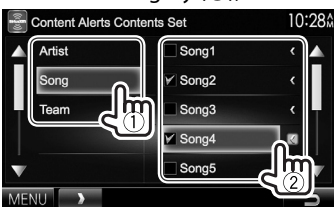

The checkmark appears beside the selected item.

- To show the details of the item, press [←].
- To delete the registered items, press and hold the item you want to delete (①) (trash icon) and a checkmark is shown beside the selected item, then press [←] (②).



- To delete all registered items, press and hold [All Clear] for <Content Alerts Contents Set>.

For traffic and weather information



- Press [▼] repeatedly to change the page on the <SiriusXM Mode> screen.

- 2
- Select the city for which you want receive traffic and weather information.



SiriusXM® Satellite Radio

❑ Activating content alerts

For artists/songs/sports teams

1



- Press [▼] repeatedly to change the page on the <SiriusXM Mode> screen.

2



- To deactivate content alerts: Select [OFF] for <Content Alerts>.

For traffic and weather information

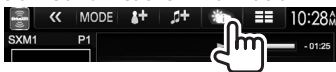

- To deactivate the content alert : press [🗨️] again.

❑ Switching registered content

When receiving the contents registered for content alerts, an alert appears on the screen. Press [Jump], then select the item to jump on the <Content Alerts> screen.



- To show the details of the item, press [<].

Setting reception restrictions

❑ Setting the parental control

You can limit access to SiriusXM channels, such as those with mature content.

Setting/Changing the parental code

- The initial setting is "0000."
- Changing the code does not change the <Parental Control>/<Parental Lock Channel Selection> settings.

- 1 Display the <Parental Code Check> screen.



- 2 Enter a four-digit code (①), and then confirm (②).

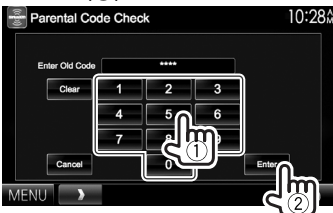

- To clear the entry, press [Clear].
- To cancel setting the code, press [Cancel].

- 3 Enter a new four-digit code (①), and then confirm (②).



- To clear the entry, press [Clear].
- To cancel setting the code, press [Cancel].

- 4 Enter the four-digit code and then press [Enter] again to confirm the code.

Activating/Deactivating the parental control

You can set the parental control feature to lock any SiriusXM channel(s) or automatically lock all channels classified as "mature" by SiriusXM®.

1



2



[OFF] Deactivates the parental mature and user lock.

[Mature] Locks channels classified as "mature" only.

[User] Locks only the selected channels.

- 3 Enter the parental code to confirm your choice.

Continued on the next page...

SiriusXM® Satellite Radio

Selecting the channels to lock—Parental Lock Channel

This parental control option allows you to pick the channels to be locked by the parental control feature.

- When <Parental Control> is set to [Mature] or [OFF], you cannot change the <Parental Lock Channel Selection> setting.



2 Enter the parental code.

3 Select a category (1), and then a channel (2).



- You can change the page to display more items by pressing [▲]/[▼].
- To list all the channels, select [All Channels].
- A check mark appears beside the selected channel.

Repeat this step if you want to set the lock on multiple channels.

To deactivate the parental lock for all locked channels: Select [All Clear] for <Parental Lock Channel Selection> on the <SiriusXM Mode> screen, then enter the parental code number.

☐ Skipping unwanted channels

If you do not want to receive some channels, you can skip them.

Activating the channel skipping



2 Select a category (1), and then select a channel (2).

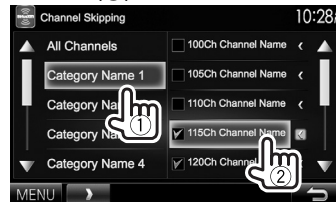

- You can change the page to display more items by pressing [▲]/[▼].
- To list all the channels, select [All Channels].
- A check mark appears beside the selected channel.

Repeat this step if you want to skip multiple channels.

To clear the channel skipping for all skipped channels: Press and hold [All Clear] in <Skip Channel Selection> on the <SiriusXM Mode> screen.

☐ Resetting the SiriusXM Satellite Radio settings

You can reset the SiriusXM Satellite Radio settings you set up and restore the default settings.



- Press [▼] repeatedly to change the page on the <SiriusXM Mode> screen.



OTHER EXTERNAL COMPONENTS

Using external audio/video players—AV-IN

When the operation buttons are not displayed on the screen, touch the area shown on the illustration.

- To change settings for video playback, see page 55.



You can connect an external component to the AV-IN1 and iPod/AV-IN2 input terminals. (Page 71)

Indications and buttons on the source control screen



Operation buttons

- [MODE]** Changes the AV-IN name.
- Press [◀] or [▶] to select an AV-IN name.
 - This setting does not affect the source name “AV-IN 1”/ “AV-IN 2” displayed on the <TOP MENU>.
- [MENU]** Displays the <TOP MENU> screen.

Starting playback

- 1 Connect an external component to the AV-IN1 or iPod/AV-IN2 input terminal. (Page 71)
- 2 Select “AV-IN1” or “AV-IN2” as the source.
 - Press [▼] to change the page on the <TOP MENU> screen.



- 3 Turn on the connected component and start playing the source.

Using a rear view camera

- To connect a rear view camera, see page 71.
- To use a rear view camera, a REVERSE lead connection is required. (Pages 68 and 69)

Activating the rear view camera

- 1 Display the <Input> setting screen. On the <TOP MENU> screen:



- 2



To deactivate: Select [OFF] for <R-CAM Interrupt>.

OTHER EXTERNAL COMPONENTS

❑ Displaying the picture from the rear view camera

The rear view screen is displayed when you shift the gear to the reverse (R) position.



- To erase the caution message, touch the screen.

To display the picture from the rear view camera manually DDX7015BT*1

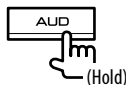

DDX5902*2



DDX715WBT*3

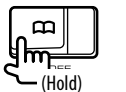

- When displaying the picture from the rear view camera manually, you can change the picture settings using **[Aspect]/[PictureAdjust]**. (Page 55)

To exit the rear view screen: Press and hold the same button again.

- *1 This operation works only when **<AUD Key Long Press>** is set to **[R-CAM]**. (Page 62)
- *2 This operation works only when **<TEL Key Long Press>** is set to **[R-CAM]**. (Page 62)
- *3 This operation works only when **<P.BOOK Key Long Press>** is set to **[R-CAM]**. (Page 62)

❑ Using the parking guidelines

You can display parking guidelines to enable easier parking when you shift the gear to the reverse (R) position.

Displaying the parking guidelines

1 Display the **<Display>** setting screen.

On the **<TOP MENU>** screen:

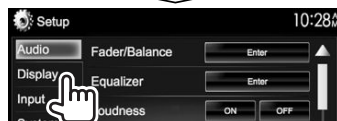
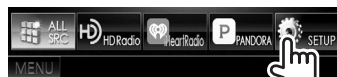

- Press [▼] repeatedly to change the page on the **<Display>** menu screen.

2



To deactivate: Select **[OFF]** for **<Parking Guidelines>**.

Adjusting the parking guidelines

Adjust the parking guidelines according to the size of the car, parking space and so on.

- Install the rear view camera in the appropriate position according to the instructions supplied with the rear view camera.
- When adjusting the parking guidelines, make sure to use the parking brake to prevent the car from moving.

1 Display the **<Display>** setting screen. (See the left column).

- Press [▼] repeatedly to change the page on the **<Display>** menu screen.

2

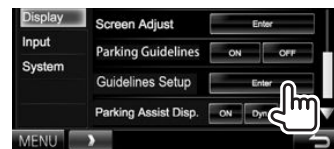

3 Adjust the parking guidelines by selecting the mark (1), then adjusting the position of the selected mark (2).

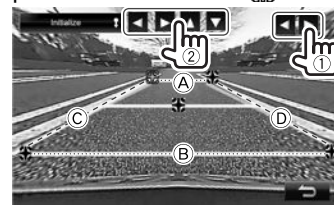

Make sure that (A) and (B) are horizontally parallel, and that (C) and (D) are the same length.

- Press and hold **[Initialize]** for 2 seconds to set all the marks to the initial default position.

OTHER EXTERNAL COMPONENTS

Using a smartphone—HDMI/MHL

❑ What is HDMI/MHL?

HDMI stands for High Definition Multi-media Interface. HDMI connections can transfer digital video source signals (such as from a DVD player) without converting them to analog.

A new feature that has been added to HDMI that extends its capabilities further is MHL, or Mobile High-definition Link.

Both interfaces allow your smartphone to connect to the device. When it is connected, you can see your smartphone's screen on the monitor.

About Miracast Dongles

This unit is compatible with Miracast Dongles.

Connecting a Miracast Dongle (KCA-WL100: optional accessory) to the HDMI/MHL input terminal (Page 71) enables you to enjoy listening to music, watching videos, or viewing pictures over a wireless connection.

- For details about Miracast Dongle settings, etc., refer to the instructions supplied with the Miracast Dongle.

❑ Displaying the screen of the smartphone

You can display the screen of smartphones connected via the HDMI/MHL input terminal.

- 1 Connect your smartphone to the HDMI/MHL input terminal. (Page 71)
 - Use HDMI cable KCA-HD100 (optional accessory) or MHL cable KCA-MH100 (optional accessory).
- 2 Select **"HDMI/MHL"** as the source. On the **<TOP MENU>** screen:



- 3 Start an application or playback on your smartphone.

Using an external component via ADS adapter—OEM Features (Only for DDX5902)

You can control the sources from the component via ADS adapter.

- **Preparation:** Configure the settings on the **<OEM Setup>** screen beforehand. (Page 62)

- 1 Connect the ADS adapter to the iDataLink input terminal. (Page 71)
- 2 Select **"OEM Features"** as the source. (Page 11) On the **<TOP MENU>** screen:
 - Press [**▼**] to change the page on the **<TOP MENU>** screen.

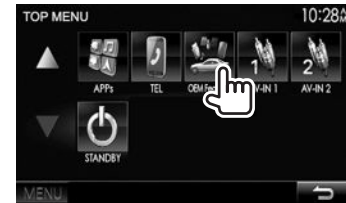

- 3 Turn on the connected component and start playing the source.

BLUETOOTH

Information for using Bluetooth® devices



Bluetooth is a short-range wireless radio communication technology for mobile devices such as mobile phones, portable PCs, and other devices. Bluetooth devices can be connected without cables and communicate with each other.

Notes

- While driving, do not perform complicated operations such as dialing numbers, using the phone book, etc. When you perform these operations, stop your car in a safe place.
- Some Bluetooth devices may not connect to this unit depending on the Bluetooth version of the device.
- This unit may not work for some Bluetooth devices.
- Connecting conditions may vary depending on your environment.
- For some Bluetooth devices, the device is disconnected when the unit is turned off.

About mobile phones compatible with Phone book Access Profile (PBAP)

If your mobile phone supports PBAP, you can display the phone book and call lists on the touch panel screen when the mobile phone is connected.

- Phone book: up to 600 entries
- Dialed calls, received calls, and missed calls: up to 10 entries each

Connecting Bluetooth devices

❑ Registering a new Bluetooth device

When you connect a Bluetooth device to the unit for the first time, pair the unit and the device. Pairing allows Bluetooth devices to communicate with each other.

- The pairing method differs depending on the Bluetooth version of the device.
 - For devices with Bluetooth 2.1: You can pair the device and the unit using SSP (Secure Simple Pairing) which only requires confirmation.
 - For devices with Bluetooth 2.0: You need to enter a PIN code both on the device and unit for pairing.
- Once the connection is established, it is registered in the unit even if you reset the unit. Up to 5 devices can be registered in total.
- Two devices for Bluetooth phone and one for Bluetooth audio can be connected at a time.
- To use the Bluetooth function, you need to turn on the Bluetooth function of the device.
- To use the registered device, you need to connect the device to the unit. (Page 46)

Auto pairing

When <Auto Pairing> is set to [ON], iOS devices (such as iPhone) are automatically paired when connected via USB. (Page 51)

Pairing a Bluetooth device using SSP (for Bluetooth 2.1)

When the Bluetooth device is compatible with Bluetooth 2.1, a pairing request is sent from an available device.

- 1 Search the unit (“DDX****”) from your Bluetooth device.
- 2 Confirm the request both on the device and the unit.

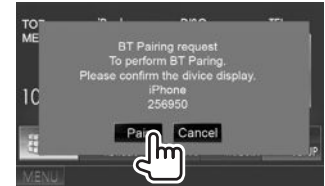

- Press [Cancel] to reject the request.

BLUETOOTH

Pairing a Bluetooth device from the target device using a PIN code (for Bluetooth 2.0)

1 Display the <Bluetooth Setup> screen.

On the <TOP MENU> screen:



- You can also display the <Bluetooth Setup> screen by pressing [**1**] on the phone control screen. (Page 48)



2 Change the PIN code.

- If you wish to skip changing the PIN code, go to step 3.
- The PIN code is initially set to "0000".
- The maximum number of digits in the PIN code is 15.

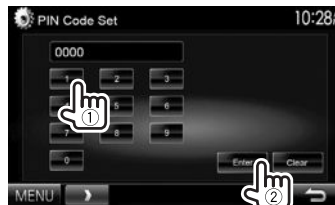

- Press [**Clear**] to delete the last entry.
- #### 3 Search for the unit ("DDX****") from your Bluetooth device.

- #### 4 Select the unit ("DDX****") on your Bluetooth device.
- If a PIN code is required, enter "0000" (initial).

When pairing is complete, the device is listed on the <Paired Device List>.



- To use the paired device, connect the device on the <Paired Device List>. (Page 46)

BLUETOOTH

Pairing a Bluetooth device from this unit using a PIN code (for Bluetooth 2.0)

1 Display the <Bluetooth Setup> screen. (Page 45)



3 Search for the available devices.

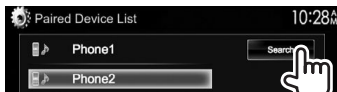

• To cancel searching devices, press [Cancel].

4 Select the device you want to pair.



• If a PIN code is required, enter "0000" (initial).

Connecting/disconnecting a registered Bluetooth device

Two devices can be connected simultaneously.

1 Display the <Bluetooth Setup> screen. (Page 45)



3 Select the device you want to connect (①), then press [Connection] (②).



4 Select [ON] or [OFF] for the target.

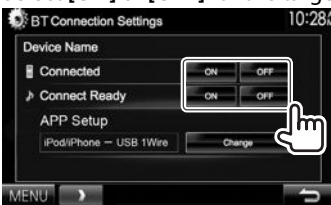

📱: Mobile phone

🎵: Audio device

- The status is shown as follows:
 - "Connected": A connection has been established.
 - "Connect Ready": A connection can be established.
 - "Disconnected": No connection is established.
- Press [Change] for <APP Setup> to display the <APP Settings> screen to configure settings for applications of iPod/iPhone/Android. (Page 52)

• When a Bluetooth mobile phone is connected, the signal strength and battery level are displayed when the information is acquired from the device.

Deleting a registered Bluetooth device

1 Display the <Bluetooth Setup> screen. (Page 45)



3 Select a device to delete (①), then press [Remove] (②).



A confirmation message appears. Press [Yes].

BLUETOOTH

Using a Bluetooth mobile phone

❑ Receiving a call

When a call comes in...

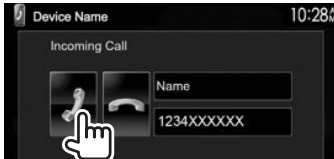

- Call information is displayed if acquired.
- Phone operation is not available while the picture from the rear view camera is displayed. (Page 41)

To reject a call



When **<Auto Response>** is set to **[ON]** (Page 51)
The unit answers incoming calls automatically.

❑ Ending a call

While talking...



❑ Adjusting the volume of calls/earpiece/microphone

While talking...







- You can adjust the volume level between 0 to 15 (initial: 3).
- Use the monitor panel to adjust the call/earpiece volume. (Page 8)

❑ Switching between handsfree mode and phone mode

While talking...



Each time you press the button, the talking method is switched (  : handsfree mode /   : phone mode).

❑ Adjusting the echo cancel level/reducing noise

While talking...



- **To adjust the echo volume (between -1 to +1, initial: 0):** Adjust **<EC LEVEL>**.
- **To adjust the noise reduction volume (between 0 to -20, initial: -10):** Adjust **<NR LEVEL>**.

BLUETOOTH

❑ Sending text during a call

You can send text during a call using the DTMF (Dual Tone Multi Frequency) function.

While talking...



❑ Switching between two connected devices

When 2 devices are connected, you can change the device to use.

On the phone control screen:



- The name of the active device appears. The devices are switched each time the button is pressed.

❑ Making a call

- 1 Display the phone control screen.

On the <TOP MENU> screen:

- Press [▼] to change the page on the <TOP MENU> screen.



- You can also display the phone control screen by pressing TEL on the monitor panel.

- 2 Select a method to make a call.

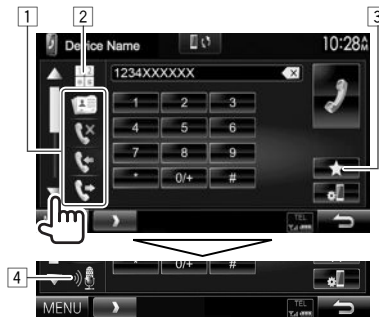

- You can show more items by pressing [▲]/[▼].
- 1 From the phone book*/call lists
 - 2 Direct number entry
 - 3 From the preset list
 - To preset, see page 50.
 - 4 Voice dialing

- You can display the <Bluetooth Setup> screen by pressing [▲]/[▼].

* When the mobile phone is not compatible with Phone Book Access Profile (PBAP), the phone book is not displayed.

From the preset list/phone book/call lists

1



- [★] From the preset list
- [📖] From the phone book
 - For DDX715WB: You can also display the phone book by pressing [📖]/V.OFF on the monitor panel.

- [📞] From the missed call list
- [📞] From the received call list
- [📞] From the dialed call list

- 2 Select the target (1), then make a call (2).



- You can change the page to display more items by pressing [▲]/[▼].

BLUETOOTH

- To use the A to Z search in the phone book:
When the phone book list is displayed, you can search by initial.



- 2 Select the initial.
- If the initial character is a number, press [1,2,3...] and then select the number.



- 3 Select a phone number from the list.



- To display other phone numbers:
When the phone book list is displayed, you can switch between phone numbers if several phone numbers are registered for the same person.

- 1 Switch the phone number.



- The phone number switches each time [>] is pressed.
- 2 Select a phone number to call.



Direct number entry

You can enter up to 31 numbers.

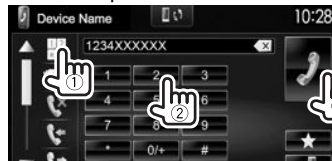

- Press [X] to delete the last entry.
- Press and hold [0/+] to add "+" to the phone number.

Voice dialing

- Available only when the connected mobile phone has a voice recognition system.

- 1 Activate voice dialing.
On the phone control screen:
- Press [▼] repeatedly to change the page on the phone control screen.



- You can also activate voice dialing by holding TEL on the monitor panel.*
- 2 Say the name of the person you want to call.
- If the unit cannot find the target, the following screen appears. Press [Start], then say the name again.



To cancel voice dialing: Press [Cancel].

- * For DDX5902: This operation works only when <TEL Key Long Press> is set to [Voice]. (Page 62)

BLUETOOTH

❑ Presetting phone numbers

You can preset up to 5 phone numbers.

- 1 Display the phone control screen.
(Page 48)
- 2 Enter the numbers on the direct number entry screen, then display the preset list.



- 3 Select a preset number to store into.



- To display the preset list, press [★] on the phone control screen.

Using the Bluetooth audio player

- To register a new device, see page 44.
- To connect/disconnect a device, see page 46.

❑ Indications and buttons on the source control screen



- The operation buttons, indications and information displayed on the screen differ depending on the connected device.

Playback information

- 1 Playback status*
- 2 Playing time*
- 3 Tag data (current track title/artist name/album title)*
 - Pressing [<] scrolls the text if not all of the text is shown.
- 4 The signal strength and battery level (only when the information is acquired from the device)

Operation buttons

- [📄] Displays the easy control screen. (Page 10)
- [⏪] [⏩] • Selects a track. (Press)
• Reverse/forward search.* (Hold)
- [▶] Starts playback.
- [⏸] Pauses playback.
- [MENU] Displays the <TOP MENU> screen.

* Available only for devices compatible with AVRCP 1.3.

BLUETOOTH

Settings for Bluetooth devices

You can change various settings for using Bluetooth devices on the **<Bluetooth Setup>** screen.

- 1 Display the **<Bluetooth Setup>** screen. On the **<TOP MENU>** screen:

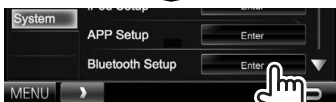
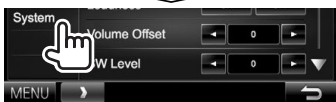

- You can also display the **<Bluetooth Setup>** screen by pressing [**SETUP**] on the phone control screen. (Page 48)



- 2 Configure the Bluetooth settings.



Setting items

<Paired Device List>	Press [Enter] to show the list of registered devices. You can connect a device or delete registered devices. (Page 46)
<PIN Code>	Changes the PIN code of the unit. (Page 45)
<Device Name>	Shows the device name to be shown on the Bluetooth device — DDX**** .
<Device Address>	Shows the device address of the unit.
<Auto Connect>	<ul style="list-style-type: none"> • ON (Initial): A connection is automatically established with the last connected Bluetooth device when the unit is turned on. • OFF: Cancels.
<Bluetooth HF/Audio>	Select the speakers used for Bluetooth (both phone and audio player). <ul style="list-style-type: none"> • Front Only: Front speakers only. • All (Initial): All speakers.
<Auto Response>	<ul style="list-style-type: none"> • ON: The unit answers the incoming calls automatically after 5 seconds. • OFF (Initial): The unit does not answer the calls automatically. Answer the calls manually.

<Auto Pairing>	<ul style="list-style-type: none"> • ON (Initial): Establishes pairing automatically with the connected iOS device (such as iPhone) even if the Bluetooth function is deactivated on the device. (Auto pairing may not work for some devices depending on the iOS version.) • OFF: Cancels.
<Ring Mode>	<ul style="list-style-type: none"> • System (Initial): The ring tone set on the unit is used. • Phone: The ring tone set on the mobile phone is used. (This function may not work depending on the mobile phone.)
<Ring Tone Change>	When <Ring Mode> is set to <System> , select the ring tone for received calls and SMS from [Tone1] (Initial) , [Tone2] , [Tone3] .
<Initialize>	Hold [Enter] to reset all settings you have made for using Bluetooth mobile phones and Bluetooth audio players.

SETTINGS

Settings for using applications of iPod/iPhone/Android

Before using applications of iPod/iPhone/Android such as Pandora, iHeartRADIO, or AUPELO!, select the device to use and connection method.

When connecting the device for first time, the setup screen (for connection, etc.) appears. Follow the procedure on the setup screen to configure the settings.

- 1 Pair the iPod/iPhone/Android device through Bluetooth. (Page 44)
- 2 Display the **<APP Setup>** screen.

On the **<TOP MENU>** screen:



- If **[Enter]** for **<APP Setup>** cannot be selected, put the unit in standby. (Page 9)

- 3 Display the **<APP Settings>** screen.



- If you do not need to change the setting, press **[OK]** to exit from the setup screen.

- 5 Select the device type (①), then press **[Next]** (②).



- 6 Select the connection method (①), then press **[Next]** (②).

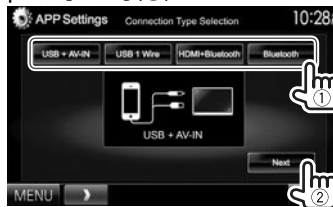

For Android:

<HDMI/MHL + Bluetooth> Select this when the Android is connected both by cable to the HDMI/MHL input terminal and via Bluetooth.

<Bluetooth> Select this when the device is connected via Bluetooth.

For iPod/iPhone:

<USB + AV-IN> Select this when the iPod/iPhone is connected using KCA-iP202 (optional accessory).

<USB 1 Wire> Select this when the iPod/iPhone is connected using KCA-iP102 (optional accessory) or KCA-iP103 (optional accessory).

<HDMI + Bluetooth> Select this when the iPod/iPhone is connected using HDMI cable KCA-HD100 (optional accessory) and KCA-iP103 (optional accessory) through a Lightning-Digital AV adapter (accessory of the iPod/iPhone).

<Bluetooth> Select this when the iPod/iPhone is connected via Bluetooth.

- When selecting **<USB + AV-IN>** or **<USB 1 Wire>**, go to step 8.

- 7 When selecting **<HDMI + Bluetooth>** or **<Bluetooth>** as the connection method, the device selection screen appears. Search for the available iPod/iPhone/Android devices (①), select the target device from the list (②), then press **[Next]**.



- You can change the page to display more items by pressing **[▲]/[▼]**.
- If the device is already listed, skip step ①.
- To stop searching, press **[Cancel]**.

- 8 Confirm the settings.



SETTINGS

Sound adjustment

Using the sound equalization

- The adjustment is memorized for each source until you adjust the sound again. If the source is a disc, the adjustment is stored for each of the following categories.
 - DVD/DVD-VR/VCD
 - CD
 - DivX/MPEG1/MPEG2/MP3/WMA/AAC
- You cannot adjust the sound when the unit is in standby.

Selecting a preset sound mode

- 1 Display the **<Equalizer>** screen.
On the **<TOP MENU>** screen:

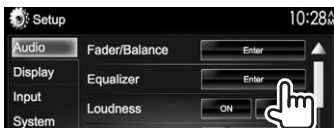
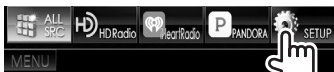

- 2 Select a sound mode.

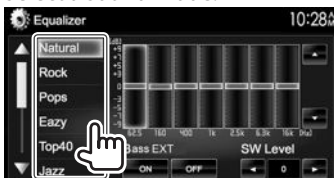

- You can change the page to display more items by pressing [▲]/[▼].

- You can also display the **<Equalizer>** screen by pressing AUD (for DDX7015BT)/AUDIO (for DDX715WBT) or by pressing and holding the Volume/ATT/AUDIO knob (for DDX5902) on the monitor panel.

Storing your own adjustment—Adjusting the sound precisely

- 1 Select a sound mode. (See the left column.)
- 2 Select a band and adjust the level of the selected band.
 - The number of bands depends on the model.
 - You can adjust the level by dragging the slider or using [▲]/[▼].
 - Repeat this step to adjust the level of other bands.

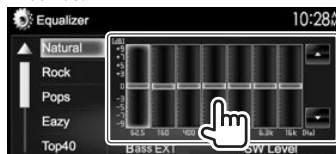

The adjustments are stored and **<User>** is activated.

- 3 Activate (**[ON]**) or deactivate (**[OFF]**) the bass (**<Bass EXT>**) (1), and then adjust the subwoofer level (2).

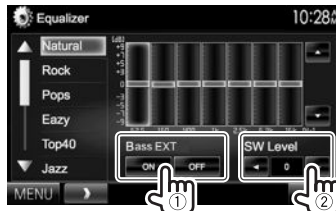

Setting the car type and speakers

- 1 Display the **<Car Setting>** screen.
On the **<TOP MENU>** screen:
 - Press [▼] repeatedly to change the page on the **<Audio>** menu screen.

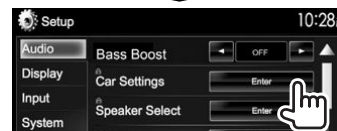

- 2 Select a car type (1), and then select the location of the speakers (2).



SETTINGS

❑ Setting the speakers—speaker size and crossover frequency

1 Display the <Speaker Select> screen.

On the <TOP MENU> screen:

- Press [▼] repeatedly to change the page on the <Audio> menu screen.

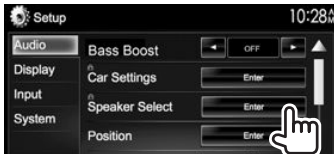

2 Select the speaker type (front speakers, rear speakers, or subwoofer).



3 Select the size of the selected speaker.



4 Adjust the crossover frequency of the selected speaker.

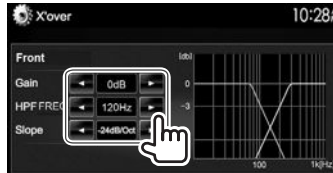

- <Gain> Adjusts the output volume of the selected speaker.
- <HPF FREQ> Adjusts the crossover frequency for the front or rear speakers (high pass filter).*1
- <LPF FREQ> Adjusts the crossover for the subwoofer (low pass filter).*2
- <Slope> Adjusts the crossover slope.
- <Phase> Selects the phase for the subwoofer.*2

*1 Appears only when the front or rear speakers are selected.

*2 Appears only when the subwoofer is selected.

❑ Setting the listening position

You can adjust the sound effects according to your listening position.

1 Display the <Position> screen.

On the <TOP MENU> screen:

- Press [▼] repeatedly to change the page on the <Audio> menu screen.



2 Select the listening position ([All], [Front L], [Front R] or [Front All]).



SETTINGS

Adjusting the Digital Time Alignment (DTA)

Make fine adjustments to the delay time of the speaker output to create a more suitable environment for your vehicle.

- 1 Display the **<Position>** screen. (Page 54)
- 2 Display the **<Position DTA>** screen.



- 3 Select the speaker you want to adjust (①), and then adjust each item (②).



<Distance> Adjusts the Digital Time Alignment (DTA) value.

<Gain> Adjusts the output volume of the selected speaker.

- To determine the adjustment value, see the right column.
- To initialize the setting value, press **[Initialize]**.

Determining the value for <Position DTA> adjustment

If you specify the distance from the center of the currently set listening position to every speaker, the delay time will be automatically computed and set.

- ① Determine the center of the currently set listening position as the reference point.
- ② Measure the distances from the reference point to the speakers.
- ③ Calculate the differences between the distance of the furthest speaker and other speakers.
- ④ Set the DTA value calculated in step ③ for individual speakers.
- ⑤ Adjust gain for individual speakers.

Example: When **[Front All]** is selected as the listening position

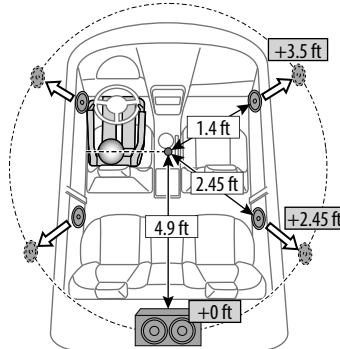

Adjustment for video playback

Adjusting the picture

You can adjust the picture quality.

- 1 Display the adjustment menu.

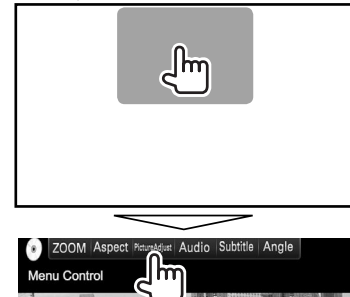

- 2 Select **[DIM ON]** (dimmer on) or **[DIM OFF]** (dimmer off).



Continued on the next page...

SETTINGS

3 Adjust the picture.



- <Bright>** Adjusts the brightness. (-15 to +15)
- <Contrast>** Adjusts the contrast. (-10 to +10)
- <Black>** Adjusts the blackness. (-10 to +10)
- <Color>** Adjusts the color. (-10 to +10)
- <Tint>** Adjusts the tint. (-10 to +10)
- <Sharpness>** Adjusts the sharpness. (-2 to +2)

❑ Changing the aspect ratio





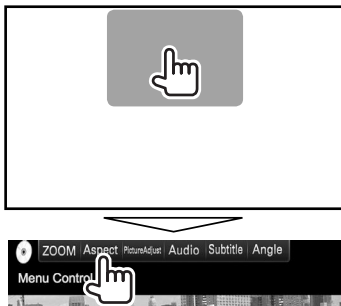

You can change the aspect ratio for video playback.

1 Display the adjustment menu.



2 Select the aspect ratio.



- <Full>*** For 16:9 original pictures
 - 4:3 signal 
 - 16:9 signal 
- <Normal>*** For 4:3 original pictures
 - 4:3 signal 
 - 16:9 signal 
- <Just>** For viewing 4:3 pictures naturally on the wide screen
 - 4:3 signal 
 - 16:9 signal 
- <Zoom1>** –
- <Zoom3>**
 - Changes the magnification.
 - The aspect ratio is automatically selected to match the video source.

* While DivX is played back with **<Screen Ratio>** set to [16:9] (Page 16), the aspect ratio may not set correctly.

❑ Zooming the picture

You can zoom the picture. Zooming is available only when discs are played back.

1 Display the adjustment menu.

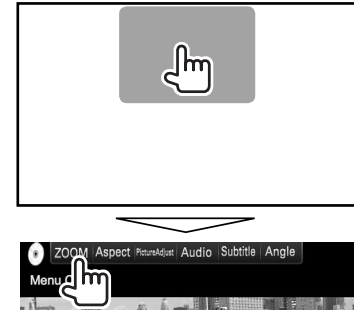

2 Change the magnification (①), then move the zooming frame (②).



- The zoom function cannot be used for some video sources.

SETTINGS

Changing the display design

You can change the background and panel color.

1 Display the **<User Customize>** screen.

On the **<TOP MENU>** screen:

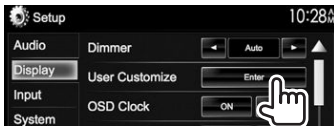
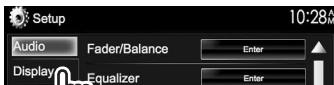
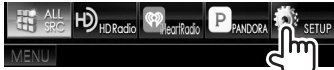

2 Select an item to change (background design: **[Background]**/panel color: **[Panel Color]**).

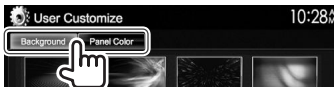

3 Select a background/panel color.
To select a background

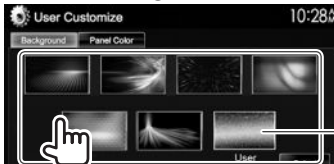

- The number of preset backgrounds and the designs available differ depending on the model.

To select a panel color



- Selecting **[Scan]** changes the illumination color gradually.

*1 Store your own scene beforehand. (See the right column.)

*2 Store your own color adjustment beforehand. (See below.)

□ Making your own color adjustment

1 Select **[Panel Color]** on the **<User Customize>** screen. (See the left column.)



2 Select the dimmer setting for the color (1), then adjust the color (2).



□ Storing your favorite image for the background

You can set your favorite image stored on the connected USB device.

- Use a JPEG/PNG/BMP file with a resolution of 800 x 480 pixels.
- The color of the captured image may look different from that of the actual scene.

1 Connect the USB device on which the image is stored. (Page 70)

2 Display the **<User Customize>** screen. (See the far left column.)

3 Display the file selection screen.

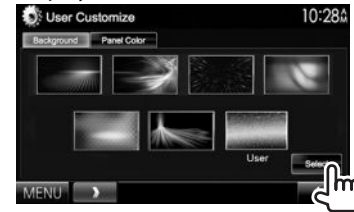

4 Select the folder (1), then the file for the background image in the selected folder (2).



- You can change the page to display more items by pressing **[▲]**/**[▼]**.

A confirmation message appears. Press **[OK]** to store the new image. (The existing image is replaced with the new one.)

SETTINGS

Customizing the <TOP MENU> screen

You can arrange the items to display on the <TOP MENU> screen.

- 1 Display the <Menu Customize> screen. On the <TOP MENU> screen:
 - Press [▼] repeatedly to change the page on the <Display> menu screen.

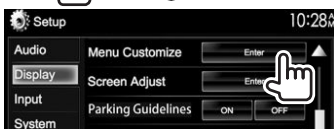
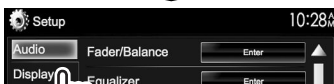
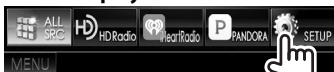

- 2 Select the position to place the icon (①), then select the item you want to display in the selected position (②).



Repeat this step to place icons for other items.

Customizing the system settings

Memorizing/recalling the settings

- You can memorize the settings changed in the <Setup> menu and recall the memorized settings any time.
- The memorized settings are kept even when the unit is reset.

- 1 Display the <SETUP Memory> screen. On the <TOP MENU> screen:
 - Press [▼] repeatedly to change the page on the <System> menu screen.

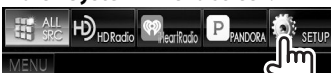

2



- To cancel, press [No].

3 Select an operation.



- [Recall]** Recalls the memorized settings.
- [Memory]** Memorizes the current settings.
- [Clear]** Clears the currently memorized settings.

- To cancel, press [Cancel].

A confirmation message appears. Press [Yes].

SETTINGS

❑ Locking the settings

You can lock the settings to prevent them from being changed.

-  is shown beside the settings that can be locked.

1 Display the **<SETUP Memory>** screen.
(Page 58)



To unlock the setting: Press [**Unlock**].

❑ Updating the system

You can update the system by connecting a USB device containing an update file.

- To update the system, visit <http://www2.jvckenwood.com/cs/ce/>.

1 Create an update file, copy it to a USB device, and connect it to the unit.

- To connect a USB device, see page 70.

2 Display the **<System Information>** screen.

On the **<TOP MENU>** screen:

- Press [**▼**] repeatedly to change the page on the **<System>** menu screen.

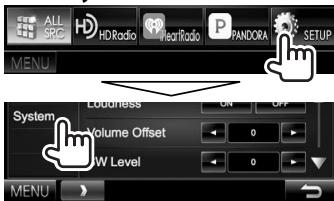

<Application Version>

Updates the system application.

<System Version>

Updates the system.

<Bluetooth Version>

Updates the Bluetooth application.

It may take a while.

If the update has been completed successfully, "Update Completed" appears. Reset the unit.

- Do not disconnect the USB device while updating.
- If the update has failed, turn the power off and then on, and retry the update.
- Even if you have turned off the power during the update, you can restart the update after the power is turned on. The update will be performed from the beginning.

❑ Adjusting the touch position

You can adjust the touch position on the touch panel if the position touched and the operation performed do not match.

1 Display the **<Touch Panel Adjust>** screen.
On the **<TOP MENU>** screen:

- Press [**▼**] repeatedly to change the page on the **<System>** menu screen.

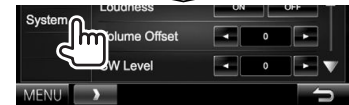

2 Touch the center of the marks at the lower left and at the upper right as instructed.



- To reset the touch position, press [**Reset**].
- To cancel the current operation, press [**Cancel**].

SETTINGS

Setting menu items

□ Displaying the <Setup> menu screen

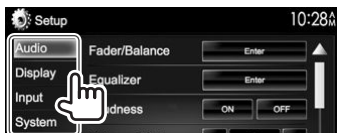
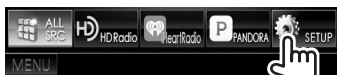

- You can change the page to display more items by pressing [▲]/[▼].
- You cannot change the <Audio> settings screen when [STANDBY] is selected on the <TOP MENU>. (Page 9)

□ <Audio> setting screen

<Fader/Balance>



Fader: Adjust the front and rear speaker output balance.

- **F6 to R6** (Initial: **0**)
 - When using a two-speaker system, set the fader to the center (**0**).

Balance: Adjust the left and right speaker output balance.

- **L6 to R6** (Initial: **0**)
 - Press [▲]/[▼]/[◀]/[▶] or drag [Speaker Icon] to adjust.
 - To clear the adjustment, press [Center].

<Equalizer>

Change the sound mode or adjust and store the equalization for each source. (Page 53)

- **Natural** (Initial)/**Rock/Pops/Easy/Top40/Jazz/Powerful/iPod***1/**User**

<Loudness>

You can activate/deactivate loudness.

- **ON** (Initial): Boost low and high frequencies to produce a well-balanced sound at a low volume level.
- **OFF:** Cancels.

<Volume Offset>

Adjust and store the auto-adjustment volume level for each source. (For discs, the adjustment is stored for each of the following categories: DVD/DVD-VR/VCD, CD, and DivX/MPEG1/MPEG2/WMV/MP3/WMA/AAC.) The volume level will automatically increase or decrease when you change the source.

- **-15 to +6** (Initial: **0**)

<SW Level>

Adjust the subwoofer level.

- **-50 to +10** (Initial: **0**)

<Bass Boost>

Select your preferred bass boost level.

- **OFF** (Initial)/**Level 1/Level 2/Level 3**

<Car Setting>*2

Select a car type and speaker location. (Page 53)

- Car type: **Off** (Initial)/**Compact/Full Size Car/Wagon/Minivan/SUV/Minivan (Long)**
- **Speaker Location:** Select the location of the speakers in your car.
 - **Front: Door** (Initial)/**On Dash/Under Dash**
 - **Rear***3: **Door/ Rear Deck/2nd Row/3rd Row**

<Speaker Select>*2

Select the speaker size and adjust the crossover frequency. (Page 54)

<Position>

Adjust the sound effects according to your listening position. (Page 54)

<DSP Select>

Select whether to use the Digital Signal Processor (DSP) system.

- **Bypass:** Invalidates all the settings for the DSP.
- **Through** (Initial): Uses the DSP.

<Drive Equalizer>

You can reduce the driving noise by raising the bandwidth.

- **ON** (Initial): Activates the Drive Equalizer.
- **OFF:** Cancels.

*1 Appears only when iPod is selected as the source.

*2 When an item is grayed out, you cannot change the setting. Select [Unlock] on the <SETUP Memory> screen to change the setting. (Page 59)

*3 The initial setting varies depending on the car type setting.

SETTINGS

<Display> setting screen

<Dimmer>

- **Auto** (Initial): Dims the screen and button illumination when you turn on the headlights.
 - The ILLUMI lead connection is required. (Page 68)*¹
- **ON**: Activates dimmer.
- **OFF**: Cancels.

<User Customize>

Change the display design (background and panel color). (Page 57)

<OSD Clock>

- **ON**: Displays the clock while a video source is playing.
- **OFF** (Initial): Cancels.

<Demonstration>

- **ON** (Initial): Activates the demonstration on the screen.
- **OFF**: Cancels.

<Scroll>

- **ON** (Initial): Scrolls the displayed information repeatedly.
- **Once**: Scrolls the displayed information once.
- **OFF**: Cancels.

Pressing [<] scrolls the text regardless of this setting.

<Menu Customize>

Change the items to display on the <TOP MENU> screen. (Page 58)

<Screen Adjustment>

Adjust the brightness and blackness of the screen. Press [**Enter**] to display the setting screen, select [**DIM ON**] (dimmer on)/[**DIM OFF**] (dimmer off), then change the following settings:

- **Bright**: Adjusts brightness.
 - **-15 to +15** (Initial: **0** for dimmer on/+**15** for dimmer off)
- **Black**: Adjusts blackness.
 - **-10 to +10** (Initial: **0**)

<Angle>*²

Adjust the panel angle. (Page 8)

<Parking Guidelines>

- **ON** (Initial): Displays the parking guidelines. (Page 42)
- **OFF**: Cancels.

<Guidelines Setup>

Adjusts the parking guidelines. (Page 42)

<Parking Assist Disp.>*³

When an ADS adapter is connected, you can display information about obstacles around the car.

- **ON**: Always displays information.
- **Dyn.** (Initial): Displays information when the sensor detects obstacles.
- **OFF**: Cancels.

<Parking Assist Pos.>*³

Select where information about obstacles is displayed on the screen (left or right).

- **Left/Right** (Initial)

*¹ Only for DDX7015BT/DDX5902.

*² Only for DDX7015BT/DDX715WBT.

*³ Only for DDX5902.

<Input> setting screen

<R-CAM Interrupt>

- **ON**: Displays the picture from the rear view camera when you shift the gear to the reverse (R) position.
- **OFF** (Initial): Select this when no camera is connected.

SETTINGS

☐ <System> setting screen

<Language>

Select the text language used for on-screen information.

- **English** (Initial)/**Español/Français/Deutsch/Italiano/Nederlands/Ελληνικά/Português/Türkçe/Čeština/Polski/Magyar/Русский/עברית/العربية/فارسی/ភាសាខ្មែរ/简体中文/繁體中文/Bahasa Indonesia/한국어**
- **GUI Language:** Select the language used for displaying operation buttons and menu items.
 - **English** (Initial)/**Local** (the language selected above)

<Clock>

Adjust the clock time. (Page 5)

<iPod Setup>

Configure the settings of iPod. (Page 19)

<APP Setup>

- **APP Connection Setup:** Configure the Apps settings. (Page 52)
- **APP Interrupt Volume:** Adjust the App volume.
 - **0 to 35** (Initial: 17)

<Bluetooth Setup>

Configure settings for using a Bluetooth device, such as connection and other general operations. (Page 51)

<Beep>

- **ON** (Initial): Activates the key-touch tone.
- **OFF:** Cancels.

<SETUP Memory>

You can memorize, recall, or clear the settings you have made. (Page 58)

<OEM Setup>*¹

Shows information about/changes the settings for using the ADS adapter.

<DivX(R) VOD>*²

This unit has its own Registration Code. Once you have played back a file with the Registration Code recorded, this unit's Registration Code is overwritten for copyright protection.

- Press [**Enter**] to display the information.
- To return to the previous screen, press [**OK**].

<TEL Key Long Press>*¹

Assigns the function of the TEL button when held.

- **R-CAM:** Displays the picture from the rear view camera. (Page 42)
- **V-OFF:** Turns off the screen. (Page 9)
- **Voice** (Initial): Activates voice dialing. (Page 49)

<AV-OUT>*³

You can determine the use of the external component connected to the AV-OUT terminal.

• **OFF** (Initial)/**AV-IN1/AV-IN2/DVD**

<AV Key Long Press>*³

Assigns the function of the AV button when held.

- **AV-OUT** (Initial): Selects the AV source for extra monitors or amplifiers.
- **APPs:** Displays the Apps screen. (Page 22)

<AUD Key Long Press>*⁴

Assigns the function of the AUD button when held.

- **V-OFF** (Initial for DDX5092): Turns off the screen. (Page 9)
- **R-CAM** (Initial for DDX7015BT/DDX715WBT): Displays the picture from the rear view camera. (Page 42)

<P.BOOK Key Long Press>*⁵

Assigns the function of the  / V.OFF button when held.

- **V-OFF** (Initial): Turns off the screen. (Page 9)
- **R-CAM:** Displays the picture from the rear view camera. (Page 42)

<Security Code>*²

Register the security code for the unit. (Page 4)

<SI>

Activate or deactivate the security function. (Page 5)

<Serial Number>*¹

Displays the serial number.

<Touch Panel Adjust>

Adjust the touch position of the buttons on the screen. (Page 59)

<Steering Remote Controller>*²

Assign functions to the keys on the remote controller of the steering wheel. (Page 65)

<System Information>

Displays the version information of the software. You can update the software. (Page 59)

*¹ Only for DDX5902.

*² Only for DDX7015BT/DDX715WBT.

*³ Only for DDX7015BT/DDX5902.

*⁴ Only for DDX7015BT.

*⁵ Only for DDX715WBT.

REMOTE CONTROLLER

Overview

DDX7015BT/DDX715WBT:

This unit can be operated using the Remote Controller (RC-DV340) supplied with this unit.

DDX5902:

Optional Remote Controller KNA-RCDV331 is designed for controlling this unit. Refer to the instruction manual that comes with the remote controller.

⚠ Caution:

- Put the Remote Controller in a place where it will not move during braking or other operations. A dangerous situation could result if the Remote Controller falls down and gets wedged under the pedals while driving.
- Do not leave the battery near fire or under direct sunlight. A fire, explosion or excessive heat generation may result.
- Do not recharge, short, break up or heat the battery, or place it in an open fire. Such actions may cause the battery to leak fluid. If spilled fluid comes in contact with your eyes or clothing, immediately rinse with water and consult a physician.
- Place the battery out of reach of children. In the unlikely event that a child swallows the battery, immediately consult a physician.

❑ Battery installation

Use two "AAA"/"R03"-size batteries.

Insert the batteries with the + and - poles aligned properly, following the illustration inside the case.

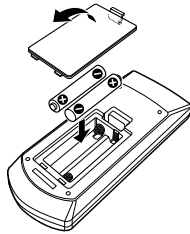

- If the Remote Controller operates only over shorter distances or does not operate at all, it is possible that the batteries are depleted. In such instances, replace both batteries with new ones.

❑ Remote Controller mode switch

The functions operated from the remote controller differ depending on the position of the mode switch.

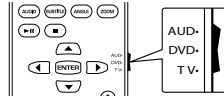

AUD mode: Switch to this mode when controlling a selected source or tuner source, etc.

DVD mode: Switch to this mode when playing DVDs or CDs etc. with the player integrated in this unit.

TV mode: Not used.

- The position of the remote control mode switch is indicated in the title of each mode, e.g., "AUD mode".
- When controlling a player that is not integrated in the unit, select "AUD" mode.

Operations from the remote controller

❑ Common operations (AUD mode)

SRC	<ul style="list-style-type: none">• Selects the source.• Hangs up the incoming/current call.
▲/▼ VOL	Adjusts the volume level.
ATT	Attenuates/restores the sound.
DISP/V.SEL	Does not function for this unit.
ENTER	Enters options.
☎	Answers incoming calls.
FNC/PBC/MENU	Switches the control screen.
MODE/TOP MENU	Changes the aspect ratio. <ul style="list-style-type: none">• The aspect ratio changes each time you press this key.
OPEN	Adjusts the panel angle.* <ul style="list-style-type: none">• The panel angle changes each time you press this key.

* Available for DDX7015BT/DDX715WBT only.

REMOTE CONTROLLER

❑ DVD/VCD (DVD mode)

	Moves the cursor when displaying a menu.
	Selects a track.
	Starts/pauses playback.
	Stops and memorizes the point where the disc stops.
0 – 9	<ul style="list-style-type: none"> Specifies the number to search for in direct search. : Fast forwards/backwards. <ul style="list-style-type: none"> Fast forward/backward speed changes each time you press this key. : Slow forwards/backwards during pause.
MODE/TOP MENU	Shows the disc top menu.
FNC/PBC/MENU	Shows the disc menu.
SUBTITLE	Changes the subtitle language.
ZOOM	Changes the zoom ratio. <ul style="list-style-type: none"> Zoom ratio changes each time you press this key.
ANGLE	Changes the picture angle. <ul style="list-style-type: none"> Picture angle changes each time you press this key.
AUDIO	Changes the voice language. <ul style="list-style-type: none"> Voice language changes each time you press this key.
DIRECT	Enters direct search mode. (See the far right column.)
CLEAR	Deletes a character while in direct search mode.

❑ Music Disc/Audio file/Video file/Picture file (AUD mode)

AM –/FM +	Selects a folder.
	Selects a track/file.
	Starts/pauses playback.
0 – 9	Specifies the number to search for in direct search.
DIRECT	Enters direct search mode. (See the right column.)

❑ Radio/HD Radio*/SiriusXM* (AUD mode)

AM –/FM +	Selects the band.
	Searches for stations.
	Changes the seek mode (AUTO1, AUTO2, MANU).
0 – 9	<ul style="list-style-type: none"> Specifies preset number. (–) Specifies the frequency of the station to receive to search for in direct search.
DIRECT	Enters direct search mode. (See the right column.)

* Only for DDX5902.

❑ iPod (AUD mode)

	Selects music/videos.
	Starts/pauses playback.

❑ USB (AUD mode)

AM –/FM +	Selects a folder.
	Selects a file.
	Starts/pauses playback.

Searching for an item (chapter/title/folder/file/track) directly

- Press DIRECT to enter the search mode. Each time you press DIRECT, the item to search for changes.
- Press a number button to select a desired item.
- Press ENTER to confirm the selection.

Searching for a tuner frequency directly

- Press DIRECT to enter the search mode.
- Press number buttons to enter a frequency.
- Press to confirm the entry.

REMOTE CONTROLLER

Using the steering remote controller (Only for DDX7015BT/DDX715WBT)

You can assign functions to the keys of the remote controller on the steering wheel.

- This function is available only when your vehicle is equipped with the electrical steering remote controller.
- You can only register/change the functions while you are parked.
- If your steering remote controller is not compatible, learning may not be completed and an error message may appear.

❑ Registering/Changing the functions

- 1 Display the <System> setting screen. On the <TOP MENU> screen:

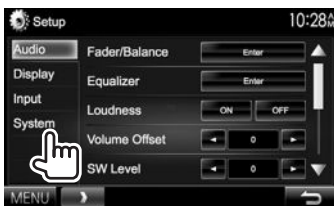

- 2 Display the <Steering Remote Control Setting> screen.
 - Press [▼] repeatedly to change the page on the <System> menu screen.



- 3 Press a steering remote controller button to register/change.
- 4 Select a function to assign.



- You can change the page to display more items by pressing [▲]/[▼].

- 5 Repeat steps 3 and 4 as necessary.
- 6 Finish the procedure.



- The unit can register/change all of the button's functions at the same time. To do this, press each button in turn and after pressing all of them, press [Done] in the <Steering Remote Control Setting> screen. However, new functions cannot be learned after this operation.
- When changing the functions already learned, touch the button you want to change in step 3 and then touch to select the new function from the function list.
- Confirm the contents of the settable functions in the function list. You cannot edit the function list.

❑ Initializing the settings

- 1 Display the <System> setting screen. (See the far left column.)
 - Press [▼] repeatedly to change the page on the <System> menu screen.



- To cancel the initialization, press [No].

CONNECTION/INSTALLATION

Before installing the unit

⚠ WARNING

- If you connect the ignition wire (red) and the battery wire (yellow) to the car chassis (ground), you may cause a short circuit, that in turn may start a fire. Always connect those wires to the power source running through the fuse box.
- Do not cut out the fuse from the ignition wire (red) and the battery wire (yellow). The power supply must be connected to the wires via the fuse.

⚠ Precautions on installation and connection

- Mounting and wiring this product requires skills and experience. For best safety, leave the mounting and wiring work to professionals.
- Make sure to ground the unit to a negative 12 V DC power supply.
- Do not install the unit in a spot exposed to direct sunlight or excessive heat or humidity. Also avoid places with too much dust or the possibility of water splashing.
- Do not use your own screws. Use only the screws provided. If you use the wrong screws, you could damage the unit.
- If the power is not turned on ("Miswiring DC Offset Error", "Warning DC Offset Error" is displayed), the speaker wire may have a short circuit or have touched the chassis of the vehicle and the protection function may have been activated. Therefore, the speaker wire should be checked.

- If your car's ignition does not have an ACC position, connect the ignition wires to a power source that can be turned on and off with the ignition key. If you connect the ignition wire to a power source with a constant voltage supply, such as with battery wires, the battery may be drained.
- Only for DDX7015BT/DDX715WBT: If the console has a lid, make sure to install the unit so that the monitor panel will not hit the lid when closing and opening.
- If the fuse blows, first make sure the wires are not touching to cause a short circuit, then replace the old fuse with one with the same rating.
- Insulate unconnected wires with vinyl tape or other similar material. To prevent a short circuit, do not remove the caps on the ends of the unconnected wires or the terminals.
- Connect the speaker wires correctly to the terminals to which they correspond. The unit may be damaged or fail to work if you share the ⊖ wires or ground them to any metal part in the car.
- When only two speakers are being connected to the system, connect both connectors either to the front output terminals or to the rear output terminals (do not mix front and rear). For example, if you connect the ⊕ connector of the left speaker to a front output terminal, do not connect the ⊖ connector to a rear output terminal.
- After the unit is installed, check whether the brake lamps, blinkers, wipers, etc. on the car are working properly.
- Mount the unit so that the mounting angle is 30° or less.
- Do not press hard on the panel surface when installing the unit in the vehicle. Otherwise scratches, damage, or failure may result.

- This unit has a cooling fan to decrease the internal temperature. Do not mount the unit in a place where the cooling fan of the unit is blocked. Blocking these openings will prevent the cooling of the internal temperature and result in malfunction.

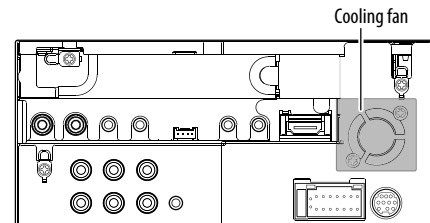

⚠ CAUTION

Install this unit in the console of your vehicle. Do not touch the metal part of this unit during and shortly after the use of the unit. Metal parts such as the heat sink and enclosure become hot.

❑ Supplied accessories for installation

- ① Wiring harness x 1
- ② Trim plate x 1*¹
- ③ Extension wire (2 m) x 1
- ④ Extraction keys x 2*¹
- ⑤ Flat head screws (M5 x 7 mm) x 6*¹
- ⑥ Round head screws (M5 x 6 mm) x 6
- ⑦ Antenna extension cable x 1*²
- ⑧ Steering Remote cable x 1*³
- ⑨ Microphone (3 m) x 1
- ⑩ Fixture for HDMI/MHL connector x 1
- ⑪ Screws for the fixture (M2.6 x 6 mm) x 1

*¹ Only for DDX7015BT/DDX5902.

*² Only for DDX715WBT.

*³ Only for DDX7015BT/DDX715WBT.

CONNECTION/INSTALLATION

❑ Installation procedure

- 1 To prevent a short circuit, remove the key from the ignition and disconnect the ⊖ battery.
- 2 Make the proper input and output wire connections for each unit.
- 3 Connect the speaker wires of the wiring harness.
- 4 Connect the wiring harness wires in the following order: ground, battery, ignition.
- 5 Connect the wiring harness connector to the unit.
- 6 Install the unit in your car.
 - Make sure that the unit is installed securely in place. If the unit is unstable, it may malfunction (e.g., the sound may skip).
- 7 Reconnect the ⊖ battery.
- 8 Press the reset button.
- 9 Configure <Initial Setup>. (Page 4)

Installing the unit

❑ Installing the unit (Only for DDX7015BT/DDX5902)

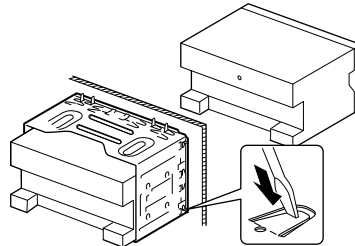

- Bend the tabs of the mounting sleeve with a screwdriver or similar utensil and attach it in place.

❑ When installing the unit using the mounting bracket removed from the car

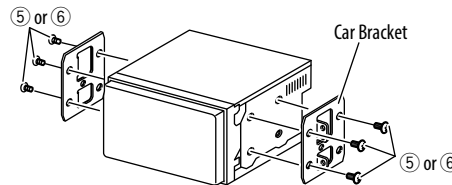

- Select the appropriate type of screw for the mounting bracket: flat head (5) or round head (6).

❑ Installing the trim plate (Only for DDX7015BT/DDX5902)

- 1 Attach the trim plate (2).

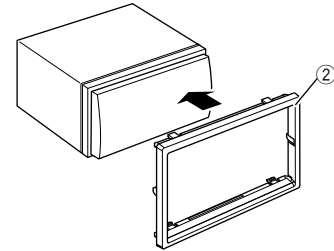

CONNECTION/INSTALLATION

Connection

Connecting wires to terminals (for DDX7015BT/DDX5902)

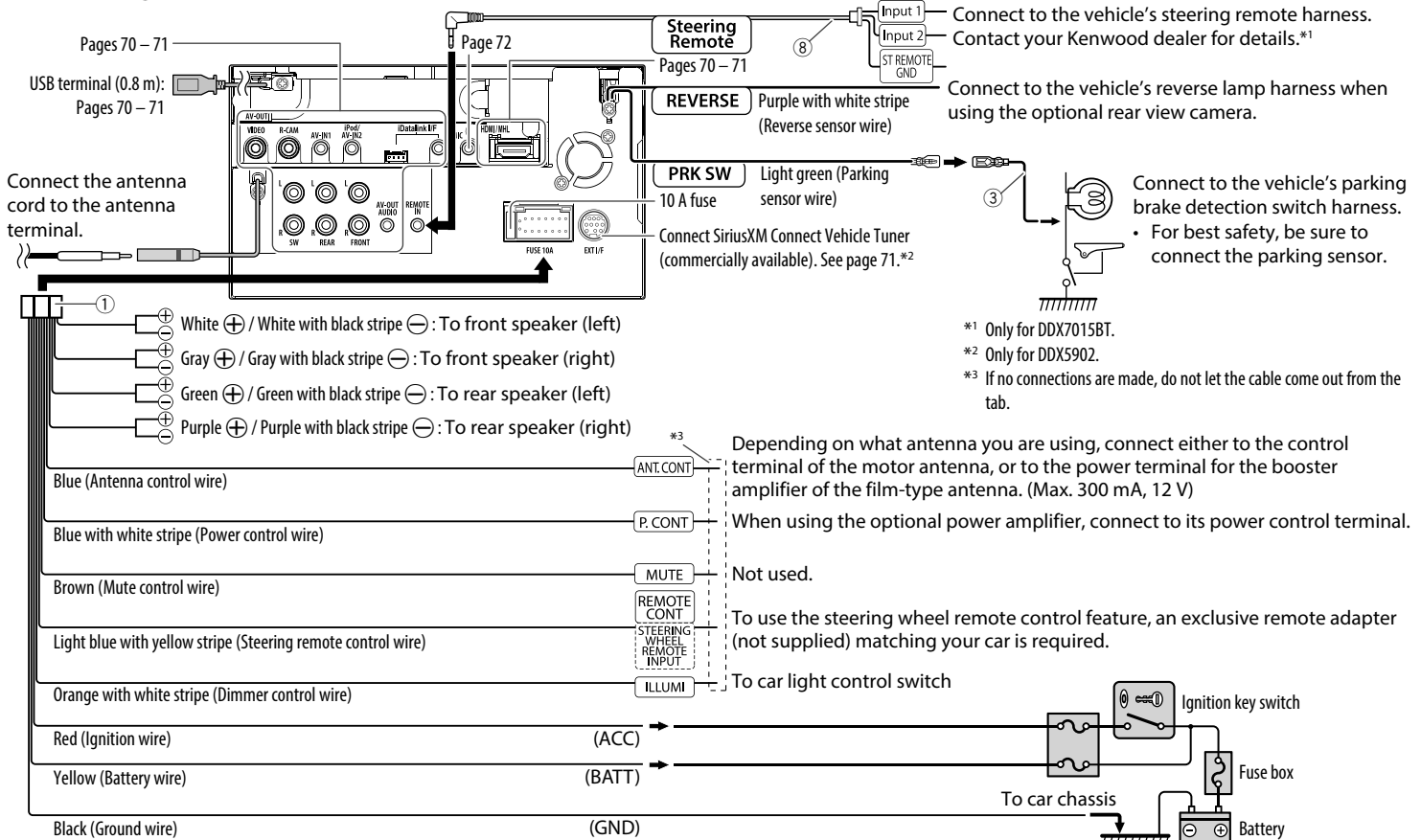

CONNECTION/INSTALLATION

❑ Connecting a USB device

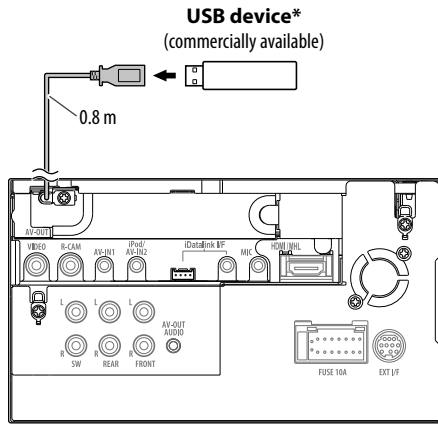

* Use CA-U1EX to extend the cable if necessary. (Max 500 mA, 5V)

❑ Connecting an iPod/iPhone

iPod/iPhone except for iPod nano (7th Generation)/iPod touch (5th Generation)/iPhone 5S/iPhone 5C/iPhone 5
(commercially available)

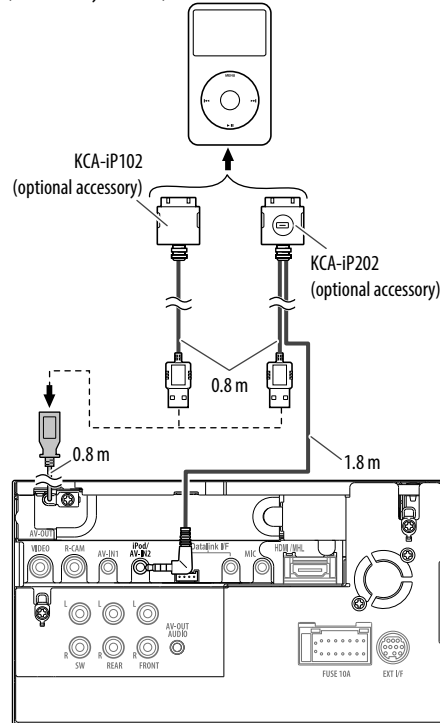

iPod nano (7th Generation)/iPod touch (5th Generation)/iPhone 5S/iPhone 5C/iPhone 5
(commercially available)

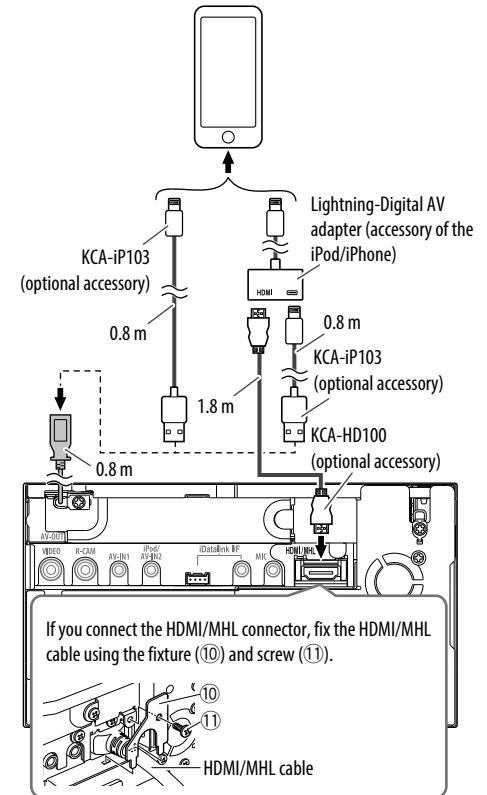

CONNECTION/INSTALLATION

❑ Connecting a smartphone

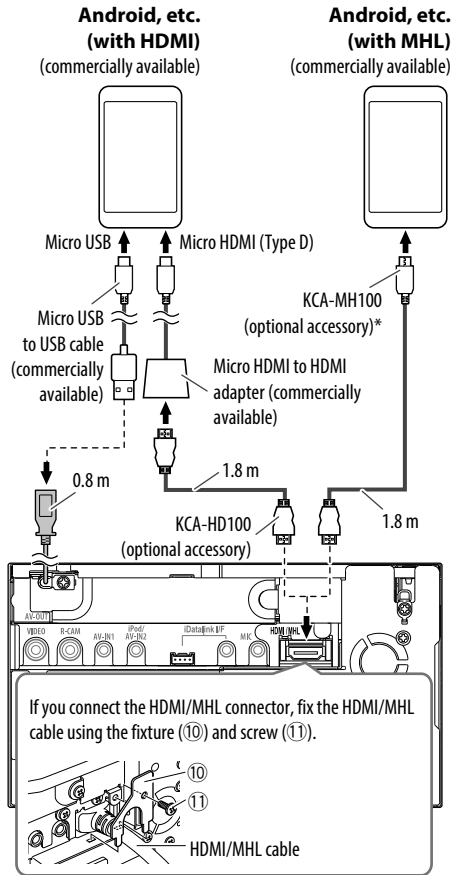

* Use conversion adapter to connect to smartphones if necessary.

❑ Connecting the Miracast Dongle to use smartphone/iPod/iPhone over a wireless connection

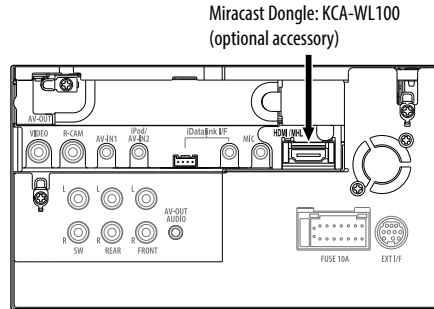

❑ Connecting external components

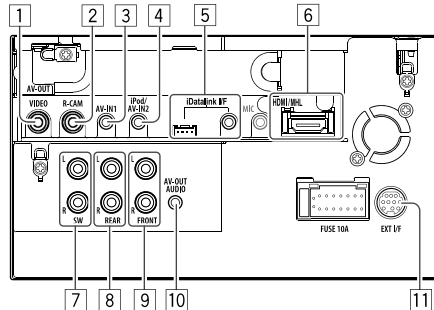

- ❑ 1 AV-OUT/Video output (Yellow)
- ❑ 2 Rear view camera input (Yellow)
- ❑ 3 Audio Video input (AV-IN1)*¹
- ❑ 4 iPod/Audio Video input (iPod/AV-IN2)*¹
- ❑ 5 iDataLink input for connecting ADS adapter (commercially available)*²
- ❑ 6 HDMI/MHL input
- ❑ 7 Subwoofer preout (monaural output)*³
 - Subwoofer left output (White)
 - Subwoofer right output (Red)
- ❑ 8 Rear preout*³
 - Audio left output (White)
 - Audio right output (Red)
- ❑ 9 Front preout*³
 - Audio left output (White)
 - Audio right output (Red)
- ❑ 10 Audio output (ø3.5 mini jack)
Resistance-free stereo type mini plug
- ❑ 11 Expansion port for connecting SiriusXM Connect Vehicle Tuner (commercially available)*²

*¹ When connecting the component to play on “AV-IN1” or “AV-IN2”, use the Audio and Video cable CA-C3AV (optional accessory).

*² Only for DDX5902.

*³ When connecting an external amplifier, connect its ground wire to the chassis of the car; otherwise the unit may be damaged.

REFERENCES

Maintenance

❑ Caution on cleaning the unit

Do not use any solvent (for example, thinner, benzene, etc.), detergent, or insecticide. This may damage the monitor or the unit.

Recommended cleaning method:

Gently wipe the panel with a soft, dry cloth.

❑ Moisture condensation

Moisture may condense on the lens inside the unit in the following cases:

- After starting the heater in the car.
- If it becomes very humid inside the car.

Should this occur, the unit may malfunction. In this case, eject the disc and leave the unit turned on for a few hours until the moisture evaporates.

❑ How to handle discs

- When removing a disc from its case, press down the center holder of the case and lift the disc out, holding it by the edges.



- Always hold the disc by the edges. Do not touch its recording surface.
- When storing a disc in its case, gently insert the disc around the center holder (with the printed surface facing up).
 - Make sure to store discs in their cases after use.

❑ To keep discs clean

Dirty discs may not play correctly.

If a disc does become dirty, wipe it with a soft cloth in a straight line from the center to the edge.



- Do not use any solvents (for example, conventional record cleaner, spray, thinner, benzene, etc.) to clean discs.

❑ To play new discs

New discs may have some rough spots around the inner and outer edges. If such a disc is used, this unit may reject the disc.



- To remove these rough spots, rub the edges with a pencil or ball-point pen, etc.

More information

❑ File playback

Playing DivX files (for discs only)*

- This unit can play back DivX files with the extension code <.divx>, <.div>, or <.avi> (regardless of the letter case—upper/lower).
- Audio streams should conform to MP3 or Dolby Digital.
- Files encoded in the interlaced scanning mode may not be played back correctly.
- The maximum bit rate for video signals (average) is 8 Mbps.

* Only for DDX7015BT/DDX715WBT.

Playing MPEG1/MPEG2 files

- This unit can play back MPEG1/MPEG2 files with the extension code <.mpg> or <.mpeg>.
- The stream format should conform to MPEG system/program stream.
The file format should be MP@ML (Main Profile at Main Level)/SP@ML (Simple Profile at Main Level)/MP@LL (Main Profile at Low Level).
- Audio streams should conform to MPEG1 Audio Layer-2 or Dolby Digital.

Playing JPEG/BMP/PNG files (for USB only)

- This unit can play back picture files with the extension code <.jpg>, <.jpeg>, <.bmp> or <.png>.
- This unit can play back files that are at 32 x 32 to 8 192 x 7 680 resolution.
It may take time to display the file depending on its resolution.
- This unit can play back baseline JPEG files.
Progressive JPEG files or lossless JPEG files cannot be played.

Continued on the next page...

REFERENCES

Playing audio files (for discs: MP3/WMA/AAC, for USB: MP3/WMA/WAV/AAC/FLAC)

- This unit can play back files with the extension code <.mp3>, <.wma>, <.wav>, <.m4a> or <.flac> (regardless of the letter case—upper/lower).
- This unit can play back files that meet the conditions below:
 - Bit rate:
 - MP3: 8 kbps – 320 kbps
 - WMA: 48 kbps – 192 kbps
 - AAC: For discs: 16 kbps – 320 kbps
For USB: 32 kbps – 320 kbps
 - Sampling frequency:
 - MP3: 8 kHz – 48 kHz
 - WMA: For discs: 32 kHz – 48 kHz
For USB: 8 kHz – 48 kHz
 - WAV: 44.1 kHz
 - AAC: 16 kHz – 48 kHz
 - FLAC : 8 kHz – 48 kHz
- This unit can show ID3 Tag Version 1.0/1.1/2.2/3/2.4 (for MP3).
- This unit can also show WMA/AAC/FLAC Tag.
- This unit can play back files recorded in VBR (variable bit rate).
- Files recorded in VBR have a discrepancy in elapsed time indication.

- This unit cannot play back the following files:
 - MP3 files encoded with MP3i and MP3 PRO format.
 - MP3 files encoded with Layer 1/2.
 - WMA files encoded with lossless, professional, and voice format.
 - WMA files which are not based upon Windows Media® Audio.
 - WMA/AAC files copy-protected with DRM.
 - AAC files encoded using any other application than iTunes.
 - AAC files copy-protected with FairPlay (except those stored on an iPod).
 - Files which have data such as AIFF, ATRAC3, etc.
- This unit can display jacket pictures that meet the conditions below:
 - Picture size: 32 x 32 to 1 232 x 672 (PNG: 800 x 480) resolution
 - Data size: less than 650 KB.
 - File type: JPEG/PNG/BMP

Playing H.264/WMV files (for USB only)

- This unit can play back files with the extension code <.mp4>, <.wmv>, <.avi> or <.mkv>.
- This unit can only play back files which are less than 2 GB.
- The stream format should conform to MPEG system/program stream.

Disc playback

Playable disc types

Disc type	Recording format, file type, etc.
DVD <ul style="list-style-type: none"> DTS sound cannot be reproduced or emitted from this unit. 	DVD Video*1
DVD Recordable/Rewritable (DVD-R/-RW*2, +R/+RW*3) <ul style="list-style-type: none"> DVD Video: UDF bridge DVD-VR DivX*5/MPEG1/MPEG2/MP3/WMA/AAC: ISO 9660 level 1, level 2, Romeo, Joliet 	<ul style="list-style-type: none"> DVD Video DVD-VR*4 DivX*5/MPEG1/MPEG2 MP3/WMA/AAC
Dual Disc	DVD side
CD/VCD	<ul style="list-style-type: none"> VCD (Video CD) Audio CD/CD Text (CD-DA)
CD Recordable/Rewritable (CD-R/-RW) <ul style="list-style-type: none"> ISO 9660 level 1, level 2, Romeo, Joliet 	<ul style="list-style-type: none"> VCD (Video CD) CD-DA MPEG1/MPEG2 MP3/WMA/AAC

*1 DVD Region code:

For DDX5902: 1

For DDX7015BT/DDX715WBT: 4

If you insert a DVD Video disc of an incorrect Region Code, "Region Code Error" appears on the screen.

*2 DVD-R recorded in multi-border format are also playable (except for dual layer discs). DVD-RW dual layer discs are not playable.

*3 It is possible to play back finalized +R/+RW (Video format only) discs. "DVD" is selected as the disc type when a +R/+RW disc is loaded. +RW double layer discs are not playable.

*4 This unit cannot play back content protected with CPRM.

*5 Only for DDX7015BT/DDX715WBT.

REFERENCES

Unplayable discs

- Unplayable disc types and formats are as follows:
 - DVD-Audio/DVD-ROM discs
 - MPEG4/DivX*/JPEG/FLAC/MKV/DVD+VR/DVD-RAM recorded on DVD-R/RW or +R/+RW
 - SVCD (Super Video CD), CD-ROM, CD-I (CD-I Ready), DTS-CD
 - MPEG4/JPEG/FLAC/MKV recorded on CD-R/RW
- Discs that are not round.
- Discs with coloring on the recording surface or discs that are dirty.
- Recordable/Rewritable discs that have not been finalized.
- 3 inch discs. Attempting to insert these discs using an adapter may cause a malfunction.

* Only for DDX5902.

DualDisc playback

The Non-DVD side of a "DualDisc" does not comply with the "Compact Disc Digital Audio" standard. Therefore, the use of the Non-DVD side of a DualDisc on this product cannot be recommended.

Playing Recordable/Rewritable discs

- This unit can recognize a total of 64 770 files and 254 folders (a maximum of 255 files per folder).
- Use only "finalized" discs.
- This unit can play back multi-session discs; however, unclosed sessions will be skipped while playing.
- Some discs or files may not be played back due to their characteristics or recording conditions.

❑ About data stored in the connected USB device/iPod/iPhone

- We bear no responsibility for any loss of data in iPod/iPhone and USB mass storage class devices while using this unit.

❑ USB playback

Playable files on a USB device

- This unit can play the following types of files stored in a USB mass storage class device.
 - JPEG/BMP/PNG/MPEG1/MPEG2/MP3/WMA/WAV/AAC/FLAC/H.264/WMV (VC-1)
- This unit can recognize a total of 5 000 files and 250 folders (a maximum of 999 files per folder).
- Make sure all important data has been backed up to avoid losing the data.

Notes on using a USB device:

- This unit may not play back files in a USB device properly when using a USB extension cable.
- USB devices equipped with special functions such as data security functions cannot be used with the unit.
- Do not use a USB device with 2 or more partitions.
- Depending on the shape of the USB devices and connection ports, some USB devices may not be attached properly or the connection might be loose.
- This unit may not recognize a memory card inserted into the USB card reader.
- When connecting with a USB cable, use the USB 2.0 cable.

- The maximum number of characters (when the characters are 1 byte):
 - Folder names: 128 characters
 - File names: 128 characters
- Avoid using the USB device if it might affect driving safety.
- Do not pull out and connect the USB device repeatedly while "Reading" is shown on the screen.
- Electrostatic shock at connecting a USB device may cause abnormal playback of the device. In this case, disconnect the USB device then reset this unit and the USB device.
- Operation and power supply may not work as intended for some USB devices.
- Do not leave a USB device in the car, or expose to direct sunlight or high temperatures to prevent deformation or damage to the device.

REFERENCES

❑ Notes on playing iPod/iPhone

- iPod/iPhone that can be connected to this unit:
Made for
 - iPod with video
 - iPod classic
 - iPod nano (7th Generation)
 - iPod nano (6th Generation)
 - iPod nano (5th Generation)
 - iPod nano (4th Generation)
 - iPod nano (3rd Generation)
 - iPod touch (5th Generation)
 - iPod touch (4th Generation)
 - iPod touch (3rd Generation)
 - iPod touch (2nd Generation)
 - iPod touch (1st Generation)
 - iPhone 5S
 - iPhone 5C
 - iPhone 5
 - iPhone 4S
 - iPhone 4
 - iPhone 3GS
 - iPhone 3G
 - iPhone
- When operating an iPod/iPhone, some operations may not be performed correctly or as intended. In this case, visit the following KENWOOD web site: <www.kenwood.com/cs/ce/ipod>
- For some iPod/iPhone models, the performance may be abnormal or unstable during operation. In this case, disconnect the iPod/iPhone device, then check its condition.
If the performance is not improved or slow, reset your iPod/iPhone.
- When you turn on this unit, the iPod/iPhone is charged through the unit.
- The text information may not be displayed correctly.

❑ Language codes (for DVD/DVD-VR language selection)

AA	Afar	GL	Galician	MI	Maori	SO	Somali
AB	Abkhazian	GN	Guarani	MK	Macedonian	SQ	Albanian
AF	Afrikaans	GU	Gujarati	ML	Malayalam	SR	Serbian
AM	Ameharic	HA	Hausa	MN	Mongolian	SS	Siswati
AR	Arabic	HI	Hindi	MO	Moldavian	ST	Sesotho
AS	Assamese	HR	Croatian	MR	Marathi	SU	Sundanese
AY	Aymara	HU	Hungarian	MS	Malay (MAY)	SW	Swahili
AZ	Azerbaijani	HY	Armenian	MT	Maltese	TA	Tamil
BA	Bashkir	IA	Interlingua	MY	Burmese	TE	Telugu
BE	Byelorussian	IE	Interlingue	NA	Nauru	TG	Tajik
BG	Bulgarian	IK	Inupiak	NE	Nepali	TH	Thai
BH	Bihari	IN	Indonesian	NO	Norwegian	TI	Tigrinya
BI	Bislama	IS	Icelandic	OC	Occitan	TK	Turkmen
BN	Bengali, Bangla	IW	Hebrew	OM	(Afan) Oromo	TL	Tagalog
BO	Tibetan	JA	Japanese	OR	Oriya	TN	Setswana
BR	Breton	JL	Yiddish	PA	Panjabi	TO	Tonga
CA	Catalan	JW	Javanese	PL	Polish	TR	Turkish
CO	Corsican	KA	Georgian	PS	Pashto, Pushto	TS	Tsonga
CS	Czech	KK	Kazakh	QU	Quechua	TT	Tatar
CY	Welsh	KL	Greenlandic	RM	Rhaeto-Romance	TW	Twi
DZ	Bhutani	KM	Cambodian	RN	Kirundi	UK	Ukrainian
EL	Greek	KN	Kannada	RO	Rumanian	UR	Urdu
EO	Esperanto	KO	Korean (KOR)	RW	Kinyarwanda	UZ	Uzbek
ET	Estonian	KS	Kashmiri	SA	Sanskrit	VI	Vietnamese
EU	Basque	KU	Kurdish	SD	Sindhi	VO	Volapuk
FA	Persian	KY	Kirghiz	SG	Sangho	WO	Wolof
FI	Finnish	LA	Latin	SH	Serbo-Croatian	XH	Xhosa
FJ	Fiji	LN	Lingala	SI	Singhalese	YO	Yoruba
FO	Faroese	LO	Laothian	SK	Slovak	ZU	Zulu
FY	Frisian	LT	Lithuanian	SL	Slovenian		
GA	Irish	LV	Latvian, Lettish	SM	Samoan		
GD	Scots Gaelic	MG	Malagasy	SN	Shona		

REFERENCES

Error message list

If an error occurs while using the unit, a message appears. Take appropriate action according to the following message/remedy/cause list.

“No Signal”/“No Video Signal”:

- Start playback on the external component connected to the AV-IN1 or iPod/AV-IN2 input terminal.
- Start playback on the smartphone connected to HDMI/MHL input terminal.
- Check the cords and connections.
- Signal input is too weak.

“Miswiring DC Offset Error”/“Warning DC Offset Error”:

- A speaker cord has shorted or it has come into contact with the car chassis. Wire or insulate the speaker cord as appropriate, then reset the unit. (Pages 3 and 67)

“Parking off”:

- No playback picture is shown when the parking brake is not engaged.

“Authorization Error”:

- Check whether the connected iPod/iPhone is compatible with this unit. (Page 76)

“USB Device Error”:

- The USB power voltage is abnormal.
- Turn off and turn on the unit.
- Connect another USB device.

“Panel Mecha Error”:

- The panel does not work properly. Reset the unit.

“Connection Error”:

- The device is registered but the connection has failed. Connect the registered device. (Page 46)

“Please Wait...”:

- The unit is preparing to use the Bluetooth function. If the message does not disappear, turn off and turn on the unit, then connect the device again (or reset the unit).

“No Voice Device”:

- The connected mobile phone does not have a voice recognition system.

“No Data”:

- No phone book data is contained in the connected Bluetooth phone.

“Initialize Error”:

- The unit has failed to initialize the Bluetooth module. Try the operation again.

“Dial Error”:

- Dialing has failed. Try the operation again.

“Hung Up Error”:

- The call has not ended yet. Park your car, and use the connected mobile phone to end the call.

“Pick Up Error”:

- The unit has failed to receive a call.

“Disconnected”:

- The device is not connected.

“Check device”:

- The application is not active.

“Check application”:

- A connection to the application cannot be established.

“Not logged in”:

- You are not logged in.

“Request time out”:

- A network (WiFi connection, server) error has occurred.

“Station not selected”:

- No station is selected.

“Station cannot be saved”/“Station cannot be created”/“Station cannot be deleted”:

- The station cannot be saved, created, or deleted.

“Please update Pandora App”:

- The Pandora application on your iPod touch/iPhone/Android/BlackBerry is not the latest version. Update the application.

“Please check device.”:

- The Pandora application on your iPod touch/iPhone/Android/BlackBerry is not started up.
- The Pandora application is not installed in the connected device.
- An error has occurred on the Pandora application.

“Login Error”:

- You have not been signed into Pandora.

“No skips remaining”:

- No more songs can be skipped.

“Failed to save your thumb rating”:

- Thumb-up/down is prohibited.

“No Station”:

- No station is available.

“No Active Station”:

- No station is being played.

REFERENCES

“Station limit reached”:

- The Station List is full and no more stations can be registered.

“Failed to save your bookmark”:

- The unit has failed to save a bookmark. Try the operation again.

“Limited Connectivity”:

- The connection with the Pandora application cannot be established.

“Pandora not available”:

- You cannot use the Pandora application from the area where you are currently trying to access Pandora.

“Try again later”:

- The Pandora server is under maintenance.

“Station does not exist”:

- The selected station has been deleted by another device or has expired.

“Cannot create a Station”:

- You cannot create a station during the read-only mode or when network connection is not established.

“SXM No Signal”:

- Make sure the SiriusXM Satellite Radio antenna is mounted outside the vehicle. Move the vehicle to an area with a clear view of the sky.

“SXM Check Antenna”:

- Check the SiriusXM Satellite Radio antenna connection, and make sure the antenna is firmly attached to the tuner.
- Check whether the SiriusXM Satellite Radio antenna cable is bent or broken. If it is damaged, replace the whole antenna unit.

“SXM Check Tuner”:

- Make sure the SiriusXM Connect Vehicle Tuner is connected to the unit.

“SXM Chan Unavailable” (appears on the screen for about 2 seconds, then returns to the previous channel):

- The selected channel is no longer available. Select another channel or continue listening to the previous channel.

“SXM Ch Unsubscribed” (appears on the screen for about 2 seconds, then returns to the previous channel):

- The selected channel is not part of your current subscription plan. Call 1-866-635-2349 to subscribe.

“SXM Subscription Updated – Press Enter to Continue”:

- Your subscription has been updated. Press the appropriate button to continue.

“SXM Channel Locked”

- The selected channel has been locked by the parental controls. Enter the unlock code when you are asked. (Page 39)

“SXM Incorrect Lock Code”

- The selected channel is a mature or parental lock channel, and locked by the parental lock or user lock code. Enter the correct lock code.

Troubleshooting

What appears to be trouble is not always serious. Check the following points before calling a service center.

- For operations with the external components, refer also to the instructions supplied with the adapters used for the connections (as well as the instructions supplied with the external components).

□ General

No sound comes out of the speakers.

- Adjust the volume to the optimum level.
- Check the cords and connections.

No picture is displayed on the screen.

- Turn on the screen. (Page 9)

The unit does not work at all.

- Reset the unit. (Page 3)

The remote controller* does not work.

- Replace the battery.

* For DDX5902: Purchase KNA-RCDV331 separately.

REFERENCES

Discs

Recordable/Rewritable discs cannot be played back.

- Insert a finalized disc.
- Finalize the discs with the component which you used for recording.

Tracks on the Recordable/Rewritable discs cannot be skipped.

- Insert a finalized disc.
- Finalize the discs with the component which you used for recording.

Playback does not start.

- The format of files is not supported by the unit.

No picture appears on the external monitor.

- Connect the video cord correctly.
- Select the correct input on the external monitor.

DivX*/MPEG1/MPEG2/MP3/WMA/AAC discs cannot be played back.

- Record the tracks using a compatible application on the appropriate discs. (Page 74)
- Add appropriate extension codes to the file names.

Tracks on the Recordable/Rewritable discs are not played back as you have intended them to play.

- Playback order may differ from the one played back using other players.

* Only for DDX7015BT/DDX715WBT.

USB

“Reading” does not disappear from the screen.

- Turn the power off and on again.

While playing a track, sound is sometimes interrupted.

- The tracks are not properly copied into the USB device. Copy the tracks again, and try again.

Tracks are not played back as you have intended them to play.

- Playback order may differ from the one played back using other players.

iPod/iPhone

No sound comes out of the speakers.

- Disconnect the iPod/iPhone, then connect it again.
- Select another source, then reselect “iPod”.

The iPod/iPhone does not turn on or does not work.

- Check the connecting cable and its connection.
- Update the firmware version.
- Charge the battery.
- Reset the iPod/iPhone.

Sound is distorted.

- Deactivate the equalizer either on this unit or the iPod/iPhone.

A lot of noise is generated.

- Turn off (uncheck) “VoiceOver” on the iPod/iPhone. For details, visit <<http://www.apple.com>>.

No operations are available when playing back a track containing artwork.

- Operate the unit after the artwork has loaded.

Videos cannot be played.

- Connect with USB Audio and Video cable KCA-iP202 for iPod/iPhone except for iPod nano (7th Generation)/iPod touch (5th Generation)/iPhone 5S/iPhone 5C/iPhone 5 or KCA-HD100 and KCA-iP103 through a Lightning-Digital AV adapter

for iPod nano (7th Generation)/iPod touch (5th Generation)/iPhone 5S/iPhone 5C/iPhone 5. Other cables cannot be used.

No sound of videos comes out.

- Connect with USB Audio and Video cable KCA-iP202 for iPod/iPhone except for iPod nano (7th Generation)/iPod touch (5th Generation)/iPhone 5S/iPhone 5C/iPhone 5 or KCA-HD100 and KCA-iP103 through a Lightning-Digital AV adapter for iPod nano (7th Generation)/iPod touch (5th Generation)/iPhone 5S/iPhone 5C/iPhone 5. Other cables cannot be used.

Tuner

AME automatic presetting does not work.

- Store stations manually. (Page 30)

Static noise while listening to the radio.

- Connect the antenna firmly.

AV-IN1/AV-IN2

No picture appears on the screen.

- Turn on the video component if it is not on.
- Connect the video component correctly.

HD Radio reception (only for DDX5902)

Sound quality changes when receiving HD Radio stations.

- Fix the reception mode either to <Digital> or <Analog>. (Page 32)

No sound can be heard.

- The HD Radio reception mode is not appropriate. Select the appropriate mode from <Digital>, <Analog> or <Auto>.

REFERENCES

❑ iHeartRADIO*/Pandora*/AUPEO!

The application does not work.

- The application on your iPod touch/iPhone/Android is not the latest version. Update the application.

* Only for DDX5902.

❑ Bluetooth

Phone sound quality is poor.

- Reduce the distance between the unit and the Bluetooth mobile phone.
- Move the car to a place where you can get a better signal reception.

The sound is interrupted or skipped while using a Bluetooth audio player.

- Reduce the distance between the unit and the Bluetooth audio player.
- Disconnect the device connected for Bluetooth phone.
- Turn off, then turn on the unit.
(When the sound is not yet restored) connect the player again.

The connected audio player cannot be controlled.

- Check whether the connected audio player supports AVRC (Audio Video Remote Control Profile).

The Bluetooth device does not detect the unit.

- Search from the Bluetooth device again.

The unit does not pair with the Bluetooth device.

- For devices compatible with Bluetooth 2.1:
Register the device using a PIN code. (Page 45)

- For devices compatible with Bluetooth 2.0:
Enter the same PIN code for both the unit and target device. If the PIN code of the device is not indicated in its instructions, try "0000" or "1234."
- Turn off, then turn on the Bluetooth device.

Echo or noise occurs.

- Adjust the microphone unit position.
- Adjust the echo volume or noise reduction volume. (Page 47)

The unit does not respond when you try to copy the phone book to the unit.

- You may have tried to copy the same entries (as stored) to the unit.

Specifications

❑ Monitor section

Picture Size (W x H)

DDX7015BT/DDX715WBT:	6.95 inches (diagonal) wide 156.6 mm × 81.6 mm (6-3/16" × 3-3/16")
DDX5902:	6.2 inches (diagonal) wide 137.5 mm × 77.2 mm (5-7/16" × 3-1/16")

Display System	Transparent TN LCD panel
Drive System	TFT active matrix system
Number of Pixels	1 152 000 (800H × 480V × RGB)
Effective Pixels	99.99%
Pixel Arrangement	RGB striped arrangement
Back Lighting	LED

❑ DVD player section

D/A Converter	24 bit
Audio Decoder	Linear PCM/Dolby Digital/MP3/WMA/AAC
Video Decoder	MPEG1/MPEG2/DivX*
Wow & Flutter	Below Measurable Limit
Frequency Response	96 kHz Sampling: 20 Hz to 20 000 Hz 48 kHz Sampling: 20 Hz to 20 000 Hz 44.1 kHz Sampling: 20 Hz to 20 000 Hz
Total Harmonic Distortion	0.010% (1 kHz)
Signal to Noise Ratio	94 dB (DVD-Video 96 kHz)
Dynamic Range	91 dB (DVD-Video 96 kHz)
Disc Format	DVD-Video/DVD-VR/VIDEO-CD/CD-DA
Sampling Frequency	44.1 kHz/48 kHz/96 kHz

Quantifying Bit Number	16/20/24 bit
------------------------	--------------

* Only for DDX7015BT/DDX715WBT.

❑ USB interface section

USB Standard	USB 2.0 High Speed
File System	FAT 16/32
Maximum Power Supply Current	DC 5 V \leq 1 A
D/A Converter	24 bit
Audio Decoder	MP3/WMA/AAC/WAV/FLAC
Video Decoder	MPEG1/MPEG2/H.264/WMV/JPEG/BMP/PNG

REFERENCES

❑ HDMI interface section

Connector Type TYPE-A

❑ MHL interface section

Supported Version

MHL 2

Maximum Power Supply Current

DC 5 V \equiv 900 mA

❑ Bluetooth section

Technology Bluetooth 3.0 + EDR

Frequency 2.402 GHz to 2.480 GHz

Output Power +4 dBm (MAX), 0 dBm (AVE),
Power Class 2

Maximum Communication Range

Line of sight approx. 10 m
(32.8 ft)

Audio Codec SBC/AAC/MP3/aptX/aptX Sprint*

Profile HFP (Hands Free Profile)
A2DP (Advanced Audio
Distribution Profile)
AVRCP (Audio/Video Remote
Control Profile)
GAP (Generic Access Profile)
PBAP (Phonebook Access Profile)
SDP (Service Discovery Profile)
SPP (Serial Port Profile)

* aptX/aptX Sprint are compatible only with DDX5902.

❑ DSP section

Graphics equalizer

DDX5902:

BAND 7 Band

Frequency (Hz) (BAND1-7)
62.5/160/400/1k/2.5k/6.3k/16k

Gain -9/-8/-7/-6/-5/-4/-3/-2/
-1/0/1/2/3/4/5/6/7/8/9 dB

DDX7015BT/DDX715WBT:

BAND 5 Band

Frequency (Hz) (BAND1-5)
62.5/250/1k/4k/16k

Gain -9/-8/-7/-6/-5/-4/-3/-2/
-1/0/1/2/3/4/5/6/7/8/9 dB

2 Way X'Over

HIGH PASS FILTER frequency
Through/50/60/80/100/120/150/
180/220

SLOPE -6/-12/-18/-24 dB/Oct.

LOW PASS FILTER frequency
50/60/80/100/120/Through

SLOPE -6/-12/-18/-24 dB/Oct.

Position

Front/Rear/Subwoofer Delay
0 ft to 20.0 ft (0.07 ft Step)

Gain -8 dB to 0 dB

Subwoofer Level -50 dB to +10 dB

❑ FM tuner section

Frequency Range

DDX5902: 87.9 MHz to 107.9 MHz (200 kHz)

DDX7015BT/DDX715WBT:
87.5 MHz to 108.0 MHz (50 kHz)

Usable Sensitivity (S/N: 30 dB)

7.2 dBf (0.63 μ V/75 Ω)

Quieting Sensitivity (S/N: 50 dB)

15.2 dBf (1.58 μ V/75 Ω)

Frequency Response (\pm 3.0 dB)

Digital: 20 Hz to 20 kHz*

Analog: 30 Hz to 15 kHz

Signal to Noise Ratio

Digital: 75 dB (STEREO)*

Analog: 68 dB (MONO)

Selectivity (\pm 400 kHz)

\geq 80 dB

Stereo Separation 40 dB (1 kHz)

* Only for DDX5902.

❑ AM tuner section

Frequency Range (10 kHz)

530 kHz to 1 700 kHz

Usable Sensitivity 29 dB μ

Frequency Response (\pm 3.0 dB)

Digital: 40 Hz to 15 kHz*

Signal to Noise Ratio

Digital: 75 dB (STEREO)*

* Only for DDX5902.

REFERENCES

❑ Video section

Color System of External Video Input
NTSC/PAL

External Video Input Level (mini jack)
1 Vp-p/75 Ω

External Audio Max Input Level (mini jack)
2 V/25 kΩ

Video Output Level (RCA jacks)
1 Vp-p/75 Ω

Audio Output Level (mini jacks)
1.2 V/10 kΩ

❑ Audio section

Maximum Power (Front & Rear)
50 W × 4

Typical Power Output
Full Bandwidth Power
(at less than 1%THD)
22 W × 4

Preout Level
DDX5902: 5 V/10 kΩ
DDX7015BT/DDX715WBT:
4 V/10 kΩ

Preout Impedance
DDX5902: ≤ 250 Ω
DDX7015BT/DDX715WBT:
≤ 600 Ω

Speaker Impedance
4 Ω to 8 Ω

❑ General

Operating Voltage
14.4 V (10.5 V to 16 V allowable)

Maximum Current Consumption
10 A

Installation Dimensions (W × H × D)
DDX7015BT/DDX5902:
182 mm × 112 mm × 157 mm
(7-3/16" × 4-7/16" × 6-3/16")
DDX715WBT:
178 mm × 100 mm × 159 mm
(7" × 3-15/16" × 6-5/16")
206 mm × 104 mm × 159 mm
(including the sub panel part)

Operational Temperature Range
-10°C to +60°C

Weight
DDX7015BT: 2.5 kg (5.5 lbs)
DDX5902: 2.0 kg (4.4 lbs)
DDX715WBT: 2.6 kg (5.7 lbs)

Design and specifications are subject to change without notice.

❑ Trademarks and licenses

- Manufactured under license from Dolby Laboratories. Dolby and the double-D symbol are trademarks of Dolby Laboratories.
- "DVD Logo" is a trademark of DVD Format/Logo Licensing Corporation registered in the US, Japan and other countries.
- The "AAC" logo is a trademark of Dolby Laboratories.
- Microsoft and Windows Media are either registered trademarks or trademarks of Microsoft Corporation in the United States and/or other countries.

- "Made for iPod," and "Made for iPhone" mean that an electronic accessory has been designed to connect specifically to iPod, or iPhone, respectively, and has been certified by the developer to meet Apple performance standards. Apple is not responsible for the operation of this device or its compliance with safety and regulatory standards. Please note that the use of this accessory with iPod, or iPhone may affect wireless performance. iPhone, iPod, iPod classic, iPod nano, and iPod touch are trademarks of Apple Inc., registered in the U.S. and other countries.
- Lightning is a trademark of Apple Inc.
- This item incorporates copy protection technology that is protected by U.S. patents and other intellectual property rights of Rovi Corporation. Reverse engineering and disassembly are prohibited.
- Font for this product is designed by Ricoh.
- THIS PRODUCT IS LICENSED UNDER THE MPEG-4 VISUAL PATENT PORTFOLIO LICENSE FOR THE PERSONAL AND NON-COMMERCIAL USE OF A CONSUMER FOR (i) ENCODING VIDEO IN COMPLIANCE WITH THE MPEG-4 VISUAL STANDARD ("MPEG-4 VIDEO") AND/OR (ii) DECODING MPEG-4 VIDEO THAT WAS ENCODED BY A CONSUMER ENGAGED IN A PERSONAL AND NON-COMMERCIAL ACTIVITY AND/OR WAS OBTAINED FROM A VIDEO PROVIDER LICENSED BY MPEG LA TO PROVIDE MPEG-4 VIDEO. NO LICENSE IS GRANTED OR SHALL BE IMPLIED FOR ANY OTHER USE. ADDITIONAL INFORMATION INCLUDING THAT RELATING TO PROMOTIONAL, INTERNAL AND COMMERCIAL USES AND LICENSING MAY BE OBTAINED FROM MPEG LA, LLC. SEE [HTTP://WWW.MPEGLA.COM](http://www.mpegla.com).

REFERENCES

- THIS PRODUCT IS LICENSED UNDER THE AVC PATENT PORTFOLIO LICENSE FOR THE PERSONAL USE OF A CONSUMER OR OTHER USES IN WHICH IT DOES NOT RECEIVE REMUNERATION TO (i) ENCODE VIDEO IN COMPLIANCE WITH THE AVC STANDARD ("AVC VIDEO") AND/OR (ii) DECODE AVC VIDEO THAT WAS ENCODED BY A CONSUMER ENGAGED IN A PERSONAL ACTIVITY AND/OR WAS OBTAINED FROM A VIDEO PROVIDER LICENSED TO PROVIDE AVC VIDEO. NO LICENSE IS GRANTED OR SHALL BE IMPLIED FOR ANY OTHER USE. ADDITIONAL INFORMATION MAY BE OBTAINED FROM MPEG LA, L.L.C. SEE [HTTP://WWW.MPEGLA.COM](http://www.mpegla.com)
- Pandora, the Pandora logo, and the Pandora trade dress are trademarks or registered trademarks of Pandora Media, Inc., used with permission.
- HD Radio Technology manufactured under license from iBiquity Digital Corporation. U.S. and Foreign Patents. HD Radio™ and the HD, HD Radio, and "Arc" logos are proprietary trademarks of iBiquity Digital Corp.
- Sirius, XM and all related marks and logos are trademarks of Sirius XM Radio Inc. All rights reserved.
- Android is a trademark of Google Inc.
- BlackBerry®, RIM®, Research In Motion® and related trademarks, names and logos are the property of Research In Motion Limited and are registered and/or used in the U.S. and countries around the world. Used under license from Research In Motion Limited.
- The Bluetooth® word mark and logos are registered trademarks owned by Bluetooth SIG, Inc. and any use of such marks by JVC KENWOOD Corporation is under license. Other trademarks and trade names are those of their respective owners.
- The terms HDMI and HDMI High-Definition Multimedia Interface, and the HDMI logo are trademarks or registered trademarks of HDMI Licensing LLC in the United States and other countries.
- MHL and the MHL logo are a trademark or registered trademark of MHL, LLC.
 - Incorporates MHL 2
- iHeartRadio® is a registered mark of Clear Channel Broadcasting, Inc. in the United States and other countries. Such marks are used under license.
- libFLAC
 - Copyright (C) 2000,2001,2002,2003,2004,2005,2006,2007,2008,2009 Josh Coalsou
 - Redistribution and use in source and binary forms, with or without modification, are permitted provided that the following conditions are met:
 - Redistributions of source code must retain the above copyright notice, this list of conditions and the following disclaimer.
 - Redistributions in binary form must reproduce the above copyright notice, this list of conditions and the following disclaimer in the documentation and/or other materials provided with the distribution.
 - Neither the name of the Xiph.org Foundation nor the names of its contributors may be used to endorse or promote products derived from this software without specific prior written permission.

THIS SOFTWARE IS PROVIDED BY THE COPYRIGHT HOLDERS AND CONTRIBUTORS "AS IS" AND ANY EXPRESS OR IMPLIED WARRANTIES, INCLUDING, BUT NOT LIMITED TO, THE IMPLIED WARRANTIES OF MERCHANTABILITY AND FITNESS FOR A PARTICULAR PURPOSE ARE DISCLAIMED. IN NO EVENT SHALL THE FOUNDATION OR CONTRIBUTORS BE LIABLE FOR ANY DIRECT, INDIRECT, INCIDENTAL, SPECIAL, EXEMPLARY, OR CONSEQUENTIAL DAMAGES (INCLUDING, BUT NOT LIMITED TO, PROCUREMENT OF SUBSTITUTE GOODS OR SERVICES; LOSS OF USE, DATA, OR PROFITS; OR BUSINESS INTERRUPTION) HOWEVER CAUSED AND ON ANY THEORY OF LIABILITY, WHETHER IN CONTRACT, STRICT LIABILITY, OR TORT (INCLUDING NEGLIGENCE OR OTHERWISE) ARISING IN ANY WAY OUT OF THE USE OF THIS SOFTWARE, EVEN IF ADVISED OF THE POSSIBILITY OF SUCH DAMAGE.

- "aupeo" is a trade mark of Aupeo Ltd.
- The aptX® software is copyright CSR plc or its group companies. All rights reserved. The aptX® mark and the aptX logo are trade marks of CSR plc or one of its group companies and may be registered in one or more jurisdictions.

DIVX

- This DivX Certified® device has passed rigorous testing to ensure it plays DivX® video. To play purchased DivX movies, first register your device at vod.divx.com. Find your registration code in the DivX VOD section of your device setup menu. (Page 62)
- DivX Certified® to play DivX® video, including premium content.
- DivX®, DivX Certified® and associated logos are trademarks of DivX, LLC and are used under license.

KENWOOD

Download from www.Somanuals.com. All Manuals Search And Download.

Free Manuals Download Website

<http://myh66.com>

<http://usermanuals.us>

<http://www.somanuals.com>

<http://www.4manuals.cc>

<http://www.manual-lib.com>

<http://www.404manual.com>

<http://www.luxmanual.com>

<http://aubethermostatmanual.com>

Golf course search by state

<http://golfingnear.com>

Email search by domain

<http://emailbydomain.com>

Auto manuals search

<http://auto.somanuals.com>

TV manuals search

<http://tv.somanuals.com>