

KENWOOD

MONITOR WITH DVD RECEIVER

DDX7035

DDX7045

DDX7065

INSTRUCTION MANUAL

KENWOOD CORPORATION



© PRINTED IN JAPAN B64-2843-00/00 (M)(AI)

Contents

Before Use	4
About discs	6
Notes on playing MP3/WMA	7
DDX7035 Basic operations	8
DDX7045/7065 Basic operations	10
Basic Operations of Remote Controller	12
Switch Screen Mode	14
Control during DVD Video or Video CD Playback	16
• Displaying the DVD/VCD Playback screen	
• Displaying the Easy Control Panel	
• Displaying the DVD/VCD Control screen	
• DVD Disc Menu	
• VCD Zoom Control	
• Information Display	
• Direct Search	
Tuner Control	22
• Displaying the Easy Control Panel	
• Displaying the Tuner Control screen	
• Displaying the Tuner Menu screen	
• Seek Mode	
• Auto Memory	
• Manual Memory	
• Preset Select	
• Set Station Name	
• Direct Search	
• Traffic Information	
• Search for Program Type	
• Radio Text	
CD/MP3/WMA/Disc Changer Play Control	28
• Displaying the Easy Control Panel	
• Displaying the CD/MP3/WMA/Disc Changer Control screen	
• Displaying the CD/MP3/WMA/Disc Changer Menu screen	
• Set Disc Name	
• Directory List (during MP3/WMA play)	
• ID3/WMA TAG Display (during MP3/WMA play)	
• Disc Select (during play by disc changer)	
• Direct Search	
TV Control	36
• Displaying the TV Picture screen	
• Displaying the Easy Control Panel	
• Displaying the TV Control screen	
• Displaying the TV Menu screen	
• Seek Mode	
• Auto Memory	
• Manual Memory	
• Preset Select	
• Set Station Name	
Source Select	40
• Displaying the Control screen	
• Displaying the Source Select screen	
Mute Telephone	41
• Mute Telephone	
Character Entry	41
• How To Use the Character Entry screen	
Adjusting the Monitor Display Position and Quality	42
• Displaying the Screen Control screen	
• Displaying the Tilt Control screen	
Setup Menu	
Setup Menu	43
• Displaying the Control screen	
• Displaying the Setup Menu screen	
Audio Set Up	44
• Displaying the Audio Set Up screen	
• Crossover Network Setup	
Audio Set Up	46
• Displaying the Car Type Set Up screen	
• Displaying the Speaker Set Up screen	
• Displaying the Channel Level screen	
• Channel Level	
• DTA Setup	
• High Pass Filter Setup	
• Low Pass Filter Setup	
DVD Setup	52
• Displaying the DVD SETUP 1 screen	
• Displaying the DVD SETUP2 screen	
• Language Setup	
• Parental Level Setup	
System Setup	56
• Displaying the System Set Up 1 screen	
• Displaying the System Set Up 2 screen	
AV Interface	58
• Displaying the AV I/F 1 screen	
• Displaying the AV I/F 2 screen	
User Interface	60
• Displaying the User I/F 1 screen	
• Displaying the User I/F 2 screen	
• Touch Panel Adjust	
• Clock	
• Security Code Setup	
TV Setup	64
• Displaying the TV1 Area Set Up screen	
• Displaying the TV2 Area Set Up screen	
RDS Setup <Function of DDX7035>	65
• Displaying the RDS Set Up 1 screen	
• Displaying the RDS Set Up 2 screen	
AMP Control	66
• Displaying the AMP Control screen	

Sound Effects Menu

Sound Effects Menu	68
• Displaying the Control screen	
• Displaying the Sound Effects Menu screen	
Audio Control	69
• Displaying the Audio Control 1 screen	
• Displaying the Audio Control 2 screen	
Equalizer	70
• Displaying the Equalizer screen	
• Tone curve setup	
• Parametric Equalizer	
Zone Control	74
• Displaying the Zone Control screen	
Digital Effect	75
• Displaying the Digital Effect screen	
Position	76
• Displaying the Position screen	
Hands-Free Unit Control	78
GSM control	78
• Displaying the Control screen	
• When called	
• When dialing	
• Calling by Phone Book	
• Addition to Phone Book	
• Editing the Phone Book	
• Quick Dialing	
• Hand Free Setup	
• Reading the SMS (Short Message Service) messages	
• Creating an SMS (Short Message Service) message	
Glossary	86
Troubleshooting Guide	87
Specifications	92

Before Use

⚠ WARNING

To prevent injury and/or fire, take the following precautions:

- Ensure that the unit is securely installed. Otherwise it may fly out of place during collisions and other jolts.
- When extending the ignition, battery or ground wires, make sure to use automotive-grade wires or other wires with an area of 0.75mm² (AWG18) or more to prevent cable deterioration and damage to the cable coating.
- To prevent short circuits, never put or leave any metallic objects (e.g., coins or metal tools) inside the unit.
- If the unit starts to emit smoke or strange smells, turn off the power immediately and consult your Kenwood dealer.
- Do not touch the liquid crystal fluid if the LCD is damaged or broken due to shock. The liquid crystal fluid may be dangerous to your health or even fatal. If the liquid crystal fluid from the LCD contacts your body or clothing, wash it off with soap immediately.

⚠ CAUTION

To prevent damage to the machine, take the following precautions:

- Make sure to ground the unit to a negative 12V DC power supply.
- Do not open the top or bottom covers of the unit.
- Do not install the unit in a spot exposed to direct sunlight or excessive heat or humidity. Also avoid places with too much dust or the possibility of water splashing.
- Do not subject the faceplate to excessive shock, as it is a piece of precision equipment.
- When replacing a fuse, only use a new one with the prescribed rating. Using a fuse with the wrong rating may cause your unit to malfunction.
- To prevent short circuits when replacing a fuse, first disconnect the wiring harness.
- Do not use any screws except for the ones provided. The use of improper screws might result in damage to the main unit.
- You cannot view video pictures whilst the vehicle is moving. To enjoy TV/video pictures, find a safe place to park and engage the parking brake.

NOTE

- If you experience problems during installation, consult your Kenwood dealer.
- If the unit does not seem to be working right, try pressing the reset button first. If that does not solve the problem, consult your Kenwood dealer.

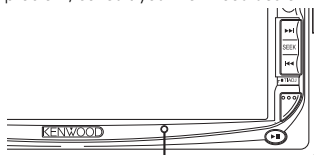

Reset button

Screen brightness during low temperatures

When the temperature of the unit falls such as during winter, the liquid crystal panel's screen will become darker than usual. Normal brightness will return after using the monitor for a whilst.

Audio units you can control from the DDX7035/7045/7065 Receiver (in November of 2003):

KDC-CPS89, KDC-CPS87, KDC-CPS85, KDC-C719, KDC-C717, KDC-C715, KDC-C669, KDC-C667, KDC-C665, KDC-D301, KDV-C810, KDC-CPS89P, KCA-HF521, KTC-V500N/P/E (Set the "O-N" switch to "N" position if provided.)

Navigation units you can control from the DDX7035/7045/7065 Receiver (in November of 2003):

KNA-DV2600

Loading and Replacing the battery

Use one lithium battery (CR2025). Insert the batteries with the ⊕ and ⊖ poles aligned properly, following the illustration inside the case.

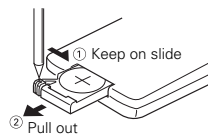

⚠ WARNING

Store unused batteries out of the reach of children. Contact a doctor immediately if the battery is accidentally swallowed.



Do not set the remote on hot places such as above the dashboard.



- The provided batteries are intended for use in operation checking, and their service life may be short.
- When the remote controllable distance becomes short, replace both of the batteries with new ones.

Cleaning the panel and monitor

When the operator panel and monitor panels are dirty, wipe and clean them using a soft cloth (such as a commercially available silicon coated cloth). When contaminated excessively, clean them using a cloth dipped in a neutral detergent first, then remove the detergent using a dry cloth. Do not use a hard cloth and a volatile chemical (such as an alcohol). If used, the panel surface may be scratched or printed letters may be erased.

Cleaning the disc slot

As dust can accumulate in the disc slot, clean it occasionally. Your discs can get scratched if you put them in a dusty disc slot.

Lens Fogging

Right after you turn on the car heater in cold weather, dew or condensation may form on the lens in the disc player of the unit. Called lens fogging, discs may be impossible to play. In such a situation, remove the disc and wait for the condensation to evaporate. If the unit still does not operate normally after a whilst, consult your Kenwood dealer.

The marking of products using lasers (Except for some areas)

**CLASS 1
LASER PRODUCT**

The label is attached to the chassis/case and says that the component uses laser beams that have been classified as Class 1. It means that the unit is utilizing laser beams that are of a weaker class. There is no danger of hazardous radiation outside the unit.

Region codes in the world

The DVD players are given a region code according to the country or area it is marketed, as shown in the following map.

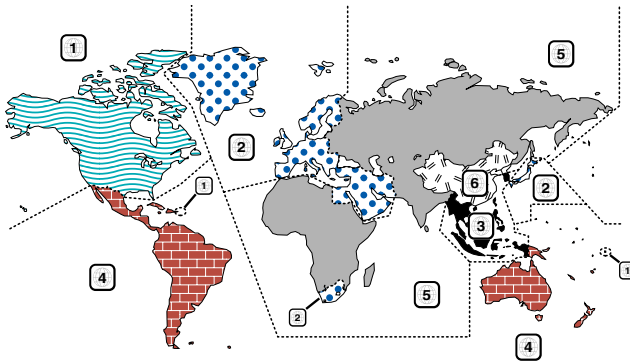

Icons on the DVD discs

Icon	Description
	Indicates the region code where the disc can be played.
	Number of voice languages recorded with the audio function. The number in the icon indicates the number of voice languages. (Max. 8 languages)
	Number of subtitle languages recorded with the subtitle function. The number in the icon indicates the number of subtitle languages. (Max. 32 languages)
	Number of angles provided by the angle function. The number in the icon indicates the number of angles. (Max. 9 angles)
	Aspect ratios that can be selected. "LB" stands for Letter Box and "PS" for Pan/Scan. In the example on the left, the 16:9 video can be converted into letter box video.

Unplayable discs

This player cannot play back any of the following discs.

- DVD-ROM/DVD-RAM discs
- HQ-VCD discs
- CDV discs (Only the audio part can be reproduced)
- CD-G/CD-EG/CD-EXTRA discs (Only the audio can be reproduced)
- Photo CD discs
- DVD-Audio

Also, you cannot play back the DVD-R/RW and DVD+R/RW discs if not recorded in the DVD-Video format.

Restrictions due to difference between discs

Some DVD and VCD discs can be played only in certain playback modes according to the intentions of the software producers. As this player plays discs according to their intentions, some functions may not work as intended by you. Please be sure to read the instructions provided with each disc. When an inhibition icon is displayed on the monitor, it indicates that the disc being played is under the restriction as described above.



The illustrations of the display and the panel appearing in this manual are examples used to explain more clearly how the controls are used. Therefore, what appears on the display in the illustrations may differ from what appears on the display on the actual equipment, and some of the illustrations on the display may represent something impossible in actual operation.

Explanation of icons used on this manual



Indicates the key operation on the receiver.



Indicates the button you must touch.



Indicates the key or joystick operation on the remote controller.



The initial value of each setup is shown.



Gives an additional information or an operation advice.

Time is displayed on each control screen in the 12 hour clock display type (with AM/PM displayed) or in the 24 hour clock display type (without AM/PM displayed) depending on the sales area. The display type cannot be changed. In this instruction manual, screens of the 24 hour display type are used as examples.

About discs

Handling discs

- Don't touch the recording surface of the disc.

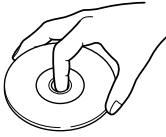

- CD-R/RW, DVD-R/RW, and DVD+R/RW are easier to damage than a normal music CD. Use a CD-R/RW, DVD-R/RW, or DVD+R/RW after reading the caution items on the package etc.
- Don't stick tape etc. on the disc. Also, don't use a disc with tape stuck on it.

When using a new disc

If the disc center hole or outside rim has burrs, use it after removing them with a ball pen etc.

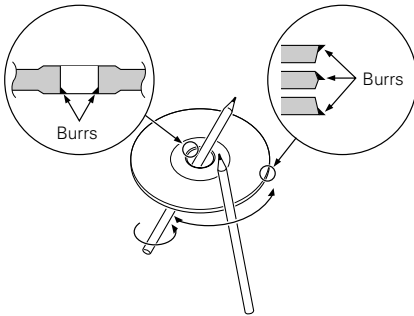

Disc accessories

Don't use disc type accessories.

Disc cleaning

Clean from the center of the disc and move outward.

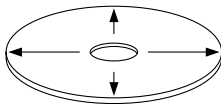



Removing discs

When removing discs from this unit pull them out horizontally.

Discs that can't be used

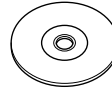
- Discs that aren't round can't be used.



- Discs with coloring on the recording surface or that are dirty can't be used.
- This unit can only play the CDs with . It may not correctly play discs which do not have the mark.
- A CD-R or CD-RW that hasn't been finalized can't be played. (For the finalization process refer to your CD-R/CD-RW writing software, and your CD-R/CD-RW recorder instruction manual.)

Disc storage

- Don't place them in direct sunlight (On the seat or dashboard etc.) and where the temperature is high.
- Store discs in their cases.

Notes on playing MP3/WMA

This unit can play MP3 (MPEG1 Audio Layer 3)/WMA.

Note, however, that the MP3 recording media and formats acceptable are limited. When writing MP3, pay attention to the following restrictions.

Acceptable media

The MP3/WMA recording media acceptable to this unit are CD-ROM, CD-R, and CD-RW.

When using CD-RW, do full format not quick format to prevent malfunction.

Acceptable medium formats

The following formats are available for the media used in this unit. The maximum number of characters used for file name including the delimiter ("") and three-character extension are indicated in parentheses.

- ISO 9660 Level 1 (12 characters)
- ISO 9660 Level 2 (31 characters)
- Joliet (64 characters)
- Romeo (128 characters)

Up to 170 characters can be displayed in the long file name format. For a list of available characters, see the instruction manual of the writing software and the section Entering file and folder names below.

The media reproducible on this unit has the following limitations:

- Maximum number of directory levels: 8
- Maximum number of files per folder: 255
- Maximum number of characters for folder name: 64
- Maximum number of folders: 100

MP3 written in the formats other than the above may not be successfully played and their file names or folder names are not properly displayed.

Settings for your MP3/WMA encoder and CD writer

Do the following setting when compressing audio data in MP3 data with the MP3/WMA encoder.

- Transfer bit rate: MP3: 8 —320 kbps
WMA: 48 —192 kbps
- Sampling frequency: MP3: 32, 44.1, 48 kHz
WMA: 32, 44.1, 48 kHz

When you use your CD writer to record MP3/WMA up to the maximum disc capacity, disable additional writing. For recording on an empty disc up to the maximum capacity at once, check Disc at Once.

 Play mode may not be possible when portions of the functions of Windows Media Player 9 or higher are used.

Entering ID3 tag

The Displayable ID3 tag is ID3 version 1.x.

For the character code, refer to the List of Codes.

	0	1	2	3	4	5	6	7	8	9	A	B	C	D	E	F
0		0	@	P	p					■	▲	▲	▲	▲	▲	▲
1		1	1	A	Q	a	q			!	=	A	N	a	n	
2		2	B	R	b	r				e	T	A	O	a	o	
3		#	3	C	S	c	s			£	1	A	O	a	o	
4		\$	4	D	T	d	t			¢	A	O	a	o		
5		%	5	E	U	e	u			¥	µ	A	O	a	o	
6		&	6	F	V	f	v			!	!	!	!	!	!	!
7		7	G	W	w					§	!	!	!	!	!	!
8		(8	H	X	h	x			²	!	!	!	!	!	!
9)	9	I	Y	i	y			©	!	!	!	!	!	!
A		*	A	J	Z	j	z			±	=	E	U	e	u	
B		+	B	K	k					~	!	!	!	!	!	!
C		<	C	L	l					¼	!	!	!	!	!	!
D		=	D	M	m					½	!	!	!	!	!	!
E		>	E	N	n					¾	!	!	!	!	!	!
F		?	F	O	o					!	!	!	!	!	!	!

Entering file and folder names

The code list characters are the only file names and folder names that can be entered and displayed.

If you use any other character for entry, the file and folder names are not displayed correctly. They may neither be displayed correctly depending on the CD writer used. The unit recognizes and plays only those MP3/WMA which have the MP3 extension (.MP3/WMA).

 A file with a name entered with characters not on the code list may not play correctly.

Writing files into a medium

When a medium containing MP3/WMA data is loaded, the unit checks all the data on the medium. If the medium contains a lot of folders or non-MP3/WMA files, therefore, it takes a long time until the unit starts playing MP3/WMA. In addition, it may take time for the unit to move to the next MP3/WMA file or a File Search or Folder Search may not be performed smoothly.

 Loading such a medium may produce loud noise to damage the speakers.

- Do not attempt to play a medium containing a non-MP3/WMA file with the MP3/WMA extension. The unit mistakes non-MP3/WMA files for MP3/WMA data as long as they have the MP3/WMA extension.
- Do not attempt to play a medium containing non-MP3/WMA.

MP3/WMA playing order

When selected for play, Folder Search, File Search, or Folder Select, files and folders are accessed in the order in which they were written by the CD writer. Because of this, the order in which they are expected to be played may not match the order in which they are actually played. You may be able to set the order in which MP3/WMA are to be played by writing them onto a medium such as a CD-R with their file names beginning with play sequence numbers such as "01" to "99", depending on your CD writer.

DDX7035 Basic operations

English

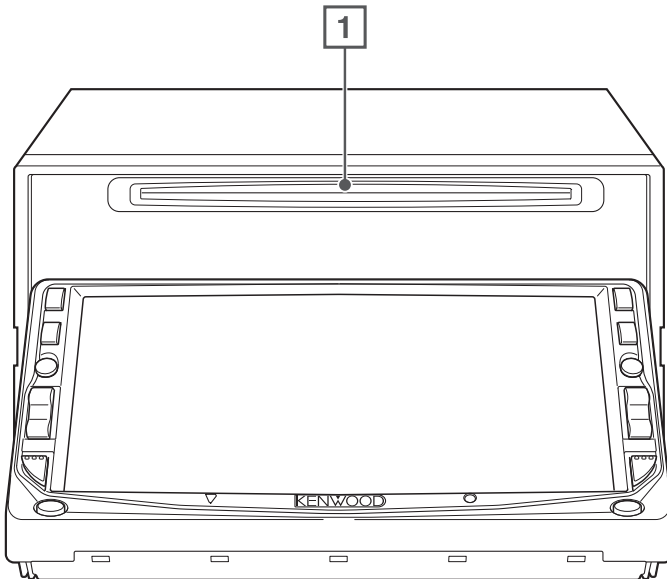
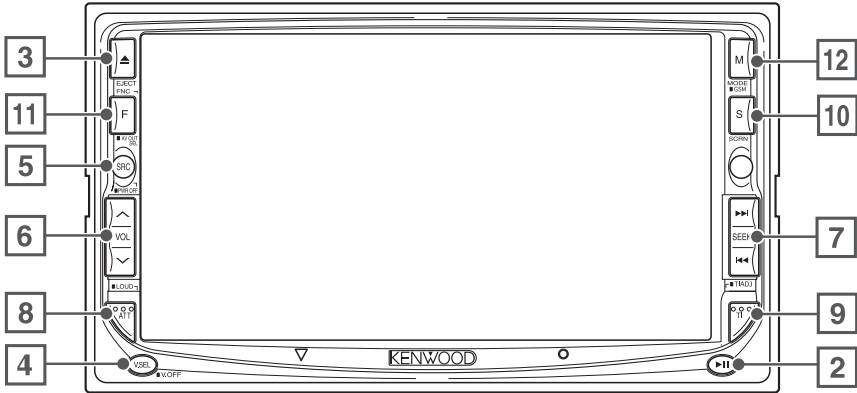

1 Play Disc

[Disc insertion slot]

A disc is played when you insert it.

2 Play/Pause

[▶||] key

Pauses and replays a disc.

3 Eject Disc

[EJECT] key

The disc is ejected.

4 Switch Video Sources

[V.SEL] key

The video sources are switched each time you press the key.



* Optional accessory

Clears the video image when pressed more than one second. When pressed again, the original image is redisplayed.

5 Switch Audio Source/Power Supply

[SRC] key

The audio sources are switched each time you press the key.

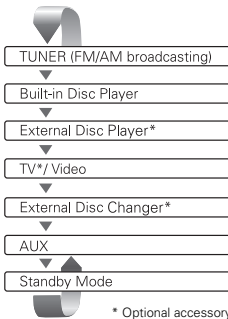

* Optional accessory

Hold down more than 1 second to turn the power supply Off. Push it again to turn power supply On.

6 Volume Controls

[VOL] key

7 Track/Station Selectors

[SEEK] key

Selects a music or chapter, track, or frequency.

8 Attenuator/Loudness

[ATT]/[LOUD] key

Attenuates the volume.

Press it again to cancel muting.

Press it for more than one second to turn the Loudness function on or off. (see page 69)

If turned on, high and low tones are enhanced during low volume.

9 Traffic Information

[TI] key

Turns the Traffic Information function On or Off. (see page 26)

10 Screen Setup

[SCRN] key

Displays the Screen Control or Tilt Control screen. (see page 42)

11 Function

[FNC] key

The video sources are switched each time you press the key.

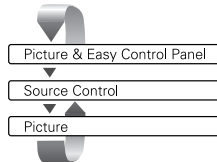

Switches the source that is output at the AV OUTPUT terminal when it is pressed more than 1 second.

12 Switch Screen Mode/GSM

[MODE]/[GSM] key

The screen mode is switched. (see page 14)

The GSM Control screen appears when you hold down the key more than 1 second. (see page 78)



The display turns on when you put the parking brake, except for the navigation system.

DDX7045/7065 Basic operations

English

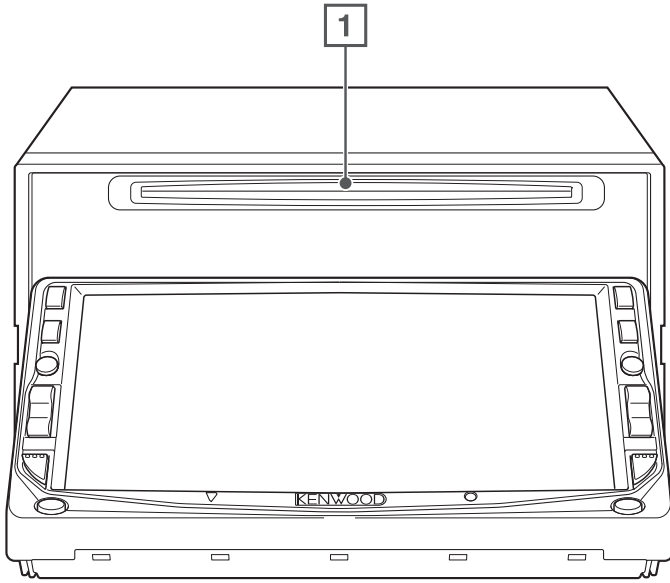
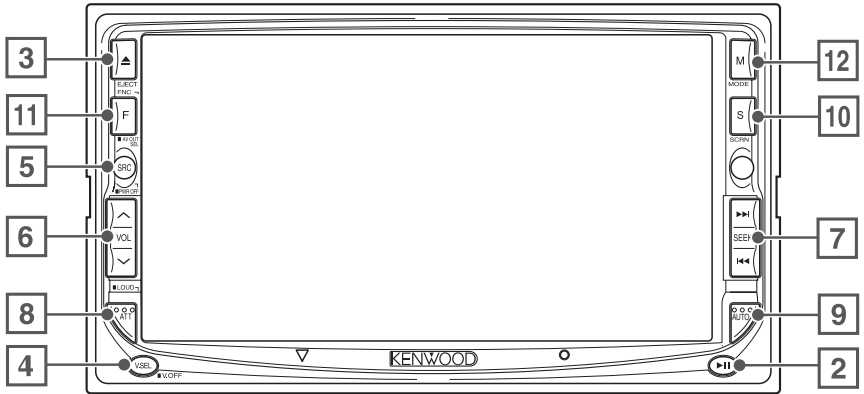

1 Play Disc

[Disc insertion slot]

A disc is played when you insert it.

2 Play/Pause

[▶||] key

Pauses and replays a disc.

3 Eject Disc

[EJECT] key

The disc is ejected.

4 Switch Video Sources

[V.SEL] key

The video sources are switched each time you press the key.



* Optional accessory

Clears the video image when pressed more than one second. When pressed again, the original image is redisplayed.

5 Switch Audio Source/Power Supply

[SRC] key

The audio sources are switched each time you press the key.

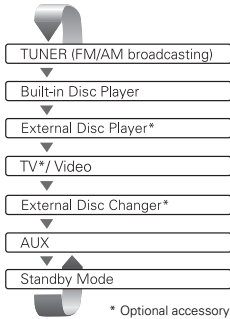

* Optional accessory

Hold down more than 1 second to turn the power supply Off. Push it again to turn power supply On.

6 Volume Controls

[VOL] key

7 Track/Station Selectors

[SEEK] key

Selects a music or chapter, track, or frequency.

8 Attenuator/Loudness

[ATT]/[LOUD] key

Attenuates the volume.

Press it again to cancel muting.

Press it for more than one second to turn the Loudness function on or off. (see page 69)

If turned on, high and low tones are enhanced during low volume.

9 Select Seek Mode

[AUTO] key

Selects the Seek mode. (see pages 24/38 for the <Seek Mode>)

10 Screen Setup

[SCRN] key

Displays the Screen Control or Tilt Control screen. (see page 42)

11 Function

[FNC] key

The video sources are switched each time you press the key.

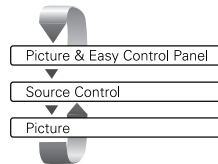

Switches the source that is output at the AV OUTPUT terminal when it is pressed more than 1 second.

12 Switch Screen Mode/GSM

[MODE]/[GSM] key

The screen mode is switched. (see page 14)

The GSM Control screen appears when you hold down the key more than 1 second. (see page 78)



The display turns on when you put the parking brake, except for the navigation system.

Basic Operations of Remote Controller

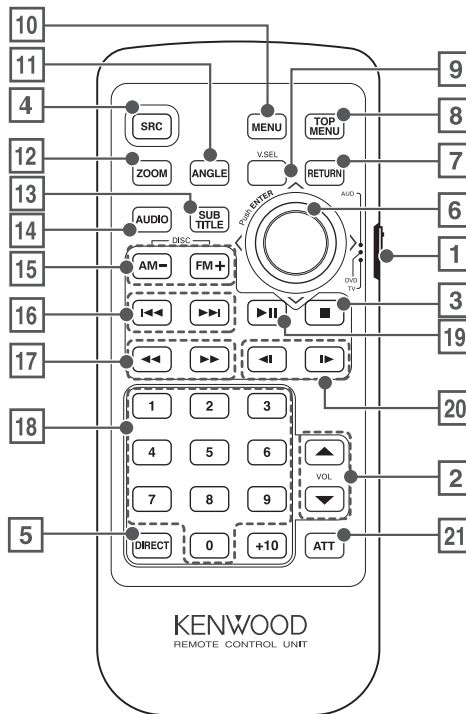

1 Remote Control Mode selector

Selects one of the following remote control modes.
 TV: TV source
 DVD: Built-in DVD/VCD/CD/MP3/WMA player source
 AUD: Tuner source or attached disc changer/disc player source

2 Volume Control

Adjusts the volume.

3 [DISC]

Stops to play the built-in disc player.

4 Switches over the sound source each time it is pressed.

5 Selects the Direct Search mode.
 (see pages 21/26/35/39 for <Direct Search>)

6 Joystick

[DVD]

Enters your selection from the DVD Disc Menu.

7 [DVD] [VCD]

Returns to the previous screen when the DVD/VCD Disc Menu is used.

8 [DVD]

Calls the Top menu of DVD Disc Menu.

9 Switch Video Sources

[V.SEL] key (When **[1]** is set to "TV")

The video sources are switched each time you press the key.



* Optional accessory

10 [DVD]

Calls the DVD Disc Menu.

11 [DVD]

Each time you press the button, the angle switches.

12 [DVD] [VCD]

Each time you press the button, the zoom ratio switches.

13 [DVD]

Switches a subtitle language.

14 [DVD]

Switches an audio language.

15 [DISC]

Select a folder or a disc.

[TV]

FM: Switches to TV1, TV2, or VIDEO.

[TUNER]

FM: Switches to the FM1, FM2, or FM3 band.

AM: Switches to the AM band.

16 [DISC]

Selects a chapter, a track or a song.

[TV]

Select a channel.

[TUNER]

Selects a station.

17 [DVD] [VCD]

◀◀ : Fast Backward (Rewind). The speed changes each time it is pressed.

▶▶ : Fast Forward. The speed changes each time it is pressed.

18 [TV] [TUNER]

[1] — **[6]** : Call the stations from memory.

19 [DISC]

Plays or pauses.

[TV] [TUNER]

Selects the Seek mode. (see page 24/38 for the <Seek Mode>)

20 [DVD]

◀■ : Slow Backward.

■▶ : Slow Forward.

21 Attenuator

[ATT] key

Attenuates the volume.

Press it again to cancel muting.

[DVD]

: An operation during DVD playback

[VCD]

: An operation during VCD playback

[DISC]

: An operation during DVD, VCD, CD, MP3/WMA or MD playback

[TV]

: An operation during TV source

[TUNER]

: An operation during FM/AM broadcasting source

Switch Screen Mode

The Screen mode of the monitor changes each time the [MODE] key is pressed.

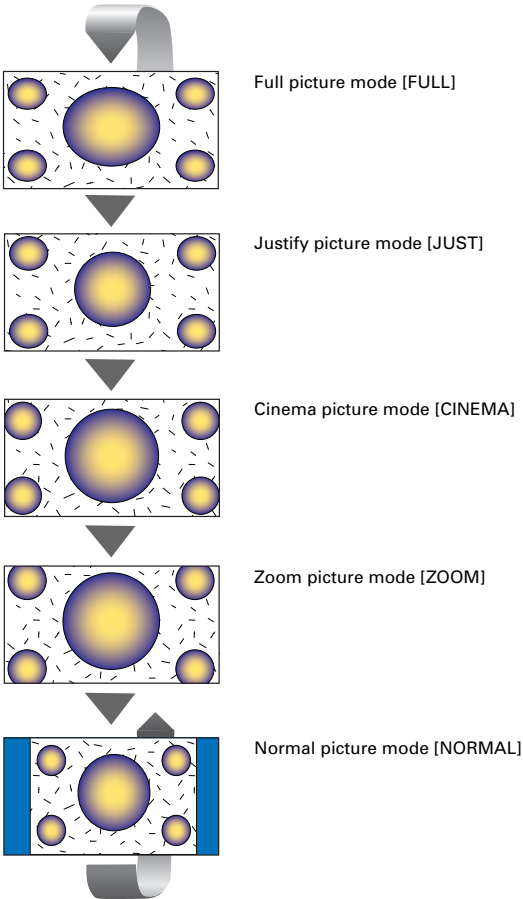
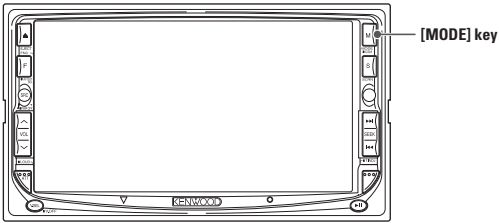

- When the Menu, Easy Control screen, or Navigation is selected, it is shown in the full-size display mode automatically. Their Screen mode cannot be changed.
- The Screen mode can be set for each of DVD/VCD, TV, and video images.

Control during DVD Video or Video CD Playback

Control during DVD Video or Video CD Playback

Various control screens appear when you play back a DVD Video (DVD) or a Video

Displaying the DVD/VCD Playback screen

You can use the following operations when displaying DVD/VCD images.

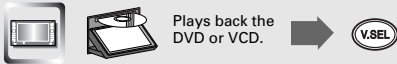

DVD playback screen

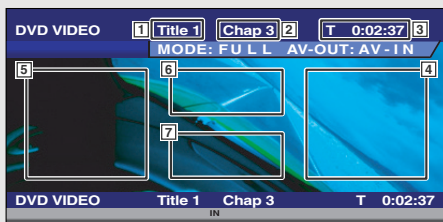

VCD playback screen

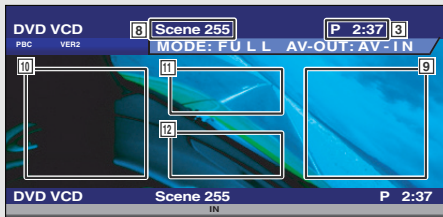

- 1 Title Number Display
- 2 Chapter Number Display
- 3 Play Time Display
- 4 Forward Chapter Search Area
Selects the next chapter.
- 5 Backward Chapter Search Area
Selects the previous chapter.
- 6 DVD Disc Menu Control Buttons Area
Displays the Disc Menu Control buttons. (see page 20)
- 7 Information Display Button Area (see page 21)

- 8 Scene/Track Number Display
- 9 Forward Scene/Track Search Area
Selects the next scene (when PBC is On) or track (when PBC is Off).
- 10 Backward Scene/Track Search Area
Selects the previous scene (when PBC is On) or track (when PBC is Off).
- 11 Zoom Control Button Area
Displays the Zoom Control buttons. (see page 21)
- 12 Information Display Button Area (see page 21)



- For DVD/VCD playback, DVD/VCD picture selection, or controller key operations, see <DDX7035/7045/7065 Basic Operations> (see page 8/10).
- The information display is cleared automatically after approximately 5 seconds. Also, the information can be displayed automatically when it is updated (see page 61).

CD (VCD) disc.

Displaying the Easy Control Panel

The Control Panel is displayed in a floating position of the DVD/VCD screen.



Display of Easy Control Panel

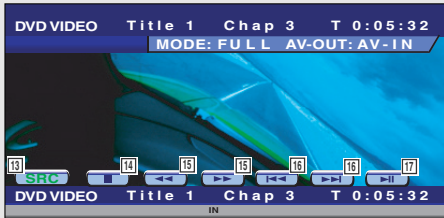

13 Switches the source.

14 Stops to play.

15 Rewinds or fast forwards.

16 **Chapter Search (DVD)**

Searches for a chapter.

Scene/Track Search (VCD)

Selects a scene (when PBC is On) or a track (when PBC is Off).

17 Plays or pauses.



The Easy Control Panel display is cleared when you touch the center of image display area.

Control during DVD Video or Video CD Playback

Displaying the DVD/VCD Control screen

Plays a DVD/VCD using various functions.



DVD/VCD Control screen



- 18 Ejects the disc from the built-in disc player.
- 19 Calls the Sound Effects Menu. (see page 68)
- 20 Calls the Setup Menu. (see page 43)
- 21 Displays the Source Select screen. (see page 40)
- 22 Fast Forwards or Rewinds.
- 23 Stops to play.
When pressed twice, the disc is played from its beginning when you play it in the next time.
- 24 Selects a chapter, a scene or a track.
When the DVD is paused, touch this button to start single-frame stepping.
- 25 Plays or pauses.
- 26 Slow Forwards or Backwards. (during DVD playback only)
- 27 Turns the PBC function of VCD On or Off. (when VCD Ver 2.0 or SVCD is in use only)
- 28 Switches the Repeat Play operations in the following sequence.
DVD: Title Repeat, Chapter Repeat, Repeat Off
VCD: Track Repeat, Repeat Off (Available when the PBC is off)
- 29 Scrolls the display text.
- 30 Switches the play time display in the following sequence.
DVD: Title, chapter, remaining titles
VCD: Track, disc, remaining discs (Effective only when the PBC function is off)
- 31 Title Number Display (DVD)
- 32 Chapter/Scene/Track Number Display
- 33 Play Time Display
- 34 Appears when a disc is inserted.
- 35 Function Indicator

Control during DVD Video or Video CD Playback

DVD Disc Menu

Selects an option from the DVD Disc Menu.

1 Displays the Disc Menu Control screen



6 DVD Disc Menu Control Buttons Area (page 16)

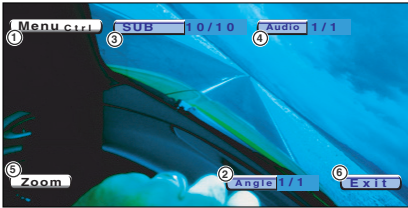

- 1 Calls the Menu Control.
- 2 Switches the picture angle.
(during program playback only)
- 3 Switches the caption language.
(during program playback only)
- 4 Switches the voice language.
(during program playback only)
- 5 Displays the Zoom Control screen.
- 6 Clears the Disc Menu Control.

2 Select Disc Menu options

Disc Menu



Menu ctrl

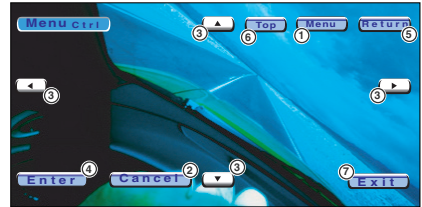

- 1 Calls the Menu.
- 2 Returns to the Disc Menu Control screen.
- 3 Selects a menu option.
- 4 Enters your menu selection.
- 5 Returns to the previous menu screen.
- 6 Displays the Top Menu.
- 7 Clears the Disc Menu Control.

Zoom Control



Zoom

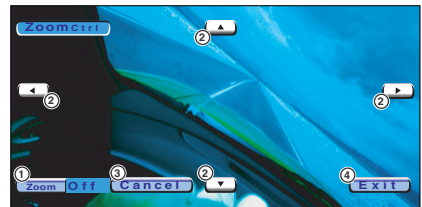

- 1 Changes the zoom ratio at 4 levels (2 times, 3 times, 4 times, or off) each time you touch.
- 2 Scrolls the screen in the direction you touch.
- 3 Returns to the Disc Menu Control screen.
- 4 Clears the Disc Menu Control.

VCD Zoom Control

Displays an enlarged VCD screen.

1 Displays the Zoom Control screen



11 Zoom Control Button Area
(page 16)

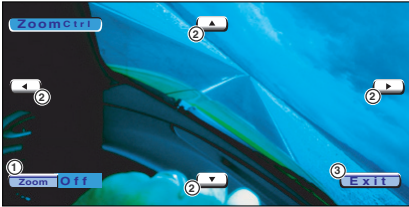

- 1 Changes the zoom ratio at 4 levels (2 times, 3 times, 4 times, or off) each time you touch.
- 2 Scrolls the screen in the direction you touch.
- 3 Clears the Zoom Control button.

Information Display

Displays the DVD and AV information.



7

12

Information Display Button Area
(Page 16)

The information is displayed for 5 seconds.

Direct Search

You can search for a DVD/VCD chapter, scene or track by entering its number.

1 Selects the Direct Search mode



DIRECT

The following items can be searched directly each time it is pressed.

DVD: Title, Chapter, Time, Direct number

VCD (when PBC is On): Scene, Direct number

VCD (when PBC is Off): Track, Time

However, the direct search may not be supported for some discs.

2 Enter a number or time



0

9

3 Search



The operation ends automatically if you do not operate within 10 seconds.

Tuner Control

Various control screens appear in the Tuner Source mode.

Displaying the Easy Control Panel

The Tuner Control Panel is displayed in a floating position of the selected picture.



Displaying the Easy Control Panel

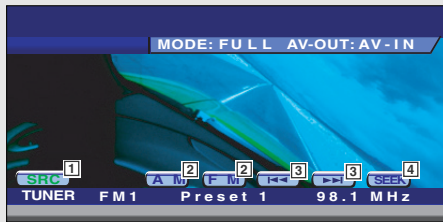

- 1 Switches the source.
- 2 Switches the band (to AM or FM1/2/3).
- 3 Tunes in a station
- 4 Switches the Seek mode.
(see page 24 for the <Seek Mode>)



- For receiver key operations, see <DDX7035/7045/7065 Basic Operations> (see page 8/10).
- The Easy Control Panel display is cleared when you touch the center of image display area.

Displaying the Tuner Control screen

You can tune in a station using various functions.



Tuner Control screen

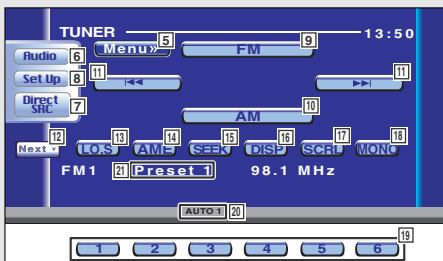

Displaying the Tuner Menu screen

You can select menu options using various functions.



Tuner Menu screen

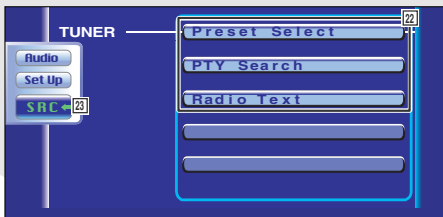

- 5] Calls the Tuner Menu.
- 6] Calls the Sound Effects Menu. (see page 68)
- 7] Displays the Source Select screen. (see page 40)
- 8] Calls the Setup Menu. (see page 43)
- 9] Switches to the FM1/2/3 band.
- 10] Switches to the AM band.
- 11] Tunes in a station.
Use the <Seek Mode> to change the frequency switching.
- 12] Switches between **1** to **6** buttons and Function buttons to use.
- 13] **LOIS** Turns the Local seek function On or Off. <Function of DDX7035>
CRSC Turns the CRSC function On or Off. (Only when receiving the FM broadcast) <Function of DDX7045/7065>
- 14] Selects the Auto Memory mode.
(See page 24 for the <Auto Memory>)
- 15] Switches the Seek mode.
(see page 24 for the <Seek Mode>)
- 16] Selects the Program Service Name, or Radio Text mode for text display. (Only when receiving the FM broadcast) <Function of DDX7035>
- 17] Scrolls the display text. <Function of DDX7035>
- 18] Select the Monaural sound mode. (Only when receiving the FM broadcast) <Function of DDX7035>
- 19] When **1** to **6** buttons appear, you can call up the stations from memory.
For memory of broadcasting stations, see <Auto Memory> (see page 24) or <Manual Memory> (see page 24).
- 20] **Seek Mode Indicator**
- 21] **Memory Number Display**
- 22] Selects options from various function menus.
- 23] Returns to the Tuner Control screen.



The available functions vary depending on the model used (the tuner specifications and the broadcasting system that can be received).

Tuner Control

Seek Mode

Sets a station selection.



If **SEEK** is not shown, touch **Next**.

The mode is switched each time you touch the button.

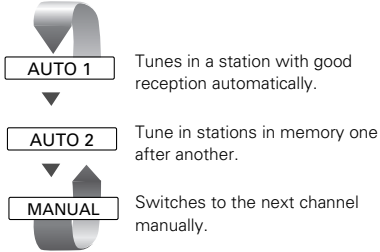

Auto Memory

Stores stations with good reception in memory automatically.

1 Select a band you wish to store in memory



2 Select the Auto Memory mode



If **AME** is not shown, touch **Next**.

3 Start Auto Memory



Touch  or .

Auto Memory terminates when 6 stations are stored or when all stations are tuned in.

 The operation ends automatically if you do not operate within 10 seconds.

Manual Memory

Stores the current receiving station in memory.

1 Select a station you wish to store in memory

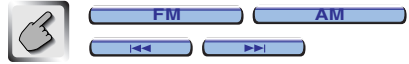

2 Store in memory



If **1** to **6** are not shown, touch **Next**.

Continue to touch until the memory number appears.

Preset Select

Lists and tunes in stations in memory one after the other.

1 Call the Tuner Menu



2 Call the Preset Select Menu

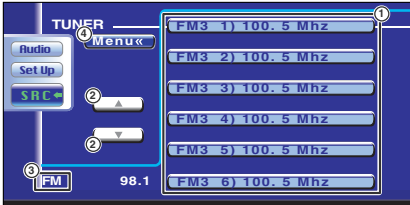

- 1 Tunes in the displayed station.
If the station name is displayed if it has been set. (DDX7045/7065)
- 2 Switches the band of the displayed station list.
- 3 Band Display.
- 4 Returns to the Tuner Menu.

Function of DDX7045/7065

Set Station Name

Names a station.

1 Tune in a station you wish to name



2 Call the Tuner Menu



3 Selects the Set Name mode



4 Enter a name

For character entry details, see <Character Entry> (see page 41).

5 Exit the Set Name mode



- You can store up to 30 stations in memory.
- You can set a station name only after you have applied the parking brake.

Direct Search

Tunes in a station when its frequency is entered.

1 Select a band



FM+

AM-

2 Selects the Direct Search mode



DIRECT

3 Enter a frequency



0

9

When you enter them, signal reception starts.

Example: When you receive FM 92.1 MHz

0 9 2 1

Example: When you receive AM 810 kHz

0 8 1 0



The operation ends automatically if you do not operate within 10 seconds.

Function of DDX7035

Traffic Information

When a traffic bulletin starts, any source is switched to the traffic information and it is displayed automatically.

When the traffic bulletin starts...

The Traffic Information screen appears automatically.

Traffic Information screen

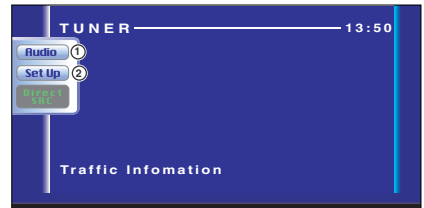

① Calls the Sound Effects Menu. (see page 68)

② Calls the Setup Menu. (see page 43)



During reception of traffic information the adjusted volume is automatically remembered, and the next time it switches to traffic information it's automatically the remembered volume.

Please note that if DSP unit (optional accessory) is connected, the volume will be preset by pressing the  button for 2 seconds or more.

Search for Program Type

A program is tuned when you set its program type.

1 Call the Tuner Menu



2 Call the PTY Search Menu



- ① Selects a program type.
- ② Scrolls the program type list.
- ③ Searches for the program type.
It is displayed when the Program Type is selected.
- ④ Returns to the Tuner Menu.

3 Select a program type



4 Search for the program type



Radio Text

You can display the radio text.

1 Call the Tuner Menu



2 Display the Radio Text

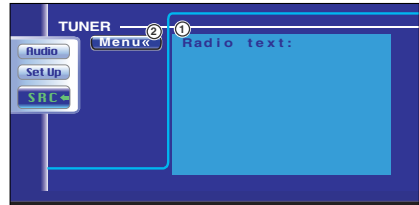

- ① Displays the Radio Text
- ② Returns to the Tuner Menu.

CD/MP3/WMA/Disc Changer Play Control

CD/MP3/WMA/Disc Changer Play Control

You can call various control screens during CD/MP3/WMA/Disc Changer playback.

Displaying the Easy Control Panel

The CD/MP3/WMA/Disc Changer Play Control Panel is displayed in a floating position of the selected picture.



Display of Easy Control Panel
During CD playback

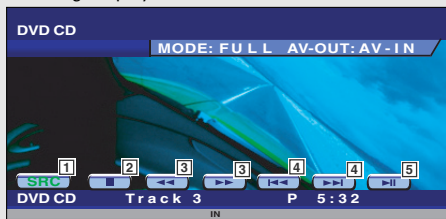

During MP3/WMA playback



During playback on disc changer



During playback on CD player



- 1 Switches the source.
- 2 Stops to play the built-in disc player.
- 3 When a CD is played back on the built-in disc player: Rewinds or fast forwards.
- 4 Selects a song.
- 5 Plays or pauses.
- 6 When an MP3/WMA is played back on the built-in disc player: Selects a folder.
- 7 When a disc is played back on the disc changer: Selects a disc.



- For CD/MP3/WMA/Disc Changer playback and receiver key operations, see <DDX7035/7045/7065 Basic Operations> (see page 8/10).
- The Easy Control Panel display is cleared when you touch the center of image display area.

Displaying the CD/MP3/WMA/ Disc Changer Control screen

You can play the CD/MP3/WMA/disc changer using various functions.



CD Control screen



During CD playback

- 8 Calls the CD Menu.
- 9 Calls the Sound Effects Menu. (see page 68)
- 10 Displays the Source Select screen. (see page 40)
- 11 Calls the Setup Menu. (see page 43)
- 12 Ejects the disc from the built-in disc player.
- 13 Selects a track.
- 14 Fast Forwards or Rewinds.
- 15 Plays or pauses.
- 16 Starts or stops Scan Play (that plays the beginning of each song one after the other).
- 17 Repeats to play (the present track).
- 18 Starts or stops Random Play (to play songs in random order).
- 19 Selects the Disc Name (see <Set Disc Name>, page 33), Disc Text, or Track Text mode for text display.
- 20 Scrolls the display text.
- 21 Switches the play time display between Track, Disc, and Disc Remaining Time.
- 22 **Track Number Display**
- 23 **Play Time Display**
- 24 Appears when a disc is inserted.
- 25 Stops to play the built-in disc player.
When pressed twice, the disc is played back from its beginning in the next time.
- 26 **Function Indicator**

CD/MP3/WMA/Disc Changer Play Control

MP3/WMA Control screen

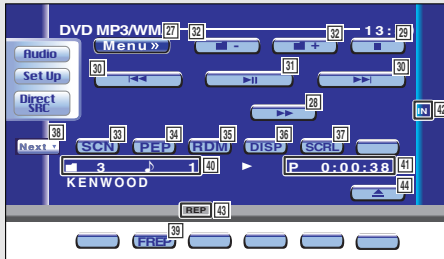

During MP3/WMA play

- 27 Calls the MP3/WMA Menu.
- 28 Fast Forwards.
- 29 Stops to play.
When pressed twice, the disc is played back from its beginning in the next time.
- 30 Selects a song.
- 31 Plays or pauses.
- 32 Selects a folder.
- 33 Starts or stops Scan Play (that plays the beginning of each song one after the other).
- 34 Repeats to play (the present song).
- 35 Starts or stops Random Play (to play songs of the present folder in random order).
- 36 Selects the Folder name, File name, Title (ID3/WMA tag), Artist name (ID3/WMA tag), or Album name (ID3 tag) for text display.
- 37 Scrolls the display text.
- 38 Switches the button display.
- 39 Repeats to play the song of the present folder.
- 40 Folder and File Number Display
- 41 Play Time Display
- 42 Appears when a disc is inserted.
- 43 Function Indicator
- 44 Ejects a disc.

Disc Changer/CD player Control screen

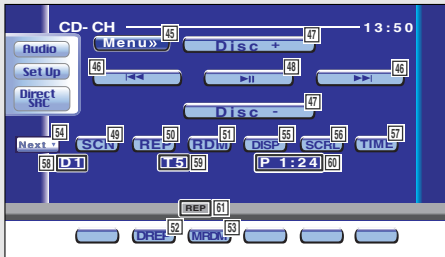

During play by the disc changer/CD player

- 45 Calls the Disc Changer/CD player Menu.
- 46 Selects a track.
Starts Fast Forward or Fast Rewind when it is held down.
- 47 Selects a disc. (Function of Disc Changer)
- 48 Plays or pauses.
- 49 Starts or stops Scan Play (that plays the beginning of each song one after the other).
- 50 Repeats to play (the present track).
- 51 Starts or stops Random Play (to play songs in random order).
- 52 Repeats to play disc (the present disc). (Function of Disc Changer)
- 53 Starts or stops Magazine Random Play (to play songs of the disc changer in random order). (Function of Disc Changer)
- 54 Switches the button display.
- 55 Selects the Disc Name (see <Set Disc Name>, page 33), Disc Text, or Track Text mode for text display.
- 56 Scrolls the display text.
- 57 Switches the play time display between Track, Disc, and Disc Remaining Time.
- 58 **Disc Number Display** (Function of Disc Changer)
- 59 **Track Number Display**
- 60 **Play Time Display**
- 61 **Function Indicator**



The functions that can be used and the information that can be displayed will differ depending on the models being connected.

CD/MP3/WMA/Disc Changer Play Control

Displaying the CD/MP3/WMA/ Disc Changer Menu screen

You can select menu options using various functions.



CD Menu screen

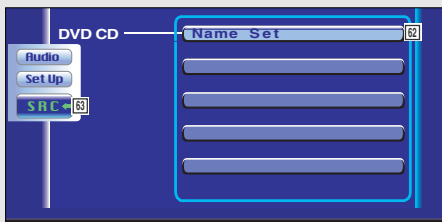

62 Selects options from various function menus.

63 Returns to the CD/MP3/WMA/Disc Changer Control screen.



The available functions vary depending on the source used.

Set Disc Name

Names a CD.

1 Play a CD you wish to name

2 Call the CD/Disc Changer Menu



Menu»

3 Select the Set Name mode



Name Set



The **Name Set** position varies depending on the disc you are playing.

4 Enter a name

For character entry details, see <Character Entry> (see page 41).

5 Exit the Set Name mode



Ok»



- You cannot name an MD or MP3/WMA disc.
- Number of discs that can be stored in memory
Built-in disc player: 10
External CD changer/ player:
Varies depending on the CD changer/ player.
Refer to the CD changer/ player manual.

Directory List (during MP3/WMA play)

The directory of an MP3/WMA disc are listed for quick search.

1 Call the MP3/WMA Menu



Menu»

2 Start the Directory List



Directory List

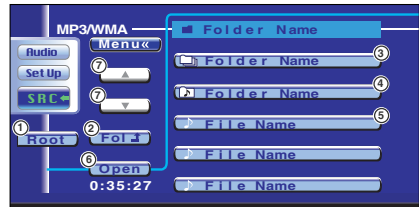

- ① Returns to the root directory.
- ② Displays the next higher level of hierarchy.
- ③ Displays a directory if the subdirectory has a directory. When you touch the directory, it opens.
- ④ Displays a directory if the subdirectory has files without a directory. When you touch the directory, it opens and songs in the directory are played.
- ⑤ Displays the MP3/WMA files. When you touch a file, its song is played back.
- ⑥ Plays the selected directory.
- ⑦ Scrolls the list.

3 Select a song



File Name

Display the desired song and touch the file display.

CD/MP3/WMA/Disc Changer Play Control

ID3/WMA TAG Display (during MP3/WMA play)

The ID3/WMA TAG information of MP3/WMA file is listed.

1 Call the MP3/WMA Menu



Menu»

2 Display the ID3/WMA TAG



Information



- ① Scrolls the list.

Disc Select (during play by disc changer)

The discs loaded on the disc changer are listed for quick disc selection.

1 Calls the Disc Changer Menu



Menu»

2 Call the Disc Select Menu



Disc Select



- ① Plays the displayed disc.
- ② Selects the Disc Name or Disc Text mode for text display.
- ③ Scrolls the list.
(It is not displayed when a disc changer having 6 or less discs is used.)

3 Select the desired disc



1. Disc Name

Touch the desired disc display.

Direct Search

Searches for a disc or a song when its number is entered.

During play on the built-in disc player

1 Select the Direct Search mode



DIRECT

The following items can be searched directly each time it is pressed.

CD: Track number, Total play time

MP3/WMA: Folder, File

2 Enter a disc or track number



0 — 9

3 Search

When searching for a song:



During play on an external in disc player or disc changer

1 Enter a disc or track number



0 — 9

2 Search

When searching for a song:



When searching for a disc:



The operation ends automatically if you do not operate within 10 seconds.

TV Control (with the optional accessory TV Tuner connected only)

Various control screens appear in the TV Source mode.

Displaying the TV Picture screen

Various control screens appear in the TV Source mode.



Selects the TV Pictures.

TV Picture screen

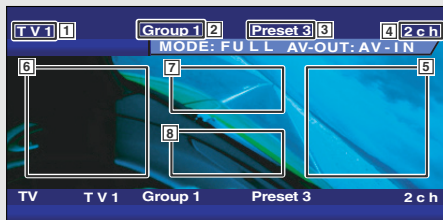

Displaying the Easy Control Panel

The Control Panel is displayed in a floating position of the TV picture.



Displaying the Easy Control Panel

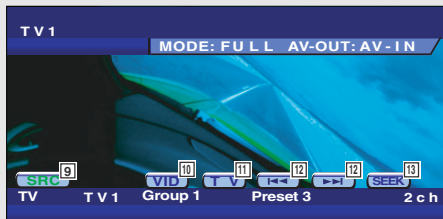

- 1 TV Band Number Display
- 2 TV Area Group Display (see page 64)
- 3 Memory Number Display
- 4 Channel Number Display
- 5 Channel Up Area
Increase the channel.
- 6 Channel Down Area
Decrease the channel.
- 7 Band/Video Switch Area
Switches to TV1, TV2, or VIDEO.
- 8 Information Display Button Area



- For receiver key operations, see <DDX7035/7045/7065 Basic Operations> (see page 8/10).
- The information display is cleared automatically after approximately 5 seconds. Also, the information can be displayed automatically when it is updated (see page 61).

- 9 Switches the source.
- 10 Switches to Video (VIDEO).
- 11 Switches the TV band (to TV1 or TV2).
- 12 Calls up a channel.
- 13 Switches the Seek mode.
(see page 38 for the <Seek Mode>)



The Easy Control Panel display is cleared when you touch the center of image display area.

Displaying the TV Control screen

You can tune in a TV station using various functions.



TV Control screen

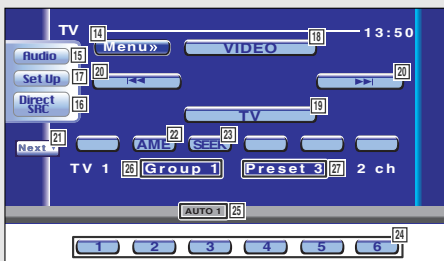

Displaying the TV Menu screen

You can select menu options using various functions.



TV Menu screen



14 Calls the TV Menu.

15 Calls the Sound Effects Menu. (see page 68)

16 Displays the Source Select screen. (see page 40)

17 Calls the Setup Menu. (see page 43)

18 Switches to VIDEO.

19 Switches to TV1 or TV2.

20 Select a channel.

Use the <Seek Mode> (see page 38) to change the channel tuning sequence.

21 Switches between **1** to **6** buttons and Function buttons to use.

22 Selects the Auto Memory mode. (see page 38 for the <Auto Memory>)

23 Switches the Seek mode. (see page 38 for the <Seek Mode>)

24 When **1** to **6** buttons appear, you can call up the channels from memory.

For memory of broadcasting stations, see <Auto Memory> (see page 38) or <Manual Memory> (see page 38).

25 **Seek Mode Indicator**

26 **TV Area Group Display** (see page 64)

27 **Memory Number Display**

28 Selects options from various function menus.

29 Returns to the TV Control screen.



The available functions vary depending on the model used (the tuner specifications and the broadcasting system that can be received).

TV Control

Seek Mode

Sets a TV station selection.



If **SEEK** is not shown, touch **Next**.

The mode is switched each time you touch the button.

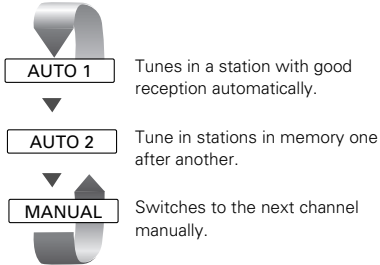

Auto Memory

Stores stations with good reception in memory automatically.

1 Select a band you wish to store in memory



2 Select the Auto Memory mode



If **AME** is not shown, touch **Next**.

3 Start Auto Memory



Touch or .

Auto Memory terminates when 6 stations are stored or when all stations are tuned in.

The operation ends automatically if you do not operate within 10 seconds.

Manual Memory

Stores the current receiving channel in memory.

1 Select a channel you wish to store in memory



2 Store in memory

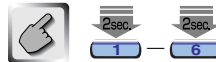

If **1** to **6** are not shown, touch **Next**.

Continue to touch until the memory number appears.

Preset Select

Lists and tunes in stations in memory one after the other.

1 Select a band you wish to call



2 Call the TV Menu



3 Call the Preset Select Menu

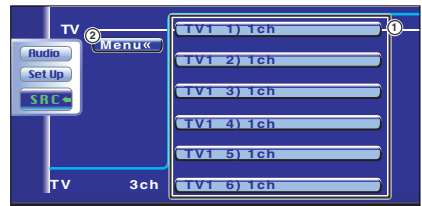

- 1 Tunes in the displayed station.
If the station name is displayed if it has been set.
- 2 Returns to the TV Menu.

Set Station Name

Names a station.

1 Select a station you wish to name



2 Call the TV Menu



3 Selects the Set Name mode



4 Enter a name

For character entry details, see <Character Entry> (see page 41).

5 Exit the Set Name mode



- You can store up to 20 stations in memory.
- You can set a station name only after you have applied the parking brake.

Source Select

Source Select

The source you wish to listen to can be selected quickly.

Displaying the Control screen



Press this key several times until the Control screen appears.

Control screen



Displaying the Source Select screen



Source Select screen

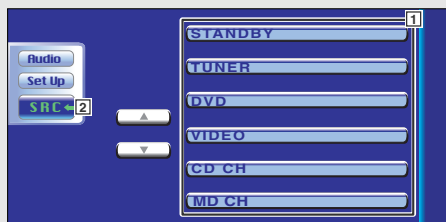

The Source Select screen can be displayed from the control screen of any source.

- 1 Select the source.
- 2 Returns to the Control screen previously displayed.

Mute Telephone

Mute Telephone

When the telephone is called, the system is paused automatically.

When the telephone is called...

The Phone Call ("CALL") screen appears, and system is paused.

Phone Call ("CALL") screen



If you continue to listen the source audio during phone call...



The system restarts to play while the phone call is continued.

When the call ends...

Hang up the phone.

The system restarts to play.

Character Entry

How To Use the Character Entry screen

When you select the Set Disc Name mode or others, the following screen appears for character entry.

Character Entry screen

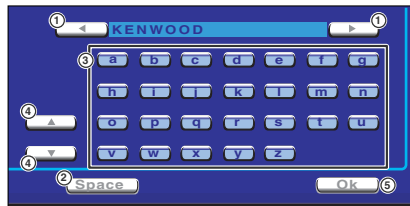

- ① Shifts the cursor.
- ② Enters a space.
If you erase a character, locate the cursor on it and touch this button.
- ③ Enters characters.
- ④ Displays respective character entry screens.
- ⑤ Exits the Character Entry mode and returns to the previous screen.



You can enter characters only after you have applied the parking brake.

Adjusting the Monitor Display Position and Quality

Adjusting the Monitor Display Position and Quality

You can adjust the position and picture quality of the monitor.

Displaying the Screen Control screen

You can adjust the picture quality using the following keys.



Screen Control screen

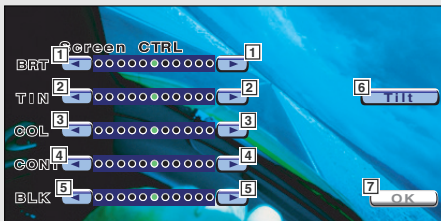

Displaying the Tilt Adjust screen

You can set the monitor tilt.



Tilt Adjust screen

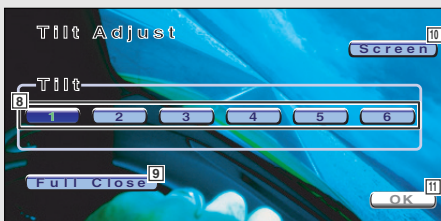

- 1 **Brightness Control**
- 2 **Tint Control**
Displayed for an NTSC system image on TV or Video.
- 3 **Color Control**
Displayed on the TV and Video screen only.
- 4 **Contrast Control**
- 5 **Black Level Adjustment**
- 6 Displays the Adjust Monitor Position screen.
(see <Displaying the Tilt Adjust screen>, page 42)
- 7 Returns to the previous screen.

 The Screen Control screen is displayed only when you have applied the parking brake.

- 8 **Monitor Tilt Adjustment**
- 9 The monitor fully closes.
- 10 Returns to the Screen Control screen.
- 11 Returns to the previous screen.

 If you turn the power off, the panel will close. However, if you turn the power back on, it will return to the adjusted tilt.

Setup Menu

Setup Menu

You can set up various receiver parameters.

Displaying the Control screen



Press this key several times until the Control screen appears.

Control screen



Displaying the Setup Menu screen



Setup Menu screen

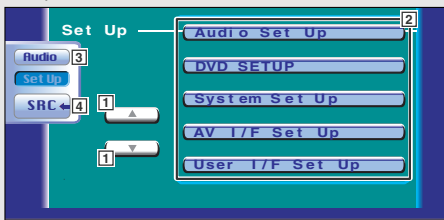

You can call the same Setup Menu for the Control screen of each source.

- 1 Scrolls the Setup Menu.
- 2 Calls each Setup Menu.
- 3 Calls the Sound Effects Menu. (see page 68)
- 4 Returns to the Control screen of the previous source.

Your setup on the <Sound Effects Menu> is adjusted automatically according to your <Audio Set Up> (see page 46) on the Setup menu. We recommend you to complete the <Audio Set Up> first, then set up the <Sound Effects Menu>.

The available functions vary depending on the model used (the tuner specifications and the broadcasting system that can be received).

Setup Menu

Audio Set Up

You can setup a speaker network, etc.

Displaying the Audio Set Up screen



Speaker setup screen

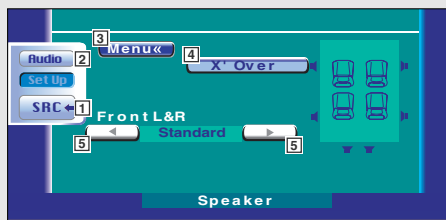

- 1 Returns to the Control screen of the previous source.
- 2 Calls the Sound Effects Menu. (see page 68)
- 3 Calls the Setup Menu.
- 4 Displays the X'Over setup screen. (see page 45)
- 5 Sets up the front speaker type to fine-tune for the optimal equalizer curves.
 - Standard: Setup for general diameter speakers
 - Narrow: Setup for small diameter speakers
 - Middle: Setup for small diameter woofer
 - Wide: Setup for large diameter woofer

Crossover Network Setup

You can set a crossover frequency of speakers.



X'Over (P 44 **4**)

X'Over setup screen

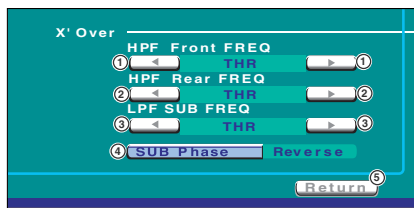

- ① Sets a Front High Pass Filter frequency.
You can select any of the following frequency.
Through, 40, 60, 80, 100, 120, 150, 180, 220 Hz
- ② Sets a Rear High Pass Filter frequency.
You can select any of the following frequency.
Through, 40, 60, 80, 100, 120, 150, 180, 220 Hz
- ③ Sets a Sub woofer Low Pass Filter frequency.
You can select any of the following frequency.
50, 80, 120, Through Hz
- ④ Sets the phase of subwoofer output.
The phase is reversed 180 degrees when set to "Reverse".
- ⑤ Returns to the Speaker setup screen.

Setup Menu

Audio Set Up (with the optional accessory DSP unit connected only)

You can set up more detailed settings by connecting the optional accessory DSP

Displaying the Car Type Set Up screen

If your vehicle type is selected, the Digital Time Alignment is set automatically (for timing adjustment of sound output for each channel) to have the highest surround effects.



Audio Set Up

Car Type Set Up screen

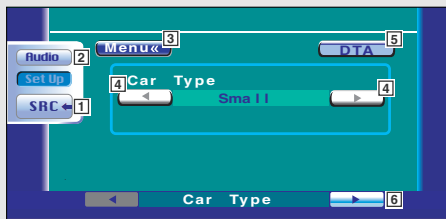

- 1 Returns to the Control screen of the previous source.
- 2 Calls the Sound Effects Menu. (see page 68)
- 3 Calls the Setup Menu.
- 4 Sets up the car type you use together with this unit.
- 5 Displays the DTA (Digital Time Alignment) Setup screen. (see page 48)
You can adjust the digital time alignment that was set automatically when you selected the car type.
- 6 Displays the Speaker Set Up screen.



You cannot set up "Car Type" when "Position" (see page 76) is "ALL".

unit.

Displaying the Speaker Set Up screen

When the speaker type and size are set, the speaker crossover network and equalizer curve are set automatically.



Speaker Set Up screen



Displaying the Channel Level screen

You can set the volume at each setup position.



Channel Level screen

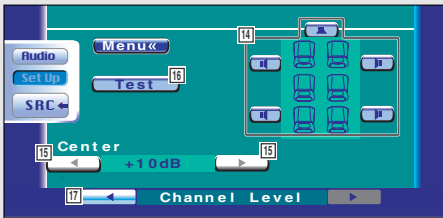

- 7 Displays the X'over (HPF) screen.
(See <High Pass Filter Setup>, page 50)
- 8 Display the X'over (LPF) screen.
(See <Low Pass Filter Setup>, page 50)
- 9 Sets up the front speaker type to fine-tune the optimal equalizer curves.
Standard: Setup for general diameter speakers
Narrow: Setup for small diameter speakers
Middle: Setup for small diameter woofer
Wide: Setup for large diameter woofer
- 10 Select the speakers for Multi-channel sounds.
"3/2": Center speaker, Front speaker, Rear speaker
"2/2": Front speaker, Rear speaker
"3/0": Center speaker, Front speaker
"2/0": Front speaker
- 11 Set the use or no use of Sub Woofer.
- 12 Displays the Channel Level Setup screen.
- 13 Displays the Car Type Set Up screen.



- "X'Over HPF" and "X'Over LPF" can be set only when "Sub Woofer" is set to "On".
- "Multi Channel" can be set only when "Dolby Pro Logic" (see page 75) is set to "On".

- 14 Selects a speaker to be set.
(see <Channel Level>, page 48)
- 15 Sets the speaker volume.
(see <Channel Level>, page 48)
- 16 Starts or stops test signal tone output for setup check.
- 17 Displays the Speaker Set Up screen.



- Your setup on the <Sound Effects Menu> is adjusted automatically to get the best sound effects according to the car type and speaker you have set on the <Audio Set Up> (see page 46). We recommend you to complete the <Audio Set Up> first, then set up the <Sound Effects Menu>.
You can fine-adjust the automatic set value by <DTA Setup> (see page 48) or <Parametric Equalizer> (see page 72).
- Stop the test signal tone if you have finished setting up the Channel Level. If you leave the test signal tone on, you may not be able to set up other settings.

Setup Menu

English

Channel Level

Set the volume at each setup position.

1 Select a speaker you wish to adjust



Channel Level setup screen



- ① Left front speaker
- ② Right front speaker
- ③ Left rear speaker
- ④ Right rear speaker
- ⑤ Center speaker

2 Adjust the volume



DTA Setup

Manually set the sound output timing of each channel.

1 Display the DTA Setup screen



DTA Setup screen

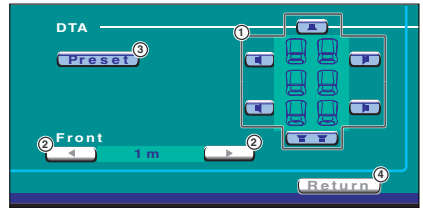

- ① Selects a speaker to be adjusted.
- ② Sets the distance between the selected speakers to adjust delay time.
- ③ Stores the adjusted status in memory or calls it from memory.
- ④ Returns to the Car Type Set Up screen.

2 Select a speaker you wish to adjust

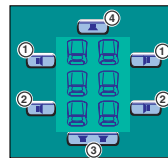

- ① Front speaker
- ② Rear speaker
- ③ Subwoofer
- ④ Center speaker

3 Set a delay time



The speakers are virtually moved to the desired distance.

When the values of center speaker and front speakers increase, they are virtually moved forward. When the values of rear speakers and subwoofer increase, they are virtually moved backward.

Store or call your setup into/from memory

To store your setup in memory



Continue to touch more than 2 seconds.

To call your setup from memory



Setup Menu

High Pass Filter Setup

You can manually set a High Pass Filter of Crossover Network.



X'Over HPF (P47 7)

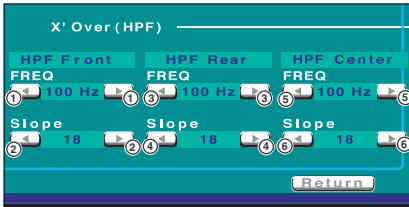

- ① Sets a crossover frequency of Front High Pass Filter.
- ② Sets a crossover slope of Front High Pass Filter.
- ③ Sets a crossover frequency of Rear High Pass Filter.
- ④ Sets a crossover slope of Rear High Pass Filter.
- ⑤ Sets a crossover frequency of Center High Pass Filter.
- ⑥ Sets a crossover slope of Center High Pass Filter.
- ⑦ Returns to the Speaker Set Up screen.



"HPF Center" can be set only when "Multi Channel" (see page 61) is set to "3/2" or "3/0".

Low Pass Filter Setup

You can manually set a Low Pass Filter of Crossover Network.



X'Over LPF (P47 8)

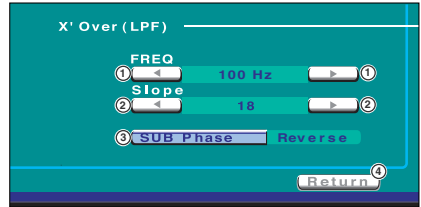

- ① Sets a crossover frequency of Low Pass Filter.
- ② Sets a crossover slope of Low Pass Filter.
- ③ Sets the phase of subwoofer output. The phase is reversed 180 degrees when set to "Reverse".
- ④ Returns to the Speaker Set Up screen.

Setup Menu

DVD Setup

You can set up the DVD play.

Displaying the DVD SETUP 1 screen



DVD SETUP

DVD SETUP 1 screen



- 1 Returns to the Control screen of the previous source.
- 2 Calls the Sound Effects Menu. (see page 68)
- 3 Calls the Setup Menu.
- 4 Selects a disc menu language.*1
(See <Language Setup>, page 54)
- 5 Selects a subtitle language.*1
(See <Language Setup>, page 54)
- 6 Selects an audio language.*1
(See <Language Setup>, page 54)
- 7 Sets the dynamic range.*2 (Wide)
The dynamic range is reduced by changing from "Wide" to "Normal" and from "Normal" to "Midnight".
You can easy to listen a small sound when the dynamic range is narrow.
This is effective only when you are using a Dolby Digital software.
- 8 Displays the DVD SETUP 2 screen.

If **DVD SETUP** is not shown, touch  or  to display it.

Displaying the DVD SETUP2 screen



DVD SETUP 2 screen



- 9] Sets an angle mark display. (On)
- 10] Selects the screen display mode. *1 (16:9)
 - *16:9*: Displays wide pictures.
 - *4:3 LB*: Displays wide pictures in the Letter Box format (having black stripes at the top and bottom of screen).
 - *4:3 PS*: Displays wide pictures in the Pan & Scan format (showing pictures cut at the right and left ends).
- 11] Displays the Parental Lock screen. *1 (OFF)
(See <Parental Level Setup>, page 55)
- 12] Keep "AUTO" to use.
- 13] Displays the DVD SETUP 1 screen.



*1 Disabled when a DVD is being played.

*2 Disabled when the Zone function is On.

Setup Menu

Language Setup

Select a language you use for the speech and menus.

1 Display the Language Setup screen

See <Displaying the DVD SETUP 1 screen> (see page 52) and select a language you wish to use.

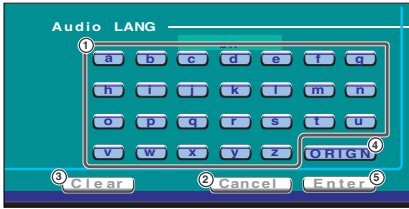

- ① Enters a language code.
- ② Cancels the language setup and returns to the DVD SETUP 1 screen.
- ③ Clears the language code.
- ④ Sets the original audio language.
(It appears during audio language setup.)
- ⑤ Sets the language and returns to the DVD SETUP 1 screen.
(It appears after you have entered a language code.)

2 Enter a language code

See the Language Code Table shown at right to select the desired language.

3 Set the language you use



Enter

Language Code Table

Abbreviation	Language	Abbreviation	Language
aa	Afar	lv	Latvian, Lettish
ab	Abkhazian	mg	Malagasy
af	Afrikaans	mi	Maori
am	Amharic	mk	Macedonian
ar	Arabic	ml	Malayalam
as	Assamese	mn	Mongolian
ay	Aymara	mo	Moldavian
az	Azerbaijani	mr	Marathi
ba	Bashkir	ms	Malay
be	Byelorussian	mt	Maltese
bg	Bulgarian	my	Burmese
bh	Bihari	na	Nauru
bi	Bislama	ne	Nepali
bn	Bengali, Bangla	nl	Dutch
bo	Tibetan	no	Norwegian
br	Breton	oc	Occitan
ca	Catalan	om	(Afan) Oromo
co	Corsican	or	Oriya
cs	Czech	pa	Punjabi
cy	Welsh	pl	Polish
da	Danish	ps	Pashto, Pushto
de	German	pt	Portuguese
dz	Bhutani	qu	Quechua
el	Greek	rm	Rhaeto-Romance
en	English	rn	Kirundi
eo	Esperanto	ro	Romanian
es	Spanish	ru	Russian
et	Estonian	rw	Kinyarwanda
eu	Basque	sa	Sanskrit
fa	Persian	sd	Sindhi
fi	Finnish	sg	Sango
fj	Fiji	sh	Serbo-Croatian
fo	Faroese	si	Singhalese
fr	French	sk	Slovak
fy	Frisian	sl	Slovenian
ga	Irish	sm	Samoan
gd	Scots Gaelic	sn	Shona
gl	Galician	so	Somali
gn	Guarani	sq	Albanian
gu	Gujarati	sr	Serbian
ha	Hausa	ss	Siswati
hi	Hindi	st	Sesotho
hr	Croatian	su	Sundanese
hu	Hungarian	sv	Swedish
hy	Armenian	sw	Swahili
ia	Interlingua	ta	Tamil
ie	Interlingue	te	Telugu
ik	Inupiak	tg	Tajik
in	Indonesian	th	Thai
is	Icelandic	ti	Tigrinya
it	Italian	tk	Turkmen
iw	Hebrew	tl	Tagalog
ja	Japanese	tn	Setswana
ji	Yiddish	to	Tongan
jw	Javanese	tr	Turkish
ka	Georgian	ts	Tsonga
kk	Kazakh	tt	Tatar
kl	Greenlandic	tw	Twi
km	Cambodian	uk	Ukrainian
kn	Kannada	ur	Urdu
ko	Korean	uz	Uzbek
ks	Kashmiri	vi	Vietnamese
ku	Kurdish	vo	Volapuk
ky	Kirghiz	wo	Wolof
la	Latin	xh	Xhosa
ln	Lingala	yo	Yoruba
lo	Laotian	zh	Chinese
lt	Lithuanian	zu	Zulu

Parental Level Setup

Sets a parental level.

1 Display the Parental Level code number screen



Set (P53 11)

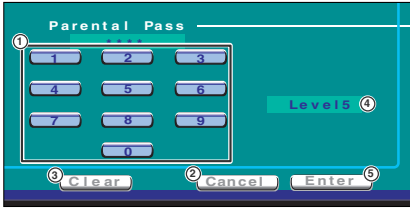

- 1 Enters a code number.
- 2 Cancels the current setup and returns to the DVD SETUP 2 screen.
- 3 Clears the code number.
- 4 Displays the present parental lock level.
- 5 Determines the code number and displays the Parental Level Setup screen.

2 Enter the code number



0 — **9**



- The number you enter first is set as your code number.
- You can clear the password by pressing the Reset button.

3 Display the Parental Level Setup screen



Enter

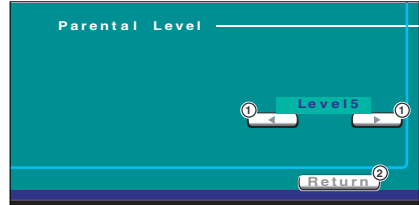

- 1 Sets a parental level.
- 2 Returns to the DVD SETUP 2 screen.

4 Set a parental level



← **→**

5 Enter the parental level setup



Return



- If a disc has a higher parental lock level, the audience needs to enter the code number.
- The parental lock level varies depending on a loaded disc.
- If a disc has no parental lock, any audience can play it back even when you have set the parental lock.

Setup Menu

System Setup

You can set up the system parameters.

Displaying the System Set Up 1 screen



System Set Up 1 screen

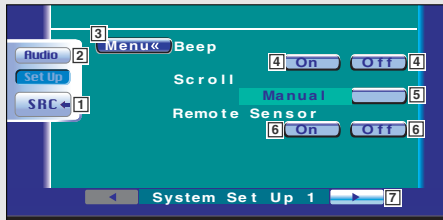

- 1 Returns to the Control screen of the previous source.
- 2 Calls the Sound Effects Menu. (see page 68)
- 3 Calls the Setup Menu.
- 4 Turns the key touch tone On or Off. (☑ On)
- 5 Allows scrolling of text display on the Source Control screen. (☑ Auto)
"Auto": Scrolls the screen automatically.
"Manual": Allows you to scroll the screen manually.
- 6 Selects a remote control signal. (☑ On)
If you turn it "Off", your operation from the remote controller is rejected when you are in the TV mode.
- 7 Displays the System Set Up 2 screen.

If **System Set Up** is not shown, touch  or  to display it.

Displaying the System Set Up 2 screen



System Set Up 2 screen

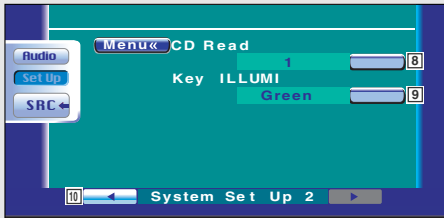

8 Sets a music CD playback. ( 1)

"1": Automatically recognizes and plays back an MP3/WMA disc, a DVD or a music CD.

"2": Forcibly plays back a disc as a music CD.

Select "2" if you wish to play a music CD having a special format or if you cannot play a disc in the "1" position.



- You cannot play an MP3/WMA/VCD disc in the "2" position. Also, you may not play some music CDs in the "2" position.

- Your setup is disabled when the disc is being played.

9 Selects an illumination color of receiver keys.

( **Green**)

"Green": Green

"Red": Red

10 Displays the System Set Up 1 screen.

Setup Menu

AV Interface

You can set audio and visual (AV) interface parameters.







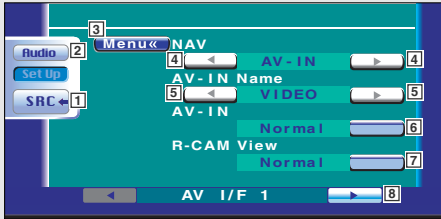

Displaying the AV I/F 1 screen



AV I/F Set Up

AV I/F 1 screen



- 1 Returns to the Control screen of the previous source.
- 2 Calls the Sound Effects Menu. (see page 68)
- 3 Calls the Setup Menu.
- 4 Selects a navigation system connection. ( RGB)
"RGB": Allows the Kenwood's Navigation System to connect via its interface cable.
"AV-IN": Allows a third-party navigation system to connect via the AV INPUT port.
"OFF": Must be used if no navigation system is connected. (The navigation display is cancelled when the AV source is switched.)
- 5 Sets a name to be displayed when you select a system that is connected via the AV INPUT port. ( VIDEO)
 If you have set the navigation system connection to "AV-IN", the display is fixed to "NAV".
- 6 Sets an image display of the system that is connected via the AV INPUT port. ( Normal)
"Normal": When the image source is switched, an image entered via the AV INPUT port is displayed.
"AUTO": When an image signal is entered via the AV INPUT port, this image is displayed.
- 7 Sets how the rear camera image is displayed.
"Reverse": Displays with left and right reversed.
"Normal": Displays as it is.
 "R-CAM View" can be set only when "AV-IN Name" is set to "R-CAM".
- 8 Displays the AV I/F 2 screen.
 If **AV I/F Set Up** is not shown, touch  or  to display it.

Displaying the AV I/F 2 screen



AV I/F 2 screen

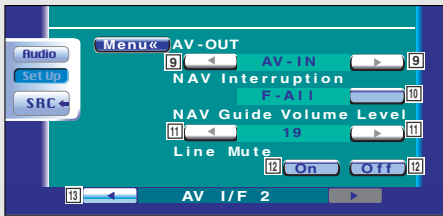

- 9 Selects an AV source to be output at the AV OUTPUT port. (AV-IN)



If you select DVD as a source when the optional accessory DSP unit is connected, no DVD sound is output to the AV output port.

- 10 Selects speakers used for voice guidance of the navigation system. (F-Left)

"F-Left": Uses the front left side speaker for voice guidance.

"F-Right": Uses the front right side speaker for voice guidance.

"F-All": Uses both front speakers for voice guidance.

- 11 Adjusts the volume for voice guidance of the navigation system. (19)

- 12 Mutes the volume during voice guidance of the navigation system. (On)

When turned "On", the volume level drops for voice guidance.

- 13 Displays the AV I/F 1 screen.

Setup Menu

User Interface

You can set up user interface (IF) parameters.

Displaying the User I/F 1 screen



User I/F Set Up

User I/F 1 screen

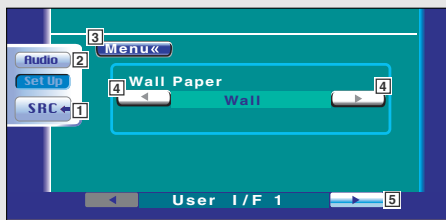

- 1 Returns to the Control screen of the previous source.
- 2 Calls the Sound Effects Menu. (see page 68)
- 3 Calls the Setup Menu.
- 4 Switches the wall paper.
- 5 Displays the User I/F 2 screen.



If **User I/F Set Up** is not shown, touch  or  to display it.

Displaying the User I/F 2 screen



User I/F 2 screen

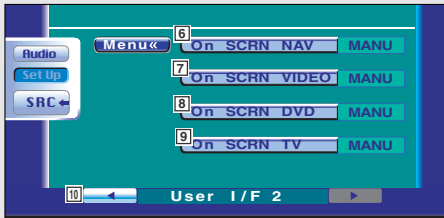

- 6] Sets an on-screen display of the navigation screen.
(**Auto**)
If you set to "Auto", an information is displayed for 5 seconds when updated.
- 7] Sets an on-screen display of the video playback screen. (**Auto**)
If you set to "Auto", an information is displayed for 5 seconds when updated.
- 8] Sets an on-screen display of the DVD playback screen. (**MANU**)
If you set to "Auto", an information is displayed for 5 seconds when updated.
- 9] Sets an on-screen display of the TV screen.
(**Auto**) (optional accessory) (with the optional accessory TV tuner connected only)
If you set to "Auto", an information is displayed for 5 seconds when updated.
- 10] Displays the User I/F 1 screen.

Setup Menu

Touch Panel Adjust

You can adjust the touch panel operations.

1 Display the Touch Panel Adjust screen



If **Touch Adjust** is not shown, touch or to display it.

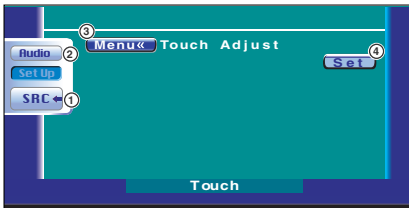

- ① Returns to the Control screen of the previous source.
- ② Calls the Sound Effects Menu. (see page 68)
- ③ Calls the Setup Menu.
- ④ Allows you to start touch panel adjustment.

2 Start to adjust the touch panel

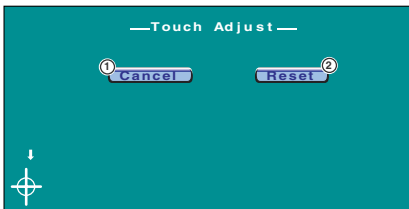

- ① Cancels the adjustment and returns to the Touch Panel Adjust screen.
- ② Resets to the initial status.

3 Adjustment



Touch the center of left lower and right upper when requested.

Clock

Adjusts the clock time

1 Display the Clock Screen



If **Clock Adjust** is not shown, touch or to display it.

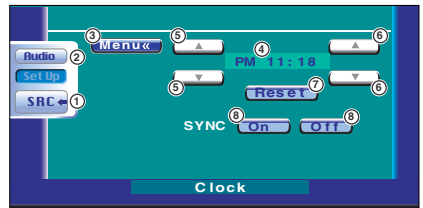

- ① Returns to the Control screen of the previous source.
- ② Calls the Sound Effects Menu. (see page 68)
- ③ Calls the Setup Menu.
- ④ Clock time display.
- ⑤ Adjusts hours.
- ⑥ Adjusts minutes.
- ⑦ Sets "00" minute.
Setup examples: 3:00~3:29 → 3:00
3:30~3:59 → 4:00
- ⑧ Sets the clock time in synchronous with the time data sent from the RDS station. <Function of DDX7035> (On)
When turned "On", the synchronous mode starts and the clock cannot be adjusted manually.

2 Adjust the clock time



Security Code Setup

You can set a security code to protect your receiver system against theft.



When the Security Code function is activated, it can't be released.

Note, your Security Code is the 4 digit number entered in your "Car Audio Passport" in this package.

1 Display the Security Code Setup screen



If **Security Set Up** is not shown, touch or to display it.

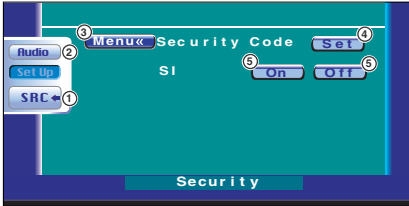

- ① Returns to the Control screen of the previous source.
- ② Calls the Sound Effects Menu. (see page 68)
- ③ Calls the Setup Menu.
- ④ Allows you to start security code registration.
- ⑤ Turns the SI function On or Off.
If turned "On", the burglar alarm lamp flashes when the vehicle ignition is off.

If you have already completed the code registration, the **Set** is not displayed.

2 Start the security code registration

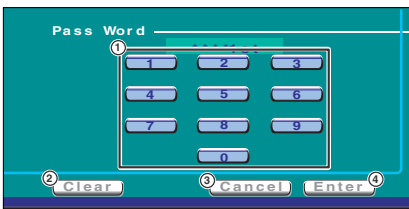

- ① Enters a security code.
- ② Clears your entry.
- ③ Cancels the registration and returns to the Security Code Setup screen.
- ④ Enters the security code.

3 Enter a security code



Input a four-digit number.

4 Register your security code



5 Reenter the security code

Reenter the same security code as that you have entered in Step 3 for confirmation.

If you enter a different security code, the screen returns to Step 3 (for the first code entry).

6 Register the security code again



Your security code has been registered.

If you press the Reset button or if you disconnect your Receiver from the battery after the code registration, you need to enter the registered security code. See below for details.

If you have pressed the Reset button or if you have disconnected the Receiver from battery...

1 Enter the correct security code



You must enter the same security code as that you have entered in Step 3 above.

2 Enter the security code



Now, you can use your Receiver.

If you enter an incorrect security code, you cannot use your Receiver for a while.

Incorrect entry count **Receiver inoperable time**

1	—
2	5 minutes
3	1 hour
4 or more	24 hours

Setup Menu

TV Setup (with the optional accessory TV Tuner connected only)

The TV signal receiving areas can be set.

Displaying the TV1 Area Set Up screen



TV1 Area Set Up screen



- 1 Returns to the Control screen of the previous source.
- 2 Calls the Sound Effects Menu. (see page 68)
- 3 Calls the Setup Menu.
- 4 Sets the present TV1 receiving area.
- 5 Displays the TV2 Area Set Up screen.

If **TV Set Up** is not shown, touch or to display it.



Displaying the TV2 Area Set Up screen



TV2 Area Set Up screen

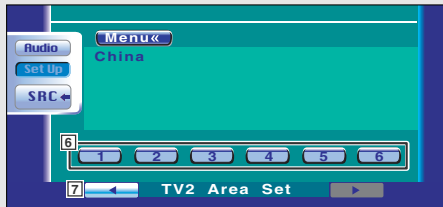

- 6 Sets the present TV2 receiving area.
- 7 Displays the TV1 Area Set Up screen.

RDS Setup <Function of DDX7035>

The related RDS parameters can be set.

Displaying the RDS Set Up 1 screen



RDS Set Up

RDS Set Up1 screen

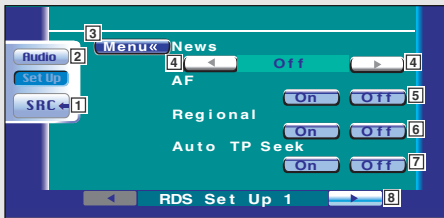

- 1 Returns to the Control screen of the previous source.
- 2 Calls the Sound Effects Menu. (see page 68)
- 3 Calls the Setup Menu.
- 4 Sets a news bulletin interrupt time.
- 5 Turns the Alternative Frequency function On or Off. (☑ On)
- 6 Turns the Region Restriction function On or Off. (☑ On)
- 7 Turns the Auto TP Seek function On or Off. (☑ On)
- 8 Displays the RDS Set Up 2 screen.



If **RDS Set Up** is not shown, touch  or  to display it.



Displaying the RDS Set Up 2 screen



RDS Set Up2 screen



- 9 Selects a display language for the PTY function.
- 10 Displays the RDS Set Up 1 screen.

Setup Menu

AMP Control (with the optional accessory LX Power AMP connected only)

Sets the power amp connected via the LX bus.

Displaying the AMP Control screen



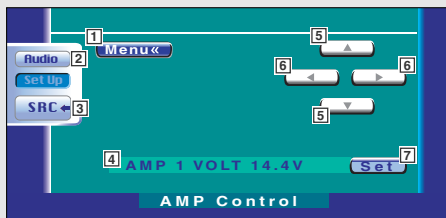

AMP Ctrl

AMP Control screen



- 1 Calls the Setup Menu.
- 2 Calls the Sound Effects Menu. (see page 68)
- 3 Returns to the Control screen of the previous source.
- 4 Setup option and value display
- 5 Select a setup option.
- 6 Selects a set value.
- 7 Enters the set value.



- If **AMP Ctrl** is not shown, touch  or  to display it.
- For the model name of amp you can control from the system, see the amp's catalog.
- For the options and values you can change and for the amp's operation when changed, see the amp's instruction manual.

Sound Effects Menu

Sound Effects Menu

You can set up the receiver sound effects.

Displaying the Control screen



Control screen



Displaying the Sound Effects Menu screen



Sound Effects screen

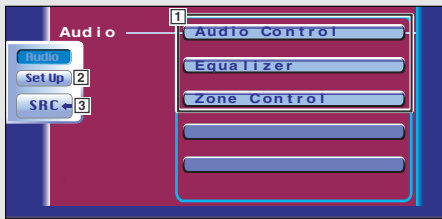

 You can display the same Sound Effects Menu on the Control screen of any source.

- 1 Calls the Sound Effects Menu.
- 2 Calls the Setup Menu. (see page 43)
- 3 Returns to the Control screen of the previous source.

-  Your setup on the <Sound Effects Menu> is adjusted automatically according to your <Audio Set Up> (see page 46) on the Setup menu. We recommend you to complete the <Audio Set Up> first, then set up the <Sound Effects Menu>.
- Displayed items vary depending on the optional accessory connected.

Audio Control

You can adjust the front and rear and right and left audio balance.

Displaying the Audio Control 1 screen



Audio Control

Audio Control 1 screen

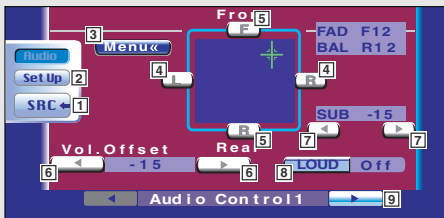



Displaying the Audio Control 2 screen

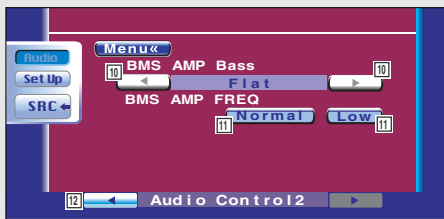

Audio Control 2 screen



- 1 Returns to the Control screen of the previous source.
- 2 Calls the Setup Menu. (see page 43)
- 3 Calls the Sound Effects Menu.
- 4 Adjusts the right and left volume balance.
- 5 Adjusts the front and rear volume balance.
- 6 Adjusts the volume of the present source based on the difference level of original volume.
 If you have increased the volume first, then reduced it using the 'Vol. Offset', the big sound may suddenly be generated when you switch to another source.
- 7 Adjusts the subwoofer volume.
- 8 Turns the Loudness control function On or Off. (Does not appear when the optional accessory DSP unit is connected.)
If turned "On", high and low tones are automatically enhanced during low volume. ( On)
- 9 Displays the Audio Control 2 screen.

- 10 Adjusts the bass boost of the B.M.S power amplifier (optional accessory).
 You may not set some models of power amp boost to "+18". See the catalog or instruction manual of power amplifier.
- 11 Set the center frequency of bass boost you have set for the "AMP Bass".
If you set it to "Low", the center frequency is dropped for 20 to 30%.
- 12 Displays the Audio Control 1 screen.

Sound Effects Menu

Equalizer

You can set up the equalizer.

Displaying the Equalizer screen



Equalizer screen

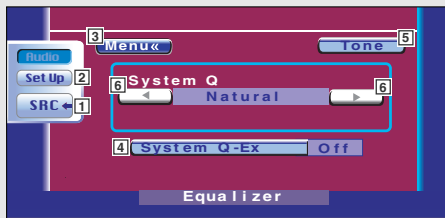

- 1 Returns to the Control screen of the previous source.
- 2 Calls the Setup Menu. (see page 43)
- 3 Calls the Sound Effects Menu.
- 4 Select the adjustment items for the Tone Curve setup. (Does not appear when the optional accessory DSP unit is connected.)
If you set it to "Off", only "Level" can be set up for Tone Curve.
- 5 **Tone** : Displays the Tone curve setup screen. (see page 71)
P-EQ : Displays the Parametric Equalizer screen. (see <Parametric Equalizer> page 72) (with the optional accessory DSP unit connected)
You can adjust the value set for the Equalizer Curve Type.
- 6 Selects an equalizer curve type.
You can select any of the following equalizer curves.
System Q
 - "Natural"
 - "Rock"
 - "Pops"
 - "Easy"
 - "Top 40"
 - "Jazz"
 - "User" (when the tone curve (page 71) is set up)**KBS** (with the optional accessory DSP unit connected)
 - "Natural"
 - "Top 40"
 - "Rock"
 - "Dance"
 - "Vocal"
 - "Classic"
 - "User" (when Parametric Equalizer (page 72) is set up)

Tone curve setup

You can set a Tone curve.

1 Display the Tone setup screen



Tone setup screen



- 1 Bass adjustment items are displayed.
- 2 Middle adjustment items are displayed.
- 3 Treble adjustment items are displayed.
- 4 Bass DC Extend settings
If turned "On", it extends the bass center frequency to the low register by approximately 20%.
- 5 Returns to the Equalizer screen.

Tone curve can be set for each source.

2 Select a frequency band you wish to adjust



You can adjust the following frequency bands.

Bass: 60, 70, 80, 100/150 (When "Q Factor" is "2.00") Hz

Middle: 500, 1k, 1.5k, 2k Hz

Treble: 10k, 12.5k, 15k, 17.5k Hz

3 Set a center frequency



4 Set a level



5 Set a Q factor

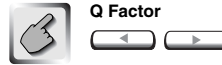

You can set it up only when Bass or Middle is adjusted.

6 Close the Tone setup screen



Sound Effects Menu

Parametric Equalizer

You can Manually set the equalizer curve by adjusting the center frequency, gain and Q value. (with the optional accessory DSP unit connected)

1 Display the Parametric Equalizer screen



- ①②③④ Select a band to be adjusted.
- ⑤ Sets a frequency.
- ⑥ Sets a gain level.
- ⑦ Sets a Q value.
- ⑧ Store the present equalizer curve in memory, or calls it from memory.
- ⑨ Exits the Parametric Equalizer setup and returns to the Equalizer screen.

2 Select a frequency band you wish to adjust



You can adjust the following frequency bands.

- ① 60, 80, 100, 120, 160, 200, 250 Hz
- ② 315, 400, 500, 630, 800, 1k Hz
- ③ 1.25k, 1.6k, 2k, 2.5k, 3.15k, 4k Hz
- ④ 5k, 6.3k, 8k, 10k, 12.5k, 16k Hz

3 Set a center frequency



4 Set a gain



5 Set a Q value



Store or call the equalizer curve into/from memory

To store the equalizer curve in memory:

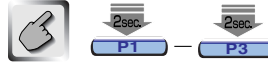

Continue to touch **P1** to **P3** more than 2 seconds.

To call the equalizer curve from memory:



Touch **P1** to **P3** of the equalizer curve you wish to call from memory.

When you call an equalizer curve, its type is shown as "User".

6 Close the Parametric Equalizer screen



Sound Effects Menu

Zone Control

You can set the front and rear audio source.

Displaying the Zone Control screen



Zone Control screen (when the Zone function is On)

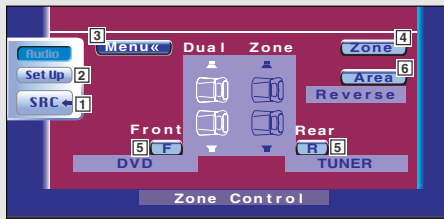

- 1 Returns to the Control screen of the previous source.
- 2 Calls the Setup Menu. (see page 43)
- 3 Calls the Sound Effects Menu.
- 4 Turns the Zone Function (that sets different source sounds for front and rear speakers) On or Off. When turned On, **F** and **R** are shown.
- 5 Sets the front and rear audio source separately. (This button appears when the Zone function is On.)

When the rear speaker sound is switched, the audio source that is output at the AV OUTPUT terminal is also switched to the same source. However, if you have set the "Area" to "Reverse", the audio source that is output at the AV OUTPUT terminal is switched depending on the front sound source.

- 6 Switches the front and rear audio sources. (This button appears when the Zone function is On.) Use "Reverse" to change over the front and rear audio sources.

If the zone function is turned on, the **F** / **R** button appears on each source control screen, with which you can adjust the volume balance between the front and rear sources.



Digital Effect (with the optional accessory DSP unit connected only)

You can set up the Digital Effect.

Displaying the Digital Effect screen



Digital Effect

Digital Effect screen

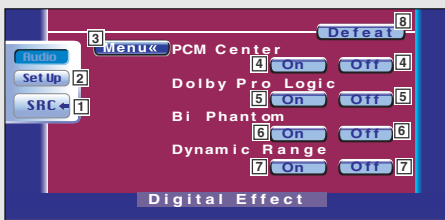

- 1 Returns to the Control screen of the previous source.
- 2 Calls the Setup Menu. (see page 43)
- 3 Calls the Sound Effects Menu.
- 4 **PCM Center**
If you set to "On", a sound is output from the center speaker.
- 5 Turns the Dolby Pro Logic function on or off.
- 6 Turns the Bi Phantom function on or off.
If you set to "On", the signal of the center channel is controlled so that it can be exactly positioned.
- 7 Sets up the dynamic range when the Dolby Digital sound is used.
If you set to "On", it compresses the dynamic range to control loud sounds.
- 8 The DSP unit settings return to default.



- The Dolby Pro Logic and PCM Center functions are effective when the 2ch PCM signal is used.
- You cannot set up "Bi Phantom" when "Dolby Pro Logic" is "Off".
- You cannot set up "PCM Center" when "Dolby Pro Logic" is "On".

Sound Effects Menu

Position (with the optional accessory DSP unit connected only)

You can adjust the sound effects according to your listening position.

Displaying the Position screen



Position screen

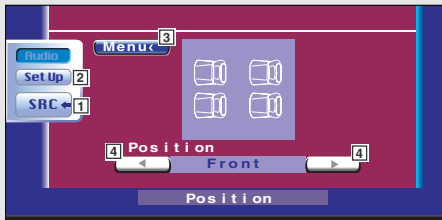

- 1 Returns to the Control screen of the previous source.
- 2 Calls the Setup Menu. (see page 43)
- 3 Calls the Sound Effects Menu.
- 4 Sets a listening position.
You can select any of "Front R" (Right front), "Front L" (Left front), "Front" (All front), "Rear" (All rear), and "ALL" (All) positions.



The final distance is adjusted to the total of Car Type Set Up value (see page 46) and Position Setup (both Position and Position Fine Control) value.

Hands-Free Unit Control

GSM control

You can call the following control screens if the GSM is connected to the system.

Displaying the Control screen



Or the telephone is called.

GSM Control screen

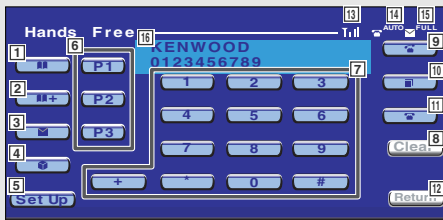

- 1 Displays the Search for Phone Book screen.
(See the <Calling by Phone Book>, page 80)
- 2 Adds a number to the Phone Book.
(See the <Addition to Phone Book>, page 81)
- 3 Displays the Create a Mail screen.
(See the <Creating an SMS (Short Message Service) messages>, page 84)
- 4 Displays the SMS list.
(See the <Reading SMS (Short Message Service) messages>, page 84)
- 5 Displays the Hands-Free Call Setup screen.
(See the <Hands Free Setup>, page 83)
- 6 Enter three phone numbers for quick dialing.
(See the <Quick Dialing>, page 83)
- 7 Enters a phone number.
(See the <When dialing>, page 79)
- 8 Clears the entered phone number.
All numbers you have entered are cleared if the button is pressed more than 1 second.
- 9 Starts the hands-free phone call.
- 10 Displays the previously called phone number.
- 11 Ends the hands-free phone call.
- 12 Returns to the previous screen.
- 13 Displays the radio wave intensity
- 14 Displays the present Auto Response status
When Auto Response is on: AUTO
When Auto Response is off:
- 15 Indicates the SMS registration availability
- 16 Displays the calling and called phone numbers
If you have registered a phone number in the Phone Book, the destination person name is displayed.



For details on the hands-free phone calls, see the Instruction Manual of KCA-HF521 GSM Hands-Free Unit (optional).

When called

When you are called, you can use the hands-free phone.

1 Respond to a phone call



When the telephone is called, the GSM Control screen appears automatically.

2 Terminate the phone call



The previous screen reappears.

When dialing

Originate a call by entering a phone number.

1 Enter a phone number



2 Originate a call



You can start talking when the destination responds.

3 Terminate the phone call



The previous screen reappears.

Hands-Free Unit Control

Calling by Phone Book

You can call a person using his/her phone number that you have registered in the Phone Book.

1 Display the Search for Phone Book screen



The Initial Input screen appears.

Initial Input screen



- 1 Switches the character type.
- 2 Scrolls the character array display.
- 3 Displays the Phone Book beginning with the name whose first character you have touched.
- 4 Returns to the GSM Control screen.

2 Select the initial character of a person name in memory



The Phone Book List screen appears.

Phone Book List screen

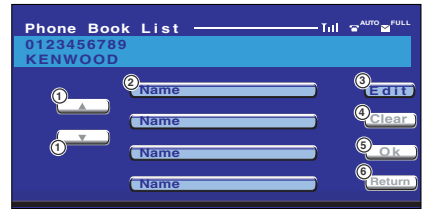

- 1 Scrolls the list.
- 2 Enters the destination (called party) name.
- 3 Displays the destination data edit screen. (See the <Editing the Phone Book>, page 82)
- 4 Clears the destination if this button is touched more than 2 seconds.
- 5 Enters the destination data and returns to the GSM Control screen.
- 6 Returns to the GSM Control screen.

3 Select a destination you wish to call



4 Select a destination you wish to call



The GSM Control screen appears again. The selected destination data is displayed.

5 Originate a call



You can start talking when the destination responds.

6 Terminate the phone call



The previous screen reappears.

Addition to Phone Book

You can add a phone number to the Phone Book.

1 Enter a phone number you wish to register



2 Start phone number registration



Device Select screen

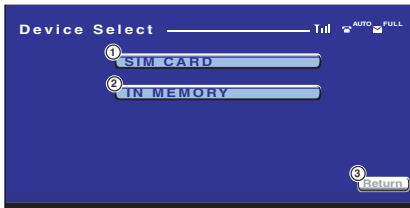

- 1 Registers a phone number in the SIM card.
- 2 Registers a phone number in the GSM system itself.
- 3 Returns to the GSM Control screen.

3 Select a memory device in which you wish to register phone data



When you select the device, the Name Edit screen appears.

Name Edit Screen



- 1 Shifts the cursor.
- 2 Switches the character type. The digits, accent and extended code characters, and alphabets are switched each time it is pressed.
- 3 Scrolls the keyboard display.
- 4 Enters a character.
- 5 Clears the character. All entry characters are cleared if this key is touched more than 1 second.
- 6 Enters the entry characters.
- 7 Returns to the Device Select screen.
- 8 Enters a space.



The extended code characters are displayed only when a cellular phone supporting the GSM alphabets is connected. Each of extended code characters (^, {, }, \, |,], , l, €) occupies a two-character memory space when registered.

4 Enter a name



5 Register the name



The name has been registered.

Hands-Free Unit Control

Editing the Phone Book

You can edit data you have registered in the Phone Book.

1 Select an item you wish to edit



See the <Calling by Phone Book> (see page 80) and select an item you wish to edit on the Phone Book List screen.

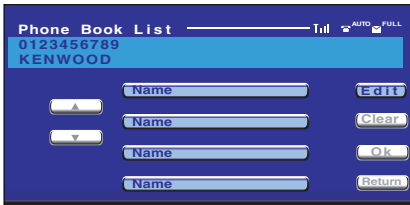

2 Start editing



The Edit Phone Number screen appears.

Edit Phone Number ("TEL Number Edit") screen

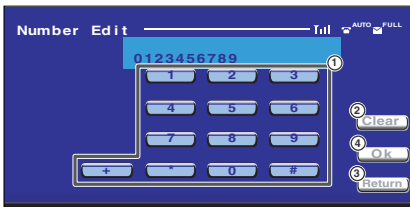

- 1 Enters a phone number.
- 2 Clears the input phone number.
All entry numbers are cleared if this key is touched more than 1 second.
- 3 Returns to the Phone Book List screen.
- 4 Enters the phone number.

3 Enter a phone number

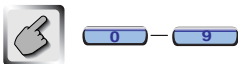

4 Register the phone number



The phone number is registered, the Edit Name ("Name Edit") screen appears.

Edit Name ("Name Edit") screen



- 1 Shifts the cursor.
- 2 Switches the character type.
The digits, accent and extended code characters, and alphabets are switched each time it is pressed.
- 3 Scrolls the keyboard display.
- 4 Enters a character.
- 5 Clears the character.
All entry characters are cleared if this key is touched more than 1 second.
- 6 Enters the entry characters.
- 7 Returns to the Edit Phone Number ("TEL Number Edit") screen.
- 8 Enters a space.

The extended code characters are displayed only when a cellular phone supporting the GSM alphabets is connected.
Each of extended code characters (^, !,), \, |, ., , l, €) occupies a two-character memory space when registered.

5 Enter a name



6 Register the phone number



The editing completes and the Phone Book data is updated.

Quick Dialing

You can register up to 3 phone numbers for quick dialing.

To register a phone number:

1 Display a phone number you wish to register

See the <Calling by Phone Book> (see page 80) and <When dialing> (see page 79).

2 Register the phone number



Continue to touch more than 2 seconds.

To call a phone number from memory:



Only a phone number can be registered for Quick Dialing. Therefore, the destination subscriber name and others are not displayed during dialing.

Hand Free Setup

The hands-free system can be set as follows.

Display the SMS SetUp screen



Hands Free Set Up screen

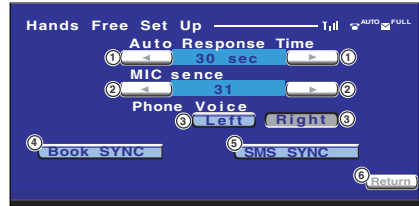

- ① Sets an automatic response time after call termination.
- ② Adjusts the microphone sensitivity.
- ③ Sets a ringing tone output position.
"Left": Outputs the tone from the front left-hand side speaker.
"Right": Outputs the tone from the front right-hand side speaker.
- ④ Synchronizes the GSM with the Phone Book of optional KCA-HF521 unit.
- ⑤ Synchronizes the GSM with the SMS of optional KCA-HF521 unit.
- ⑥ Returns to the GSM Control screen.

The "Phone Voice" of both "Left" and "Right" can be turned On at the same time. But they cannot be turned Off at the same time.

Hands-Free Unit Control

Reading the SMS (Short Message Service) messages

You can display messages received by the SMS.

1 Display the BOX Message List screen



BOX Message List screen

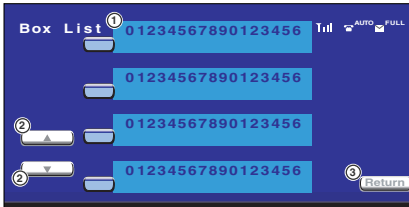

- 1 Displays messages.
- 2 Scrolls the message list.
- 3 Returns to the GSM Control screen.

2 Select a message you wish to display



The message is displayed on the Box Message screen.

BOX Message screen

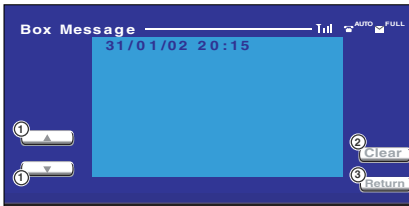

- 1 Scrolls for a single message.
- 2 Clears the message if this button is touched more than 2 seconds.
- 3 Returns to the BOX Message List screen.

Creating an SMS (Short Message Service) message

You can create a message to be sent by the SMS.

1 Enter the destination number where you wish to send an SMS message



2 Display the SMS Message Input screen



SMS Message Input screen



- 1 Shifts the cursor.
- 2 Switches the character type.
The digits, accent and extended code characters, and alphabets are switched each time it is pressed.
- 3 Enters a space.
- 4 Scrolls the keyboard display.
- 5 Enters a character.
- 6 Clears the character.
All entry characters are cleared if this key is touched more than 1 second.
- 7 Sends the created message.
- 8 Returns to the GSM Control screen.

3 Create a message



4 Send the message



Returns to the GSM Control screen.



The extended code characters are displayed only when a cellular phone supporting the GSM alphabets is connected.

Each of extended code characters (^, {, }, \, |,], ~, !, €) occupies a two-character memory space when registered.

Glossary

DVD: Digital Versatile Disc

A type of disc which contains recording of audio/video packaged media with high video and audio quality, such as a movie, featuring large recording capacity and digital signal processing capability.

VCD: VIDEO CD

A type of CD which contains the recording of moving images. It compresses image information by about 1/120 and audio information by about 1/6 and accommodates up to 74 minutes of recording in a disc with the same diameter as ordinary music CD of 12 cm.

Some VCDs do not have the P.B.C. compatibility and are capable of playback only, while some are P.B.C.-compatible and are capable of various special playback control operations. This player can play both of these VCDs.

MPEG: Moving Picture Expert Group (DVD, VCD)

This is an international standard for digital video and audio compression and decompression in media.

Dolby Digital

This is a digital audio compression technology developed by Dolby Laboratories. It is compatible with 5.1-channel surround audio as well as normal stereo (2-channel) audio and can accommodate a large amount of audio data efficiently in a disc.

DTS

Name of a digital surround system developed by Digital Theater Systems, Inc.

Top menu/menu (DVD)

Some DVDs display more than one title in a screen. This screen is referred to as the top menu.

The menu is the item display (menu screen) for use in setting operations. The menu can be recalled any time during playback to perform settings according to the current software, including the audio switching between Dolby Digital and PCM, switching of language used in the subtitles and spoken voice.

Title number (DVD)

The title is the largest unit of video and audio recorded in a DVD. It usually corresponds to a single movie of video software or an album (sometimes a piece of music) of music software. The numbers assigned to individual titles are referred to as the title numbers.

Chapter number (DVD)

The chapter is a section of video and audio recorded in a DVD. A title is composed of several chapters. The numbers assigned to individual chapters are referred to as the chapter numbers.

Subtitles (DVD)

Some DVD discs contains the recording of more than one subtitle language. This player allow you to select one of the recorded subtitle languages during playback.

Track number (CD, VCD)

A track is also a section of video and audio recorded in a disc. The numbers assigned to individual tracks are referred to as the track numbers.

With most of music CDs, a track is assigned to a piece of music. However, with a VCD, the sections of the contents do not always correspond to the assigned tracks.

As (special) playback functions such as skipping and programming of ordinary CDs are based on track number data, such playback functions are sometimes impossible with some VCDs.

P.B.C.: Play-Back Control (VCD)

When a VIDEO CD carries "Play Back Control capable" or similar message on the disc or jacket, desired scenes and information can be played back in an interactive manner using a hierarchical structure while viewing the menu screens displayed on the TV screen.

Troubleshooting Guide

Some system functions are limited to control depending on your setup.

- The rear speakers of DTA cannot be set.
- The "Channel Level" of rear speakers cannot be set.

"Multi Channel" has been set to "2/0" or "3/0" (no rear speaker setting) on the Speaker Set Up screen (page 47).

- No signals can be set.
- The "Equalizer" cannot be set.
- The "Position" cannot be set.
- The "Car Type Setup" value cannot be set.
- The "Speaker Setup" value cannot be set.
- No crossover frequency can be set.
- The "Channel Level" (test signal output) cannot be set.

The Zone Control has been turned On (page 74).

- The center speaker for DTA cannot be set.
- The "Channel Level" of the center speaker cannot be set.

"Multi Channel" has been set to "2/0" or "2/2" (no center speaker setting) on the Speaker Set Up screen (page 47).

- The subwoofer of DTA cannot be set.
- The "Channel Level" of the subwoofer cannot be set.

"Sub Woofer" has been set to "Off" on the Speaker Set Up screen (page 47).

Troubleshooting Guide

What might appear to be a malfunction in your unit may just be the result of slight misoperation or miswiring. Before calling service, first check the following table for possible problems.

■ General

The power does not turn on.

- The fuse has blown.
- After checking for short circuits in the wires, replace the fuse with one having the same rating.

The desired source is NOT selected although you pressed the SRC button.

- An optional unit required to listen to each source is not connected yet.
- The RESET button is not pressed yet although the optional unit has been connected to the system.
- The "O-N" switch of the optional unit is at the "O" position.
- A disc changer not supported by the system is used.
- A non-connected source is not selected. See <INSTALLATION MANUAL> and connect the unit correctly.
- Press the reset button (see page 4).
- Set the "O-N" switch to the "N" position.
- Use a disc changer supported by the system (see page 4).

Nothing happens when the buttons are pressed.

- The computer chip in the unit is not functioning normally.
- Press the reset button on the unit (see page 4).

No television/video image appears.

- The unit is not connected to the parking brake detection switch.
- The parking brake is not engaged.
- Make proper connections according to <INSTALLATION MANUAL>.
- For safety reasons no television/video images are displayed while the vehicle is moving. Engaging the parking brake will cause images to be displayed.

The screen is dark.

- The unit is in a location where temperature is low.
- If the temperature of the monitor unit drops, the screen may appear darker when power is first turned on due to the characteristics of a liquid crystal panel. Wait a while after turning power on for the temperature to rise. Normal brightness will return.

The screen does not darken when the vehicle's lights are turned on.

- The unit is set to auto dimmer.
- The illumination wire has not been connected. (If manual dimmer is set)
- When the unit is set to auto dimmer, it is not linked to the vehicle's light switch.
- Make proper connections according to <INSTALLATION MANUAL>.

AM/FM radio reception is poor and/or there is noise.

- The TV antenna and vehicle's radio antenna are too close.
- Separate the two antennas as far as possible.
- Turn off the main unit.

The remote controller does not operate.

- The remote control mode selector is not set correctly.
- Switch the remote control mode selector according to the source you select (see page 12).

No sound can be heard, or the volume is low.

- Attenuator is turned on.
- The fader or balance settings are set all the way to one side.
- The input/output wires or wiring harness are connected incorrectly.
- Turn off Attenuator.
- Reset the fader and/or balance settings.
- Reconnect the input/output wires or the wiring harness correctly. See the section on <INSTALLATION MANUAL>.

The sound quality is poor or distorted.

- One of the speaker wires is being pinched by a screw in the car.
- The speakers are not wired correctly.
- Check the speaker wiring.
- Reconnect the speaker wires so that each output terminal is connected to a different speaker.

Radio reception is poor.

- The car antenna is not extended.
- The antenna control wire is not connected.
- Pull the antenna out all the way.
- Connect the wire correctly, referring to the section on <INSTALLATION MANUAL>.

The memory is erased when the ignition is turned off.

- The battery wire has not been connected to the proper terminal.
- The ignition and battery wire are incorrectly connected.
- Connect the wire correctly, referring to the section on <INSTALLATION MANUAL>.
- Connect the wire correctly, referring to the section on <INSTALLATION MANUAL>.

The TEL mute function does not work.

- The TEL mute wire is not connected properly.
- Connect the wire correctly, referring to the section on <INSTALLATION MANUAL>.

The TEL mute function turns on even though the TEL mute wire is not connected.

- The TEL mute wire is touching a metal part of the car.
- Pull the TEL mute wire away from the metal part of the car.

The sound/picture skips on a DVD/VCD/CD.

- The disc is scratched or dirty.
- Clean the disc, referring to the section on <Disc cleaning> (see page 6).

A track will not play.

- Random play has been selected.
- Turn off random play.

A VCD cannot be played using menus.

- The VCD disc being played is not compatible with P.B.C.
- Menu playback is available only with VCD discs recorded with P.B.C.

The subtitle is not displayed.

- The DVD disc being played does not contain the recording of subtitles.
- The subtitle cannot be displayed when the DVD disc being played does not contain the recording of subtitles.

The voice (or subtitle) language cannot be changed.

- The DVD disc being played does not contain the recording of more than one audio (or subtitle) language.
- The voice (or subtitle) language cannot be changed when the DVD disc being played does not contain the recording of more than one voice (or subtitle) language.

Troubleshooting Guide

The viewing angle cannot be changed.

- The DVD disc being played does not contain the recording of more than one angle.
- You are attempting to switch the angle in a DVD section where more than one angle is not recorded.
- The viewing angle cannot be changed when the DVD disc being played does not contain the recording of more than one angle.
- More than one viewing angle may be recorded only in limited sections in a disc.

Playback will not start even after a title is selected.

- A viewing restriction (RATING) has been set for the disc.
- Check the viewing restriction level (RATING) setting.

The voice or subtitle language selected in the initial setting is not played.

- The DVD disc being played does not contain the recording of the selected voice or subtitle language.
- Use a DVD disc containing the recording of the selected voice or subtitle language.

■ Disc source

The disc control mode cannot be selected.

- No wire has been connected to the disc changer input terminal on the unit.
- Connect the wire to the disc changer input terminal on the unit.

The specified disc does not play, but another one plays instead.

- The specified CD is quite dirty.
- The CD is upside-down.
- The disc is loaded in a different slot from that specified.
- The disc is severely scratched.
- Clean the CD.
- Load the CD with the labeled side up.
- Eject the disc magazine and check the number for the specified disc.
- Try another disc instead.

The sound skips.

- Something is touching the disc changer.
- The CD is scratched or dirty.
- Remove whatever is touching it.
- If skipping happens at the same place when the car is stopped, something with the CD is wrong. Clean the CD.

The display shows that the changer is being played, but no sound can be heard.

- The computer chip in the unit is not functioning normally.
- Press the reset button on the unit (see page 4).

The specified track will not play.

- Random play or magazine random play has been selected.
- Turn off random play or magazine random play.

Track repeat, disc repeat, track scan, disc scan, random play, and magazine random play start by themselves.

- The setting is not cancelled.
- The settings for these functions remain on until the setting to off or the disc ejected, even if the power is turned off or the source changed.

Can't remove disc.

- The cause is that more than 10 minutes has elapsed since the vehicle ACC switch was turned OFF.
- The disc can only be removed within 10 minutes of the ACC switch being turned OFF. If more than 10 minutes has elapsed, turn the ACC switch ON again and press the Eject button.

■ MP3/WMA source

Cannot play an MP3/WMA.

- The media is scratched or dirty.
- Clean the media, referring to the CD cleaning of the section on <About discs> (see page 6).

The sound skips when an MP3/WMA is being played.

- The media is scratched or dirty.
- The recording condition is bad.
- Clean the media, referring to the CD cleaning of the section on <About discs> (see page 6).
- Record the media again or use another media.

The MP3/WMA track time isn't displayed correctly.

- —
- There are times when it isn't displayed correctly according to the MP3/WMA recording conditions.

Can't display the ID3 tag information correctly.

- Record is not made in conformity with the ID3 tag version 1.x.
- Record in conformity with the ID3 tag version 1.x. Also, the display may be incorrect if an MP3 file uses the ID3 tag v1.x standard and if this standard has been expanded after production of the machine software.

The following messages are displayed when certain problems are occurring in your system. Take the recommended actions.

Hot Error	The protective circuit in the unit activates when the temperature inside the unit exceeds 60°C (140°F), stopping all operation. ⇒ Cool down the unit by opening the windows or turning on the air conditioner. As the temperature falls below 60°C (140°F), the disc will start playing again.
Hold Error	The protective circuit in the unit activates when the temperature inside the automatic disc changer exceeds 60°C (140°F), stopping all operation. ⇒ Cool down the unit by opening the windows or turning on the air conditioner. As the temperature falls below 60°C (140°F), the disc will start playing again.
Mecha Error	The disc player is malfunctioning. ⇒ Eject the disc and try inserting it again. Contact the Kenwood dealer if this indicator continues blinking or the disc cannot be ejected.
Disc Error	The unplayable discs is inserted.
Read Error	The disc is upside-down. ⇒ Load the disc with the labeled side up. The disc is quite dirty. ⇒ Clean the disc, referring to the section on <Disc cleaning> (see page 6).
Region code Error	The DVD software encoded for other region code.
Parental level Error	The parental level is set to high levels.
Error 07 — 67	The unit is malfunctioning for some reason. ⇒ Press the reset button on the unit. If the "Error ##" code does not disappear, consult your nearest service center.

Specifications

Specifications subject to change without notice.

Monitor section

Picture size	6.4 inches wide 143.6(W)x77.1(H)mm
Display system	Transparent TN LCD panel
Drive system	TFT active matrix system
Number of pixels	336,960 (480Hx234VxRGB)
Effective pixels	99.99%
Pixel arrangement	RGB striped arrangement
Back lighting	Cold Cathode Fluorescent Tube

DVD section

D/A Converter	24Bit
Decoder	Linear PCM/Dolby digital/dts/MP3/WMA
Wow & Flutter	Below Measurable Limit
Frequency response	
(Sampling frequency;96k)	20~44,000Hz
(Sampling frequency;48k)	20~22,000Hz
(Sampling frequency;44.1k)	20~20,000Hz
Total harmonic distortion (1k)	0.010%
Signal to Noise ratio	100dB (DVD 96k)
Dynamic range	100dB (DVD 96k)
DISC Format	DVD-Video/VIDEO-CD/CD-DA
Sampling frequency	44.1kHz/48kHz, 96kHz
Quantifying bit number	16/20/24bit

FM Tuner section

Frequency range (50kHz)	87.5~108.0MHz
Usable sensitivity (S/N=26dB)	9.3dBf (0.8µV/75Ω)
Quieting sensitivity (S/N=46dB)	15.2dBf (1.6µV/75Ω)
Frequency response (±3.0dB)	30Hz~15kHz
S/N (dB) (MONO)	72dB
Selectivity (±400kHz)	Over80dB
Stereo separation	38dB (1kHz)

AM Tuner section (DDX7045/7065)

Frequency range (9kHz)	531kHz~1611kHz
Usable sensitivity	28dBµ

LW Tuner section (DDX7035)

Frequency range (9kHz)	153kHz~281kHz
Usable sensitivity	28dBµ

MW Tuner section (DDX7035)

Frequency range (9kHz)	531kHz~1611kHz
Usable sensitivity	28dBµ

Video section

Color system of external video input	NTSC/PAL
External video input level (RCA jacks)	1Vp-p/75Ω
External audio max input level(RCA jacks)	1V/22kΩ
Analog RGB input	0.7Vp-p/75Ω

Audio section

Maximum Power (Front&Rear)	50Wx4
Full Bandwidth Power (Front&Rear)	
(at Less than 1%THD)	22Wx4
Preout level (V)	2V/10kΩ
Preout impedance	≤ 600Ω
Tone action	
Bass	100 Hz ±10 dB
Middle	1 kHz ±10 dB
Treble	10 kHz ±10 dB

General

Operating voltage	14.4V (11V~16V)
Current consumption	15A
Dimensions (WxHxD)	182mmx112mmx163mm
Operational temperature range	-10°C~60°C
Storage temperature range	-20°C~85°C
Weight: Main unit	2.8kg

Although the effective pixels for the liquid crystal panel is given as 99.99% or more, 0.01% of pixels may not light or may light incorrectly.

 is a trademark of DVD Format/Logo Licensing Corporation registered in the U.S., Japan and other countries.

This product incorporates copyright protection technology that is protected by U.S. patents and other intellectual property rights. Use of this copyright protection technology must be authorized by Macrovision, and is intended for home and other limited viewing uses only unless otherwise authorized by Macrovision. Reverse engineering or disassembly is prohibited.

Manufactured under license from Dolby Laboratories.
"Dolby" and the double-D symbol are trademarks of Dolby Laboratories.

"DTS" and "DTS 2.0 + Digital Out" are trademarks of Digital Theater Systems, Inc.

KENWOOD

Free Manuals Download Website

<http://myh66.com>

<http://usermanuals.us>

<http://www.somanuals.com>

<http://www.4manuals.cc>

<http://www.manual-lib.com>

<http://www.404manual.com>

<http://www.luxmanual.com>

<http://aubethermostatmanual.com>

Golf course search by state

<http://golfingnear.com>

Email search by domain

<http://emailbydomain.com>

Auto manuals search

<http://auto.somanuals.com>

TV manuals search

<http://tv.somanuals.com>