

KENWOOD

KDV-MP735 KDV-MP765

DVD-RECEIVER

INSTRUCTION MANUAL

KENWOOD CORPORATION



© B64-2832-00/00 (M/C)

Contents

Safety precautions 3

WARNING
CAUTION
NOTE

Notes 5

Notes on playing MP3 6

About DVD/CDs 8

General features 10

Power
Selecting the Source
Volume
Mute
Audio Control
Switching Display
Adjusting Clock
Faceplate Angle Adjustment

Tuner features 13

Tuning
Manual Tuning
Station Preset Memory
Auto Memory Entry
Preset Tuning
Scan Tuning
Local Seek

DVD/ VCD/ CD-DA/ MP3 features 15

Playing DVD, VCD, CD-DA and MP3
Stopping playback
Fast Forwarding and Reversing
Track/Chapter/File Search
Repeat Play
Random Play (VCD, CD-DA)
Track Scan (VCD, CD-DA)
Select audio output channel
MP3 Folder List (MP3)
MP3 Play Mode (MP3)

DVD/ VCD/ CD-DA/ MP3 features of Remote 19

Slow playback (DVD, VCD)
Direct Track Search (VCD, CD-DA, MP3)
GOTO Search (DVD, VCD, CD-DA)
PBC function On/Off (VCD)
Using DVD Menu (DVD)
Switching the Viewing Angle (DVD)
Selecting the Sub Title Language (DVD)
Selecting the Audio Language (DVD)
Switching the Vocal sound (VCD, CD-DA)
Set a TV type
Switching Time Display for Discs
Title Information/Digest screen (DVD)

DVD Setup Menu features 23

DVD setup mode
Setting the General setup
Setting the Audio setup
Setting the Speaker setup
Test tone
Setting the Preferences
Setting the Parental level
Changing the password
Initializing

Menu system 30

Menu System
Clock Display
Touch Sensor Tone
Line Mute
Contrast Adjustment

Basic Operations of remote 32

Accessories/ Installation Procedure 34

Connecting Wires to Terminals 35

Installation 37

Removing the Unit 38

Troubleshooting Guide 39

Specifications 41

Safety precautions

▲WARNING

To prevent injury or fire, take the following precautions:

- Insert the unit all the way in until it is fully locked in place. Otherwise it may fall out of place when jolted.
- When extending the ignition, battery, or ground wires, make sure to use automotive-grade wires or other wires with a 0.75mm² (AWG18) or more to prevent wire deterioration and damage to the wire coating.
- To prevent a short circuit, never put or leave any metallic objects (such as coins or metal tools) inside the unit.
- If the unit starts to emit smoke or strange smells, turn off the power immediately and consult your Kenwood dealer.
- Make sure not to get your fingers caught between the faceplate and the unit.
- Be careful not to drop the unit or subject it to strong shock. The unit may break or crack because it contains glass parts.
- Do not touch the liquid crystal fluid if the LCD is damaged or broken due to shock. The liquid crystal fluid may be dangerous to your health or even fatal. If the liquid crystal fluid from the LCD contacts your body or clothing, wash it off with soap immediately.

▲CAUTION

To prevent damage to the machine, take the following precautions:

- Make sure to ground the unit to a negative 12V DC power supply.
- Do not open the top or bottom covers of the unit.
- Do not install the unit in a spot exposed to direct sunlight or excessive heat or humidity. Also avoid places with too much dust or the possibility of water splashing.
- Do not set the removed faceplate or the faceplate case in areas exposed to direct sunlight, excessive heat or humidity. Also avoid places with too much dust or the possibility of water splashing.
- To prevent deterioration, do not touch the terminals of the unit or faceplate with your fingers.
- Do not subject the faceplate to excessive shock, as it is a piece of precision equipment.
- When replacing a fuse, only use a new one with the prescribed rating. Using a fuse with the wrong rating may cause your unit to malfunction.
- To prevent a short circuit when replacing a fuse, first disconnect the wiring harness.
- Do not place any object between the faceplate and the unit.
- Do not use your own screws. Use only the screws provided. If you use the wrong screws, you could damage the unit.

Do Not Load 3-in. DVD/CDs in the DVD/CD slot

If you try to load a 3 in. DVD/CD with its adapter into the unit, the adapter might separate from the DVD/CD and damage the unit.

Safety precautions

NOTE

- If you experience problems during installation, consult your Kenwood dealer.
- If the unit fails to operate properly, press the Reset button. The unit returns to factory settings when the Reset button is pressed. (See 'Initializing', page 29.) If the unit still fails to operate properly after the Reset button has been pressed, contact your local KENWOOD dealer for assistance.

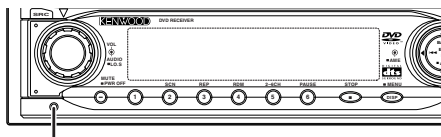

Reset button

- Characters in the LCD may become difficult to read in temperatures below 41 °F (5 °C).
- The illustrations of the display and the panel appearing in this manual are examples used to explain more clearly how the controls are used. Therefore, what appears on the display in the illustrations may differ from what appears on the display on the actual equipment, and some of the illustrations on the display may represent something impossible in actual operation.

Lens Fogging

Right after you turn on the car heater in cold weather, dew or condensation may form on the lens in the Disc player of the unit. Called lens fogging, Discs may be impossible to play. In such a situation, remove the disc and wait for the condensation to evaporate. If the unit still does not operate normally after a while, consult your Kenwood dealer.

Available Discs

You can play back the following types of disc on this unit.

- DVD-Video discs
The KDV-MP735 will playback any disc whose region number is "3" (or "ALL").
The KDV-MP765 will playback any disc whose region number is "6" (or "ALL").
- DVD-R discs (recorded in the standard DVD-Video disc format)
- VCD discs (Video CDs)
- Marked music CDs  (including the finalized CD-R/RW discs)
- CD-ROM/R/RW discs (recorded in the formats listed on Page 6)



- A DVD-R or CD-R/RW disc may not be played back due to its recording status.
Also, the disc not finalized yet cannot be played back. (For finalizing processing, see the Instruction Manual of your recorder or writing software.)
- This player has been designed to play back the DVD software which has been encoded for specific region areas. It cannot play back the DVD software encoded for other region areas than the region areas for which it has been designed. (page 5)

Unavailable Discs

All of DVD-ROM, DVD-RAM, DVD-RW, DVD+R/RW, HQ-VCD and Photo CDs cannot be played back. See the "Available Discs" section.

Restrictions due to difference between discs

Some DVD and VCD discs can be played only in certain playback modes according to the intentions of the software producers. As this player plays discs according to their intentions, some functions may not work as intended by you. Please be sure to read the instructions provided with each disc. When an inhibition icon is displayed on the monitor, it indicates that the disc being played is under the restriction as described above.



Inhibition icon

Notes

Cleaning the Unit

If the faceplate of this unit is stained, wipe it with a dry soft cloth such as a silicon cloth.

If the faceplate is stained badly, wipe the stain off with a cloth moistened with neutral cleaner, then wipe neutral detergent off.



- Applying spray cleaner directly to the unit may affect its mechanical parts. Wiping the faceplate with a hard cloth or using a volatile liquid such as thinner or alcohol may scratch the surface or erases characters.

Cleaning the DVD/CD Slot

As dust tends to accumulate in the DVD/CD slot, clean it every once in a while. Your DVD/CDs can get scratched if you put them in a dusty DVD/CD slot.

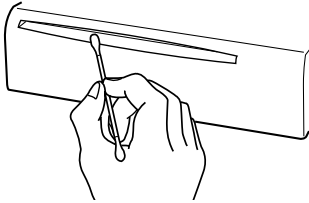

The marking of products using lasers (Except for some areas)

**CLASS 1
LASER PRODUCT**

The label is attached to the chassis/case and says that the component uses laser beams that have been classified as Class 1. It means that the unit is utilizing laser beams that are of a weaker class. There is no danger of hazardous radiation outside the unit.

Region codes in the world

The DVD players are given a region code according to the country or area it is marketed, as shown in the following map.

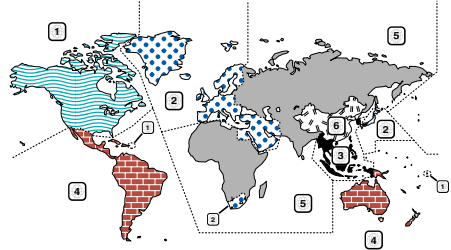

This product incorporates copyright protection technology that is protected by method claims of certain U.S. patents and other intellectual property rights owned by Macrovision Corporation and other rights owners. Use of this copyright protection technology must be authorized by Macrovision Corporation, and is intended for home and other limited viewing uses only unless otherwise authorized by Macrovision Corporation. Reverse engineering or disassembly is prohibited.

Manufactured under license from Dolby Laboratories.

"Dolby" and the double-D symbol are trademarks of Dolby Laboratories. Confidential Unpublished Works. ©1992-1997 Dolby Laboratories, Inc. All rights reserved.

"DTS" and "DTS Digital Surround" are trademarks of Digital Theater Systems, inc.

DVD is a trademark of DVD Format/Logo Licensing Corporation registered in the U.S., Japan and other countries.

Notes on playing MP3

Note, however, that the MP3 recording media and formats acceptable are limited. When writing MP3, pay attention to the following restrictions.

Acceptable media

The MP3 recording media acceptable to this unit are CD-ROM, CD-R, and CD-RW.

When using CD-RW, do full format not quick format to prevent malfunction.

Acceptable medium formats

The following formats are available for the media used in this unit. The maximum number of characters used for file and folder name including the delimiter (".") and three-character extension are indicated in parentheses.

- ISO 9660 Level 1 (12 characters; Up to 11 characters are displayed)
- ISO 9660 Level 2 (31 characters; Up to 11 characters are displayed)
- Joliet (64 character; Up to 11 characters are displayed)

For a list of available characters, see the instruction manual of the writing software and the section Entering file and folder names below.

MP3 written in the formats other than the above may not be successfully played and their file names or folder names are not properly displayed.

Settings for your MP3 encoder and CD writer

Do the following setting when compressing audio data in MP3 data with the MP3 encoder.

- Transfer bit rate:
MP3: 8 —320 kbps
- Sampling frequency
MP3: 16, 22.05, 24, 32, 44.1, 48 kHz

When you use your CD writer to record MP3 up to the maximum disc capacity, disable additional writing. For recording on an empty disc up to the maximum capacity at once, check Disc at Once.

Entering file and folder names

When entering file and folder names, use the alphanumeric characters described above only.

If you use any other character for entry, the file and folder names are not displayed correctly. They may neither be displayed correctly depending on the CD writer used.

The unit recognizes and plays only those MP3 which have the MP3 extension (.MP3).



- A file with a name entered with characters not on the code list may not play correctly.

Writing files into a medium

When a medium containing MP3 data is loaded, the unit checks all the data on the medium. If the medium contains a lot of folders or non-MP3 files, therefore, it takes a long time until the unit starts playing MP3.

In addition, it may take time for the unit to move to the next MP3 file or a File Search or Folder Search may not be performed smoothly.



Loading such a medium may produce loud noise to damage the speakers.

- Do not attempt to play a medium containing a non-MP3 file with the MP3 extension.
The unit mistakes non-MP3 files for MP3/WMA data as long as they have the MP3 extension.
- Do not attempt to play a medium containing non MP3.

MP3 playing order

When selected for play, or for File Search, files and folders are accessed in the order in which they were written by the CD writer.

Because of this, the order in which they are expected to be played may not match the order in which they are actually played. You may be able to set the order in which MP3 are to be played by writing them onto a medium such as a CD-R with their file names beginning with play sequence numbers such as "01" to "99", depending on your CD writer.

For example, a medium with the following folder/file hierarchy is subject to File Search as shown below.

Example of a medium's folder/file hierarchy

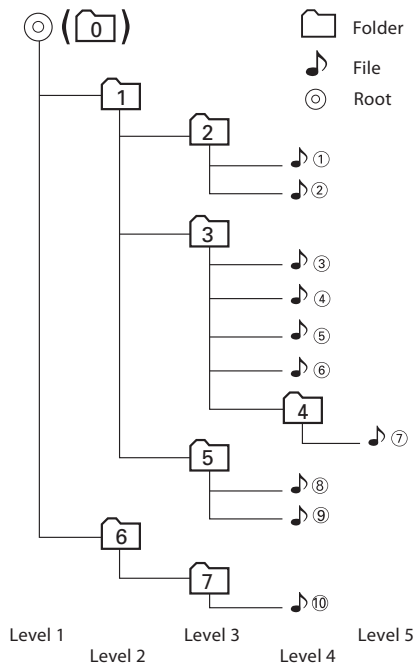

When a File Search is executed with file 🎵 4 being played ...

Operation of the button	(Current file: 🎵 4)
⏮ Button	Beginning of file 🎵 4 → 🎵 3
⏭ Button	🎵 5 → 🎵 6

About DVD/CDs

Handling Discs

- Don't touch the recording surface of the Disc.



- CD-R and CD-RW are easier to damage than a normal music CD. Use a CD-R or a CD-RW after reading the caution items on the package etc.
- Don't stick tape etc. on the Disc. Also, don't use a Disc with tape stuck on it.

When using a new Disc

If the Disc center hole or outside rim has burrs, use it after removing them with a ball pen etc.

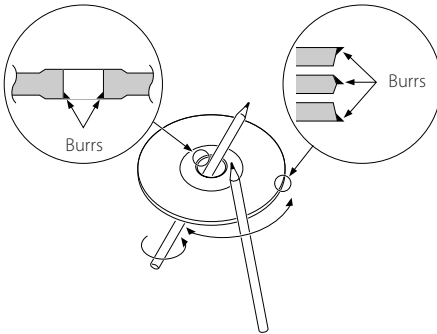

DVD/CD accessories

Don't use disc type accessories.

Disc cleaning

Clean from the center of the disc and move outward.

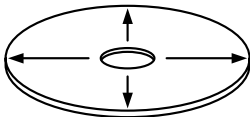

Removing Discs

When removing Discs from this unit pull them out horizontally.

Discs that can't be used

- Discs that aren't round can't be used.







- Discs with coloring on the recording surface or that are dirty can't be used.
- A DVD-R, CD-R or CD-RW that hasn't been finalized can't be played. (For the finalization process refer to your DVD-R/CD-R/CD-RW writing software, and your DVD-R/CD-R/CD-RW recorder instruction manual.)

Disc storage

- Don't place them in direct sunlight (On the seat or dashboard etc.) and where the temperature is high.
- Store Discs in their cases.

Icons on the DVD discs

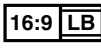
	Indicates the region code where the disc can be played.
	Number of voice languages recorded with the audio function. The number in the icon indicates the number of voice languages. (Max. 8 languages)
	Number of subtitle languages recorded with the subtitle function. The number in the icon indicates the number of subtitle languages. (Max. 32 languages)
	Number of angles provided by the angle function. The number in the icon indicates the number of angles. (Max. 9 angles)
	Aspect ratios that can be selected. "LB" stands for Letter Box and "PS" for Pan/Scan. In the example on the left, the 16:9 video can be converted into letter box video.

General features

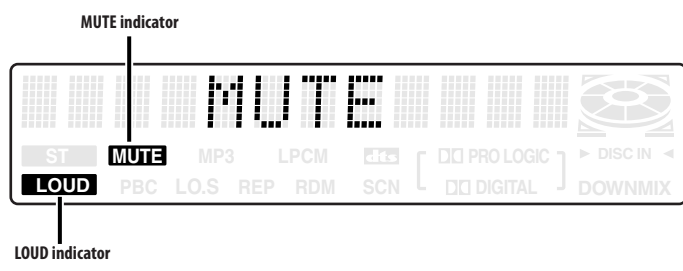
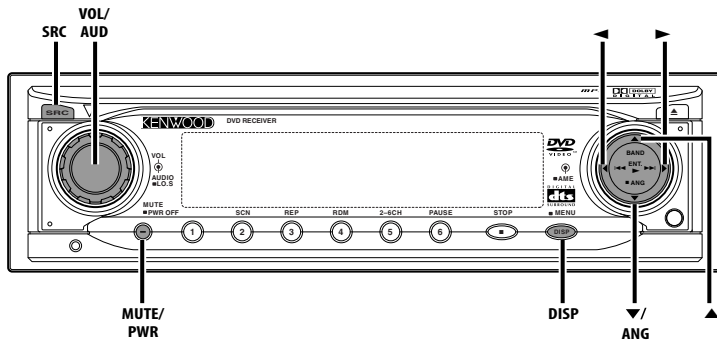

Power

Turning ON the Power

Press the [PWR] button.

Turning OFF the Power

Press the [PWR] button for at least 1 second.

Selecting the Source

Press the [SRC] button.

Source required	Display
Tuner	"TUNER"
DVD/VCD/ CD-DA/ MP3	"DVD"
Auxiliary input	"AUX IN"



- Video images are outputted in the DVD source mode only. The front video output produces video images when the parking brake is set correctly.

Volume

Increasing Volume

Turn the [VOL] knob clockwise.

Decreasing Volume

Turn the [VOL] knob counterclockwise.

Mute

Mutes (or cuts) the sound level temporarily.

Press the [MUTE] button.

Each time the button is pressed the Mute turns ON or OFF. When it's ON, the "MUTE" indicator blinks.

Audio Control

1 Select the Audio item for adjustment Press the [AUD] button.

Each time the button is pressed the items that can be adjusted switch as shown below.

2 Adjust the Audio item Rotate the Rotary Volume knob.



- When operation stops for 5 seconds, the Audio Control mode closes.

In Tuner, DVD (2 channel mode), or Auxiliary input source

Adjustment Item	Display	Range
Bass level*	"Bass"	-7 — +7
Treble level*	"Treble"	-7 — +7
Balance	"Balance"	Left 9 — Right 9
Fader	"Fader"	Rear 9 — Front 9
Loudness	"Loud"	ON/OFF
Sound	"Sound"	USER/ SOFT/ HARD/ SHARP/ CINEMA
Volume	"Volume"	00 — 40



- * Can be used only when you have set the "Sound" item to "USER".
- The LOUD indicator lights when you turn the Loudness control On.
- No sound is outputted from the center speaker and the subwoofer.

In DVD (6 channel mode) source

Adjustment Item	Display	Range
Front left level	"FrontL"	-10 — +10
Center level	"Center"	-10 — +10
Front right level	"FrontR"	-10 — +10
Rear left level	"RearL"	-10 — +10
Rear right level	"RearR"	-10 — +10
Subwoofer level	"SUB W"	-10 — +10
Volume	"Volume"	00 — 40



- Before adjusting the volume of each speaker, complete the procedure of 'Setting the Speaker setup' (page 26).
- Sound may not be outputted due to the setting conditions. Please see Section, 'Select audio output channel' (Page 17).

Switching Display

Switching the information displayed.

Press the [DISP] button.

Each time the button is pressed the display switches as shown below.

In Tuner source

Information

Frequency

Clock (It is displayed 5 seconds only.)

In DVD/VCD/CD-DA/MP3 source

Information

Play time & Track number

Clock (It is displayed 5 seconds only.)

Disc type (It is displayed 5 seconds only.)

In Auxiliary input source

Information

Auxiliary input

Clock (It is displayed 5 seconds only.)



- You can change the "Play time" by the procedure of 'Switching Time Display for Discs' (page 21).

Adjusting Clock

1 Select the clock display

Press the [DISP] button.

2 Enter clock adjustment mode

Press the [DISP] button for at least 1 second.

The clock display blinks.

3 Select an item you wish to adjust.

Press the [◀] or [▶] button.

4 Set the clock time.

Press the [▲] or [▼] button.

Repeat Steps 3 and 4 to adjust the clock.

5 Exit clock adjustment mode

Press the [DISP] button.



- When operation stops for 5 seconds, the clock adjustment mode closes.

Faceplate Angle Adjustment

You can adjust the front panel angle for easy viewing.

1 Enter faceplate angle adjustment mode

Press the [ANG] button for at least 1 second.

"Angle Adj" is displayed.

2 Adjust the Faceplate Angle

Press the [ANG] button.



- When operation stops for 5 seconds, the faceplate angle adjustment mode closes.
- Do not apply excessive force to the faceplate. It can cause damage.

Tuner features

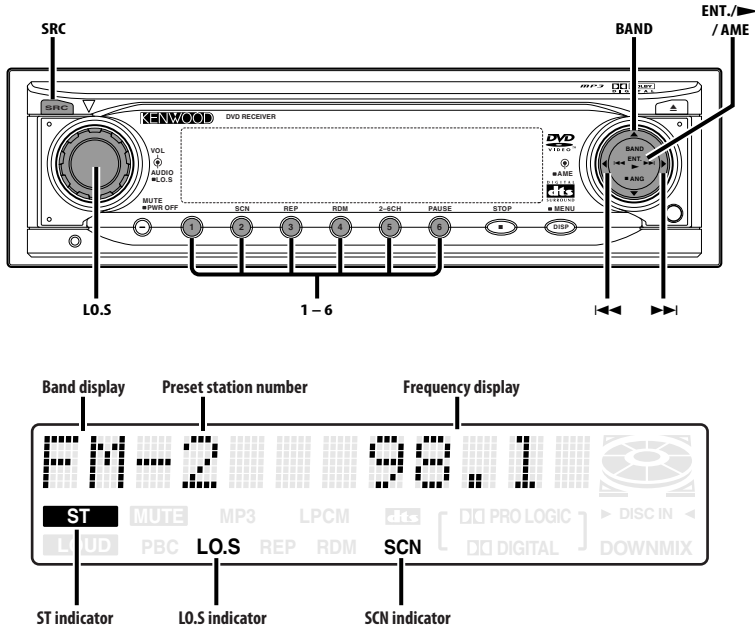

Tuning

Selecting the station.

1 Select tuner source

Press the [SRC] button.

Select the "TUNER" display.

2 Select the band

Press the [BAND] button.

Each time the button is pressed it switches between the FM1, FM2, FM3, AM1, and AM2 bands.

3 Tune up or down band (Auto tuning)

Press the [◀▶] or [▶▶] button.



- During reception of stereo stations the "ST" indicator is ON.

Manual Tuning

1 Enter manual tuning mode

Press the [◀◀] or [▶▶] button for at least 1 second.

2 Tune up or down band

Press the [◀◀] or [▶▶] button.



- When operation stops for 5 seconds, the manual tuning mode closes.
- When you start another operation (band switching, volume control or others), the Manual Tuning mode is released.

Tuner features

Station Preset Memory

Putting the station in the memory.

- 1 Select the band**
Press the [BAND] button.
- 2 Select the frequency to put in the memory**
Press the [◀◀] or [▶▶] button.
- 3 Put the frequency in the memory**
Press the desired [1] — [6] button for at least 1 second.
On each band, 1 station can be put in the memory on each [1] — [6] button.

Auto Memory Entry

Putting stations with good reception in the memory automatically.

- 1 Select the band for Auto Memory Entry**
Press the [BAND] button.
- 2 Open Auto Memory Entry**
Press the [AME] button for at least 1 second.
When you reach the end of frequency band, the Auto Memory Entry completes automatically.

Preset Tuning

Calling up the stations in the memory.

- 1 Select the band**
Press the [BAND] button.
- 2 Call up the station**
Press the desired [1] — [6] button.

Scan Tuning

Tunes the receivable stations one by one every approximately 5 seconds.

- 1 Select the band**
Press the [BAND] button.
- 2 Start Scan Tuning**
Press the [ENT./▶] button.
When it's ON, "SCN" indicator is ON.
- 3 When you have tuned the desired station**
Press the [ENT./▶] button.

Local Seek

Only stations whose reception is good are searched for in auto seek tuning.

- Press the [LO.S] button for at least 1 second.**
Each time the button is pressed the Local Seek turns ON or OFF.
When it's ON, "LOS" indicator is ON.

DVD/VCD/ CD-DA/ MP3 features

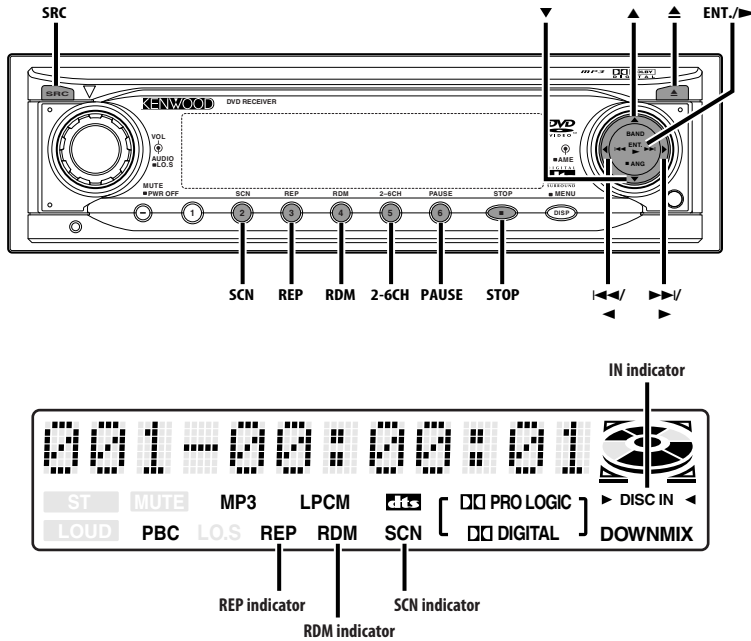

Playing DVD, VCD, CD-DA and MP3

When there is no disc inserted

- 1 Open the panel to insert disc
Press the [▲] button.
- 2 Insert a disc.



- When the faceplate has been slid open, it might interfere with the shift lever or something else. If this happens, pay attention to safety and move the shift lever or take an appropriate action, then operate the unit.



- When a disc is inserted the "IN" indicator is ON.

When a disc is inserted

Press the [SRC] button.
Select the "DVD" display.

Pause and play

Press the [PAUSE] button.

Each time the button is pressed the song pauses or plays.

Eject the disc

- 1 Eject the disc
Press the [▲] button.
- 2 Return the panel to the original position
Press the [▲] button.



- 3 in. (8cm) disc can't be played. Using an adapter and inserting them into this unit can cause damage.
- Video images are outputted in the DVD source mode only. The front video output produces video images when the parking brake is set correctly.



- The MP3 media that this unit can play are CD-ROM, CD-R, and CD-RW. The medium formats must be ISO 9660 Level 1, Level 2, or Joliet. The methods and precautions to be followed for writing MP3 data are covered in 'Notes on playing MP3' (page 6). Check that section before creating your MP3 media.

Stopping playback

1 Stopping playback

Press the [STOP] button.

VCD/CD-DA/MP3

Stop to play.

DVD

Press the button once during playback stops it and the position where it is stopped is stored in memory.



- Press the [STOP] button twice to cancel playback.
- No operation is possible depending on disks.

2 Resume the play (DVD only)

Press the [ENT./▶] button.

Press button under this condition to resume the play.

Fast Forwarding and Reversing

Fast Forwarding

Press the [▶▶] button for at least 1 second.

Reversing

Press the [◀◀] button for at least 1 second.

Each time the button is pressed the Search speed switches as shown below.

Setting	Display
2 times	"FF 2X" / "FR 2X"
4 times	"FF 4X" / "FR 4X"
6 times	"FF 6X" / "FR 6X"
8 times	"FF 8X" / "FR 8X"
Normal play	"PLAY"



- Audio output of DVDs and video CDs is disabled during fast-forward and fast-rewind. Audio output of audio CDs is disabled at the 6x, 8x-speed operation.

Canceling Fast Forwarding / Reversing

Press the [ENT./▶] button.

Track/Chapter/File Search

Press the [◀◀] or [▶▶] button.

Disc	Search
DVD	Searching for a chapter
VCD[PBC ON]	—
VCD[PBC OFF], CD-DA	Searching for a track
MP3	Searching for a file

Repeat Play

Press the [REP] button.

Each time the button is pressed the Repeat Play switches as shown below.

When it's ON, "REP" indicator is ON.

DVD:

Repeat play	Display/Screen Display
Chapter Repeat	"Chapter REP"/"CHAPTER REPEAT ON"
Title Repeat	"Title REP"/"TITLE REPEAT ON"
OFF	"Normal Play"/"REPEAT OFF"

VCD[PBC OFF], CD-DA:

Repeat play	Display/Screen Display
Track Repeat	"Track REP"/"REP-ONE"
Disc Repeat	"Disc REP"/"REP-ALL"
OFF	"Normal Play"/"REPEAT OFF"



- When a music CD is loaded, it can be repeated to play during normal playback.

MP3:

Repeat play	Display/Screen Display
File Repeat	"Track REP"/"REP-ONE"
Folder Repeat	"Disc REP"/"REP-ALL"
OFF	"Normal Play"/"REPEAT OFF"

Random Play (VCD, CD-DA)

Play all the songs on the disc in random order.

Press the [RDM] button.

Each time the button is pressed Random Play turns ON or OFF.

When it's ON, "Track RDM" is displayed.



- When the [▶▶] button is pressed, the next song select starts.
- When used for a video CD during play with PBC ON, the PBC is turned Off.

Track Scan (VCD, CD-DA)

Playing the first part of each song on the disc you are listening to and searching for the song you want to listen to.

1 Start Track Scan

Press the [SCN] button.

"Track SCAN" is displayed. Scan starts from the first track.

When it's ON, "SCN" indicator is ON.

2 Release it when the song you want to listen to is played

Press the [SCN] button.



- When used for a video CD during play with PBC ON, the PBC is turned Off.

Select audio output channel

You can set the mixed output at 2-channel stereo port or the separate output of each channel.

Press the [2-6CH] button for at least 1 second.

Setting	Display
2 channel (stereo) mode	"Stereo"
6 channel mode	"Full 6CH"



- The audio of each channel is output as shown on the next table depending on your setup and playback audio. (The sound is output only when marked by symbol "●" on the table.)

	Front output	Rear output	Center output	Subwoofer output
2 channel mode	●	●		
Play the 2-channel audio in the 6-channel mode with Dolby Pro-Logic function Off.	●			
Play the 2-channel audio in the 6-channel mode with Dolby Pro-Logic function On. *	●	●	●	●
Play the 6-channel audio in the 6-channel mode.	●	●	●	●

* When you have set the "FRONT" and "REAR" or "CENTER" item to "SMALL" by 'Setting the Speaker setup' (page 26).

The 2-channel audio is a linear PCM, a music CD, and an MP3 audio sound.

The 6-channel audio is a DVD's 5.1-ch Dolby digital sound and a DTS audio sound.

- When you have set the "FRONT," "CENTER," "REAR" and "SUBWOOFER" items to "OFF" or "NONE" by 'Setting the Speaker setup' (page 26), no sound is output by its speaker.
- For Dolby Pro-Logic function setup, see the "PRO LOGIC" section of 'Setting the Audio setup' (page 25).

MP3 Folder List (MP3)

Select a folder or a file you wish to play.

1 Stops to play

Press the [STOP] button.

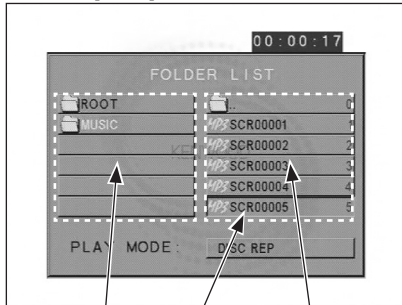

Folder list

File list

The selected item is displayed as the pressed button.

2 Moves to the Folder List

Press the [◀] or [▶] button.

3 Selects a folder

Press the [▲] or [▼] button.

4 Determines the folder

Press the [ENT./▶] button.

5 Moves to the File List

Press the [◀] or [▶] button.

6 Selects a file

Press the [▲] or [▼] button.

7 Determines the file

Press the [ENT./▶] button.

The file starts to play.

MP3 Play Mode (MP3)

Select a playback mode.

1 Stops to play

Press the [STOP] button.

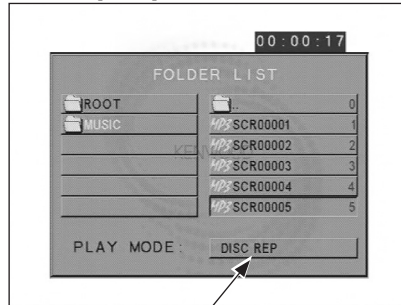

Play mode

2 Moves to a play mode selection

Press the [◀] or [▶] button.

3 Selects a play

Press the [▲] or [▼] button.

Display	Setting
"SINGLE"	Pauses after play of a single music.
"REP-ONE"	Repeats to play a single music.
"FOLDER"	Pauses after play of music in a folder.
"FOLDER REP"	Repeats to play music in a folder.
"DISC SCAN"	Play the beginning of music on a disc one after another approximately 10 seconds.
"DISC"	Pauses after play of music on a disc.
"DISC REP" (Original setting)	Repeats to play music on a disc.
"RANDOM"	Plays music on a disc in the random sequence.
"SHUFFLE ON"	Plays music of a folder in the random sequence, and pauses after its play.

4 Moves to the File List

Press the [◀] or [▶] button.

5 Selects a file

Press the [▲] or [▼] button.

6 Determines a file

Press the [ENT./▶] button.

Play starts in accordance with selected play mode.

DVD/ VCD/ CD-DA/ MP3 features of Remote

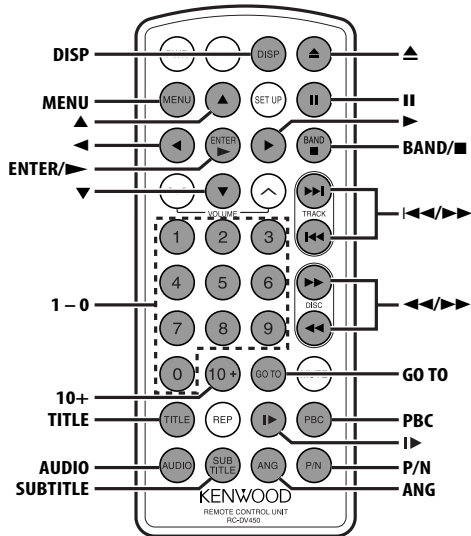

Slow playback (DVD, VCD)

Press the **||>** button.

Each time the button is pressed the Search speed switches as shown below.

DVD

Setting	Display
Forward of 1/2 times	"SF 2X"
Forward of 1/4 times	"SF 4X"
Forward of 1/8 times	"SF 8X"
Reverse of 1/2 times	"SR 2X"
Reverse of 1/4 times	"SR 4X"
Reverse of 1/8 times	"SR 8X"
Normal play	"PLAY"

VCD

Setting	Display
Forward of 1/2 times	"SF 2X"
Forward of 1/4 times	"SF 4X"
Forward of 1/8 times	"SF 8X"
Pause	"STEP BWD"



- You can return to the normal play by pressing the [ENTER/▶] button.

Direct Track Search (VCD, CD-DA, MP3)

Doing Track Search by entering the track/file number.

Press the number buttons.



- Press [10+] button to input two digits or more.

DVD/VCD/ CD-DA/ MP3 features of Remote

GOTO Search (DVD, VCD, CD-DA)

1 Enter GOTO mode

Press the [GOTO] button.

For DVDs, specify the title/chapter number or the elapsed time of the title.

For VCD and CD-DA, specify the elapsed time of the disc.

2 Select Search mode (DVD only)

Press the [GOTO] button.

Each time the button is pressed the Search mode switches as shown below.

Search mode	Display
Title/Chapter Search	"TITLE **/** CHAPTER **/**"
Time Search	"TIME ____ : ____"



- During Title/Chapter Search mode, the Title Number display and the Chapter Number display are switched to each other when you press the [◀] or [▶] button.

3 Enter the number

Press the number buttons.



- Example: In case of Chapter 13 of a DVD
"CHAPTER 013/030": (10) (3)
- Example: In case of 12 min. 34 sec. of a CD-DA
"GO TO 12:34": (1) (2) (3) (4)

4 Do Search (DVD only)

Press the [ENTER/▶] button.

PBC function On/Off (VCD)

You can determine whether to use the PBC function for video CDs with playback control record.

Press the [PBC] button.

Each time the button is pressed PBC function turns ON or OFF.

When it's ON, "PBC" indicator is ON.

Using DVD Menu (DVD)

Available in DVDs with title menus/root menus.

1 Enter Top Menu (root menu) mode

Press the [MENU] button.

"DVD MENU" is displayed.

Enter Title Menu mode

Press the [TITLE] button.

"TITLE MENU" is displayed.

2 Selecting the menu item

Press the [◀], [▶], [▲] or [▼] button or press the number buttons.

3 Setting the menu item

Press the [ENTER/▶] button.



- See your disc's operating instructions for information on the menu operation.

Switching the Viewing Angle (DVD)

Press the [ANGLE] button.

Each time you press the button to switch viewing angle.

Selecting the Sub Title Language

(DVD)

Press the [SUB TITLE] button.

Each time you press the button to change the sub title language.

Selecting the Audio Language (DVD)

Press the [AUDIO] button.

Each time you press the button to change the voice language.

Switching the Vocal sound (VCD, CD-DA)

Press the [AUDIO] button.

Each time the button is pressed the vocal sound switches.

VCD

Setting	Display
Left vocal*	"LEFT VOCAL"
Right vocal*	"RIGHT VOCAL"
Monaural Left (L / L)	"MONO LEFT"
Monaural Right (R / R)	"MONO RIGHT"
Stereo (L / R)	"STEREO"



- * The "LEFT VOCAL" and "RIGHT VOCAL" functions may not operate normally if the Karaoke sounds are not recorded correctly on the video CD.

CD-DA

Setting	Display
Monaural Left (L / L)	"MONO LEFT"
Monaural Right (R / R)	"MONO RIGHT"
Stereo (L / R)	"STEREO"

Set a TV type

A TV type can be set according to the TV color display mode.

1 Steps to play

Press the [BAND/■] button.

2 Sets a TV type

Press the [P/N] button.

Each time the button is pressed the TV type switches as shown below.

Display	Setting
"MULTI"	The color signal output is switched automatically according to the recording system of the current disc.
"NTSC"	The color signals are output in the standard NTSC system.
"PAL"	The color signals are output in the standard PAL system.



- The setup can be changed temporarily by the Remote Commander. Set the TV type using the "TV TYPE" item of 'Setting the Speaker setup' (page 28).

Switching Time Display for Discs

Switch the display that appears while discs are playing.

Press the [DISP] button.

Each time the button is pressed the display switches as shown below.

DVD

Information	Display
Title time	"TITLE ###/### CHAPTER ###/###"
Remaining time of title	"TITLE REMAIN"
Chapter time	"CHAPTER ELAPSED"
Remaining time of chapter	"CHAPTER REMAIN"
OFF	

VCD[PBC ON]

Information	Display
Track Time	"SINGLE ELAPSED"
Remaining time of track	"SINGLE REMAIN"
OFF	"OFF"

VCD[PBC OFF], CD-DA

Information	Display
Track Time	"SINGLE ELAPSED"
Remaining time of track	"SINGLE REMAIN"
Disc time	"TOTAL ELAPSED"
Remaining time of disc	"TOTAL REMAIN"
OFF	"OFF"

MP3

Information	Display
Track Time	"SINGLE ELAPSED"
Remaining time of track	"SINGLE REMAIN"
OFF	"OFF"



- When it is OFF, the title or the track elapse time is displayed.

Title Information/Digest screen (DVD)

This shows the information on your disc/title.

1 Enter Title Information Press the [PBC] button.

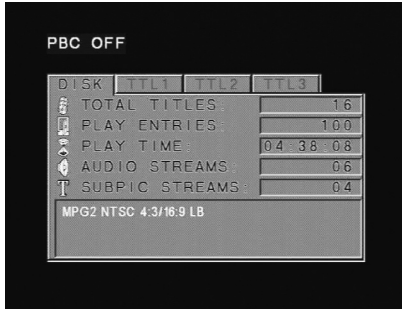

2 Select Title Press the [◀] or [▶] button.



- Press the [◀◀] or [▶▶] button to change 10 titles at a time.
- Press the [◀◀◀] or [▶▶▶] button to switch to the first or last title.

3 Play Title Press the [ENTER/▶] button.



- Press the [BAND/■] button to stop playing.

4 Display Digest Screen Press the [MENU] button.



- Press the [BAND/■] button to return to the Title Information screen.

5 Select Chapter Press the desired [1] — [9] button.



- Press the [BAND/■] button to stop playing.
- Press the [◀◀] or [▶▶] button to change the display page.

6 Canceling the title information Press the [PBC] button.



- Some titles or chapters may not be displayed. In this case, the original screen will be displayed.

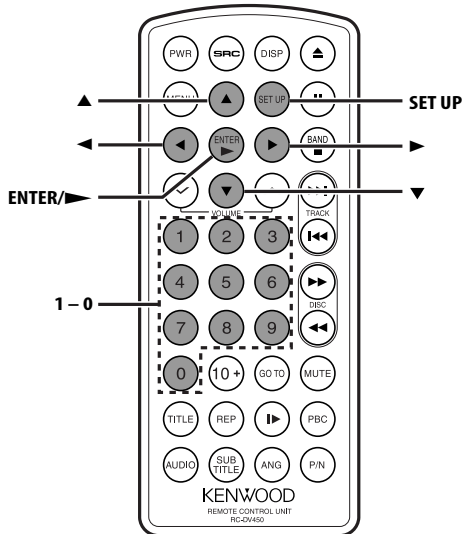

In DVD source

DVD setup mode

1 Enter Setup mode

Press the [SET UP] button.

Display

"GENERAL SETUP"	Page 24
"SPEAKER SETUP"	Page 26
"AUDIO SETUP"	Page 25
"PREFERENCES"	Page 28
"EXIT SETUP"	Exit setup mode



- When you have set the "Stereo" by 'Select audio output channel' (page 17), you cannot set the "SPEAKER SETUP" item.
- You cannot set the "PREFERENCES" during playback. To do so, stop to play (by selecting the "Stop").

2 Select the Setup page

Press the [▲] or [▼] button.

The selected item is displayed in white characters.

3 Set the Setup page

Press the [ENTER/▶] button.

4 Select the setup item

Press the [▲] or [▼] button.



- See the setup operations for Setup Items and their set values.

5 Set the setup item

Press the [▶] button.

6 Select the setting

Press the [▲] or [▼] button.

7 Set the setting

Press the [ENTER/▶] button.

The value you have set is displayed by the pressed button.

8 Exit Setup page

Select "MAIN PAGE" and press the [ENTER/▶] button.

9 Exit Setup mode

Select "EXIT SETUP" and press the [ENTER/▶] button.

DVD Setup Menu features

Setting the General setup

- 1 Select "GENERAL SETUP" page
See 'DVD setup mode' (page 23) to select "GENERAL SETUP".

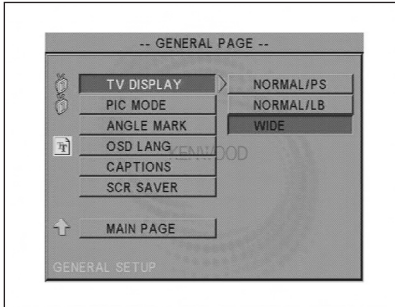

- 2 Select the general setup item
Press the [▲], [▼], [◀] or [▶] button to select an item.
Press the [ENTER/▶] button.

"TV DISPLAY"

Use the procedure described below to set the output screen.

Display	Setting
"NORMAL/PS"	Wide-screen software with pan & scan specification is played in a panned & scanned screen (with the left and right sides cut off).
"NORMAL/LB"	Wide-screen software with pan & scan specification is played in a letter box screen (with black stripes on the top and bottom).
"WIDE"	Set the picture mode of the wide-screen monitor to "FULL"

"PIC MODE"

Select a DVD image mode.

Display	Setting
"AUTO"	The image is switched automatically depending on the original image.
"HI-RES"	The original image recorded on the DVD is the Video mode.
"N-FLICKER"	The original image recorded on the DVD is the Movie Picture mode.

"ANGLE MARK"

When multiple image angles are recorded on a DVD, they are shown by the mark during playback.

Display	Setting
"ON"	Displays the Angle mark.
"OFF"	Does not display the Angle mark.

"OSD LANG"

Set the setup, message or other display languages.

Display	Setting
"ENGLISH"	Set the English.
"CHINESE"	Set the Chinese.

"CAPTIONS"

When a disc having the Closed Captions information is played back, this information can be output.

Display	Setting
"ON"	Outputs the Closed Captions signal.
"OFF"	Does not output the Closed Captions signal.

"SCR SAVER"

To prevent the screen burn-out, you can start the screen saver automatically when the on-screen image does not change for a certain time period.

Display	Setting
"ON"	Starts the screen saver automatically.
"OFF"	Does not use the screen saver.

3 Exit Setup page

Select "MAIN PAGE" and press the [ENTER/▶] button.

Setting the Audio setup

- 1 Select "AUDIO SETUP" page**
See 'DVD setup mode' (page 23) to select "AUDIO SETUP".

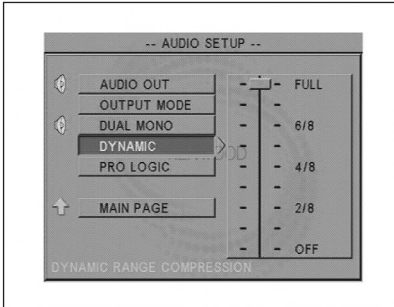

- 2 Select the audio setup item**
Press the [▲], [▼], [◀] or [▶] button to select an item.
Press the [ENTER/▶] button.

"AUDIO OUT"

You cannot change this item setup. Use it as it is.

"OUTPUT MODE"

You cannot change this item setup. Use it as it is.

"DUAL MONO"

Set the output sound of a Karaoke DVD (for a sing-along machine).

Display	Setting
"STEREO"	Stereo (L / R)
"L-MONO"	Monaural Left (L / L)
"R-MONO"	Monaural Right (R / R)
"MIX-MONO"	Mixed Left and Right (L+R)

"DYNAMIC"

Sets the dynamic range of playback sound recorded on a Dolby Digital system DVD.

Display	Setting
"FULL"	For more powerful sound at regular volumes
"7/8"	
"6/8" / "3/4"	Large ↑ Compression rate ↓ Small
"5/8"	
"4/8" / "1/2"	
"3/8"	
"2/8" / "1/4"	
"1/8"	
"OFF"	For the regular sound

"PRO LOGIC"

Set the use of Dolby Pro Logic for the Dolby Digital 2-channel DVD/VCD, CD-DA or MP3.

Display	Setting
"OFF"	Turns the Dolby Pro-Logic function Off.
"ON"	Turns the Dolby Pro-Logic function On.
"AUTO"	Turns the Dolby Surround play On automatically when available.



- You cannot operate Dolby Digital 5.1ch surround or DTS 5.1ch surround DVD and DTS-CD are playing.

3 Exit Setup page

Select "MAIN PAGE" and press the [ENTER/▶] button.

Setting the Speaker setup

- 1 Select "SPEAKER SETUP" page
See 'DVD setup mode' (page 23) to select "SPEAKER SETUP".

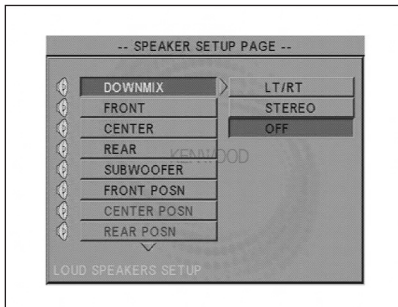

- 2 Select the speaker setup item
Press the [▲], [▼], [◀] or [▶] button to select an item.
Press the [ENTER/▶] button.

"DOWNMIX"

Set the mixed sound output to the 2-channel stereo port or the output of each channel separately.

Display	Setting
"LT/RT"	Outputs the sound mixed to the Dolby Surround audio.
"STEREO"	Outputs the sound mixed to the stereo sound.
"OFF"	Outputs the sound in the multi-channel mode.



- In the multi-channel mode, only the front speaker sound is output when you have turned the Dolby Pro-Logic function Off and when you play the 2-channel sound of a linear PCM, a video CD, a music CD, or an MP3 audio.
- Also, see the Notes of 'Select audio output channel' section (page 17).

"FRONT"

Display	Setting
"LARGE"	Used for speakers that can play the wide frequency range including bass.
"SMALL"	Used for speakers that cannot play the bass enough.

"CENTER"

Display	Setting
"LARGE"	Used for speakers that can play the wide frequency range including bass.
"SMALL"	Used for speakers that cannot play the bass enough.
"OFF"	No center speaker is used.

"REAR"

Display	Setting
"LARGE"	Used for speakers that can play the wide frequency range including bass.
"SMALL"	Used for speakers that cannot play the bass enough.
"OFF"	No center speaker is used.

"SUBWOOFER"

Display	Setting
"PRESENT"	The subwoofer is used.
"NONE"	No subwoofer is used.

"FRONT POSN"

Set a distance from front speakers to the listening position. It can be set from "0.5 FT/0.1 M" to "13.0 FT/3.3 M" at every 0.5-foot (approximately 0.1-meter) step.

"CENTER POSN"

Set a distance from center speakers to the listening position. It can be set from "0.5 FT/0.1 M" to "13.0 FT/3.3 M" at every 0.5-foot (approximately 0.1-meter) step.

"REAR POSN"

Set a distance from rear speakers to the listening position. It can be set from "0.5 FT/0.1 M" to "13.0 FT/3.3 M" at every 0.5-foot (approximately 0.1-meter) step.

"TEST TONE"

See 'Test tone', page 27.

3 Exit Setup page

Select "MAIN PAGE" and press the [ENTER/▶] button.



- When you set the "DOWNMIX" to "LT/RT" or "STEREO," you cannot set any parameter other than "DOWNMIX."
- The "LARGE" or "SMALL" setup of "FRONT," "CENTER" and "REAR" items corrects the bass during playback of Dolby Digital sound.
- You can select the "SMALL" of "FRONT" item only when you have set the "SUBWOOFER" item to "PRESENT."

Test tone

This item allows you to adjust the output level of each channels of speaker using the built-in test signal. The output level must be adjusted from the listening position.

1 Select "SPEAKER SETUP" page

See 'DVD setup mode' (page 23) to select "SPEAKER SETUP".

2 Selects the "TEST TONE" signal output

Select "TEST TONE" and press the [ENTER/▶] button.

3 Sets the "TEST TONE" output

Press the [▲], [▼], [◀] or [▶] button to select an item.

Press the [ENTER/▶] button.

Display	Setting
"ON"	Outputs the test tone (noise signals).
"OFF"	Stops to output the test tone.

4 Adjusts the sound level of each speaker

See the 'Audio Control' section (page 11) and adjust each speaker to output the same level of sounds.

5 Turns the Test tone off

Select "OFF" and press the [ENTER/▶] button.

6 Exit Setup page

Select "MAIN PAGE" and press the [ENTER/▶] button.

DVD Setup Menu features

Setting the Preferences

- 1 Select "PREFERENCES" page
See 'DVD setup mode' (page 23) to select "PREFERENCES".

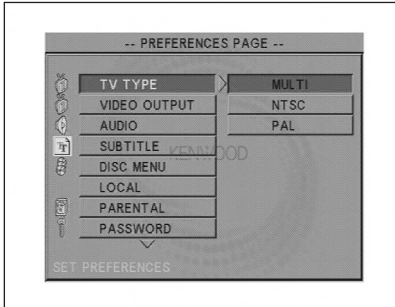

- You cannot set the "PREFERENCES" during playback. To do so, stop to play (by selecting the "Stop").

- 2 Select the preferences item
Press the [▲], [▼], [◀] or [▶] button to select an item.
Press the [ENTER/▶] button.

"TV TYPE"

A TV type can be set according to the TV color display mode.

Display	Setting
"MULTI"	The color signal output is switched automatically according to the recording system of the current disc.
"NTSC"	The color signals are output in the standard NTSC system.
"PAL"	The color signals are output in the standard PAL system.



- The setup can be changed temporarily by the Remote Commander. (page 21)

"VIDEO OUTPUT"

You cannot change this item setup. Use it as it is.

"AUDIO"

Set the audio language produced from the speakers.

Display	Setting
"ENGLISH"	English
"FRENCH"	French
"SPANISH"	Spanish
"CHINESE"	Chinese
"JAPANESE"	Japanese

"SUBTITLE"

Set the language of the subtitles displayed on the screen.

Display	Setting
"ENGLISH"	English
"FRENCH"	French
"SPANISH"	Spanish
"CHINESE"	Chinese
"JAPANESE"	Japanese
"OFF"	No subtitle is displayed

"DISC MENU"

Set the language used for the menus (title menu, etc.).

Display	Setting
"ENGLISH"	English
"FRENCH"	French
"SPANISH"	Spanish
"CHINESE"	Chinese
"JAPANESE"	Japanese

"LOCAL"

Display	Setting
"CHINA"	China
"FRANCE"	France
"HONG KONG"	Hong Kong
"JAPAN"	Japan
"TAIWAN"	Taiwan
"GBR"	Great Britain
"USA"	United States of America

"PARENTAL"

See 'Setting the Parental level', page 29.

"PASSWORD"

See 'Changing the password', page 29.

"DEFAULTS"

See 'Initializing', page 29.

"FOLDER LIST"

You cannot change this item setup. Use it as it is.

3 Exit Setup page

Select "MAIN PAGE" and press the [ENTER/▶] button.

Setting the Parental level

Use this function to restrict the viewing of movies to children of appropriate age levels only.

1 Select the "PARENTAL"

See 'Setting the Preferences' (page 28) to select "PARENTAL".

2 Setting a Parental Lock level

Press the [▲] or [▼] button.

Display	Setting
"1 G"	Plays children-oriented software. Restricts playback of adult and general-oriented DVD software.
"2"	
"3 PG"	
"4 PG 13"	
"5"	
"6 PG-R"	
"7 NC-17"	
"8 ADULT"	Plays any software (including adult-, general- and children-oriented).
"NO_PARENTAL"	Canceling the parental lock.

3 Enter the password

Press the number buttons.

Enter your password (4-digit). Input numbers are displayed "X".

Press the [ENTER/▶] button.



- Parental level varies with the discs.
- The password's initial value is "3308".

Changing the password

1 Select the "PASSWORD"

See 'Setting the Preferences' (page 28) to select "PASSWORD".

2 Select the "CHANGE"

Select "CHANGE" and press the [ENTER/▶] button.

3 Changes the password.

Press the number buttons.

Display	Setting
"OLD PASSWORD"	To enter your current password correctly
"NEW PASSWORD"	To enter a new password
"CONFIRM PWD"	To enter the new password again for confirmation

4 Set the password

Press the [ENTER/▶] button.



- The password's initial value is "3308".

Initializing

Resets (or initializes) the parameters you have set by "DVD Setup" to the original status when the deck was shipped from the plant.

1 Select the "DEFAULTS"

See 'Setting the Preferences' (page 28) to select "DEFAULTS".

2 Select the "RESET"

Select "RESET" and press the [ENTER/▶] button.

3 Enter the password

Press the number buttons.

4 Initializes the parameters you have set

Press the [ENTER/▶] button.



- The DVD setup values are NOT initialized even when the Reset button of the unit is pressed.

Menu system

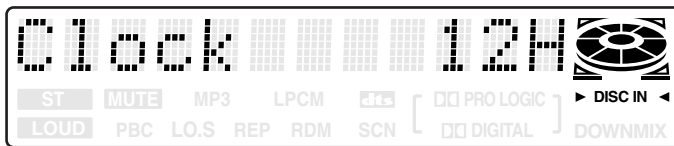
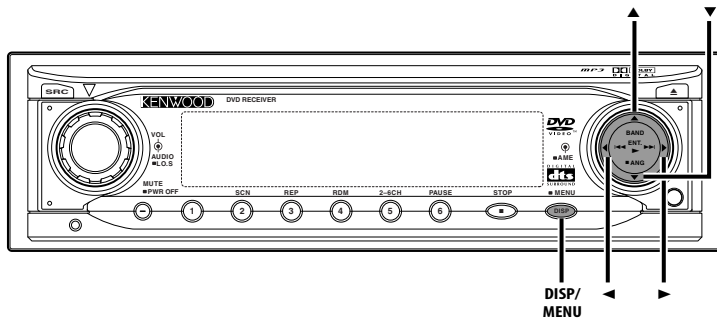

Menu System

Setting during operation beep sound etc. functions.

1 Switches to a display mode other than Clock Display.

Press the [DISP] button.

Displays the frequency, play time, or AUX.

2 Enter Menu mode

Press the [MENU] button for at least 1 second.

3 Select the menu item

Press the [◀] or [▶] button.

4 Set the menu item

Press the [▲] or [▼] button.

5 Exit Menu mode

Press the [MENU] button.



- When operation stops for 5 seconds, the Menu mode closes.

Clock Display

Select the Clock Display mode as follows.

Display	Setting
"Clock 12H"	Sets the 12-hour system time display.
"Clock 24H"	Sets the 24-hour system time display.

Touch Sensor Tone

Setting the operation check sound (beep sound) ON/OFF.

Display	Setting
"Beep ON"	Beep is heard.
"Beep OFF"	Beep canceled.

Line Mute

When the phone is called or when the Voice Guidance of navigation system starts, the audio sound is muted.

Display	Setting
"LINEMUTE ON"	Mutes the sound.
"LINEMUTE OFF"	Does not mute the sound.

Contrast Adjustment

Adjusting the display contrast.

Display and Setting
"Contrast 00"
⋮
"Contrast 07"

Basic Operations of remote

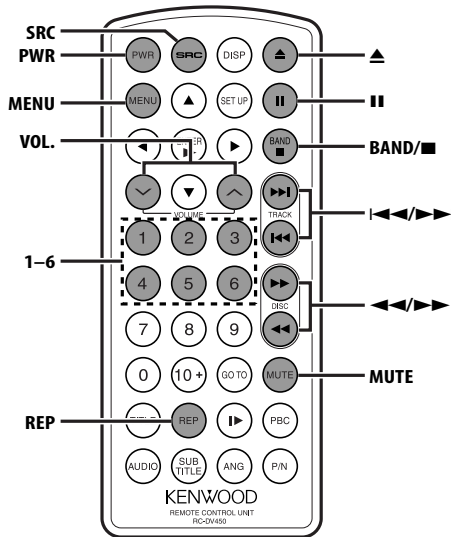

Loading and Replacing the battery

Use one lithium battery (CR2025).

Insert the batteries with the + and – poles aligned properly, following the illustration inside the case.

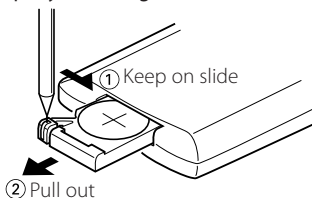

⚠ WARNING

- Store unused batteries out of the reach of children. Contact a doctor immediately if the battery is accidentally swallowed.



- Do not set the remote on hot places such as above the dashboard.

Basic operations

[PWR] button

Turning OFF the Power



- Turn on the power by pressing the switch on the main unit. The remote controller cannot be used. (Page 14)

[VOL.] buttons

Adjusting the volume.

[SRC] button

Each time the button is pressed the source switches.

For the source switching order refer to 'Selecting the Source' (page 10).

[MUTE] button

Turning the volume down quickly.

When it is pressed again it returns to the previous level.

In Tuner source

[BAND/■] buttons

Select the band.

Each time the button is pressed it switches between the FM1, FM2, FM3, AM1, and AM2 bands.

[◀◀]/ [▶▶] buttons

Tune the station having better receiving signals automatically.

[◀◀]/ [▶▶] buttons

Tune the receiving station manually.

The receiving frequency is increased for one step each time you press the button.

[0] — [6] buttons

Press buttons [1] — [6] to recall preset stations.

In Disc source

[◀◀]/ [▶▶] buttons

Doing chapter/track/file forward and backward.

[◀◀]/ [▶▶] buttons

Fast Forwarding and Reversing.

Setting	Display
2 times	"FF 2X" / "FR 2X"
4 times	"FF 4X" / "FR 4X"
6 times	"FF 6X" / "FR 6X"
8 times	"FF 8X" / "FR 8X"
Normal play	"PLAY"

[II] button

Each time the button is pressed the song pauses and plays.

[▲] button

Ejects the disc by opening the panel.
Also, closes the panel.

[BAND/■] button

When pressed, the DVD deck memories the current playback position and stops. When pressed again, the memory position is erased. The VCD/CD-DA/MP3 stops to play back.

[MENU] button

When pressed, the DVD displayed the Title Menu.

For details, see the 'Using DVD Menu' section (page 20).

When pressed, the VCD/CD-DA starts "Track Scan." For details, see the 'Track Scan' section (page 17).

[REP] button







Starts the "Repeat Play". For details, see the 'Repeat Play' section (page 16).

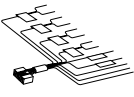

- This is the explanation of basic system operations. For advanced system functions, see the 'DVD/VCD/CD-DA/MP3 features of Remote' section (page 19).

Accessories/ Installation Procedure

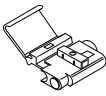
Accessories

①	1
②	2
③	4
④	4
⑤	1
⑥	1
⑦	1

Installation Procedure

1. To prevent a short circuit, remove the key from the ignition and disconnect the ⊖ battery.
2. Make the proper input and output wire connections for each unit.
3. Connect the speaker wires of the wiring harness.
4. Connect the wiring harness wires in the following order: ground, battery, ignition.
5. Connect the wiring harness connector to the unit.
6. Install the unit in your car.
7. Reconnect the ⊖ battery.
8. Press the reset button.

▲WARNING

If you connect the ignition wire (red) and the battery wire (yellow) to the car chassis (ground), you may cause a short circuit, that in turn may start a fire. Always connect those wires to the power source running through the fuse box.



- If your car's ignition does not have an ACC position, connect the ignition wires to a power source that can be turned on and off with the ignition key. If you connect the ignition wire to a power source with a constant voltage supply, as with battery wires, the battery may die.
- If the console has a lid, make sure to install the unit so that the faceplate will not hit the lid when closing and opening.
- If the fuse blows, first make sure the wires aren't touching to cause a short circuit, then replace the old fuse with one with the same rating.
- Insulate unconnected wires with vinyl tape or other similar material. To prevent a short circuit, do not remove the caps on the ends of the unconnected wires or the terminals.
- Connect the speaker wires correctly to the terminals to which they correspond. The unit may be damaged or fail to work if you share the ⊖ wires or ground them to any metal part in the car.
- When only two speakers are being connected to the system, connect the connectors either to both the front output terminals or to both the rear output terminals (do not mix front and rear). For example, if you connect the ⊕ connector of the left speaker to a front output terminal, do not connect the ⊖ connector to a rear output terminal.
- After the unit is installed, check whether the brake lamps, blinkers, wipers, etc. on the car are working properly.
- Mount the unit so that the mounting angle is 30° or less.

Connecting Wires to Terminals

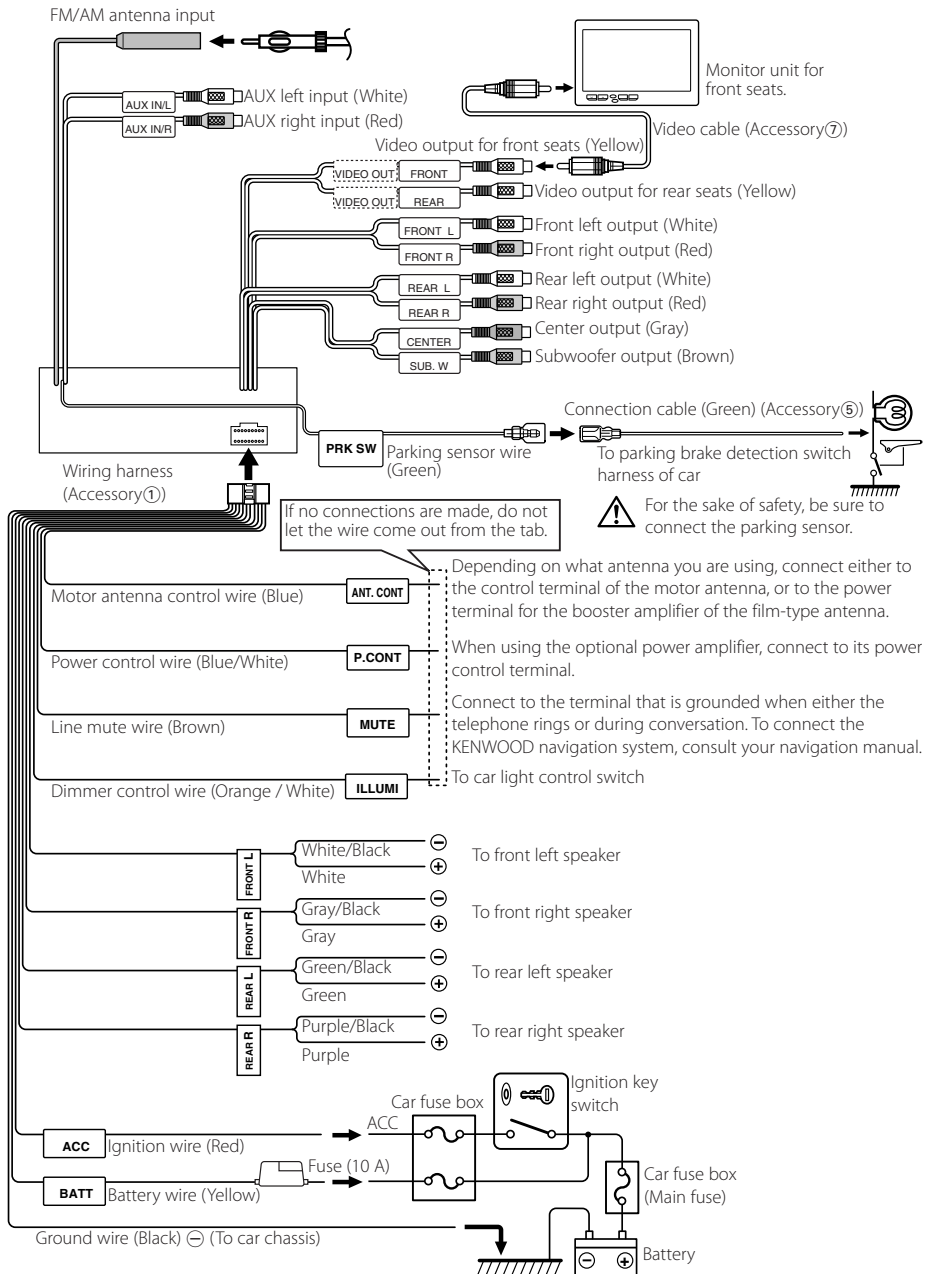

Using the Relay Connector (Accessory ⑥)

- 1 Plug the vehicle's harness into the relay connector.
- 2 Plug the parking brake detection wire into the relay connector.

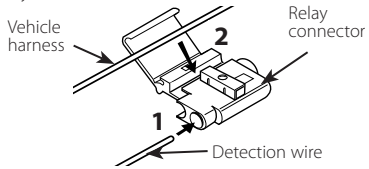

- 3 Lock the cable clamp.

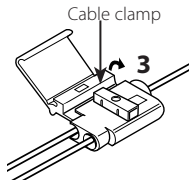

- 4 Press down using pliers until the conductive metal is even with the plastic surface.
- 5 Lock the lid.

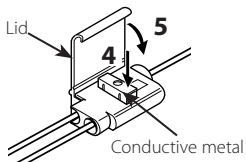

Installation

non-Japanese cars

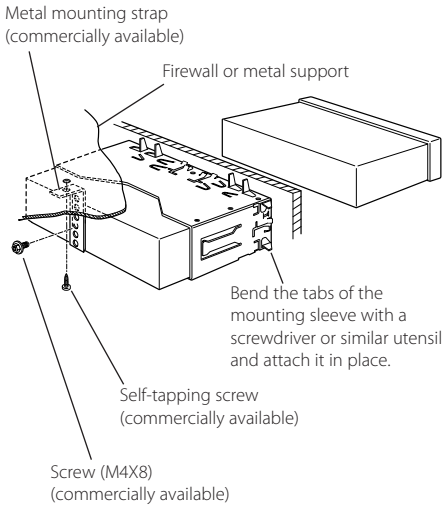

- Make sure that the unit is installed securely in place. If the unit is unstable, it may malfunction (for example, the sound may skip).

Japanese cars

- 1 Refer to the section 'Removing the hard rubber frame' (page 38) and then remove the hard rubber frame.
- 2 Align the holes in the unit (two locations on each side) with the vehicle mounting bracket and secure the unit with the accessory screws.

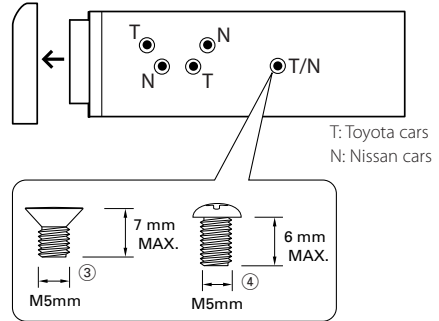

Accessory ③...for Nissan car
Accessory ④...for Toyota car



- During installation, do not use any screws except for those provided. The use of different screws might result in damage to the main unit.
- Damage may occur if a screwdriver or similar tool is used with excessive force during the installations.

Removing the Unit

Removing the hard rubber frame

- 1 Upper the frame and pull it forward as shown in the figure.

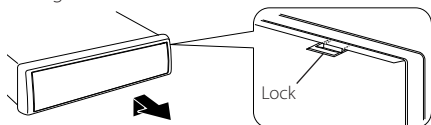

- 2 When the upper level is removed, remove the lower two locations.

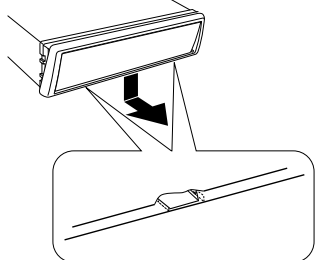

- The frame can be removed from the bottom side in the same manner.
- When you mount the "hard rubber frame," take care to face its upward and downward sides correctly. The side having closer claws must face upward, and the one having wider claws must face downward.

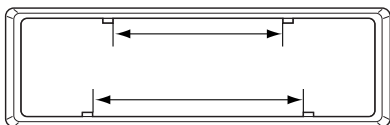

Removing the Unit

- 1 Refer to the section 'Removing the hard rubber frame' (page 38) and then remove the hard rubber frame.
- 2 Remove the screw (M4 × 8) on the back panel.
- 3 Insert the two removal tools deeply into the slots on each side, as shown.

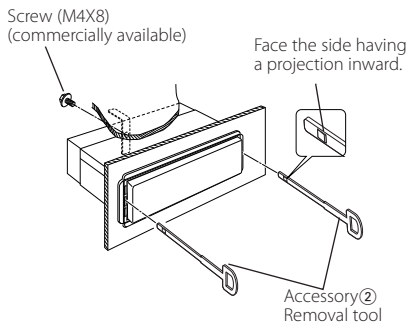

- Be careful to avoid injury from the catch pins on the removal tool.
- 4 Pull the unit all the way out with your hands, being careful not to drop it.

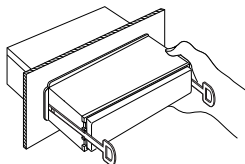

Troubleshooting Guide

What might seem to be a malfunction in your unit may just be the result of slight misoperation or miswiring. Before calling service, first check the following table for possible problems.

General

? The power does not turn ON.

- ✓ The fuse has blown.
 - ⓘ After checking for short circuits in the wires, replace the fuse with one with the same rating.
- ✓ Speaker cable touches on chassis etc.
 - ⓘ Wire or insulate the speaker cable properly and press the reset button.

? There's a source you can't switch.

- ✓ There's no media inserted.
 - ⓘ Set the media you want to listen to. If there's no media in this unit, you can't switch to each source.

? No video image appears.

- ✓ The unit is not connected to the parking brake detection switch.
 - ⓘ Make proper connections according to 'Connecting Wires to Terminals'.
- ✓ The parking brake is not engaged.
 - ⓘ For safety reasons no video images are displayed while the vehicle is moving. Engaging the parking brake will cause images to be displayed.
- ✓ The setting of the NTSC/PAL switch is incorrect.
 - ⓘ Set the NTSC/PAL switch correctly.

? Nothing happens when the buttons are pressed.

- ✓ The "H" symbol appears in the screen.
 - ⓘ You cannot carry out any operation disabled by disc.

? The memory is erased when the ignition is turned OFF.

- ✓ The ignition and battery wire are incorrectly connected.
 - ⓘ Connect the wire correctly, referring to the section on 'Connecting Wires to Terminals'.

? No sound can be heard, or the volume is low.

- ✓ The fader or balance settings are set all the way to one side.
 - ⓘ Center the fader and balance settings.
- ✓ The input/output wires or wiring harness are connected incorrectly.
 - ⓘ Reconnect the input/output wires or the wiring harness correctly. See the section on 'Connecting Wires to Terminals'.

? The sound quality is poor or distorted.

- ✓ One of the speaker wires is being pinched by a screw in the car.
 - ⓘ Check the speaker wiring.
- ✓ The speakers are not wired correctly.
 - ⓘ Reconnect the speaker wires so that each output terminal is connected to a different speaker.

? The Touch Sensor Tone doesn't sound.

- ✓ The preout jack is being used.
 - ⓘ The Touch Sensor Tone can't be output from the preout jack.

? The Line mute function does not work.

- ✓ The Line mute wire is not connected properly.
 - ⓘ Connect the wire correctly, referring to the section on 'Connecting Wires to Terminals'.

? The Line mute function turns ON even though the Line mute wire is not connected.

- ✓ The Line mute wire is touching a metal part of the car.
 - ⓘ Pull the Line mute wire away from the metal part of the car.

Tuner source

? Radio reception is poor.

- ✓ The car antenna is not extended.
 - ⓘ Pull the antenna out all the way.
- ✓ The antenna control wire is not connected.
 - ⓘ Connect the wire correctly, referring to the section on 'Connecting Wires to Terminals'.
- ✓ The local seek is turned on.
 - ⓘ Turn off the local seek. (page 14)

Disc source

? The specified disc does not play, but another one plays instead.

- ✓ The specified DVD/CD is quite dirty.
 - ⓘ Clean the DVD/CD.
- ✓ The disc is loaded in a different slot from that specified.
 - ⓘ Eject the disc magazine and check the number for the specified disc.
- ✓ The disc is severely scratched.
 - ⓘ Try another disc instead.

? The disc won't insert.

- ✓ There's already another disc inserted.
 - ⓘ Press the [▲] button and remove the disc.

Troubleshooting Guide

? A VCD cannot be played using menus.

- ✓ The VCD disc being played is not compatible with P.B.C.
 - ☞ Menu playback is available only with VCD discs recorded with P.B.C.

? The subtitle is not displayed.

- ✓ The DVD disc being played does not contain the recording of subtitles.
 - ☞ The subtitle cannot be displayed when the DVD disc being played does not contain the recording of subtitles.

? The voice (or subtitle) language cannot be changed.

- ✓ The DVD disc being played does not contain the recording of more than one audio (or subtitle) language.
 - ☞ The voice (or subtitle) language cannot be changed when the DVD disc being played does not contain the recording of more than one voice (or subtitle) language.

? The viewing angle cannot be changed.

- ✓ The DVD disc being played does not contain the recording of more than one angle.
 - ☞ The viewing angle cannot be changed when the DVD disc being played does not contain the recording of more than one angle.
- ✓ You are attempting to switch the angle in a DVD section where more than one angle is not recorded.
 - ☞ More than one viewing angle may be recorded only in limited sections in a disc.

? Playback will not start even after a title is selected.

- ✓ A viewing restriction (RATING) has been set for the disc.
 - ☞ Check the viewing restriction level (RATING) setting.

? The voice or subtitle language selected in the initial setting is not played.

- ✓ The DVD disc being played does not contain the recording of the selected voice or subtitle language.
 - ☞ Use a DVD disc containing the recording of the selected voice or subtitle language.

MP3 source

? Cannot play an MP3/WMA.

- ✓ The media is scratched or dirty.
 - ☞ Clean the media, referring to the CD cleaning of the section on 'About DVD/CDs' (page 8).

? The sound skips when an MP3 is being played.

- ✓ The media is scratched or dirty.
 - ☞ Clean the media, referring to the CD cleaning of the section on 'About DVD/CDs' (page 8).
- ✓ The recording condition is bad.
 - ☞ Record the media again or use another media.

? The MP3 track time isn't displayed correctly.

- ✓ ---
 - ☞ There are times when it isn't displayed correctly according to the MP3 recording conditions.

The messages shown below display your systems condition.

- No Disc: The DVD/CD is quite dirty. The DVD/CD is upside-down. The DVD/CD is scratched a lot.
☞ Clean the DVD/CD and load it correctly.
☞ No DVD/CD in the unit.
☞ Insert the DVD/CD.
- Disc Error: The DVD/CD is quite dirty. The DVD/CD is upside-down. The DVD/CD is scratched a lot.
☞ Clean the DVD/CD and load it correctly.
- Unknown Disc: The disc of this format cannot be played back.
- Region Error: The DVD software encoded for other region code.
- Loading: The unit is reading the data on the disc.
- Error: The DVD/CD mechanism does not operate normally.
☞ Hold down [▲] button more than 5 seconds, and the DVD/CD mechanism will be reset.
- Mecha Error: The unit is malfunctioning for some reason.
☞ Press the reset button on the unit. If the "Mecha Error" code does not disappear, consult your nearest service center.

Specifications

Specifications subject to change without notice.

FM tuner section

- Frequency range (50 kHz space)
 - : 87.5 MHz – 108.0 MHz
- Usable sensitivity (S/N = 30dB)
 - : 9.3dBf (0.8 μ V /75 Ω)
- Quieting Sensitivity (S/N = 50dB)
 - : 15.2dBf (1.6 μ V /75 Ω)
- Frequency response (\pm 3.0 dB)
 - : 30 Hz – 15 kHz
- Signal to Noise ratio (MONO)
 - : 70 dB
- Selectivity (\pm 400 kHz)
 - : \geq 70 dB
- Stereo separation (1 kHz)
 - : 30 dB

AM tuner section

- Frequency range (9 kHz space)
 - : 531 kHz – 1611 kHz
- Usable sensitivity (S/N = 20dB)
 - : 28 dB μ (25 μ V)

DVD/CD player section

- D/A Converter
 - : 8 Level $\Delta\Sigma$
- Wow & Flutter
 - : Below Measurable Limit
- Frequency response
 - : 20 Hz – 30 kHz (Sampling frequency; 96 kHz)
- Total harmonic distortion (1 kHz)
 - : 0.01 %
- Signal to Noise ratio
 - : 110 dB
- Dynamic range
 - : 90 dB
- MP3 decode
 - : Compliant with MPEG-1/2 Audio Layer-3
- Disc format
 - : DVD-VIDEO / VIDEO CD / CD-DA / MP3

Audio section

- Maximum output power
 - : 40 W \times 4
- Full Bandwidth Power (4 Ω , 1 kHz, 10% THD)
 - : 28 W \times 4
- Tone action
 - Bass : 100 Hz \pm 10 dB
 - Treble : 10 kHz \pm 10 dB
- Video output level
 - : 1 Vp-p/75 Ω
- Audio output level (during disc play)
 - : 1800 mV/10 k Ω

Auxiliary input

- Frequency response (\pm 1 dB)
 - : 20 Hz – 20 kHz
- Input Maximum Voltage
 - : 1500 mV
- Input Impedance
 - : 55 k Ω

General

- Operating voltage (11 – 16V allowable)
 - : 14.4 V
- Current consumption
 - : 10 A
- Installation Size (W x H x D)
 - : 178 x 50 x 165 mm
- Weight
 - : 1.90 kg

KENWOOD

Free Manuals Download Website

<http://myh66.com>

<http://usermanuals.us>

<http://www.somanuals.com>

<http://www.4manuals.cc>

<http://www.manual-lib.com>

<http://www.404manual.com>

<http://www.luxmanual.com>

<http://aubethermostatmanual.com>

Golf course search by state

<http://golfingnear.com>

Email search by domain

<http://emailbydomain.com>

Auto manuals search

<http://auto.somanuals.com>

TV manuals search

<http://tv.somanuals.com>