

# KENWOOD

**KVT-837DVD**

**KVT-847DVD**

**KVT-867DVD**

**KVT-737DVD**

**KVT-747DVD**

**KVT-767DVD**

---

MONITOR WITH DVD RECEIVER

## **INSTALLATION MANUAL**

附 DVD 接收機顯示器

**安裝說明書**

附 DVD 接收机显示器

**安装说明书**

DVD 수신기장착 모니터

**설치 설명서**

Kenwood Corporation

# Accessories

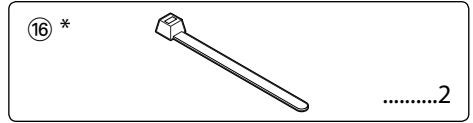
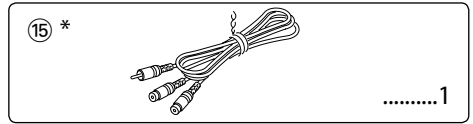
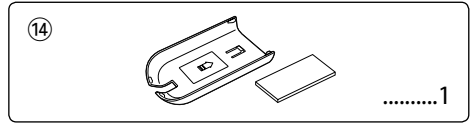
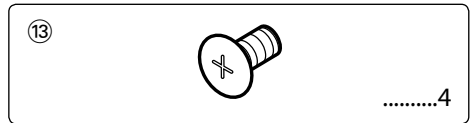
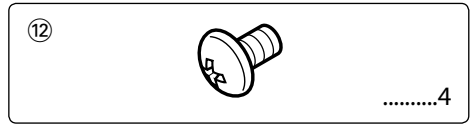
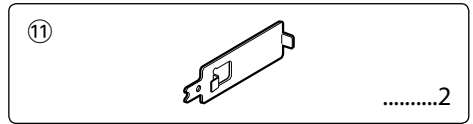
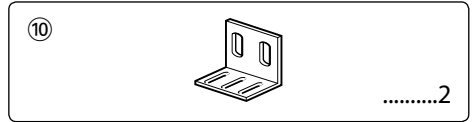
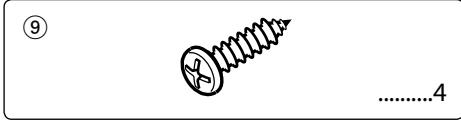
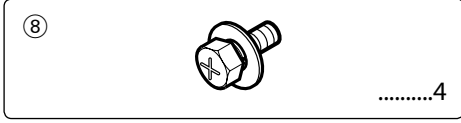
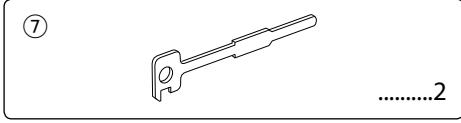
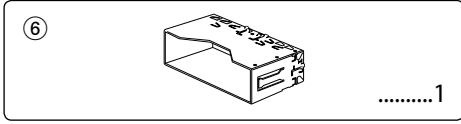
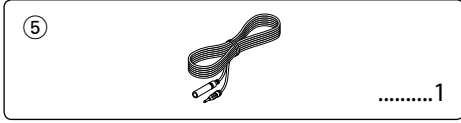
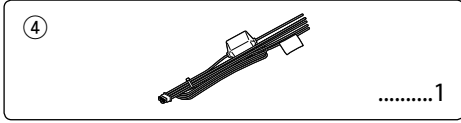
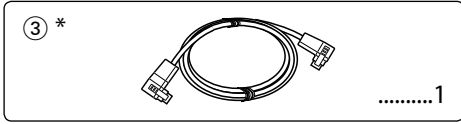
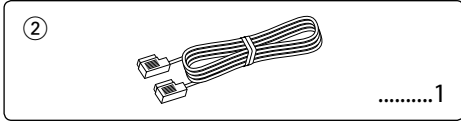
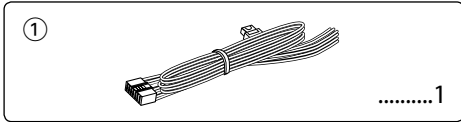

\* KVT-837DVD/847DVD/867DVD only

## Installation Procedure

- 1.To prevent a short circuit, remove the key from the ignition and disconnect the ⊖ battery.
- 2.Make the proper input and output wire connections for each unit.
- 3.Connect the speaker wires of the wiring harness.
- 4.Connect the wiring harness wires in the following order: ground, battery, ignition.
- 5.Connect the wiring harness connector to the unit.
- 6.Install the unit in your car.
- 7.Reconnect the ⊖ battery.
- 8.Press the reset button.

### ▲WARNING

- If you connect the ignition wire (red) and the battery wire (yellow) to the car chassis (ground), you may cause a short circuit, that in turn may start a fire. Always connect those wires to the power source running through the fuse box.
- Do not cut out the fuse from the ignition wire (red) and the battery wire (yellow). The power supply must be connected to the wires via the fuse.

### ▲CAUTION

- If the power is not turned ON (or it is ON, but will be OFF immediately), the speaker wire may have a short-circuit or touched the chasis of the vehicle and the protection function may have been activated. Therefore, the speaker wire should be checked.
- If your car's ignition does not have an ACC position, connect the ignition wires to a power source that can be turned on and off with the ignition key. If you connect the ignition wire to a power source with a constant voltage supply, as with battery wires, the battery may die.
- If the console has a lid, make sure to install the unit so that the faceplate will not hit the lid when closing and opening.
- If the fuse blows, first make sure the wires aren't touching to cause a short circuit, then replace the old fuse with one with the same rating.
- Insulate unconnected wires with vinyl tape or other similar material. To prevent a short circuit, do not remove the caps on the ends of the unconnected wires or the terminals.
- Connect the speaker wires correctly to the terminals to which they correspond. The unit may be damaged or fail to work if you share the ⊖ wires or ground them to any metal part in the car.
- When only two speakers are being connected to the system, connect the connectors either to both the front output terminals or to both the rear output terminals (do not mix front and rear). For example, if you connect the ⊕ connector of the left speaker to a front output terminal, do not connect the ⊖ connector to a rear output terminal.
- After the unit is installed, check whether the brake lamps, blinkers, wipers, etc. on the car are working properly.
- Mount the unit so that the mounting angle is 30° or less.

# Connection

**!** When handling an optical cable for wiring, use care not to exceed the minimum cable bend radius of 30 mm. If you exceed the minimum bend limit, optical fibers within the optical cable may be damaged.



An Optical cable (Accessory ③) is fixed with a chassis using harness band (Accessory ⑫). (KVT-837DVD/847DVD/867DVD only)

For the sake of safety, be sure to connect the parking sensor.

Connect to the vehicle's parking brake detection switch harness using the supplied relay connector.

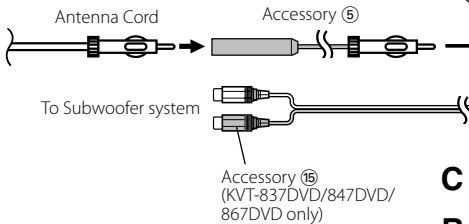
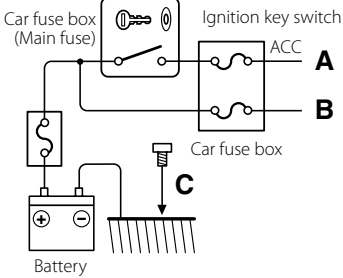
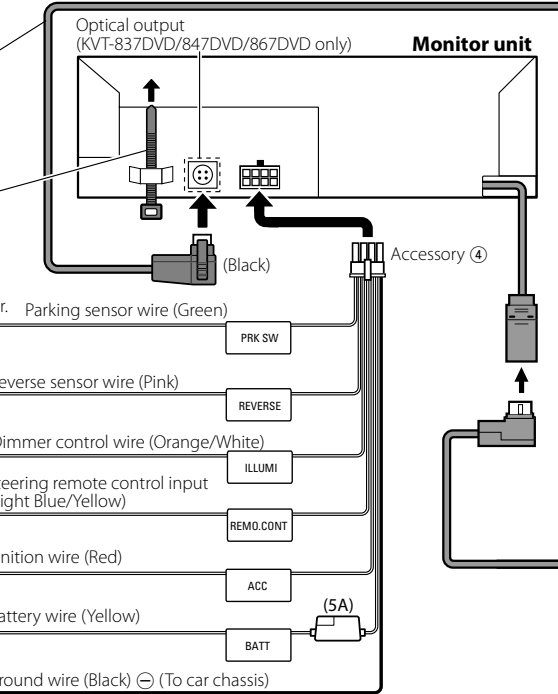
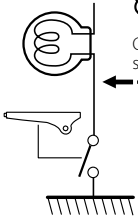

Connect to the terminal that is grounded when either the telephone rings or during conversation.

To connect the Kenwood navigation system, consult your navigation manual.

Depending on what antenna you are using, connect either to the control terminal of the motor antenna, or to the power terminal for the booster amplifier of the film-type antenna.

When using the optional power amplifier, connect to its power control terminal.

To "EXT.AMP.CONT." terminal of the amplifier having the external amp control function.

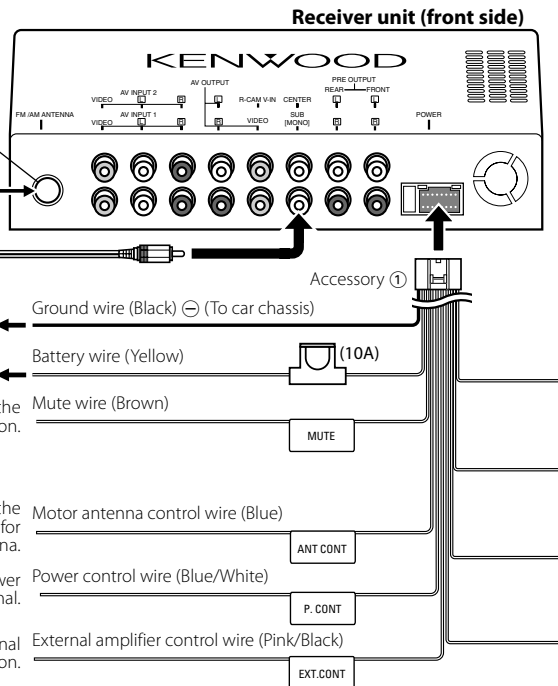

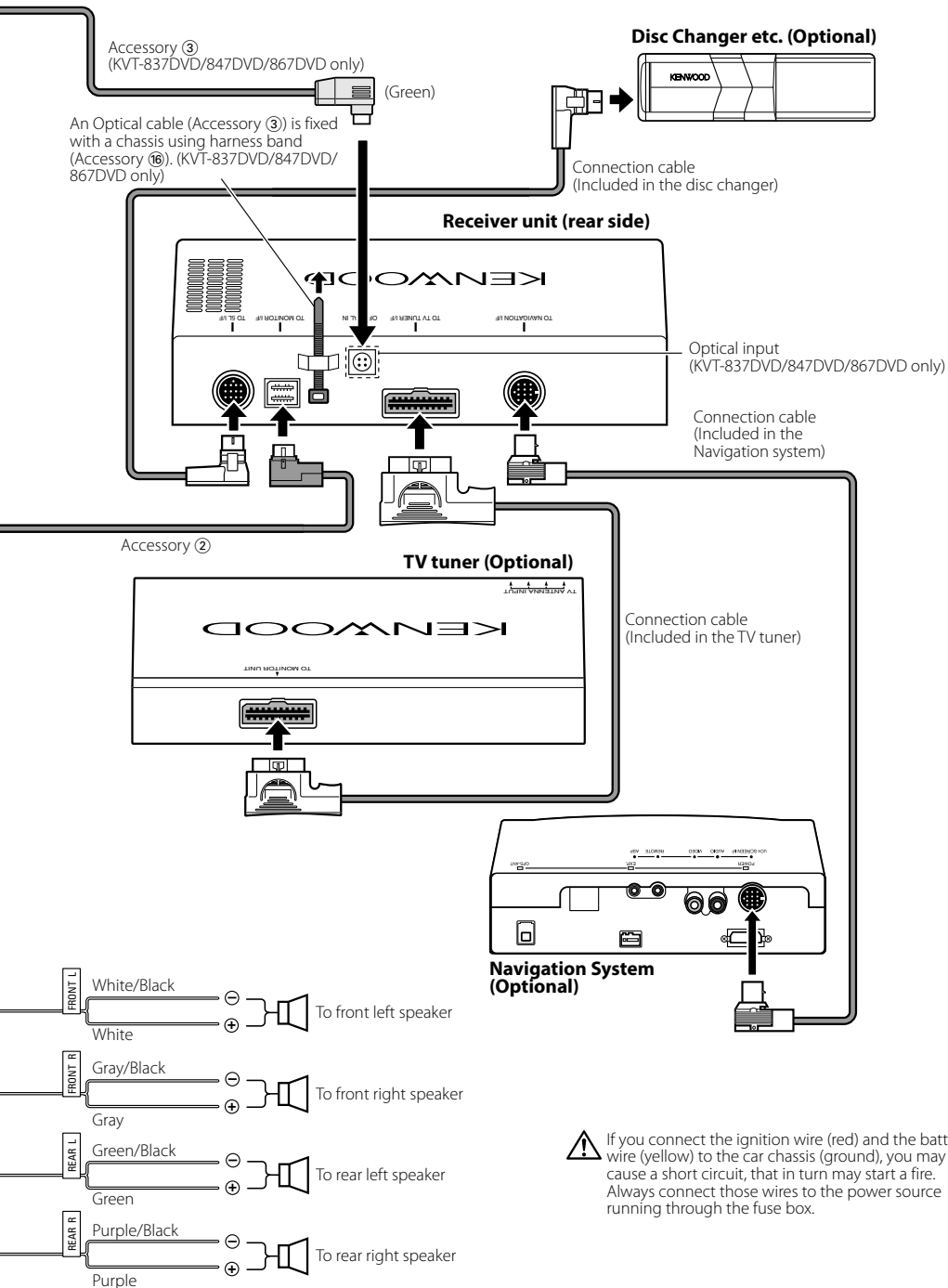

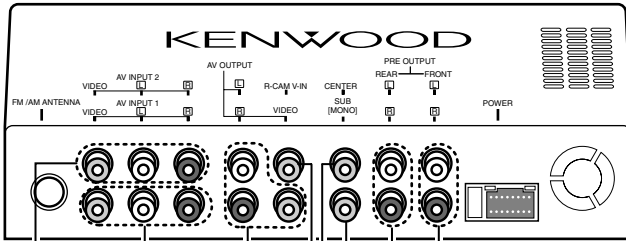

■ **Front Preout**

- Audio left output (White)
- Audio right output (Red)

■ **Rear Preout**

- Audio left output (White)
- Audio right output (Red)

■ **Subwoofer (MONO) Preout**

You can use Accessory 15 when to connect the subwoofer system input terminals is stereo.

■ **Center Preout**

■ **Rear View Camera Input**

- Visual input (Yellow)

■ **Audio/Visual Output**

- Visual output (Yellow)
- Audio left output (White)
- Audio right output (Red)

■ **Audio/Visual input 1**

- Visual input (Yellow)
- Audio left input (White)
- Audio right input (Red)

■ **Audio/Visual input 2**

- Visual input (Yellow)
- Audio left input (White)
- Audio right input (Red)

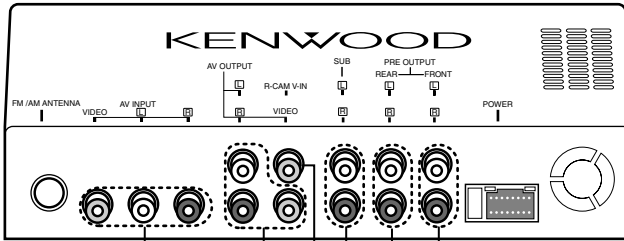

■ **Front Preout**

- Audio left output (White)
- Audio right output (Red)

■ **Rear Preout**

- Audio left output (White)
- Audio right output (Red)

■ **Subwoofer Preout**

- Audio left output (White)
- Audio right output (Red)

■ **Rear View Camera Input**

- Visual input (Yellow)

■ **Audio/Visual Output**

- Visual output (Yellow)
- Audio left output (White)
- Audio right output (Red)

■ **Audio/Visual input**

- Visual input (Yellow)
- Audio left input (White)
- Audio right input (Red)

## Installation for Monitor Unit

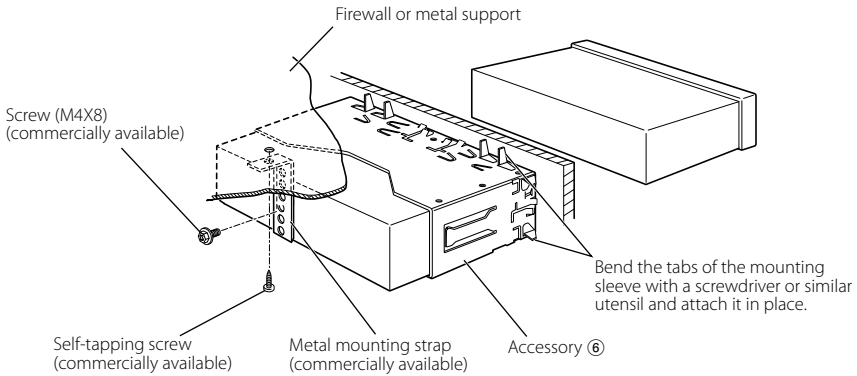

Make sure that the unit is installed securely in place. If the unit is unstable, it may malfunction (eg, the sound may skip).

## Installation for Receiver unit

1. Attach the installation brackets ⑩ to the sides of the hideaway unit using the sems bolts ⑧.

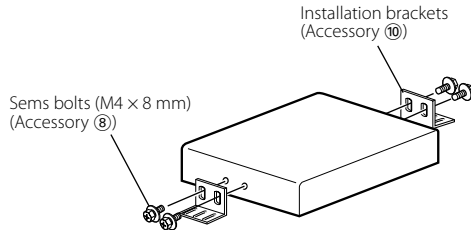

2. Use the tapping screw ⑨ to secure the hideaway unit to the audio board.

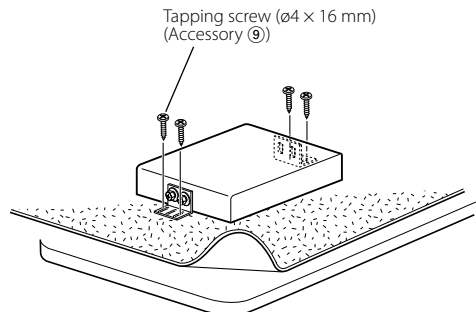





# Removing Monitor Unit

## ■ Removing the Hard Rubber Frame (escutcheon)

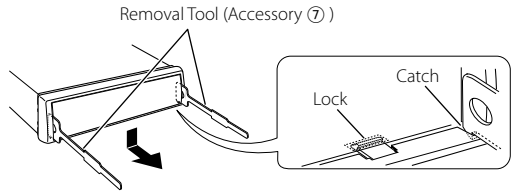
1. Engage the catch pins on the removal tool (7) and remove the two locks on the lower level. Lower the frame and pull it forward as shown in the figure.



2. When the lower level is removed, remove the upper two locations.

 The frame can be removed from the top side in the same manner.

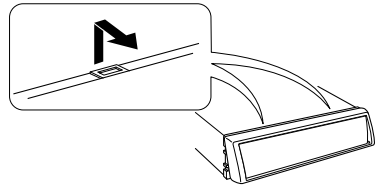

## ■ Removing the Unit

1. Refer to the section <Removing the Hard Rubber Frame> and then remove the hard rubber frame.
2. Remove the Hex-head screw with integral washer (M4 × 8) on the back panel.
3. Insert the two removal tools (7) deeply into the slots on each side, as shown.

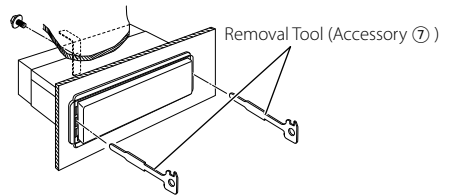

4. Lower the removal tool toward the bottom, and pull out the unit halfway while pressing towards the inside.

 Be careful to avoid injury from the catch pins on the removal tool.

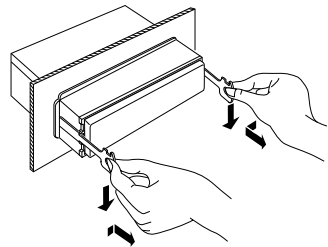

5. Pull the unit all the way out with your hands, being careful not to drop it.

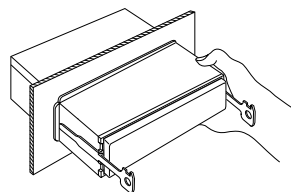

# Installing in Japanese-Made Cars

## ■ Installation on Toyota, Nissan or Mitsubishi Car using Brackets at Holes shown by "●"

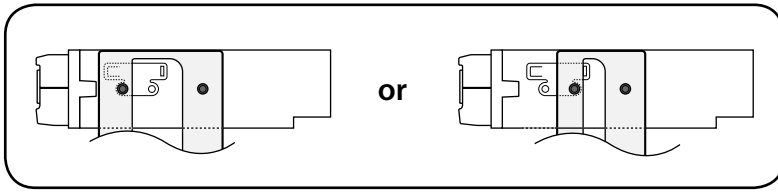

Accessory ⑫ (M5x6mm)  
or Accessory ⑬ (M5x7mm)

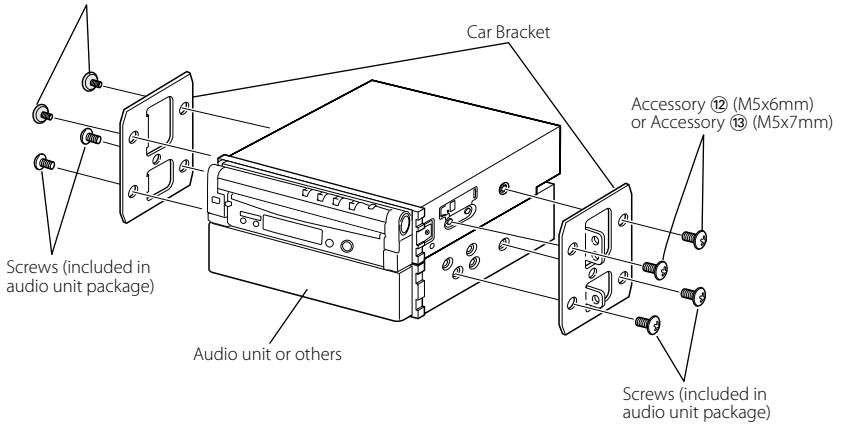

## ■ Installation on Toyota Car using Brackets at Holes shown by "●"

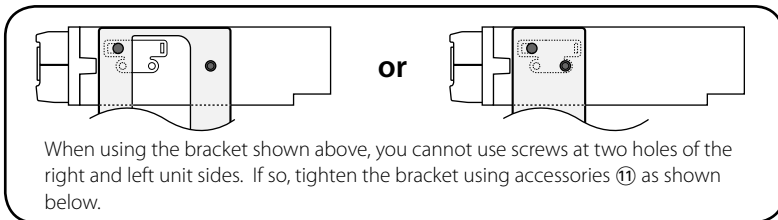

1. Use accessories ⑪ at both sides as shown.

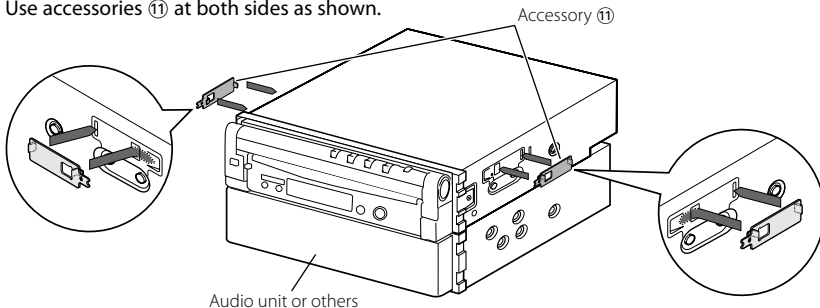

## 2. Mount the bracket at each side.

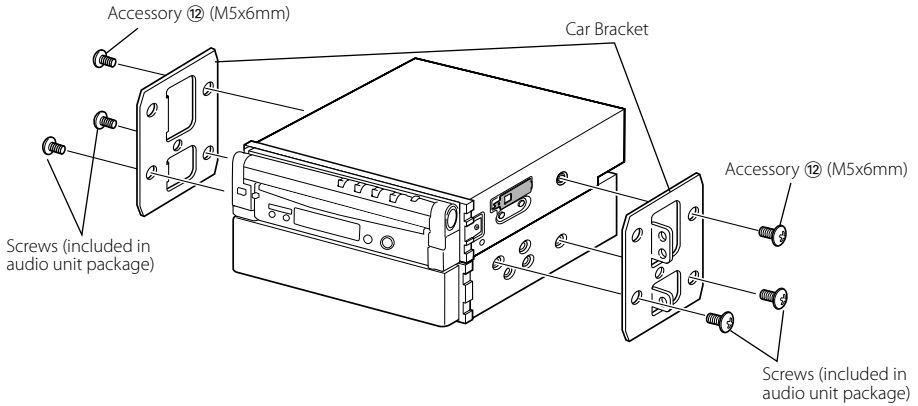

## 3. Bend each end of accessory 11 to fix the bracket.

Use a flat-blade screwdriver or pliers, and bend each accessory tab into the hole of installation bracket to fix the bracket.

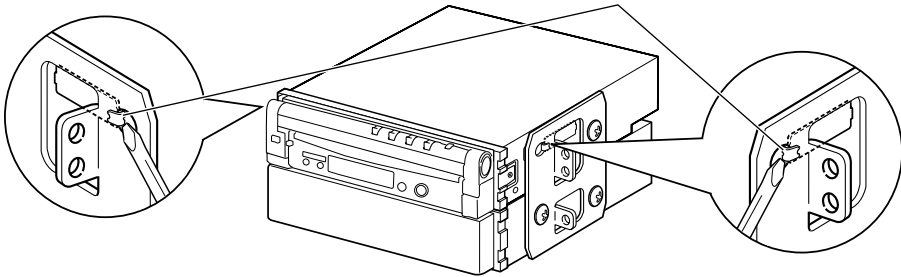

## Installation of Remote control unit

### ■ Install the remote control unit holder (Accessory 14).

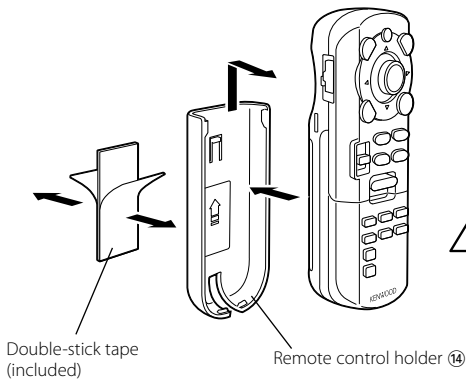

 To prevent the Remote control unit from dropping down under your foot, install it using the Remote control unit holder. If the Remote control unit drops down under driving pedals, it will interfere with your driving and may result in a traffic accident.

# 附件

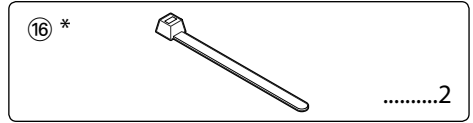
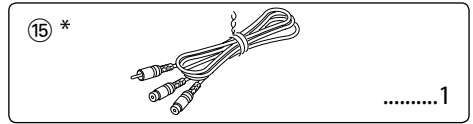
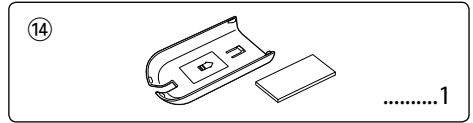
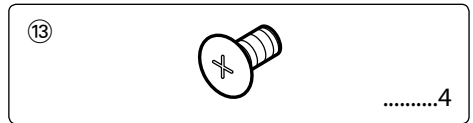
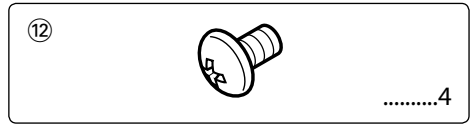
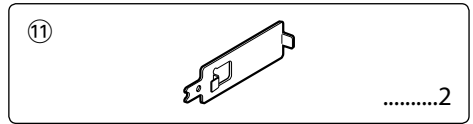
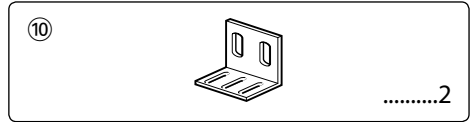
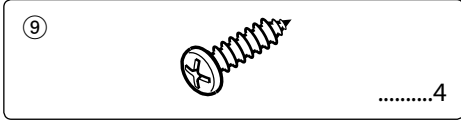
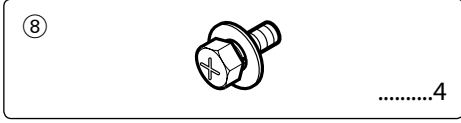
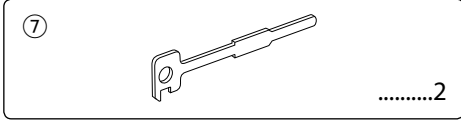
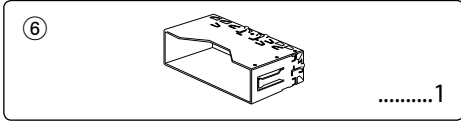
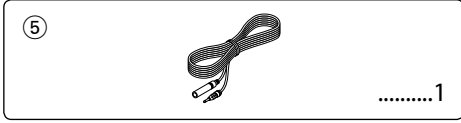
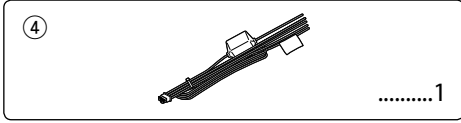
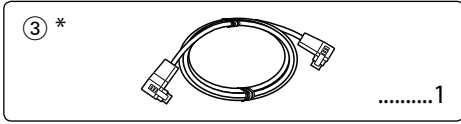
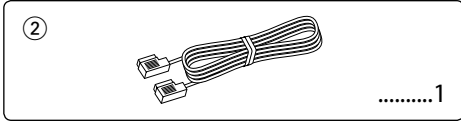
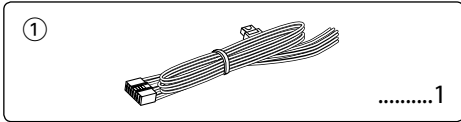

\* 僅限 KVT-837DVD/847DVD/867DVD

## 安裝程序

1. 為了防止短路，從點火開關中拔出鑰匙，拆下蓄電池的負極⊖接線。
2. 連接各裝置的輸入、輸出導線。
3. 連接電線束的揚聲器導線。
4. 按照接地導線、蓄電池導線和點火導線的順序連接電線束。
5. 將電線束的連接器連接到裝置上。
6. 將裝置安裝到汽車中。
7. 重新連接蓄電池的負極⊖接線。
8. 按下復位按鈕。

### ▲警告

- 如果您將點火裝置電線（紅色）和電池線（黃色）連接到汽車底盤（接地），您可能會導致短路，並造成火災。請始終將那些電線連接到經過保險絲盒的電源。
- 不得從點火導線（紅色）和蓄電池導線（黃色）上拆下保險絲。電源必須通過保險絲與導線連接。

### ▲注意

- 如果電源無法接通（或者雖然接通，但是立即斷開），揚聲器導線可能發生短路、或與汽車底盤接觸，保護功能可能動作。這時請檢查揚聲器導線。
- 如果汽車的點火裝置沒有ACC位置，請將點火導線與可以通過點火鑰匙接通和斷開的電源連接。如果將點火導線與始終供電的電源連接，例如與蓄電池導線連接，蓄電池將全部放電而無法使用。
- 如果控制台設有蓋板，在安裝時請注意、當關閉和打開面板時，不得與蓋板碰撞。
- 當保險絲燒斷時，請首先確認不應有引起短路的接觸，然後使用與舊保險絲相同規格的保險絲更換。
- 請用乙烯帶等絕緣物包裹未連接的導線。為了防止發生短路，不得取下未連接導線的線端或端子的護罩。
- 將揚聲器導線直接與對應的端子連接。如果共用負極⊖導線或者將其與汽車的金屬部件連接，本裝置可能損壞或者無法正常工作。
- 當祇有兩祇揚聲器與系統連接時，請將連接器或者與兩個前側輸出端子連接，或者與兩個後側輸出端子連接（不得將前側與後側混合連接）。例如，如果將左側揚聲器的正極⊕連接器與前側輸出端子連接，則不得將負極⊖連接器與後側輸出端子連接。
- 安裝結束後，請確認汽車制動器燈、方向指示燈和刮水器等是否正常動作。
- 本機安裝角度為30度以下為宜。

# 連接

**!** 在連接光纖線路時，請注意光纖的彎曲半徑不得小於 30mm。如超過最小彎曲限度，光纖中的光導纖維可能發生損壞。



使用線束卡 (附件 16) 將光纖 (附件 3) 與底盤固定。  
(僅限 KVT-837DVD/847DVD/867DVD)

**!** 為了安全、請確保連接手剎車傳感器。

使用配備的中繼連接器連接到汽車的手剎車檢測開關線束。

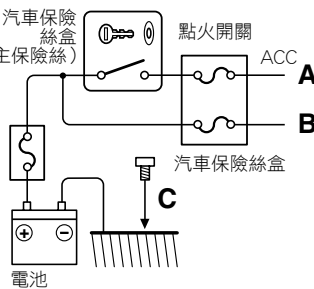
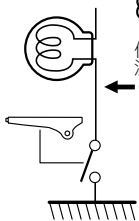

與汽車的倒車燈導線連接

連接到燈光控制開關

至操縱遙控器

**A** ← 點火裝置電線 (紅色)

**B** ← 電池線 (黃色)

**C** ← 接地線 (黑色) ⊖ (連接到汽車底盤)

光信號輸出  
(僅限 KVT-837DVD/847DVD/867DVD)

監視器

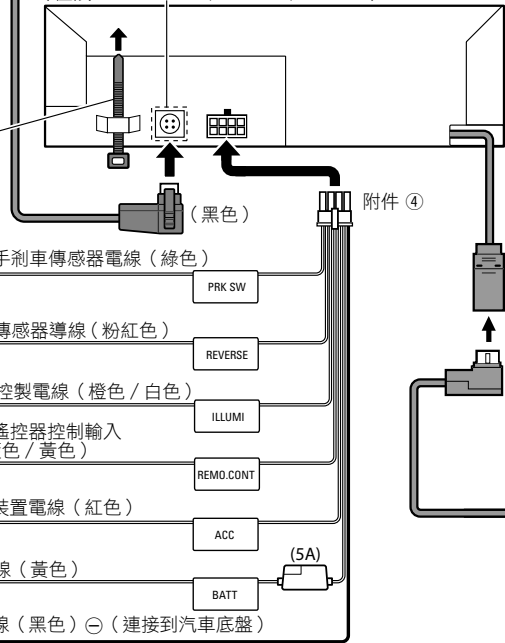

接收機 (前部)

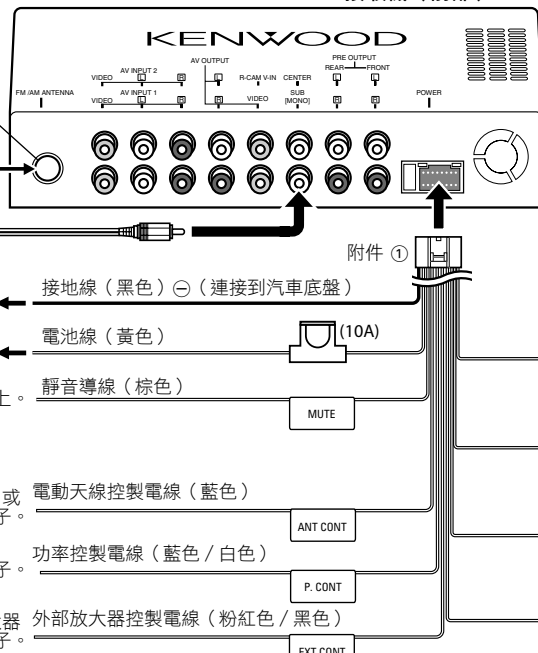

天線導線

FM/AM 天線輸入

至低音揚聲器系統

附件 15  
(僅限 KVT-837DVD/  
847DVD/867DVD)

連接到電話振鈴或通話時接地的端子上。

**!** 請參照導航系統的使用說明書、  
連接建伍導航系統。

根據您使用天線的情況、請連接到電動天線的控制端子、或  
者連接到薄膜型天線增強放大器的功率端子。

當使用選購的功率放大器時、請連接到它的功率控制端子。

連接到有外部放大器控制功能的放大器  
“EXT.AMP.CONT (外部放大器控制)” 端子。

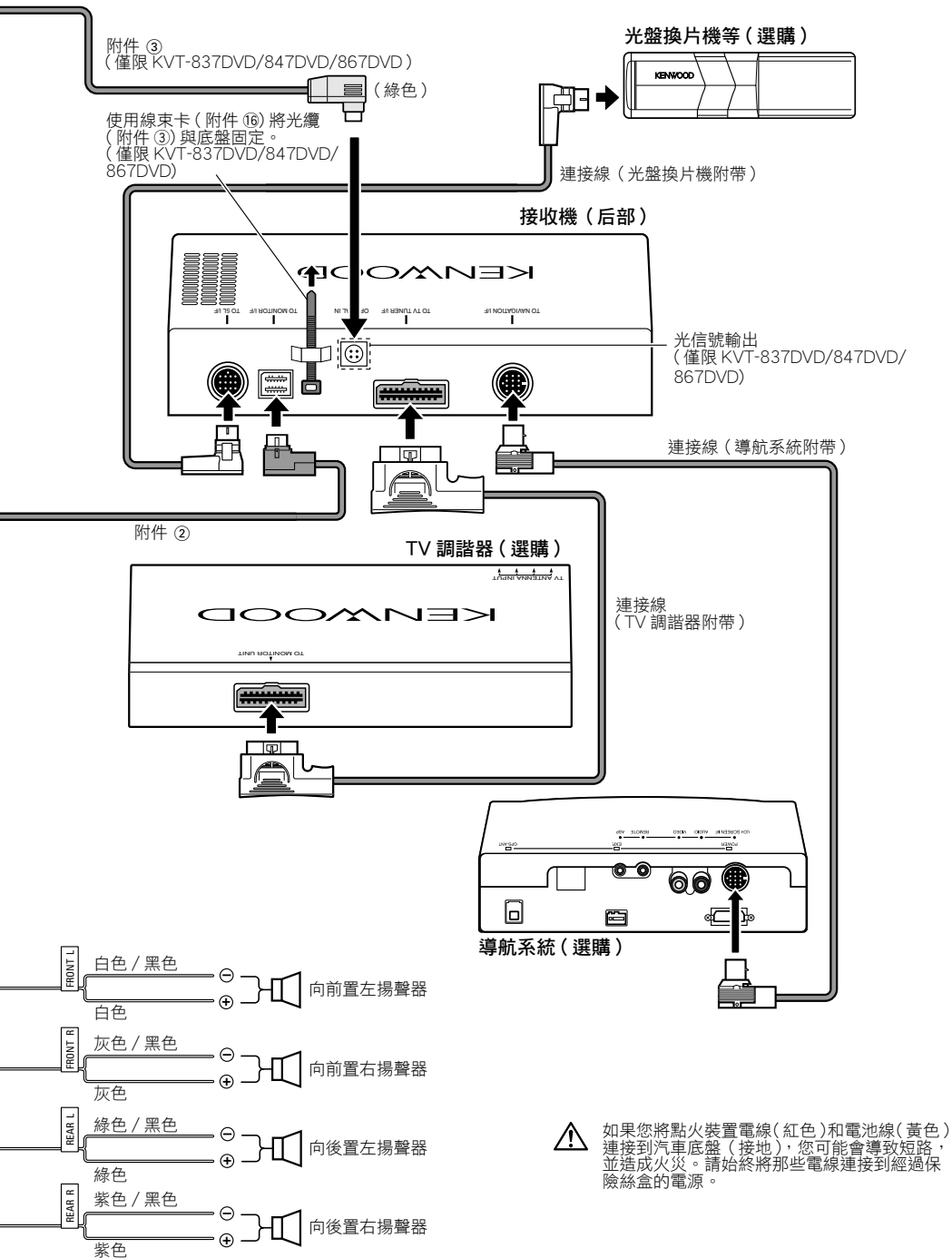

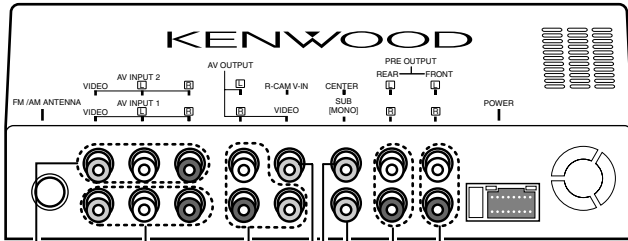

- 前預輸出
  - 音頻左輸出 (白色)
  - 音頻右輸出 (紅色)
- 后預輸出
  - 音頻左輸出 (白色)
  - 音頻右輸出 (紅色)
- 低音揚聲器 (單聲道) 預輸出  
當連接的低音揚聲器系統的輸入端子為立體聲時，可以使用附件 15。
- 中央預輸出
- 後視攝影機輸入
  - 視頻輸入 (黃色)
- 音頻 / 視頻輸出
  - 視頻輸入 (黃色)
  - 音頻左輸出 (白色)
  - 音頻右輸出 (紅色)
- 音頻 / 視頻輸入 1
  - 視頻輸入 (黃色)
  - 音頻左輸入 (白色)
  - 音頻右輸入 (紅色)
- 音頻 / 視頻輸入 2
  - 視頻輸入 (黃)
  - 音頻左輸入 (白色)
  - 音頻右輸入 (紅色)



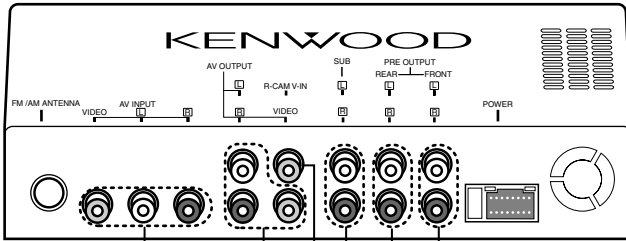

- 前預輸出
  - 音頻左輸出 (白色)
  - 音頻右輸出 (紅色)
- 后預輸出
  - 音頻左輸出 (白色)
  - 音頻右輸出 (紅色)
- 低音揚聲器預輸出
  - 音頻左輸出 (白色)
  - 音頻右輸出 (紅色)
- 後視攝影機輸入
  - 視頻輸入 (黃色)
- 音頻 / 視頻輸出
  - 視頻輸入 (黃色)
  - 音頻左輸出 (白色)
  - 音頻右輸出 (紅色)
- 音頻 / 視頻輸入
  - 視頻輸入 (黃色)
  - 音頻左輸入 (白色)
  - 音頻右輸入 (紅色)

## 安裝顯示器裝置

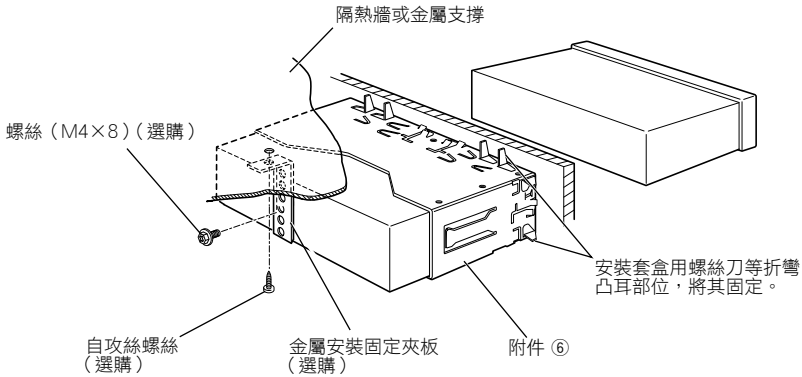

請切實固定裝置。若安裝不穩，可能會出故障。

## 安裝隱藏的裝置

1. 使用螺栓 ⑧ 將安裝托架 ⑩ 固定在隱藏部件的側面。

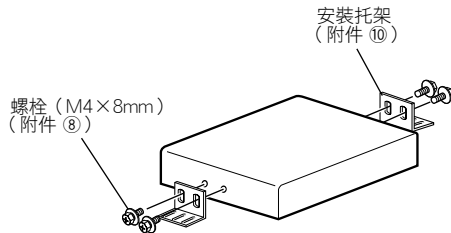

2. 使用自攻螺釘 ⑨ 將隱藏部件固定到音頻板上。

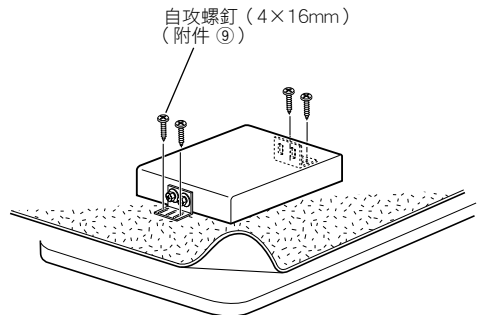

# 拆除顯示器裝置

## ■ 硬橡膠框的拆卸方法

1. 拉出可拆卸工具 ⑦ 的凸耳，拆卸下側兩處的鎖定裝置。  
按圖示要領將框向下壓，再向後拉出。

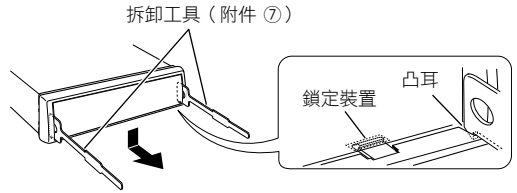

2. 下側拆卸後，上側兩處也以同樣方法拆卸。

☞ 從上側開始也可同樣拆卸。

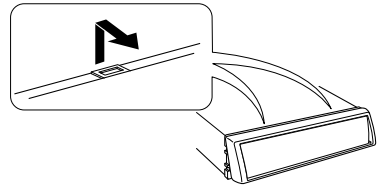

## ■ 拆卸方法

1. 參照〈硬橡膠框的拆卸方法〉部分的内容，拆下硬橡膠框。

2. 卸下背面板附有的墊圈螺絲 (M4×8)。

3. 將可拆卸工具 ⑦ 深深插入裝置的槽內。

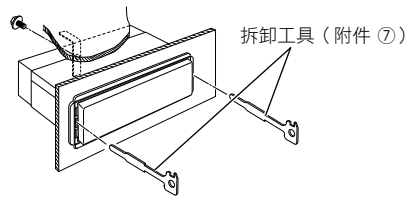

4. 將可拆卸工具向下降，靠近內側，將裝置拉出到中途。

☞ 安裝時請注意不要被可拆卸工具的凸耳碰傷。

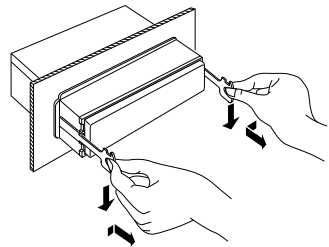

5. 用手托住裝置拉出，以免掉落。

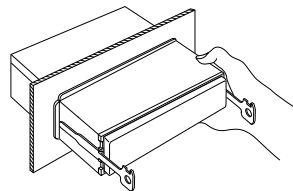

## 在日本汽車上安裝時

■ 當將汽車托架向使用如下圖所示“●”位置的孔的豐田牌汽車、日產牌汽車以及三菱牌汽車等安裝時

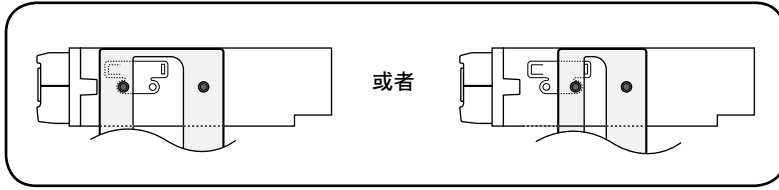

附件 ⑫ (M5×6mm)  
或者附件 ⑬ (M5×7mm)

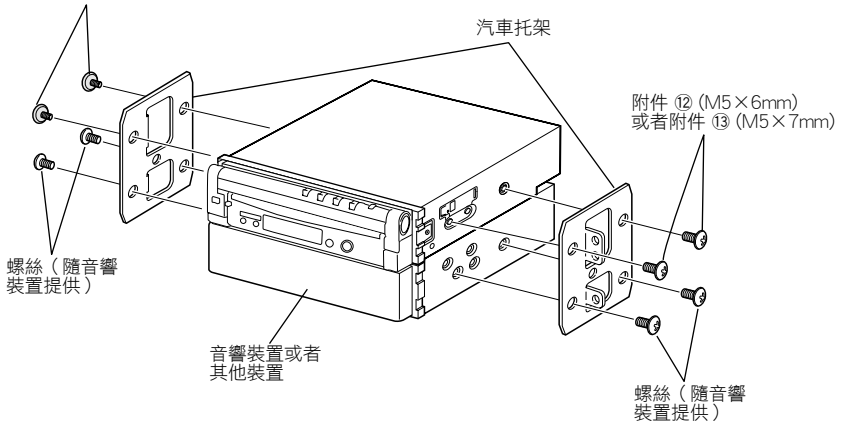

■ 當將汽車托架向使用如下圖所示“●”位置的孔的豐田牌汽車安裝時

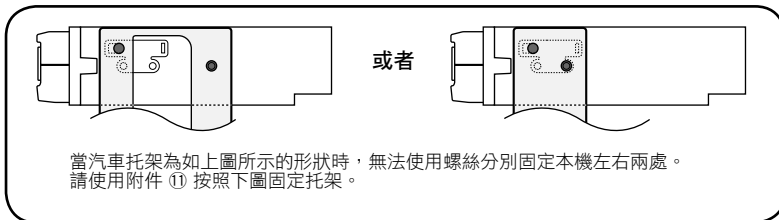

1. 如下圖所示，將附件 ⑪ 安裝在兩側。

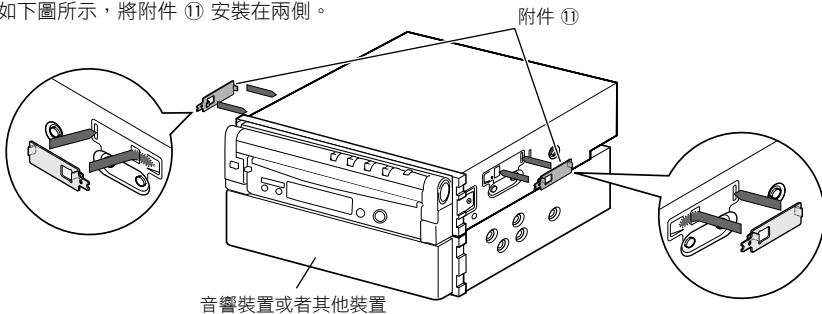

## 2. 安裝托架。

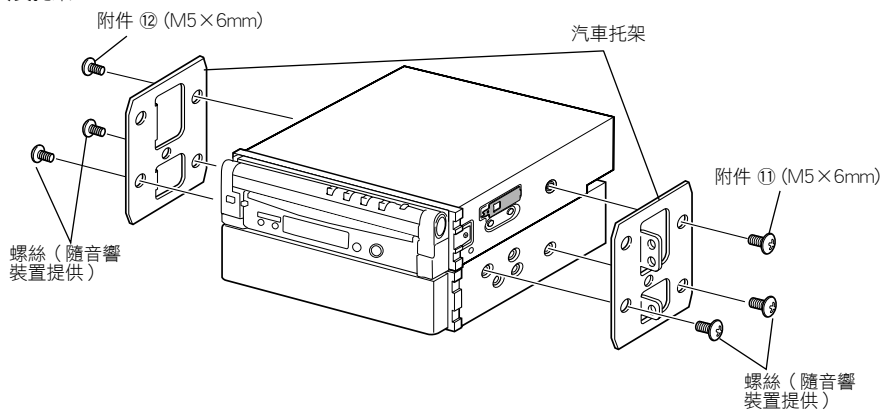

## 3. 折彎附件 11 的前端，固定托架。

使用改錐或者鉗子，將左右側的部件折彎，固定托架孔。

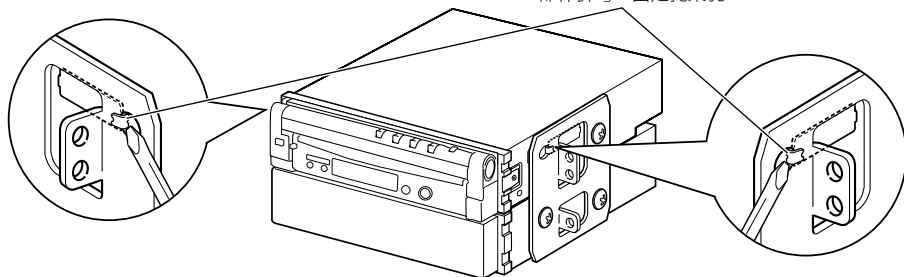

## 安裝遙控裝置

### ■ 安裝遙控裝置座 (附件 14)

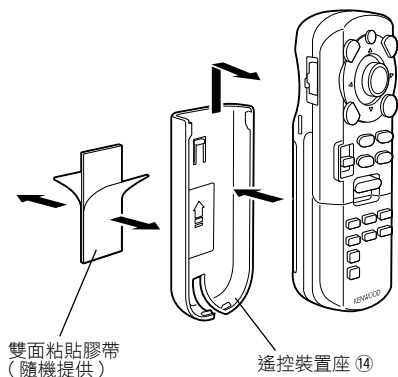

⚠ 為了防止遙控裝置掉落在腳下，請安裝遙控裝置座。如果遙控裝置掉落在操縱踏板下，將防礙駕駛而導致交通事故。

# 附件

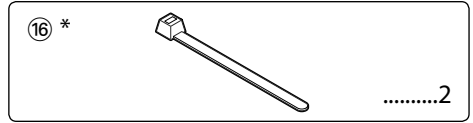
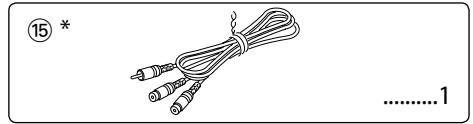
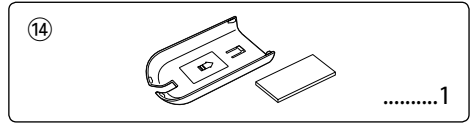
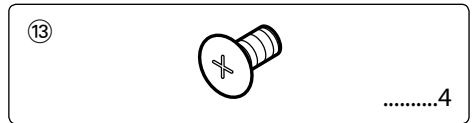
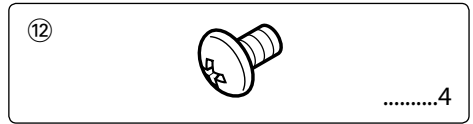
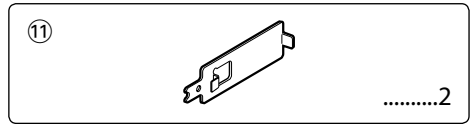
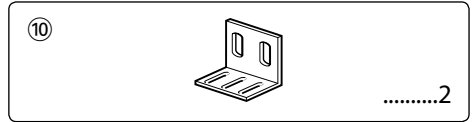
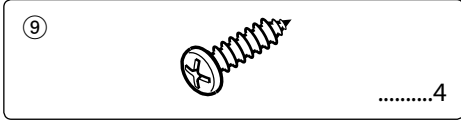
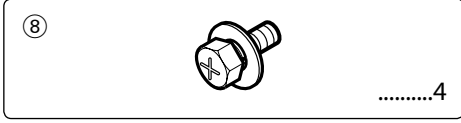
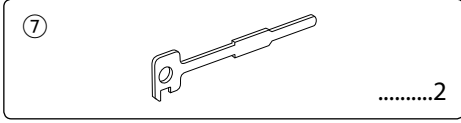
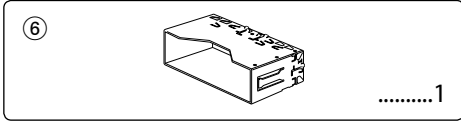
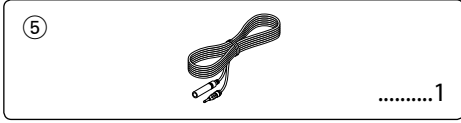
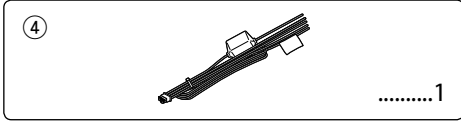
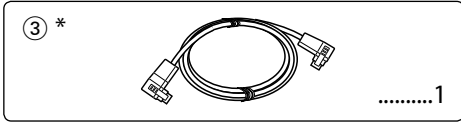
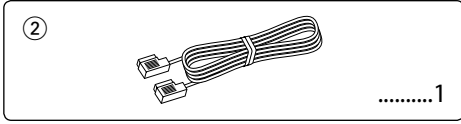
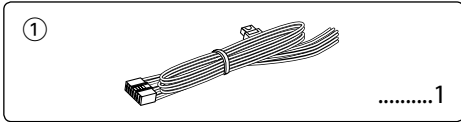

\* 仅限 KVT-837DVD/847DVD/867DVD

## 安装程序

1. 为了防止短路，从点火开关中拔出钥匙，拆下蓄电池的负极⊖接线。
2. 连接各装置的输入、输出导线。
3. 连接电线束的扬声器导线。
4. 按照接地导线、蓄电池导线和点火导线的顺序连接电线束。
5. 将电线束的连接器连接到装置上。
6. 将装置安装到汽车中。
7. 重新连接蓄电池的负极⊖接线。
8. 按下复位按钮。

### ▲警告

- 如果您将点火装置电线（红色）和电池线（黄色）连接到汽车底盘（接地），您可能会导致短路，并造成火灾。请始终将那些电线连接到经过保险丝盒的电源。
- 不得从点火导线（红色）和蓄电池导线（黄色）上拆下保险丝。电源必须通过保险丝与导线连接。

### ▲注意

- 如果电源无法接通（或者虽然接通，但是立即断开），扬声器导线可能发生短路、或与汽车底盘接触，保护功能可能动作。这时请检查扬声器导线。
- 如果汽车的点火装置没有ACC位置，请将点火导线与可以通过点火钥匙接通和断开的电源连接。如果将点火导线与始终供电的电源连接，例如与蓄电池导线连接，蓄电池将全部放电而无法使用。
- 如果控制台设有盖板，在安装时请注意、当关闭和打开面板时，不得与盖板碰撞。
- 当保险丝烧断时，请首先确认不应有引起短路的接触，然后使用与旧保险丝相同规格的保险丝更换。
- 请用乙烯带等绝缘物包覆未连接的导线。为了防止发生短路，不得取下未连接导线的线端或端子的护罩。
- 将扬声器导线直接对应的端子连接。如果共用负极⊖导线或者将其与汽车的金属部件连接，本装置可能损坏或者无法正常工作。
- 当只有两只扬声器与系统连接时，请将连接器或者与两个前侧输出端子连接，或者与两个后侧输出端子连接（不得将前侧与后侧混合连接）。例如，如果将左侧扬声器的正极⊕连接器与前侧输出端子连接，则不得将负极⊖连接器与后侧输出端子连接。
- 安装结束后，请确认汽车制动器灯、方向指示灯和刮水器等是否正常动作。
- 本机安装角度为30度以下为宜。

# 连接

**!** 在连接光缆线路时，请注意光缆的弯曲半径不得小于 30mm。如超过最小弯曲限度，光缆中的光导纤维可能发生损坏。



使用线束卡（附件 16）将光缆（附件 3）与底盘固定。（仅限 KVT-837DVD/847DVD/867DVD）

**!** 为了安全，请确保连接于刹车传感器。

使用配备的中继连接器连接到汽车的手刹车检测开关线束。

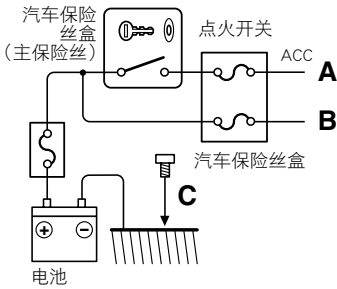
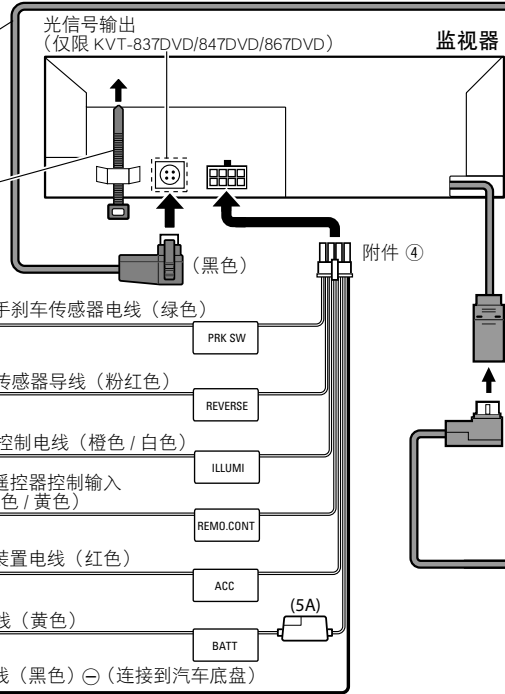
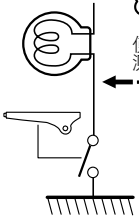

- A** ← 点火装置电线 (红色)
- B** ← 电池线 (黄色)
- C** ← 接地线 (黑色) ⊖ (连接到汽车底盘)

## 接收机 (前部)

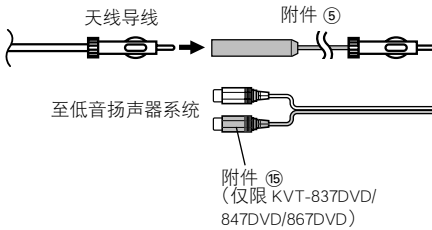
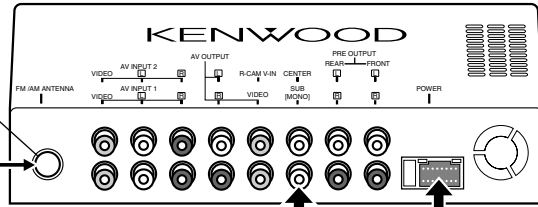

- C** ← 接地线 (黑色) ⊖ (连接到汽车底盘)
- B** ← 电池线 (黄色)

连接到电话振铃或通话时接地的端子上。

**!** 请参照导航系统的使用说明书，连接建伍导航系统。

根据您使用天线的情况，请连接到电动天线的控制端子，或者连接到薄膜型天线增强放大器的功率端子。

当使用选购的功率放大器时，请连接到它的功率控制端子。

连接到有外部放大器控制功能的放大器“EXT.AMP.CONT (外部放大器控制)”端子。

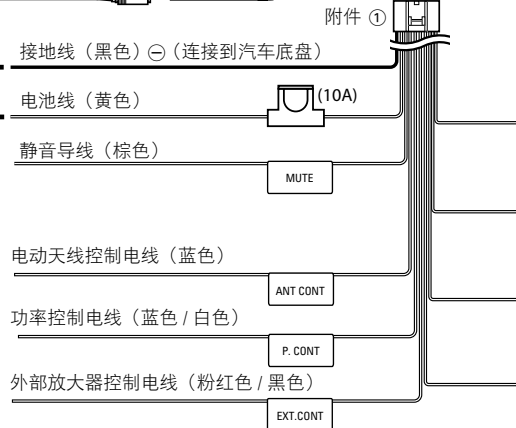



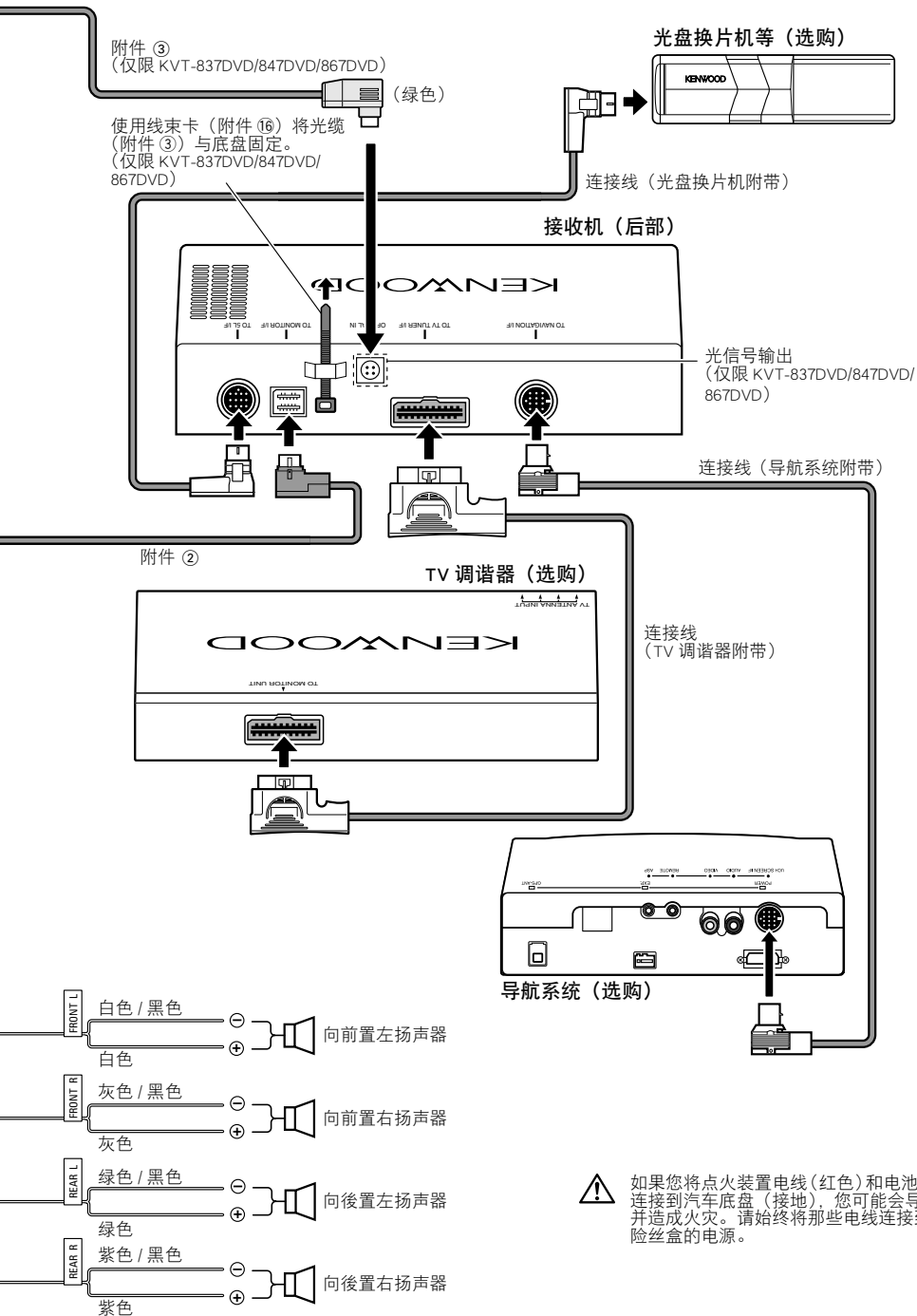

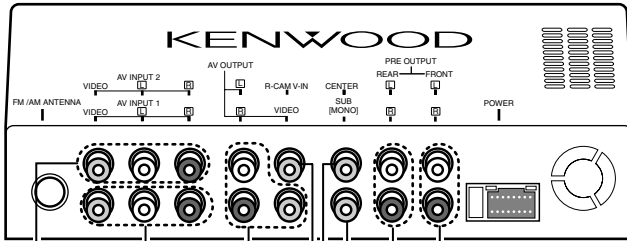

■ 前预输出

- 音频左输出 (白色)
- 音频右输出 (红色)

■ 后预输出

- 音频左输出 (白色)
- 音频右输出 (红色)

■ 低音扬声器 (单声道) 预输出

当连接的低音扬声器系统的输入端子为立体声时, 可以使用附件 ⑮。

■ 中央预输出

■ 后视摄影机输入

- 视频输入 (黄色)

■ 音频 / 视频输出

- 视频输入 (黄色)
- 音频左输出 (白色)
- 音频右输出 (红色)

■ 音频 / 视频输入 1

- 视频输入 (黄色)
- 音频左输入 (白色)
- 音频右输入 (红色)

■ 音频 / 视频输入 2

- 视频输入 (黄色)
- 音频左输入 (白色)
- 音频右输入 (红色)

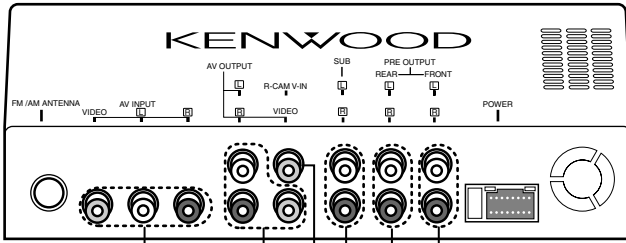

- 前预输出
  - 音频左输出 (白色)
  - 音频右输出 (红色)
- 后预输出
  - 音频左输出 (白色)
  - 音频右输出 (红色)
- 低音扬声器输出
  - 音频左输出 (白色)
  - 音频右输出 (红色)
- 后视摄影机输入
  - 视频输入 (黄色)
- 音频 / 视频输出
  - 视频输入 (黄色)
  - 音频左输出 (白色)
  - 音频右输出 (红色)
- 音频 / 视频输入
  - 视频输入 (黄色)
  - 音频左输入 (白色)
  - 音频右输入 (红色)

## 安装显示器装置

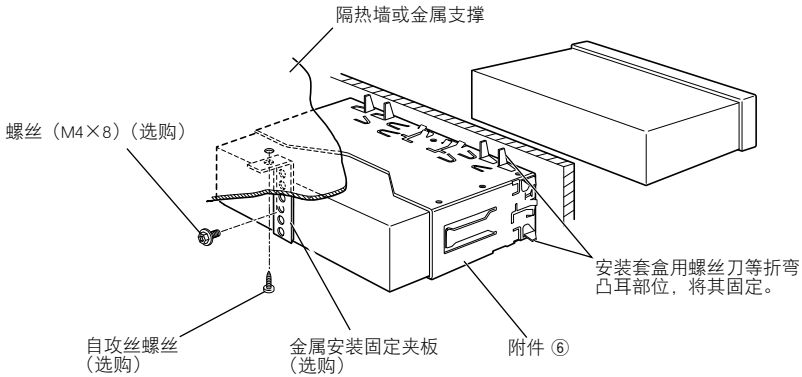

 请切实固定装置。若安装不稳, 可能会出故障。

## 安装隐藏的装置

1. 使用螺栓 ⑧ 将安装托架 ⑩ 固定在隐藏部件的侧面。

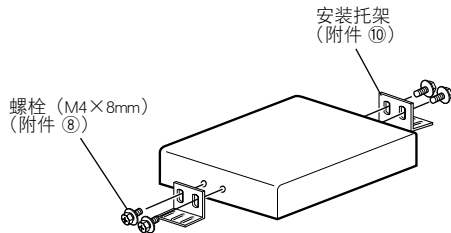

2. 使用自攻螺钉 ⑨ 将隐藏部件固定到音频板上。

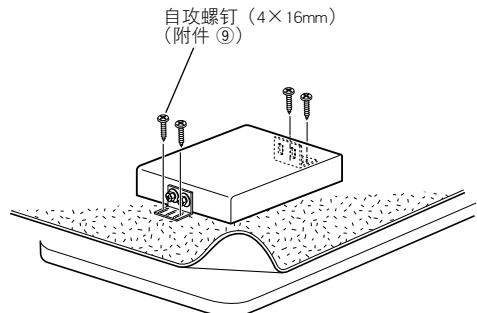

# 拆除显示器装置

## ■ 硬橡胶框的拆卸方法

1. 拉出可拆卸工具 ⑦ 的凸耳，拆卸下侧两处的锁定装置。  
按图示要领将框向下压，再向后拉出。

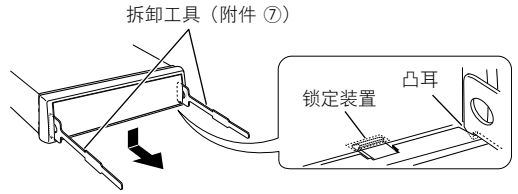

2. 下侧拆卸后，上侧两处也以同样方法拆卸。

 从上侧开始也可同样拆卸。

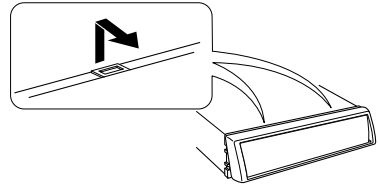

## ■ 拆卸方法

1. 参照〈硬橡胶框的拆卸方法〉部分的内容，拆下硬橡胶框。

2. 卸下背面板附有的垫圈螺丝 (M4×8)。

3. 可拆卸工具 ⑦ 深深插入装置的槽内。

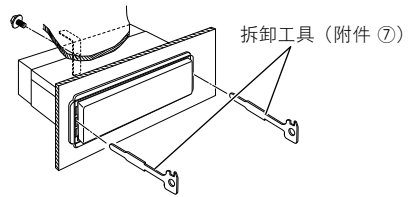

4. 将可拆卸工具向下降，靠近内侧，将装置拉出到中途。

 安装时请注意不要被可拆卸工具的凸耳碰伤。

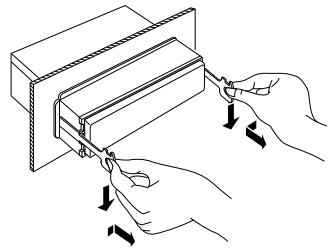

5. 用手托住装置拉出，以免掉落。

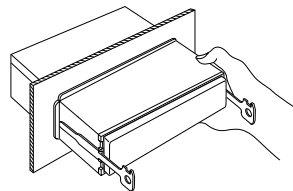

## 在日本汽车上安装时

■ 当将汽车托架向使用如下图所示“●”位置的孔的丰田牌汽车、日产牌汽车以及三菱牌汽车等安装时

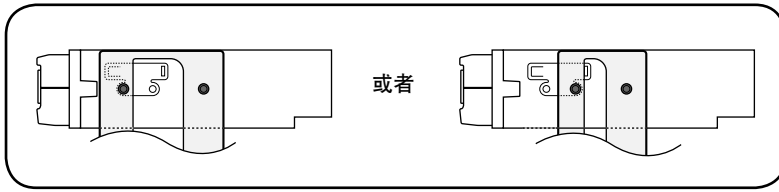

附件 ⑫ (M5×6mm)  
或者附件 ⑬ (M5×7mm)

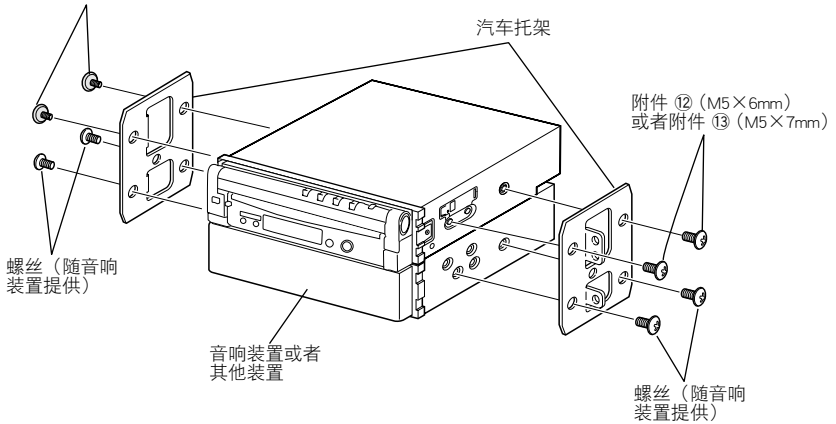

■ 当将汽车托架向使用如下图所示“●”位置的孔的丰田牌汽车安装时

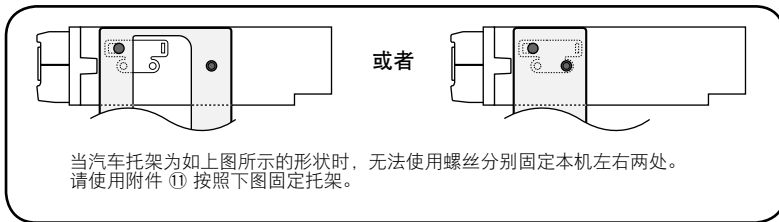

1. 如下图所示，将附件 ⑪ 安装在两侧。

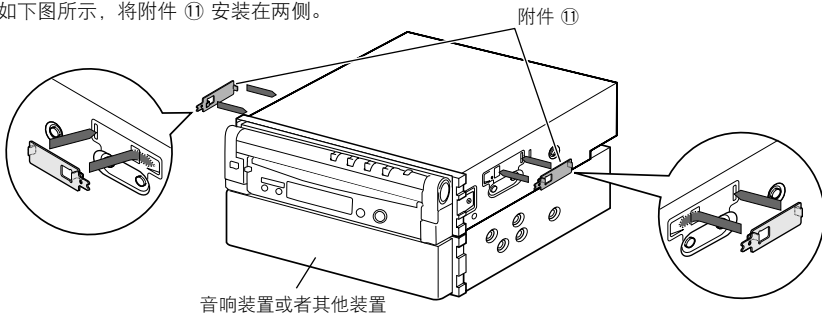

## 2. 安装托架。

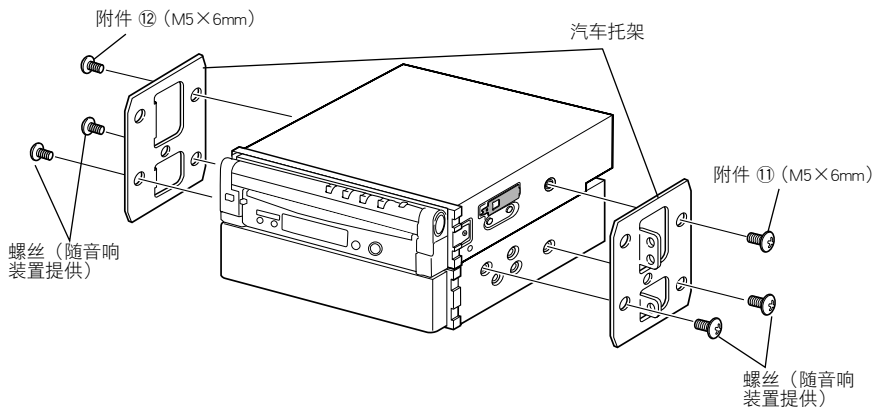

## 3. 折弯附件 11 的前端，固定托架。

使用改锥或者钳子，将左右侧的部件折弯，固定托架孔。

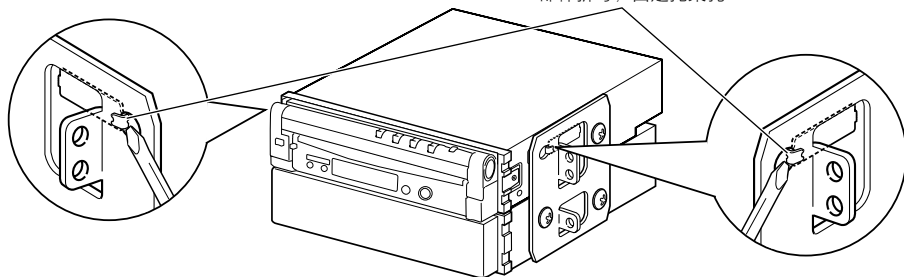

## 安装遥控装置

### ■ 安装遥控装置座 (附件 14)

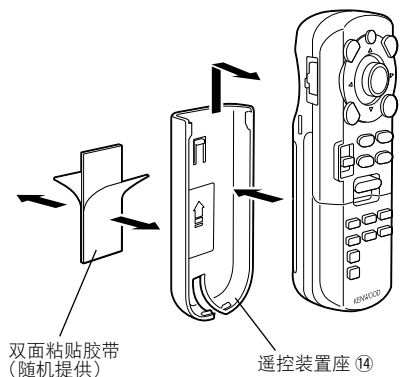

为了防止遥控装置掉落在脚下，请安装遥控装置座。如果遥控装置掉落在操纵踏板下，将妨碍驾驶而导致交通事故。

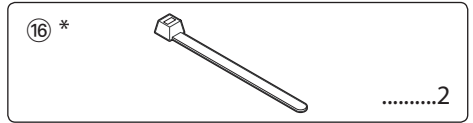
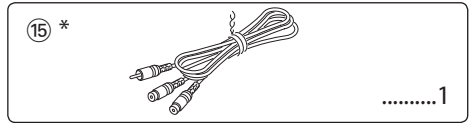
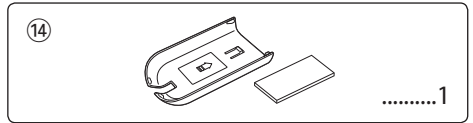
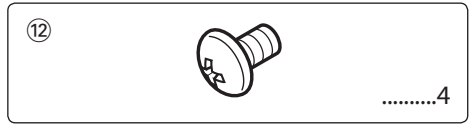
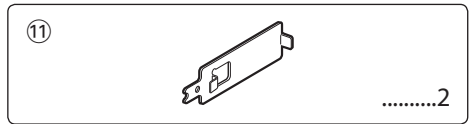
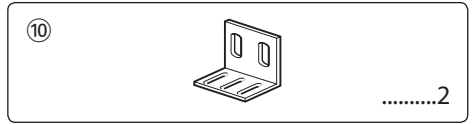
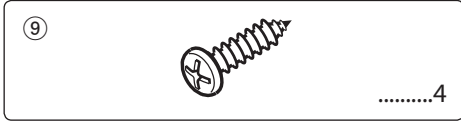
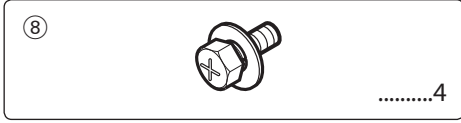
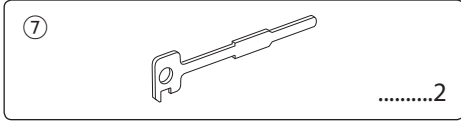
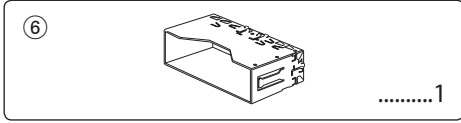
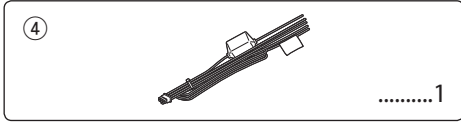
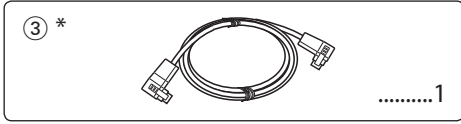
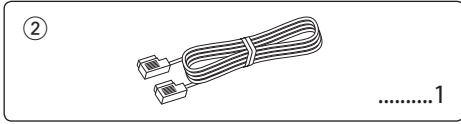
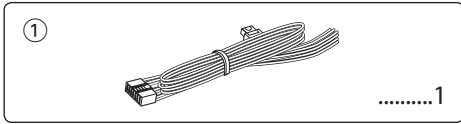

 \* KVT-837DVD/847DVD/867DVD에만 해당



## 설치 순서

1. 단락을 방지하기 위해 이그니션에서 키를 빼고 ⊖ 배터리를 차단합니다.
2. 각 기기의 입출력 와이어를 바르게 접속합니다.
3. 와이어링 하네스와 스피커 와이어를 접속합니다.
4. 어스, 배터리, 이그니션의 순서로 와이어링 하네스의 와이어를 접속합니다.
5. 와이어링 하네스 커넥터를 본 기기에 접속합니다.
6. 자동차에 본 기기를 설치합니다.
7. ⊖ 배터리를 다시 접속합니다.
8. 리세트 버튼을 누릅니다.

### ▲경고

- 이그니션 와이어 (빨강) 와 배터리 와이어 (노랑) 를 차대 (접지) 에 연결할 때에 전기 누전을 일으켜 발화할 수도 있습니다. 이들 와이어는 항상 퓨즈 박스를 관통하는 진원 소스에 연결하십시오.
- 이그니션 배선 (적색)과 배터리 배선 (황색)으로부터 퓨즈를 잘라내지 마십시오. 파워 서플라이는 퓨즈를 통해서 배선에 연결되어야 합니다.

### ▲주의

- 전원이 ON으로 되지 않는 경우(또는 ON이지만, 즉시 OFF로 되는 경우)에는, 스피커 배선이 쇼트되었거나 자동차의 차시에 접촉해서 보호 기능이 활성화되었을 수 있습니다. 그러므로, 스피커 배선을 체크해야 합니다.
- 자동차의 이그니션에 ACC 위치가 없는 경우에는 이그니션 키를 사용하여 ON/OFF 로 할 수 있는 전원에 이그니션 와이어를 접속합니다. 배터리 와이어처럼 일정 전압의 전원에 이그니션 와이어를 접속하면 배터리가 움직이지 않습니다.
- 기기에 뚜껑이 있는 경우, 개폐시 전면 플레이트가 뚜껑에 부딪치지 않는지 확인해서 설치하십시오.
- 퓨즈가 끊어졌을 경우에는 단락의 원인이 되므로 와이어가 접촉하고 있지 않음을 확인하고 나서 같은 규격의 새 퓨즈로 교환해 주십시오.
- 연결되지 않은 와이어는 비닐 테이프 등으로 절연시키십시오. 누전을 방지하기 위해서 연결되지 않은 와이어, 혹은 단자의 끝에 있는 캡을 제거하지 마십시오.
- 스피커 와이어를 해당 단자에 바르게 접속합니다.
  - 와이어를 공유하거나 자동차의 금속부분에 어스를 연결하면 본 기기가 고장이 나거나 오작동할 수도 있습니다.
- 두개의 스피커가 시스템에 연결되어져 있을 경우에는 출력 단자의 앞의 양쪽, 혹은 출력 단자의 후반의 양쪽에 커넥터를 연결하십시오. (양쪽과 후반부를 섞어서 연결하지 마십시오). 예를 들어, 왼쪽 스피커의 + 커넥터를 앞쪽의 출력 단자에 연결했다면, - 커넥터를 후반 출력 단자에 연결하면 안됩니다.
- 본 기기를 설치한 후에 자동차의 브레이크 램프, 점멸기, 와이퍼가 정상으로 작동하고 있는지 확인해 주십시오.
- 설치 각도가 30 도 이하로 되도록 본 기기를 설치해 주십시오.

# 접속

**!** 배선용으로 광케이블을 취급하는 경우에는, 30mm의 최소 케이블 굵힘 반경을 초과하지 않도록 주의해서 사용하십시오. 최소 굽힘 한계를 초과하면, 광케이블 내의 광화이버가 손상될 수 있습니다.



광케이블(액세서리 ③)은 케이블 타이(액세서리 ⑫)를 사용해서 사시에 고정합니다. (KVT-837DVD/847DVD/867DVD에만 해당)

안전을 위해서, 주차 센서를 접속하십시오.

제공되는 릴레이 단자를 사용해서 자동차의 주차 브레이크 탐지 스위치에 접속합니다.

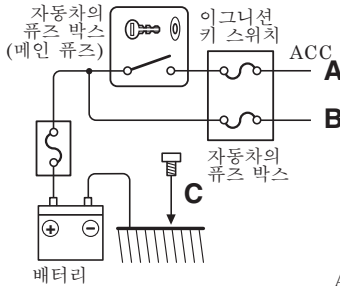
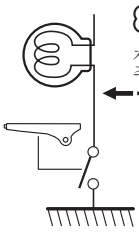

- 자동차의 반진 램프로 리버스 센서 배선(핑크색)
- 자동차 라이트 컨트롤 스위치에 조광기 컨트롤 와이어(오렌지/흰색)
- 스티어링 리모컨으로 스티어링 리모컨 입력(밝은 청색/황색)
- A ← 이그니션 와이어(적색)
- B ← 배터리 와이어(황색)
- C ← 지선(검은색) ⊖ (자동차의 새시에)

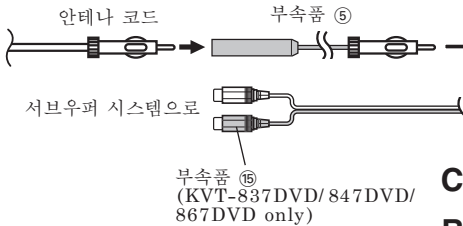
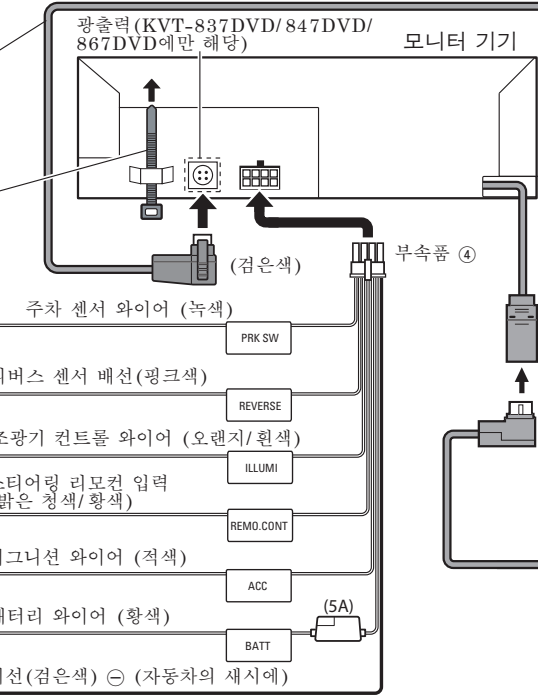

전화 호출 또는 대화중 접지된 단자에 접속합니다.

**!** Kenwood네비게이션 시스템을 연결하기위해서는 네비게이션 매뉴얼을 참조하십시오.

사용하고 있는 안테나에 따라 모터 안테나 컨트롤 단자 또는 필름 타입 안테나의 부스터 증폭용 전원단자에 접속한다.

옵션의 앰프를 사용할 경우에 전원 컨트롤 단자에 접속한다.

외부 앰프 컨트롤 기능을 가지는 앰프의 "EXT.AMP.CONT." 터미널에.

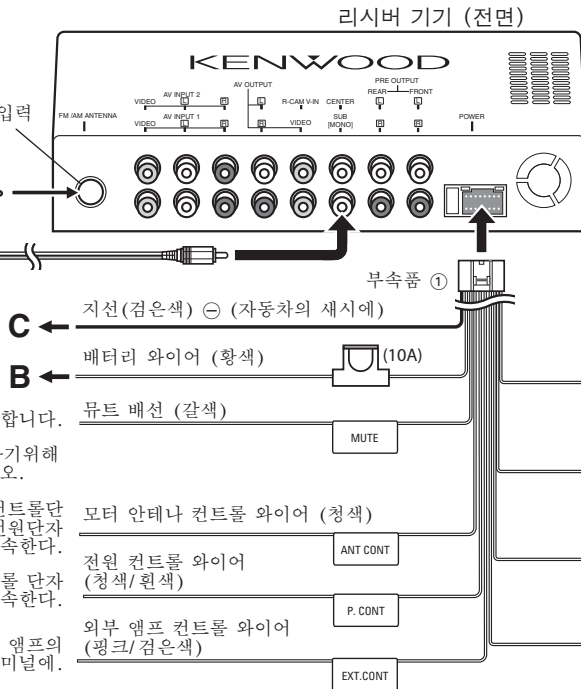

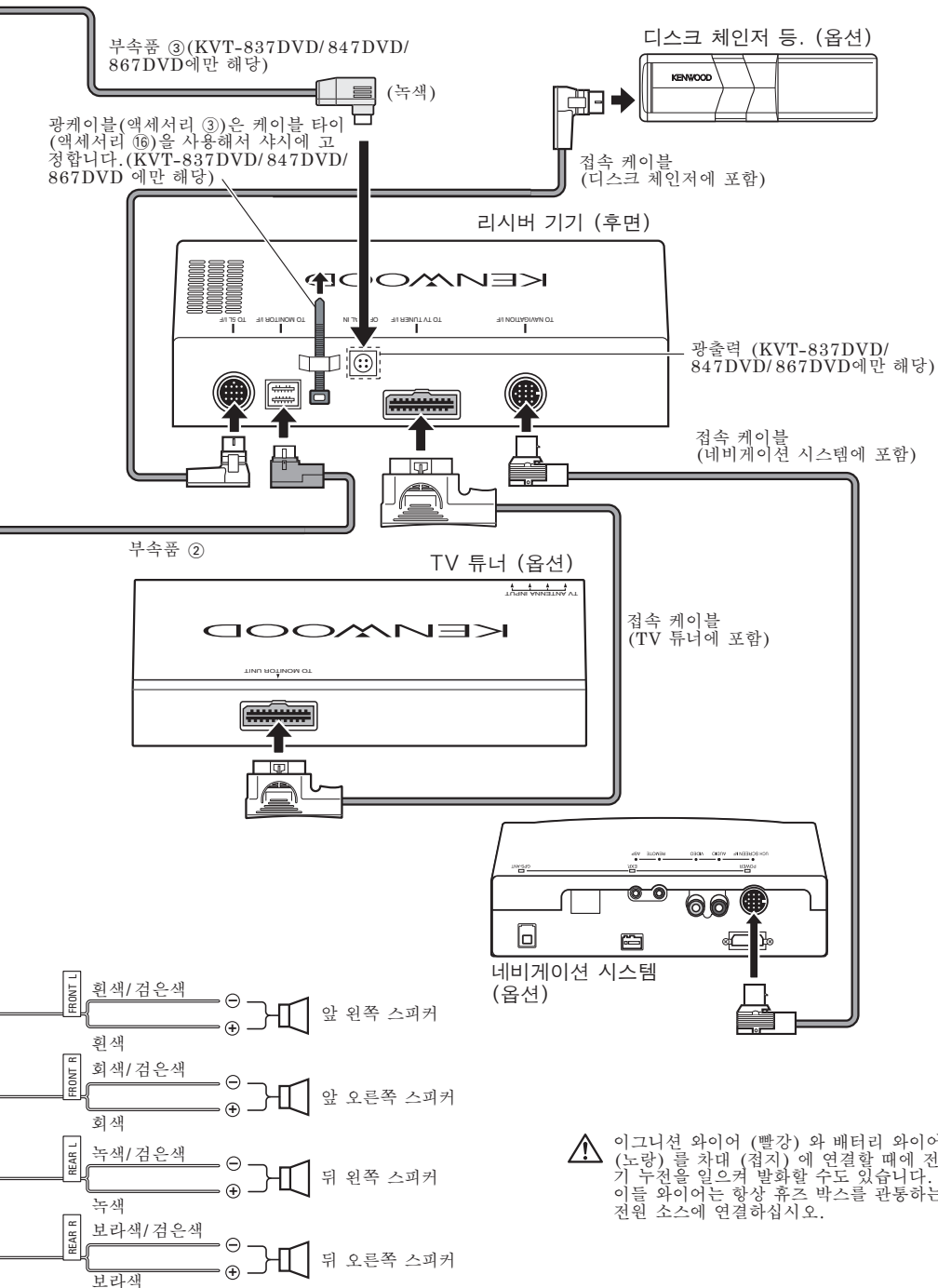

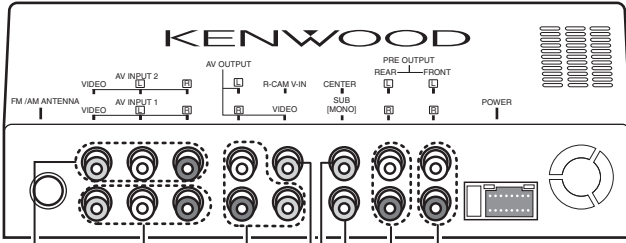

■ 전면 예비출력

- 오디오 좌측 출력 (백색)
- 오디오 우측 출력 (적색)

■ 후면 예비출력

- 오디오 좌측 출력 (백색)
- 오디오 우측 출력 (적색)

■ 서브-우퍼 (모노) 예비출력

서브우퍼 시스템 입력 단자를 접속할 곳 이 스테레오인 경우에 액세스리 ⑮ 를 사용할 수 있습니다 .

■ 중앙 예비출력

■ 후면 보기 카메라 입력

- 비주얼 출력 (황색)

■ 오디오/비주얼 출력

- 비주얼 출력 (황색)
- 오디오 좌측 출력 (백색)
- 오디오 우측 출력 (적색)

■ 오디오/비주얼 입력 1

- 비주얼 입력 (황색)
- 오디오 좌측 입력 (백색)
- 오디오 우측 입력 (적색)

■ 오디오/비주얼 입력 2

- 비주얼 입력 (황색)
- 오디오 좌측 입력 (백색)
- 오디오 우측 입력 (적색)

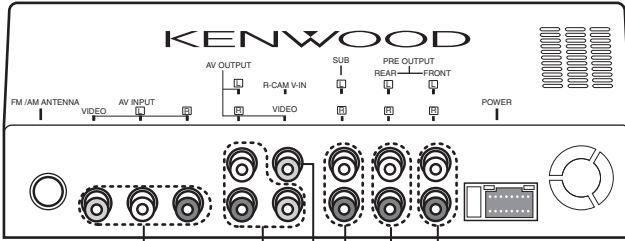

- **전면 예비출력**
  - 오디오 좌측 출력 (백색)
  - 오디오 우측 출력 (적색)
- **후면 예비출력**
  - 오디오 좌측 출력 (백색)
  - 오디오 우측 출력 (적색)
- **서브-우퍼 예비출력**
  - 오디오 좌측 출력 (백색)
  - 오디오 우측 출력 (적색)
- **후면 보기 카메라 입력**
  - 비주얼 출력 (황색)
- **오디오/비주얼 출력**
  - 비주얼 출력 (황색)
  - 오디오 좌측 출력 (백색)
  - 오디오 우측 출력 (적색)
- **오디오/비주얼 입력**
  - 비주얼 입력 (황색)
  - 오디오 좌측 입력 (백색)
  - 오디오 우측 입력 (적색)

## 모니터 유닛을 위한 설치

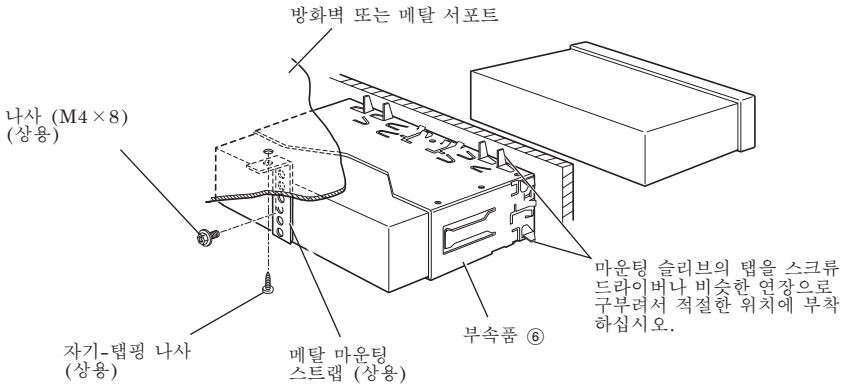

 기기가 제자리에 단단히 설치되었는지 확인하십시오. 기기가 불안정하면, 오작동할 수도 있습니다 (예, 소리가 났을 수 있습니다).

## 리시버 기기를 위한 설치

1. 설치 브래킷 ⑩을 볼트 ⑧를 사용해서 보이지 않는 쪽에 부착하십시오.

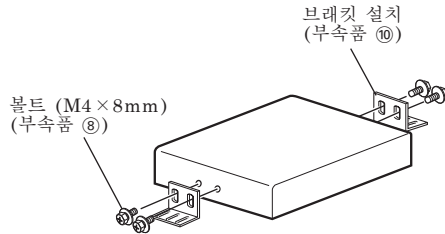

2. 탭핑 나사 ⑨를 사용해서 오디오 보드에 단단히 부착하십시오.

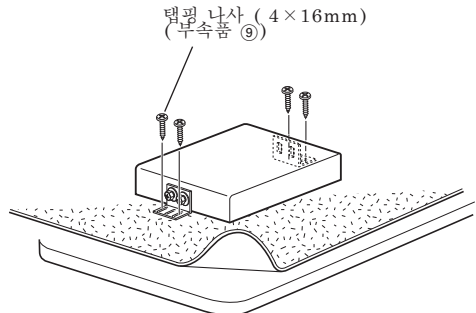

# 모니터 유닛 떼어내기

## ■ 강화 고무 프레임 떼어내기

1. 고정 핀을 제거용 기구 ⑦에 대고 아래 쪽에 있는 두개의 잠금 장치를 떼어내십시오.  
프레임을 내려서 그림에 보이는 것처럼 앞으로 당겨내십시오.

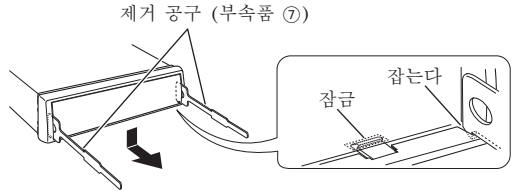

2. 아래 쪽을 떼어냈으면, 위쪽의 두 곳도 떼어내십시오.

 프레임은 위쪽으로부터 같은 방식으로 떼어낼 수 있습니다.

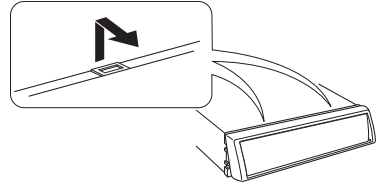

## ■ 강화 고무 프레임 떼어내기

1. <강화 고무 프레임 떼어내기> 섹션을 참조한 후 강화 고무 프레임을 떼어내십시오.
2. 후면 패널의 위서 (M4×8) 로 6 각 나사를 떼어내십시오.
3. 제거 공구 ⑦을 그림처럼 각각의 슬롯에 깊숙히 삽입하십시오.

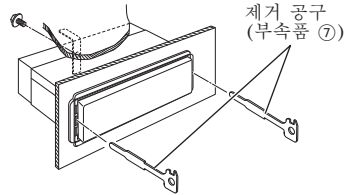

4. 제거 공구를 바닥으로 낮추어서 안쪽으로 밀면서 기기를 반쯤 끌어 당기십시오.

 제거 공구의 고정 핀으로 인해 상처가 나지 않도록 주의하십시오.

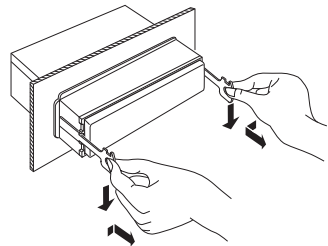

5. 떨어뜨리지 않도록 주의하면서 손으로 기기를 밖으로 당겨내십시오.

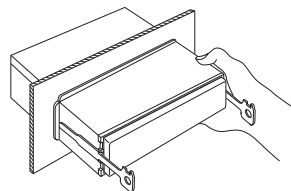

# 일제 자동차에 설치하기

## ●의 구멍에 브래킷을 사용하는 토요타 자동차에 설치하기

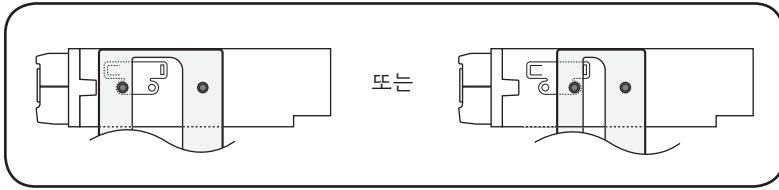

부속품 ⑫ (M5×6mm)  
또는 부속품 ⑬ (M5×7mm)

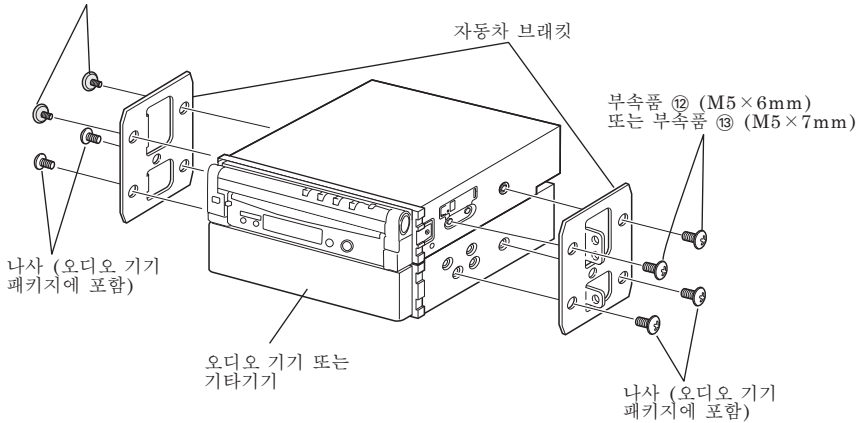

## ●의 구멍에 브래킷을 사용하는 토요타 자동차에 설치하기

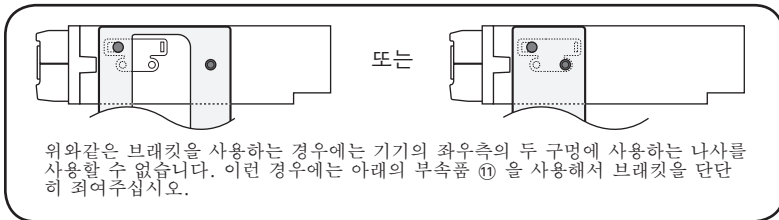

1. 그림과 같이 양쪽에 부속품 ⑪을 사용하십시오.

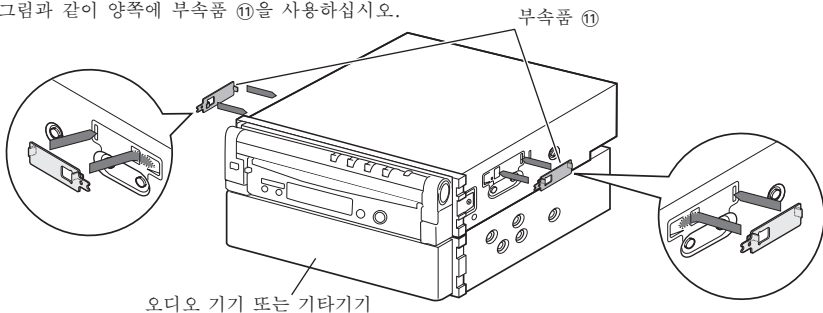



2. 각각에 브래킷을 설치하십시오.

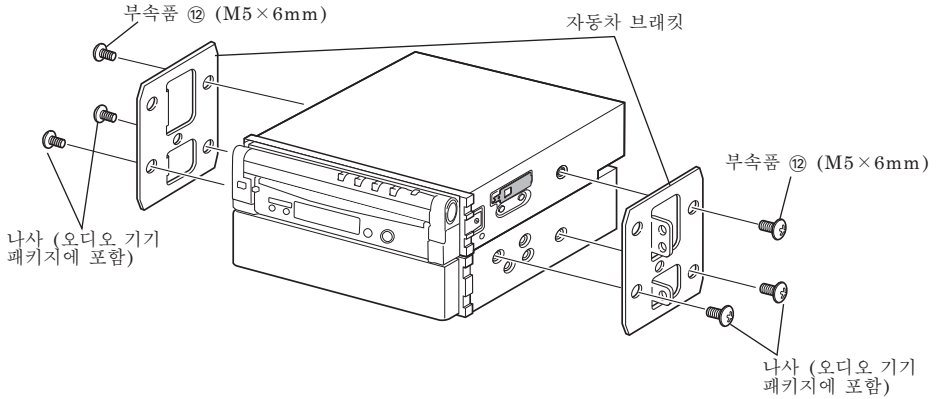

3. 부속품 ⑪의 각 끝부분을 구부려서 브래킷을 고정하십시오.

일자형 드라이버 또는 펜치를 사용해서 각 부속품 탭을 설치 브래킷의 구멍쪽으로 구부려서 브래킷을 고정하십시오.

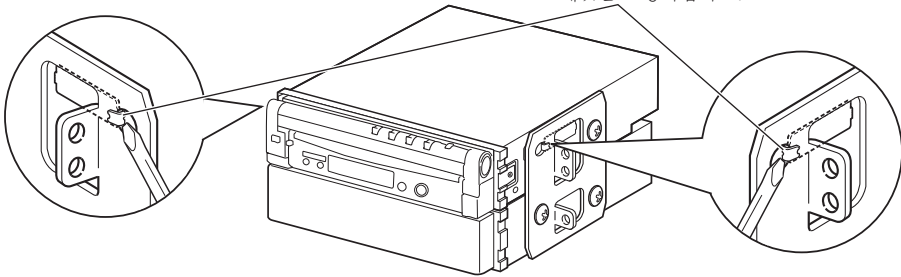

## 리모컨 유닛의 설치

■ 리모컨 유닛 홀더 설치 (액세서리 ⑭)

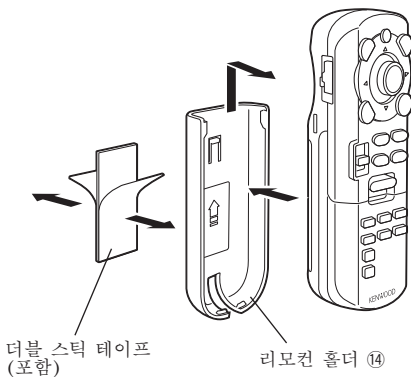

**!** 여러분의 발에 리모컨 유닛이 떨어지는 것을 방지하기 위해서는, 리모컨 유닛 홀더를 사용해서 설치하십시오. 리모컨 유닛이 드라이브 페달 아래에 떨어지면, 운전을 방해할 수 있습니다.





---

# KENWOOD

## Free Manuals Download Website

<http://myh66.com>

<http://usermanuals.us>

<http://www.somanuals.com>

<http://www.4manuals.cc>

<http://www.manual-lib.com>

<http://www.404manual.com>

<http://www.luxmanual.com>

<http://aubethermostatmanual.com>

Golf course search by state

<http://golfingnear.com>

Email search by domain

<http://emailbydomain.com>

Auto manuals search

<http://auto.somanuals.com>

TV manuals search

<http://tv.somanuals.com>