

CASSETTE-RECEIVER

KRC-701

KRC-601

INSTRUCTION MANUAL

KENWOOD CORPORATION

Take the time to read through this instruction manual. Familiarity with installation and operation procedures will help you obtain the best performance from your new cassette-receiver.

For your records

Record the serial number, found on the back of the unit, in the spaces designated on the warranty card, and in the space provided below. Refer to the model and serial numbers whenever you call upon your KENWOOD dealer for information or service on the product.

Model KRC-701/601 Serial number _____

KENWOOD

Contents

Before use

Before use

Safety precautions.....	3
Features.....	5

Basic operations

Power / Volume / Attenuator.....	8
Loudness.....	9
Auto seek tuning.....	10
Manual tuning.....	11
Local seek.....	12
Cassette tape play.....	13
Dolby B NR / Tape type selection.....	14
Basic operation of remote control.....	15

Tuner features

Station preset memory.....	18
Auto memory entry.....	19
Priority radio preset.....	20
CRSC.....	21
Channel space selection.....	22

Cassette player features

DPSS.....	23
Index scan.....	24
Music repeat.....	25
Blank skip.....	26
Tuner call.....	27

Disc changer control features

Disc play with Disc changer.....	28
Track / Disc search.....	29
Track / Disc repeat.....	30
Track scan.....	31
Disc scan.....	32
Random play.....	33
Magazine random play.....	34

General features

Clock display / setting.....	35
Audio controls.....	36
Selectable illumination.....	38
Theft deterrent faceplate.....	39
Disabled system indicator.....	40

Installation

Accessories.....	41
Installation procedure.....	42
Installation.....	43
Connections.....	45

Troubleshooting guide.....46

Specifications.....48

Dolby noise reduction manufactured under license from Dolby Laboratories Licensing Corporation. "DOLBY" and the double-D symbol are trademarks of Dolby Laboratories Licensing Corporation.

Safety precautions

⚠WARNING

Take the following precautions to prevent fire and avoid personal injury :

- Press in the faceplate until it is firmly locked to the main unit to prevent it from being detached in an accident.
- When extending the ignition cable, battery cable, or ground cable, use 0.75mm² (AWG18) or larger automotive grade cable to avoid cable deterioration or damage to the covering.
- Check that no metal objects (coins, tools, etc.) are left inside the unit to avoid short circuits.
- If you smell or see smoke, turn the power off immediately and consult your Kenwood dealer.

⚠CAUTION

Take the following precautions to keep the unit in proper working order.

- Be sure the unit is connected to a 12V DC power supply with a negative ground connection.
- Do not open the top or bottom cover.
- Do not install the unit in places it is exposed to direct sunlight, high heat or humidity, water may splash over it, or dust exists.
- Do not store the detached faceplate or faceplate storage case in places it is exposed to direct sunlight or high heat.
- Do not splash water on the faceplate.
- The faceplate is a precision piece of equipment that contains sensitive parts. Do not subject it to excessive shock.
- Do not touch the terminals of the faceplate or the unit.
- If you need to replace the fuse, make sure the new fuse is of the same type and rating. Using a fuse of a different type of rating may damage your unit. The fuse rating is normally shown on the fuse and fuse box.
- If you need to replace the fuse, unplug the wiring harness before replacing the fuse to prevent short circuits.

FCC WARNING

- This equipment may generate or use radio frequency energy. Changes or modifications to this equipment may cause harmful interference unless the modifications are expressly approved in the instruction manual. The user could lose the authority to operate this equipment if an unauthorized change or modification is made.

IMPORTANT INFORMATION

This unit is NOT designed to be connected directly to a CD changer that was manufactured and sold before 1994. If you plan to use such units, please read the following information carefully.

- **To control KDC-C200 / KDC-C300 / KDC-C400**
A CA-DS100 (sold separately as an optional accessory), along with the control box and extension cord supplied with the CD changer, are required.
- **To control KDC-C301 / KDC-C600 / KDC-C800 / KDC-C601 / KDC-C401**
A CA-DS100 (sold separately as an optional accessory), along with the extension cord supplied with the CD changer, are required.
- **KDC-C100 / KDC-C302 / C205 / C705 and CD changer Manufactured by Other Companies are not compatible with this Kenwood model.**

FAILURE TO FOLLOW THESE INSTRUCTIONS MAY RESULT IN DAMAGE TO THIS UNIT AND/OR THE CD CHANGER

Safety precautions

Before use

NOTE

- If you have difficulty in installing this unit in your vehicle, contact your Kenwood dealer.
- If it doesn't seem to be working properly, first press the Reset button. If the malfunction persists, consult your Kenwood dealer.

Reset button

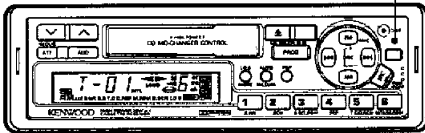

Cleaning the unit

- If the front panel is dirty, wipe it clean with a silicon cloth or soft dry cloth with the power off.

CAUTION

Do not use hard cloths or paint thinner, alcohol, or other volatile solvents. These may damage external surfaces or remove indicator characters.

Cleaning the faceplate terminal

- If the faceplate terminal or mount faceplate terminal becomes dirty, wipe it clean with a soft dry cloth.

Cleaning the tape head

- As you play tapes for a long time, magnetic dust and other grime accumulates around the heads and eventually causes noise that lowers sound quality. To clean the heads, use a cleaning tape or cleaning kit. Make sure you purchase a cleaning tape or cleaning kit suited to car audio use.

Be careful with your tapes.

- Before loading a cassette, take up any slack tape, by turning one of the spools with a pencil. Loading a slack tape can cause tape to tangle around the capstan and pinch roller and other problems.
- Do not use any deformed cassettes or cassettes with labels coming off, or the unit may fail.
- Do not leave cassettes exposed to high heat (for example, on the dashboard where it is exposed to direct sunlight, or near heater outlets). This can deform the cassette shell.
- Avoid long cassettes, such as 120-minute tapes. The tape is thin and easily tangled around the pinch roller or other parts.
- If you do not listen to your tape, remove it from the unit and store it safely. If a cassette is left in for a long time, the tape can stick to the tape head, causing failure.

Features

■ Tuner section

- **Auto seek tuning (Page 10)**
Automatically searches for stations you can receive.
- **Station preset memory (Page 18)**
Stores the frequencies of your favourite stations in memory. The frequencies stored in memory can be recalled by a single touch of a button.
- **Auto memory entry (Page 19)**
Automatically stores the stations in the band you are listening to in memory. You can tune to the stations stored in memory by a single touch of a button in the same way as for the Stations preset memory function. If you use this function when you drive a long way and do not know what stations are available there, you can check the programmes broadcast by local stations by recalling them by a single touch of a button.
- **Priority radio preset (Page 20)**
This function enables you to tune to the preset station by a single touch of a button while you are listening to a cassette or disc. Since you can listen to a station without switching to the tuner mode, it is useful to listen your favourite station (such as news, traffic information).
- **Local seek (Page 12)**
When this feature is turned on, the tuner scans only the stations offering good reception during Auto seek tuning and Auto memory entry.
- **CRSC (Clean Reception System Circuit) (Page 21)**
When this feature is turned on, the tuner switches reception to mono to reduce multi-path noise if it occurs in the broadcast you are listening to.
- **Channel space selection (Page 22)**
This feature allows you to change the frequency step between 200 kHz in FM/10 kHz in AM and 50 kHz in FM/9 kHz in AM.

Cassette player section

⌘ Tape type selection (Page 14)

The Tape type selection function allows you to play normal tapes and metal (chrome) tapes.

⌘ DPSS (Direct Program Search System) (Page 23)

This function lets you select tracks up to nine positions before or after the one you are playing.

⌘ Index scan (Page 24)

When this function is turned on, the first part of each track on the tape is played in succession. This function is useful to search for the track you want to listen to.

⌘ Music repeat [Page 25]

When this function is turned on, the player plays the track you are listening to repeatedly,

• Blank skip (Page 26)

When this feature is turned on, the player automatically fast forwards to the next track if it detects a long blank section.

⌘ Tuner call (Page 27)

When this function is turned on, you can listen to the radio while rewinding or fast forwarding a cassette.

■ Disc changer (optional) control section

⌘ Disc changer control (Page 28)

This unit has a Disc changer control function.

⌘ Track / Disc search (Page 29)

You can search for the track / disc you want by specifying the track / disc number.

⌘ Track repeat (Page 30)

When this function is turned on, the track you are listening to is played repeatedly.

⌘ Disc repeat (Page 30)

When this function is turned on, the disc you are listening to is played repeatedly.

⌘ Track scan (Page 31)

When this function is turned on, the first part of each track on the disc you are listening to is played automatically to help you find the one you want.

⌘ Disc scan (Page 32)

When this function is turned on, the first part of each disc in the Disc changer is played automatically to help you find one you want from the magazine loaded in the Disc changer.

• Random play (Page 33)

When this function is turned on, the tracks on the disc you are listening to are played in random order.

• Magazine random play (Page 34)

When this function is turned on, the tracks on the discs in your Disc changer are played in random order.

■ General section

- **Remote control (Function of KRC-701) (Page 15)**

This unit can be operated with the wireless remote control.
There are also convenient features available only with the remote control.
- **Attenuator (Page 8)**

This function allows you to lower the volume quickly. The fade-in function is provided to restore the original volume gradually.
- **Loudness control (Page 9)**

When this function is turned on when the volume level is low, sound is made clear by emphasizing bass.
- **Audio controls (Page 36)**

Adjust the bass, treble, balance, and fader.
- **Selectable illumination (Function of KRC-701) (Page 38)**

Allows illumination colour to be switched between green and orange.
- **Clock display (Page 35)**

The time can be displayed.
- **Theft deterrent faceplate (Page 39)**

The faceplate is detachable. When you leave the vehicle, you can take the faceplate with you to help prevent theft.
- **Disabled system indicator (Page 40)**

When the faceplate is detached from the unit, the LED blinks.
- **Automatic illumination control (Function of KRC-701)**

When the illumination cable is connected, the display panel lights up when the vehicle's lights are on even if the power is off. You can turn the power on easily in darkness.
If the disabled system is removed, the Disabled System indicator LED lights to remind you to reattach the faceplate.
- **Automatic dimmer control (Function of KRC-701)**

When the dimmer cable is connected, automatically dims the display when the car's light control is turned on.

Power/Volume/Attenuator

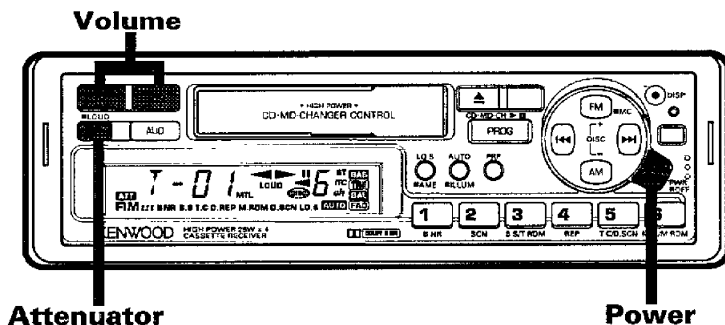

To turn the power on

Press the Source button.

NOTE

Perform the following operations with the power on.

To turn the power off

Press the Source button for more than a second.

To increase the volume

Press the Audio up button(∧).

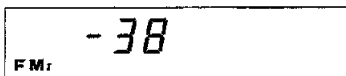

To decrease the volume

Press the Audio down button(∨).

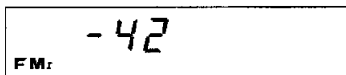

To use the Attenuator function

Press the Attenuator button. The Attenuator indicator will appear on the display and Attenuator function will turn on.

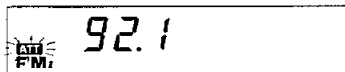

ON

To cancel the Attenuator function

Press the Attenuator button or set the volume to minimum. The Attenuator indicator disappears and the Attenuator function is cancelled.

To stop all the functions with the power on

Press the Source button to select All off mode. When "OFF" is displayed, you are in All off mode. You can stop all the function with the power on.

Loudness

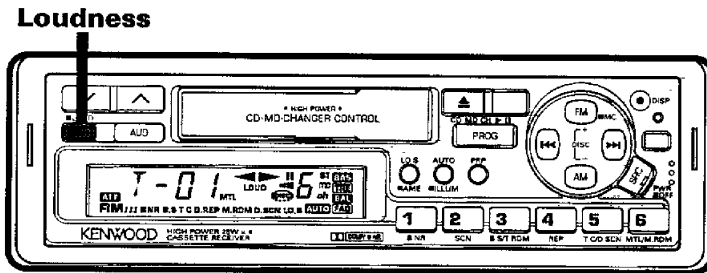

To use loudness control

Press the Loudness button for more than a second. Loudness is turned on and the Loudness indicator appears on the display. This function is factory-set to ON.

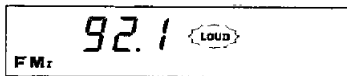

ON

To cancel loudness control

Press the Loudness button for more than a second. Loudness is turned off and the Loudness indicator disappears.

Auto seek tuning

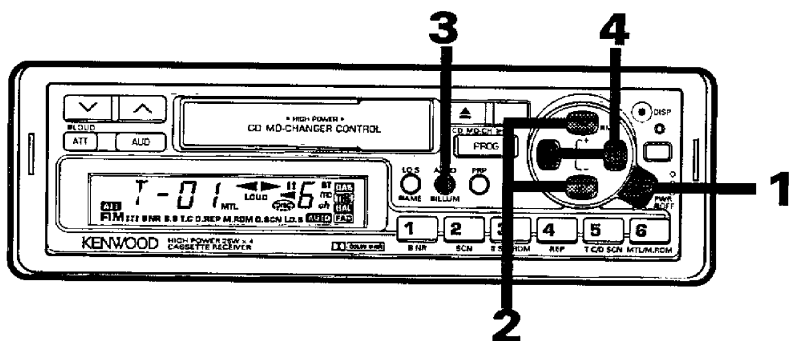

- 1** Listen to the radio
Press the Source button to select Tuner mode.
When "TUnE" is displayed, you are in Tuner mode.

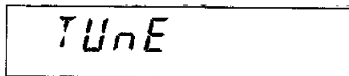

- 3** To select Auto seek tuning mode
Press the Auto button.
The Auto indicator will appear on the display and Auto seek tuning will turn on. This function is factory-set to ON.

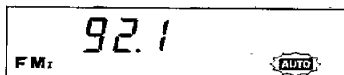

- 2** To select a band
Press the FM/AM button.
Each time you press the FM button briefly, the band changes between FM1, FM2, and FM3.
Press the AM button to choose AM band.

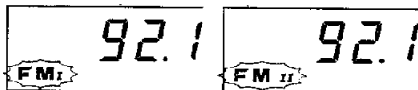

FM1

FM2



FM3

AM

- 4** To tune
Press the Tuning up/down button.
When the Tuning up button is pressed, up seeking is performed.
When the Tuning down button is pressed, down seeking is performed.
The Stereo indicator appears on the display when stereo broadcasts are received.

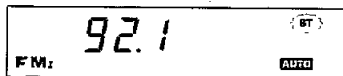

Manual tuning

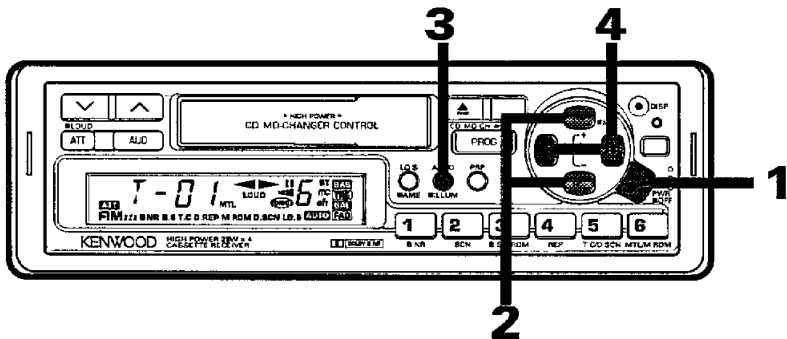

- 1** Listen to the radio
Press the Source button to select Tuner mode.
When "TUNE" is displayed, you are in Tuner mode.

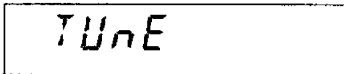

- 3** To select Manual tuning mode
Press the Auto button.
The Auto indicator disappears and the Auto seek tuning is cancelled.

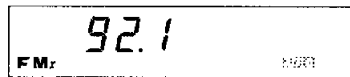

- 2** To select a band
Press the FM/AM button.
Each time you press the FM button briefly, the band changes between FM1, FM2, and FM3.
Press the AM button to choose AM band.

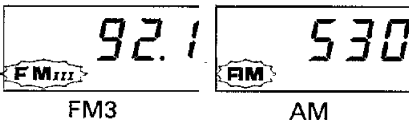
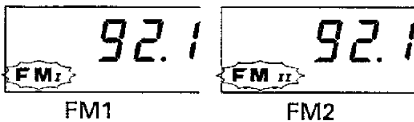

- 4** To tune
Press the Tuning up/down button.
When you press the button once, the received frequency changes by one step. The frequency will continue to change as long as you hold the button down.
The Stereo indicator appears on the display when stereo broadcasts are received.

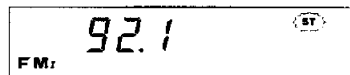

Local seek

Local seek

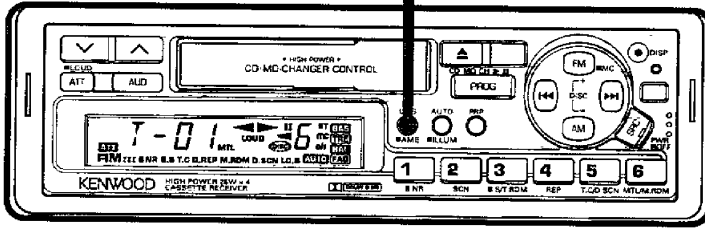

To use Local seek

Briefly press the Local seek button.
The Local seek indicator will appear
on the display, and local seek will turn
on.

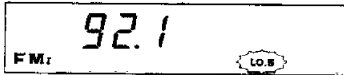

ON

To cancel Local seek

Briefly press the Local seek button.
The Local seek indicator disappears,
and local seek turns off.

Cassette tape play

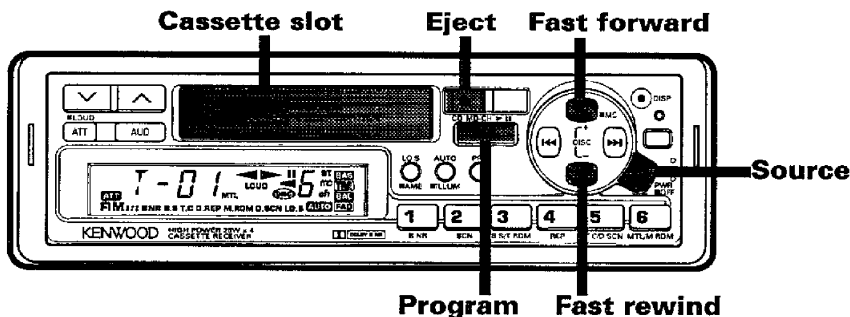

To play a cassette

Insert a cassette with the tape aperture on the right.

If there is a tape in the unit, press the Source button to select Tape mode.

The word "TAPE" will be displayed, and playback will start.

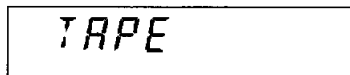

NOTE

When you insert the cassette with side A up, one of the following indicators appears or blinks on the display to indicate the tape operation.

Indicator	Tape side playing/status
▶	Side A
◀	Side B
◀▶	The tape is stopped. The player is in another mode.
▶ (with radiating lines)	Fast forwarding
◀ (with radiating lines)	Fast rewinding

CAUTION

If you do not listen to your tape, remove it from the unit and store it safely. If a cassette is left in for a long time, the tape can stick to the tape head, causing failure.

To stop and eject

Press the Eject button.

The tape playing stops and the player ejects the cassette.

To fast forward/rewind

Press the Fast forward or Fast rewind button.

When you press the fast forward button, the tape is fast forwarded.

When you press the fast rewind button, the tape is rewound.

The Operation indicator blinks.

To cancel fast forward/rewind

Press the Program button.

The fast forward/rewind is cancelled and the tape playing begins.

To switch sides

Press the Program button.

The player will play the reverse side.

Dolby B NR/Tape type selection

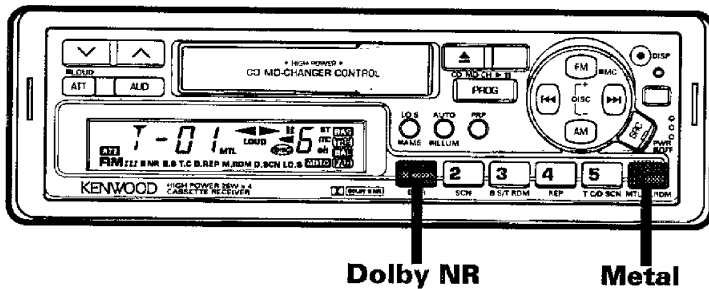

Basic operations

To use Dolby B NR

Press the Dolby NR button.
The Dolby B NR indicator will appear on the display and Dolby B NR will turn on.



ON

To cancel Dolby B NR

Press the Dolby NR button.
The Dolby B NR indicator will disappear and Dolby B NR will turn off.

To listen to metal/chrome tapes

Press the Metal button.
The Metal indicator will appear on the display and the unit will be set to the metal/chrome tape position.

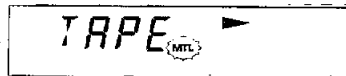

Metal/chrome tape position

To listen to normal tapes

Press the Metal button.
The Metal indicator will disappear and the unit will be set to the normal tape position. The unit is factory-set to the normal tape position.

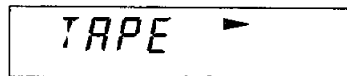

Normal tape position

Basic operations of remote control (Function of the KRC-701)

All modes

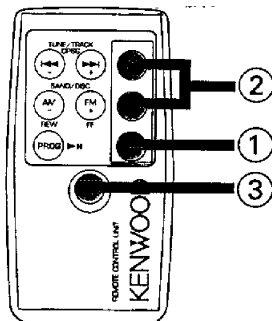

① Attenuator button

Lowers volume immediately.
To restore previous level, press this button again or set the volume to minimum.

② Volume button

The \wedge button increases the volume.
The \vee button decreases the volume.

③ Source button

Each time you press this button, the mode changes.

Replacing the battery

- Use one lithium battery (CR2025).

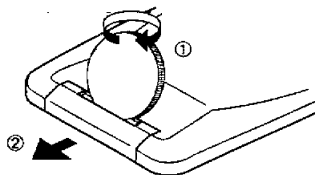

- Insert the battery according to the illustration inside the battery case, taking care not to reverse the + and - polarity.
- This battery life is about 6 months, depending on operating conditions. When it expires, replace it.

▲WARNING

- Store the lithium battery outside the reach of children. In case a person swallows a lithium battery, immediately call the doctor.

NOTE

- Before using the remote controller for the first time, pull out the film from the battery case.

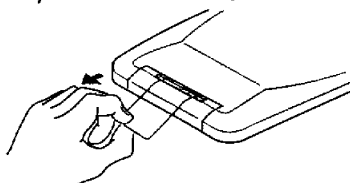

Basic operations of remote control (Function of the KRC-701)

Tape mode

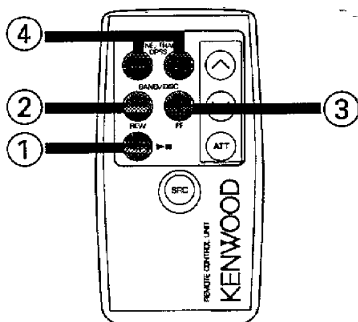

- ① **▶/|| button**
Plays the reverse side of tape.
When you press this button during fast forwarding or rewinding, it stops and tape play starts.
- ② **Rewind button**
Rewinds the tape.
- ③ **Fast forward button**
Fast forwards the tape.
- ④ **DPSS button**
The ◀◀ button skips back a specified number of tracks.
The ▶▶ button skips ahead a specified number of tracks.

Tuner mode

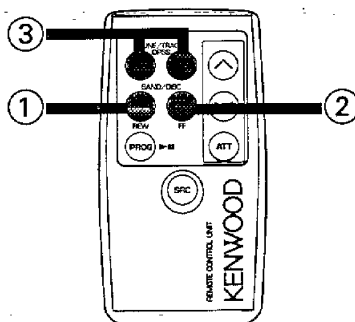

- ① **AM button**
Press the AM button to choose AM mode.
- ② **FM button**
Each time you briefly press the FM button, the band changes between FM1, FM2, and FM3.
- ③ **Tuning button**
The ◀◀ button decreases the frequency.
The ▶▶ button increases the frequency.

Disc changer mode

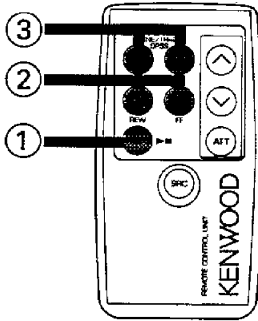

- ① **▶/II button**
Plays/pauses disc play.
- ② **Disc search button**
Press the - button to find a previous disc.
Press the + button to find a subsequent disc.
- ③ **Track search button**
Press the ◀◀ button to find a previous track.
Press the ▶▶ button to find a subsequent track.

Station preset memory

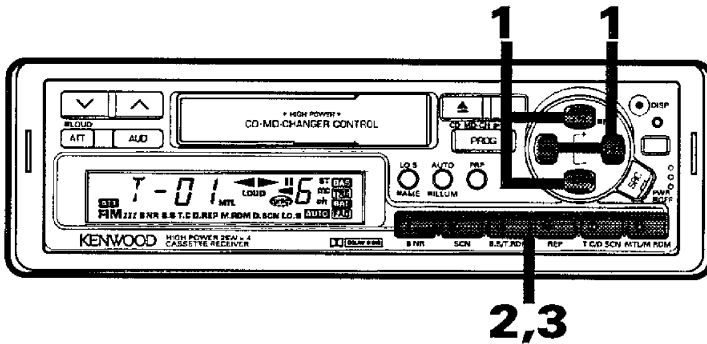

Tuner features

1

Select the band and station (frequency) you want to preset.

2

To preset

Press the Preset station button (1 to 6) you want to use for more than two seconds.

When the station identity is stored in memory, the button number indicator blinks once.

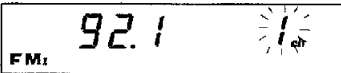

You can preset each button for one station each from the FM1, FM2, FM3, and AM bands.

NOTE

To change preset frequencies

Tune in a station you want to preset and press the Preset station button you want to change for more than two seconds.

3

To recall a preset station
Briefly press the Preset station button (1 to 6) you want.

The number of the button that you pressed will be displayed, and the preset station will be recalled.

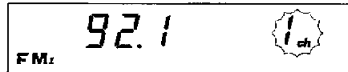

Auto memory entry

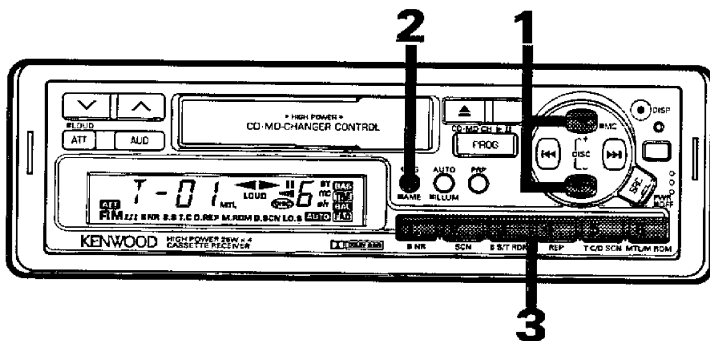

1 Select the band for Auto memory entry.

2 **Auto memory entry**
Press the Auto memory button for more than two seconds. Auto memory entry starts and preset station button numbers are displayed in order.

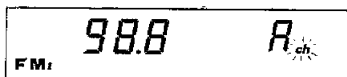

When stations are preset in all Preset stations buttons, Auto memory entry ends. The last preset station is received.

3 To recall stations stored in memory by Auto memory entry Briefly press a Preset station button (1 to 6). The number of the pressed button is displayed, and the station is recalled.

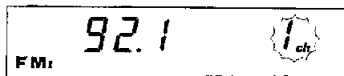

Priority radio preset

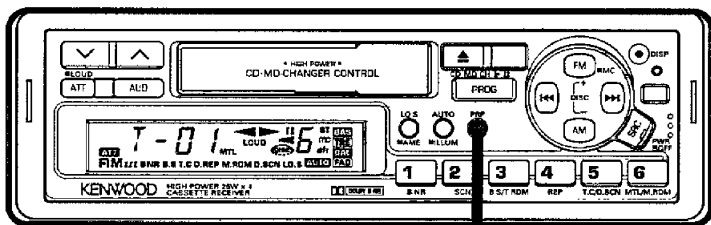

Priority radio preset

Tuner features

To recall preset stations

Press the Priority radio preset button.

The Priority radio preset indicator appears on the display and the preset station is recalled.

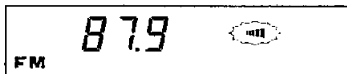

ON

To change the station to be recalled

Tune to the station you want in the Priority radio preset mode.

Only Auto seek tuning and Manual tuning can be performed in the Priority radio preset mode. Tune to the desired station by Auto seek tuning or Manual tuning.

The station you are tuned to is automatically preset, and will be recalled subsequently.

To return to the original mode

Press the Priority radio preset button.

The Priority radio preset indicator disappears and the original mode returns.

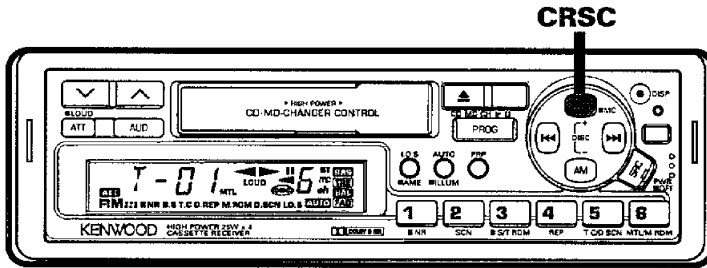

To turn CRSC on

Press the MC button for more than a second. The mc indicator disappears on the display and the CRSC function will turn on. This function is factory-set to ON.

NOTE

If FM sound is unstable:
With CRSC function on, strong electrical field (from power lines, for instance) may make the sound level fluctuate. If this happens, try turning CRSC off.

To cancel the CRSC

Press the MC button for more than a second. The mc indicator will appear on the display and the CRSC function is cancelled.

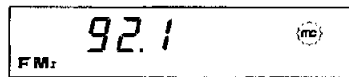

OFF

Channel space selection

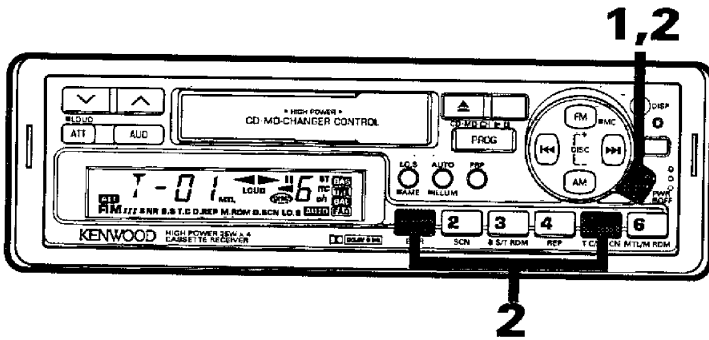

Tuner features

1
2

Turn the power off.

Hold down preset station buttons "1" and "5" and turn the power on. The frequency step is 50 kHz in FM and 9 kHz in AM.

NOTE

- When the frequency step is changed, all the contents of memory become the initial values.
- This operation is not needed when the unit is used in the United States or Canada. If it is used in any other country, the operation must be carried out so as to set the frequency to 50 kHz on FM and 9 kHz on AM.

To return to the original frequency step

Perform steps 1 and 2 again. The frequency step returns to its original value.

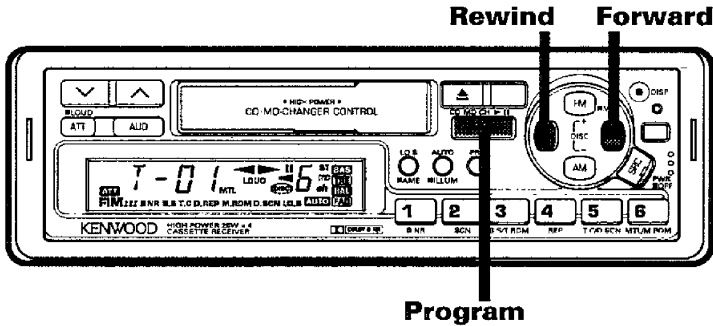

Rewind DPSS

Briefly press the Rewind button. Each time you press this button, the number of tracks to be skipped increases. The number of tracks you skip will be displayed. You can skip up to nine tracks. The tape is rewound to the specified track and playback starts.

For example:

- To skip three tracks back; Press the button four times.



NOTE

- If you press the Rewind button within three seconds after a track starts playing, the previous track will be counted as the current track (0 track).
- This function detects the beginning of a track by detecting the blank space between tracks. If the blank space between tracks is less than four seconds, or the volume is low for more than four seconds, the function will not operate correctly.

Forward DPSS

Briefly press the Forward button. Each time you press this button, the number of tracks to be skipped increases. The number of tracks you skip will be displayed. You can skip up to nine tracks. The tape is fast-forwarded to the specified track and playback starts.

For example:

- To skip five tracks ahead; Press the button five times.

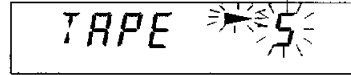

To cancel

To cancel DPSS in the middle, press the Program button. The DPSS is cancelled and playback starts.

Index scan

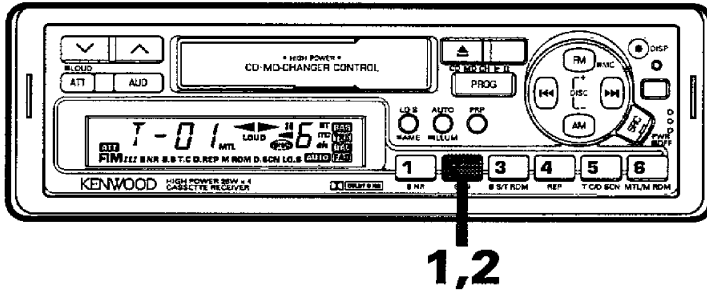

- 1** To start Index scan
Press the Scan button.
The Scan indicator blinks. The player plays the first part of each track recorded on the tape. The display will change as indicated below during index scan.

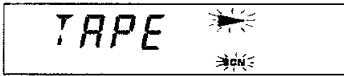

- 2** When you hear the track you want
Press the Scan button or Program button.
Index scan is cancelled, and normal playback starts.

NOTE

Index scan is cancelled when the tape stops.

Music repeat

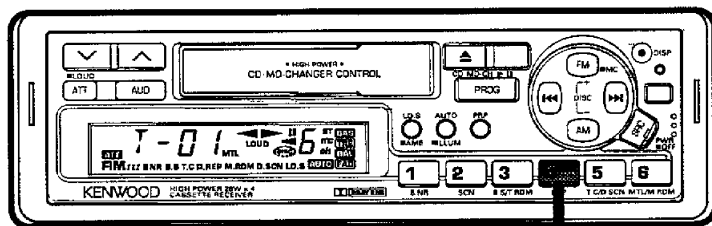

Repeat

To turn the Music repeat function on

Press the Repeat button to repeat the track you are listening to. The Repeat indicator will appear on the display and the Music repeat function will turn on.

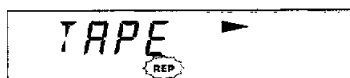

ON

When the player reaches the end of the track, it will automatically rewind the tape and play the track again.

To cancel

Press the Repeat button or Program button. The Repeat indicator disappears and the Music repeat function is cancelled.

Blank skip

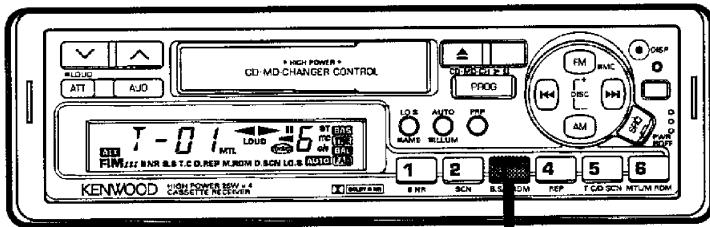

Blank skip

To turn the Blank skip function on

Press the Blank skip button. The Blank skip indicator will appear on the display and the Blank skip function will turn on. This function is factory-set to ON.

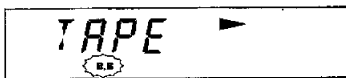

ON

NOTE

If the player encounters more than 10 seconds without sound, it will automatically fast forward to the start of the next track.

If the recording level is very low for a long time, the player may regard it as a blank and fast forward. In this case, turn the Blank skip function off.

To cancel

Press the Blank skip button. The Blank skip indicator disappears and the Blank skip function is cancelled.

Tuner call

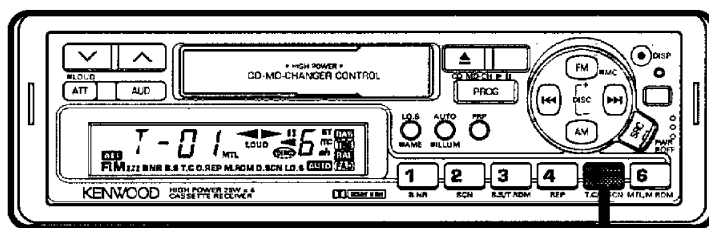

Tuner call

To turn the Tuner call function on

Press the Tuner call button.
The Tuner call indicator will appear on the display and the Tuner call function will turn on.

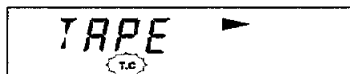

ON

The radio turns on automatically during fast forwarding or rewinding.

To cancel

Press the Tuner call button.
The Tuner call indicator disappears and the Tuner call function is cancelled.

Disc play with Disc changer

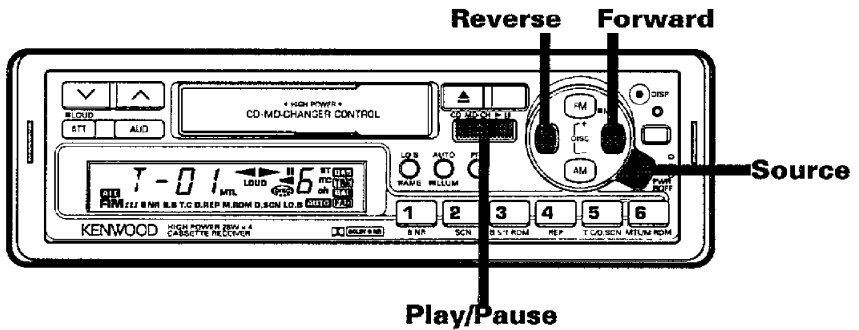

To play discs

Press the Source button to select Disc changer mode. If you see DISC display, you are in Disc changer mode.

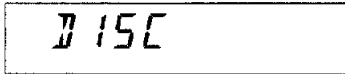

The Disc indicator will appear on the display and disc play will begin.

Disc No. display

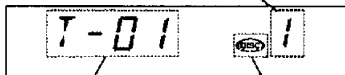

Track No. display

Disc indicator

When the player reaches the end of the last track on the disc you are playing, it will shift automatically to the first track on the next disc. When the player plays the last disc, it will return to the first disc.

When you change the discs in the auto changer, "LOAD" is displayed. Disc No. 10 is displayed as "0".

To fast forward

Hold down the Forward button.

To reverse

Hold down the Reverse button.

To pause

Press the Play/Pause button. The Pause indicator will appear on the display and disc play stops.

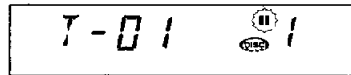

When you press the Play/Pause button again, play restarts.

NOTE

- If the MD track number surpasses "100", the last two digits of the track number are displayed.
- This unit cannot display MD disc titles.

Track/Disc search

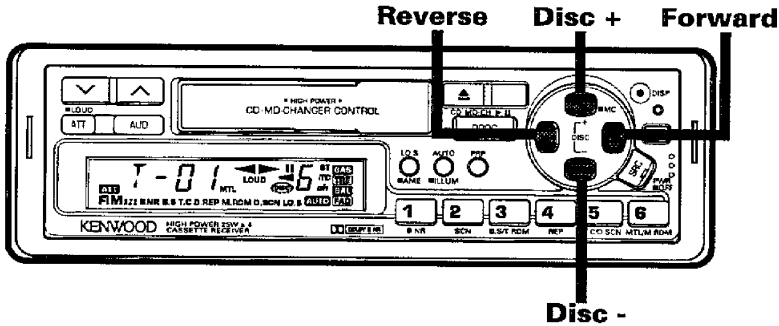

Reverse track search

Briefly press the Reverse button. When you press this button once, the player returns to the start of the track you are listening to. Each time you press the button, the track number on the display decreases. The player plays the track with the track number shown on the display.



NOTE

If you try reverse track search while playing track 1, the player will resume play at the start of track 1; it does not search for the last track.

NOTE

If you try forward track search while playing the last track on a disc, the Forward track search function does not work.

Reverse disc search

Press the Disc - button. Each time you press this button, the disc number on the display decreases. The player plays the disc with the disc number shown on the display.

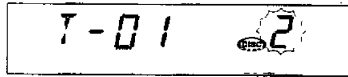

Forward track search

Briefly press the Forward button. Each time you press this button, the track number on the display increases. The player plays the track with the track number shown on the display.

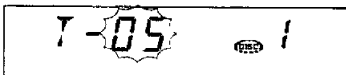

Forward disc search

Press the Disc + button. Each time you press this button, the disc number on the display increases. The player plays the disc with the disc number shown on the display.

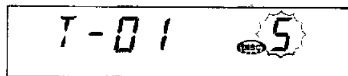

Track/Disc repeat

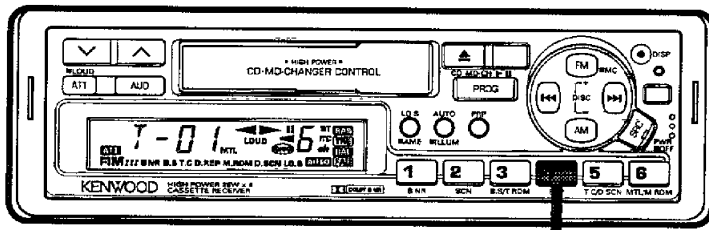

Repeat

To start Track repeat

Press the Repeat button once.
When Disc repeat is on, press the button twice.
The Repeat indicator will appear on the display and the Track repeat function will turn on.
The same track is played repeatedly.



ON

To start Disc repeat

Press the Repeat button twice.
When Track repeat is on, press the button once.
The Disc repeat indicator will appear on the display and the Disc repeat function will turn on.
The same disc is played repeatedly.

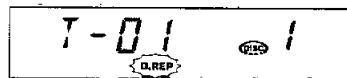

ON

To cancel Track repeat

Press the Repeat button twice.
The Repeat indicator disappears and the Track repeat function is cancelled.

NOTE

When disc play stops, Track repeat is cancelled.

To cancel Disc repeat

Press the Repeat button once.
The Disc repeat indicator disappears and the Disc repeat function is cancelled.

NOTE

When disc play stops, Disc repeat is cancelled.

Track scan

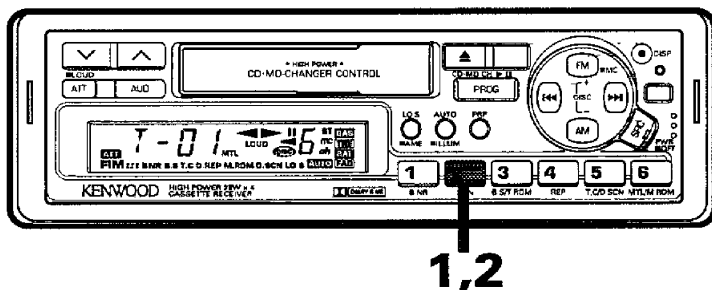

1

Press the Track scan button. The Track scan indicator will appear on the display and the player will play the first 10 seconds of each track in succession. The track number blinks on the display.

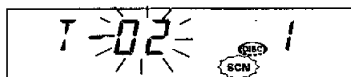

2

To select a track
Press the Track scan button. The Track scan indicator disappears and the Track scan is cancelled. Normal playback starts.

NOTE

- When disc play stops, Track scan is cancelled.
- When all tracks on the disc you are listening to are scanned, Track scan is cancelled.

Disc scan

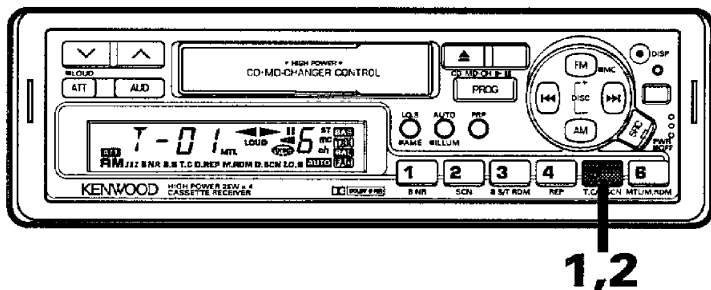

1

Press the Disc scan button.
The Disc scan indicator will appear on the display and the player will play the first 10 seconds from each disc in succession.

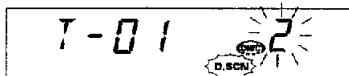

2

To select a disc

Press the Disc scan button.
The Disc scan indicator disappears and the Disc scan is cancelled.
Normal playback starts.

NOTE

- When disc play stops, Disc scan is cancelled.
- When all discs in the magazine you are listening to are scanned, Disc scan is cancelled.

Random play

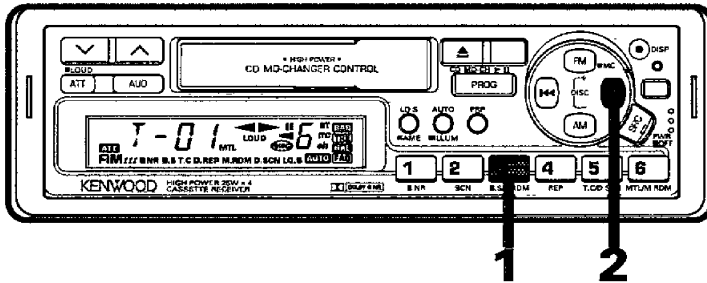

1

Press the Random button. The Random indicator will appear on the display and the player will randomly select another track from the disc you are playing. The track numbers on the display will change continuously during track selection. When a track is selected, playback will begin automatically.

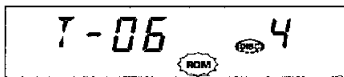

ON

NOTE

When all the tracks on a disc have been played, the player will randomly select the next disc.

2

To select another track
Press the ►► button.
The player will randomly choose another track.

To cancel

Press the Random button. The Random indicator disappears and Random play is cancelled. Normal disc play starts.

NOTE

When the disc play stops, the Random play function is cancelled.

Magazine random play

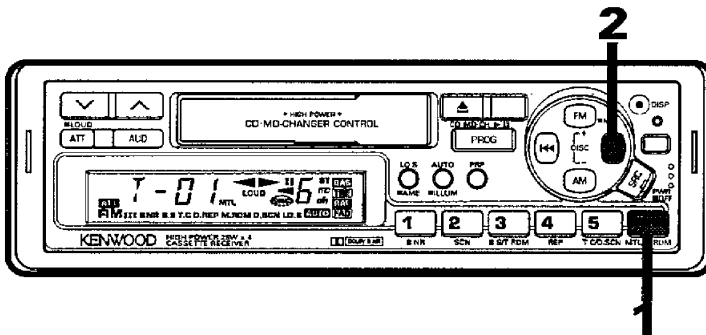

1

Press the Magazine random button. The Magazine random play indicator will appear on the display and the track select will start. The track/disc numbers on the display will change continuously during track selection. When a track is selected, playback will begin automatically.



ON

NOTE

The Magazine random play is not available if you use the KDC-C200/C300/C400/C301/C401.

2

To select another track
Press the ►► button.

The player will randomly choose another track.

To cancel

Press the Magazine random button. The Magazine random indicator disappears and Magazine random play is cancelled. Normal disc play starts.

NOTE

- When disc play stops, the Magazine random play function is cancelled.
- The Magazine random selection time changes according to the number of discs in the magazine.

Clock display/setting

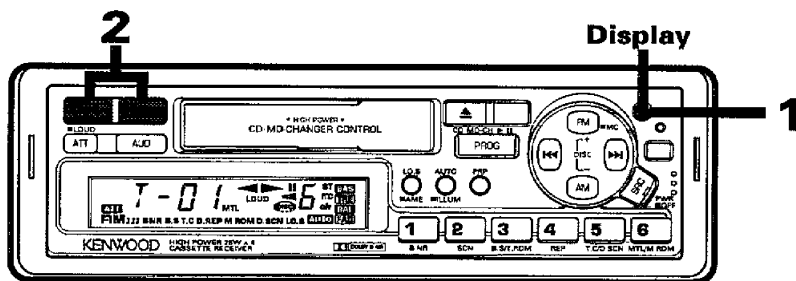

To recall clock display

Press the Display button.

The display changes as listed in the table.

Mode	Displays
Tuner	Frequency ↔ Clock
Tape	"TAPE" ↔ Clock
Disc changer	Track number → Track time → Clock →
All standby	"OFF" ↔ Clock

"A" appears in AM and "P" appears in PM.

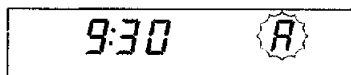

To set the clock

1

If the time is not displayed, press the Display button.
The time is displayed.

2

Hold down the Display button, and press the ∇/\wedge button.
Press the ∇ button to adjust the hour and the \wedge button to adjust the minutes.

Audio controls

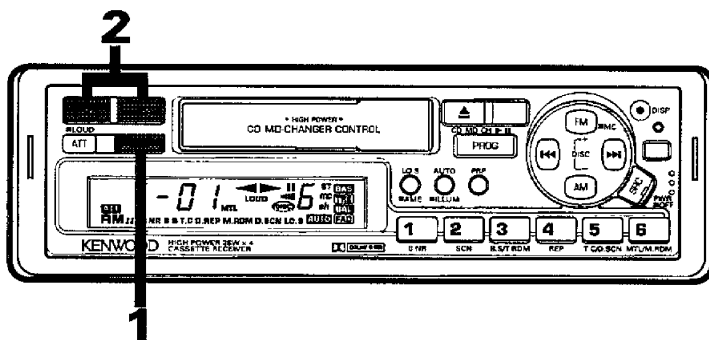

- 1** To select the control mode
Press the Audio button.
Each time you press this button, the adjustment mode changes as follows:
Bass -> Treble -> Balance -> Fader -> Volume. If you do not perform the next operation within five seconds, the Volume adjustment mode (normal mode) will return.

NOTE

Source tone memory

This unit allows the Tone (Bass and Treble) control to be set independently for each source mode (Tape, FM, AM, and disc). The tone set in Tape mode is recalled automatically when you select Tape, and the tone set in Tuner mode is recalled automatically when you select Tuner.

- 2** To adjust each mode
Press the Audio control button.
Adjust each mode according to the table.

To cancel

Press the Audio button for more than a second.
The Volume adjustment mode will return.

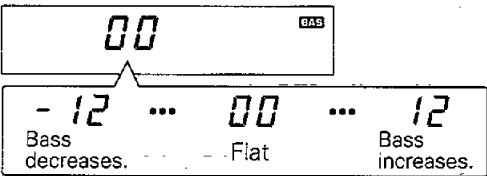
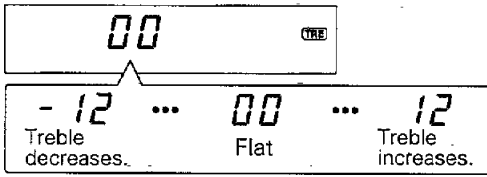
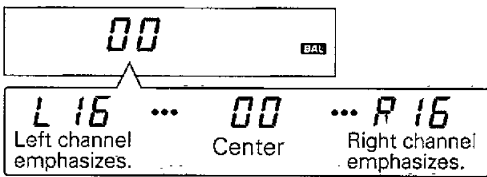
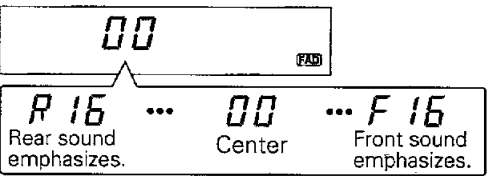
Display	Operation of Audio control button	
	Audio down button	Audio up button
<p>Bass adjustment</p> 	Bass decreases.	Bass increases.
<p>Treble adjustment</p> 	Treble decreases.	Treble increases.
<p>Balance adjustment</p> 	Left channel emphasizes.	Right channel emphasizes.
<p>Fader adjustment</p> 	Rear sound emphasizes.	Front sound emphasizes.

Selectable illumination

Function of the KRC-701

Illumination

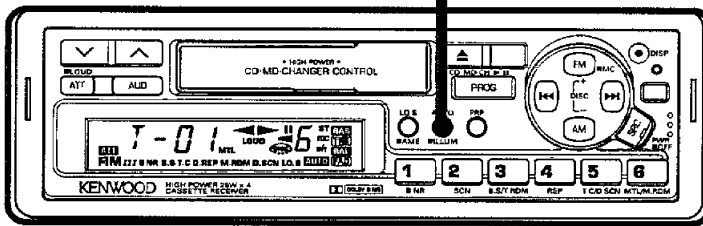

To change illumination colour

Press the Illumination button for more than a second.

Each time you press this button, the illumination will change from green to orange or vice versa.

Theft deterrent faceplate

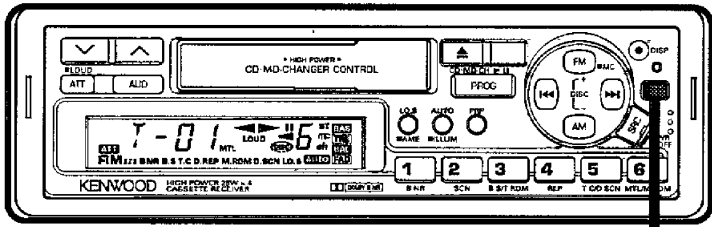

Release

To remove the faceplate

Press the Release button.

The faceplate is unlocked and can be detached.

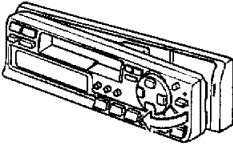

CAUTION

- Place the faceplate in the storage case to prevent shocks. Since it is a precision piece of equipment, if it is subject to shock, it may fail.

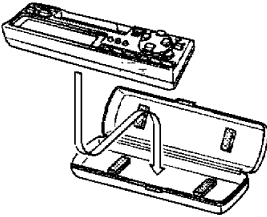

- Do not expose the faceplate or its storage case to direct sunlight or high heat, otherwise it may be deformed or fail.

To install the faceplate

1

Align the projections on the faceplate with the grooves on the faceplate.

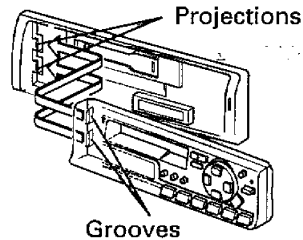

2

Press the faceplate until it clicks. The faceplate is locked in place and the unit becomes operable.

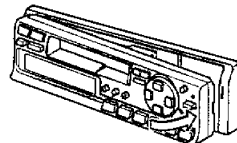

Disabled system indicator

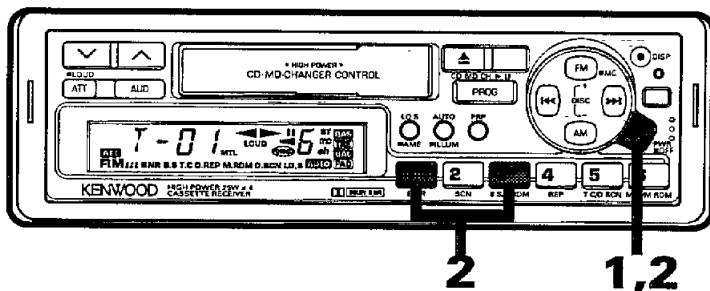

1

Turn the power off.





2

Hold down preset station buttons "1" and "3" and turn the power on. The Disabled system indicator function turns off, and the LED does not blink when the faceplate is detached.

To turn the Disabled system indicator on

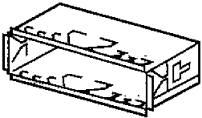
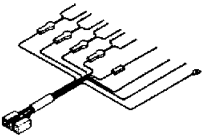
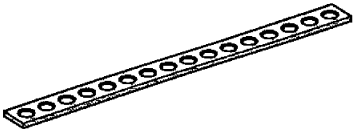
Perform steps 1 and 2 again. The LED blinks when the faceplate is detached.

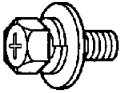
Accessories

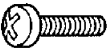
Part name	External view	Number of items
Mounting sleeve		1
Wiring harness		1
Metal mounting strap		1
Removal tool		2
Screw with washer (M4 × 8)		1
Machine screw (M5 × 6)		4
Machine screw (φ4 × 16)		1

Installation procedure

Installation

1. Remove the ignition key and disconnect the negative (-) terminal of the battery to prevent short circuits.
2. Connect the input and output cables of the units.
3. Connect the speaker cables of the wiring harness.
4. Connect the ground cable, battery cable, and ignition cable of the wiring harness in the order listed.
5. Connect the wiring harness connectors to the unit.
6. Install the unit in the car.
7. Connect the negative (-) terminal of the battery.
8. Press the Reset button.

CAUTION

- Check that no unconnected cables or connectors are touching the car body. Do not remove caps from unconnected cables or connectors to prevent short circuits.
- Connect the speaker cables to appropriate speaker connectors separately. Sharing the negative cable of the speaker or grounding speaker cables to the metal body of the car can cause this unit to fail.
- After installation, check that the brake lamps, wipers, and wipers work properly.
- Some CD auto-changers require a conversion cord for connection. See the "Safety precautions" for details.
- Insulate unconnected ends of cords with vinyl tape or similar.

Installation

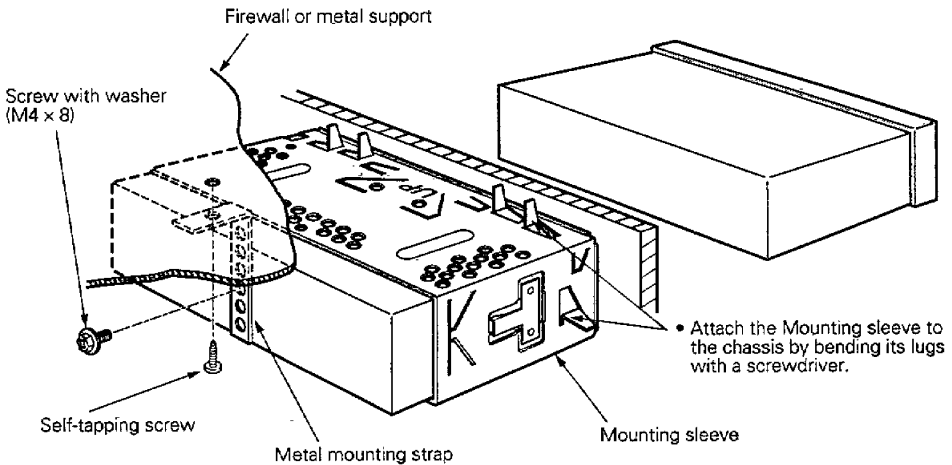

NOTE

Install the unit securely. If the unit is unstable, it may malfunction, causing sound skipping.

To install in the Japanese car

1. Remove the escutcheon.

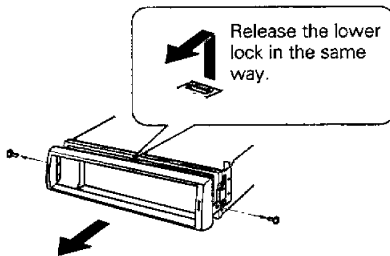

2. Fit the Machine screws (M5 x 6) (accessories) into the appropriate (two) holes in the car bracket.

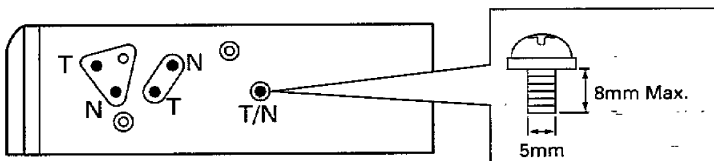

Installation

Installation

To remove the unit.

1. Remove the Screws with washer (M4 x 8) holding on the back panel.
2. Insert the removal tools deep into the slots of the unit.

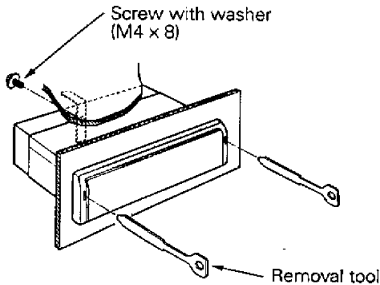

3. Push the tools down and pull them toward you until the set is drawn out halfway.

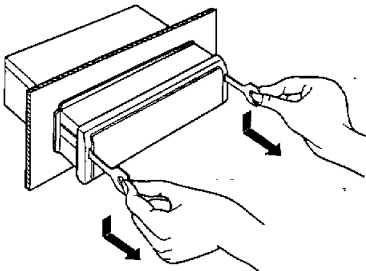

4. Take the set out by hand, being careful not to drop it.

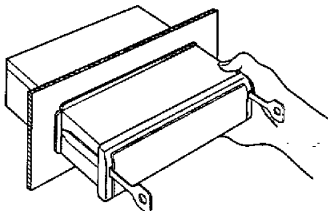

How to use the faceplate fastening screw.

When you want to fasten the faceplate to the main unit so that they cannot be separated, attach the provided machine screw ($\phi 4 \times 16$ mm) into the screw hole shown in the illustration below.

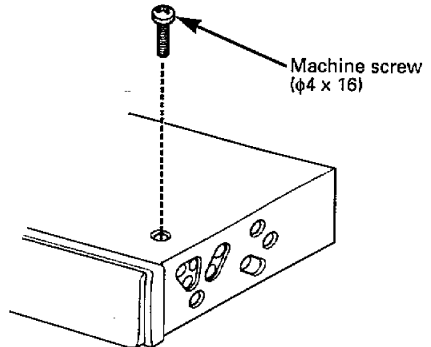

CAUTION

- Be sure to attach the machine screw ($\phi 4 \times 16$ mm) to the specified screw hole. If it is attached to other screw hole, it will contact the mechanical parts inside the unit and cause damage to them.
- Never insert the machine screw ($\phi 4 \times 16$ mm) into other screw hole than specified.

Connections

NOTE

To connect the Disc-changer, consult your Disc-changer manual.

* Circled numbers indicate the procedures described in the Installation Procedure.

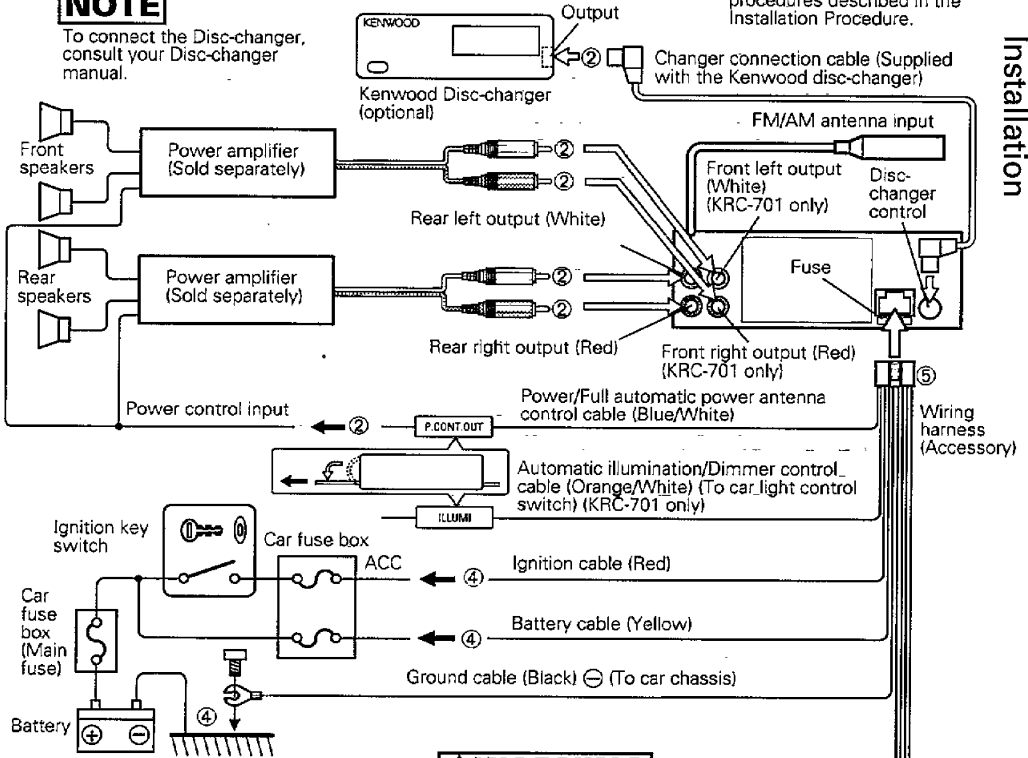

Installation

CAUTION

When two speakers are connected to the system, be sure to connect both of them to the front output or rear output. In other words, do not connect the positive connector of the left speaker to the front output and the negative connector to the rear output.

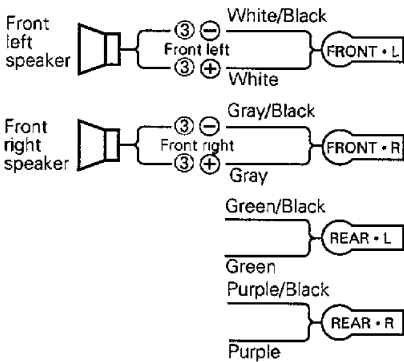

WARNING

To prevent fire when the ignition cable (Red) or battery cable (Yellow) is short-circuited by coming into contact with the vehicle chassis (ground), only connect the power supply after making the fuse box connections.

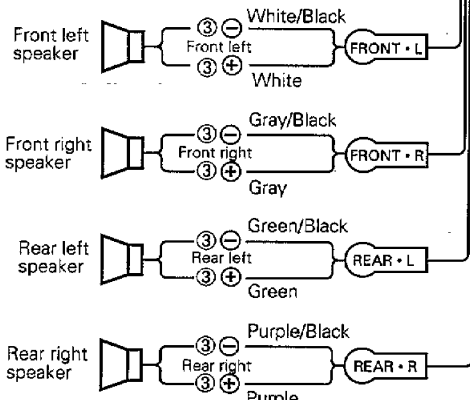

Troubleshooting guide

Often, what appears to be a malfunction is due to user error. Before calling for service please consult the following table.

Symptom	Cause	Remedy
The power is not turned on.	The wiring harness fuse blows.	Check cables for shorts, then replace the fuse with one of with the same rating (shown on the case).
No sound or sound is low.	The volume level is minimum.	Raise the volume level.
	The fader or balance is set to one side.	Adjust the fader and balance.
	The input/output cable or wiring harness is connected incorrectly.	Connect the input/output cable or wiring harness correctly. See "Connections" (Page 45).
The unit does not work properly when a button is pressed.	The cassette tape is faulty.	Use another cassette.
	The microcomputer malfunctions.	Press the Reset button on the front panel.
Sound quality is poor. (Sound distortion)	The volume level is too high.	Use the appropriate volume level.
	The tape head is dirty.	Clean the head. See "Head cleaning (Page 4)".
	A speaker cable is pressed by a screw in the car.	Check the speaker cabling.
A cassette cannot be inserted.	A speaker cable is shared.	Connect the speaker output connectors to the separate speaker connectors.
	The cassette is deformed.	Use another cassette.
Poor radio reception.	The cassette has been inserted incorrectly.	Insert the cassette with the tape aperture on the right.
	The car antenna is not extended.	Extend the antenna.
Tape mode is not selected.	The antenna control cable is not connected.	Connect the cable correctly. See "Connections (Page 45)".
	No cassette is inserted.	Insert a cassette into the unit.
When the ignition key switch is set to OFF, the memory contents disappear.	The battery cable is not connected correctly.	Connect the cable correctly. See "Connections (Page 45)".

Disc changer section

Symptom	Cause	Remedy
Disc changer mode cannot be selected.	Disc changer input is not connected to the unit.	Connect the Disc changer input to the unit.
Disc play does not start.	Power button is not turned ON.	Turn the power button ON, press the SOURCE button, and select the Disc changer mode.
The specified disc is not played; a different disc is played instead.	The specified disc is very dirty.	Check and, if possible, clean the disc.
	The disc is loaded upside down.	Eject the disc magazine and insert the disc correctly.
	Two discs are inserted in a slot.	Eject the disc magazine and insert the discs correctly.
	The number of the slot into which the disc is inserted is different from the number of the specified disc.	Eject the disc magazine and check the number of the specified disc.
Sound skips due to vibration.	The disc is severely damaged.	Use another disc.
	Something is touching the Disc changer.	Keep it away from the Disc changer.
Sound quality is poor.	The disc is dirty or damaged.	If sound skips at the same part, the disc is faulty. Check and, if possible, clean the disc.
	The recording of the disc is poor.	Try playing another disc. If the sound is good, the fault was with the original disc.
No sound is heard even though the information concerning the Disc changer is displayed.	The disc is dirty or damaged.	Check and, if possible, clean the disc.
	Volume is set to minimum level.	Raise the volume level.
	The microcomputer does not function correctly.	Press the Reset button on this unit.
The specified track is not played.	The system is not connected properly.	Connect the system properly. See "Connections" (Page 45).
	The player is set to RANDOM PLAY/MAGAZINE RANDOM PLAY.	Turn off RANDOM PLAY/MAGAZINE RANDOM PLAY.

In some cases, you may see one of the following error messages on your unit's display

- E-01:** No disc magazine in changer. Disc magazine is not inserted properly.
⇒ Insert the disc magazine properly.
- E-02:** No disc in disc magazine.
⇒ Load a disc in the disc magazine.
- E-04:** Disc is too dirty. The disc is upside down. The disc is damaged.
⇒ Clean the disc and insert it correctly.
- E-10:** No data is recorded on the MD.
⇒ The player plays the next disc automatically.
- E-11:** No track is recorded on the MD.
⇒ The player plays the next disc automatically.
- E-99:** Mechanism malfunction.
⇒ Press the Reset button. If the "E-99" message does not disappear, contact local service center.
- E-0d:** When the temperature exceeds 60°C, a protection circuit will stop all operations. This message will then be displayed.
⇒ Let the place where the changer is located cool down. As soon as it has cooled, the changer starts playing.

Specifications

Specifications subject to change without notice.

Specifications

FM tuner section

Frequency range (200 kHz space)	87.9 MHz – 107.9 MHz
(50 kHz space)	87.5 MHz – 108.0 MHz
Usable sensitivity (S/N = 30 dB)	9.3 dBf (0.8 μ V / 75 Ω)
Quiet sensitivity (S/N = 50 dB)	15.2 dBf (1.6 μ V / 75 Ω)
Frequency response (\pm 3.0 dB)	30 Hz – 15 kHz
Signal to Noise ratio	73 dB
Selectivity	100 dB
Capture Ratio	1.5 dB
Image Response Ratio	70 dB
IF Response Ratio	120 dB
ST. separation	40 dB (1 kHz)

AM tuner section

Frequency range (9 kHz space)	531 kHz – 1611 kHz
(10 kHz space)	530 kHz – 1700 kHz
Usable sensitivity	28 dB (30 μ V)

Cassette deck section

Tape speed	4.76 cm / sec.
Wow & Flutter (WRMS)	0.08 %
Fast winding time (C-60)	100 sec.
Frequency response (120 μ s)	30 Hz – 16 kHz (\pm 3 dB)
(70 μ s)	30 Hz – 18 kHz (\pm 3 dB)
Separation	43 dB (1 kHz)
Signal to Noise ratio (Dolby B NR OFF)	54 dB
(Dolby B NR ON)	63 dB

Audio section

Preout level / Load	1500 mV (Max.) / 10 k Ω
Maximum output power	25 W \times 4
Output power (4 Ω , 1 KHz, 10% THD)	20 W \times 4
(4 Ω , 30 Hz – 20 KHz, 1% THD)	15 W \times 4
Tone	Bass: 100 Hz \pm 10 dB
	Treble: 10 kHz \pm 10 dB

General

Operating voltage	14.4 V (11 – 16 V allowable)
Current consumption	6.9 A at Rated power
Installation size (W \times H \times D)	182 \times 53 \times 154 mm
	7-3/16 \times 2-1/16 \times 6-1/16 in.
Weight	1.7 kg (3.7 LBS)

Free Manuals Download Website

<http://myh66.com>

<http://usermanuals.us>

<http://www.somanuals.com>

<http://www.4manuals.cc>

<http://www.manual-lib.com>

<http://www.404manual.com>

<http://www.luxmanual.com>

<http://aubethermostatmanual.com>

Golf course search by state

<http://golfingnear.com>

Email search by domain

<http://emailbydomain.com>

Auto manuals search

<http://auto.somanuals.com>

TV manuals search

<http://tv.somanuals.com>