

# KENWOOD

CD-RECEIVER

# KDC-237

---

## INSTRUCTION MANUAL

Kenwood Corporation



© B64-3700-00/00 (E0/E20)

# Contents

---

## **Safety precautions** **3**

---

## **Notes** **4**

---

## **General features** **6**

---

- Power
- Selecting the Source
- Volume
- Attenuator
- Audio Control
- Audio Setup
- Bass Boost
- Speaker Setting
- Switching Display
- Theft Deterrent Faceplate
- TEL Mute

## **Tuner features** **10**

---

- Tuning
- Station Preset Memory
- Auto Memory Entry
- Preset Tuning

## **RDS features** **12**

---

- Traffic Information
- PTY (Program Type)
- Program Type preset
- Changing Language for PTY Function

## **CD player features** **15**

---

- Playing CD
- Fast Forwarding and Reversing
- Track Search
- Track Repeat
- Scan Play
- Random Play

## **Menu system** **17**

---

- Menu System
- Touch Sensor Tone
- Manual Clock Adjustment
- Synchronize Clock
- DSI (Disabled System Indicator)
- Dimmer
- News Bulletin with Timeout Setting
- Local Seek
- Tuning Mode
- AF (Alternative Frequency)
- Restricting RDS Region (Region Restrict Function)
- Auto TP Seek
- Monaural Reception
- Auxiliary Input Display Setting
- Built-in Auxiliary input Setting
- Power OFF Timer
- Demonstration mode Setting

## **Accessories/ Installation Procedure** **21**

---

## **Connecting Wires to Terminals** **22**

---

## **Installation** **24**

---

## **Troubleshooting Guide** **25**

---

## **Specifications** **26**

---

## Safety precautions

---

### **⚠ WARNING**

---

#### **To prevent injury or fire, take the following precautions:**

- To prevent a short circuit, never put or leave any metallic objects (such as coins or metal tools) inside the unit.
- Mounting and wiring this product requires skills and experience. For safety's sake, leave the mounting and wiring work to professionals.

### **⚠ CAUTION**

---

#### **To prevent damage to the machine, take the following precautions:**

- Make sure to ground the unit to a negative 12V DC power supply.
- Do not install the unit in a spot exposed to direct sunlight or excessive heat or humidity. Also avoid places with too much dust or the possibility of water splashing.
- Do not place the faceplate (and the faceplate case) in areas exposed to direct sunlight, excessive heat or humidity. Also avoid places with too much dust or the possibility of water splashing.
- To prevent deterioration, do not touch the terminals of the unit or faceplate with your fingers.
- Do not subject the faceplate to excessive shock, as it is a piece of precision equipment.
- When replacing a fuse, only use a new fuse with the prescribed rating. Using a fuse with the wrong rating may cause your unit to malfunction.
- Do not use your own screws. Use only the screws provided. If you use the wrong screws, you could damage the unit.

#### **Do Not Load 8 cm (3 in.) CDs in the CD slot**

If you try to load a 8 cm (3 in.) CD with its adapter into the unit, the adapter might separate from the CD and damage the unit.

### **Lens Fogging**

When you turn on the car heater in cold weather, dew or condensation may form on the lens in the CD player of the unit. Called lens fogging, this condensation on the lens may not allow CDs to play. In such a situation, remove the disc and wait for the condensation to evaporate. If the unit still does not operate normally after a while, consult your Kenwood dealer.

## Notes

- If you experience problems during installation, consult your Kenwood dealer.
- When you purchase optional accessories, check with your Kenwood dealer to make sure that they work with your model and in your area.
- The characters which can be displayed by this unit are A-Z 0-9 @ " ' ` % & \* + - = , . / \ < > [ ] ( ) ; : ^ - { } ~ .
- The RDS feature won't work where the service is not supported by any broadcasting station.
- The illustrations of the display and the panel appearing in this manual are examples used to explain more clearly how the controls are used. Therefore, what appears on the display in the illustrations may differ from what appears on the display on the actual equipment, and some of the illustrations on the display may be inapplicable.

### How to reset your unit

- If the unit fails to operate properly, press the Reset button. The unit returns to factory settings when the Reset button is pressed.

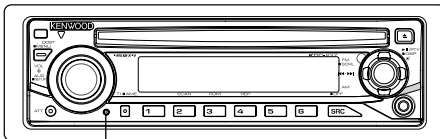

Reset button

### Cleaning the Unit

If the faceplate of this unit is stained, wipe it with a dry soft cloth such as a silicon cloth.

If the faceplate is stained badly, wipe the stain off with a cloth moistened with neutral cleaner, then wipe it again with a clean soft dry cloth.



- Applying spray cleaner directly to the unit may affect its mechanical parts. Wiping the faceplate with a hard cloth or using a volatile liquid such as thinner or alcohol may scratch the surface or erase characters.

### Cleaning the Faceplate Terminals

If the terminals on the unit or faceplate get dirty, wipe them with a clean soft dry cloth.

### Before using this unit for the first time

This unit is initially set on the Demonstration mode.

When using this unit for the first time, cancel the <Demonstration mode Setting> (page 20).

## Handling CDs

- Do not touch the recording surface of the CD.
- Do not stick tape etc. on the CD, or use a CD with tape stuck on it.
- Do not use disc type accessories.
- Clean from the center of the disc and move outward.
- When removing CDs from this unit, pull them out horizontally.
- If the CD center hole or outside rim has burrs, use the CD only after removing the burrs with a ballpoint pen etc.

## CDs that cannot be used

- CDs that are not round cannot be used.

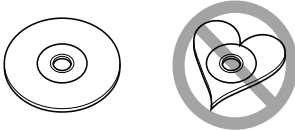

- CDs with coloring on the recording surface or CDs that are dirty cannot be used.
- This unit can only play the CDs with .  
This unit may not correctly play discs which do not have the mark.
- You cannot play a CD-R or CD-RW that has not been finalized. (For the finalization process refer to your CD-R/CD-RW writing software, and your CD-R/CD-RW recorder instruction manual.)

This Product is not installed by the manufacturer of a vehicle on the production line, nor by the professional importer of a vehicle into an EU Member State.

## Information on Disposal of Old Electrical and Electronic Equipment (applicable for EU countries that have adopted separate waste collection systems)



Products with the symbol (crossed-out wheeled bin) cannot be disposed as household waste.

Old electrical and electronic equipment should be recycled at a facility capable of handling these items and their waste byproducts. Contact your local authority for details in locating a recycle facility nearest to you. Proper recycling and waste disposal will help conserve resources whilst preventing detrimental effects on our health and the environment.

## The marking of products using lasers (Except for some areas)

**CLASS 1  
LASER PRODUCT**

The label is attached to the chassis/case and says that the component uses laser beams that have been classified as Class 1. It means that the unit is utilizing laser beams that are of a weaker class. There is no danger of hazardous radiation outside the unit.

# General features

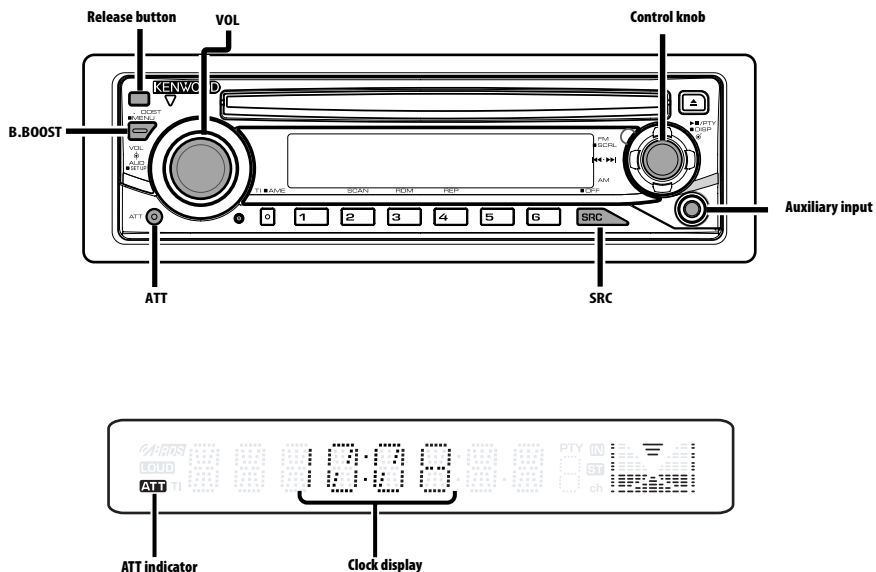

## Power

### Turning ON the Power

Press the [SRC] button.

### Turning OFF the Power

Press the [SRC] button for at least 1 second.



- This unit automatically turns full power OFF after 20 minutes lapses in Standby mode in order to save the vehicle's battery. The time until full power OFF can be set in <Power OFF Timer> (page 20).
- Use the mini-plug which is stereo type and does not have any resistance.

## Selecting the Source

Press the [SRC] button.

Source required	Display
Tuner	"TUNER"
CD	"CD"
Auxiliary input*	"AUX"
Standby (Illumination only mode)	"STANDBY"

\* An equipment such as a portable audio player can be connected to the auxiliary input terminal using a commercially available mini-plug (3.5Ø).

## Volume

### Increasing Volume

Turn the [VOL] knob clockwise.

### Decreasing Volume

Turn the [VOL] knob counterclockwise.

## Attenuator

Turning the volume down quickly.

**Press the [ATT] button.**

Each time you press the button, the Attenuator turns ON and OFF.

When the Attenuator is ON, the "ATT" indicator blinks.

## Audio Control

### 1 Select the source to adjust

**Press the [SRC] button.**

### 2 Enter Audio Control mode

**Press the [VOL] knob.**

### 3 Select the Audio item to adjust

**Press the [VOL] knob.**

Each time you press the knob, the item to be adjusted alternates between the items shown in the table below.

### 4 Adjust the Audio item

**Turn the [VOL] knob.**

Adjustment Item	Display	Range
System Q	"NATURAL"/"ROCK"/ "POPS"/"EASY"/ "TOP40"/"JAZZ"	Natural/Rock/Pops/Easy/ Top 40/Jazz
Bass level	"BAS L"	-8 — +8
Middle level	"MID L"	-8 — +8
Treble level	"TRE L"	-8 — +8
Balance	"BAL"	Left 15 — Right 15
Fader	"FAD"	Rear 15 — Front 15

*Exit Audio Control mode (Volume control mode)*



### About System Q

- You can recall the best sound setting preset for different types of music.
- Change each setting value with the <Speaker Setting> (page 8). First, select the speaker type with the Speaker setting.
- "USER": This appears when Bass level, Middle level, and Treble level are adjusted. When "USER" is selected, these levels are recalled.

### 5 Exit Audio Control mode

**Press any button.**

Press a button other than the [VOL] knob and [ATT] button.

## Audio Setup

Setting the Sound system, such as Volume offset.

### 1 Select the source to adjust

**Press the [SRC] button.**

### 2 Enter Audio Setup mode

**Press the [VOL] knob for at least 1 second.**

### 3 Adjust the Audio setup item

**Turn the [VOL] knob.**

Adjustment Item	Display	Range
Volume offset	"V-OFF"	-8 — ±0 (AUX : -8 — +8)



- Volume offset: Sets each source's volume as a difference from the basic volume.

### 4 Exit Audio Setup mode

**Press the [VOL] knob for at least 1 second.**

## Bass Boost

Bass sound can be enhanced by one-touch operation.

**Press the [B.BOOST] button.**

When you press the button once, the current Bass Boost setting is displayed.

Each time you press the button, the Bass Boost setting alternates.

Setting	Display
Bass Boost 1	"BB-L L1"
Bass Boost 2	"BB-L L2"
Bass Boost off	"BB-L OFF"

# General features

## Speaker Setting

Fine-tuning so that the System Q value is optimal when setting the speaker type.

### 1 Enter Standby

Press the [SRC] button.

Select the "STANDBY" display.

### 2 Enter Speaker Setting mode

Press the [VOL] knob.

### 3 Select the Speaker type

Turn the [VOL] knob.

Each time you turn the knob, the setting alternates between the settings shown in the table below.

Speaker type	Display
OFF	"SP OFF"
For 5 & 4 in. speaker	"SP 5/4"
For 6 & 6x9 in. speaker	"SP 6*9/6"
For the OEM speaker	"SP OEM"

### 4 Exit Speaker Setting mode

Press the [VOL] knob.

## Switching Display

Changing the information displayed.

### 1 Enter Switching Display mode

Press the Control knob for at least 1 second.

"DISP SEL" is displayed.

### 2 Select the Display item

Push the Control knob towards [◀◀] or [▶▶].

#### In Tuner source

Information	Display
Frequency (MW, LW)	"FREQ"
Program Service name (FM)	"FREQ/PS"
Clock	"CLOCK"

#### In CD source

Information	Display
Play time & Track number	"P-TIME"
Clock	"CLOCK"

#### In Standby/ Auxiliary input source

Information	Display
Source name	"SRC NAME"
Clock	"CLOCK"

### 3 Exit Switching Display mode

Press the Control knob.

## Theft Deterrent Faceplate

The faceplate of the unit can be detached and taken with you, helping to deter theft.

### Removing the Faceplate

Press the Release button.

The faceplate unlocks, allowing you to detach it.



- The faceplate is a precision piece of equipment and can be damaged by shocks or jolts.
- Keep the faceplate in its faceplate case while detached.
- Do not expose the faceplate (and the faceplate case) to direct sunlight or excessive heat or humidity. Also avoid places with too much dust or the possibility of water splashing.

### Reattaching the Faceplate

#### 1 Align the projections on the unit with the grooves on the faceplate.

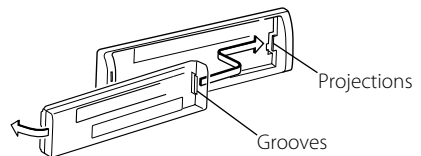

#### 2 Push the faceplate in until it clicks.

The faceplate is locked in place, allowing you to use the unit.



---

## TEL Mute

The audio system automatically mutes when a call comes in.

### ***When a call comes in***

"CALL" is displayed.

The audio system pauses.

### ***Listening to the audio during a call***

**Press the [SRC] button.**

The "CALL" display disappears and the audio system comes back ON.

### ***When the call ends***

**Hang up the phone.**

The "CALL" display disappears and the audio system comes back ON.



- To use the TEL Mute feature, you need to hook up the MUTE wire to your telephone using a commercial telephone accessory. Refer to <Connecting Wires to Terminals> (page 22).

## Tuner features

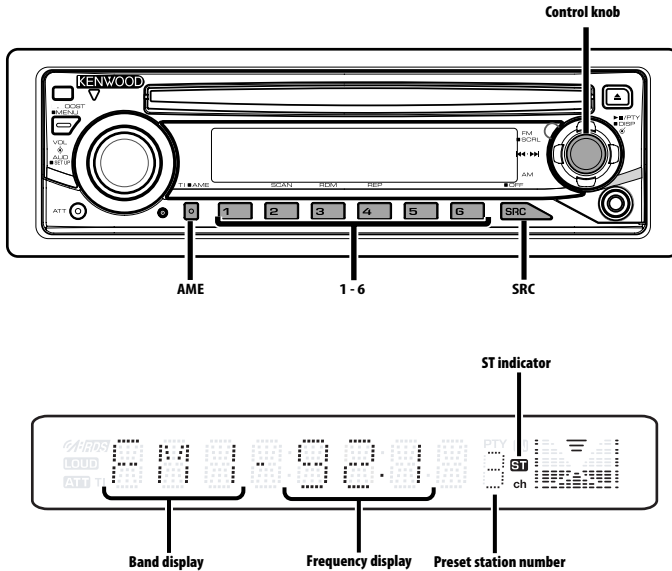

### Tuning

Selecting the station.

#### 1 Select tuner source

Press the [SRC] button.

Select the "TUNER" display.

#### 2 Select the band

Push the Control knob towards [FM] or [AM].

Each time you push the knob toward [FM], it switches between the FM1, FM2, and FM3 bands.

#### 3 Tune up or down band

Push the Control knob towards [◀◀] or [▶▶].



- During reception of stereo stations the "ST" indicator is ON.

### Station Preset Memory

Putting a station in the memory.

#### 1 Select the band

Push the Control knob towards [FM] or [AM].

#### 2 Select the frequency to put in the memory

Push the Control knob towards [◀◀] or [▶▶].

#### 3 Put the frequency in the memory

Press the desired [1] — [6] button for at least 2 seconds.

The preset number display blinks 1 time.

On each band, 1 station can be put in the memory on each [1] — [6] button.

---

## Auto Memory Entry

Putting stations with good reception in the memory automatically.

### 1 Select the band for Auto Memory Entry

Push the Control knob towards [FM] or [AM].

### 2 Open Auto Memory Entry

Press the [AME] button for at least 2 seconds.

"A-MEMORY" is displayed.

When 6 stations that can be received are put in the memory Auto Memory Entry closes.



- When the <AF (Alternative Frequency)> (page 19) is ON, only RDS stations are put in the memory.

- When Auto Memory Entry is done in the FM2 band, the RDS stations preset in the FM1 band are not put in the memory.

Likewise, when Auto Memory Entry is done in the FM3 band, RDS stations preset in FM1 or FM2 are not put in the memory.

---

## Preset Tuning

Recalling the stations in the memory.

### 1 Select the band

Push the Control knob towards [FM] or [AM].

### 2 Recall the station

Press the desired [1] — [6] button.

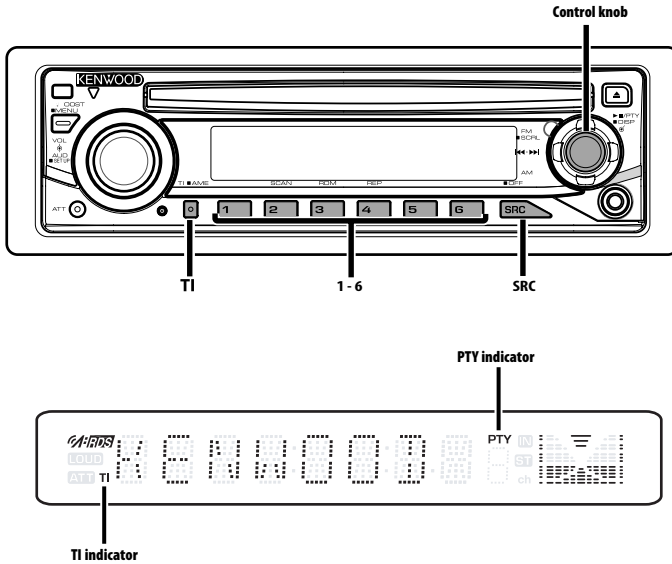

### Traffic Information

Changing to traffic information automatically when a traffic bulletin starts even when you are not listening to the radio.

#### Press the [TI] button.

Each time you press the button, the Traffic information function turns ON and OFF.

When traffic information is ON, "TI" indicator is ON.

When a traffic information station is not being received the "TI" indicator blinks.

When a traffic bulletin starts, "TRAFFIC" is displayed and the audio changes to traffic information.



- During reception of an AM station when the Traffic Information function is turned ON, the frequency changes to an FM station.
- During reception of traffic information the adjusted volume is automatically remembered, and the next time the audio changes to traffic information, the volume automatically becomes the remembered volume.

#### Receiving other traffic information stations

Push the Control knob towards [◀◀] or [▶▶].



- Traffic information can be switched when it is on the Tuner Source. However, you cannot switch the Traffic information during reception of the Traffic bulletin switched from the source other than the Tuner.

## PTY (Program Type)

Selecting the Program Type and searching for a station.

### 1 Enter PTY mode

Press the Control knob.

During PTY mode the "PTY" indicator is ON.



- This function cannot be used during a traffic bulletin or AM reception.

### 2 Select the Program Type

Push the Control knob towards [FM] or [AM].

Each time you push the knob, the Program Type alternates between the program types shown in the table below.

No.	Program Type	Display
1.	Speech	"SPEECH"
2.	Music	"MUSIC"
3.	News	"NEWS"
4.	Current Affairs	"AFFAIRS"
5.	Information	"INFO"
6.	Sport	"SPORT"
7.	Education	"EDUCATE"
8.	Drama	"DRAMA"
9.	Culture	"CULTURE"
10.	Science	"SCIENCE"
11.	Varied	"VARIED"
12.	Pop Music	"POP M"
13.	Rock Music	"ROCK M"
14.	Easy Listening Music	"EASY M"
15.	Light Classical	"LIGHT M"
16.	Serious Classical	"CLASSICS"
17.	Other Music	"OTHER M"
18.	Weather	"WEATHER"
19.	Finance	"FINANCE"
20.	Children's programs	"CHILDREN"
21.	Social Affairs	"SOCIAL"
22.	Religion	"RELIGION"
23.	Phone In	"PHONE IN"
24.	Travel	"TRAVEL"
25.	Leisure	"LEISURE"
26.	Jazz Music	"JAZZ"
27.	Country Music	"COUNTRY"
28.	National Music	"NATION M"
29.	Oldies Music	"OLDIES"
30.	Folk Music	"FOLK M"
31.	Documentary	"DOCUMENT"



- Speech and Music include the Program type shown below.  
Music: No.12 — 17, 26 — 30  
Speech: No.3 — 11, 18 — 25, 31
- You can put the Program Type in the [1] — [6] button memory and for quick recall. Refer to the <Program Type preset> (page 13).
- You can change the display language. Refer to <Changing Language for PTY Function> (page 14).

### 3 Search for the selected Program Type station

Push the Control knob towards [◀◀] or [▶▶].

When you want to search for other stations, push [◀◀] or [▶▶] of the Control knob again.



- When the selected Program Type is not found, "NO PTY" is displayed. Select another Program Type.

### 4 Exit PTY mode

Press the Control knob.

## Program Type preset

Putting the Program Type in the Preset button memory and quick recall.

### Presetting the Program Type

#### 1 Select the Program Type to preset

Refer to <PTY (Program Type)> (page 13).

#### 2 Preset the Program Type

Press the desired [1] — [6] button for at least 2 seconds.

### Recalling the preset Program Type

#### 1 Enter PTY mode

Refer to <PTY (Program Type)> (page 13).

#### 2 Recall the Program Type

Press the desired [1] — [6] button.

### **Changing Language for PTY Function**

Selecting the Program Type display language.

#### **1 Enter PTY mode**

Refer to <PTY (Program Type)> (page 13).

#### **2 Enter Changing Language mode**

Press the [TI] button.

#### **3 Select the language**

Push the Control knob towards [FM] or [AM].

Each time you push the knob, the language alternates between the languages shown in the table below.

Language	Display
English	"ENGLISH"
French	"FRENCH"
German	"GERMAN"

#### **4 Exit Changing Language mode**

Press the [TI] button.

## CD player features

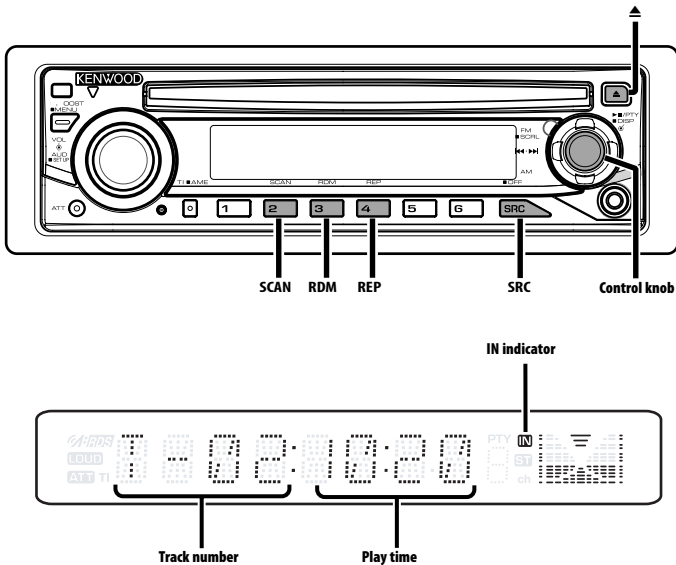

### Playing CD

#### When a disc is inserted

Press the [SRC] button.

Select the "CD" display.



- When a CD is inserted, the "IN" indicator is ON.

#### Pause and play

Press the Control knob.

Each time you press the knob, the audio pauses or plays.

#### Eject the CD

Press the [▲] button.



- You can eject the disc for 10 minutes after switching off the engine.

### Fast Forwarding and Reversing

#### Fast Forwarding

Hold down toward [▶▶] with the Control knob.

Release to resume the playback.

#### Reversing

Hold down toward [◀◀] with the Control knob.

Release to resume the playback.

# CD player features

---

## Track Search

---

Selecting the song you want to hear.

Push the Control knob towards [◀◀] or [▶▶].

## Track Repeat

---

Replaying the song you are listening to.

**Press the [REP] button.**

Each time you press the button, the Track Repeat turns ON or OFF.

When the Track Repeat is ON, "TRAC REP" is displayed.

## Scan Play

---

Playing the first part of each song on the disc you are listening to and searching for the song you want to hear.

### 1 Start Scan Play

**Press the [SCAN] button.**

"TRAC SCN" is displayed.

### 2 Release it when the song you want to listen to is played

**Press the [SCAN] button.**

## Random Play

---

Playing all the songs on the disc in random order.

**Press the [RDM] button.**

Each time you press the button, Random Play turns ON or OFF.

When the Random mode is ON, "DISC RDM" is displayed.



- When you push the Control knob toward [▶▶], the next random song starts.



# Menu system

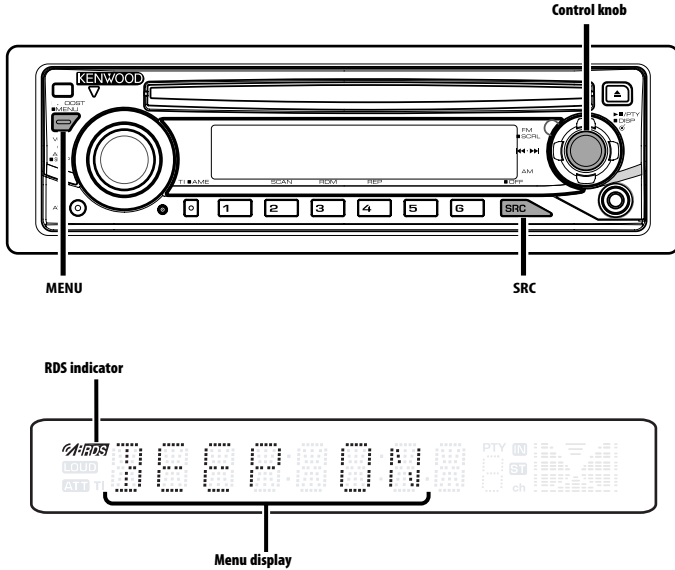

## Menu System

Setting beep sound during operation, etc. functions.

The Menu system basic operation method is explained here. The reference for the Menu items and their setting content is after this operation explanation.

### 1 Enter Menu mode

Press the [MENU] button for at least 1 second.

"MENU" is displayed.

### 2 Select the menu item

Push the Control knob towards [FM] or [AM].

Example: When you want to set the beep sound select the "BEEP" display.

### 3 Set the menu item

Push the Control knob towards [◀◀] or [▶▶].

Example: When you select "BEEP", each time you push the knob it alternates between "BEEP ON" or "BEEP OFF". Select 1 of them as the setting.

You can continue by returning to step 2 and setting other items.

### 4 Exit Menu mode

Press the [MENU] button.



- When other items those applicable to the basic operation method above are displayed, their setting content chart is entered. (Normally the setting listed at the top of the chart is the original setting.) Also, the explanation for items that are not applicable (<Manual Clock Adjustment> etc.) are entered step by step.

*In Standby mode*

## Touch Sensor Tone

Setting the operation check sound (beep sound) ON/OFF.

Display	Setting
"BEEP ON"	Beep is heard.
"BEEP OFF"	Beep canceled.

# Menu system

In Standby mode

## Manual Clock Adjustment



- You can do this adjustment when the <Synchronize Clock> (page 18) is set as OFF.

### 1 Select Clock Adjustment mode

Push the Control knob towards [FM] or [AM].  
Select the "CLK ADJ" display.

### 2 Enter Clock Adjust mode

Press the Control knob for at least 1 second.  
The clock display blinks.

### 3 Adjust the hours

Push the Control knob towards [FM] or [AM].

#### Adjust the minutes

Push the Control knob towards [◀◀] or [▶▶].

### 4 Exit Clock adjustment mode

Press the [MENU] button.

In Standby mode

## Synchronize Clock

Synchronizing the RDS station time data and this unit's clock.

Display	Setting
"SYNC ON"	Synchronizes the time.
"SYNC OFF"	Adjust the time manually.



- It takes 3 to 4 minutes to synchronize the clock.

In Standby mode

## DSI (Disabled System Indicator)

A red indicator will blink on the unit after the faceplate is removed, warning potential thieves.

Display	Setting
"DSI ON"	LED flashes.
"DSI OFF"	LED OFF.

## Dimmer

You can lower the brightness of the display by using the dimmer function.

Display	Setting
"DIM ON"	The display dims.
"DIM OFF"	The display doesn't dim.

## News Bulletin with Timeout Setting

The tuner automatically changes when a news bulletin starts even if the radio is not being listened to. Also, you can set the time interval when interruption is prohibited.

Display and Setting
"NEWS OFF"
"NEWS 00M"
:
"NEWS 90M"

When you set "NEWS 00M" — "NEWS 90M", the News Bulletin Interrupt function is ON.

When the News Bulletin is ON, the "NEWS" indicator is ON.

When the news bulletin starts, "NEWS" is displayed, and the tuner changes to the news bulletin.



- If you choose the "20MIN" setting, further news bulletins will not be received for 20 minutes once the first news bulletin is received.
- The news bulletin volume is the same level that was set for <Traffic Information> (page 12).
- This news bulletin function is only available if the desired station sends PTY-code for news bulletin or belongs to <Enhanced Other Network>-Network sending PTY-code for news bulletin.
- When the News Bulletin Interrupt function is ON, the tuner changes to an FM station.

In Tuner mode

## Local Seek

Only stations whose reception is good are searched in auto seek tuning.

Display	Setting
"LOS OFF"	The local seek function is OFF.
"LOS ON"	The local seek function is ON.

In Tuner mode

## Tuning Mode

Sets the tuning mode.

Tuning mode	Display	Operation
Auto seek	"AUTO 1"	Automatic search for a station.
Preset station seek	"AUTO 2"	Search in order of the stations in the Preset memory.
Manual	"MANUAL"	Normal manual tuning control.

## AF (Alternative Frequency)

When the reception is poor, automatically alternate to another frequency broadcasting the same program in the same RDS network with better reception.

Display	Setting
"AF ON"	The AF function is ON.
"AF OFF"	The AF function is OFF.

When the AF function is ON, the "RDS" indicator is ON.



- When no other stations with stronger reception are available for the same program in the RDS network, you may hear the incoming broadcast in bits and snatches. Turn OFF the AF function in such a case.

## Restricting RDS Region (Region Restrict Function)

You can choose whether or not to restrict the RDS channels, received with the AF function for a particular network, to a specific region.

Display	Setting
"REG ON"	The Region Restrict Function is ON.
"REG OFF"	The Region Restrict Function is OFF.



- If AF function is not restricted to the specified region and network, the AF function sets up to search the station with good reception in the same RDS network.

## Auto TP Seek

When the TI function is ON and the reception is poor while listening to a traffic information station, another traffic information station with better reception will be searched for automatically.

Display	Setting
"ATPS ON"	The Auto TP Seek Function is ON.
"ATPS OFF"	The Auto TP Seek Function is OFF.

In FM reception

## Monaural Reception

You can reduce the noise when stereo broadcasts are received as monaural.

Display	Setting
"MONO OFF"	The monaural reception is OFF.
"MONO ON"	The monaural reception is ON.

# Menu system

## Auxiliary Input Display Setting

Selecting the display when alternating to Auxiliary input source.

### 1 Select Auxiliary input source

Press the [SRC] button.

Select the "AUX" display.

### 2 Enter Menu mode

Press the [MENU] button for at least 1 second.

"MENU" is displayed.

### 3 Select Auxiliary input display setting mode

Push the Control knob towards [FM] or [AM].

Select the "NAME SET" display.

### 4 Enter Auxiliary input display setting mode

Press the Control knob for at least 1 second.

The selected Auxiliary input display is displayed.

### 5 Select the Auxiliary input display

Push the Control knob towards [◀◀] or [▶▶].

Each time you push the knob, the display alternates as listed below.

- "AUX"
- "DVD"
- "PORTABLE"
- "GAME"
- "VIDEO"
- "TV"

### 6 Exit Auxiliary input display setting mode

Press the [MENU] button.



- When operation stops for 10 seconds, the name at that time is registered, and the Auxiliary input display setting mode closes.

*In Standby mode*

## Built-in Auxiliary input Setting

Set the Built-in Auxiliary Input function.

Display	Setting
"AUX OFF"	When selecting the source there's no Auxiliary Input.
"AUX ON1"	When selecting the source there's Auxiliary Input.
"AUX ON2"	When the unit is turned on by AUX source, the attenuator function is activated. Press [ATT] button to cancel the attenuator function in order to listen to the external equipment.



- Setting to "AUX ON2" will not output the noise which is produced when an external equipment is not connected to the AUX terminal.

*In Standby mode*

## Power OFF Timer

Setting the timer to turn this unit's power OFF automatically when Standby mode continues. Using this setting can save the vehicle's battery power.

Display	Setting
"OFF -- --"	Power OFF Timer function is OFF.
"OFF 20M" (Original setting)	Turns the power OFF after 20 minutes.
"OFF 40M"	Turns the power OFF after 40 minutes.
"OFF 60M"	Turns the power OFF after 60 minutes.

*In Standby mode*

## Demonstration mode Setting

Sets the demonstration mode.

### 1 Select the Demonstration mode

Push the Control knob towards [FM] or [AM].

Select the "DEMO" display.

### 2 Set the Demonstration mode

Press the Control knob for at least 2 seconds.

Each time you press the knob at least 2 seconds, the Demonstration mode alternates between the settings shown in the table below.

Display	Setting
"DEMO ON"	The Demonstration mode function is ON.
"DEMO OFF"	Exit Demonstration mode (Normal mode).

# Accessories/ Installation Procedure

## Accessories

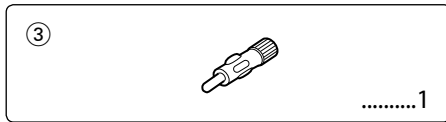
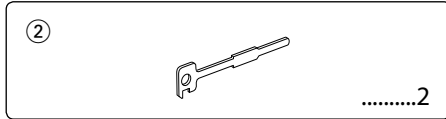
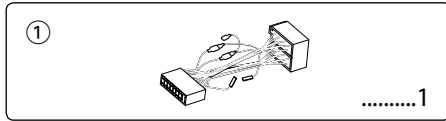

## Installation Procedure

1. To prevent short circuits, remove the key from the ignition and disconnect the ⊖ terminal of the battery.
2. Make the proper input and output wire connections for each unit.
3. Connect the wire on the wiring harness.
4. Take Connector B on the wiring harness and connect it to the speaker connector in your vehicle.
5. Take Connector A on the wiring harness and connect it to the external power connector on your vehicle.
6. Connect the wiring harness connector to the unit.
7. Install the unit in your car.
8. Reconnect the ⊖ terminal of the battery.
9. Press the reset button.



- If the power is not turned ON (or it is ON, but will be OFF immediately), the speaker wire may have a short-circuit or touched the chassis of the vehicle and the protection function may have been activated. Therefore, the speaker wire should be checked.
- If your car is not prepared for this special connection-system, consult your Kenwood dealer.
- Only use antenna conversion adapters (ISO-JASO) when the antenna cord has an ISO plug.
- Make sure that all wire connections are securely made by inserting jacks until they lock completely.
- If your vehicle's ignition does not have an ACC position, or if the ignition wire is connected to a power source with constant voltage such as a battery wire, the power will not be linked with the ignition (i.e., it will not turn on and off along with the ignition). If you want to link the unit's power with the ignition, connect the ignition wire to a power source that can be turned on and off with the ignition key.
- If the fuse blows, first make sure that the wires have not caused a short circuit, then replace the old fuse with one with the same rating.
- Insulate unconnected wires with vinyl tape or other similar material. To prevent short circuits, also do not remove the caps on the ends of the unconnected wires or the terminals.
- Connect the speaker wires correctly to the terminals to which they correspond. The unit may receive damage or fail to work if you share the ⊖ wires and/or ground them to any metal part in the car.
- After the unit is installed, check whether the brake lamps, indicators, wipers, etc. on the car are working properly.
- If the console has a lid, make sure to install the unit so that the faceplate does not hit the lid when closing and opening.
- Mount the unit so that the mounting angle is 30° or less.

# Connecting Wires to Terminals

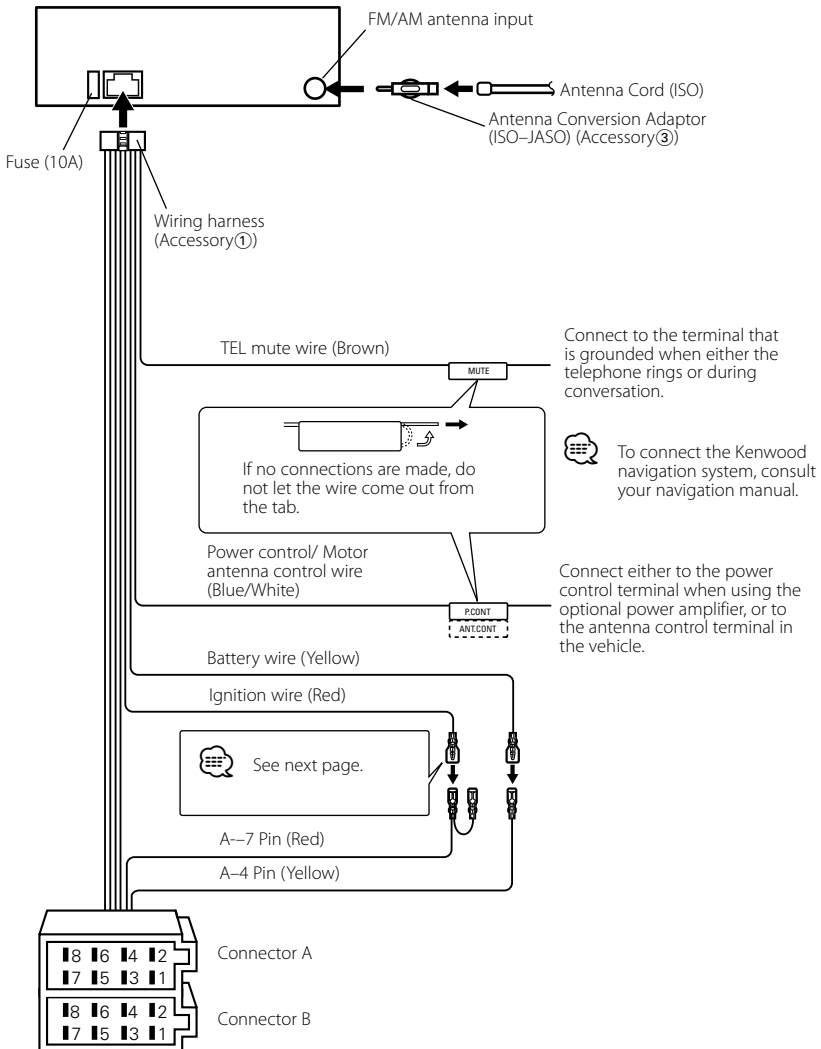

## Connector Function Guide

Pin Numbers for ISO Connectors	Cable Colour	Functions
External Power Connector		
A-4	Yellow	Battery
A-5	Blue/White	Power Control
A-7	Red	Ignition (ACC)
A-8	Black	Earth (Ground) Connection
Speaker Connector		
B-1	Purple	Rear Right (+)
B-2	Purple/Black	Rear Right (-)
B-3	Gray	Front Right (+)
B-4	Gray/Black	Front Right (-)
B-5	White	Front Left (+)
B-6	White/Black	Front Left (-)
B-7	Green	Rear Left (+)
B-8	Green/Black	Rear Left (-)

## ⚠ WARNING

### Connecting the ISO Connector

The pin arrangement for the ISO connectors depends on the type of vehicle you drive. Make sure to make the proper connections to prevent damage to the unit.

The default connection for the wiring harness is described in [1] below. If the ISO connector pins are set as described in [2] or [3], make the connection as illustrated.

Please be sure to reconnect the cable as shown [2] below to install this unit to the **Volkswagen** vehicles etc.

- [1] (Default setting) The A-7 pin (red) of the vehicle's ISO connector is linked with the ignition, and the A-4 pin (yellow) is connected to the constant power supply.

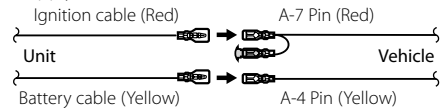

- [2] The A-7 pin (red) of the vehicle's ISO connector is connected to the constant power supply, and the A-4 pin (yellow) is linked to the ignition.

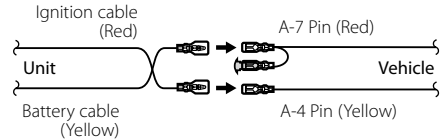

- [3] The A-4 pin (yellow) of the vehicle's ISO connector is not connected to anything, while the A-7 pin (red) is connected to the constant power supply (or both the A-7 (red) and A-4 (yellow) pins are connected to the constant power supply).

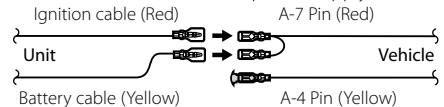

- When the connection is made as in [3] above, the unit's power will not be linked to the ignition key. For that reason, always make sure to turn off the unit's power when the ignition is turned off.

To link the unit's power to the ignition, connect the ignition cable (ACC...red) to a power source that can be turned on and off with the ignition key.

# Installation

## Installation

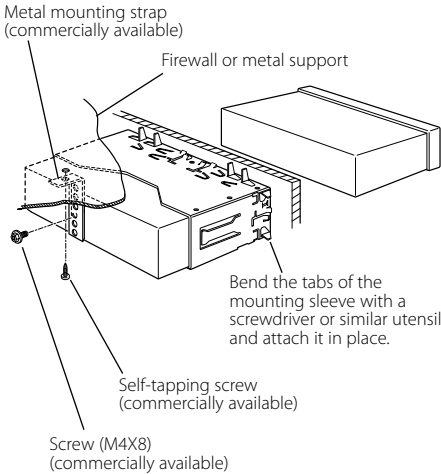

- Make sure that the unit is installed securely in place. If the unit is unstable, it may malfunction (for example, the sound may skip).

## Removing the hard rubber frame

- 1 Engage the catch pins on the removal tool and remove the two locks on the upper level. Upper the frame and pull it forward as shown in the figure.

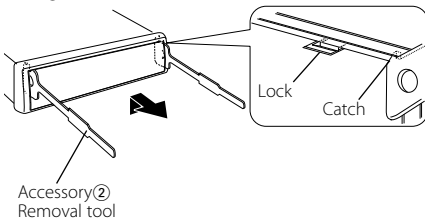

- 2 When the upper level is removed, remove the lower two locations.



- The frame can be removed from the bottom side in the same manner.

## Removing the Unit

- 1 Refer to the section <Removing the hard rubber frame> and then remove the hard rubber frame.
- 2 Remove the screw (M4 x 8) on the back panel.
- 3 Insert the two removal tools deeply into the slots on each side, as shown.
- 4 Lower the removal tool toward the bottom, and pull out the unit halfway while pressing towards the inside.

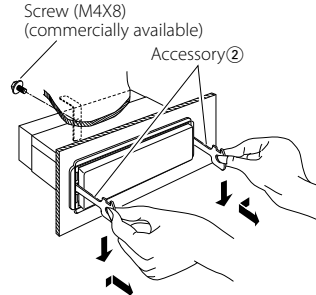

- Be careful to avoid injury from the catch pins on the removal tool.
- 5 Pull the unit all the way out with your hands, being careful not to drop it.



# Troubleshooting Guide

Some functions of this unit may be disabled by some settings made on this unit.

## ! Cannot switch to Aux source.

- ▶ AUX is not turned on. ☞ <Built-in Auxiliary input Setting> (page 20)

## ! Cannot display the user of System Q.

- ▶ <Audio Control> (page 7) is not set.

What might seem to be a malfunction in your unit may just be the result of slight misoperation or miswiring. Before calling service, first check the following table for possible problems.

## General

### ? The Touch Sensor Tone doesn't sound.

- ✓ The preout jack is being used.
  - ☞ The Touch Sensor Tone can't be output from the preout jack.

## Tuner source

### ? Radio reception is poor.

- ✓ The car antenna is not extended.
  - ☞ Pull the antenna out all the way.
- ✓ The antenna control wire is not connected.
  - ☞ Connect the wire correctly, referring to the section on <Connecting Wires to Terminals> (page 22).

## Disc source

### ? The specified disc does not play, but another one plays instead.

- ✓ The specified CD is quite dirty.
  - ☞ Clean the CD.
- ✓ The disc is severely scratched.
  - ☞ Try another disc instead.

## The messages shown below display your systems condition.

- TOC ERR: The CD is quite dirty. The CD is upside-down. The CD is scratched a lot.
- E-99: The unit is malfunctioning for some reason.  
☞ Press the reset button on the unit. If the "E-99" code does not disappear, consult your nearest service center.
- IN (Blink): The CD player section is not operating properly.  
☞ Reinsert the CD. If the CD cannot be ejected or the display continues to flash even when the CD has been properly reinserted, please switch off the power and consult your nearest service center.
- PROTECT: The speaker wire has a short-circuit or touches the chassis of the vehicle, and then the protection function is activated.  
☞ Wire or insulate the speaker cable properly and press the reset button. If the "PROTECT" code does not disappear, consult your nearest service center.
- DEMO: The Demonstration mode has been selected.  
☞ The <Demonstration mode Setting> (page 20) is ON. Turn it OFF.

# Specifications

---

Specifications subject to change without notice.

## FM tuner section

---

- Frequency range (50 kHz space)
  - : 87.5 MHz – 108.0 MHz
- Usable sensitivity (S/N = 26dB)
  - : 0.7  $\mu$ V/75  $\Omega$
- Quieting Sensitivity (S/N = 46dB)
  - : 1.6  $\mu$ V/75  $\Omega$
- Frequency response ( $\pm$ 3.0 dB)
  - : 30 Hz – 15 kHz
- Signal to Noise ratio (MONO)
  - : 70 dB
- Selectivity (DIN) ( $\pm$ 400 kHz)
  - :  $\geq$  80 dB
- Stereo separation (1 kHz)
  - : 35 dB

## MW tuner section

---

- Frequency range (9 kHz space)
  - : 531 kHz – 1611 kHz
- Usable sensitivity (S/N = 20dB)
  - : 25  $\mu$ V

## LW tuner section

---

- Frequency range
  - : 153 kHz – 281 kHz
- Usable sensitivity (S/N = 20dB)
  - : 45  $\mu$ V

## CD player section

---

- Laser diode
  - : GaAlAs
- Digital filter (D/A)
  - : 8 Times Over Sampling
- D/A Converter
  - : 1 Bit
- Spindle speed
  - : 500 – 200 rpm (CLV)
- Wow & Flutter
  - : Below Measurable Limit
- Frequency response ( $\pm$ 1 dB)
  - : 10 Hz – 20 kHz
- Total harmonic distortion (1 kHz)
  - : 0.01 %
- Signal to Noise ratio (1 kHz)
  - : 93 dB
- Dynamic range
  - : 93 dB

## Audio section

---

- Maximum output power
  - : 45 W x 4
- Output power (DIN 45324, +B=14.4V)
  - : 28 W x 4
- Speaker Impedance
  - : 4 – 8  $\Omega$
- Tone action
  - Bass : 100 Hz  $\pm$ 8 dB
  - Middle : 1 kHz  $\pm$ 8 dB
  - Treble : 10 kHz  $\pm$ 8 dB

## Auxiliary input

---

- Frequency response ( $\pm$ 1 dB)
  - : 20 Hz – 20 kHz
- Input Maximum Voltage
  - : 1200 mV
- Input Impedance
  - : 100 k $\Omega$

## General

---

- Operating voltage (11 – 16V allowable)
  - : 14.4 V
- Current consumption
  - : 10 A
- Installation Size (W x H x D)
  - : 182 x 53 x 155 mm
- Weight
  - : 1.4 kg



---

# KENWOOD

## Free Manuals Download Website

<http://myh66.com>

<http://usermanuals.us>

<http://www.somanuals.com>

<http://www.4manuals.cc>

<http://www.manual-lib.com>

<http://www.404manual.com>

<http://www.luxmanual.com>

<http://aubethermostatmanual.com>

Golf course search by state

<http://golfingnear.com>

Email search by domain

<http://emailbydomain.com>

Auto manuals search

<http://auto.somanuals.com>

TV manuals search

<http://tv.somanuals.com>