

# KENWOOD

## KDC-X959

CD-RECEIVER

## INSTRUCTION MANUAL

KENWOOD CORPORATION



**Take the time to read through this instruction manual.**

**Familiarity with installation and operation procedures will help you obtain the best performance from your new CD-receiver.**

### **For your records**

Record the serial number, found on the back of the unit, in the spaces designated on the warranty card, and in the space provided below. Refer to the model and serial numbers whenever you call upon your KENWOOD dealer for information or service on the product.

Model KDC-X959      Serial number \_\_\_\_\_

© B64-2257-00 (KV)

## Contents

<b>Safety precautions.....</b>	<b>4</b>	<b>Tuner features.....</b>	<b>22</b>	<b>Menu system.....</b>	<b>32</b>
<b>About RDS .....</b>	<b>5</b>	Tuning Mode		Menu System	
<b>Notes on playing MP3/WMA.....</b>	<b>6</b>	Tuning		Security Code	
<b>About CDs.....</b>	<b>8</b>	Direct Access Tuning		Touch Sensor Tone	
<b>General features .....</b>	<b>9</b>	Station Preset Memory		Manual Clock Adjustment	
Power		Auto Memory Entry		Date Adjustment	
Selecting the Source		Preset Tuning		Date Mode	
Volume		SNPP (Station Name Preset Play)		Synchronize Clock	
Attenuator		<b>RDS features .....</b>	<b>24</b>	DSI (Disabled System Indicator)	
Loudness		PTY (Program Type)		Contrast Adjustment	
System Q		Registration of a station as a PTY		Dimmer	
Audio Control		Program Type preset		System Q	
Speaker & Woofer Setting		Radio Text Scroll		Built-in Amp Mute Setting	
Switching Display Type		<b>CD/MP3/WMA/External disc</b>		Dual Zone System Setting	
Display switching part for "Display Type		<b>control features .....</b>	<b>27</b>	B.M.S. (Bass Management System)	
A" and "Display Type B"		Playing CD & MP3/WMA		B.M.S. Frequency Offset	
Display switching part for "Display Type		Playing External Disc		Traffic Information	
C" and "Display Type D"		Fast Forwarding and Reversing		CRSC (Clean Reception System Circuit)	
Wallpaper selecting		Track Search		Text Scroll	
Picture downloading		Album Search		Built-in Auxiliary input Setting	
Non-fading Output		Direct Track Search		Picture downloading	
Theft Deterrent Faceplate		Direct Album Search		<b>Basic Operations of remote.....</b>	<b>38</b>
Station/Disc Naming (SNPS/DNPS)		Track/Album Repeat		<b>Accessories .....</b>	<b>41</b>
Auxiliary Input Display Setting		Track Scan		<b>Installation Procedure .....</b>	<b>41</b>
Dual Zone System		Random Play		<b>Connecting Wires to Terminals</b>	<b>42</b>
		Magazine Random Play		<b>Installation .....</b>	<b>43</b>
		Album Select		<b>Troubleshooting Guide .....</b>	<b>45</b>
		Text/Title Scroll		<b>Specifications .....</b>	<b>51</b>
		DNPP (Disc Name Preset Play)			

## **▲ Warning**

---

### **▲ CAUTION**

Use of controls or adjustments or performance of procedures other than those specified herein may result in hazardous radiation exposure.

In compliance with Federal Regulations, following are reproductions of labels on, or inside the product relating to laser product safety.

KENWOOD CORPORATION  
2967-3, ISHIKAWA-CHO,  
HACHIOJI-SHI  
TOKYO, JAPAN

KENWOOD CORP. CERTIFIES THIS EQUIPMENT  
CONFORMS TO DHHS REGULATIONS NO.21 CFR  
1040. 10, CHAPTER 1, SUBCHAPTER J.

Location : Bottom Panel

### **FCC WARNING**

This equipment may generate or use radio frequency energy. Changes or modifications to this equipment may cause harmful interference unless the modifications are expressly approved in the instruction manual. The user could lose the authority to operate this equipment if an unauthorized change or modification is made.

### **NOTE**

This equipment has been tested and found to comply with the limits for a Class B digital device, pursuant to Part 15 of the FCC Rules. These limits are designed to provide reasonable protection against harmful interference in a residential installation. This equipment may cause harmful interference to radio communications, if it is not installed and used in accordance with the instructions.

However, there is no guarantee that interference will not occur in a particular installation. If this equipment does cause harmful interference to radio or television reception, which can be determined by turning the equipment off and on, the user is encouraged to try to correct the interference by one or more of the following measures:

- Reorient or relocate the receiving antenna.
- Increase the separation between the equipment and receiver.
- Connect the equipment into an outlet on a circuit different from that to which the receiver is connected.
- Consult the dealer or an experienced radio/TV technician for help.

### **NOTE**

This Class B digital apparatus complies with Canadian ICES-003.

## Safety precautions

### **▲WARNING**

#### **To prevent injury or fire, take the following precautions:**

- Insert the unit all the way in until it is fully locked in place. Otherwise it may fall out of place when jolted.
- When extending the ignition, battery, or ground wires, make sure to use automotive-grade wires or other wires with a 0.75mm<sup>2</sup> (AWG18) or more to prevent wire deterioration and damage to the wire coating.
- To prevent a short circuit, never put or leave any metallic objects (such as coins or metal tools) inside the unit.
- If the unit starts to emit smoke or strange smells, turn off the power immediately and consult your Kenwood dealer.
- Make sure not to get your fingers caught between the faceplate and the unit.
- Be careful not to drop the unit or subject it to strong shock.  
The unit may break or crack because it contains glass parts.

### **▲CAUTION**

#### **To prevent damage to the machine, take the following precautions:**

- Make sure to ground the unit to a negative 12V DC power supply.
- Do not open the top or bottom covers of the unit.
- Do not install the unit in a spot exposed to direct sunlight or excessive heat or humidity. Also avoid places with too much dust or the possibility of water splashing.
- Do not subject the faceplate to excessive shock, as it is a piece of precision equipment.
- When replacing a fuse, only use a new one with the prescribed rating. Using a fuse with the wrong rating may cause your unit to malfunction.
- To prevent a short circuit when replacing a fuse, first disconnect the wiring harness.
- Do not place any object between the faceplate and the unit.
- Do not use your own screws. Use only the screws provided. If you use the wrong screws, you could damage the unit.
- Do not apply excessive force to the moving faceplate. Doing so will cause damage or malfunction.
- Do not apply excessive force to the open faceplate or place objects on it. Doing so will cause damage or breakdown.

### **IMPORTANT INFORMATION**

#### **About the disc changer/CD player to be connected:**

To connect a disc changer having the "O-N" switch to this unit, set the "O-N" switch to "N".  
**Precautions when connecting disc changers/CD players released in 1997 or earlier.**

When you connect a model with no "O-N" switch, the converter cord CA-DS100 available as an option may be required. For details, consult your Kenwood dealer.  
A disc changer doesn't work when it is connected without using these options. If a model with no "O-N" switch is connected, some unavailable functions and information that cannot be displayed are generated.

Note that none of the KDC-C100, KDC-C302, C205, C705, and non-Kenwood CD changers can be connected.



You can damage both your unit and the CD changer if you connect them incorrectly.

#### **Do Not Load 8-cm (3-in.) CDs in the CD slot**

If you try to load an 8-cm CD with its adapter into the unit, the adapter might separate from the CD and damage the unit.

## NOTE

- If you experience problems during installation, consult your Kenwood dealer.
- If the unit fails to operate properly, press the Reset button. The unit returns to factory settings when the Reset button is pressed. If the unit still fails to operate properly after the Reset button has been pressed, contact your local KENWOOD dealer for assistance.
- Press the reset button if the disc auto changer fails to operate correctly. Normal operation should be restored.

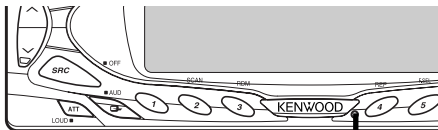

Reset button

- We recommend the use of the Security Code function (see p. 34) to prevent theft.
- The illustrations of the display and the panel appearing in this manual are examples used to explain more clearly how the controls are used. Therefore, what appears on the display in the illustrations may differ from what appears on the display on the actual equipment, and some of the illustrations on the display may represent something impossible in actual operation.

## Lens Fogging

Right after you turn on the car heater in cold weather, dew or condensation may form on the lens in the CD player of the unit. Called lens fogging, CDs may be impossible to play. In such a situation, remove the disc and wait for the condensation to evaporate. If the unit still does not operate normally after a while, consult your Kenwood dealer.

## Cleaning the Faceplate Terminals

If the terminals on the unit or faceplate get dirty, wipe them with a dry, soft cloth.

## Cleaning the Unit

If the faceplate of this unit is stained, wipe it with a dry soft cloth such as a silicon cloth. If the faceplate is stained badly, wipe the stain off with a cloth moistened with neutral cleaner, then wipe neutral detergent off.



Applying spray cleaner directly to the unit may affect its mechanical parts. Wiping the faceplate with a hard cloth or using a volatile liquid such as thinner or alcohol may scratch the surface or erase characters.

## Cleaning the CD Slot

As dust tends to accumulate in the CD slot, clean it every once in a while. Your CDs can get scratched if you put them in a dusty CD slot.

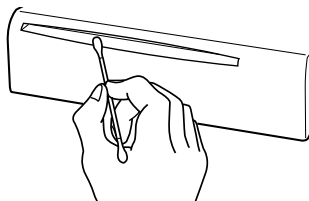

## About RDS

### RDS (Radio Data System)

RDS is a service used by radio stations to transmit data outside normal radio broadcast signals.

When an RDS station is received, you can immediately find out what kind of data is being transmitted by looking at the program service name, which appears in the display after the frequency.

The RDS indicator turns on when an RDS station is being received.

### Alarm

When an emergency transmission (announcing disasters, etc.) is made, the current function will be interrupted to allow the warning to be received under the following conditions: during tuner reception, or when the Traffic Information function is turned on.

## Notes on playing MP3/WMA

This unit can play MP3(MPEG1, 2, 2.5 Audio Layer 3)/WMA. Note, however, that the MP3/WMA recording media and formats acceptable are limited. When writing MP3/WMA, pay attention to the following restrictions.

### Acceptable media

The MP3/WMA recording media acceptable to this unit are CD-ROM, CD-R, and CD-RW.

Please use the full format when using CD-RW. If you use the quick format, media may not be played.

### Acceptable medium formats

The following formats are available for the media used in this unit. The maximum number of characters used for file name including the delimiter (".") and three-character extension are indicated in parentheses.

- ISO 9660 Level 1 (12 characters)
- ISO 9660 Level 2 (31 characters)
- Joliet (64 characters)
- Romeo (128 characters)

Up to 200 characters can be displayed in the long file name format.

For a list of available characters, see the instruction manual of the writing software and the section Entering file and folder names below. The media reproducible on this unit has the following limitations:

- Maximum number of directory levels: 8
- Maximum number of files per folder: 255
- Maximum number of characters for folder name: 64
- Maximum number of folders: 100

MP3/WMA written in the formats other than the above may not be successfully played and their file names or folder names are not properly displayed.

### Settings for your MP3/WMA encoder and CD writer

Do the following setting when compressing audio data in WMA data with the WMA encoder.

- Transfer bit rate: 48k —192 kbps
- Sampling frequency: 32k, 44.1k 48k Hz

When you use your CD writer to record MP3/WMA up to the maximum disc capacity, disable additional writing. For recording on an empty disc up to the maximum capacity at once, check Disc at Once.

### Entering ID3 tag and Contents Description

The Displayable ID3 tag is ID3 version 1.x.

For the character code, refer to the List of Codes.

### Entering file and folder names

The code list characters are the only file names and folder names that can be entered and displayed.

If you use any other character for entry, the file and folder names are not displayed correctly. They may neither be displayed correctly depending on the CD writer used.

The unit recognizes and plays only those MP3/WMA which have the MP3/WMA extension (.MP3/.WMA).



A file with a name entered with characters not on the code list may not play correctly.

### Writing files into a medium

When a medium containing MP3/WMA data is loaded, the unit checks all the data on the medium. If the medium contains a lot of folders or non-MP3/WMA files, therefore, it takes a long time until the unit starts playing MP3/WMA.

In addition, it may take time for the unit to move to the next MP3/WMA file or a Track Search or Album Search may not be performed smoothly.



Loading such a medium may produce loud noise to damage the speakers.

- Do not attempt to play a medium containing a non-MP3/WMA file with the MP3/WMA extension.  
The unit mistakes non-MP3/WMA files for MP3/WMA data as long as they have the MP3/WMA extension.
- Do not attempt to play a medium containing non MP3/WMA.

0	@	P	·	p	■	°	A	Đ	à	đ		
1	A	Q	a	q	i	±	A	Ń	á	ñ		
2	B	R	b	r	e	²	A	Ō	â	ô		
#	3	C	S	c	s	£	³	A	Ŏ	ã	ó	
\$	4	D	T	d	t	¤	·	A	Œ	ä	ö	
%	5	E	U	e	u	¥	µ	A	Œ	ä	ö	
&	6	F	V	f	v	:	¶	Æ	Œ	æ	ö	
'	7	G	W	g	w	§	·	Ç	×	ç	±	
(	8	H	X	h	x	¸	†	E	Ø	è	ø	
)	9	I	Y	i	y	©	¡	E	Ü	é	ü	
*	:	J	Z	j	z	ª	§	E	Ü	é	ü	
+	:	K	I	k	{	«	»	E	Ü	é	ü	
<	<	L	I	l		¼	¼	Ü	ü	ü	ü	
=	=	M	J	m	}	½	½	ÿ	ÿ	ÿ	ÿ	
>	>	N	^	n	~	¾	¾	I	P	i	p	
/	/	?	0	-	o	■	■	é	I	B	i	ÿ

### MP3/WMA playing order

When selected for play, Album Search, Track Search, or for Album Select, files and folders are accessed in the order in which they were written by the CD writer.

Because of this, the order in which they are expected to be played may not match the order in which they are actually played. You may be able to set the order in which MP3/WMA are to be played by writing them onto a medium such as a CD-R with their file names beginning with play sequence numbers such as "01" to "99", depending on your CD writer.

For example, a medium with the following folder/ file hierarchy is subject to Album Search, Track Search, or Album Select as shown below.

Example of a medium's folder/file hierarchy

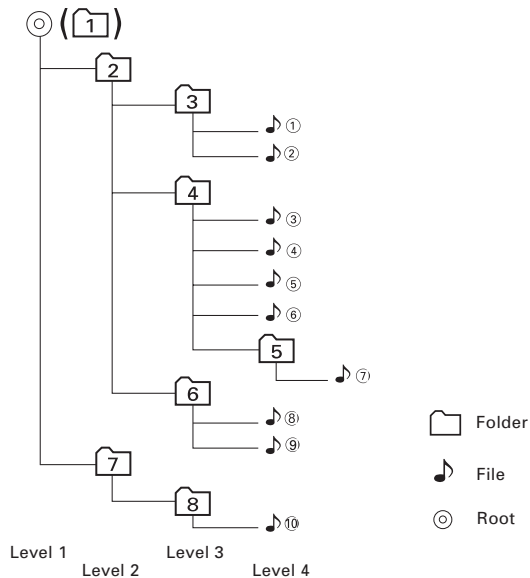

### When a Track Search is executed with file 4 being played ...

Current file number	Operation of the button	
	◀◀ Button	▶▶ Button
4	Beginning of file 4 ▶ 3	5 ▶ 6

### When an Album Search is executed with file 4 being played ...

Current folder number	Operation of the button	
	AM Button	FM Button
4	3 ▶ 2 ▶ 1 ▶ 8 ...	5 ▶ 6 ▶ 7 ▶ 8 ▶ 1 ...

### When Album Select is selected with file 4 being played to move from folder to folder ...

Current folder number	Operation of the button			
	◀◀ Button	▶▶ Button	AM Button	FM Button
4	3	6	2	5

## About CDs

### Handling CDs

- Don't touch the recording surface of the CD.

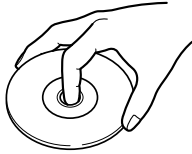

- CD-R and CD-RW are easier to damage than a normal music CD. Use a CD-R or a CD-RW after reading the caution items on the package etc.
- Don't stick tape etc. on the CD. Also, don't use a CD with tape stuck on it.

### When using a new CD

If the CD center hole or outside rim has burrs, use it after removing them with a ball pen etc.

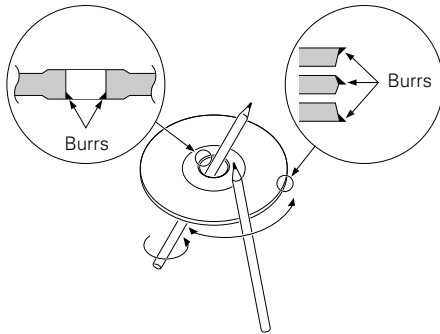

### CD accessories

Don't use disc type accessories.

### CD cleaning

Clean from the center of the disc and move outward.

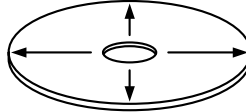



### Removing CDs

When removing CDs from this unit pull them out horizontally.

### CDs that can't be used

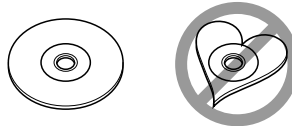
- CDs that aren't round can't be used.



- CDs with coloring on the recording surface or that are dirty can't be used.
  - Don't use CDs without disc mark
- 
- A CD-R or CD-RW that hasn't been finalized can't be played. (For the finalization process refer to your CD-R/CD-RW writing software, and your CD-R/CD-RW recorder instruction manual.)

### CD storage

- Don't place them in direct sunlight (On the seat or dashboard etc.) and where the temperature is high.
- Store CDs in their cases.



## General features

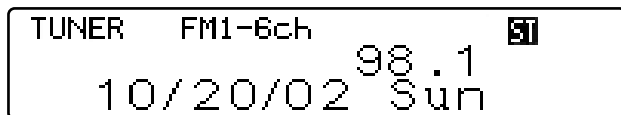
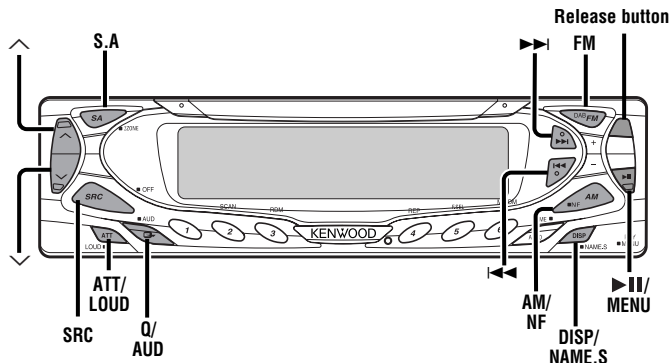

The display above is an example when Display type is set to "Display Type A".  
The function indicator is displayed only if it is "Display Type A".

## Power

### Turning ON the Power

Press the [SRC] button.

When the power is ON, the <Security Code> (page 34) is displayed as "CODE ON" or "CODE OFF".

### Turning OFF the Power

Press the [SRC] button for at least 1 second.

## Selecting the Source

Press the [SRC] button.

### Source required

### Display

Tuner	"TUNER"
CD	"Compact Disc"
External disc	"DiscChanger"
Auxiliary input	"AUX"
Standby (Illumination only mode)	"ALL OFF"

"AUX" is displayed in both the built-in Auxiliary input of this unit and optional Auxiliary inputs.

Enter an Auxiliary input name in <Auxiliary Input Display Setting> (page 20) to show the individual display.

## General features

### Volume

#### Increasing Volume

Press the [ $\wedge$ ] button.

#### Decreasing Volume

Press the [ $\vee$ ] button.

### Attenuator

Turning the volume down quickly.

Press the [ATT] button.

Each time the button is pressed the Attenuator turns ON or OFF.

When it's ON, "ATT ON" is displayed.

### Loudness

Compensating for low and high tones during low volume.

Press the [LOUD] button for at least 1 second.

Each time the button is pressed for at least 1 second the Loudness turns ON or OFF.

When it's ON, "LOUD ON" is displayed.

### System Q

You can recall the best sound setting preset for different types of the music.

#### 1 Select the source to set

Press the [SRC] button.

#### 2 Select the Sound type

Press the [Q] button.

Each time the button is pressed the sound setting switches.

Sound setting	Display
Flat	"FLAT"
User memory	"User Preset"
Rock	"ROCK"
Pops	"POPS"
Easy	"EASY"
Top 40	"TOP 40"
Jazz	"JAZZ"



- User memory: The values set on the <Audio control> (page 10).
- Each setting value is changed with the <Speaker & Woofer Setting> (page 12).  
First, select the speaker type with the Speaker setting.

### Audio Control

#### 1 Select the source for adjustment

Press the [SRC] button.

#### 2 Enter Audio Control mode

Press the [AUD] button for at least 1 second.

### 3 Select the Audio item for adjustment

Press the [FM] or [AM] button.

Each time the button is pressed the items that can be adjusted switch as shown below.

### 4 Adjust the Audio item

Press the [◀◀] or [▶▶] button.

Adjustment Item	Display	Range
Bass Center Frequency	"Bass FRQ"	60/70/80/100 or 150 (Hz)
Bass level	"Bass"	-8 — +8
Bass Q Factor	"Bass Q"	1.00/1.25/1.50/2.00
Bass Extend	"Bass EXT"	ON/OFF
Middle Center Frequency	"Middle FRQ"	0.5/1.0/1.5/2.0 (kHz)
Middle level	"Middle"	-8 — +8
Middle Q Factor	"Middle Q"	1.0/2.0
Treble Center Frequency	"Treble FRQ"	10.0/12.5/15.0/17.5 (kHz)
Treble level	"Treble"	-8 — +8
Balance	"Balance"	Left 15 — Right 15
Fader	"Fader"	Rear 15 — Front 15
Non-Fading level*	"NF Level"	-15 — +15
Front High Pass Filter	"HPF Front"	Through/40/60/80/100/120/150/180/220 (Hz)
Rear High Pass Filter	"HPF Rear"	Through/40/60/80/100/120/150/180/220 (Hz)
Non-Fading Low Pass Filter*	"LPF NF"	50/80/120/Through (Hz)
Non-Fading Phase*	"NF Phase"	Normal (0°)/Reverse (180°)
Volume offset	"Volume Offset"	-8 — ±0



- According to the Bass Q Factor setting value, the frequencies that can be set in Bass Center Frequency change as shown below.

Bass Q Factor	Bass Center Frequency
1.00/1.25/1.50	60/70/80/100
2.00	60/70/80/150

- When the bass extend is set to ON, low frequency response is extended by 20%.
- Volume offset: Each source's volume can be set as a difference from the basic volume.
- \*: This mode is available only when <Non-fading Output> (page 19) is ON.

### 5 Exit Audio Control mode

Press the [AUD] button.

## General features

### Speaker & Woofer Setting

Speaker setting allows the System Q settings to be fine-tuned according to the type of speakers.

Woofer setting allows for Network configuration according to the type of subwoofers.

#### 1 Enter Standby

Press the [SRC] button.

Select the "ALL OFF" display.

#### 2 Enter Speaker & Woofer Setting mode

Press the [Q] button.

"Speaker Setting" is displayed.

#### 3 Select the Setting mode

Press the [FM] or [AM] button.

Each time the button is pressed it switches between Speaker setting mode and Woofer setting mode.

#### 4 Select the Speaker and Woofer type

Press the [◀◀] or [▶▶] button.

Each time the button is pressed the setting switches as shown below.

#### In Speaker setting mode

Speaker type	Display
OFF	"OFF"
For 5 & 4 in. speaker	"5/4 inch"
For 6 & 6x9 in. speaker	"6*9/6inch"
For the OEM speaker	"O.E.M."

#### In Woofer setting mode

Woofer type	Display
OFF	"Woofer OFF"
12 in. A type	"12in type A"
10 in. A type	"10in type A"
12 in. B type	"12in type B"
10 in. B type	"10in type B"
12 in. C type	"12in type C"
10 in. C type	"10in type C"
8 in. type	"8inch"
12 in. D type	"12in type D"
10 in. D type	"10in type D"

#### 5 Exit Speaker & Woofer Setting mode

Press the [Q] button.

### Switching Display Type

Setting the Display type.

Press the [DISP] button.

Each time the button is pressed the Display type switches as shown below.

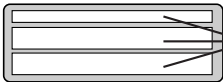
Display	Display mode
"Display Type D"	 Picture
"Display Type A"	 Character information display

### "Display Type B"



### "Display Type C"

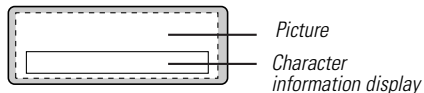

The display of each part can be changed.

- Picture:

<Display switching part for "Display Type C" and "Display Type D"> (page 16)

- Character information display:

<Display switching part for "Display Type A" and "Display Type B">: (page 13)

<Display switching part for "Display Type C" and "Display Type D">(page 16)

## Display switching part for "Display Type A" and "Display Type B"

When Display Type is set to "Display Type A" or "Display Type B", the displayed contents are changed.

### "Display Type A"

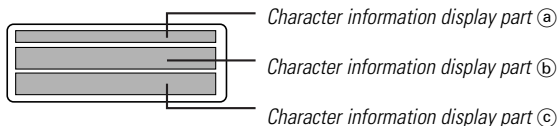

### "Display Type B"

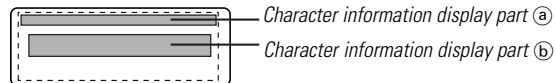

#### 1 Select the Display Type

Press the [DISP] button.

#### 2 Enter Display Control mode

Press the [S.A] button.

"Display Control" is displayed.

#### 3 Switch character information display part ㉒

Press the [FM] or [AM] button.

#### Switch character information display part ㉓

(Only when Display Type is "Display Type A")

Press the [◀◀] or [▶▶] button.

Each time the button is pressed the display switches.

The Reference for the display content is after this operation's explanation.

#### 4 Exit Display Control mode

Press the [S.A] button.



Character information display part ㉓ cannot display the same information as character information display part ㉒.

## General features



### In Tuner source

#### Character information display part ⑥ Display

Information	Display
Station name	"SNPS+FREQ"
or Program Service name or Frequency	
Radio text	"R-TEXT"
Date & Clock (Only when Display Type is "Display Type B")	"DATE+CLOCK"
Date	"DATE"
Blank (Only when Display Type is "Display Type A")	
Frequency	"Frequency"

#### Character information display part ⑦ Display

Information	Display
Spectrum Analyzer & Clock	"S/ANA+CLOCK"
Radio text	"R-TEXT"
Blank	
Date	"DATE"
Date & Clock	"DATE+CLOCK" or "CLOCK"

-  The band display is always displayed on the ⑦ part display.
-  For Station name registration refer to <Station/Disc Naming (SNPS/DNPS)> (page 20).



### In CD/ External disc source

#### Character information display part ⑥ Display

Information	Display
Disc name	"DNPS"
Disc title	"DISC-TITLE"
Track title	"TRACK-TITLE"
Date & Clock (Only when Display Type is "Display Type B")	"DATE+CLOCK"
Date	"DATE"
Blank (Only when Display Type is "Display Type A")	

#### Character information display part ⑦ Display

Information	Display
Spectrum Analyzer & Clock	"S/ANA+CLOCK"
Track Title	"TRACK-TITLE"
Disc Title	"DISC-TITLE"
Disc name	"DNPS"
Blank	
Date	"DATE"
Date & Clock	"DATE+CLOCK" or "CLOCK"

-  The Track Time is always displayed on the ⑦ part display.
-  For Disc name registration refer to <Station/Disc Naming (SNPS/DNPS) > (page 20).

### **In MP3/WMA source**

#### **Character information display part ② Display**

<b>Information</b>	<b>Display</b>
Disc name	"DNPS"
Folder name	"FOLDER NAME"
File name	"FILE NAME"
Song title & Artist name	"TITLE/ARTIST"
Album name & Artist name	"ALBUM/ARTIST"
Date & Clock (Only when Display Type is "Display Type B")	"DATE+CLOCK"
Date	"DATE"
Blank (Only when Display Type is "Display Type A")	

#### **Character information display part ③ Display**

<b>Information</b>	<b>Display</b>
Spectrum Analyzer & Clock	"S/ANA+CLOCK"
Album name & Artist name	"ALBUM/ARTIST"
Song title & Artist name	"TITLE/ARTIST"
File name	"FILE NAME"
Folder name	"FOLDER NAME"
Disc name	"DNPS"
Blank	
Date	"DATE"
Date & Clock	"DATE+CLOCK" or "CLOCK"



- The Track Time is always displayed on the ③ part display.
- For Disc name registration refer to <Station/Disc Naming (SNPS/DNPS)> (page 20).
- The Album name cannot be displayed during WMA play.

### **In Auxiliary input source**

#### **Character information display part ② Display**

<b>Information</b>	<b>Display</b>
Blank (Only when Display Type is "Display Type A")	
Date	"DATE"
Date & Clock (Only when Display Type is "Display Type B")	"DATE+CLOCK"

#### **Character information display part ③ Display**

<b>Information</b>	<b>Display</b>
Spectrum Analyzer & Clock	"S/ANA+CLOCK"
Blank	
Date	"DATE"
Date & Clock	"DATE+CLOCK" or "CLOCK"



The Auxiliary input name is always displayed on the ③ part display.

### **In Standby mode**

#### **Character information display part ② Display**

<b>Information</b>	<b>Display</b>
Blank (Only when Display Type is "Display Type A")	
Date	"DATE"
Date & Clock (Only when Display Type is "Display Type B")	"DATE+CLOCK"

#### **Character information display part ③ Display**

<b>Information</b>	<b>Display</b>
Blank	
Date	"DATE"
Date & Clock	"DATE+CLOCK" or "CLOCK"



The "ALL OFF" is always displayed on the ③ part display.

## General features

### Display switching part for "Display Type C" and "Display Type D"

When Display Type is set to "Display Type C" or "Display Type D", the displayed contents are changed.

#### "Display Type C"

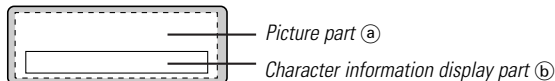

#### "Display Type D"

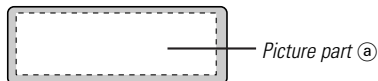

#### 1 Select the Display Type

Press the [DISP] button.

#### 2 Enter Display Control mode

Press the [S.A] button.

"Display Control" is displayed.

#### 3 Switch character information display part (b)

Press the [AM] button.

Each time the button is pressed the display switches.  
The Reference for the display content is after this operation's explanation.

#### Switch the Picture part (a)

Press the [FM] button.

Each time the button is pressed the display switches.

#### Display

Demonstration

Movie 1

Movie 2

Downloaded movie

Spectrum Analyzer 1

Spectrum Analyzer 2

Spectrum Analyzer 3

Spectrum Analyzer 4

Spectrum Analyzer 5

Wallpaper

#### 4 Exit Display Control mode

Press the [S.A] button.



- Wallpapers can be changed.

This unit comes with 5 types of wallpaper registered.

A downloaded wallpaper is added to the place after the last original wallpaper of this unit.

Refer to <Wallpaper selecting> (page 18).

- A downloaded movie can be selected when it has been downloaded into this unit.

Refer to <Picture downloading> (page 18).

#### In Tuner source

#### Character information display part (b) Display

Information	Display
Station name	"BAND+ch+SNPS"
or Program Service name or Frequency	
Frequency	"BAND+ch+FREQ"
Date	"DATE"
Date & Clock	"DATE+CLOCK"
Radio text	"R-TEXT"



 For Station name registration refer to <Station/Disc Naming (SNPS/DNPS)> (page 20).

-  • For Disc name registration refer to <Station/Disc Naming (SNPS/DNPS)> (page 20).  
• The Album name cannot be displayed during WMA play.

### ***In CD/ External disc source***

#### **Character information display part ⑥ Display**

<b>Information</b>	<b>Display</b>
Disc name	"DNPS"
Track Time	"P-Time"
Date	"DATE"
Date & Clock	"DATE+CLOCK"
Track title	"TRACK-TITLE"
Disc title	"DISC-TITLE"

 For Disc name registration refer to <Station/Disc Naming (SNPS/DNPS )> (page 20).

### ***In MP3/WMA source***

#### **Character information display part ⑥ Display**

<b>Information</b>	<b>Display</b>
Disc name	"DNPS"
Track Time	"P-Time"
Date	"DATE"
Date & Clock	"DATE+CLOCK"
Album name & Artist name	"ALBUM/ARTIST"
Song title & Artist name	"TITLE/ARTIST"
File name	"FILE NAME"
Folder name	"FOLDER NAME"

### ***In Auxiliary input source***

#### **Character information display part ⑥ Display**

<b>Information</b>	<b>Display</b>
Date	"DATE"
Date & Clock	"DATE+CLOCK"
Auxiliary input name	"AUX NAME"

### ***In Standby mode***

#### **Character information display part ⑥ Display**

<b>Information</b>	<b>Display</b>
Date	"DATE"
Date & Clock	"DATE+CLOCK"
Standby display	"ALL OFF"

## General features

### Wallpaper selecting

Select a wallpaper to display when Display Type is set to "Display Type C" or "Display Type D".

#### 1 Select the wallpaper display

Refer to <Display switching part for "Display Type C" and "Display Type D"> (page 16).

#### 2 Select the wallpaper

**Display the wallpapers one after another and select one**

1 Turn the wallpaper scan ON

Press the [▶||] button.

Each time the button is pressed the Wallpaper scan is turned ON and OFF.

When it's ON, "SCAN" is displayed.

When it's ON, each wallpaper is displayed every several seconds.

2 At the wallpaper you want to display

Press the [▶||] button.

**Select wallpaper manually**

1 Turn the wallpaper scan OFF.

Press the [▶||] button.

Each time the button is pressed the Wallpaper scan is turned ON and OFF.

2 Select the wallpaper.

Press the [◀◀] or [▶▶] button.

Each time the button is pressed the wallpaper changes.

#### 3 Exit Display Control mode

Press the [S.A] button.

### Picture downloading

Downloading movies and wallpapers. Downloaded pictures can be used for the display of this unit.

#### 1 Inset a CD-R/CD-RW.

Insert a CD-R/CD-RW containing files to be downloaded into this unit. Refer to <Playing CD & MP3/WMA> (page 28) for details.

Our URL

<<http://www.kenwoodusa.com/division.jsp?categoryId=3>>

describes how to make CD-R/CD-RW.

#### 2 Enter Standby

Press the [SRC] button.

Select the "ALL OFF" display.

#### 3 Enter Menu mode

Press the [MENU] button for at least 1 second.

"MENU" is displayed.

#### 4 Select the downloading mode

Press the [FM] or [AM] button.

Select the "Disp Data DL" display.

#### 5 Enter the downloading mode

Press the [◀◀] or [▶▶] button.

"File Check!!" is displayed.

#### 6 Select files to be downloaded

Press the [FM] or [AM] button.

#### 7 Start downloading

Press the [◀◀] or [▶▶] button for at least 2 seconds.

"Downloading" is displayed.

When the downloading finishes, "Finished Download" is displayed.



Picture download may take as long as 10 minutes.

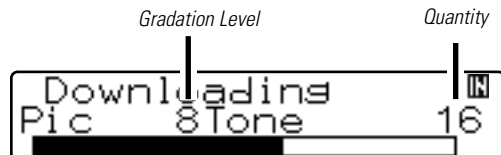

### **When you would like to cancel**

Press the [MENU] button.

### **8 Exit the downloading mode**

Press the [MENU] button.



- Do not operate this unit, while "Data Writing" is displayed, to prevent data from being damaged.

- The number of files that can be downloaded.

  - Downloaded movie: 1 file

  - Wallpaper: 1 file

- When a new movie is downloaded, it is overwritten to the currently downloaded movie.

Also, when a new wallpaper is downloaded, it is overwritten to the currently downloaded wallpaper.

Note! There is no way to delete the downloaded pictures.

- The downloaded pictures can be used for display.

  - <Display switching part for "Display Type C" and "Display Type D"> (page 16)

  - <Wallpaper selecting> (page 18)

- When you can't download the pictures to this unit, there may be a problem with the CD-R/CD-RW write method.

Refer to the URL

<<http://www.kenwoodusa.com/division.jsp?categoryId=3>>, and rewrite the CD-R/CD-RW.

### **Non-fading Output**

Turning the Non-fading output ON or OFF.

Press the [NF] button for at least 1 second.

Each time the button is pressed Non-fading output switches ON or OFF.

When it's ON, "NF ON" is displayed.

### **Theft Deterrent Faceplate**

The faceplate of the unit can be detached and taken with you, helping to deter theft.

#### **Removing the Faceplate**

**1** Press the Release button.

Drop open the faceplate.

**2** Drawing the faceplate to left side pull it to the front and remove it.

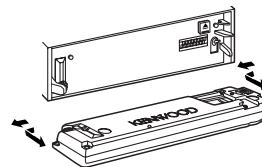

- The faceplate is a precision piece of equipment and can be damaged by shocks or jolts. For that reason, keep the faceplate in its special storage case while detached.

- Do not expose the faceplate or its storage case to direct sunlight or excessive heat or humidity. Also avoid places with too much dust or the possibility of water splashing.

#### **Reattaching the Faceplate**

**1** Align the shaft on the unit with the depression on the faceplate.

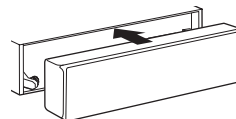

**2** Push the faceplate in until it clicks.



The faceplate is locked in place, allowing you to use the unit.

## General features

### Station/Disc Naming (SNPS/DNPS)

Attaching a title to a Station or CD.

#### 1 Receive/play the station/disc you want to attach a title to

-  • A title can't be attached to a MD.
- Disc Naming can't be done during CD text or MP3/WMA text display in the Character information display part .

#### 2 Enter name set mode

Press the [NAME.S] button for at least 2 seconds.  
"Name Set" is displayed.

#### 3 Move the cursor to the enter character position

Press the [◀◀] or [▶▶] button.

#### 4 Select the character type

Press the [▶||] button.

Each time the button is pressed the character type switches as shown below.

##### Character type

Alphabet upper case

Alphabet lower case

Numbers and symbols

Special characters (Accent characters)

#### 5 Select the characters

Press the [FM] or [AM] button.

-  Characters can be entered by using a remote with a number buttons.

Example: If "DANCE" is entered.

Character	Button	#Times pressed
"D"	[#3]	1
"A"	[#2]	1
"N"	[#6]	2
"C"	[#2]	3
"E"	[#3]	2

#### 6 Repeat steps 3 through 5 and enter the name.

#### 7 Exit name set mode

Press the [NAME.S] button.

-  • When operation stops for 10 seconds the name at that time is registered, and Name Set mode closes.
- Memory numbers
  - FM: 32 stations
  - AM: 16 stations
  - Internal CD player: 30 discs
  - External CD changer/ player: Varies according to the CD changer/ player. Refer to the CD changer/ player manual.
- The title of station/CD can be changed by the same operation used to name it.

### Auxiliary Input Display Setting

Selecting the display when this device is switched to internal and optional Auxiliary input sources.

#### 1 Select Auxiliary input source

Press the [SRC] button.  
Select the "AUX" display.

#### 2 Enter Auxiliary input display setting mode

Press the [NAME.S] button for at least 2 seconds.  
The presently selected AUX Name is blinks.

#### 3 Select the Auxiliary input display

Press the [◀◀] or [▶▶] button.  
Each time the button is pressed it switches through the below displays.

- "AUX"
- "TV"
- "VCP"
- "GAME"
- "PORTABLE"
- "DVD"

#### 4 Exit Auxiliary input display setting mode

Press the [NAME.S] button.



When operation stops for 10 seconds, the name at that time is selected, and Auxiliary input display setting mode closes.

- The Dual Zone System can be used with the optional Auxiliary input sources shown below.
  - KCA-S210A
  - CA-C1AX
  - CD changer with an Auxiliary input function installed.
- The Dual Zone System cannot be used in the built-in Auxiliary input.
- This function can be used in Auxiliary input source.
- The front channel and rear channel can be set to be the internal source or the Auxiliary input source. Refer to the <Dual Zone System Setting> (page 36).

### Dual Zone System

Makes the sound different for the front channel and rear channel.

One side of both the front and rear channels outputs the internal source sound, and the other side outputs the Auxiliary input source sound.

Press the [S.A] button for at least 1 second.

Each time the button is pressed for at least 1 second Dual Zone System switches ON or OFF.

When it's ON, "Zone 2 ON" is displayed.



- When the Dual Zone System is ON, there is no Auxiliary input source channel audio control or other effect.
- When the Dual Zone System is being used the internal source channel can't be used with an External disc source.
- When you set the Dual zone system to ON while the non-fading preout is switched ON, the sound of the non-fading preout isn't output.

## Tuner features

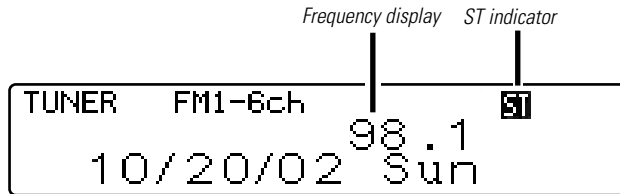
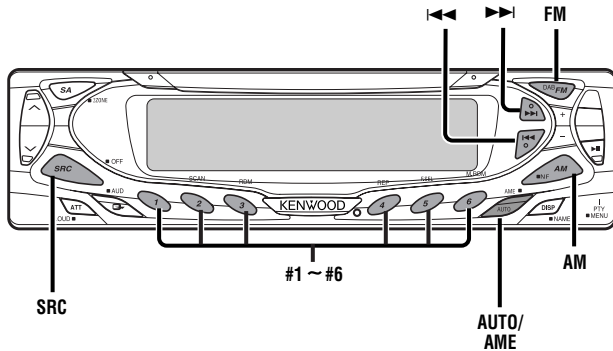

The display above is an example when Display type is set to "Display Type A".  
The function indicator is displayed only if it is "Display Type A".

### Tuning Mode

Choose the tuning mode.

Press the [AUTO] button.

Each time the button is pressed the Tuning mode switches as shown below.

Tuning mode	Display	Operation
Auto seek	"Auto1"	Automatic search for a station.
Preset station seek	"Auto2"	Search in order of the stations in the Preset memory.
Manual	"Manual"	Normal manual tuning control.

### Tuning

Selecting the station.

#### 1 Select tuner source

Press the [SRC] button.

Select the "TUNER" display.

#### 2 Select the band

Press the [FM] or [AM] button.

Each time the [FM] button is pressed it switches between the FM1, FM2, and FM3 bands.

#### 3 Tune up or down band

Press the [◀◀] or [▶▶] button.



- During reception of stereo stations the "ST" indicator is ON.
- The sound will be temporarily muted while the faceplate is opening.

## Direct Access Tuning (Function of remote)

Entering the frequency and tuning.

### 1 Select the band

Press the [FM] or [AM] button.

### 2 Enter Direct Access Tuning mode

Press the [DIRECT] button on the remote.

"- - - -" is displayed.

### 3 Enter the frequency

Press the number buttons on the remote.

Example:

<u>Desired frequency</u>	<u>Press button</u>
92.1 MHz (FM)	[#0], [#9], [#2], [#1]
810 kHz (AM)	[#0], [#8], [#1], [#0]

### Canceling Direct Access Tuning

Press the [DIRECT] button on the remote.

## Station Preset Memory

Putting the station in the memory.

### 1 Select the band

Press the [FM] or [AM] button.

### 2 Select the frequency to put in the memory

Press the [◀◀] or [▶▶] button.

### 3 Put the frequency in the memory

Press the [#1] — [#6] button for at least 2 seconds.

The preset number display blinks 1 time.

On each band, 1 station can be put in the memory on each [#1] — [#6] button.

## Auto Memory Entry

Putting stations with good reception in the memory automatically.

### 1 Select the band for Auto Memory Entry

Press the [FM] or [AM] button.

### 2 Open Auto Memory Entry

Press the [AME] button for at least 2 seconds.

When 6 stations that can be received are put in the memory Auto Memory Entry closes.

## Preset Tuning

Calling up the stations in the memory.

### 1 Select the band

Press the [FM] or [AM] button.

### 2 Call up the station

Press the [#1] — [#6] button.

## Tuner features

### SNPP (Station Name Preset Play) (Function of Remote)

Selecting the stations to display SNPS.

#### 1 Enter SNPP mode

Press the [DNPP] button on the remote.

When "SNPP" is displayed, SNPS displays the FM1, FM2, FM3 and AM bands in order.



If the station has no name, the frequency or program service name is displayed instead.

#### Changing the display order

Press the [◀◀] or [▶▶] button.

#### Changing the displayed band

Press the [FM] or [AM] button.

#### 2 If the station you want is displayed

Press the [OK] button on the remote.

The displayed SNPS station is received.

#### Canceling the SNPP mode

Press the [DNPP] button on the remote.

## RDS features

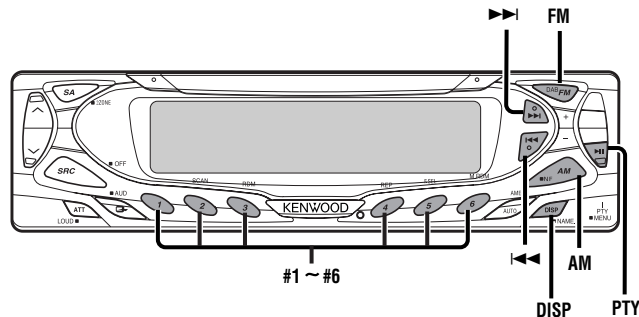

Radio text

Program Service name

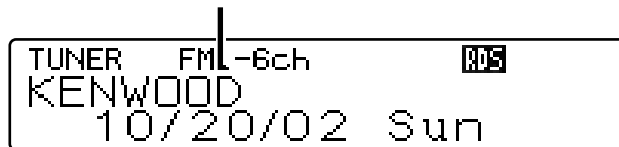

The display above is an example when Display type is set to "Display Type A".  
The function indicator is displayed only if it is "Display Type A".



## PTY (Program Type)

Selecting the Program Type and searching for a station.

### 1 Enter PTY mode

Press the [PTY] button.

"PTY Select" is displayed.



This function can't be used during a traffic bulletin or AM reception.

### 2 Select the Program Type

Press the [FM] or [AM] button.

No.	Program Type	Display
1.	Speech	"All Speech"
2.	Music	"All Music"
3.	News	"News"
4.	Information	"Information"
5.	Sports	"Sports"
6.	Talk	"Talk"
7.	Rock	"Rock"
8.	Classic Rock	"Classic Rock"
9.	Adult Hits	"Adult Hits"
10.	Soft Rock	"Soft Rock"
11.	Top 40	"Top 40"
12.	Country	"Country"
13.	Oldies	"Oldies"
14.	Soft	"Soft"
15.	Nostalgia	"Nostalgia"
16.	Jazz	"Jazz"
17.	Classical	"Classical"
18.	R & B	"Rhythm & Blues"
19.	Soft R & B	"Soft R & B"
20.	Language	"Foreign Language"
21.	Religious Music	"Religious Music"
22.	Religious Talk	"Religious Talk"

23.	Personality	"Personality"
24.	Public	"Public"
25.	College	"College"
26.	Weather	"Weather"



- Speech and Music include the Program type below.

Speech: No.3 — 6, 20, 22 — 26

Music: No.7 — 19, 21

- The Program Type can be put in the [#1] — [#6] button memory and called up quickly. Refer to the <Program Type preset> (page 26).

### 3 Search for the selected Program Type station

Press the [◀◀] or [▶▶] button.

When you want to search for other stations press the [◀◀] or [▶▶] button again.



- When the selected Program Type isn't found, "NO PTY" is displayed. Select another Program Type.

### 4 Exit PTY mode

Press the [PTY] button.

### Confirming the Program Type

Press the [DISP] button.

The Program Type is displayed for 5 seconds.

## RDS features

### Registration of a station as a PTY

Registering a Program Type for stations with no PTY data.

- 1 Receive the station you want to register**
- 2 Select the Program Type to register**  
Refer to <PTY(Program Type)> (page 25).
- 3 Register the Program Type**  
Press the [NAME.S] button for at least 2 seconds.
- 4 Exit PTY mode**  
Press the [PTY] button.

### Program Type preset

Putting the Program Type in the Preset button memory and calling it up quickly.

#### **Presetting the Program Type**

- 1 Select the Program Type to preset**  
Refer to <PTY(Program Type)> (page 25).
- 2 Preset the Program Type**  
Press the [#1] — [#6] button for at least 2 seconds.

#### **Calling up the preset Program Type**

- 1 Enter PTY mode**  
Refer to <PTY(Program Type)> (page 25).
- 2 Call up the Program Type**  
Press the [#1] — [#6] button.

### Radio Text Scroll

Scrolling the displayed radio text.

Press the [DISP] button for at least 1 second.



The following parts show texts that can be scrolled.

- Character information display part ⑥  
Refer to <Display switching part for "Display Type A" and "Display Type B"> (page 13).  
Refer to <Display switching part for "Display Type C" and "Display Type D"> (page 16).

## CD/MP3/WMA/External disc control features

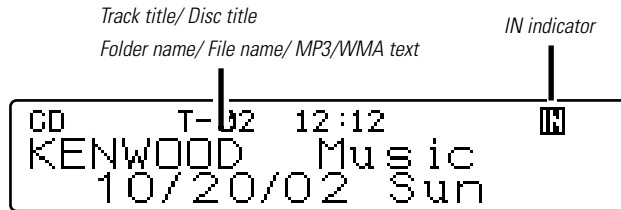
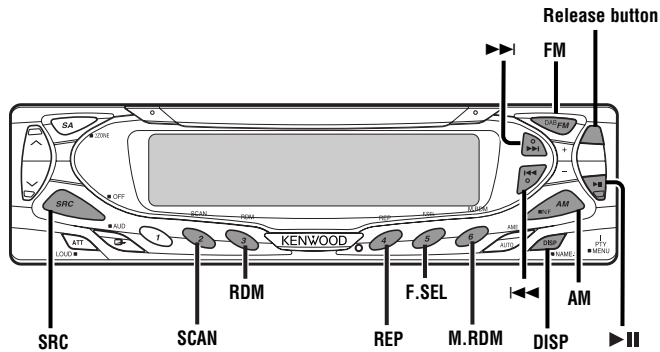

The display above is an example when Display type is set to "Display Type A".

The function indicator is displayed only if it is "Display Type A".

## CD/MP3/WMA/External disc control features

### Playing CD & MP3/WMA

#### When there is no disc inserted

##### 1 Drop open the faceplate

Press the Release button.

##### 2 Insert a disc.

##### 3 Press the faceplate on the right side, and return it to its former position.



- When the faceplate has been dropped open, it might interfere with the shift lever or something else. If this happens, pay attention to safety and move the shift lever or take an appropriate action, then operate the unit.
- Do not use the unit with the faceplate in the open condition. If it's used in the open position dust can enter the inside part and cause damage.



When a disc is inserted, the "IN" indicator is ON.

#### When a disc is inserted

Press the [SRC] button.

Select the "Compact Disc" display.

#### Pause and play

Press the [▶||] button.

Each time the button is pressed it pauses and plays.

#### Eject the disc

##### 1 Drop open the faceplate

Press the Release button.

##### 2 Eject the disc

Press the [▲] button.

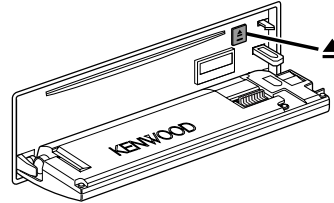

##### 3 Press the faceplate on the right side, and return it to its former position.



3 in. (8cm) disc can't be played. Using an adapter and inserting them into this unit can cause damage.



The MP3/WMA media that this unit can play are CD-ROM, CD-R, and CD-RW.

The medium formats must be ISO 9660 Level 1, Level 2, Joliet, or Romeo. The methods and precautions to be followed for writing MP3/WMA data are covered in <Notes on playing MP3/WMA> (page 6).

Check that section before creating your MP3/WMA media.

### Playing External Disc

Playing discs set in the optional accessory disc player connected to this unit.

Press the [SRC] button.

Select the display for the disc player you want.

Display examples:

Display	Disc player
"Compact Disc2"	CD player
"DiscChanger"	CD changer/ MD changer

### **Pause and play**

Press the [▶||] button.

Each time the button is pressed it pauses and plays.



The functions that can be used and the information that can be displayed will differ depending on the external disc players being connected.

### **Album Search**

Selecting the disc set in the Disc changer or the folder recorded on the MP3/WMA media.

Press the [FM] or [AM] button.

### **Fast Forwarding and Reversing**

#### **Fast Forwarding**

Hold down on the [▶▶] button.

Release your finger to play the disc at that point.

#### **Reversing**

Hold down on the [◀◀] button.

Release your finger to play the disc at that point.

### **Direct Track Search (Function of remote)**

Doing Track Search by entering the track number.

#### **1 Enter the track number**

Press the number buttons on the remote.

#### **2 Do Track Search**

Press the [◀◀] or [▶▶] button.

#### **Canceling Direct Track Search**

Press the [▶||] button.

### **Track Search**

Searching for a song on the disc or in the MP3/WMA folder.

Press the [◀◀] or [▶▶] button.

## CD/MP3/WMA/External disc control features

### Direct Album Search (Function of disc changers with remote)

Doing Disc Search by entering the disc number.

#### 1 Enter the disc number

Press the number buttons on the remote.

#### 2 Do Album Search

Press the [DISC+] or [DISC-] button.

#### Canceling Direct Album Search

Press the [▶||] button.

### Track/Album Repeat

Replaying the song, disc in the Disc changer or MP3/WMA folder you're listening to.

Press the [REP] button.

Each time the button is pressed the Repeat Play switches as shown below.

Repeat play	Display
Track Repeat (In CD/MD)	"Track Repeat ON"/ "Repeat ON"
(In MP3/WMA)	"File Repeat ON"
Album Repeat (In Disc Changer)	"Disc Repeat ON"
(In MP3/WMA media)	"Folder Repeat ON"
OFF	"Repeat OFF"

### Track Scan

Playing the first part of each song on the disc or MP3/WMA folder you are listening to and searching for the song you want to listen to.

#### 1 Start Track Scan

Press the [SCAN] button.

"Scan ON" is displayed.

#### 2 Release it when the song you want to listen to is played

Press the [SCAN] button.

### Random Play

Play all the songs on the disc or MP3/WMA folder in random order.

Press the [RDM] button.

Each time the button is pressed Random Play turns ON or OFF.

When it's ON, "Random ON" is displayed.



When the [▶▶] button is pressed, the next song select starts.

### Magazine Random Play (Function of disc changer)

Play the songs on all the discs in the disc changer in random order.

Press the [M.RDM] button.

Each time the button is pressed the Magazine Random Play turns ON or OFF.

When it's ON, "M.Random ON" is displayed.

 When the [▶▶] button is pressed, the next song select starts.

## Album Select (Function of MP3/WMA)

Quickly selecting the folder you want to listen to.

### 1 Enter Album Select mode

Press the [F.SEL] button.

"Select Mode" is displayed.

During Select mode the folder information is displayed as shown below.

*Folder name display*

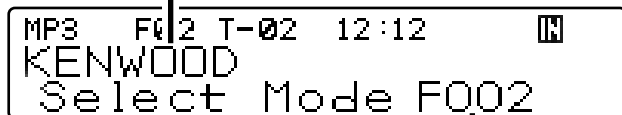

*Folder number display*

### 2 Select the folder level

Press the [FM] or [AM] button.

With the [FM] button you move 1 level down and with the [AM] button 1 level up.

### Selecting a folder in the same level

Press the [◀◀] or [▶▶] button.

With the [◀◀] button you move to the previous folder, and with the [▶▶] button to the next folder.

### Returning to the top level

Press the [#3] button.

### 3 Decide the folder to play

Press the [▶||] button.

The Album Select mode releases, and the MP3/WMA in the folder being displayed is played.

 The methods for moving to other folders in the album select mode are different from those in the album search mode.  
See <Notes on playing MP3/WMA> (page 6) for details.

### Canceling the Album Select mode

Press the [F.SEL] button.

 - Folder name display: Display the currently selected folder name.  
- Folder number display: Displays the number in the folder belonging to the currently selected folder.

## Text/Title Scroll

Scrolling the displayed CD text, MP3/WMA text, or MD title.

Press the [DISP] button for at least 1 second.

 The following parts show texts that can be scrolled.

- Character information display part ⑥  
Refer to <Display switching part for "Display Type A" and "Display Type B"> (page 13).
- Refer to <Display switching part for "Display Type C" and "Display Type D"> (page 16).

## CD/MP3/WMA/External disc control features

### DNPP (Disc Name Preset Play) (Function of disc changers with remote)

Selecting the CD displayed in the DNPS of the CDs set in the Disc changer.

#### 1 Enter DNPP mode

Press the [DNPP] button on the remote.

When "DNPP" is displayed the DNPS display in order.

#### Forward / Reverse display

Press the [DISC-] or [DISC+] button.

#### 2 When the disc you want is displayed

Press the [OK] button on the remote.

The disc being displayed is played.

#### Canceling the DNPP mode

Press the [DNPP] button on the remote.

## Menu system

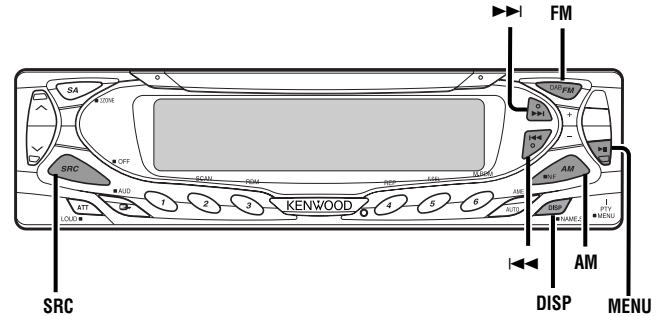



## Menu System

Setting during operation beep sound etc. functions.  
The Menu system basic operation method is explained here. The reference for the Menu items and their setting content is after this operation explanation.

### 1 Enter Menu mode

Press the [MENU] button for at least 1 second.

"MENU" is displayed.

### 2 Select the menu item

Press the [FM] or [AM] button.

Example: When you want to set the beep sound select the "Beep" display.

### 3 Set the menu item

Press the [◀◀] or [▶▶] button.

Example: When "Beep" is selected, each time the button is pressed it switches "Beep :ON" or "Beep :OFF". Select 1 of them as the setting.

You can continue by returning to step 2 and setting other items.

### 4 Exit Menu mode

Press the [MENU] button.



When other items that are applicable to the basic operation method above are displayed afterwards their setting content chart is entered. (Normally the uppermost setting in the chart is the original setting.)

Also, the explanation for items that aren't applicable (<Manual Clock Adjustment>etc.) are entered step by step.

## Menu system

### Security Code <In Standby mode>

Because authorization by the Security Code is required when it's removed from the vehicle, personalizing this unit is by using the Security Code is a help in preventing theft.



When the Security Code function is activated, the code can't be changed and the function can't be released.

Note, the Security Code can be set as the 4 digit number of your choice.

#### 1 Enter Standby

Press the [SRC] button.

Select the "ALL OFF" display.

#### 2 Enter Menu mode

Press the [MENU] button for at least 1 second.

When "MENU" is displayed, "Security" is displayed.

#### 3 Enter Security Code mode

Press the [◀◀] or [▶▶] button for at least 1 second.

When "ENTER" is displayed, "CODE" is displayed.

#### 4 Select the digits to enter

Press the [◀◀] or [▶▶] button.

#### 5 Select the Security Code numbers

Press the [FM] or [AM] button.

#### 6 Repeat steps 4 and 5, and complete the Security Code.

#### 7 Confirm the Security Code

Press the [▶▶] button for at least 3 seconds.

When "RE-ENTER" is displayed, "CODE" is displayed.

#### 8 Do the step 4 through 7 operation, and reenter the Security Code.

"APPROVED" is displayed.

The Security Code function activates.



When the wrong Code is entered in steps 4 through 6, repeat from step 4.

**Press the Reset button and when it's removed from the battery power source**

**1** Turn the power ON.

**2** Do the step 4 through 7 operation, and enter the Security Code.

"APPROVED" is displayed.

The unit can be used.

### Touch Sensor Tone

Setting the operation check sound (beep sound) ON/OFF.

Display	Setting
"Beep :ON"	Beep is heard.
"Beep :OFF"	Beep canceled.

### Manual Clock Adjustment



This adjustment can be done when the <Synchronize Clock> (page 35) is set as OFF.

#### 1 Select Clock Adjustment mode

Press the [FM] or [AM] button.

Select the "Clock Adjust" display.

#### 2 Enter Clock Adjust mode

Press the [◀◀] or [▶▶] button for at least 1 second.

The clock display blinks.

### 3 Adjust the hours

Press the [FM] or [AM] button.

#### Adjust the minutes

Press the [◀◀] or [▶▶] button.

### 4 Exit Clock adjustment mode

Press the [MENU] button.

## Date Adjustment

#### 1 Select Date Adjust mode

Press the [FM] or [AM] button.

Select the "Date Adjust" display.

#### 2 Enter Date Adjust mode

Press the [◀◀] or [▶▶] button for at least 1 second.

The date display blinks.

#### 3 Selecting the item (day, month, or year) to adjust

Press the [◀◀] or [▶▶] button.

The items that are blinking are items that can be adjusted.

#### 4 Adjust each item

Press the [FM] or [AM] button.

#### 5 Repeat step 3 and 4 operation and adjust the date.

#### 6 Exit Date adjustment mode

Press the [MENU] button.

## Date Mode

Setting the date format.

#### 1 Select Date Mode

Press the [FM] or [AM] button.

Select the "Date Mode" display.

#### 2 Select the date format

Press the [◀◀] or [▶▶] button.

## Synchronize Clock

Synchronizing the RDS station time data and this unit's clock.

Display	Setting
"SYNC :OFF"	Adjust the time manually.
"SYNC :ON"	Synchronizes the time.



It takes 3 to 4 minutes to synchronize the clock.

## DSI (Disabled System Indicator)

A red indicator will blink on the unit after the faceplate is removed, warning potential thieves.

Display	Setting
"DSI :ON"	LED flashes.
"DSI :OFF"	LED OFF.

## Menu system

### Contrast Adjustment

Adjusting the display contrast.

#### Display and Setting

"Contrast :0"

"Contrast :1"

"Contrast :2" (Original setting)

"Contrast :3"

### Built-in Amp Mute Setting <In Standby mode>

Toggles ON or OFF the mute control on the built-in amplifier. Turning ON this control enhances the preout quality.

#### Display

#### Setting

"AMP Mute :OFF"

The built-in amplifier activates.

"AMP Mute :ON"

The built-in amplifier deactivates.

### Dimmer

Dimming this unit's display automatically when the vehicle light switch is turned ON.

#### Display

#### Setting

"Dimmer :ON"

The display dims.

"Dimmer :OFF"

The display doesn't dim.

### Dual Zone System Setting

#### <When the Dual Zone System is OFF >

Setting the Front channel and Rear channel sound when the Dual Zone System is ON.

#### Display

#### Setting

"Zone 2 :Rear"

The front is this unit's internal source, and the rear is Auxiliary input sound.

"Zone 2 :Front"

The rear is this unit's internal source, and the front is Auxiliary input sound.

### System Q

Setting display/don't display for the System Q factors (Bass center frequency, Bass Q factor, Bass extend, Middle center frequency, Middle Q factor, and Treble center frequency) in Audio control.

#### Display

#### Setting

"System Q :ON"

The System Q factors are displayed.

"System Q :OFF"

The System Q factors aren't displayed.

## B.M.S. (Bass Management System)

Adjust the bass boost level of the external amplifier using the main unit.

Display	Setting
"AMP Bass Flat"	Bass boost level is flat.
"AMP Bass +6"	Bass boost level is low (+6dB).
"AMP Bass +12"	Bass boost level is mid (+12dB).
"AMP Bass +18"	Bass boost level is high (+18dB).



- Refer to the catalog or instruction manual for power amplifiers that can be controlled from this unit.
- For amplifiers there are the model that can be set from Flat to +18 dB, and the model that can be set from Flat to +12 dB.

When an amplifier that can only be set to +12 is connected to the unit, "AMP Bass +18" won't work correctly even if it's selected.

## B.M.S. Frequency Offset

Setting the central frequency boosted by B.M.S.

Display	Setting
"AMP Frq :Normal"	Boost with the normal central frequency
"AMP Frq :Low"	Drop the normal central frequency 20%

## Traffic Information

Switching to traffic information automatically when a traffic bulletin starts even when you aren't listening to the radio.

Display	Setting
"TI :OFF"	The Traffic Information function is OFF.
"TI :ON"	The Traffic Information function is ON.

When a traffic bulletin starts, "Traffic Info" is displayed it and it switches to traffic information.



- During reception of a AM station when the Traffic Information function is turned on ON it switches to a FM station.
- During reception of traffic information the adjusted volume is automatically remembered, and the next time it switches to traffic information it's automatically the remembered volume.

### Receiving other traffic information stations (In tuner source)

Press the [◀◀] or [▶▶] button.



Traffic information station switching can be done when listening to the radio.

## CRSC (Clean Reception System Circuit)

<In FM reception>

Temporarily have reception switched from stereo to mono to reduce multi-path noise when listening to the FM station.

Display	Setting
"CRSC :ON"	The CRSC is ON.
"CRSC :OFF"	The CRSC is OFF.



Strong electrical fields (such as from power lines) may cause unstable sound quality when CRSC is turned ON. In such a situation, turn it OFF.

## Menu system

### Text Scroll

Setting the displayed text scroll.

Display	Setting
"Scroll :Auto"	Repeats scroll.
"Scroll :Manual"	Scrolls when the display changes.



The text scrolled is shown below.

- CD text
- Folder name/ File name/ MP3/WMA text
- MD title
- Radio text

### Built-in Auxiliary input Setting

Set the Built-in Auxiliary Input function.

Display	Setting
"AUX IN :OFF"	When selecting the source there's no Auxiliary Input.
"AUX IN :ON"	When selecting the source there's Auxiliary Input.

### Picture downloading <In Standby mode>

For the setting method refer to the <Picture downloading> (page 18).

## Basic Operations of remote

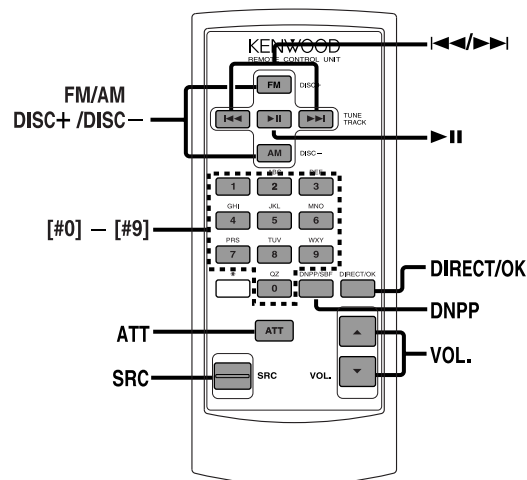

## Loading and Replacing the battery

Use one lithium battery (CR2025).  
Insert the batteries with the + and – poles aligned properly,  
following the illustration inside the case.

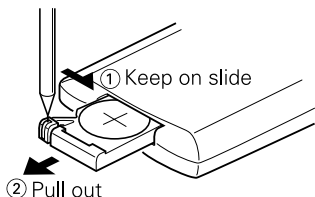

### ▲WARNING

Store unused batteries out of the reach of children. Contact a doctor immediately if the battery is accidentally swallowed.

⚠ Do not set the remote on hot places such as above the dashboard.

## Basic operations

### [VOL.] buttons

Adjusting the volume.

### [SRC] button

Each time the button is pressed the source switches.  
For the source switching order refer to <Selecting the Source>  
(page 9).

### [ATT] button

Turning the volume down quickly.  
When it is pressed again it returns to the previous level.

## In Tuner source

### [FM]/ [AM] buttons

Select the band.

Each time the [FM] button is pressed it switches between the FM1, FM2, and FM3 bands.

### [◀◀]/ [▶▶] buttons

Tune up or down band.

### [#0] – [#9] buttons

Press buttons [#1] — [#6] to recall preset stations.

### [DIRECT] button

Enters and cancels the <Direct Access Tuning> (page 23) mode.

### [▶II] button

Enters and cancels the <PTY (Program Type)> (page 25) mode.

### [DNPP]/ [OK] button

Enters and cancels the <SNPP (Station Name Preset Play)> (page 24) mode.

## ***Basic Operations of remote***

### **In Disc source**

#### **[◀◀]/ [▶▶] buttons**

Doing track forward and backward.

#### **[DISC+]/ [DISC-] buttons**

Doing album forward and backward.

#### **[▶ II] button**

Each time the button is pressed the song pauses and plays.

#### **[DNPP]/ [OK] button**

Enters and cancels the <DNPP (Disc Name Preset Play)> (page 32) mode.

#### **[#0] – [#9] buttons**

When in <Direct Track Search> (page 29) and <Direct Album Search> (page 30), enter the track/disc number.



## Accessories

### External view

..... Number of items

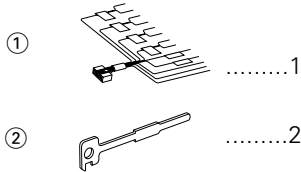

### External view

..... Number of items

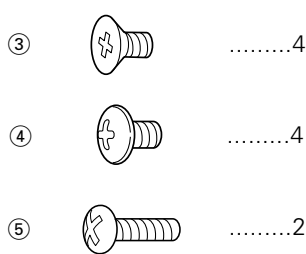

The use of any accessories except for those provided might result in damage to the unit. Make sure only to use the accessories shipped with the unit, as shown above.

## Installation Procedure

1. To prevent a short circuit, remove the key from the ignition and disconnect the  $\ominus$  battery.
2. Make the proper input and output wire connections for each unit.
3. Connect the speaker wires of the wiring harness.
4. Connect the wiring harness wires in the following order: ground, battery, ignition.
5. Connect the wiring harness connector to the unit.
6. Install the unit in your car.
7. Reconnect the  $\ominus$  battery.
8. Press the reset button.

### ▲WARNING

If you connect the ignition wire (red) and the battery wire (yellow) to the car chassis (ground), you may cause a short circuit, that in turn may start a fire. Always connect those wires to the power source running through the fuse box.

### ▲CAUTION

- If your car's ignition does not have an ACC position, connect the ignition wires to a power source that can be turned on and off with the ignition key. If you connect the ignition wire to a power source with a constant voltage supply, as with battery wires, the battery may die.
- If the console has a lid, make sure to install the unit so that the faceplate will not hit the lid when closing and opening.
- If the fuse blows, first make sure the wires aren't touching to cause a short circuit, then replace the old fuse with one with the same rating.
- Insulate unconnected wires with vinyl tape or other similar material. To prevent a short circuit, do not remove the caps on the ends of the unconnected wires or the terminals.
- Connect the speaker wires correctly to the terminals to which they correspond. The unit may be damaged or fail to work if you share the  $\ominus$  wires or ground them to any metal part in the car.
- When only two speakers are being connected to the system, connect the connectors either to both the front output terminals or to both the rear output terminals (do not mix front and rear). For example, if you connect the  $\oplus$  connector of the left speaker to a front output terminal, do not connect the  $\ominus$  connector to a rear output terminal.
- After the unit is installed, check whether the brake lamps, blinkers, wipers, etc. on the car are working properly.
- Mount the unit so that the mounting angle is  $30^\circ$  or less.

# Connecting Wires to Terminals

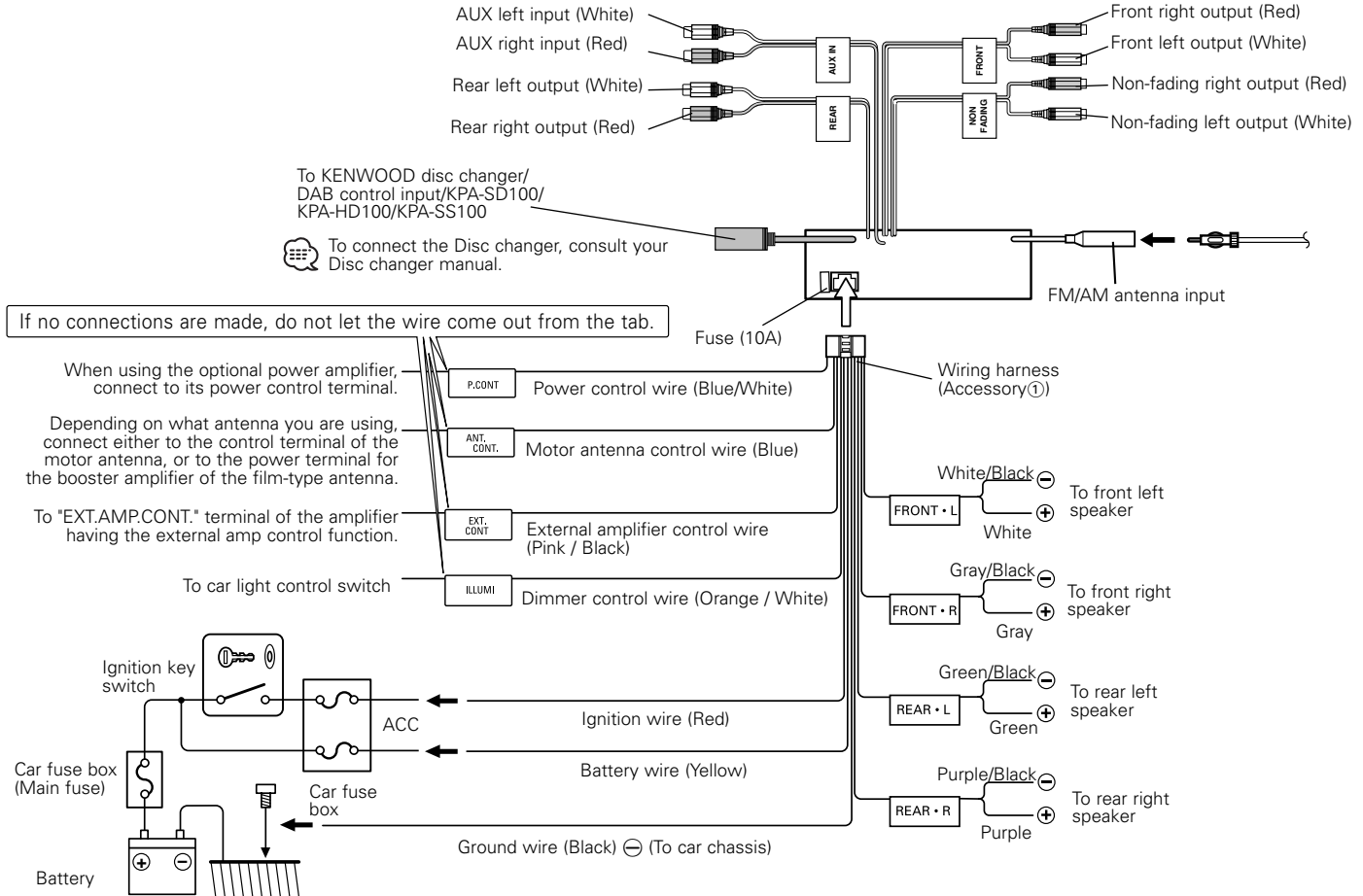

# Installation

## ■ Installation

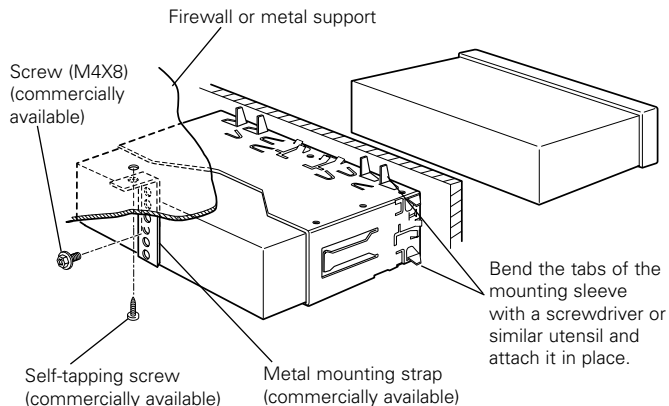

Make sure that the unit is installed securely in place. If the unit is unstable, it may malfunction (for example, the sound may skip).

## ■ Installing in Japanese-Made Cars

- 1 Refer to the section "Removing the hard rubber frame" (page 44) and then remove the hard rubber frame.
- 2 Align the holes in the unit (two locations on each side) with the vehicle mounting bracket and secure the unit with the accessory screws.

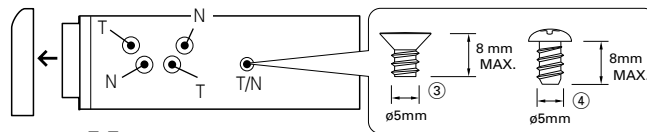

- ⚠ During installation, do not use any screws except for those provided. The use of different screws might result in damage to the main unit.
- Damage may occur if a screwdriver or similar tool is used with excessive force during the installations.

## ■ Screwing the Faceplate on the Unit

If you want to fasten the faceplate to the main unit so that it does not fall off, screw in the provided screws ( $\phi 2.6 \times 12$  mm) in the holes shown below.

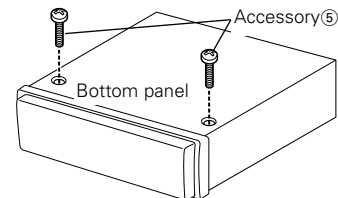

- ⚠ Never insert the tapite screw ( $\phi 2.6 \times 12$  mm) in any other screw hole than the one specified. If you screw it in another hole, it will contact and may cause damage to the mechanical parts inside the unit.

## Installation

### ■ Removing the hard rubber frame

- 1 Engage the catch pins on the removal tool and remove the two locks on the lower level.  
Lower the frame and pull it forward as shown in the figure.

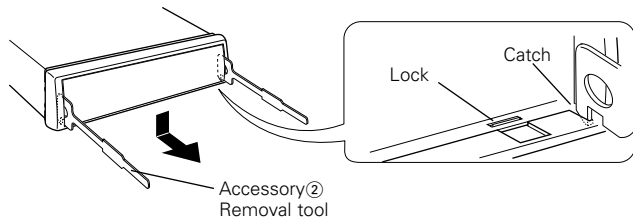

- 2 When the lower level is removed, remove the upper two locations.

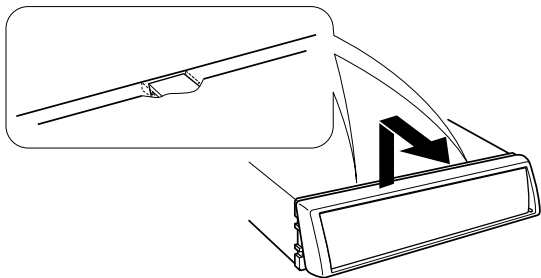

The frame can be removed from the top side in the same manner.

### ■ Removing the Unit

- 1 Refer to the section “Removing the hard rubber frame” and then remove the hard rubber frame.
- 2 Remove the screw (M4 × 8) on the back panel.
- 3 Insert the two removal tools deeply into the slots on each side, as shown.

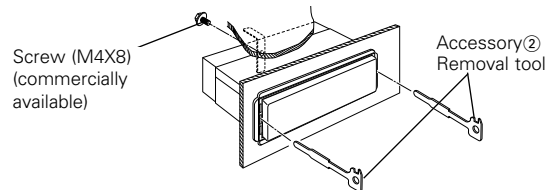

- 4 Lower the removal tool toward the bottom, and pull out the unit halfway while pressing towards the inside.



Be careful to avoid injury from the catch pins on the removal tool.

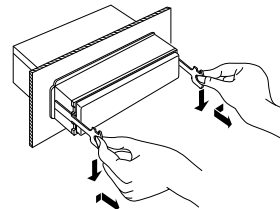

- 5 Pull the unit all the way out with your hands, being careful not to drop it.

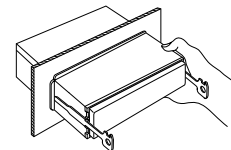

## Troubleshooting Guide

**What might seem to be a malfunction in your unit may just be the result of slight misoperation or miswiring. Before calling service, first check the following table for possible problems.**

### General

#### ? The power does not turn ON.

- ✓ The fuse has blown.
  - ☞ After checking for short circuits in the wires, replace the fuse with one with the same rating.
- ✓ No ACC position on vehicle ignition.
  - ☞ Connect the same wire to the ignition as the battery wire.

#### ? Nothing happens when the buttons are pressed.

- ✓ The computer chip in the unit is not functioning normally.
  - ☞ Press the reset button on the unit (page 5).

#### ? There's a source you can't switch.

- ✓ There's no CD inserted.
  - ☞ Set the media you want to listen to. If there's no media in this unit, you can't switch to each source.
- ✓ The Disc changer isn't connected.
  - ☞ Connect the Disc changer. If the Disc changer isn't connected to its input terminal, You can't switch to an external disc source.

#### ? The faceplate does not open or close.

- ✓ The faceplate is incorrectly attached.
  - ☞ Reattach the faceplate correctly, See the section on <Removing the Faceplate>(page 19).

#### ? The memory is erased when the ignition is turned OFF.

- ✓ The battery wire has not been connected to the proper terminal.
  - ☞ Connect the wire correctly, referring to the section on <Connecting Wires to Terminals>.
- ✓ The ignition and battery wire are incorrectly connected.
  - ☞ Connect the wire correctly, referring to the section on <Connecting Wires to Terminals>.

#### ? There's no loudness effect.

- ✓ You're using Non-fading preout.
  - ☞ Loudness has no effect in Non-fading preout.

#### ? Even if Loudness is turned ON, high-pitched tone isn't compensated for.

- ✓ Tuner source is selected.
  - ☞ High-pitched tone isn't compensated for when in Tuner source.

#### ? The Bass center frequency, Bass quality factor, Bass extend, Middle center frequency, Middle quality factor, and Treble center frequency can't be adjusted.

- ✓ The <System Q> (page 36) is set OFF.
  - ☞ Set it ON.

#### ? No sound can be heard, or the volume is low.

- ✓ The fader or balance settings are set all the way to one side.
  - ☞ Center the fader and balance settings.
- ✓ The input/output wires or wiring harness are connected incorrectly.
  - ☞ Reconnect the input/output wires or the wiring harness correctly. See the section on <Connecting Wires to Terminals>.
- ✓ The values of Volume offset are low.
  - ☞ Increase the values of Volume offset. (page 11)

#### ? The sound quality is poor or distorted.

- ✓ One of the speaker wires is being pinched by a screw in the car.
  - ☞ Check the speaker wiring.
- ✓ The speakers are not wired correctly.
  - ☞ Reconnect the speaker wires so that each output terminal is connected to a different speaker.

#### ? Non-fading output, Non-fading Low Pass Filter and Non-fading setting can't be done.

- ✓ The <Non-fading output> (page 19) is OFF.
  - ☞ Turn it ON.
- ✓ The <Dual zone system> (page 21) is ON.
  - ☞ Turn it OFF.

## Troubleshooting Guide

### ? There's no Front High Pass Filter and Rear High Pass Filter effect.

- ✓ The Non-fading preout is being used.
  - ☞ There's no effect in Non-fading preout.

### ? The Security Code item isn't displayed in the Menu System.

- ✓ The Security Code function is already activated.
  - ☞ When the Security Code function is activated it isn't displayed in the menu items.

### ? The Touch Sensor Tone doesn't sound.

- ✓ The preout jack is being used.
  - ☞ The Touch Sensor Tone can't be output from the preout jack.

### ? Even though the vehicle light switch is turned ON, the unit's display won't dim.

- ✓ The dimmer wire isn't connected.
  - ☞ Connect the dimmer wire correctly.

### ? The Dimmer function doesn't work.

- ✓ The Dimmer wire isn't connected correctly.
  - ☞ Check the Dimmer wire connection.
- ✓ The <Built-in Amp Mute Setting> (page 36) is ON.
  - ☞ Turn it OFF.

### ? AUX cannot be selected.

- ✓ <Built-in Auxiliary input Setting> is turned off.
  - ☞ Refer to the <Built-in Auxiliary input Setting> (page 38) in the menu setting and turn on the <Built-in Auxiliary input Setting> .

## Tuner source

### ? Radio reception is poor.

- ✓ The car antenna is not extended.
  - ☞ Pull the antenna out all the way.
- ✓ The antenna control wire is not connected.
  - ☞ Connect the wire correctly, referring to the section on <Connecting Wires to Terminals>.

### ? The desired frequency can't be entered with the Direct Access Tuning.

- ✓ A station that can't be received is being entered.
  - ☞ Enter a station that can be received.
- ✓ You're trying to enter a frequency with a 0.01 MHz unit.
  - ☞ What can be designated in the FM band is to 0.1 MHz.

### ? It isn't the set Traffic information sound volume.

- ✓ The set sound volume is less than the tuner sound volume.
  - ☞ If the tuner sound volume is louder than the set sound volume, the tuner sound volume is used.

## Troubleshooting Guide

---

### Disc source

#### ? "AUX" is displayed without achieving External disc control mode.

- ✓ O-N switch is set to "O" side.
    - ☞ Set the switch to "N" side.
  - ✓ Unsupported disc changer is connected.
    - ☞ Connect the supported disc changer. (page 4)
- 

#### ? The specified disc does not play, but another one plays instead.

- ✓ The specified CD is quite dirty.
    - ☞ Clean the CD.
  - ✓ The CD is upside-down.
    - ☞ Load the CD with the labeled side up.
  - ✓ The disc is loaded in a different slot from that specified.
    - ☞ Eject the disc magazine and check the number for the specified disc.
  - ✓ The disc is severely scratched.
    - ☞ Try another disc instead.
- 

#### ? The specified track will not play.

- ✓ Random play or magazine random play has been selected.
    - ☞ Turn off random play or magazine random play.
- 

#### ? Cannot play CD-R or CD-RW.

- ✓ Finalization processing is not being conducted for CD-R/CD-RW.
    - ☞ Conduct finalization processing with CD recorder.
  - ✓ A non-compatible CD changer is being used to play the CD-R/CD-RW.
    - ☞ Use a CD changer compatible with CD-R/CD-RW to play.
- 

#### ? A CD ejects as soon as it is loaded.

- ✓ The CD is upside-down.
    - ☞ Load the CD with the labeled side up.
  - ✓ The CD is quite dirty.
    - ☞ Clean the CD, referring to the section on <CD cleaning> (page 8).
- 

#### ? Can't remove disc.

- ✓ The cause is that more than 10 minutes has elapsed since the vehicle ACC switch was turned OFF.
    - ☞ The disc can only be removed within 10 minutes of the ACC switch being turned OFF. If more than 10 minutes has elapsed, turn the ACC switch ON again and press the Eject button.
- 

#### ? The disc won't insert.

- ✓ There's already another disc inserted.
    - ☞ Press the [▲] button and remove the disc.
- 

#### ? Direct Track Search and Direct Album Search can't be done.

- ✓ Another function is ON.
    - ☞ Turn Random Play or other functions OFF.
- 

#### ? Track Search can't be done.

- ✓ For the albums first or last song.
    - ☞ For each album, Track Search can't be done in the backward direction for the first song or in the forward direction for the last song.
-

## Troubleshooting Guide

### MP3/WMA source

#### ? Cannot play an MP3/WMA.

- ✓ Not conforming to ISO 9660 Level 1/2, Joliet, and Romeo.
  - ☞ Use a medium conforming to ISO 9660 Level 1/2, Joliet, and Romeo.
- ✓ The MP3/WMA has no or invalid track name extension.
  - ☞ Add the ".MP3/WMA" extension to the MP3/WMA track name.
- ✓ The media is scratched or dirty.
  - ☞ Clean the media, referring to the section on <CD cleaning> (page 8).
- ✓ The CD-RW is used with the quick format.
  - ☞ Select the full format to use CD-RWs.

#### ? Noise or no sound generated when an MP3/WMA is played.

- ✓ The track has the MP3/WMA track name extension while it is not an MP3/WMA.
  - ☞ Do not use the ".MP3/WMA" extension in non-MP3/WMA.

#### ? Takes time before the unit starts playing MP3/WMA.

- ✓ The medium contains many albums, tracks, and hierarchical levels.
  - ☞ The unit checks all tracks on the loaded medium first. If the medium has many tracks recorded, it may take a long time for the unit before it starts playing MP3/WMA.

#### ? Fails to play MP3/WMA in the intended order.

- ✓ The MP3/WMA tracks were not written by the CD writer in the order in which you wanted them to be played.
  - ☞ Depending on the CD writer, you may be able to set the order in which MP3/WMA tracks are to be played by writing them onto a medium with their track names beginning with play sequence numbers such as "01" to "99".

#### ? The sound skips when an MP3/WMA is being played.

- ✓ The media is scratched or dirty.
  - ☞ Clean the media, referring to the section on <CD cleaning> (page 8).
- ✓ The recording condition is bad.
  - ☞ Record the media again or use another media.

#### ? Can't display the ID3 tag information correctly.

- ✓ Record is not made in conformity with the ID 3 tag version1.x.
  - ☞ Record in conformity with the ID 3 tag version1.x.

#### ? Can't enter Album Select mode.

- ✓ There's no folder recorded in the MP3/WMA media.
  - ☞ Use a media with levels.

#### ? The songs in the selected folder aren't played in Album Select mode.

- ✓ There are no MP3/WMA in the selected folder.
  - ☞ Make sure there's recorded content in the MP3/WMA media.

#### ? The MP3/WMA track/album search takes time.

- ✓ Many tracks are recorded on the media.
  - ☞ When the media directory is complex, the track/album search can take time.

#### ? The MP3/WMA related text isn't displayed correctly.

- ✓ A character is entered that this unit can't display.
  - ☞ For the characters that can be used for MP3/WMA text entry, refer to <Notes on playing MP3/WMA> (page 6).

#### ? The MP3/WMA track time isn't displayed correctly.

- ✓ ---
  - ☞ There are times when it isn't displayed correctly according to the MP3/WMA recording conditions.



## Troubleshooting Guide

---

### The messages shown below display your systems condition.

Eject:	No disc magazine has been loaded in the changer. The disc magazine is not completely loaded. ⇨ Load the disc magazine properly. No CD in the unit. ⇨ Insert the CD.	Mecha Error:	Something is wrong with the disc magazine. Or the unit is malfunctioning for some reason. ⇨ Check the disc magazine. And then press the reset button on the unit. If the "Mecha Error" code does not disappear, consult your nearest service center.
No Disc:	No disc has been loaded in the disc magazine. ⇨ Load a disc into the disc magazine.	Hold Error:	The protective circuit in the unit activates when the temperature inside the automatic disc changer exceeds 60°C (140°F), stopping all operation. ⇨ Cool down the unit by opening the windows or turning on the air conditioner. As the temperature falls below 60°C (140°F), the disc will start playing again.
TOC Error:	No disc has been loaded in the disc magazine. ⇨ Load a disc into the disc magazine. The CD is quite dirty. The CD is upside-down. The CD is scratched a lot. ⇨ Clean the CD and load it correctly.	NO NAME:	<ul style="list-style-type: none"><li>• Attempted to display DNPS during the CD play having no disc names preset.</li><li>• Attempted to display SNPS during the receiving session of the station having no station name preset.</li></ul>
E-05:	The CD is upside-down. ⇨ Load the CD correctly.	NO TITLE:	Attempted to display the disc title or track title while the MD having no MD title is being played.
Blank Disc:	Nothing has been recorded on the MD.	NO TEXT:	<ul style="list-style-type: none"><li>• Attempted to display the disc text or track text while the CD having no CD text is being played.</li><li>• Attempted to display text during reception of the station that isn't sending text data.</li><li>• Attempted to display the ID3 tag or contents description while the MP3/WMA having no ID3 tag or contents description is being played.</li></ul>
No Track Disc:	No tracks are recorded on the MD, although it has a title.	Waiting:	Radio text data is being received.
No Music Data:	Media was played that doesn't have data recorded that the unit can play. ⇨ Use media that has data recorded that the unit can play. Files for picture downloading only are recorded in CD-R/CD-RW.	Load:	Discs are being exchanged in the Disc changer.
No Panel:	The faceplate of the slave unit being connected to this unit has been removed. ⇨ Replace it.	Reading:	The unit is reading the data on the disc.
E-77:	The unit is malfunctioning for some reason. ⇨ Press the reset button on the unit. If the "E-77" code does not disappear, consult your nearest service center.	NO ACCESS:	After setting it in the Disc Changer, DNPP was done without having it been played at least 1 time.

## Troubleshooting Guide

---

IN (Blink): The CD player section is not operating properly.  
⇨ Reinsert the CD. If the CD cannot be ejected or the display continues to flash even when the CD has been properly reinserted, please switch off the power and consult your nearest service center.

Unsupported File:  
A WMA is played with a format that this unit can't support.

Protected File: A copy-protected file is played.

Can't Download:  
Download Error:  
This unit does not work properly for some reason.  
⇨ Press the reset button to download it again. If this error is still displayed, consult a local Kenwood dealer.

No Display Data File:  
No file that can be downloaded is contained in the CD-ROM.  
⇨ Make sure that a files created with referring to <<http://www.kenwoodusa.com/division.jsp?categoryld=3>> is contained in the CD-ROM.  
Do not delete the extension (.kbn) created when the file was created.

Incorrect File: The file selected to be downloaded has a format that this unit cannot read.  
⇨ Recreate the file.

Writing Error: Writing failed while the file was downloaded.  
⇨ Try the downloading again.

## Specifications

### Specifications subject to change without notice.

#### FM tuner section

Frequency range (200 kHz space) .....	87.9 MHz – 107.9 MHz
Usable sensitivity (S/N = 30dB) .....	9.3dBf (0.8 $\mu$ V/75 $\Omega$ )
Quieting Sensitivity (S/N = 50dB) .....	15.2dBf (1.6 $\mu$ V/75 $\Omega$ )
Frequency response ( $\pm$ 3.0 dB).....	30 Hz – 15 kHz
Signal to Noise ratio (MONO).....	70 dB
Selectivity ( $\pm$ 400 kHz).....	$\geq$ 80 dB
Stereo separation (1 kHz) .....	40 dB

#### AM tuner section

Frequency range (10 kHz space) .....	530 kHz – 1700 kHz
Usable sensitivity (S/N = 20dB) .....	28 dB $\mu$ (25 $\mu$ V)

#### CD player section

Laser diode .....	GaAlAs ( $\lambda$ =780 nm)
Digital filter (D/A).....	8 Times Over Sampling
D/A Converter .....	1 Bit
Spindle speed ..(CD-DA/MP3/WMA).....	1000 – 400 rpm (CLV 2times)
Wow & Flutter.....	Below Measurable Limit
Frequency response ( $\pm$ 1 dB).....	10 Hz – 20 kHz
Total harmonic distortion (1 kHz) .....	0.01 %
Signal to Noise ratio (1 kHz) .....	96 dB
Dynamic range .....	95 dB
Channel separation.....	90 dB
MP3 decode .....	Compliant with MPEG-1.0/2.0/2.5 Audio Layer-3
WMA decode .....	Compliant with Windows Media Audio 8

#### Audio section

Maximum output power.....	50 W x 4
Full Bandwidth Power (at less than 1% THD) .....	22 W x 4
Tone action	
Bass : .....	100 Hz $\pm$ 10 dB
Middle : .....	1 kHz $\pm$ 10 dB
Treble : .....	10 kHz $\pm$ 10 dB
Preout level / Load (during disc play).....	4500 mV/10 k $\Omega$
Preout impedance.....	80 $\Omega$

#### Auxiliary input

Frequency response ( $\pm$ 1 dB).....	20 Hz – 20 kHz
Input Maximum Voltage .....	1.2 V
Input Impedance .....	$\geq$ 44 k $\Omega$

#### General

Operating voltage (11 – 16V allowable) .....	14.4 V
Current consumption.....	10 A
Installation Size (W x H x D) .....	180 x 50 x 159 mm
	7-1/16 x 1-15/16 x 6-1/4 inch
Weight.....	3.08 lbs (1.4 kg)

KENWOOD

## Free Manuals Download Website

<http://myh66.com>

<http://usermanuals.us>

<http://www.somanuals.com>

<http://www.4manuals.cc>

<http://www.manual-lib.com>

<http://www.404manual.com>

<http://www.luxmanual.com>

<http://aubethermostatmanual.com>

Golf course search by state

<http://golfingnear.com>

Email search by domain

<http://emailbydomain.com>

Auto manuals search

<http://auto.somanuals.com>

TV manuals search

<http://tv.somanuals.com>