

KENWOOD

Z828MP

CD-RECEIVER
INSTRUCTION MANUAL

KENWOOD CORPORATION



B64-2089-00 (EW)

Contents

Safety precautions	3	Volume Offset	21	Menu settings	
Handling Compact discs	6	Tuner features		Menu System.....	38
Notes on playing MP3 files	8	Tuning.....	22	Code Security Function.....	39
General features		Station Preset Memory.....	22	Touch Sensor Tone	40
Power	10	Direct Access Tuning.....	23	Manual Time Adjustment	40
Volume.....	10	Preset station seek		Calendar Adjustment.....	40
Attenuator.....	11	with Programme service name.....	23	Calendar Mode.....	40
Switching Modes.....	11	RDS features		Automatic Time Adjustment.....	41
Loudness.....	11	RDS (Radio Data System)	24	Disabled System Indicator (DSI).....	41
Switching Display Mode.....	12	Enhanced Other Network	24	Icon/Spectrum analyzer Select.....	41
Switching the Upper Part Display.....	12	Alarm.....	24	Font Select	41
Switching the Lower Part Display	14	Traffic Information Function.....	25	Dimmer	41
Switching Full-Screen Display.....	15	Presetting Volume for Traffic		System Q	42
TEL Mute.....	15	Information/News.....	25	Switching preout	42
Switching Display during the		Programme Type (PTY) Function	26	Built-in Amp Mute Control	42
Standby mode	16	Changing Language for		Switching Dual Zone System Output.....	42
Theft Deterrent Faceplate	16	Programme Type(PTY) Function	27	External Amp Control	42
System Q	16	Radio Text Scroll	27	News Bulletin Function	
Speaker & Woofer setting	17	CD/External disc control features		with PTY News Timeout Setting	42
Non-Fading Output	17	Playing CDs	28	Local Seek Function	43
Dual Zone System.....	18	Playing Other Disc mode	29	Selecting Tuning Mode.....	43
Audio control features		Fast Forwarding and Reversing		Auto Memory Entry	43
Audio Control Setting	19	Disc Play.....	29	AF (Alternative Frequency) Function	44
Bass Centre Frequency	19	Track Search	30	Restricting RDS Region	
Bass Level	19	Disc Search	30	(Region Restrict Function).....	44
Bass Quality Factor	19	Track / Disc Repeat.....	30	Auto TP Seek Function	44
Bass Extend	19	Track Scan	30	Monaural Reception	44
Middle Centre Frequency	20	Random Play	31	Reading the MP3 ID3 tag	44
Middle Level.....	20	Magazine Random Play.....	31	Text Scroll	45
Middle Quality Factor.....	20	Text Scroll.....	32	Power OFF Timer	45
Treble Centre Frequency	20	Presetting Disc Names (DNPS).....	32	Built-in AUX Control	45
Treble Level	20	Disc Name Preset Play (DNPP).....	33	Basic Operations	
Balance Level	20	MP3 player features		of remote control	46
Fader Level	20	Playing MP3 Files.....	34	Installation	
Non-Fading Level.....	20	File Search.....	35	Accessories.....	49
High-pass Filter Frequency		Folder Search	35	Installation Procedure.....	49
for Front Output	21	Fast Forwarding and Reversing		Connecting Cables to Terminals.....	50
High-pass Filter Frequency		MP3 Play.....	36	Installation	51
for Rear Output	21	Folder Select	36	Troubleshooting Guide	54
Low-pass Filter Frequency		File / Folder Repeat	37	Specifications	59
for Non-Fading Output	21	Random Play	37		
Phase for Non-Fading Output	21	Name Scroll for MP3.....	37		

Safety precautions

▲WARNING

To prevent injury and/or fire, take the following precautions:

- Insert the unit all the way until it is fully locked in place. Otherwise it may fly out of place during collisions and other jolts.
- When extending the ignition, battery or ground cables, make sure to use automotive-grade cables or other cables with an area of 0.75mm² (AWG18) or more to prevent cable deterioration and damage to the cable coating.
- To prevent short circuits, never put or leave any metallic objects (e.g., coins or metal tools) inside the unit.
- If the unit starts to emit smoke or strange smells, turn off the power immediately and consult your Kenwood dealer.
- Make sure not to get your fingers caught between the faceplate and the unit.
- Be careful not to drop the unit or subject it to strong shock.
The unit may break or crack because it contains glass parts.

▲CAUTION

To prevent damage to the machine, take the following precautions:

- Make sure to ground the unit to a negative 12V DC power supply.
- Do not open the top or bottom covers of the unit.
- Do not install the unit in a spot exposed to direct sunlight or excessive heat or humidity. Also avoid places with too much dust or the possibility of water splashing.
- Do not subject the faceplate to excessive shock, as it is a piece of precision equipment.
- When replacing a fuse, only use a new one with the prescribed rating. Using a fuse with the wrong rating may cause your unit to malfunction.
- To prevent short circuits when replacing a fuse, first disconnect the wiring harness.
- Do not place any object between the faceplate and the unit.
- During installation, do not use any screws except for the ones provided. The use of improper screws might result in damage to the main unit.
- Do not apply excessive force to the open faceplate or place objects on it. Doing so will cause damage or breakdown.

IMPORTANT INFORMATION

About the disc changer to be connected:

To connect a disc changer having the "O-N" switch to this unit, set the "O-N" switch to "N".

When you connect a model with no "O-N" switch, the converter cord CA-DS100 available as an option may be required. For details, consult your Kenwood dealer. If a model with no "O-N" switch is connected, some unavailable functions and information that cannot be displayed are generated, such as the DNPS, DNPP, Magazine random play, and CD Text display.

Note that none of the KDC-C100, KDC-C302, C205, C705, and non-Kenwood CD changers can be connected.

▲CAUTION

You can damage both your unit and the CD changer if you connect them incorrectly.

Do Not Load 8-cm (3-in.) CDs in the CD slot

If you try to load an 8-cm CD with its adapter into the unit, the adapter might separate from the CD and damage the unit.

Safety precautions

NOTE

- If you experience problems during installation, consult your Kenwood dealer.
- If the unit fails to operate properly, press the Reset button. The unit returns to factory settings when the Reset button is pressed. If the unit still fails to operate properly after the Reset button has been pressed, contact your local KENWOOD dealer for assistance.
- Press the reset button if the CD auto changer is first controlled and operates incorrectly. The original operating condition will return.

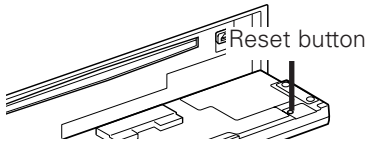

- We strongly recommend the use of the Code Security function (page 39) to prevent theft.

- The illustrations of the display and the panel appearing in this manual are examples used to explain more clearly how the controls are used. Therefore, what appears on the display in the illustrations may differ from what appears on the display on the actual equipment, and some of the illustrations on the display may represent something impossible in actual operation.
- The functions that can be used and the information that can be displayed will differ depending on the external disc players being connected.

Cleaning the Faceplate Terminals

If the terminals on the unit or faceplate get dirty, wipe them with a dry, soft cloth.

Cleaning the Unit

If the faceplate of this unit is stained, wipe it with a dry soft cloth such as a silicon cloth. If the faceplate is stained badly, wipe the stain off with a cloth moistened with neutral cleaner, then wipe neutral detergent off.

▲ CAUTION

Applying spray cleaner directly to the unit may affect its mechanical parts. Wiping the faceplate with a hard cloth or using a volatile liquid such as thinner or alcohol may scratch the surface or erase characters.

Cleaning the CD Slot

As dust can accumulate in the CD slot, clean it occasionally. Your CDs can get scratched if you put them in a dusty CD slot.

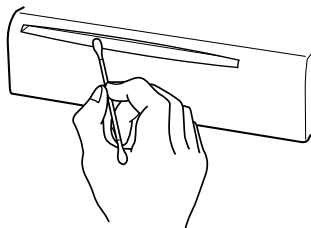

The marking of products using lasers (Except for some areas)

**CLASS 1
LASER PRODUCT**

The label is attached to the chassis/case and says that the component uses laser beams that have been classified as Class 1. It means that the unit is utilizing laser beams that are of a weaker class. There is no danger of hazardous radiation outside the unit.

Lens Fogging

Right after you turn on the car heater in cold weather, dew or condensation may form on the lens in the CD player of the unit. Called lens fogging, CDs may be impossible to play. In such a situation, remove the disc and wait for the condensation to evaporate. If the unit still does not operate normally after a whilst, consult your Kenwood dealer.

Handling Compact discs

Playing a CD that is dirty, scratched or warped can cause the sound to skip and the unit to operate incorrectly, resulting in worsened sound quality. Take the following precautions to prevent your CDs from getting scratched or damaged.

Handling CDs

- Do not touch the recorded side of the CD (i.e., the side opposite the label) when holding it.

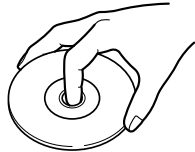

- The reflective film on a CD-R or a CD-RW is more fragile than that on an ordinary music CD, and may peel off if scratched. Fingerprints on a CD-R or CD-RW are also more likely to cause skipping when the disc is played. For these reasons, handle the disc very carefully. Detailed handling instructions will appear on the CD-R or CD-RW package: read this information carefully before using the disc.
- Do not stick tape on either side of the CD.

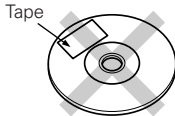

Storing CDs

- Do not store CDs in areas exposed to direct sunlight – such as a car seat or above the fascia panel (dashboard) – or other hot places. A CD-R or CD-RW is more susceptible than a music CD to damage from high temperatures and humidity, and in some cases, may become unusable if left in the car for long periods of time.
- Remove CDs from the unit when not listening to them for a whilst, and put them back in their cases. Do not stack CDs that have been removed from their cases or prop them against something.

Cleaning CDs

If a CD has become dirty, wipe it off gently using a commercially available cleaning cloth or a soft cotton cloth, starting from the centre of the disc and moving outward. Do not clean CDs with conventional record cleaners, anti-static formulas, or chemicals such as paint thinner or benzene.

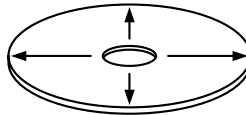

Checking New CDs for Burrs

When playing a new CD for the first time, check that there are not any burrs stuck to the perimeter of the disc or in the central hole. CDs with burrs stuck on them may not load properly or may skip whilst playing. Remove burrs using a ballpoint pen or a similar utensil.

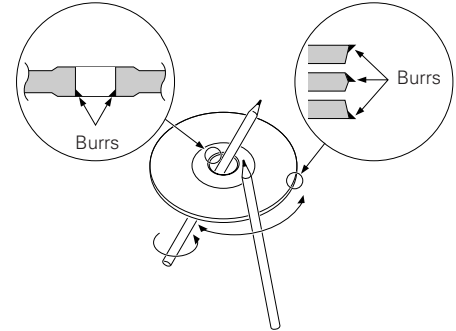

Do Not Load CD Accessories in Slot

Do not use commercially available CD accessories that can be loaded into the CD slot, such as stabilisers, protective sheets, or CD cleaning discs, since they can cause the unit to malfunction.

Removing the CD

Only remove the CD from the machine in a horizontal direction. You may damage the surface of the CD if you try pulling it down as it ejects.

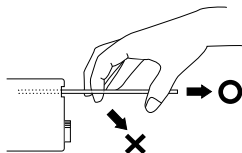

Do Not Use Special Shape CDs

- Be sure to use round shape CDs only for this unit and do not use any special shape CDs. Use of special shape CDs may cause the unit to malfunction.



- Be sure to use CDs with disc mark  only for this unit.
- CD-Rs and CD-RWs which have not undergone finalization processing cannot be played. (For more information on finalization processing, refer to the manual for your CD-R/CD-RW writing software or CD-R/CD-RW recorder.) Additionally, depending on the recording status, it may prove impossible to play certain CDs recorded on CD-R or CD-RW.

Do Not Use CDs with Sticker on the Labelled Side

Do not use the CD with the label sticker stuck on it.

Using such a CD may cause the CD to be deformed and the sticker to peel off, resulting in malfunction of the unit.

Notes on playing MP3 files

This unit can play MP3 files. Note, however, that the MP3 file recording media and formats acceptable are limited. When writing MP3 files, pay attention to the following restrictions.

Acceptable media

The MP3 file recording media acceptable to this unit are CD-ROM, CD-R, and CD-RW.

Acceptable medium formats

The medium formats acceptable to this unit are ISO 9660 Level 1 and Level 2 excluding the extended formats. When reading an MP3 file written in a format other than ISO 9660 Level 1 or Level 2, the unit may fail to play the file normally or display the file or folder name correctly.

The major specifications of ISO 9660 Level 1 and Level 2 are as follows:

- Maximum number of directory levels: 8
- Maximum number of files and folders per directory level:
253 (files and folders in total)
- Characters available to file and folder names:
A - Z, 0 - 9, _(underscore)
- Maximum number of characters in file names :
Level 1: 12 (including a separator "." and a 3-character extension)
Level 2: 31 (including a separator "." and a 3-character extension)

Settings for your MP3 encoder and CD writer

When you use your MP3 encoder to compress audio data to an MP3 file, set the transfer bit rate of the encoder to fixed 128 kbps.

When you use your CD writer to record MP3 files up to the maximum disc capacity, disable additional writing. For recording on an empty disk up to the maximum capacity at once, check Disc at Once.

Entering ID3 tag

Displayable ID3 tag is ID3 version 1 and 1.1; the character code is ASCII (see List of Codes). The ID3 tag versions 1 and 1.1 have the following size restrictions:

- Album name: 30 bytes or less
- Artist name: 30 bytes or less
- Song title: 30 bytes or less

	0	1	2	3	4	5	6	7	8	9	A	B	C	D	E	F
0				0	@	P		P			*	À	Ä	à	ä	
1	!	!	1	A	Q	a	q		i	±	Å	Ñ	á	ñ		
2	"	"	2	B	R	b	r		¢	•	Ä	Ö	ä	ö		
3	#	#	3	C	S	c	s		£	•	Ä	Ö	ä	ö		
4	\$	\$	4	D	T	d	t		¤	•	Ä	Ö	ä	ö		
5	%	%	5	E	U	e	u		¥	•	Ä	Ö	ä	ö		
6	&	&	6	F	V	f	v		¦	•	Ä	Ö	ä	ö		
7	'	'	7	G	W	g	w		§	•	Ä	Ö	ä	ö		
8	((8	H	X	h	x		¨	•	Ä	Ö	ä	ö		
9))	9	I	Y	i	y		©	•	Ä	Ö	ä	ö		
A	*	*	A	J	Z	j	z		•	•	Ä	Ö	ä	ö		
B	+	+	B	[{				«	»	Ä	Ö	ä	ö		
C	,	,	C	<					¬	¼	Ä	Ö	ä	ö		
D	-	-	D	=]]]		½	¾	Ä	Ö	ä	ö		
E	.	.	E	>	^	^	~		•	•	Ä	Ö	ä	ö		
F	/	/	F	?	_	_	_		□	◊	Ä	Ö	ä	ö		

Entering file and folder names

When entering file and folder names, use the alphanumeric characters described above only. If you use any other character for entry, the file and folder names are not displayed correctly. They may neither be displayed correctly depending on the CD writer used.

The unit recognizes and plays only those MP3 files which have the MP3 file name extension (.MP3). MP3 files should therefore be saved with the MP3 extension.

Writing files into a medium

When a medium containing MP3 data is loaded, the unit checks all the files on the medium. If the medium contains a lot of folders or non-MP3 files, therefore, it takes a long time until the unit starts playing MP3 files.

In addition, it may take time for the unit to move to the next MP3 file or a file search or folder search may not be performed smoothly. You should not write non-MP3 files or unneeded folders along with MP3 files on the medium.

CAUTION

When playing MP3 files on a medium which also contains non-MP3 files or folders, observe the following precautions. Loading such a medium may produce loud noise to break the speakers.

- Do not attempt to play a medium containing a non-MP3 file with the MP3 extension.
The unit mistakes non-MP3 files for MP3 files as long as they have the MP3 extension.
- Do not attempt to play a medium containing non MP3 file.

MP3 file playing order

When selected for play, folder search, file search, or for folder select, files and folders are accessed in the order in which they were written by the CD writer.

Because of this, the order in which they are to be recorded does not match the order in which they are played. You may be able to set the order in which MP3 files are to be played by writing them onto a medium such as a CD-R with their file names beginning with play sequence numbers such as "01" to "99", depending on your CD writer.

For example, a medium with the following folder/file hierarchy is subject to folder search, file search, or folder select as shown below.

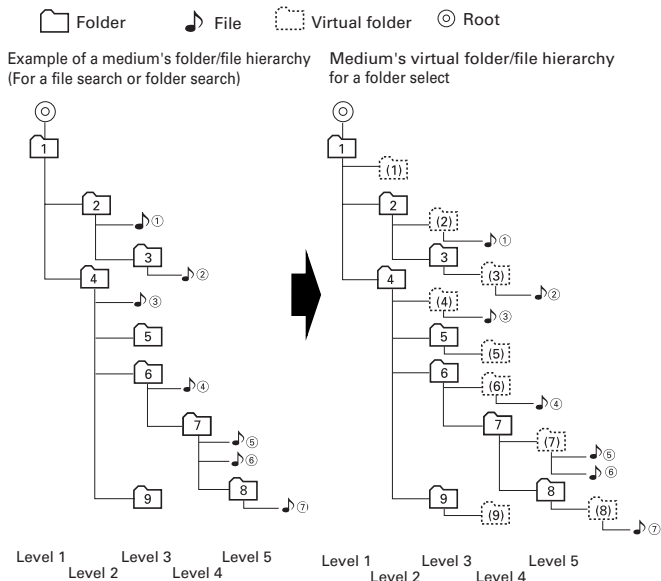

When a file search is executed with file ④ being played ...

Current track number	Operation of the button	
	◀◀ Button	▶▶ Button
④	Beginning of track ④ → ③ → ② → ① → ⑦ ...	⑤ → ⑥ → ⑦ → ① ...

When a folder search is executed with file ④ being played ...

When a folder search is executed with file ④ currently being played, the unit selects folders as shown below, starting with folder ⑥ .

Current album number	Operation of the button	
	FM Button	AM Button
⑥	⑦ → ⑧ → ⑨ → ① ...	⑤ → ④ → ③ → ② → ① → ⑨ ...

When folder select is selected with file ③ being played to move from folder to folder ...

During folder select, a virtual folder is created one hierarchical level below each folder. The hierarchy is displayed as if the MP3 file recorded in each folder were placed in that virtual folder.

When the unit enters the folder select mode with file ③ being played, it selects folders as shown below, starting with folder ④ (virtual folder ④) .

Current album number	Operation of the button			
	◀◀ Button	▶▶ Button	AM Button	FM Button
④	⑨ → ⑥ → ⑤ → ④ ...	⑤ → ⑥ → ⑨ ...	④ → ①	—

NOTE

- Each virtual folder is displayed with the original folder name bounded by parentheses " () ". For example, the virtual folder below the folder named " 4 " is displayed with a name of " (4) ". The folder name of each virtual folder is displayed with up to 30 characters (in the ISO 9660 Level 2 format) or 8 characters (in the ISO 9660 Level 1 format).
- The FM button is disabled in a folder because it has no subordinate hierarchical level below. Immediately after entering the folder select mode as in the above example, therefore, the FM button cannot be used as there is no hierarchical level below folder ④ . Once you have moved to folder ① using the folder select function, for example, you can use the FM button to select folder ① → ⑦ one level below.

General features

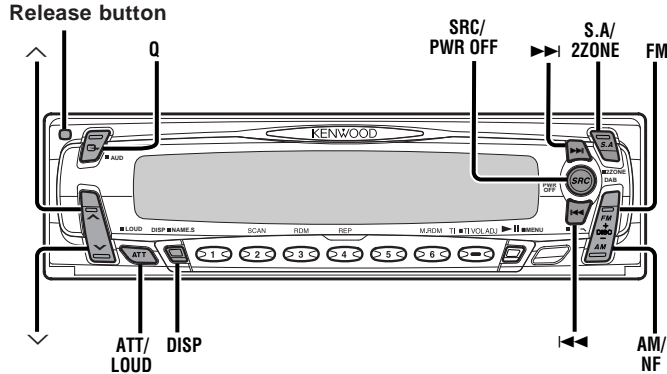

LOUD indicator

Description about this indicator for these features can be displayed by setting the Lower Part Display (page 14) to "... + Function indicator".

Power

Turning on the power:

Press the SRC button.

NOTE

Turn the power on before carrying out the following procedures.

Turning off the power:

Hold down the PWR OFF button for one second or more.

NOTE

The status of the Code Security Function (page 39) is displayed whenever the power is switched on.

"CODE ON" : Security Code has been registered

"CODE OFF" : Security Code has not been registered

Volume

Increasing Volume:

Press the ^ button to turn up the volume.

Decreasing Volume:

Press the v button to turn down the volume.

Attenuator

This function allows you to turn down the volume quickly.

Turning Attenuator On/Off:

Press the ATT button to switch the attenuator on and off. When the attenuator is off, the volume returns to the original level.

NOTE

Turning the volume up, or turning it all the way down deactivates the attenuator function.

Switching Modes

Switching Modes:

Each time you press the SRC button, the mode switches as follows:

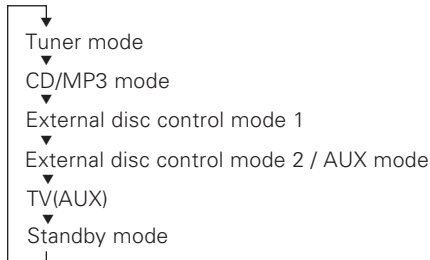

Selecting the standby mode:

Press the SRC button repeatedly to select to "ALL OFF". When "ALL OFF" is displayed, the standby mode is turned on. The standby mode turns all functions off although leaving the unit's power on. Use this mode when you want to have the display illuminated but do not want to listen to anything.

NOTE

- The mode switches to the next mode from any mode which cannot be used.
- The external disc control mode will differ depending on the unit that is connected.
- You cannot use the AUX input function of the optional switching adapter KCA-S210A if this unit is connected with the KCA-S210A.
- If you have selected Standby mode, the timer function that turns the power off automatically will be activated. To find out how to set the time on the timer, and how to cancel the timer function, refer to the section on the Power OFF Timer function under Menu settings (page 45). The Power OFF Timer function is enabled only after the security code (page 39) is set up.

NOTE

Selecting AUX-name display

Holding down the DISP button for two seconds or more during the AUX mode, AUX-name display is blinked for AUX-name selection mode.

Pressing ◀◀ or ▶▶ button during this mode allows you to select "TV", "VIDEO", "GAME", "PORTABLE", "DVD", or "AUX" in the AUX mode.

The AUX-name selection mode can be exited by pressing the DISP button or doing nothing for 10 seconds.

Loudness

This function amplifies low and high tones when the volume is turned down.

The LOUD indicator lights up, when the loudness function is on.

Turning Loudness On/Off:

Hold down the LOUD button for one second or more to switch the loudness on and off.

General features

Switching Display Mode

You can select the display mode of this unit.

Changing the Display Mode:

Each time you press the DISP button, the display mode switches as follows:

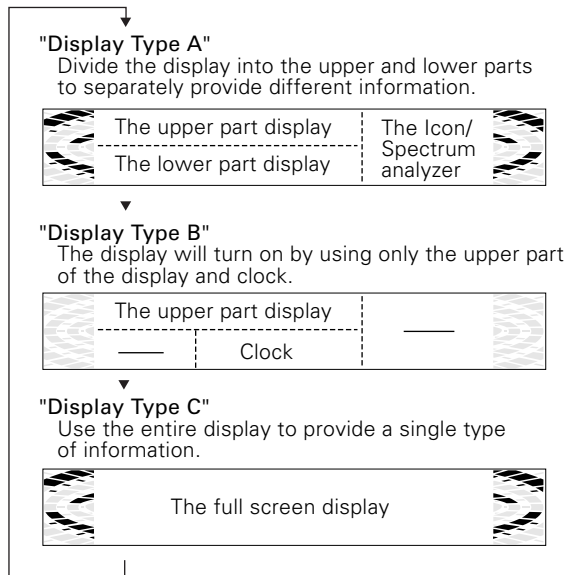

NOTE

- You can switch display information between the upper part display, lower part display, and full screen display. For further information, see "Switching the Upper Part Display" (page 12), "Switching the Lower Part Display" (page 14), "Switching Full-Screen Display" (page 15) respectively.

- You can switch the Icon/Spectrum analyzer. See "Icon/Spectrum analyzer Select" in the menu setting (page 41).
- You cannot switch into the "Display Type C" during the standby mode.

Switching the Upper Part Display

This function switches the type of information on the upper part display when the display mode is "Display Type A" or "Display Type B".

- Press the S.A button to enter the display control mode.
- Each time you press the ◀◀ or ▶▶ button, the upper part display changes as follows:

In Tuner mode:

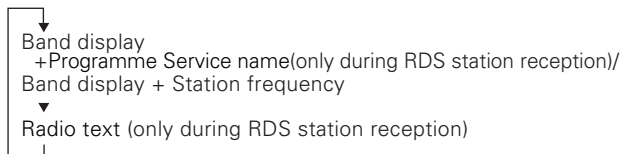

Displaying Frequencies:

Hold down the DISP button for one second or more. The frequency for the RDS station will be displayed for five seconds instead of the station name.

NOTE

If the RDS station currently tuned to is transmitting no text whilst the Radio Text Display mode is turned on, "NO TEXT" will appear in the display. Whilst awaiting reception, "Waiting" will be displayed.

WARNING

To prevent accidents, drivers should not look at the display whilst driving.

In CD/External disc control mode:

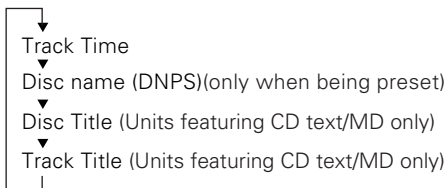

In MP3 mode:

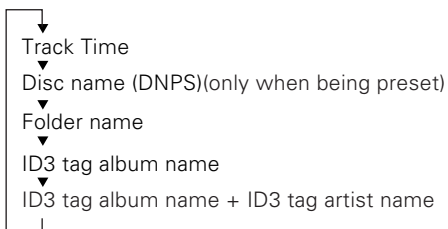

NOTE

- You can give names to discs through the presetting disc name function (page 32).
Note that depending on the unit, display may not be possible.
- If you try to display the name of a disc that does not have one, "NO NAME" is displayed instead.
- When there is an attempt to display the title of a disc for which the disc title/track title has not been recorded, "NO TEXT" is displayed for CD and "NO TITLE" is displayed for MD.
- Depending on the type of characters of the CD Text, some characters may not be displayable.
- If you don't turn the "Reading the MP3 ID tag" on, the ID3 tag will not be displayed.
See "Reading the MP3 ID3 tag" in the menu setting (page 44).

- In the AUX mode, the Upper Part Display comes up with the AUX-name only, providing no cycle-through displays.

3 Press the S.A button to end the display control mode.

NOTE

- For display mode selection, see "Switching display mode" (page 12).
- The same items cannot be selected for both the upper part and the lower part.

General features

Switching the Lower Part Display

This function switches the type of information on the lower part display when the display mode is "Display Type A".

- 1 Press the S.A button to enter the display control mode.
- 2 Each time you press the FM or AM button, the lower part display changes as follows:

In Tuner mode:

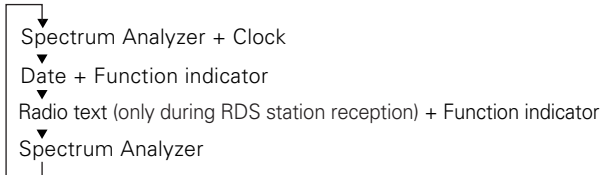

NOTE

If the RDS station currently tuned to is transmitting no text whilst the Radio Text Display mode is turned on, "NO TEXT" will appear in the display. Whilst awaiting reception, "Waiting" will be displayed.

WARNING

To prevent accidents, drivers should not look at the display whilst driving.

In CD/External disc control mode:

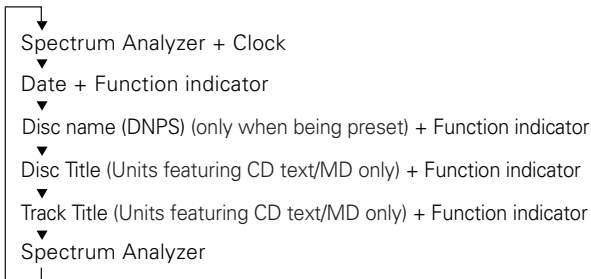

In MP3 mode:

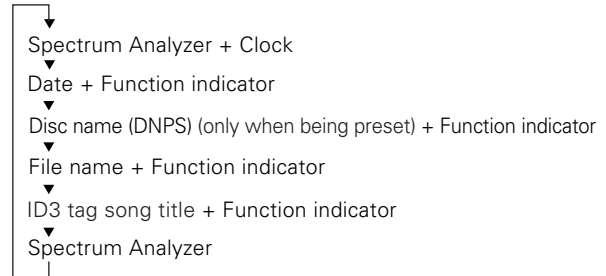

In AUX mode:

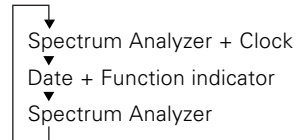

NOTE

- You can give names to discs through the presetting disc name function (page 32). Note that depending on the unit, display may not be possible.
- If you try to display the name of a disc that does not have one, "NO NAME" is displayed instead.
- When there is an attempt to display the title of a disc for which the disc title/track title has not been recorded, "NO TEXT" is displayed for CD and "NO TITLE" is displayed for MD.
- Depending on the type of characters of the CD Text, some characters may not be displayable.
- If you don't turn the "Reading the MP3 ID tag" on, the ID3 tag will not be displayed. See "Reading the MP3 ID3 tag" in the menu setting (page 44).

- 3 Press the S.A button to end the display control mode.

NOTE

- For display mode selection, see "Switching display mode" (page 12).
- If the display mode is set to "Display Type B", you can turn on or turn off the clock.
- The same items cannot be selected for both the upper part and the lower part.

Switching Full-Screen Display

This function switches the type of information on the display when the display mode is "Display Type C".

Each time you press the S.A button, the full screen display changes as follows:

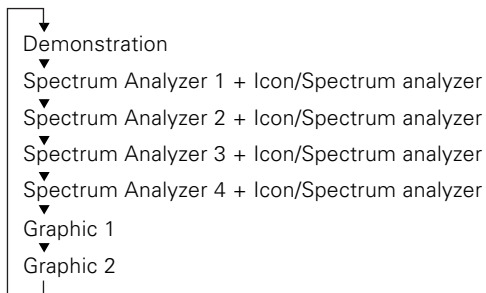
**NOTE**

- For display mode selection, see "Switching display mode" (page 12).
- You can switch the Icon/Spectrum analyzer. See "Icon/Spectrum analyzer Select" in the menu setting (page 41).

TEL Mute

Shut down the audio system temporarily whenever an incoming call is received.

NOTE

The function will not work if a cable is not connected to the car phone.

When the telephone rings:

When a call is received, "CALL" is displayed and all the unit functions are temporarily interrupted.

Restoring Original Unit Source During Phone Call:

Press the SRC button.

"CALL" disappears from the display, and the volume of the original source is restored gradually.

Turning TEL Mute Function Off After Phone Call:

Hang the phone up.

"CALL" disappears from the display.

The original source (i.e., the one used before the phone call) is returned to automatically, and the volume restored gradually.

General features

Switching Display during the Standby mode

This function switches the type of information on the display in standby mode.

- 1 Press the SRC button repeatedly to select the standby mode. "ALL OFF" is displayed when the standby mode is selected.
- 2 Each time you press the S.A button, the display changes as follows:

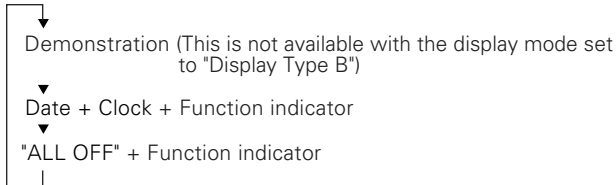

Theft Deterrent Faceplate

The faceplate of the unit can be detached and taken with you, helping to deter theft.

Removing the Faceplate:

- 1 Press the release button and drop open the faceplate.
- 2 Holding the centre part of the faceplate, pull it out.

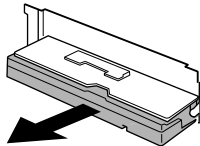

- 3 Push upward the back of the faceplate bracket until it locks.

⚠CAUTION

- Do not apply excessive force to the faceplate bracket without attaching the faceplate. Doing so will cause the faceplate bracket to be deformed.
- Do not touch the connector on the faceplate bracket after removing the faceplate. Touching the connector may cause damage to the unit.

NOTE

- The faceplate is a precision piece of equipment and can be damaged by shocks or jolts. For that reason, keep the faceplate in its special storage case whilst detached.
- Do not expose the faceplate or its storage case to direct sunlight or excessive heat or humidity. Also avoid places with too much dust or the possibility of water splashing.

Reattaching the Faceplate:

- 1 Hold the faceplate so that the control panel faces the front toward you and set the left side of the faceplate in the faceplate bracket.

⚠CAUTION

Do not set the right side of the faceplate in the faceplate bracket first, when reattaching the faceplate. Doing so may cause the connector on the faceplate bracket to malfunction.

- 2 Press the right side of the faceplate until it locks.

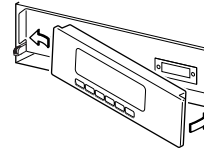

System Q

You can recall the best audio setting preset for different types of the music.

Switching the Preset Sound Setting:

Each time you press the Q button, the preset sound setting switches as follows:

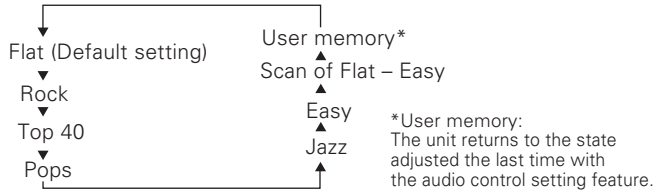

NOTE

The System Q function changes the values of the following sound quality parameters: Bass centre frequency, bass level, bass quality factor, bass extend, middle centre frequency, middle level, middle quality factor, treble centre frequency, treble level non-fading level, high-pass filter frequency for front output, high-pass filter frequency for rear output, and low-pass filter frequency for non-fading output. Their setting values are different depending on the setting of the speaker and woofer setting mode.

Speaker & Woofer setting

Speaker setting allows the System Q settings to be fine-tuned according to the type of speakers.

Woofer setting allows for Network configuration according to the type of subwoofers.

- 1 Press the SRC button repeatedly to select the standby mode. "ALL OFF" is displayed when the standby mode is selected.
- 2 Press the Q button to enter the speaker setting mode.
- 3 Each time you press the FM/AM button, the mode switches as follows:

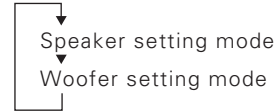

- 4 • In speaker setting mode
Press either the ◀◀ or ▶▶ button to select the type of speaker. The setting switches as follows.
Off ("Speaker Setting OFF") / For 6x9/6 in. speaker ("Speaker Setting 6*9/6 inch") /
For 5/4 in. speaker ("Speaker Setting 5/4 inch") /
For the OEM speaker ("Speaker Setting O.E.M.")
 - In woofer setting mode
Press either the ◀◀ or ▶▶ button to select the type of Sub woofer. The setting switches as follows.
"Woofer OFF" / "12in typeA" / "10in typeA" / "12in typeB" / "10in typeB" / "12in typeC" / "10in typeC" / "8inch" / "12in typeD" / "10in typeD"
- 5 Press the Q button to end the speaker setting mode and woofer setting mode.

NOTE

- Speaker setting allows for tuning of bass, middle and treble.
- Woofer setting allows for tuning of high-pass filter frequency, low-pass filter frequency and non-fading level.

Non-Fading Output

You can turn the non-fading output on and off whilst the preout is switched to the non-fading preout.

Turning non-fading output On/Off :

Hold down the NF button for one second or more to set the function ON or OFF.

"NF ON" is displayed when the non-fading output is set ON.

General features

Dual Zone System

The following operation allows separate sound sources to control the output of the front and rear speakers. The Dual zone system can only be switched on when the source is set to the TV(AUX) mode.

Dual Zone System On/Off:

Press the 2ZONE button for at least one second to switch the Dual Zone System on and off.

"Zone 2 ON" is displayed when Dual Zone System is turned on.

NOTE

- You can select the speaker output, either front or rear, for the AUX input and the unit's tuner or audio source. For details refer to "Switching Dual Zone System Output" (page 42) for the menu settings.
- The Bass, Middle, Treble and Loudness adjustments do not affect the TV(AUX) channel.
- When you set the Dual zone system to on whilst the non-fading preout is switched on, the sound of the non-fading preout does not be outputted.
- If the Attenuator function is turned on while the Dual Zone System is enabled, the Attenuator is not applied to the TV(AUX) source.
- The Dual Zone System function operates on the AUX source of this unit only.

Audio control features

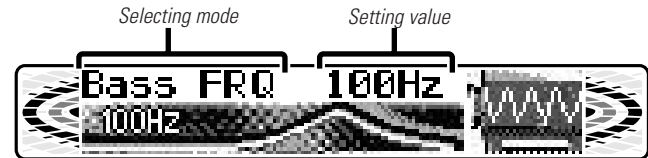
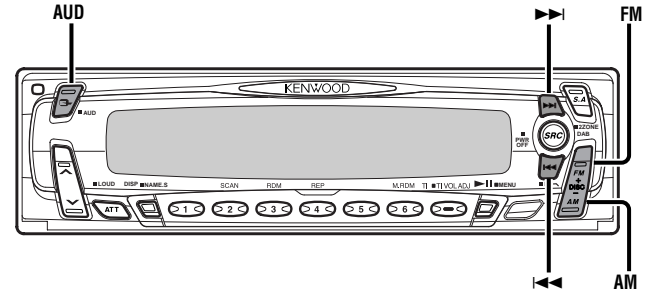

Audio Control Setting

Adjust various parameters of sound quality.

1 Hold down the AUD button for one second or more to enter the control mode.

2 **Selecting mode**

Press either the FM or AM button.

Each time the button is pressed, the adjustment mode will change.

Please refer to the following for the contents of the adjustment modes.

NOTE Source tone memory

Each source (CD, TV(AUX), FM, AM, and disc changer) has its own memory in which to store the bass, middle, treble and N-F level settings.

The settings made for a particular source are then recalled automatically whenever you use that source (e.g., FM mode uses the tone settings made for FM, AM for AM, etc.).

3 **Adjust each mode**

Press the **◀▶** button.

Please refer to the following for the adjusting values.

4 Press the AUD button to end the control mode.

NOTE

- Determining the parameters in the audio control setting will clear all the adjustments made in the System Q and they are replaced with the values made in the audio control setting.
- The following parameters can be set when the System Q function on the menu settings is ON.
Bass centre frequency, bass quality factor, bass extend, middle centre frequency, middle quality factor, and treble centre frequency.

Bass Centre Frequency

Adjust the centre frequency of the bass.

Display and setting:

"Bass FRQ" : 60 / 70 / 80 / 100 (Only when the bass quality factor is set to 1.00, 1.25 or 1.50) / 150 (Only when the bass quality factor is set to 2.00) Hz.

Bass Level

Adjust the bass level.

Display and setting:

"Bass" : - 8 - + 8

Bass Quality Factor

Adjust the Bass quality factor.

Display and setting:

"Bass Q" : 1.00 / 1.25 / 1.50 / 2.00

Bass Extend

Switch the Bass Extend mode on/off.

Display and setting:

"Bass EXT" : ON / OFF (When the bass extend mode is set to on, low frequency response is extended by 20%.)

Audio control features

Middle Centre Frequency

Adjust the centre frequency of the middle.

Display and setting:

"MID FRQ" : 0.5 / 1.0 / 1.5 / 2.0 kHz.

Middle Level

Adjust the middle level.

Display and setting:

"MID" : - 8 – + 8

Middle Quality Factor

Adjust the middle quality factor.

Display and setting:

"Middle Q" : 1.0 / 2.0

Treble Centre Frequency

Adjust the centre frequency of the treble.

Display and setting:

"TRE FRQ" : 10.0 / 12.5 / 15.0 / 17.5 kHz

Treble Level

Adjust the treble level.

Display and setting:

"TRE" : - 8 – + 8

Balance Level

Adjust the balance level.

Display and setting:

"Balance" : Left 15 – Right 15

Fader Level

Adjust the fader level.

Display and setting:

"Fader" : Rear 15 – Front 15

Non-Fading Level

Adjust the Non-fading output level.

Display and setting:

"NF Level" : - 15 – + 15

NOTE

- This mode is available only when the non-fading output function is set to on.
- Not available during the Dual zone system is on.

High-pass Filter Frequency for Front Output

Adjust the frequency of the High-pass filter for front output.

Display and setting:

"HPF Front" : Through / 40Hz / 60Hz / 80Hz / 100Hz / 120Hz /
150Hz / 180Hz / 220Hz

NOTE

You can separately set the high-pass filter for front and rear output, including preouts. The high-pass filter does not affect the non-fading preout.

High-pass Filter Frequency for Rear Output

Adjust the frequency of the High-pass filter for rear output.

Display and setting:

"HPF Rear" : Through / 40Hz / 60Hz / 80Hz / 100Hz / 120Hz /
150Hz / 180Hz / 220Hz

NOTE

You can separately set the high-pass filter for front and rear output, including preouts. The high-pass filter does not affect the non-fading preout.

Low-pass Filter Frequency for Non-Fading Output

Adjust the frequency of the Low-pass filter for Non-Fading output.

Display and setting:

"LPF NF" : 50 Hz / 80 Hz / 120 Hz / Through

NOTE

- This mode is available only when the non-fading output function is set to on.
- Not available during the Dual zone system is on.

Phase for Non-Fading Output

Adjust the phase for Non-Fading output.

Display and setting:

"NF Phase" : Normal (0°) / Reverse (180°)

NOTE

- This mode is available only when the non-fading output function is set to on.
- Not available during the Dual zone system is on.

Volume Offset

Set the sound level of the each source selected by adjusting the level difference between the basic sound level and the required level.

Display and setting:

"Volume Offset" : - 8 - ± 0

Tuner features

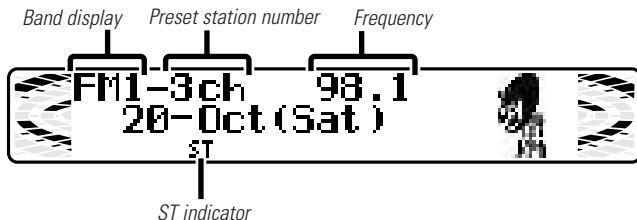
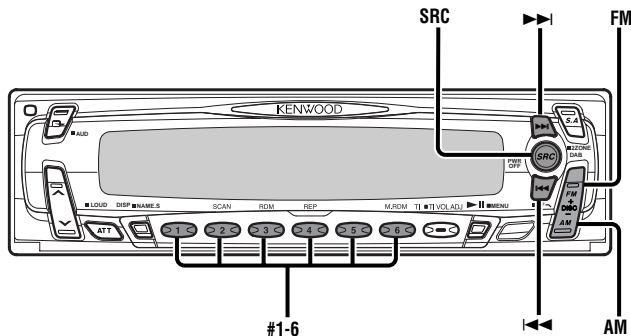

Description about this indicator for these features can be displayed by setting the Lower Part Display (page 14) to "... + Function indicator."

Tuning

- 1 Press the SRC button repeatedly until the tuner mode is obtained. "TUNER" is displayed only when the tuner mode is selected.
- 2 Press either the FM or AM button to select the band. Each time you press the FM button, the band switches between the FM1, FM2 and FM3. Press the AM button to select the MW and LW bands.
- 3
 - Auto Seek Tuning (Auto1)
Press the ►► button to seek increasing frequencies. Press the ◀◀ button to seek decreasing frequencies.
 - Preset station seek tuning (Auto2)
Press the ►► button to move to the next preset station (i.e., the one with the next highest number), and the ◀◀ button to move to the last preset station (i.e., the one with the next lowest number).

NOTE

If the frequencies stored at the preset numbers receive stations which were not originally memorized when travelling long distances, the preset number is not displayed. In such cases, pressing the ◀◀/►► button to use preset station seek will receive channel 1.

- Manual Tuning (Manual)
Press the ►► button to increase the frequency by one step. Press the ◀◀ button to decrease the frequency by one step.

NOTE

- The ST indicator lights up when stereo broadcasts are being received.
- Please see the menu settings about selecting tuning mode. (page 43)

Station Preset Memory

Store the frequency of the station currently being listened to. You can then recall that station with a single touch of a button.

- 1 Select the band/station that you want to have stored.
- 2 Hold down the button (#1-6) that you want to use for the station, for two seconds or more.
The button number blinks once in the display to indicate that the data has been stored.

Recalling a Preset Station:

Press the preset station button (#1-6) for the desired station. The number of the recalled station is displayed.

NOTE

You can store 6 stations in each of the FM1, FM2, FM3, and AM (MW and LW) bands.

Direct Access Tuning *(Function of remote control)*

When you know the frequency of the station that you want to listen to, you can input it directly for quick access.

- 1 Select the band by pressing the FM or AM button.
- 2 Press the DIRECT button.
"----" is displayed for 10 seconds.
If you make no input in the 10-second period, direct access tuning is automatically cancelled.
- 3 Enter the frequency of the desired station.
If you want to listen to an FM station at 92.1 MHz, for example, press 0, 9, 2, and 1.
If you want to listen to an AM station at 810 kHz, for example, press 0, 8, 1, and 0.

NOTE

- You cannot enter frequencies above or below what a band can receive.
- FM frequencies can only be input in 0.1 MHz steps, and not 0.01MHz steps.

Cancelling Direct Access Tuning:

Press the DIRECT button again.

Preset station seek with Programme service name *(Function of Remote Control)*

You can search for the preset station with Programme Service name.

- 1 Press the DNPP button on the remote control.
"SNPP" will be displayed once the seek mode is entered.
The names of the stations preset in the band currently listened to are displayed for 5 seconds each.
The display band switches in the following order:

→ FM1 ↔ FM2 ↔ FM3 ↔ AM ←

Each time you press the ►► button, the station display switches in the forward direction.

Each time you press the ◀◀ button, the station display switches in the reverse direction.

Stations which have no names will be displayed as frequencies.

NOTE Changing the Displayed Band

Pressing the FM button switches between the FM1, FM2, FM3 and AM displays, in that order.

Pressing the AM button switches between the displays in the reverse direction.

- 2 **Once the name is displayed for the station you want to listen to**

Press the OK button.

Reception starts of the displayed station, and the seek mode ends.

Cancelling mode during input:

Press the DNPP button.

The seek mode is cancelled.

RDS features

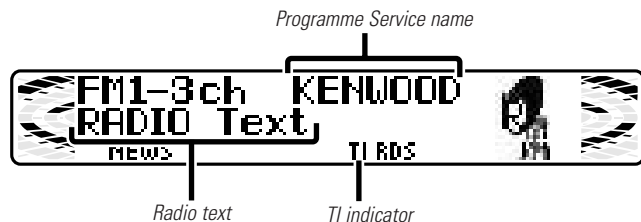
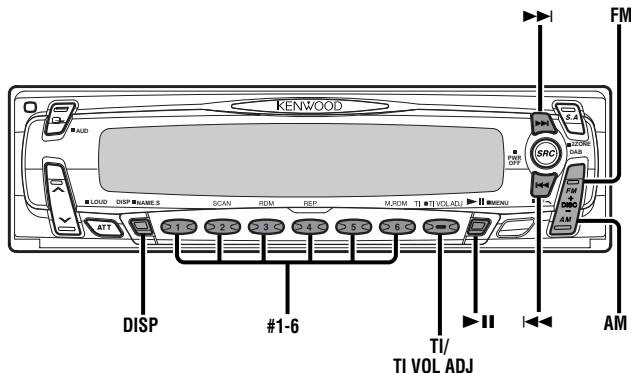

Description about this indicator for these features can be displayed by setting the Lower Part Display (page 14) to "... + Function indicator."

RDS (Radio Data System)

RDS is a digital information system that lets you receive signals besides those of regular radio programmes, such as network information being transmitted from radio stations. When listening to an RDS station (ie, a station with RDS capability), the programme service name of the station is displayed along with the frequency, advising you quickly which station is being received.

RDS (Radio Data System) stations also transmit frequency data for the same station. When you are making long trips, this function automatically switches to the particular frequency with the best reception for the particular network of stations that you want to listen to. The data is automatically stored, allowing you to switch quickly to another RDS stations, broadcasting the same programme, that has better reception. These include stations stored in the station preset memory that you often listen to.

Enhanced Other Network

Stations that offer <Enhanced Other Network> also transmit information about other RDS stations that have traffic information. When you are tuned to a station that is not transmitting traffic information, but another RDS station starts transmitting a traffic bulletin, the tuner automatically switches to the other station for the duration of the bulletin.

Alarm

When an emergency transmission (announcing disasters, etc.) is sent, all current functions are interrupted to allow the warning to be received.

Traffic Information Function

You can listen to traffic information. If you are listening to tapes or discs, they will continue playing until a traffic bulletin is broadcast.

Turning TI function On/Off:

Press the TI button to turn the function on and off.

When the function is on, the TI indicator is turned on.

When none is being received, the TI indicator will blink on and off. When a traffic information station is being received, the TI indicator will turn on.

When a traffic bulletin begins to be broadcast, "Traffic Info" will be displayed, and reception will begin at the preset volume.

If you are listening to a tape or disc when a traffic bulletin begins, they will automatically be turned off. When the bulletin ends or poor reception is experienced, the tape or disc will begin playing again.

NOTE

Pressing the TI button whilst in the MW/LW band automatically switches reception to the FM band. However, the MW/LW band is not returned to when the TI button is pressed again.

Switching to a Different Traffic Information Station:

Use the **I◀◀ / ▶▶I** buttons to make an auto seek of the TI stations in a certain band.

NOTE

- When you are listening to a tape or disc, you cannot change to another TI station.
- When the auto TP seek function is turned on and reception starts to weaken, the tuner automatically seeks traffic information stations with better reception.
- If you are tuned to a station that is not a traffic information station itself but which provides <Enhanced Other Network> services, you can still have traffic information received.
- Holding down the TI button for one second or more when the TI function is on in the disc mode results in a change to the programme service name or frequency display of the traffic information station for five seconds.

Presetting Volume for Traffic Information/News

Preset the volume level to be used for traffic information and news broadcasts.

- 1 Tune into the station for which you want to set the volume.
- 2 Adjust the volume to the desired level.
- 3 Hold down the TI VOL ADJ button for two seconds or more. The volume level blinks once in the display to indicate that the data has been stored. Future traffic information/news broadcasts are heard at the preset level.

NOTE

- The volume cannot be lowered by this function during tuner reception. The volume is only set when it is louder than the listening volume of the tuner.
- You can arrange only to listen to traffic information or news bulletins with at preset volume with the volume set at minimum.

RDS features

Programme Type (PTY) Function

Conduct auto seek tuning only on those stations with selected kinds of programmes.

1 Press the ►|| (PTY) button.

"PTY Select" is displayed, and the Programme Type Selection (PTY) Mode entered.

If you make no key input in 30 seconds, the mode will automatically turn off.

NOTE

You cannot use this function whilst the traffic bulletin is received.

2 Select the type of programme to be received

- Press either the FM or AM button repeatedly until the type of programme you want to listen to.

The selection includes:

<i>Speech</i>	(All <i>Speech</i>)
<i>Music</i>	(All <i>Music</i>)
1. News	(News)
2. Current Affairs	(Current Affairs)
3. Information	(Information)
4. Sports	(Sport)
5. Education	(Education)
6. Drama	(Drama)
7. Culture	(Cultures)
8. Science	(Science)
9. Varied	(Varied <i>Speech</i>)
10. Pop Music	(Pop Music)
11. Rock Music	(Rock Music)
12. Easy Listening Music	(Easy Listening M)
13. Light Classical	(Light Classic M)
14. Serious Classical	(Serious Classics)
15. Other Music	(Other Music)
16. Weather	(Weather & Metr)
17. Finance	(Finance)
18. Children's programmes	(Children's Prog)
19. Social Affairs	(Social Affairs)
20. Religion	(Religion)
21. Phone In	(Phone In)
22. Travel	(Travel & Touring)
23. Leisure	(Leisure & Hobby)

24. Jazz Music	(Jazz Music)
25. Country Music	(Country Music)
26. National Music	(National Music)
27. Oldies Music	(Oldies Music)
28. Folk Music	(Folk Music)
29. Documentary	(Documentary)
(Speech.....1~9,16~23, 29, Music.....10~15, 24~28)	

- You can select the type of programme directly by pressing a preset button. The buttons are factory-set to the following type of programmes:

1. <i>Music</i>	2. <i>Speech</i>	3. News
4. Other Music	5. Serious Classical	6. Varied

NOTE

Changing the Preset Button Settings for Programme Type
After selecting the type of programme to be stored in a certain preset button, hold down that button for two seconds or more. The previously stored data for that button are erased and the new programme type is stored.

3 Seeking the selected programme type

Press the ◀◀ or ▶▶ button to make a seek of frequencies with your selected type of programme. The display blinks and the seek starts.

If your selected type of programme is found, the name of the station is displayed and the station is tuned into.

"PTY Found" is displayed for about 30 seconds.

If you make no key input in 30 seconds, the PTY selection mode will turn off automatically.

NOTE

If no programme can be found, "NO PTY" is displayed. If you want to select another type of programme, repeat steps 2 and 3 above.

Switching to Other Stations with the Same Type of Programme:

When "PTY Found" is displayed, perform auto seek tuning. The tuner scans for another station with the same type of programme.

Cancelling Programme Type Function During Its Operation:

Press the ►|| (PTY) button.

Changing Language for Programme Type(PTY) Function

Changing the display language to another language.

- 1 Press the ►II(PTY) button.
"PTY Select" is displayed, and the Programme Type Selection (PTY) Mode entered.
- 2 **Enter the Changing Language Mode**
Press the DISP button to enter the changing language mode.
- 3 **Changing the Display Language**
Press the FM or AM button.
Each time the button is pressed, the display language will change as follows:

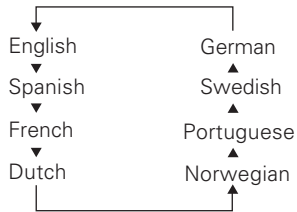

- 4 Press the DISP button to end the changing language mode.

in one scrolling display of the text.

To scroll automatically:

- 1 Display the radio text referring to the "Switching the Upper Part Display" (page 12) or "Switching the Lower Part Display" (page 14).
The text will be displayed in one scrolling display.
- 2 Holding down the DISP button for one second or more with radio text displayed on the upper part display scrolls the text once.

NOTE

- Please see the menu settings (page 45) about switching between manual scrolling and automatic scrolling.
- You can scroll text when "Display Type A" or "Display Type B" has been selected by the switching display mode function.
For display mode selection, see "Switching display mode" (page 12).

Radio Text Scroll

This function permits the text to be scrolled and the entire text to be displayed. The scrolling method differs depending on the setting of scrolling in the menu.

To scroll manually:

- 1 Display the radio text in upper part display, referring to "Switching the Upper Part Display" (page 12).
- 2 Holding down the DISP button for one second or more results

CD/External disc control features

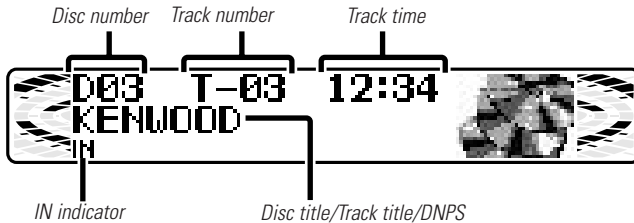
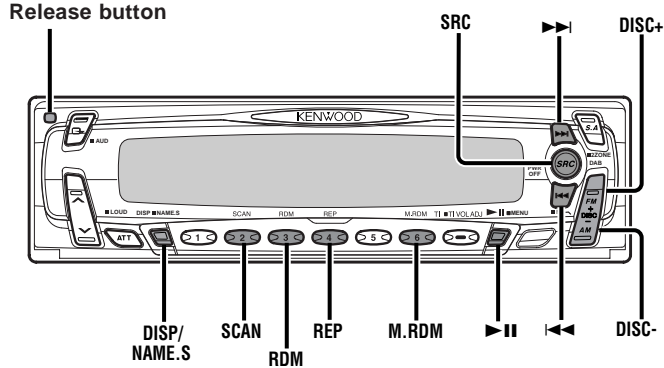

Description about this indicator for these features can be displayed by setting the Lower Part Display (page 14) to "... + Function indicator".

Playing CDs

Playing CDs:

A press of the release button causes the faceplate to drop to the front, thereby exposing the CD slot. Holding the CD with the labeled side facing up, insert it in the slot. The CD will start playing. Push back the faceplate with your hand until it locks. The IN indicator will light when a CD has been inserted.

▲CAUTION

When inserting a CD, make sure the CD has been completely drawn in before pushing back the faceplate. Failing to do so might scratch the CD.

Playing CDs Already Inserted:

Press the SRC button repeatedly until the CD mode is obtained. "CD" is displayed when the CD mode has been selected. The CD will start playing.

Pausing and Restarting CD Play:

Press the ►|| button to make the disc pause. Press the same button again to start play again.

Eject:

Press the release button and drop open the faceplate. Press the ▲ button located near the CD slot. The CD stops playing and ejects from the slot. Push back the faceplate with your hand until it locks.

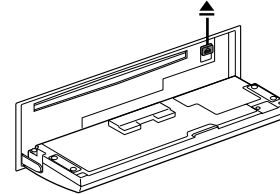

▲CAUTION

- Do not attempt to insert a CD into the slot if another one is already there.

- The unit can only play 12-cm (5-inch) CDs. If you insert an 8-cm (3-inch) CD, it will get stuck inside and can cause the unit to malfunction.
- When the faceplate has been dropped open, it might interfere with the gear lever or something else. If this happens, pay attention to safety and move the gear lever or take an appropriate action, then operate the unit.
- Do not apply excessive force to the open faceplate or place objects on it. Doing so will cause damage or breakdown.
- Do not use the unit with the faceplate in the open condition. Doing so will cause breakdown.

NOTE

When you load a CD and eject it right away, the next time you try to insert the CD may not load. In such a situation, take the CD out for a moment and then reinsert it.

Playing Other Disc mode

This function permits the connection of optional players and the playing of discs other than the loaded CD (in the current unit).

Playing Discs:

Press the SRC button repeatedly to select the external disc control mode.
The disc will start playing.

NOTE

The external disc control mode will differ, depending on the unit that is connected.

Mode Display Examples

- "CD2"...when a CD player is connected
- "CD-CH"/"MD-CH"/"DISC"...when a disc changer is connected
- "CD-CH1"/"MD-CH1"/"DISC1", "CD-CH2"/"MD-CH2"/"DISC2"...when two disc changers are connected

Pausing and Restarting Disc Play:

Press the ►|| button to make the disc pause.
Press the same button again to start play again.

NOTE

When one disc has finished playing its last track, the next disc in the changer starts playing. When the last disc in the changer has finished, the player returns to the first disc and starts playing it.

Fast Forwarding and Reversing Disc Play

Fast Forwarding Disc Play:

Hold down on the ►► button.
Release your finger to play the disc at that point.

Reversing Disc Play:

Hold down on the ◀◀ button.
Release your finger to play the disc at the point.

NOTE

You cannot use reverse play between tracks depending on the model being connected. Instead, the reverse play function is cancelled when it reaches the beginning of a track, at which point normal play automatically resumes.

CD/External disc control features

Track Search

Search forwards or backwards through the tracks on the disc until you reach the one that you want to listen to.

Making a Reverse Track Search:

Press the **◀◀** button to display the desired track number.

Press once to search back to the beginning of the current track, twice to search back to the beginning of the previous track, and so forth.

Play starts at the beginning of the displayed track number.

NOTE (For disc changers)

Pressing the **◀◀** button whilst listening to track 1 only searches back to the beginning of that track. The reverse search is not "recycled" to the last track on the disc.

Making a Forward Track Search:

Press the **▶▶** button to display the desired track number.

Press once to fast forward to the next track, twice to fast forward to the track after that, and so forth.

Play starts at the beginning of the displayed track number.

NOTE (For disc changers)

You cannot make a forward track search when listening to the last track on a disc.

Disc Search

(Function of disc changers)

Search forwards or backwards through the discs in a disc changer until you reach the one that you want to listen to.

Making a Reverse Disc Search:

Press the **DISC-** button to display the desired disc number. Each time the button is pressed, the displayed disc number decreases by one.

Play starts at the beginning of the displayed disc.

Making a Forward Disc Search:

Press the **DISC+** button to display the desired disc number.

Each time the button is pressed, the displayed disc number increases by one.

Play starts at the beginning of the displayed disc.

NOTE

"Load" is displayed when discs are being exchanged on the disc changer.

Track / Disc Repeat

Repeat playing the current track or disc.

Turning Repeat Play Function On/Off:

Press the **REP** button to switch the repeat play function on and off as follows :

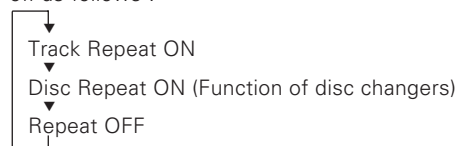

"Track Repeat ON"/"Repeat ON" is displayed and the track number blinks in the display when track repeat is on.

"Disc Repeat ON" is displayed and the disc number blinks in the display when disc repeat is on.

NOTE

Repeat play is cancelled when you eject the disc.

Track Scan

Successively play the beginning of each track on a disc until you find the track that you want to listen to.

Starting the Track Scan:

Press the SCAN button. "Scan ON" is displayed and the first 10 seconds of each track are played, and the tracks are played in order.

The track number currently being heard blinks in the display.

Stopping to Listen to the Track Being Scanned:

Press the ►|| or SCAN button again to stop the scan and keep on listening to a track normally.

NOTE

The track scan function is cancelled when you eject the disc.

Random Play

Play all the tracks on the current disc in random order.

- 1 Press the RDM button to switch the random play function on and off.

"Random ON" is displayed when random play is turned on.

The display of the track number changes continuously as the next track is being selected.

When the track has been selected, play starts.

The selected track number blinks in the display as it is being played.

NOTE (For disc changers)

When all the tracks on a certain disc have been played using the random play function, the next disc on the changer starts playing (with the random play function still turned on).

- 2 To change the track being heard, press the ►►| button. Another track is selected and played.

NOTE

Random play is cancelled when you eject the disc.

Magazine Random Play *(Function of disc changers)*

Play the tracks on all the discs in the disc changer in random order.

- 1 Press the M.RDM button to switch the magazine random play function on and off.

"M.Random ON" is displayed when magazine random play is turned on.

The display of the disc and track numbers change continuously as the next track is being selected.

When the disc/track has been selected, play starts.

The selected disc/track number blinks in the display as it is being played.

- 2 To change the track being heard, press the ►►| button. Another disc/track is selected and played.

NOTE

- Magazine random play is cancelled when you eject the disc.
- The time needed for random selection depends on the number of discs loaded in the disc magazine.

CD/External disc control features

Text Scroll

This function permits the text to be scrolled and the entire text to be displayed. The scrolling method differs depending on the setting of scrolling in the menu.

To scroll manually:

- 1 Display the disc or track title in the upper part display, referring to "Switching the Upper Part Display" (page 12).
- 2 Holding down the DISP button for one second or more results in one scrolling display of the titles.

To scroll automatically:

- 1 Display the disc or track title referring to the "Switching the Upper Part Display" (page 12) or "Switching the Lower Part Display" (page 14). The titles will be displayed in one scrolling display.
- 2 Holding down the DISP button for one second or more results in one scrolling display of the titles.

NOTE

- Please see the menu settings (page 45) about switching between manual scrolling and automatic scrolling.
- You can scroll text when "Display Type A" or "Display Type B" has been selected by the switching display mode function. For display mode selection, see "Switching display mode" (page 12).
- You cannot use the text scroll function during magazine random play.

Presetting Disc Names (DNPS)

Store the names of discs to be displayed when played.

- 1 Play the disc whose name you want to preset.

NOTE

- This function is not available for disc changers that do not feature the Disc Name Preset function.

- The Disc Name Preset function cannot be used during the Magazine random play as well as while a disc title or track title is displayed in the upper part display.
 - The Disc Name Preset function cannot be used while folder name or ID3 tag(Artist, Album) is displayed in the upper part display.
- 2 Press the NAME.S button for at least two seconds. "NAME SET" is displayed and the disc name preset mode is entered. The cursor blinks in the position where character input can be made.
 - 3 Press either the ◀◀ or ▶▶ button to move the cursor to the desired position. The ◀◀ button moves the cursor to the left, and the ▶▶ button to the right. You can also move the cursor left or right by pressing the ◀◀ or ▶▶ buttons, respectively, on the remote control.
 - 4 Each press of the ▶▶ button results in the type of characters that are to be entered changing between alphabet and numerals/symbols. Press the DISC+ or DISC- button to display the desired character. Characters that can be displayed are as follows.

Alphabet (upper case): A ~ Z

Alphabet (lower case): a ~ z

Numerals and symbols: 0~9 @ " ' ` % & * + - = , . / \ < > []

Special characters: á à é è ì í ó ò ú û ñ ç ß ï ð ñ ò ó ô õ ù ð ñ ç ß ï ð

NOTE

Direct Alphabet Input

(Function of remote control with number/letter entry buttons)

You can directly input letters using the number/letter entry buttons on the remote control.

Example: Use the following table to enter the name "DANCE".

Character	Button to press	# Times pressed
"D"	#3	1
"A"	#2	1
"N"	#6	2
"C"	#2	3
"E"	#3	2

- 5 Continue steps 3 and 4 until all the characters are chosen for the name.

NOTE

You can enter up to 12 characters for each name.

- 6 Press either the NAME.S button on the main unit or the OK button on the remote control.
The disc name is stored and the disc name preset mode is cancelled.
If you make no entry in a 10-second period, the name will be stored with the characters input so far.

NOTE

- You cannot store the names of the discs in the MDs.
- The number of discs whose names can be stored will differ depending on the disc changer that is connected. Please see your disc changer manual for details.
Up to 30 CDs can be registered with this unit.
- Discs are identified by their total length and number of tracks. If another disc happens to have the same specifications as one that you have already stored a name for, the name will be displayed for it, too.
- If you want to change the name of a disc, repeat steps 1 and 2 to display the name, and then repeat steps 3 and 4 to input the changes.
- Pressing the reset button erases the disc names stored in this unit, but does not erase the names stored in a disc changer.
- MP3 recorded media allows you to register a single media name only. Registration for each CD as it is available with the CD cannot be achieved.

Disc Name Preset Play (DNPP)

(Function of Remote Control)

If you have preset the name of a disc that you want to listen to in the disc changer, you can look for it by name and start playing it.

- 1 Press the DNPP button on the remote control.
"DNPP" will appear in the display, and the disc name preset play mode is entered.
The names of all the discs in the disc changer will appear successively in the display for five seconds each.
Discs whose names have not been preset will appear as "NO NAME" in the display.

NOTE

- This function can only be used in disc changers that were manufactured or sold as of 1997. Also note that some units cannot provide a display unless the disc name preset has been made by the unit that is playing.
- Discs in the disc changer that have never been played before will appear as "NO ACCESS" when the disc names are displayed. When you cannot identify a disc because of the "NO ACCESS" display after inserting a disc magazine, try playing it to display the disc name.
Also note that "NO DISC" will be displayed when a disc has not been loaded.

Rapid display (forward / reverse):

Press the DISC+ or DISC- button.
Pressing the DISC+ button will rapidly display the preset names/disc titles in order.
Pressing the DISC- button will rapidly display the preset names/disc titles in reverse order.

2 When the name appears for the disc you want to play

Press the OK button.
The disc whose name is displayed will be recalled, and the disc name preset play (DNPP) mode will end.

To cancell DNPP mode:

Press the DNPP button.
The disc name preset play (DNPP) mode will be cancelled.

MP3 player features

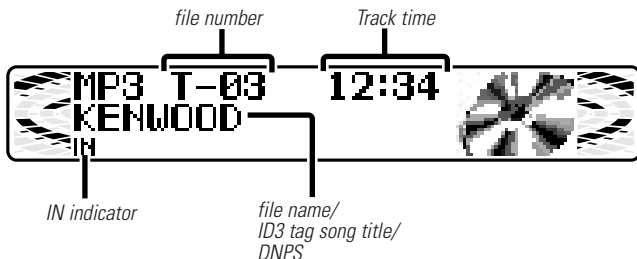
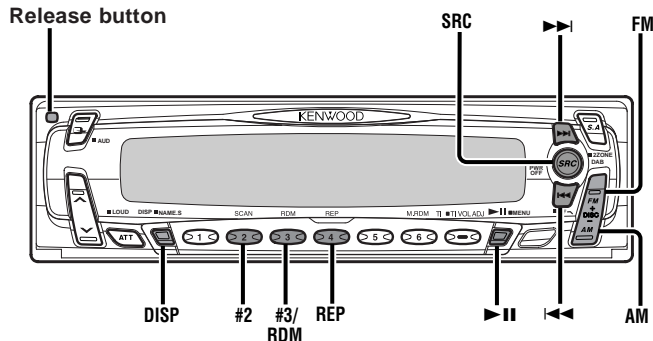

Description about this indicator for these features can be displayed by setting the Lower Part Display (page 14) to "... + Function indicator".

Playing MP3 Files

Play:

A press of the release button causes the faceplate to drop to the front, thereby exposing the CD slot. Holding the media with the labeled side facing up, insert it in the slot. The media will start playing. Push back the faceplate with your hand until it locks. The IN indicator will light when a media has been inserted.

⚠ CAUTION

When inserting a media, make sure the media has been completely drawn in before pushing back the faceplate. Failing to do so might scratch the media.

Playing Media Already Inserted:

Press the SRC button repeatedly to select the CD mode. "CD" is displayed when the CD mode has been selected. The media will start playing.

Pausing and Restarting Media Play:

Press the ►|| button to make the media pause. Press the same button again to start play again.

Eject:

Press the release button and drop open the faceplate. Press the ▲ button located near the CD slot. The media stops playing and ejects from the slot. Push back the faceplate with your hand until it locks.

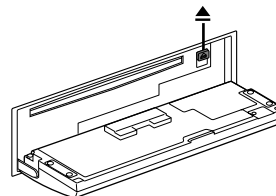

⚠ CAUTION

- Do not attempt to insert a media into the slot if another one is already there.

- When the faceplate has been dropped open, it might interfere with the gear lever or something else. If this happens, pay attention to safety and move the gear lever or take an appropriate action, then operate the unit.
- Do not apply excessive force to the open faceplate or place objects on it. Doing so will cause damage or breakdown.
- Do not use the unit with the faceplate in the open condition. Doing so will cause breakdown.

NOTE

- When you load a media and eject it right away, the next time you try to insert the media may not load. In such a situation, take the media out for a moment and then reinsert it.
- The MP3 media that this unit can play are CD-ROM, CD-R, and CD-RW.
The medium formats must be ISO 9660 Level 1 or Level 2. The methods and precautions to be followed for writing MP3 files are covered in "Notes on playing MP3 files" (page 8). Check that section before creating your MP3 media.
- It takes time for the unit to check each medium to see if it contains any MP3 file before it starts playing the medium.

File Search

Search forward or backward through the files on the media until you reach the one that you want to listen to.

Making a Backward File Search:

Press the **I◀◀** button to display the desired file number.
Press once to search back to the beginning of the current file, twice to search back to the beginning of the previous file, and so forth.
Play starts at the beginning of the displayed file number.

Making a Forward File Search:

Press the **▶▶I** button to display the desired file number.
Press once to fast forward to the next file, twice to fast forward to the file after that, and so forth.
Play starts at the beginning of the displayed file number.

NOTE

It may take time for the file search depending on the number of files and the state of the folder hierarchy.

Folder Search

Search forward or backward through the folders on the media.

Making a Backward Folder Search:

Press the **AM** button.

Pressing the button moves back to the previous folder. The unit plays the medium starts at the beginning of the selected folder.

If the selected folder contains no MP3 file, the unit automatically plays the file nearest to that folder in the MP3 file playing order.

Making a Forward Folder Search:

Press the **FM** button.

Pressing the button moves to the next folder. The unit plays the medium starts at the beginning of the selected folder.

If the selected folder contains no MP3 file, the unit automatically plays the file nearest to that folder in the MP3 file playing order.

NOTE

It may take time for the folder search depending on the number of files and the state of the folder hierarchy.

MP3 player features

Fast Forwarding and Reversing MP3 Play

Fast Forwarding MP3 Play:

- Hold down on the ►► button.
- Release your finger to play the MP3 at that point.

Reversing MP3 Play:

- Hold down on the ◀◀ button.
- Release your finger to play the MP3 at the point.

NOTE

- If you reach the beginning of the file with the fast reverse, the player enters the pause state. If you release the button, the music begins to play.
- During the fast forwarding and reversing process, audible tone and time code display are disabled.
- Time code may be different between the states before and after the fast forwarding and reversing operations.
- The time code for the first few seconds on pressing the button may be unchanged.
- The time code variation may be large if a file is encoded in variable bit rate (VBR).

Folder Select

You can use this function to select the folder containing the sound file you want be played.

1 Enter the Folder Select Mode

- Pressing the #2 button enters the folder select mode.
- The display reads as shown below.

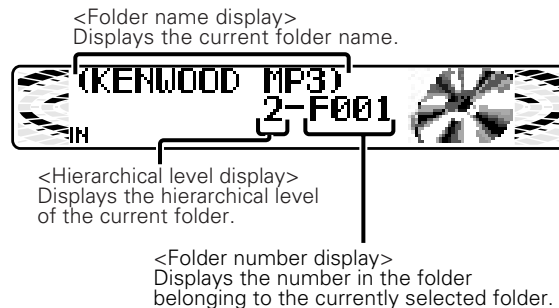

NOTE

The unit cannot enter the folder select mode if the loaded medium contains no folder recorded.

2 Selecting the desired folder

- You can move from folder to folder at the same hierarchical level:
Press the ►► button to move to the next folder at the same hierarchical level.
Press the ◀◀ button to move to the previous folder at the same hierarchical level.
- You can select the hierarchical level of the folder:
Press the FM button to move down one level in the folder hierarchy.
Press the AM button to move up one level in the folder hierarchy.
- You can return to the first hierarchical level (Root Jump):
Press the #3 button to return to the folder at the top hierarchical level on the medium currently being played.

NOTE

The methods for moving to other folders in the folder select mode are different from those in the folder search mode. See "Notes on playing MP3 files" (page 8) for details.

3 **When you have found a desired folder**

Press either the #2 or ►|| button.

This ends the folder select mode and starts playing the first MP3 file in the selected folder.

NOTE

- If the folder selected after leaving the folder select mode contains no MP3 file, the unit plays the MP3 file nearest to that folder in the MP3 file playing order.
- During the folder select mode, no audible sound is produced.

File / Folder Repeat

Repeat playing the file or the folder currently being listened to.

Turning Repeat Play On/Off:

Press the REP button to switch repeat file/folder play on and off as follows:

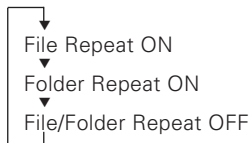

"File Repeat ON" is displayed when file repeat is on.

"Folder Repeat ON" is displayed when folder repeat is on.

NOTE

Repeat play is cancelled when you eject the media.

Random Play

Play all the files on the current folder in random order.

- 1 Press the RDM button to switch random play on and off.
"Random ON" is displayed when random play is turned on.
When the file has been selected, play will begin.

- 2 To change the file being heard, press the ►► button.
Another file will be selected and played.

NOTE

Random play is cancelled when you eject the media.

Name Scroll for MP3

This function permits the folder/file name and ID3 tag (Song title, Artist, Album) to be scrolled and the entire name to be displayed. The scrolling method differs depending on the setting of scrolling in the menu.

To scroll manually:

- 1 Display the folder name or ID3 tag (artist name, album name) in the upper part display, referring to "Switching the Upper Part Display" (page 12).
- 2 Pressing the DISP button for at least one second results in one scrolling display of the names.

To scroll automatically:

- 1 Display the folder/file name or ID3 tag (song title, artist name, album name), referring to "Switching the Upper Part Display" (page 12) or "Switching the Lower Part Display" (page 14).
The display of the name will be scrolled repeatedly.
- 2 Pressing the DISP button for at least one second results in one scrolling display of the names.

NOTE

- Please see the menu settings (page 45) about switching between manual scrolling and automatic scrolling.
- You can scroll the names when "Display Type A" or "Display Type B" has been selected by the switching display mode function.
For display mode selection, see "Switching display mode" (page 12).

Menu settings

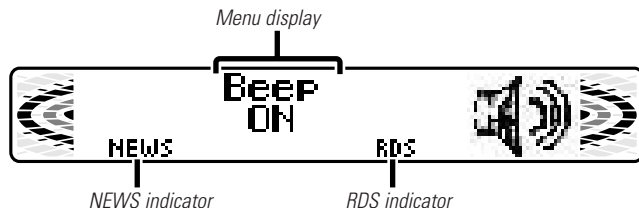
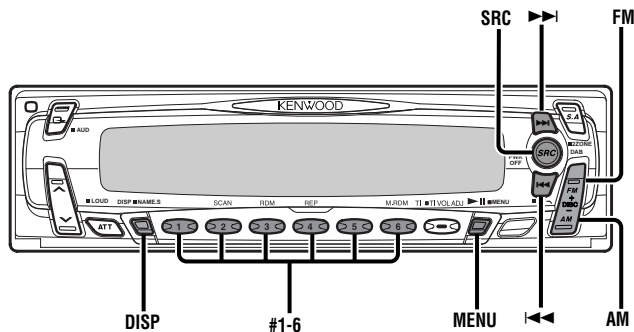

Menu System

You can set the defaults for additional functions in the menu mode. Make a setting for each function, referring to the following operations.

1 Enter the menu mode

Hold down the MENU button for one second or more. "MENU" is displayed when the menu mode is entered. The function that you can adjust is indicated with the current settings displayed.

2 Selecting function to set

Press the FM button to search through the functions until you see the one you want to adjust in the display. Press the AM button to search through the functions backward. Function items change in the order of features that follow in the menu system.

Example: If you want to switch the setting of the touch sensor tone function from on to off, first search through the functions until you see "Beep ON" in the display.

3 Changing setting for currently displayed function

Press either the ◀◀ or ▶▶ button.

The setting will change for each function.

Example: The setting of the touch sensor tone will switch from on to off, and "Beep OFF" is displayed.

4 Ending the menu mode

Press the MENU button.

NOTE

Make sure to end the menu mode when finished. If you fail to end the menu mode, several functions may not operate properly, including the Traffic Information function, the News Bulletin function with PTY news timeout setting, and the Alarm function.

Code Security Function <In Standby mode>

After a security code has been registered, power cannot be restored if the battery is disconnected from the unit unless the code is first input.

NOTE

All the steps in this procedure (1 through 7) must be completed before the code security function can be turned on. However, once the procedure is finished, it need not be repeated. Once the code security function has been activated, "Security" disappears from the MENU system. Note that it will no longer be possible to cancel this function afterwards.

- 1 Press the SRC button repeatedly to select the standby mode. "ALL OFF" is displayed when the standby mode is selected.
- 2 Hold down the MENU button for one second or more. "MENU" is displayed first and then "Security" is displayed.
- 3 Hold down either the ◀◀ or ▶▶ button for one second or more. "ENTER" will appear in the display for one second, indicating the code setting mode has been entered. When "CODE" appears in the display, you can start inputting the code.
- 4 Press the preset button and enter your security code. Use the security code shown on your Car Audio Passport. Example: Enter "3510" as your code, pressing the buttons as follows:

Step	Button to press	# Times pressed	Display
1	#1	4	"3"
2	#2	6	"5"
3	#3	2	"1"
4	#4	1	"0"

- 5 Hold down the DISP button for three seconds or more. The security code will be set.

"RE-ENTER" will appear in the display for one second, asking you to enter the code once again for confirmation. When "CODE" appears in the display, you can start inputting the code.

- 6 Press the Preset button and input the security code again.
- 7 Hold down the DISP button again for three seconds or more. "APPROVED" will appear in the display, with the code security function turning on. From this point on, if the unit is disconnected from the battery, the security code must be entered the first time that the unit's power is turned on. "ENTER" and "CODE" will appear in the display, asking you to input the code.

NOTE

If you input an incorrect security code, the code setting mode will be cancelled automatically. Follow the steps from 3 to 7 above again.

If you press the RESET button or remove the battery:

The first time you turn the unit on again, "CODE" will appear in the display, asking you to input the security code. Repeat steps 6 and 7 above, and input the security code. You can start operating the unit again when "APPROVED" appears in the display.

NOTE

If you enter the wrong code, "Waiting" is displayed and you cannot make further input of the code for a fixed interval (see table below), which grows longer each time you enter the wrong code.

When "CODE" is displayed, you can make input again.

Number of wrong inputs	Interval until next input is allowed
1	-
2	5 minutes
3	1 hour
4	24 hours

The number of wrong inputs is displayed.

Menu settings

Touch Sensor Tone

This function produces a beep sound that accompanies button operation. It can be switched on or off.

Display and setting:

"Beep ON" : Beep setting is on. (Default setting)

"Beep OFF" : Beep setting is off.

NOTE

The beep sound is not output from the preout jacks.

Manual Time Adjustment

Adjust the time manually.

NOTE

This adjustment is available only when the automatic time adjustment is set to off. (page 41)

Display and setting:

- 1 Select the display "Clock Adjust" during the selecting function in the menu system.
- 2 Hold down either the ◀◀ or ▶▶ button for one second or more to enter the Manual time adjustment mode.
The time display will blink.
- 3
 - Adjusting the hours
Press the FM button to advance the hours, or press the AM button to make the hours go back.
 - Adjusting the minutes
Press the ▶▶ button to advance the minutes, or press the ◀◀ button to make the minutes go back.
- 4 Press the MENU button to end the Manual Time Adjustment mode.
Exiting the Manual Time Adjustment mode would start the clock counting.

Calendar Adjustment

Adjust the date for the unit so that you can use the calendar function.

Display and setting:

- 1 Select the display "Date Adjust" during the selecting function in the menu system.
- 2 Hold down either the ◀◀ or ▶▶ button for one second or more to enter the Calendar adjustment mode.
The date display will blink.
- 3 **Selecting the item (day, month, or year) to adjust**
Press the ◀◀ or ▶▶ button.
The item blinking in the display can be adjusted.
- 4 **Adjusting the date**
Press the FM or AM button.
The item of the date blinking in the display will change.
- 5 Press the MENU button to end the Calendar Adjustment mode.

Calendar Mode

You can set the date formats of the calendar function.

Display and setting:

- 1 Select the display "Date Mode" during the selecting function in the menu system.
- 2 Press the ◀◀ and ▶▶ button to select the date format you want to show in the display.
The sample of the date format for today is displayed.

Automatic Time Adjustment

With automatic time adjustment, you can set the clock time automatically according to time data sent from RDS stations (after receiving RDS signals for several minutes). You can also set the time manually if the automatic time adjustment function is turned off.

Display and setting:

"SYNC ON" : Automatic time adjustment (Default setting)

"SYNC OFF" : Manual time adjustment

Adjusting Time Automatically:

Tune into an RDS station for 3 or 4 minutes.

The time adjusts automatically to the correct local time.

NOTE

The time is not adjusted when the RDS station you are tuned to is not transmitting a time signal. Choose another RDS station in such a case.

Disabled System Indicator (DSI)

A red indicator blinks on the unit after the faceplate is removed, warning potential thieves.

Display and setting:

"DSI ON" : The disabled system indicator is on. (Default setting)

"DSI OFF" : The disabled system indicator is off.

Icon/Spectrum analyzer Select

This function permits switching of the spectrum analyzer display.

Display and setting:

- 1 Select the display "Icon/Speana Select" during the selecting function in the menu system.
- 2 Pressing the ◀◀ or ▶▶ button switches the Icon/Spectrum analyzer.

Font Select

You can change the font used on the display.

Display and setting:

- 1 Select the display "Font Select" during the selecting function in the menu system.
- 2 Pressing the ◀◀ or ▶▶ button switches the font on the display.

Dimmer

You can dim the display.

NOTE

The dimmer function is not available for units if the dimmer cable is not connected.

Display and setting:

"Dimmer ON" : The dimmer setting is on. (Default setting)

"Dimmer OFF" : The dimmer setting is off.

Menu settings

System Q

When this system is set to on, the System Q factors (Bass centre frequency, Bass quality factor, Bass extend, Middle centre frequency, Middle quality factor, and Treble centre frequency) appear during the audio control mode.

Display and setting:

"System Q ON" : The System Q factors appear and can be adjusted. (Default setting)

"System Q OFF" : The System Q factors do not appear.

Switching preout

Switch the preout between the rear and non-fading. When you switch to non-fading, you can adjust the volume separately.

Display and setting:

"SWPRE Rear" : Rear preout (Default setting)

"SWPRE N-Fad" : Non-fading preout

NOTE

You cannot use the high-pass filter with non-fading preout.

Built-in Amp Mute Control <In Standby mode>

Toggles on or off the mute control on the built-in amplifier. Turning on this control enhances the preout quality.

Display and setting:

"Builtin AMP Mute ON" : Built-in Amp Mute is ON.

"Builtin AMP Mute OFF" : Built-in Amp Mute is OFF. (Default setting)

Switching Dual Zone System Output

You can select the speaker output, either front or rear, for the TV(AUX) source.

Display and setting:

"Zone 2 Rear" : Output from the rear speaker (Default setting)

"Zone 2 Front" : Output from the front speaker

NOTE

Not available during the Dual zone system is on.

External Amp Control

Adjust the bass boost level of the external amplifier using the main unit.

Display and setting:

"AMP Bass Flat" : Bass boost level is flat. (Default setting)

"AMP Bass +6" : Bass boost level is low (+6dB).

"AMP Bass +12" : Bass boost level is high (+12dB).

NOTE

As of December 2000, the power amplifiers controllable by the main unit are as follows:

KAC-X501F/PS501F/X401M/PS401M/X301T/PS301T/X201T/PS201T

News Bulletin Function with PTY News Timeout Setting

You can arrange to have news bulletins interrupt your current listening source, including other radio stations. When the News Bulletin function is on, the PTY News Timeout setting allows you to set the interval during which further news interruption cannot take place. You can adjust the PTY news interruption period from 10 to 90 minutes for each journey.

Display and setting:

"News OFF" (Default setting), "News 00min" – "News 90min"
(min= minutes)

: When you select the news interruption timeout interval, the News function turns on and the NEWS indicator lights up. When a news bulletin is received, "NEWS" will be displayed and reception will begin at the preset volume.

NOTE

- If you choose the "20min" setting, further news bulletins will not be received for 20 minutes once the first news bulletin is received.
- This function is only available if the desired station sends PTY-code for news bulletin or belongs to <Enhanced Other Network>-Network sending PTY-code for news bulletin.
- If you turn on the news bulletin function in the MW/LW band, the band is switched automatically to the FM band. However, the MW/LW band is not returned to when you turn off the function.

Local Seek Function <In Tuner mode>

With the local seek function turned on, auto seek tuning skips stations with relatively poor reception.

Display and setting:

"Local.S ON" : The local seek function is on.

"Local.S OFF" : The local seek function is off. (Default setting)

Selecting Tuning Mode <In Tuner mode>

You can choose from three tuning modes: auto seek, preset station seek, and manual.

Display and setting:

"Seek Mode Auto1" : Auto seek tuning mode (Default setting)

"Seek Mode Auto2" : Preset station seek tuning mode

"Seek Mode Manual" : Manual tuning mode

Auto Memory Entry <In Tuner mode>

You can automatically store all the receivable frequencies in the band currently being listened to, and then recall them with the touch of a button later. This function is especially useful when you are travelling and do not know what stations are available. Up to 6 frequencies can be stored this way.

Display and setting:

- 1 Select the display "Auto-Memory" during the selecting function in the menu system.
- 2 Hold down either the ◀◀ or ▶▶ button for two seconds or more to start auto memory function.
The numbers of the preset station buttons showed in order. When all the stations in a certain band are stored in the preset memory, the auto memory entry stops. The tuner then plays the last station received.

NOTE

- When the AF function is turned on whilst auto memory entry takes place, only RDS stations (i.e., stations with RDS capability) are stored. RDS stations that have been preset for FM1 cannot also be preset in FM2 or FM3.
- When the local seek function is turned whilst auto memory entry takes place, stations with poor reception are not stored.
- When the Traffic Information function is on, only the local traffic information station frequency will be stored.

Cancelling Auto Memory Entry During Its Operation:

Press the ◀◀ / ▶▶ button whilst auto memory entry is taking place to stop the process.

Recalling a Preset Station:

Press the preset station button (#1-6) for the desired station. The number of the recalled station is displayed.

Menu settings

AF (Alternative Frequency) Function

When poor reception is experienced, automatically switch to another frequency broadcasting the same programme in the same RDS network with better reception. The RDS indicator lights up when the AF function is turned on.

Display and setting:

"AF ON" : The AF function is on. (Default setting)
 "AF OFF" : The AF function is off.

NOTE

When no other stations with stronger reception are available for the same programme in the RDS network, you may hear the incoming broadcast in bits and snatches. Turn off the AF function in such a case.

Restricting RDS Region (Region Restrict Function)

You can choose whether or not to restrict the RDS channels, received with the AF function for a particular network, to a specific region. When the Region Restrict Function is on, the region is restricted.

Display and setting:

"Regional ON" : The Region Restrict Function is on. (Default setting)
 "Regional OFF" : The Region Restrict Function is off.

NOTE

Sometimes stations in the same network broadcast different programmes or use different programme service names.

Auto TP Seek Function

When the TI function is on and poor reception conditions are experienced when listening to a traffic information station, another traffic information station with better reception will be searched for automatically. This function is on, when unit is first powered on.

Display and setting:

"ATPS ON" : The Auto TP Seek Function is on.
 If the traffic information station you are tuned to experiences poor reception, this function automatically seeks another TP station. (Default setting)
 "ATPS OFF" : The Auto TP Seek Function is off.

Monaural Reception <In FM reception of Tuner mode>

When poor stereo reception is experienced, this function will reduce noise and improve listening conditions.

Display and setting:

"MONO ON" : The monaural reception is on.
 "MONO OFF" : The monaural reception is off. (Default setting)

Reading the MP3 ID3 tag <in MP3 mode>

ID3 tag information in the MP3 file is configured for use.

Display and setting:

"ID Read ON" : ID3 tag is read. (Default setting)
 "ID Read OFF" : ID3 tag is not read.

NOTE

- If you switch this setting during the play of MP3, the track is replayed from the beginning.

- If you turn the ID3 tag read ON, beginning of the play is delayed for reading process of each tag for the tune.

Text Scroll

This function permits the CD text, MD title, folder/file name and ID3 tag(Song title, Artist, Album) to be scrolled and the entire text to be displayed. Switching between manual scrolling and automatic scrolling is permitted.

Display and setting:

"Scroll Auto" : Automatic scrolling

"Scroll Manual" : Manual scrolling (Default setting)

Built-in AUX Control

The "Built-in AUX Control" determines whether you include the TV(AUX) factor in the cycle-through items in the "Switching Modes" (page 11) function.

Display and setting:

"Builtin AUX ON" : The TV(AUX) factor appears. (Default setting)

"Builtin AUX OFF" : The TV(AUX) factor does not appear.

NOTE

Not available during the Dual zone system is on.

Power OFF Timer

Set the time for the OFF Timer function activated when you selected Standby mode.

If the predefined time elapses, this unit's power is automatically turned off.

Display and setting:

"OFF - - - -" : Power OFF Timer function is cancelled.

"OFF 20min" : Unit's power goes OFF after 20 minutes.
(Default setting)

"OFF 40min" : Unit's power goes OFF after 40 minutes.

"OFF 60min" : Unit's power goes OFF after 60 minutes.

NOTE

The Power OFF Timer function is enabled only after the security code (page 39) is set up.

Basic Operations of remote control

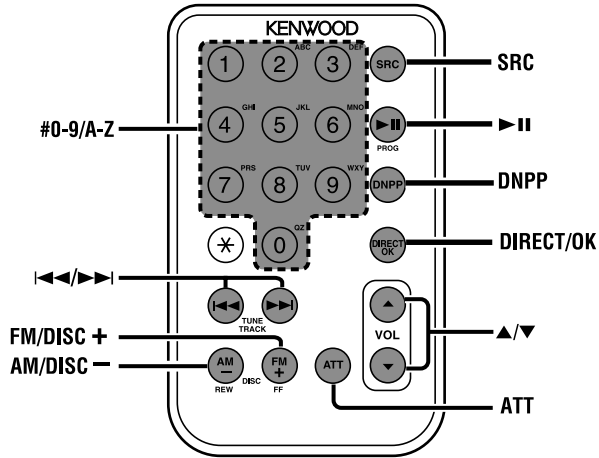

⚠ CAUTION

Do not set the remote control on hot places such as above the dashboard.

Loading and Replacing the Batteries:

Use one lithium battery (CR2025).

Remove the case following the instructions as illustrated.

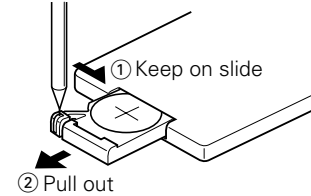

Insert the batteries with the + and - poles aligned properly, following the illustration inside the case.

⚠ WARNING

Store unused batteries out of the reach of children. Contact a doctor immediately if the battery is accidentally swallowed.

Basic operations

- **VOL buttons**
Press the ▲ button to turn the volume up.
Press the ▼ button to turn the volume down.
- **SRC button**
Each time you press the SRC button, the mode switches as follows:

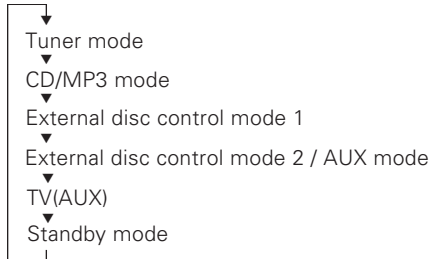

NOTE

- The mode switches to the next mode from any mode which cannot be used.
- The external disc control mode will differ depending on the unit that is connected.
- You cannot use the AUX input function of the optional switching adapter KCA-S210A if this unit is connected with the KCA-S210A.
- If you have selected Standby mode, the timer function that turns the power off automatically will be activated. To find out how to set the time on the timer, and how to cancel the timer function, refer to the section on the Power OFF Timer function under Menu settings (page 45). The Power OFF Timer function is enabled only after the security code (page 39) is set up.
- **ATT button**
Turns down the volume quickly. To return the volume to its original level, press the button again. Turning the volume up, or turning it all the way down deactivates the attenuator function.

Tuner features

- **◀◀/▶▶ buttons**
Press the ◀◀ button to make decreasing seeks (using the preset tuning mode).
Press the ▶▶ button to make increasing seeks (using the preset tuning mode).
- **AM/FM buttons**
Press the AM button to select the MW and LW bands.
Press the FM button to select and switch between FM1, FM2, and FM3 bands.
- **DIRECT/OK button**
During Preset station seek with programme service name mode, selects station.
Enters and cancels the Direct access tuning mode.
- **DNPP button**
Enters and cancels the Preset station seek with programme service name mode.
- **▶|| button**
Enters and cancels the Programme Type Selection (PTY) mode.
- **Number/letter entry buttons**
Press buttons #1-6 to recall preset stations.
Use to enter frequency of the desired station during Direct access tuning mode.





Basic Operations of remote control

CD/MP3/External disc control features

- **◀◀/▶▶ buttons**
 Press the ◀◀ button to search through the tracks and files backward.
 Press the ▶▶ button to search through the tracks and files forward.
 Used to move the cursor whilst entering disc name.
- **DISC buttons**
(for disc changers and media containing MP3 files)
 Press the DISC- button to search through the discs and folders backward.
 Press the DISC+ button to search through the discs and folders forward.
 Selects numbers and symbols whilst entering disc name.
- **▶|| button**
 When a disc is playing, this button pauses the play.
 Press the same button again to start play again.
 Selects the type of characters at the time of entering the disc name.
- **OK button**
 During disc name input, stores the already input data in memory and ends the input mode.
 Selects disc during the disc name preset play mode.
- **DNPP button (for disc changers)**
 Enters and cancels the Disc Name Preset Play mode.
- **Number / letter entry buttons**
 Used to specify the track (disc) number used in direct track (disc) searches.
 Use to enter letters during disc name preset.

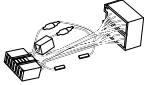
Accessories

External view

	 Number of items
①	 1
②	 2
③	 1
④	 1

▲CAUTION

The use of any accessories except for those provided might result in damage to the unit. Make sure only to use the accessories shipped with the unit, as shown above.

Installation Procedure

1. To prevent short circuits, remove the key from the ignition and disconnect the ⊖ terminal of the battery.
2. Make the proper input and output cable connections for each unit.
3. Connect the cable on the wiring harness.
4. Take Connector B on the wiring harness and connect it to the speaker connector in your vehicle.
5. Take Connector A on the wiring harness and connect it to the external power connector on your vehicle.

6. Connect the wiring harness connector to the unit.
7. Install the unit in your car.
8. Reconnect the ⊖ terminal of the battery.
9. Press the reset button.

▲CAUTION

- If your car is not prepared for this special connection-system, consult your KENWOOD dealer.
- Only use antenna conversion adapters (ISO-JASO) when the antenna cord has an ISO plug.
- Make sure that all cable connections are securely made by inserting jacks until they lock completely.
- If your vehicle's ignition does not have an ACC position, or if the ignition cable is connected to a power source with constant voltage such as a battery cable, the power will not be linked with the ignition (i.e., it will not turn on and off along with the ignition). If you want to link the unit's power with the ignition, connect the ignition cable to a power source that can be turned on and off with the ignition key.
- If the fuse blows, first make sure that the cables have not caused a short circuit, then replace the old fuse with one with the same rating.
- Do not let unconnected cables or terminals touch metal on the car or anything else conducting electricity. To prevent short circuits, also do not remove the caps on the ends of the unconnected cables or the terminals.
- Connect the speaker cables correctly to the terminals to which they correspond. The unit may receive damage or fail to work if you share the ⊖ cables and/or ground them to any metal part in the car.
- After the unit is installed, check whether the brake lamps, indicators, wipers, etc. on the car are working properly.
- Insulate unconnected cables with vinyl tape or other similar material.
- Some disc changers need conversion cables for connection. See the section on "Safety Precautions" for details.
- If the console has a lid, make sure to install the unit so that the faceplate does not hit the lid when closing and opening.
- Mount the unit so that the mounting angle is 30° or less.

Connecting Cables to Terminals

English

Connector Function Guide		
Pin Numbers for ISO Connectors	Cable Colour	Functions
External Power Connector		
A-4	Yellow	Battery
A-5	Blue/White	Power Control
A-6	Orange/White	Dimmer
A-7	Red	Ignition (ACC)
A-8	Black	Earth (Ground) Connection
Speaker Connector		
B-1	Purple	Rear Right (+)
B-2	Purple/Black	Rear Right (-)
B-3	Gray	Front Right (+)
B-4	Gray/Black	Front Right (-)
B-5	White	Front Left (+)
B-6	White/Black	Front Left (-)
B-7	Green	Rear Left (+)
B-8	Green/Black	Rear Left (-)

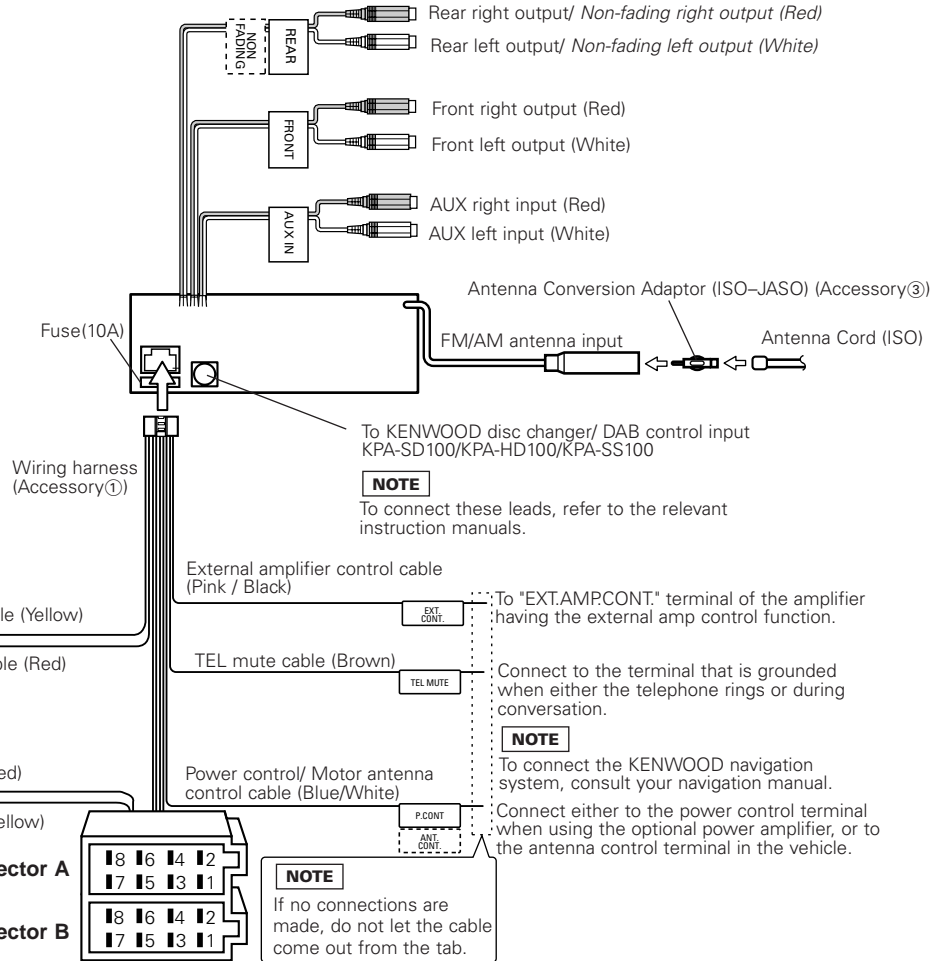

Installation

■ Installation

⚠ WARNING Connecting the ISO Connector (see p.50)

The pin arrangement for the ISO connectors depends on the type of vehicle you drive. Make sure to make the proper connections to prevent damage to the unit.

The default connection for the wiring harness is described in **1** below. If the ISO connector pins are set as described in **2** or **3**, make the connection as illustrated.

- 1** (Default setting) The A-7 pin (red) of the vehicle's ISO connector is linked with the ignition, and the A-4 pin (yellow) is connected to the constant power supply.

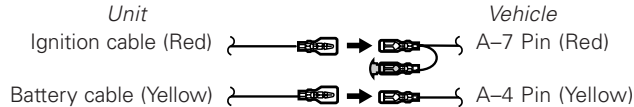

- 2** The A-7 pin (red) of the vehicle's ISO connector is connected to the constant power supply, and the A-4 pin (yellow) is linked to the ignition.

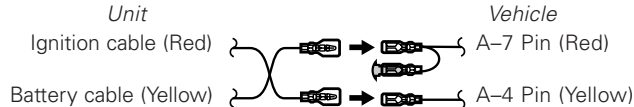

- 3** The A-7 pin (red) of the vehicle's ISO connector is not connected to anything, whilst the A-4 pin (yellow) is connected to the constant power supply (or both the A-7 (red) and A-4 (yellow) pins are connected to the constant power supply).

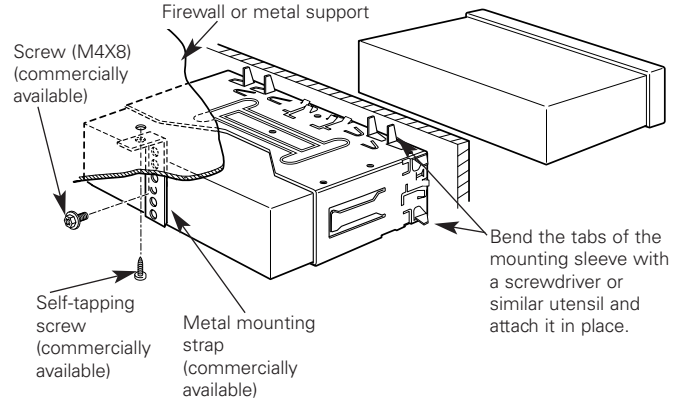
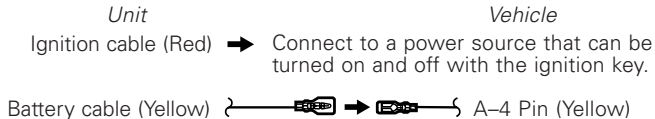

NOTE

Make sure that the unit is installed securely in place. If the unit is unstable, it may malfunction (eg, the sound may skip).

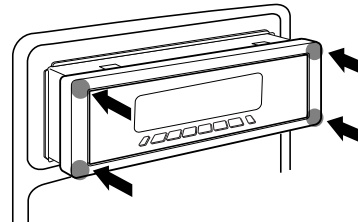

CAUTION

To attach this unit, make sure the front of the control panel faces you and fit it into the mounting sleeve by pressing the four corners of the hard rubber frame at the same time.

Do not apply strong pressure to other sections than the corners; otherwise troubles such as the impossibility of opening or closing the panel may result.

Installation

■ Removing the hard rubber frame

- 1 Engage the catch pins on the removal tool and remove the two locks on the lower level.
Lower the frame and pull it forward as shown in the figure.

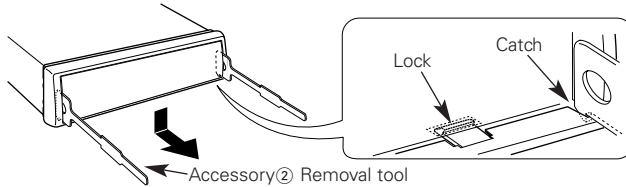

- 2 When the lower level is removed, remove the upper two locations.

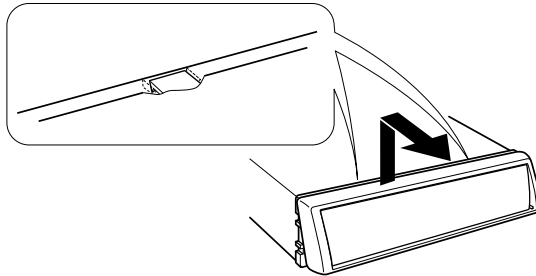

NOTE

The frame can be removed from the top side in the same manner.

■ Removing the Unit

- 1 Refer to the section "Removing the hard rubber frame" and then remove the hard rubber frame.
- 2 Remove the screw (M4x8) on the back panel.
- 3 Insert the two removal tools deeply into the slots on each side, as shown.

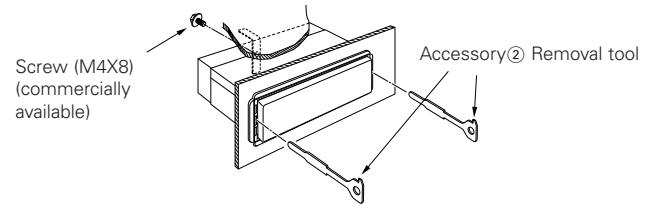

- 4 Lower the removal tool toward the bottom, and pull out the unit halfway whilst pressing towards the inside.

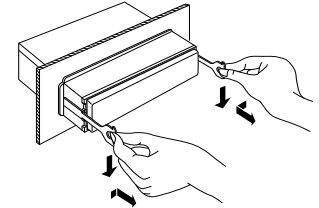

CAUTION

Be careful to avoid injury from the catch pins on the removal tool.

- 5 Pull the unit all the way out with your hands, being careful not to drop it.

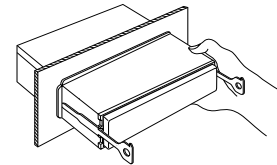

■ *Screwing the Faceplate on the Unit*

If you want to fasten the faceplate to the main unit so that it does not fall off, screw in the provided screw (M2 × 3 mm) in the hole shown below.

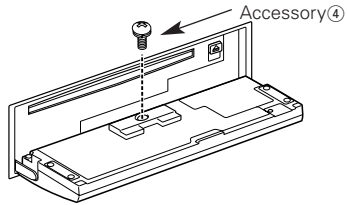

▲ CAUTION

Never insert the provided screw (M2 × 3 mm) in any other screw hole than the one specified. If you screw it in another hole, it will contact and may cause damage to the mechanical parts inside the unit.

Troubleshooting Guide

What might appear to be a malfunction in your unit may just be the result of slight misoperation or miswiring. Before calling service, first check the following table for possible problems.

PROBLEM	POSSIBLE CAUSE	SOLUTION
The power does not turn on.	The fuse has blown.	After checking for short circuits in the cables, replace the fuse with one having the same rating.
	No ACC position on vehicle ignition.	Connect the same cable to the ignition as the battery cable.
If you have selected Standby mode, the power will go OFF automatically.	The Power Off Timer function has been activated.	If you do not want the power to go OFF automatically, cancel the Power Off Timer function.
Nothing happens when the buttons are pressed.	The computer chip in the unit is not functioning normally.	Press the reset button on the unit (see page 4).
Radio reception is poor.	The car antenna is not extended.	Pull out the antenna all the way.
	The antenna control cable is not connected.	Connect the cable correctly, referring to the section on "Connecting Cables to Terminals".
The memory is erased when the ignition is turned off.	The battery cable has not been connected to the proper terminal.	Connect the cable correctly, referring to the section on "Connecting Cables to Terminals".
	The ignition and battery cable are incorrectly connected.	Connect the cable correctly, referring to the section on "Connecting Cables to Terminals".
The TEL mute function does not work.	The TEL mute cable is not connected properly.	Connect the cable correctly, referring to the section on "Connecting Cables to Terminals".
The TEL mute function turns on even though the TEL mute cable is not connected.	The TEL mute cable is touching a metal part of the car.	Pull the TEL mute cable away from the metal part of the car.
Free switching of the sound quality.	The system Q function is set on Scan mode.	Refer to the "System Q" page and switch it to a function other than Scan mode. (see p. 16).
Audio control setting cannot be achieved.	The system Q function is set on Scan mode.	Refer to the "System Q" page and switch it to a function other than Scan mode.(see p. 16).
TV (AUX) cannot be selected.	"Built-in AUX Control" is turned off.	Refer to the "Built-in AUX Control" in the menu setting (page 45) and turn on the "Built-in AUX Control" .

PROBLEM	POSSIBLE CAUSE	SOLUTION
No sound can be heard, or the volume is low.	The Attenuator function is turned on.	Turn off the Attenuator function.
	The fader and/or balance settings are set all the way to one side.	Reset the fader and/or balance settings.
	The input/output cables or wiring harness are connected incorrectly.	Reconnect the input/output cables and/or the wiring harness correctly. See the section on "Connecting Cables to Terminals".
	"Built-in Amp Mute Control" is turned on.	Refer to the "Built-in Amp Mute Control" in the menu setting (page 42) and turn off the "Built-in Amp Mute Control" .
The sound quality is poor or distorted.	A speaker cable may be pinched by a screw in the car.	Check the speaker wiring.
	The speakers are not wired correctly.	Reconnect the speaker cables so that each output terminal is connected to a different speaker.
A CD ejects as soon as it is loaded.	The CD is upside-down.	Load the CD with the labelled side up.
	The CD is quite dirty.	Clean the CD, referring to the section on "Cleaning CDs" (see page 6).
The sound skips on a CD.	The CD is scratched or dirty.	Clean the CD, referring to the section on "Cleaning CDs" (see page 6).
The specified track does not play.	Random play has been selected.	Turn off the random play function.
Can't remove disc.	The cause is that more than 10 minutes has elapsed since the vehicle ACC switch was turned OFF.	The disc can only be removed within 10 minutes of the ACC switch being turned OFF. If more than 10 minutes has elapsed, turn the ACC switch ON again and press the Eject button.

Troubleshooting Guide

CD/MP3/External disc control mode

PROBLEM	POSSIBLE CAUSE	SOLUTION
The disc control mode cannot be selected.	No cable has been connected to the disc changer input terminal on the unit.	Connect the cable to the disc changer input terminal on the unit.
The specified disc does not play, but another one plays instead.	The specified CD is very dirty.	Clean the CD.
	The CD is upside-down.	Load the CD with the labelled side up.
	The disc is loaded in a different slot from that specified.	Eject the disc magazine and check the number for the specified disc.
	The disc is severely scratched.	Try another disc instead.
The sound skips.	Something is touching the disc changer.	Remove whatever is touching it.
	The CD is scratched or dirty.	If skipping happens at the same place when the car is stopped, something is wrong with the CD. Clean the CD.
The display shows that the changer is being played, but no sound can be heard.	The computer chip in the unit is not functioning normally.	Press the reset button on the unit (see page 4).
The specified track does not play.	Random play or magazine random play has been selected.	Turn off the random play or magazine random play function.
Track repeat, disc repeat, track scan, random play, and magazine random play start by themselves.	The setting is not cancelled.	The settings for these functions remain on until the setting to off or the disc ejected, even if the power is turned off or the source changed.
Cannot play CD-R or CD-RW.	Finalization processing is not being conducted for CD-R/CD-RW.	Conduct finalization processing with CD recorder.
	A non-compatible CD changer is being used to play the CD-R/CD-RW.	Use a CD changer compatible with CD-R/CD-RW to play.

If the following situations, consult your nearest service centre:

- Even though the disc changer is connected, the Disc Changer Mode is not on, with "AUX" showing in the display during the Changer Mode.
- Even though no device (CA-C1AX, KDC-CPS87, KDC-CX87, KDC-CPS85, KDC-CX85, KDC-CPS82 or KDC-CX82) is connected, the AUX Mode is entered when switching modes.

PROBLEM	POSSIBLE CAUSE	SOLUTION
Cannot play an MP3 file.	Not conforming to ISO 9660 Level 1/2.	Use a medium conforming to ISO 9660 Level 1/2.
	The MP3 file has no or invalid file name extension.	Add the ".MP3" extension to the MP3 file name.
	The media is scratched or dirty.	Clean the media, referring to the section on "Cleaning CDs" (see p.6).
Noise or no sound generated when an MP3 file is played.	The file has the MP3 file name extension while it is not an MP3 file.	Do not use the ".MP3" extension in non-MP3 files.
Takes time before the unit starts playing MP3 files.	The medium contains many folders, files, and hierarchical levels.	The unit checks all files on the loaded medium first. If the medium has many files recorded, it may take a long time for the unit before it starts playing MP3 files.
Fails to play MP3 files in the intended order.	The MP3 files were not written by the CD writer in the order in which you wanted them to be played.	Depending on the CD writer, you may be able to set the order in which MP3 files are to be played by writing them onto a medium with their file names beginning with play sequence numbers such as "01" to "99".
The sound skips when an MP3 file is being played.	The media is scratched or dirty.	Clean the media, referring to the section on "Cleaning CDs" (see p.6).

The following messages are displayed when certain problems are occurring in your system. Take the recommended actions.

Eject	No disc magazine has been loaded in the changer. The disc magazine is not completely loaded. ⇒ Load the disc magazine properly. No CD in the unit. ⇒ Insert the CD.
No Disc	No disc has been loaded in the disc magazine. ⇒ Load a disc into the disc magazine.
TOC Error	No disc has been loaded in the disc magazine. ⇒ Load a disc into the disc magazine. The CD is very dirty. The CD is upside-down. The CD is scratched a lot. ⇒ Clean the CD and load it correctly.
Blank Disc	Nothing has been recorded on the MD.
No Tr Disc	No tracks are recorded on the MD, although it has a title.
NO PANEL	The faceplate of the slave unit being connected to this unit has been removed. ⇒ Replace it.
E-77	The unit is malfunctioning for some reason. ⇒ Press the reset button on the unit. If the "E- 77", code does not disappear, consult your nearest service centre.
Mecha Error	Something is wrong with the disc magazine. Or the unit is malfunctioning for some reason. ⇒ Check the disc magazine. And then, press the reset button on the unit. If the "Mecha Error" code does not disappear, consult your nearest service center.
Hold Error	The protective circuit in the unit activates when the temperature inside the automatic disc changer exceeds 60°C (140°F), stopping all operation. ⇒ Cool down the unit by opening the windows or turning on the air conditioner. As the temperature falls below 60°C (140°F), the disc starts playing again.
IN	If this indicator blinks, the CD player is malfunctioning. ⇒ Eject the CD and try insetting it again. If the CD cannot be ejected, press the eject button and hold it in until the CD is ejected.

Specifications

Specifications subject to change without notice.

FM tuner section

Frequency range (50 kHz space)	87.5 MHz – 108.0 MHz
Usable sensitivity (S/N = 26dB)	0.7 μ V/75 Ω
Quieting Sensitivity (S/N = 46dB)	1.6 μ V/75 Ω
Frequency response (\pm 3.0 dB)	30 Hz – 15 kHz
Signal to Noise ratio (MONO)	65 dB
Selectivity (DIN) (\pm 400 kHz)	\geq 80 dB
Stereo separation (1 kHz)	35 dB

MW tuner section

Frequency range (9 kHz space)	531 kHz – 1611 kHz
Usable sensitivity (S/N = 20dB)	25 μ V

LW tuner section

Frequency range	153 kHz – 281 kHz
Usable sensitivity (S/N = 20dB)	45 μ V

CD player section

Laser diode	GaAlAs (λ =780 nm)
Digital filter (D/A)	8 Times Over Sampling
D/A Converter	8 level $\Delta\Sigma$
Spindle speed (CD-DA)	500 – 200 rpm (CLV)
(MP3)	1000 – 400 rpm (CLV)
Wow & Flutter	Below Measurable Limit
Frequency response (\pm 1 dB)	10 Hz – 20 kHz
Total harmonic distortion (1 kHz)	0.01 %
Signal to Noise ratio (1 kHz)	96 dB
Dynamic range	95 dB
Channel separation	90 dB
MP3 decode	Compliant with MPEG-1.0 Audio Layer-3

Audio section

Maximum output power	47 W \times 4
Full Bandwidth Power (DIN 45324, +B=14.4V)	22 W \times 4
Tone action	
Bass :	100 Hz \pm 10 dB
Middle :	1 kHz \pm 10 dB
Treble :	10 kHz \pm 10 dB
Preout level / Load (during disc play)	1800 mV/10 k Ω
Preout impedance	\leq 600 Ω

General

Operating voltage (11 – 16V allowable)	14.4 V
Current consumption	10 A
Installation Size (W x H x D)	182 x 53 x 156 mm
Weight	1.8 kg

KENWOOD

Free Manuals Download Website

<http://myh66.com>

<http://usermanuals.us>

<http://www.somanuals.com>

<http://www.4manuals.cc>

<http://www.manual-lib.com>

<http://www.404manual.com>

<http://www.luxmanual.com>

<http://aubethermostatmanual.com>

Golf course search by state

<http://golfingnear.com>

Email search by domain

<http://emailbydomain.com>

Auto manuals search

<http://auto.somanuals.com>

TV manuals search

<http://tv.somanuals.com>