

KENWOOD

Z919

MULTI CONTROL CD-RECEIVER INSTRUCTION MANUAL

KENWOOD CORPORATION

**Take the time to read through this instruction manual.
Familiarity with installation and operation procedures will help you obtain the
best performance from your new CD-receiver.**

For your records

Record the serial number, found on the back of the unit, in the spaces designated on the warranty card, and in the space provided below. Refer to the model and serial numbers whenever you call upon your KENWOOD dealer for information or service on the product.

Model Z919 Serial number _____

© PRINTED IN JAPAN B64-1687-00 (KJ) (+)
01/12 11 10 9 8 7 6 5 4 3 2 1 00/12 11 10 9 8 7 6 5 4



Contents

Before use

Warning.....	3
Safety precautions	3
Notes on playing MP3 files	5
Handling Compact discs	8

General features

Power.....	9
Switching Modes	9
Volume.....	10
Loudness	10
Panel Angle Adjustment	10
Clock Adjustment.....	10
Stopwatch.....	11
Timer.....	11
Alarm.....	12
Automatic Dimmer Function.....	12
Display Font Setting.....	12
Switching the Round Indicator for the Sound Level	12
Audio Control Setting.....	13
Digital Crossover Network	15

Tuner features

Tuning	16
Station Preset Memory	16
Auto Memory Entry	17
Preset Tuning.....	17
Clean Reception System Circuit (CRSC)	17
Switching Display for Tuner	17
Station Name Preset (SNPS).....	18
Station Name Preset Play (SBF).....	19
Direct Access Tuning	19

CD/External disc control features

Playing CDs.....	20
Playing Other Disc Mode	21
Fast Forwarding and Reversing Disc Play	21
Track Search	21
Disc Search	22
Track Repeat	22
Disc Repeat.....	22
Track Scan.....	22
Disc Scan	22
Random Play	23
Magazine Random Play.....	23
Text Scroll	23

Direct Track Search.....	23
Direct Disc Search	24
Presetting Disc Names	24
Switching Display for Discs	25
Switching Playing Time Display	25
Search on Initials.....	26

MP3 features

Playing MP3 files	28
File Search	28
Folder Search	29
File Repeat	29
Folder Repeat.....	29
Random Play	29
Name Scroll for MP3.....	29
Presetting Disc Names (DNPS).....	29
Direct File Search.....	30
Switching Display for MP3.....	30
Folder Select	30

External TV control features

Tuning	32
Station Preset Memory	32
Auto Memory Entry	32
Preset Tuning.....	32
Direct Access Tuning	33

Function set system

Function Set System.....	34
Touch Sensor Tone	34
Dimmer	34
Silent Display	34
KEX (Sound Coordinate system)	35
SP (Speaker selector).....	35

Basic operations of remote35

Installation

Accessories.....	39
Installation Procedure	39
Connecting Wires to Terminals.....	40
System Connection.....	41
Installation	42
Removing the Unit	44

Troubleshooting guide45

Specifications48

▲ Warning

▲ CAUTION

Use of controls or adjustments or performance of procedures other than those specified herein may result in hazardous radiation exposure.

In compliance with Federal Regulations, following are reproductions of labels on, or inside the product relating to laser product safety.

KENWOOD CORPORATION
2967-3, ISHIKAWA-CHO,
HACHIOJI-SHI
TOKYO, JAPAN

KENWOOD CORP. CERTIFIES THIS EQUIPMENT
CONFORMS TO DHHS REGULATIONS NO.21 CFR
1040. 10, CHAPTER 1, SUBCHAPTER J.

Location : Bottom Panel

FCC WARNING

This equipment may generate or use radio frequency energy. Changes or modifications to this equipment may cause harmful interference unless the modifications are expressly approved in the instruction manual. The user could lose the authority to operate this equipment if an unauthorized change or modification is made.

NOTE

This equipment has been tested and found to comply with the limits for a Class B digital device, pursuant to Part 15 of the FCC Rules. These limits are designed to provide reasonable protection against harmful interference in a residential installation. This equipment may cause harmful interference to radio communications, if it is not installed and used in accordance with the instructions. However, there is no guarantee that interference will not occur in a particular installation. If this equipment does cause harmful interference to radio or television reception, which can be determined by turning the equipment off and on, the user is encouraged to try to correct the interference by one or more of the following measures:

- Reorient or relocate the receiving antenna.
- Increase the separation between the equipment and receiver.
- Connect the equipment into an outlet on a circuit different from that to which the receiver is connected.
- Consult the dealer or an experienced radio/TV technician for help.

NOTE

This Class B digital apparatus complies with Canadian ICES-003.

Safety precautions

▲ WARNING

To prevent injury or fire, take the following precautions:

- Insert the unit all the way in until it is fully locked in place. Otherwise it may fall out of place when jolted.
- When extending the ignition, battery, or ground wires, make sure to use automotive-grade wires or other wires with a 0.75mm² (AWG18) or more to prevent wire deterioration and damage to the wire coating.
- To prevent a short circuit, never put or leave any metallic objects (such as coins or metal tools) inside the unit.
- If the unit starts to emit smoke or strange smells, turn off the power immediately and consult your Kenwood dealer.
- Make sure not to get your fingers caught between the faceplate and the unit.
- Be careful not to drop the unit or subject it to strong shock.
The unit may break or crack because it contains glass parts.

Safety precautions

▲CAUTION

To prevent damage to the machine, take the following precautions:

- Make sure to ground the unit to a negative 12V DC power supply.
- Do not open the top or bottom covers of the unit.
- Do not install the unit in a spot exposed to direct sunlight or excessive heat or humidity. Also avoid places with too much dust or the possibility of water splashing.
- Do not subject the faceplate to excessive shock, as it is a piece of precision equipment.
- When replacing a fuse, only use a new one with the prescribed rating. Using a fuse with the wrong rating may cause your unit to malfunction.
- To prevent a short circuit when replacing a fuse, first disconnect the wiring harness.
- Do not place any object between the faceplate and the unit.
- Do not use your own screws. Use only the screws provided. If you use the wrong screws, you could damage the unit.

NOTE

- The illustrations of the display and the panel appearing in this manual are examples used to explain more clearly how the controls are used. Therefore, what appears on the display in the illustrations may differ from what appears on the display on the actual equipment, and some of the illustrations on the display may represent something impossible in actual operation.
- If you experience problems during installation, consult your Kenwood dealer.
- If the unit does not seem to be working right, try pressing the reset button first. If that does not solve the problem, consult your Kenwood dealer.

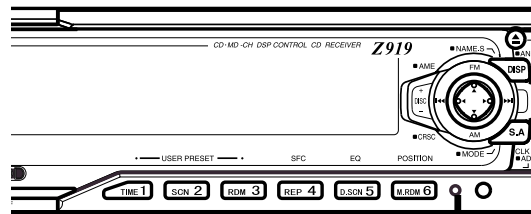

Reset button

- The functions that can be used and the information that can be displayed will differ depending on the external disc players being connected.

Cleaning the Unit

If the front panel gets dirty, turn off the power and wipe the panel with a dry silicon cloth or soft cloth.

▲CAUTION

Do not wipe the panel with a hard cloth or a cloth dampened by volatile solvents such as paint thinner and alcohol. They can scratch the surface of the panel and/or cause the indicator letters to peel off.

Cleaning the CD Slot

As dust tends to accumulate in the CD slot, clean it every once in a while. Your CDs can get scratched if you put them in a dusty CD slot.

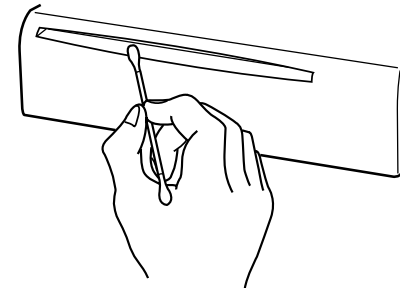

Lens Fogging

Right after you turn on the car heater in cold weather, dew or condensation may form on the lens in the CD player of the unit. Called lens fogging, CDs may be impossible to play. In such a situation, remove the disc and wait for the condensation to evaporate. If the unit still does not operate normally after a while, consult your Kenwood dealer.

Notes on playing MP3 files

This unit can play MP3 files.

Note, however, that the MP3 file recording media and formats acceptable are limited.

When writing MP3 files, pay attention to the following restrictions.

Acceptable media

The MP3 file recording media acceptable to this unit are CD-ROM, CD-R, and CD-RW.

Acceptable medium formats

The medium formats acceptable to this unit are ISO 9660 Level 1 and Level 2 excluding the extended formats. When reading an MP3 file written in a format other than ISO 9660 Level 1 or Level 2, the unit may fail to play the file normally or display the file or folder name correctly.

The major specifications of ISO 9660 Level 1 and Level 2 are as follows:

- Maximum number of directory levels: 8
- Maximum number of files and folders per directory level:
253 (files and folders in total)
- Characters available to file and folder names:
A - Z, 0 - 9, _(underscore)
- Maximum number of characters in file names:
Level 1 : 12 (including a separator "." and a 3-character extension)
Level 2 : 31 (including a separator "." and a 3-character extension)

Settings for your MP3 encoder and CD writer

When you use your MP3 encoder to compress audio data to an MP3 file, set the transfer bit rate of the encoder to fixed 128 kbps.

When you use your CD writer to record MP3 files up to the maximum disc capacity, disable additional writing. For recording on an empty disk up to the maximum capacity at once, check Disc at Once.

Entering file and folder names

When entering file and folder names, use alphanumeric characters only. If entered with any other character, the file and folder names are not displayed correctly. They may neither be displayed correctly depending on the CD writer used.

Note that the unit cannot display ID tags even though they have been embedded in MP3 files.

The unit recognizes and plays only those MP3 files which have the MP3 filename extension (.MP3). MP3 files should therefore be saved with the MP3 extension.

Writing files into a medium

When a medium containing MP3 data is loaded, the unit checks all the files on the medium. If the medium contains a lot of folders or non-MP3 files, therefore, it takes a long time until the unit starts playing MP3 files.

In addition, it may take time for the unit to move to the next MP3 file or a file search or folder search may not be performed smoothly. You should not write non-MP3 files or unneeded folders along with MP3 files on the medium.

▲CAUTION

When playing MP3 files on a medium which also contains non-MP3 files or folders, observe the following precautions. Loading such a medium may produce loud noise to break the speakers.

- Do not attempt to play a medium containing a non-MP3 file with the MP3 extension.
The unit mistakes non-MP3 files for MP3 files as long as they have the MP3 extension.
- Do not attempt to play a medium containing non MP3 file.

Notes on playing MP3 files

MP3 file playing order

When selected for play, folder search, file search, or for folder select, files and folders are accessed in the order in which they were written by the CD writer.

Because of this, the order in which they are to be recorded does not match the order in which they are played. You may be able to set the order in which MP3 files are to be played by writing them onto a medium such as a CD-R with their file names beginning with play sequence numbers such as "01" to "99", depending on your CD writer.

For example, a medium with the following folder/file hierarchy is subject to folder search, file search, or folder select as shown below.

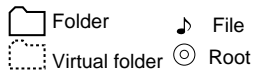

Example of a medium's folder/file hierarchy
(For a file search or folder search)

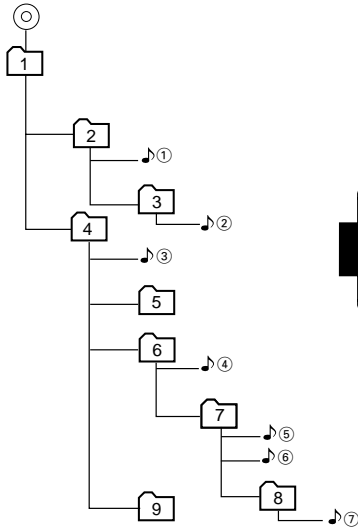

Level 1 Level 2 Level 3 Level 4 Level 5

Medium's virtual folder/file hierarchy
for a folder select

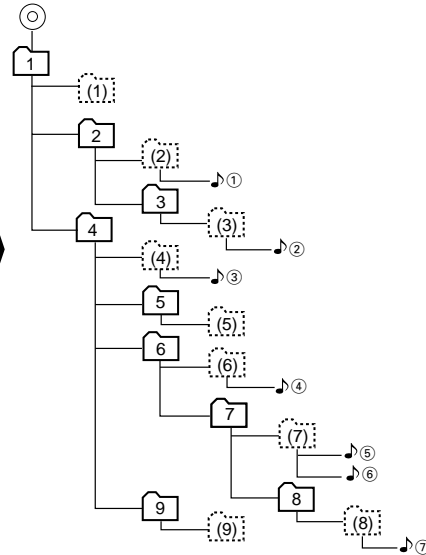

Level 1 Level 2 Level 3 Level 4 Level 5

When a file search is executed with file 4 being played ...

Current file number	Operation of the button	
	◀◀ Button	▶▶ Button
4	Beginning of file 4 → 3 → 2 → 1 → 7 ...	5 → 6 → 7 → 1 ...

When a folder search is executed with file 4 being played ...

When a folder search is executed with file 4 currently being played, the unit selects folders as shown below, starting with folder 6.

Current folder number	Operation of the button	
	FM Button	AM Button
6	7 → 8 → 9 → 1 ...	5 → 4 → 3 → 2 → 1 → 9 ...





When folder select is selected with file 3 being played to move from folder to folder ...

During folder select, a virtual folder is created one hierarchical level below each folder. The hierarchy is displayed as if the MP3 file recorded in each folder were placed in that virtual folder.

When the unit enters the folder select mode with file 3 being played, it selects folders as shown below, starting with folder 4 (virtual folder 4).

Current folder number	Operation of the button			
	◀◀ Button	▶▶ Button	AM Button	FM Button
4	9 → 6 → 5 → 4 ...	5 → 6 → 9 ...	4 → 1	—

NOTE

- Each virtual folder is displayed with the original folder name bounded by parentheses " () ". For example, the virtual folder below the folder named " 4 " is displayed with a name of " (4) ". The file name of each virtual folder is displayed with up to 29 characters (in the ISO 9660 Level 2 format) or 10 characters (in the ISO 9660 Level 1 format), excluding the binding parentheses.
- The FM button is disabled in a folder because it has no subordinate hierarchical level below. Immediately after entering the folder select mode as in the above example, therefore, the FM button cannot be used as there is no hierarchical level below folder  . Once you have moved to folder  using the folder select function, for example, you can use the FM button to select folder  →  one level below.

Handling Compact discs

Playing a CD that is dirty, scratched or warped can cause the sound to skip and the unit to operate incorrectly, resulting in worsened sound quality. Take the following precautions to prevent your CDs from getting scratched or damaged.

Handling CDs

- Do not touch the recorded side of the CD (the side opposite the label) when holding it.



- The reflective film on a CD-R or a CD-RW is more fragile than that on an ordinary music CD, and may peel off if scratched. Fingerprints on a CD-R or CD-RW are also more likely to cause skipping when the disc is played. For these reasons, handle the disc very carefully. Detailed handling instructions will appear on the CD-R or CD-RW package: read this information carefully before using the disc.
- Do not stick tape on either side of the CD.

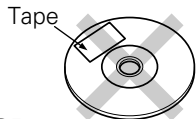

Storing CDs

- Do not store CDs in areas exposed to direct sunlight (such as a car seat or the dashboard) or other hot places. A CD-R or CD-RW is more susceptible than a music CD to damage from high temperatures and humidity, and in some cases, may become unusable if left in the car for long periods of time.

- Remove CDs from the unit when not listening to them for a while, and put them back in their cases. Do not pile up CDs that are removed from their cases or prop them against something.

Cleaning CDs

If a CD has gotten dirty, wipe it off gently using a commercially available cleaning cloth or a soft cotton cloth, starting from the center of the disc and moving outward. Do not clean CDs with conventional record cleaners, anti-static formulas, or chemicals such as paint thinner or benzene.

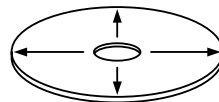

Checking New CDs for Burrs

When playing a new CD for the first time, check that there are not any burrs stuck to the perimeter of the disc or in the central hole. CDs with burrs stuck on them may not load properly or may skip while playing. Remove burrs using a ballpoint pen or a similar utensil.

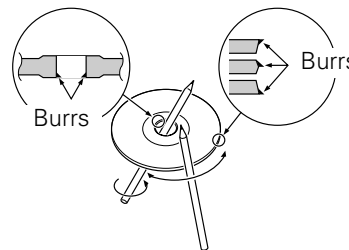

Do Not Load CD Accessories

Do not use commercially available CD accessories that can be loaded into the CD slot, such as stabilizers, protective sheets, or CD cleaning discs, since they can cause the unit to malfunction.

Removing the CD

Only remove the CD from the machine in a horizontal direction, holding it flat. You may damage the surface of the CD if you try pulling it down as it ejects.

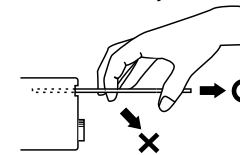

Do Not Use Special Shape CDs

- Be sure to use round shape CDs only for this unit and do not use any special shape CDs. Use of special shape CDs may cause the unit to malfunction.

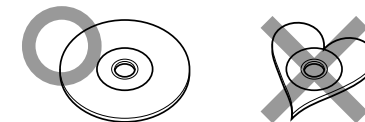

- Do not use any CD which does not bear one of the following marks:



- CD-Rs and CD-RWs which have not undergone finalization processing cannot be played. (For more information on finalization processing, refer to the manual for your CD-R/CD-RW writing software or CD-R/CD-RW recorder.) Additionally, depending on the recording status, it may prove impossible to play certain CDs recorded on CD-R or CD-RW.

Do Not Use CDs with Sticker on the Labeled Side

Do not use the CD with the label sticker stuck on it.

Using such a CD may cause the CD to be deformed and the sticker to peel off, resulting in malfunction of the unit.

General features

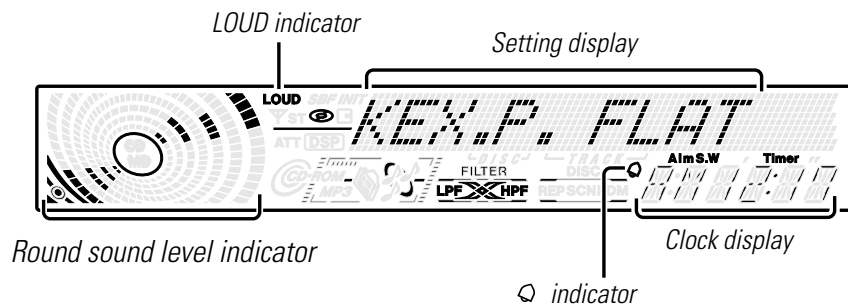
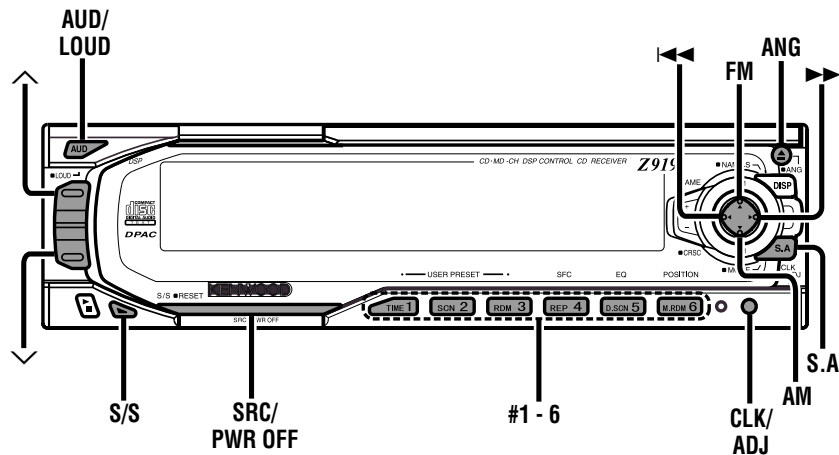

Power

Turning on the power:

Press the SRC (source) button.

NOTE

Turn the power on before carrying out the following procedures.

Turning off the power:

Press the PWR OFF button for at least one second.

Selecting standby mode:

Press the SRC button repeatedly and switch to "ALL OFF". When "ALL OFF" is displayed, the standby mode is activated. The standby mode turns all functions off while leaving the power to the unit on. Use this mode when you want to have the display illuminated but don't want to listen to anything.

Switching Modes

Switching Modes:

Each time you press the SRC (source) button, the mode switches as follows:

- ↓
- Tuner mode
- ↓
- CD/MP3 mode
- ↓
- External disc control mode
- ↓
- External TV control mode
- ↓
- Standby mode

NOTE

- The mode switches to the next mode from any mode which cannot be used.
- The external disc and TV control mode will differ depending on the unit that is connected.
- MP3 files can be played only on this unit.

General features

Volume

Increasing Volume:

Press the \wedge button to turn up the volume.

Decreasing Volume:

Press the \vee button to turn down the volume.

Loudness

This function amplifies low and high tones when the volume is turned down.

The LOUD indicator lights up when the loudness function is on.

Turning Loudness On/Off:

Press the LOUD button for at least one second to switch the loudness on and off.

Panel Angle Adjustment

You can adjust the front panel angle for easy viewing.

Sliding the panel:

Each time you press the ANG button for at least one second, the front panel will slide to three positions step by step.

NOTE

If the power is turned off, the front panel will close automatically. When you turn the power back on, the panel angle will return to the adjusted angle position.

Closing the panel:

Press the ANG button for at least one second repeatedly until the front panel closes.

CAUTION

- Take care that your fingers and so on do not get caught during the slide operation of the front panel.

- When the front panel has been slid, it might interfere with the shift lever or something else. If this happens, pay attention to safety and move the shift lever or take an appropriate action, then operate the unit.
- Do not apply excessive force to the front panel after it slides.

NOTE Protect function for the panel

The panel may move due to the protection mechanism, if any buttons are pressed with excessive force while the panel angle is adjusted to the slide position.

Clock Adjustment

Adjust the clock.

- 1 Press the CLK button to select the clock mode. Once the clock mode is selected, "CLOCK" will be displayed.

Adjusting the Clock:

- 2 Press the ADJ button for at least two seconds. "CLOCK ADJ" is displayed, and then you can adjust the time.
- 3 You can adjust hours with the FM/AM button, and minutes with the \lll/\ggg button.

NOTE To set the minute to "00"

Press the S/S button for at least one second to set the minute to "00".

Pressing this button while the minute is below "30" rounds it off, and while the minute is "30" or more rounds it up.

- 4 Press the CLK button to end the clock adjustment. Adjusting the minute restarts the second counter from 00.

Stopwatch

You can use the clock as a stopwatch.

- 1 Press the CLK button to select the stopwatch mode. Once the stopwatch mode is selected, "STOP WATCH" will be displayed. When you enter the stopwatch mode, the round sound level indicator changes its display to indicate the stopwatch mode.

- 2 **To start the measurement**

Press the S/S button.

- 3 **To stop the measurement**

Press the S/S button.

NOTE If you want to clear the time

Press the S/S button for at least one second. Then the time indication will return to "0:00'00"0".

- 4 **To restart the measurement**

Press the S/S button to restart the measurement.

NOTE To set the time to "0:00"

Press the S/S button for at least one second to return the time to "0:00".

- 4 Press the CLK button to end the time setting for timer.

- 5 **To start the timer**

Each time you press the S/S button, the timer will start and stop.

When you start the timer, the Q indicator will light up and the time counting will start.

NOTE If you want to clear the setting time of the timer

Press the S/S button for at least one second.

Then the setting time of the timer will return to the time set in the step 3.

- 6 **When the time set in the step 3 has passed**

The timer will beep for five seconds.

You can immediately stop the beep by pressing the S/S button, or leave it without any action for about 5 seconds.

Timer

You can use the clock as a timer. Once you set a time, the timer will beep when the set time has past.

- 1 Press the CLK button to select the timer mode. Once the timer mode is selected, "TIMER" will be displayed. When you enter the timer mode, the round sound level indicator changes its display to indicate the timer mode.

Time Setting:

- 2 Press the ADJ button for at least two seconds. "TIMER ADJ" is displayed, and then you can set a time for the timer.
- 3 You can adjust hours with the FM/AM button, and minutes with the I◀◀/▶▶I button.

General features

Alarm

You can use the clock as an alarm. The alarm will beep on the time set.

- 1 Press the CLK button to select the alarm mode.
Once the alarm mode is selected, "ALARM" will be displayed.

Time Setting:

- 2 Press the ADJ button for at least two seconds.
"ALARM ADJ" is displayed, and you can set a time for the alarm.
- 3 You can adjust hours with the FM/AM button, and minutes with the I◀◀/▶▶I button.

NOTE To set the minute to "00"

Press the S/S button for at least one second to set the minute to "00".

Pressing this button while the minute is below "30" rounds it off, and while the minute is "30" or more rounds it up.

- 4 Press the CLK button to end the time setting for alarm.
- 5 **To start the alarm**
Press the S/S button to switch the alarm on and off.
When you turn the alarm on, the  indicator will light up.
- 6 **When the time set in the step 3 has come**
The alarm will beep for 15 seconds.
You can immediately stop the beep by pressing the S/S button, or leave it without any action for about 15 seconds.

Automatic Dimmer Function

The display dims when the car's lights are turned on.

NOTE

The dimmer function is not available for units if the dimmer wire is not connected.

Display Font Setting

You can change the font used on the display.

Changing the display font:

Press the S.A button for at least one second to toggle between the normal font and funky font.

Switching the Round Indicator for the Sound Level

You can change the display mode of the round sound level indicator to the left of the display.

Changing the round sound level indicator:

Press the S.A button to cycle through the round sound level indicator as shown below:



NOTE

- You cannot switch the round sound level indicator when Silent display in the function set is on.
Set Silent display in the function set to off before you change the round sound level indicator.
- You cannot switch the round sound level indicator when the clock display is in the stopwatch mode and the timer mode.

Audio Control Setting

Adjust various parameters of sound quality.

- 1 Press the AUD button repeatedly and switch the display to "AUDIO CTRL" to enter the audio control mode. Pressing the button cycles through Audio control mode, Crossover control mode, and Control mode off.
- 2 **Selecting mode**
Press either the FM or AM button.
Each time the button is pressed, the adjustment mode will change.
Please refer to the following for the contents of the adjustment modes.
NOTE Source tone memory
Each source (CD, FM, AM and disc changer) has its own memory in which to store the KEX.P, bass center frequency, bass level, bass quality factor, bass extension, treble center frequency, and treble level settings.
The settings made for a particular source are recalled automatically whenever you use that source (for example, FM mode uses the tone settings made for FM, AM for AM, etc.).
- 3 **Adjust each mode**
Press the I◀◀/▶▶I button.
Please refer to the following for the adjusting values.
- 4 Press the AUD button twice to end the audio control mode.

"KEX.P." : Recalling the kenwood preset sound setting

Press the preset buttons (#1-6).
Setting values: #1;Flat, #2;Rock, #3;Top40, #4;Jazz, #5;Easy, #6;Scan of #1-5

NOTE

- This mode is available only when the Sound coordinate system is on. (page 35)
- You can call the following settings with this function; bass center frequency, bass level, bass quality factor, bass extension, treble center frequency, and treble level setting.

"BASS f" : Adjust the center frequency of the bass.

Setting values: 60 / 70 / 80 / 100 (Only when the bass quality factor is set to 1.00, 1.25 or 1.50) / 150 (Only when the bass quality factor is set to 2.00) Hz

NOTE

This mode is available only when the Sound coordinate system is on. (page 35)

"BASS" : Adjust the bass level.

Setting values: - 6 - + 6

"BASS Q" : Adjust the Bass quality factor.

Setting values: 1.00 / 1.25 / 1.50 / 2.00

NOTE

This mode is available only when the Sound coordinate system is on. (page 35)

General features

"BASS EXT" : Switch the Bass Extend mode on/off.

Setting values: ON / OFF
(When the bass extend mode is set to on, low frequency response is extended by 20%.)

NOTE

This mode is available only when the Sound coordinate system is on. (page 35)

"TRE F" : Adjust the center frequency of the treble.

Setting values: 10.0 / 12.5 / 15.0 / 17.5 kHz

NOTE

This mode is available only when the Sound coordinate system is on. (page 35)

"TREBLE" : Adjust the treble level.

Setting values: - 6 – + 6

"BALANCE" : Adjust the balance level.

Setting values: Left 15 – Right 15

"FADER" : Adjust the fader level.

Setting values: Front 15 – Rear 15

"N-F LV" : Adjust the Non-fading output level.

Setting values: - 35 – + 5

"AMP CTRL" : Set the amplifier bass increment.

Setting values: OFF/1/2

NOTE

As of December 1998, the power amplifiers controllable by the main unit are as follows:
KAC-X501F/PS501F/X401M/PS401M/X301T/PS301T/X201T/PS201T

Storing your sound settings:

Press a preset button (#1-6) for at least two seconds except during the bass center frequency, bass level, bass quality factor, bass extension, treble center frequency, and treble level adjust mode.

NOTE

- This mode is available only when the Sound coordinate system is on. (page 35)
- The settings you can preset are, bass center frequency, bass level, bass quality factor, bass extension, treble center frequency, and treble level.

Recalling your sound settings:

Press a preset button (#1-6) except during the bass center frequency, bass level, bass quality factor, bass extension, treble center frequency, and treble level adjust mode.

NOTE

This mode is available only when the Sound coordinate system is on. (page 35)

Digital Crossover Network

Adjust various parameters of the Crossover network.

- 1** Press the AUD button repeatedly and switch the display to "X'OVER CTRL" to enter the Crossover network control mode. Pressing the button cycles through Audio control mode, Crossover control mode, and Control mode off.
- 2 Selecting mode**
Press either the FM or AM button.
Each time the button is pressed, the adjustment mode will change.
Please refer to the following for the contents of the adjustment modes.
- 3 Adjust each mode**
Press the **|◀▶|** button.
Please refer to the following for the adjusting values.
- 4** Press the AUD button once to end the Crossover network control mode.

"HPF F" : Adjust the frequency of the High-pass filter for front output.

Setting values: THROU / 40Hz / 60Hz / 80Hz / 100Hz / 120Hz / 150Hz / 180Hz / 220Hz

NOTE

You can separately set the high-pass filter for front and rear output, including preouts. The high-pass filter does not affect the non-fading preout.

"HPF R" : Adjust the frequency of the High-pass filter for rear output.

Setting values: THROU / 40Hz / 60Hz / 80Hz / 100Hz / 120Hz / 150Hz / 180Hz / 220Hz

NOTE

You can separately set the high-pass filter for front and rear output, including preouts. The high-pass filter does not affect the non-fading preout.

"LPF NF" : Adjust the frequency of the Low-pass filter for Non-Fading output.

Setting values: 50 Hz / 80 Hz / 120 Hz / THROU

"PHASE : Adjust the phase for Non-Fading output.

Setting values: NOR (0°) / REV (180°)

Storing your settings of the Crossover network:

Press a preset button (#1-6) for at least two seconds.

Recalling your settings of the Crossover network:

Press a preset button (#1-6) for the desired Crossover network setting.

Tuner features

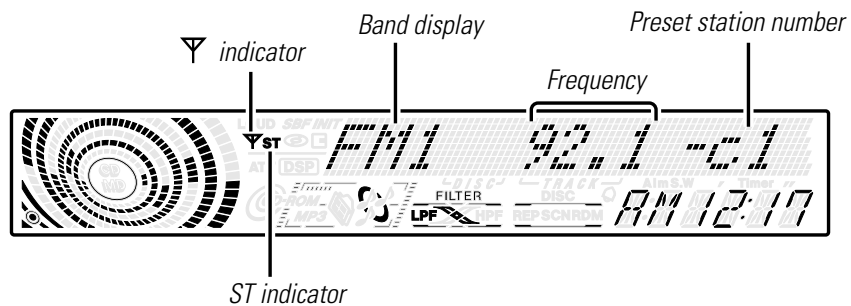
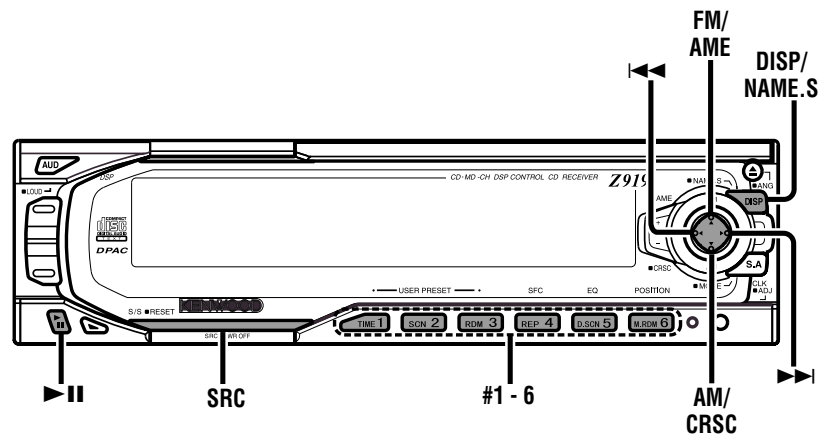

Tuning

- 1 Press the SRC (source) button repeatedly to select the tuner mode. "TUNER" is displayed when the tuner mode has been selected.
- 2 Press either the FM or AM button to select the band. Each time you press the FM button, the band switches between the FM1, FM2, and FM3. Press the AM button to select the AM band.
- 3
 - Auto Seek Tuning
Press the **▶▶** button for at least half a second to seek higher frequencies.
Press the **◀◀** button for at least half a second to seek lower frequencies.
 - Manual Tuning
Press the **▶▶** button to increase the frequency by one step.
Press the **◀◀** button to decrease the frequency by one step.

NOTE

The ST indicator lights up when stereo broadcasts are being received.

Station Preset Memory

Store the frequency of a station. You can then recall that station with a single touch of a button.

- 1 Select the band/station that you want to have stored.
- 2 Press the button (#1-6) that you want to use for the station, for at least two seconds.
The button number blinks once in the display to indicate that the data has been stored.

NOTE

You can store six stations in each of the FM1, FM2, FM3, and AM bands.

Auto Memory Entry

You can automatically store all the receivable frequencies in the band currently being listened to, and then recall them with the touch of a button later. This function is especially useful when you are travelling and do not know what stations are available. Up to six frequencies can be stored this way.

- 1 Select the band for auto memory entry.
- 2 Press the AME button for at least two seconds to start auto memory entry.
The numbers of the preset station buttons are shown in order. When all the stations in a certain band are stored in the preset memory, the auto memory entry stops. The tuner then plays the last station received.

Preset Tuning

You can recall a station being preset in preset station buttons (#1-6).

Recalling a Preset Station:

Press the preset station button (#1-6) for the desired station. The number of the recalled station is displayed.

Clean Reception System Circuit (CRSC)

Temporarily have reception switched from stereo to mono to reduce multi-path noise when listening to the FM station. The factory default for this function is ON.

Turning CRSC On/Off:

Press the CRSC button for at least one second to turn the function on/off.

When the CRSC is turned on, the ∇ indicator lights off.

NOTE

Strong electrical fields (such as from power lines) may cause unstable sound quality when CRSC is turned on. In such a situation, turn it off.

Switching Display for Tuner

You can change the display used when listening to the radio.

Changing the Display:

Each time you press the DISP button, the display changes as follows:

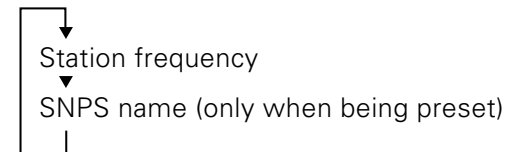

Tuner features

Station Name Preset (SNPS)

You can assign names to radio stations with the Station Preset Memory. Up to 30 stations can be assigned names.

- 1 Adjust the frequency to the station whose name you want to enter.
- 2 Press the NAME.S button for at least two seconds. "NAME SET" is displayed once the station name preset mode is entered. The cursor will blink in the position where letters are entered.
- 3 Press either the **I◀◀** or **▶▶I** button to move the cursor to the desired position. The **I◀◀** button moves the cursor to the left, and the **▶▶I** button to the right. You can also move the cursor left or right by pressing the **I◀◀** or **▶▶I** buttons, respectively, on the remote.
- 4 Each time the **▶||** button is pressed, the characters to be entered change as listed below. Press the FM or AM button to display the desired character. Characters that can be displayed are as follows:

Alphabet (upper case): A - Z 0 - 9 ! " # \$ % & ' ()
* + , - . / : ; < = > ? @ [¥] ^ ¯ ` ´ ·

Alphabet (lower case): a - z 0 - 9 ! " # \$ % & ' ()
* + , - . / : ; < = > ? @ [¥] ^ ¯ ` ´ ·

NOTE Direct Alphabet Input (Function of remote)

You can directly input letters using the number/letter entry buttons on the remote.

Example: Use the following table to enter the name "DANCE".

Character	Button to press	# Times pressed
"D"	#3	1
"A"	#2	1
"N"	#6	2
"C"	#2	3
"E"	#3	2

- 5 Continue steps 3 and 4 until all the characters are chosen for the name.

NOTE

You can enter up to 12 characters for each name.

6 Assigning Names

Press the NAME.S button on the unit or the OK button on the remote.

The name of the station is stored in memory, and the Station Name Preset mode ends.

Also, if you make no input for 10 seconds, the name will be stored up to the point that you have entered, and the mode ends.

NOTE

- You can assign names up to 30 FM/AM stations in all.
- Station names remain stored even if the reset button is pressed.
- If you want to change the name of a station, first display the name of the station (following steps 1 and 2 above), then change the letter(s) that you want by following steps 3 and 4.
- Removing this unit from the battery power supply erases station names.

Station Name Preset Play (SBF)

(Function of Remote)
(See page 35)

You can search for the station for any station if its name has been preset using Station Name Preset.

- 1 Press the SBF button.
"SBF MODE" will be displayed once the station name preset play mode is entered.
The names of the stations stored in the band currently listened to are displayed in the following order for five seconds each:

→ FM1 ↔ FM2 ↔ FM3 ↔ AM ←

Each time you press the ►► button, the station display switches in the forward direction.

Each time you press the ◀◀ button, the station display switches in the reverse direction.

Stations whose names have not been stored will be displayed as frequencies.

NOTE Changing the Displayed Band

Pressing the FM button switches between the FM1, FM2, and FM3 displays, in that order.

Pressing the AM button switches to the AM display.

- 2 **Once the name is displayed for the station you want to listen to**

Press the OK button.

Reception starts of the displayed station, and the Station Name Preset Play mode ends.

Direct Access Tuning

(Function of Remote)
(See page 35)

Use the remote to select frequencies directly.

- 1 Select the band by pressing the FM or AM button.
- 2 Press the DIRECT button.
In the display, "----" blinks for 10 seconds.
If you make no input in the 10-second period, direct access tuning is automatically canceled.
- 3 Enter the frequency of the desired station while the display is blinking.
If you want to listen to an FM station at 92.1 MHz, for example, press 9, 2, and 1.
If you want to listen to an AM station at 530 kHz, for example, press 5, 3, and 0.

NOTE

You cannot enter frequencies above or below what a band can receive.

Canceling Direct Access Tuning:

Press the DIRECT button again.

CD/External disc control features

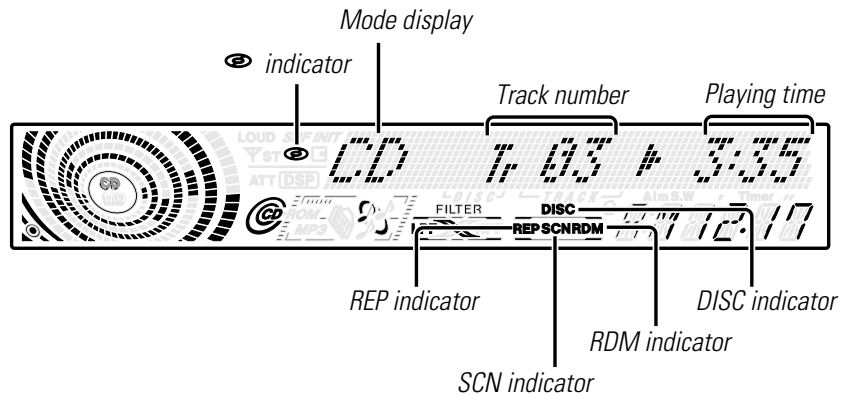
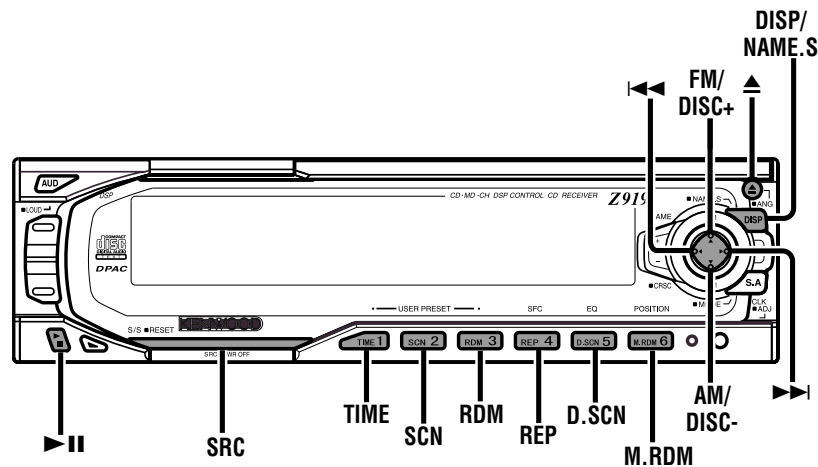

NOTE

For playing MP3 files, see "MP3 features" (page 27).

Playing CDs

Play:

Press the ▲ button to slide open the front panel, showing the CD (insertion) slot. Holding the CD with the labeled side facing up, insert it in the slot. The front panel will close, and the CD will start playing. The CD indicator will light up when a CD has been inserted.

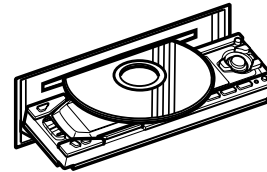

Playing CDs Already Inserted:

Press the SRC button repeatedly to select the CD mode. "CD" is displayed when the CD mode has been selected. The CD will start playing.

Pausing and Restarting CD Play:

Press the ►|| button to make the disc pause. Press the same button again to start play again.

Eject:

Press the ▲ button. The front panel will slide to eject the CD. Press the ▲ button to close the front panel.

CAUTION

- Do not attempt to insert a CD into the slot if another one is already there.
- When the front panel has been slid, it might interfere with the shift lever or something else. If this happens, pay attention to safety and move the shift lever or take an appropriate action, then operate the unit.
- Do not apply excessive force to the front panel after it slides.
- Do not use the unit with the front panel in the slid condition. Doing so will cause breakdown.

NOTE

When you load a CD and eject it right away, the next time you try to insert the CD may not load. In such a situation, take the CD out for a moment and then reinsert it.

Playing Other Disc Mode

This function permits the connection of optional players and the playing of discs other than the loaded CD (in the current unit).

Playing Discs:

Press the SRC button repeatedly to select the external disc control mode.
The disc will start playing.

NOTE

The external disc control mode will differ, depending on the unit that is connected.

Mode Display Examples

- "CD 2"...when a CD player is connected
- "CDCH"...when a disc changer is connected
- "CDCH 1", "CDCH 2"...when two disc changers are connected

Pausing and Restarting Disc Play:

Press the ►|| button to make the disc pause.
Press the same button again to start play again.

NOTE (For disc changers)

When one disc has finished playing its last track, the next disc in the changer will start playing. When the last disc in the changer has finished, the player will return to the first disc and start playing it.

Fast Forwarding and Reversing Disc Play**Fast Forwarding Disc Play:**

Hold down on the ►►I button.
Release your finger to play the disc at that point.

Reversing Disc Play:

Hold down on the I◄◄ button.
Release your finger to play the disc at the point.

Track Search

Search forward or backward through the tracks on the disc until you reach the one that you want to listen to.

Making a Backward Track Search:

Press the I◄◄ button to display the desired track number.
Press once to search back to the beginning of the current track, twice to search back to the beginning of the previous track, and so forth.
Play starts at the beginning of the displayed track number.

NOTE (For disc changers)

Pressing the I◄◄ button while listening to track 1 will only search back to the beginning of that track. The reverse search is not "recycled" to the last track on the disc.

Making a Forward Track Search:

Press the ►►I button to display the desired track number.
Press once to fast forward to the next track, twice to fast forward to the track after that, and so forth.
Play starts at the beginning of the displayed track number.

NOTE (For disc changers)

You cannot make a forward track search when listening to the last track on a disc.

CD/External disc control features

Disc Search *(Function of disc changers)*

Search forward or backward through the discs in a disc changer.

Making a Backward Disc Search:

Press the DISC- button to display the desired disc number. Each time the button is pressed, the displayed disc number decreases by one. Play starts at the beginning of the displayed disc.

Making a Forward Disc Search:

Press the DISC+ button to display the desired disc number. Each time the button is pressed, the displayed disc number increases by one. Play starts at the beginning of the displayed disc.

NOTE

"Load" is displayed when discs are being exchanged on the disc changer.

Track Repeat

Repeat playing the track currently being listened to.

Turning Track Repeat Play On/Off:

Press the REP button to switch track repeat play on and off. The REP indicator lights up when track repeat play is turned on.

NOTE

Repeat play is canceled when you eject the disc.

Disc Repeat *(Function of disc changers)*

Repeat playing the disc currently being listened to.

Turning Disc Repeat Play On/Off:

Press the REP button for at least one second to switch disc repeat play on and off. The DISC REP indicator lights up when disc repeat play is turned on.

NOTE

Repeat play is canceled when you eject the disc.

Track Scan

Successively play the beginning of each track on a disc until you find the track that you want to listen to.

Starting the Track Scan:

Press the SCN button. The SCN indicator lights up and the first 10 seconds of each track will be played, in order. The track number currently being heard blinks in the display.

Stopping to Listen to the Track Being Scanned:

Press the ►|| or SCN button again to stop the scan and keep on listening to a track normally.

NOTE

- The track scan function is canceled when you eject the disc.
- The track scan function only scans each track on a disc once.

Disc Scan *(Function of disc changers)*

Successively play the beginning of each disc on a changer until you find the one that you want to listen to.

Starting the disc scan:

Press the D.SCN button. The DISC SCN indicator lights up and the first 10 seconds of each disc will be played, in the order they are loaded on the changer. The disc number currently being heard blinks in the display.

Stopping to Listen to the Disc Being Scanned:

Press the ►|| or D.SCN button again to stop the scan and keep on listening to the disc normally.

NOTE

- The disc scan function is canceled when you eject the disc.
- The disc scan function only scans each disc on the changer once.
- "Load" is displayed when discs are being exchanged on the disc changer.

Random Play

Play all the tracks on the current disc in random order.

- 1 Press the RDM button to switch random play on and off. The RDM indicator lights up when random play is turned on. The track number will change over and over in the display as the next track is being selected. When the track has been selected, play will begin.

NOTE (For disc changers)

When all the tracks on a certain disc have been played using random play, the next disc on the changer will start playing using the same function.

- 2 To change the track being heard, press the ►► button. Another track will be selected and played.

NOTE

Random play is canceled when you eject the disc.

Magazine Random Play *(Function of disc changers)*

Play the tracks on all the discs in the disc changer in random order.

- 1 Press the M.RDM button to switch magazine random play on and off. The DISC RDM indicator lights up when magazine random play is turned on. The disc and track numbers will change over and over in the display as the next track is being selected. When the disc/track has been selected, play will begin.
- 2 To change the track being heard, press the ►► button. Another disc/track will be selected and played.

NOTE

- Magazine random play is canceled when you eject the disc.
- The time needed for random selection depends on the number of discs loaded in the disc magazine.

Text Scroll

This function permits the text to be scrolled and the entire text to be displayed.

Turning the Text Scroll on/off :

Press the TIME button for at least one second to switch the Text Scroll on and off.

When the Text Scroll is turned on:

The text display will be scrolled repeatedly.

When the Text Scroll is turned off:

The text display will be scrolled once each time when it is switched over.

Direct Track Search

(Function of Remote)
(See page 35)

Using the remote, directly input the track number that you want to listen to.

- 1 Using the number buttons on the remote, input the number of the track that you want to listen to. The selected track number will blink in the display for 10 seconds. If you make no further input in the 10-second period, the number entry mode will automatically be canceled.
- 2 Press either the ◀◀ or ►► button while the track number is blinking. The track starts playing.

Canceling Direct Track Search While It Is Operating:

Press the ►|| button.

NOTE

You cannot use the direct track search function while doing track or disc scans or using random or magazine-random play.

CD/External disc control features

Direct Disc Search *(Function of disc changers with remote)* (See page 35)

Using the remote, directly input the disc number that you want to listen to.

- Using the number buttons on the remote, input the number of the disc that you want to listen to.
The selected disc number will blink in the display for 10 seconds.
If you make no further input in the 10-second period, the number entry mode will automatically be canceled.

NOTE

- Input "0" to select disc 10.
 - If you input more than two numbers all at once, a search will be made only of the last number input.
- Press either the DISC+ or DISC- button while the number inputted is blinking.
The disc starts playing.

Canceling Direct Disc Search While It Is Operating:

Press the ►|| button.

Presetting Disc Names

Store the names of discs to be displayed when played.

- Play the disc whose name you want to preset.
- Press the NAME.S button for at least two seconds.
"NAME SET" is displayed and the disc name preset mode is entered.
The cursor blinks in the position where character input can be made.
- Press either the ◀◀ or ▶▶ button to move the cursor to the desired position.
The ◀◀ button moves the cursor to the left, and the ▶▶ button to the right.
You can also move the cursor left or right by pressing the ◀◀ or ▶▶ buttons, respectively, on the remote.

- Each time the ►|| button is pressed, the characters to be entered change as listed below.
Press the FM or AM button to display the desired character.
Characters that can be displayed are as follows:

Alphabet (upper case): A - Z 0 - 9 ! " # \$ % & ' ()
* + , - . / : ; < = > ? @ [¥] ^ ` _ ` .

Alphabet (lower case): a - z 0 - 9 ! " # \$ % & ' ()
* + , - . / : ; < = > ? @ [¥] ^ ` _ ` .

NOTE Direct Alphabet Input (Function of remote)

You can directly input letters using the number/letter entry buttons on the remote.

Example: Use the following table to enter the name "DANCE".

Character	Button to press	# Times pressed
"D"	#3	1
"A"	#2	1
"N"	#6	2
"C"	#2	3
"E"	#3	2

- Continue steps 3 and 4 until all the characters are chosen for the name.

NOTE

You can enter up to 12 characters for each name.

6 Assigning Names

Press the NAME.S button on the unit or the OK button on the remote.

The disc name is stored and the disc name preset mode is canceled.

If you make no entry in a 10-second period, the name will be stored with the characters input so far.

NOTE

- You can register up to 10 disc names in this unit, up to 100 disc names in the CD changer C907, up to 10 disc names in the TV/CD player VZ907 respectively.
- Discs are identified by their total length and number of tracks. If another disc happens to have the same specifications as one that you have already stored a name for, the name will be displayed for it, too.
- If you want to change the name of a disc, repeat steps 1 and 2 to display the name, and then repeat steps 3 and 4 to input the changes.
- Disc names remain stored even if the reset button is pressed.
- Removing this unit from the battery power supply erases disc names.

Switching Display for Discs

Switch the display that appears while discs are playing.

Switching Display for Discs:

Each time you press the DISP button, the display during disc play switches as follows:

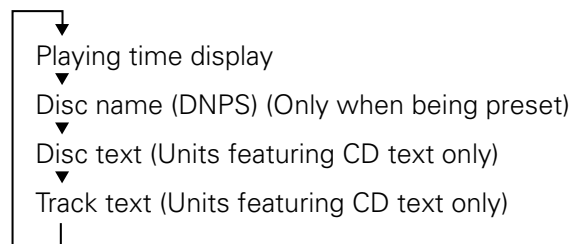

NOTE

- The playing time display will differ, depending on the setting of the switching playing time display function (see page 25).
- You can give names to discs through the presetting disc names function (see page 24).
Note that depending on the unit, display may not be possible.

- If you try to display the name of a disc that does not have one, "NO NAME" is displayed instead.
- When there is an attempt to display the text of a disc for which the disc text/track text has not been recorded, "NO TEXT" is displayed.
- Depending on the type of characters of the CD text, some characters may not be displayed.

Switching Playing Time Display

Switch the playing time display that appears while the playing time display is selected.

Switching Playing Time Display:

Each time you press the TIME button, the display during time display switches as follows:

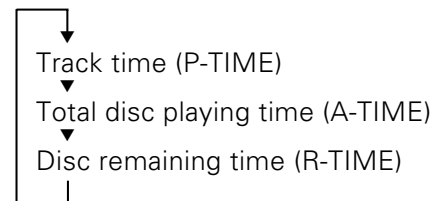

CD/External disc control features

Search on Initials *(Function of disc changers with remote)* *(See page 35)*

You can search a disc in the unit and the CD player/changer with the initials of disc names or disc texts.

- 1 Press the SBF button.
"INITIAL MODE" will appear in the display, and the Search on Initials mode is entered.
- 2 Each time the ►|| button is pressed, the characters change as listed below.

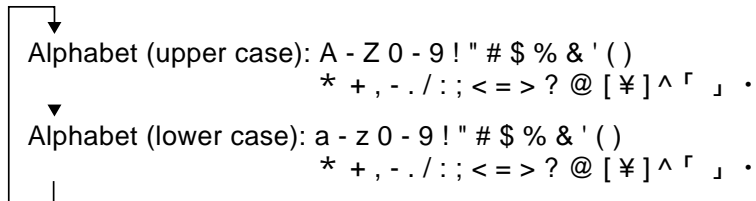

- 3 Press the FM or AM button to select an initial character.

NOTE

If you omit the above-mentioned step 2-3, all discs will be subjects for search.

- 4 Press the SBF button to start the search.
The disc names or disc texts, which have the designated initial, will be displayed one after other for five seconds each.

Rapid display (forward / reverse):

Press the ◀◀ or ▶▶ button.
Pressing the ▶▶ button will rapidly display the preset names/disc texts in order.
Pressing the ◀◀ button will rapidly display the preset names/disc texts in reverse order.

- 5 **When the name appears for the disc you want to play**
Press the OK button.
The disc whose name is displayed will be recalled, and the Search on Initials mode will end.

NOTE

- If there is only one disc with the designated initial, the operation of step 5 will be omitted and the disc will start playing immediately.
- You can not search a disc in the disc changer with the Search on Initials, if you have never played the disc before.
In this case, you must play all discs by using the disc scan etc. before using the Search on Initials.

MP3 features

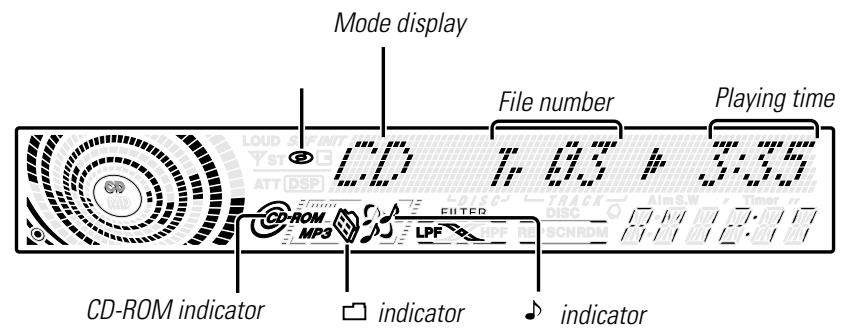
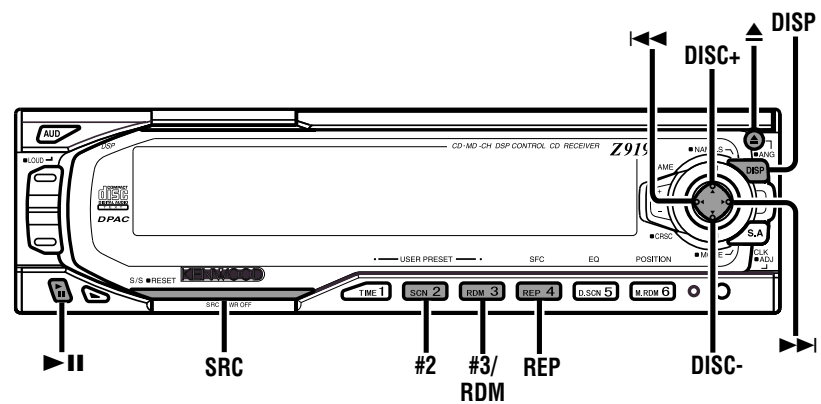

MP3 features

Playing MP3 files

Play:

Press the **▲** button to slide open the front panel, showing the CD (insertion) slot. Holding the media with the labeled side facing up, insert it in the slot. The front panel will close, and the media will start playing.

The CD-ROM indicator will light when a media has been inserted.

The **□** indicator lights up when the folder containing the MP3 file currently being played has another folder at the same hierarchical level.

Playing Media Already Inserted:

Press the SRC button repeatedly to select the CD mode. "CD" is displayed when the CD mode has been selected. The media will start playing.

Pausing and Restarting Media Play:

Press the **▶||** button to make the media pause. Press the same button again to start play again.

NOTE

MP3-related operations (such as a file search and folder search) cannot be performed during a pause. Cancel the pause before you can perform such operations.

Eject:

Press the **▲** button.

The front panel will slide to eject the media .

Press the **▲** button to close the front panel.

▲CAUTION

- Do not attempt to insert a media into the slot if another one is already there.
- When the front panel has been slid open, it might interfere with the shift lever or something else. If this happens, pay attention to safety and move the shift lever or take an appropriate action, then operate the unit.
- Do not apply excessive force to the front panel after it slides.
- Do not use the unit with the front panel in the slid condition. Doing so will cause breakdown.

NOTE

- When you load a media and eject it right away, the next time you try to insert the media may not load. In such a situation, take the media out for a moment and then reinsert it.
- The manual search is disabled when an MP3 file is being played.
- The MP3 media that this unit can play are CD-ROM, CD-R, and CD-RW. The medium formats must be ISO 9660 Level 1 or Level 2. The methods and precautions to be followed for writing MP3 files are covered in "Notes on playing MP3 files" (page 5). Check that section before creating your MP3 media.
- It takes time for the unit to check each medium to see if it contains any MP3 file before it starts playing the medium.
- When the unit is playing an MP3 file, the commercially available TV monitor VZ907 may list the currently disabled buttons on the Audio control display.

File Search

Search forward or backward through the files on the media until you reach the one that you want to listen to.

Making a Backward File Search:

Press the **◀** button to display the desired file number.

Press once to search back to the beginning of the current file, twice to search back to the beginning of the previous file, and so forth.

Play starts at the beginning of the displayed file number.

Making a Forward File Search:

Press the **▶▶** button to display the desired file number.

Press once to fast forward to the next file, twice to fast forward to the file after that, and so forth.

Play starts at the beginning of the displayed file number.

NOTE

It may take time for the file search depending on the number of files and the state of the folder hierarchy.

Folder Search

Search forward or backward through the folders on the media.

Making a Backward Folder Search:

Press the DISC- button.

Pressing the button moves back to the previous folder. The unit plays the medium starts at the beginning of the selected folder. If the selected folder contains no MP3 file, the unit automatically plays the file nearest to that folder in the MP3 file playing order.

Making a Forward Folder Search:

Press the DISC+ button.

Pressing the button moves to the next folder. The unit plays the medium starts at the beginning of the selected folder. If the selected folder contains no MP3 file, the unit automatically plays the file nearest to that folder in the MP3 file playing order.

NOTE

It may take time for the folder search depending on the number of files and the state of the folder hierarchy.

File Repeat

Repeat playing the file currently being listened to.

Turning File Repeat Play On/Off:

Press the REP button to switch file repeat play on and off. " 🎵 -REP" is displayed when file repeat play is turned on.

NOTE

File repeat play is canceled when you eject the media.

Folder Repeat

Repeat playing the folder currently being listened to.

Turning Folder Repeat Play On/Off:

Press the REP button at least one second to switch folder repeat play on and off. " 📁 -REP" is displayed when folder repeat play is turned on.

NOTE

Folder repeat play is canceled when you eject the media.

Random Play

Play all the files on the current folder in random order.

Turning Random Play On/Off:

- 1 Press the RDM button to switch random play on and off. " 📁 -RDM" is displayed when random play is turned on. When the file has been selected, play will begin.
- 2 To change the file being heard, press the ►► button. Another file will be selected and played.

NOTE

Random play is canceled when you eject the media.

Name Scroll for MP3

This function permits the folder/file name to be scrolled and the entire name to be displayed.

You can use this function in the same manner as with audio CDs. See "Text scroll" (page 23) for details.

Presetting Disc Names (DNPS)

Store the name of the media to be displayed when played.

You can name MP3 recorded media in the same way as for audio CDs. See "Presetting Disc Names" (page 24) for details. If you assign a disc name to a MP3 file stored disc, the same DNPS is displayed for all discs containing MP3 data.

MP3 features

Direct File Search

(Function of Remote)
(See Page 35)

Using the remote, directly input the file number that you want to listen to.

- Using the number buttons on the remote, input the number of the file that you want to listen to.
The selected file number will blink in the display for 10 seconds.
If you make no further input in the 10-second period, the number entry mode will automatically be canceled.
- Press either the ◀◀ or ▶▶ button while the file number is blinking.
The file starts playing.

Canceling Direct File Search While It Is Operating:

Press the ▶|| button.

NOTE

- You cannot use the direct file search function while using random play.
- The only files that can be selected using Direct File Search, are those in the folder containing the MP3 file currently playing.

Switching Display for MP3

Switch the display that appears while MP3 files are playing.

Switching Display for MP3:

Each time you press the DISP button, the display during files play switches as follows.

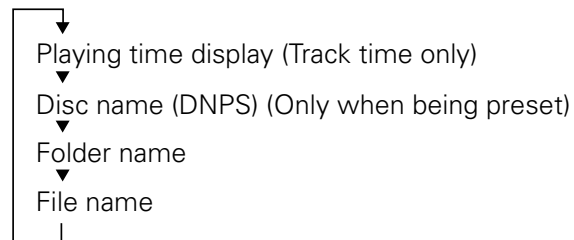

NOTE

- You can give names to medium through the presetting disc name function (see p.29).
Note that depending on the unit, display may not be possible.
- If you try to display the name of a media that does not have one, "NO NAME" is displayed instead.
- Folder names and file names are not displayed correctly if the loaded medium does not conform to ISO 9660 Level 1/2 or if they contain any character unacceptable to your CD writer.
- The Playing time display may not match the actual playing time depending on the MP3 file recording states.

Folder Select

You can use this function to select the folder containing the sound file you want be played.

1 Enter the Folder Select Mode

Press the #2 button. "SELECT MODE" is displayed and the folder select mode is turned on.
The display reads as shown below.

< Folder name display >

Displays the current folder name.



< Folder number display >

Displays the number in the folder belonging to the currently selected folder.

< Hierarchical level display >

Displays the hierarchical level of the current folder.

NOTE

The unit cannot enter the folder select mode if the loaded medium contains no folder recorded.

2 Selecting the desired folder

- You can move from folder to folder at the same hierarchical level:
Press the ►► button to move to the next folder at the same hierarchical level.
Press the ◀◀ button to move to the previous folder at the same hierarchical level.
- You can select the hierarchical level of the folder:
Press the FM button to move down one level in the folder hierarchy.
Press the AM button to move up one level in the folder hierarchy.
- You can return to the first hierarchical level (Root Jump):
Press the #3 button to return to the folder at the top hierarchical level on the medium currently being played.

NOTE

- The □ indicator blinks when the folder to which the current folder belongs has another folder at the same hierarchical level. The 🎵 indicator blinks when that folder contains an MP3 file.
- The methods for moving to other folders in the folder select mode are different from those in the folder search mode. See "Notes on playing MP3 files" (page 5) for details.

3 When you have found a desired folder

- Press the ►|| button.
This ends the folder select mode and starts playing the first MP3 file in the selected folder.

NOTE

If the folder selected after leaving the folder select mode contains no MP3 file, the unit plays the MP3 file nearest to that folder in the MP3 file playing order.

External TV control features

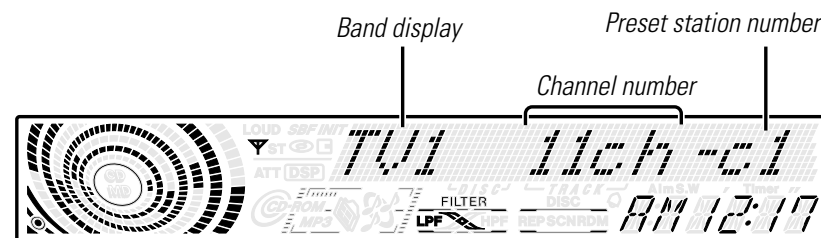
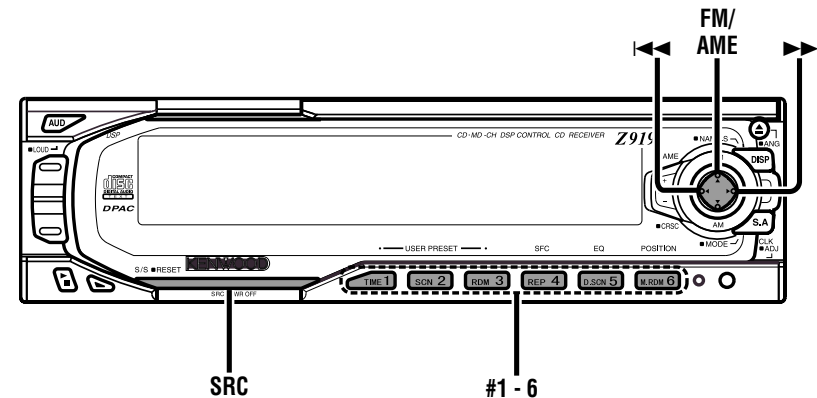

External TV control features

NOTE When the TV/CD player VZ907 is connected
When the TV/CD player VZ907 is connected, the TI button appears on the Source control screen of the TV monitor. Since the traffic information function is not installed in this unit, you can not use the TI button on the TV monitor.

Tuning

- 1 Press the SRC (source) button repeatedly to select the external TV control mode.
"TV" is displayed when the external TV control mode has been selected.
- 2 **Selecting Bands and Video Inputs**
Press the FM button to select the TV band.
Each time you press the FM button, the TV band switches between the TV1,TV2,Video1, and Video2.
- 3
 - Auto Seek Tuning (AUTO 1)
Press the ►►I button to seek increasing channels.
Press the I◄◄ button to seek decreasing channels.
 - Preset Station Seek Tuning (AUTO 2)
Press the ►►I button to move to the next preset station (the one with the next highest number), and the I◄◄ button to move to the last preset station (the one with the next lowest number).
 - Manual Tuning (MANUAL)
Press the ►►I button to increase the channel by one step.
Press the I◄◄ button to decrease the channel by one step.

NOTE

You can select the Tuning mode of AUTO1, AUTO2, or MANUAL at the television side. For details, please refer to the instruction manual for the television.

Station Preset Memory

Store the channel of a TV station. You can then recall that station with a single touch of a button.

- 1 Select the band/station that you want to have stored.
- 2 Press the button (#1-6) that you want to use for the station, for at least two seconds.
The button number blinks once in the display to indicate that the data has been stored.

NOTE

You can store six stations in each of the TV1 and TV2 bands.

Auto Memory Entry

You can automatically store all the receivable channels in the band currently being listened to, and then recall them with the touch of a button later. This function is especially useful when you are travelling and do not know what stations are available. Up to six channels can be stored this way.

- 1 Select the band for auto memory entry.
- 2 Press the AME button for at least two seconds to start auto memory entry.
The numbers of the preset station buttons are shown in order. When all the stations in a certain band are stored in the preset memory, the auto memory entry stops. The tuner then plays the last station received.

Preset Tuning

You can recall a station being preset in preset station buttons (#1-6).

Recalling a Preset Station:

Press the preset station button (#1-6) for the desired station. The number of the recalled station is displayed.

Function set system

Direct Access Tuning

(Function of Remote)

(See page 35)

Use the remote to select channels directly.

- 1 Select the TV band by pressing the FM button.
- 2 Press the DIRECT button.
In the display, "--" blinks for 10 seconds.
If you make no input in the 10-second period, direct access tuning is automatically canceled.
- 3 Enter the channel of the desired station while the display is blinking.
If you want to watch the channel 21 of the TV station, for example, press 2 and 1.

NOTE

You cannot enter channels above or below what a band can receive.

Canceling Direct Access Tuning:

Press the DIRECT button again.

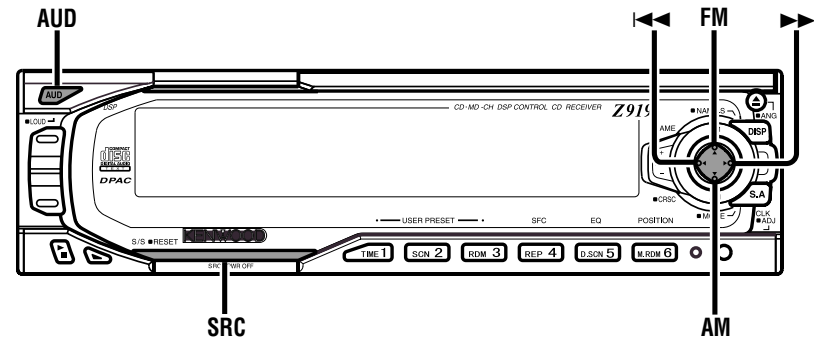

Setting display



Function set system

Function Set System

To accommodate a greater number of functions, a function set system has been employed for making settings. Press the AUD button to enter the function set mode and then display the function to make the setting.

- 1 Press the SRC button repeatedly and switch the display to "ALL OFF" to enter the standby mode.
- 2 Press the AUD button.
"FUNCTION SET" is displayed when the function set mode is entered.
The function that you can adjust is indicated with the current settings displayed.
- 3 **Selecting function to set**
Press the FM button to search through the functions until you see the one you want to adjust in the display.
Press the AM button to search through the functions backward.
Example: If you want to switch the setting of the touch sensor tone function from on to off, first search through the functions until you see "BEEP ON" in the display.

BEEP ON

- 4 **Changing setting for currently displayed function**
Press either the ◀◀ or ▶▶ button.
The setting will change for each function.
Example: The setting of the touch sensor tone will switch from on to off, and "BEEP OFF" is displayed.

BEEP ON → BEEP OFF

- 5 **Ending the function set mode**
Press the AUD button.

Touch Sensor Tone

This function produces a beep sound that accompanies button operation. It can be switched on or off.

Display and setting:

"BEEP ON" : Beep setting is on.
"BEEP OFF" : Beep setting is off.

NOTE

The beep sound is not output from the preout jacks.

Dimmer

You can dim the display.

Display and setting:

"DIMMER LOW" : The dimmer setting is low.
"DIMMER MIDDLE" : The dimmer setting is middle.
"DIMMER HIGH" : The dimmer setting is high.

NOTE

The dimmer function is not available for units if the dimmer wire is not connected.

Silent Display

If you feel that display amount on the screen is too much, you can reduce the display amount.

Display and setting:

"SILENT ON" : The silent display function setting is on.
"SILENT OFF" : The silent display function setting is off.

Basic Operations of remote

KEX (Sound Coordinate system)

When this system is set to on, the sound coordinate factors (KEX.P, Bass Frequency, Bass quality, Bass extension, and Treble frequency) appear during the audio control mode.

Display and setting:

- "KEX CTRL ON" : The sound coordinate factors appear and can be adjusted.
- "KEX CTRL OFF" : The sound coordinate factors are not appeared.

SP (Speaker selector)

Using this function to set the diameter of the speaker optimizes the sound quality to the speaker diameter.

Display and setting:

- "STANDARD": Speaker with a general diameter
- "NARROW": Speaker with small diameter
- "WIDE": Woofer with a large diameter
- "MIDDLE": Tweeter with a small diameter

NOTE

- This mode is available only when the Sound coordinate system is on. (page 35)
- This function fine-tunes the settings for bass center frequency, bass level, bass quality factor, bass extension, treble center frequency, and treble level which are recalled by Sound preset under Audio control.

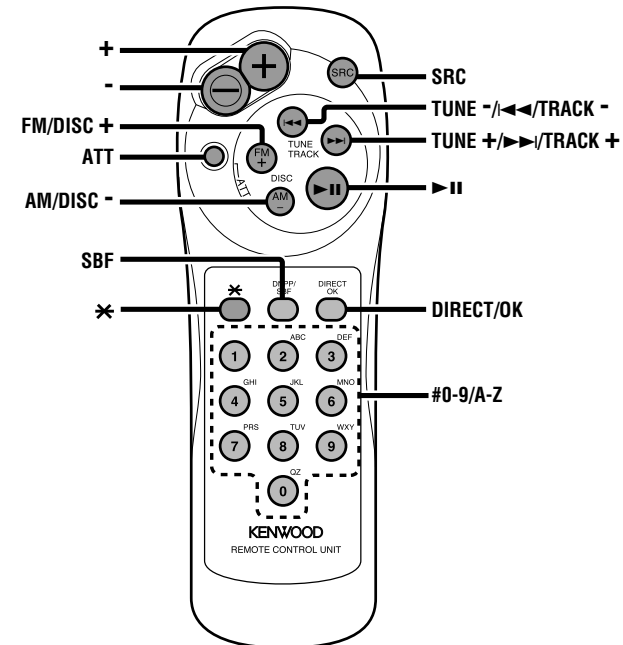

Basic Operations of remote

▲CAUTION

Do not set the remote on hot places such as above the dashboard.

Loading and Replacing the Batteries:

Use two "AAA"-size batteries.

Slide the cover while pressing downwards to remove it as illustrated.

Insert the batteries with the + and - poles aligned properly, following the illustration inside the case.

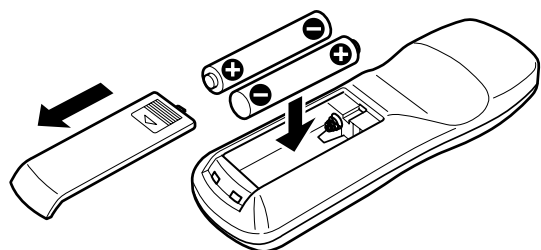

▲WARNING

Store unused batteries out of the reach of children. Contact a doctor immediately if the battery is accidentally swallowed.

NOTE

- The provided batteries are intended for use in operation checking, and their service life may be short.
- When the remote controllable distance becomes short, replace both of the batteries with new ones.
- A portion of the operations may not be possible, depending on the unit that is connected.

General features

- **VOLUME buttons**
Press the + button to turn the volume up.
Press the - button to turn the volume down.
- **SRC button**
Each time you press the SRC button, the mode switches as follows:

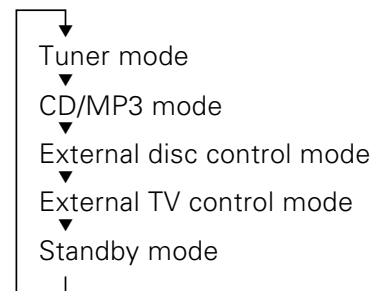

NOTE

- The mode switches to the next mode from any mode which cannot be used.
- The external disc and TV control mode will differ depending on the unit that is connected.
- MP3 files can be played only on this unit.
- **ATT button**
Turns down the volume quickly. To return the volume to its original level, press the button again. Turning the volume up, or turning it all the way down deactivates the attenuator function.
- *** button**
Each time you press this button, the front panel slides one step at a time.
When the front panel has been slid down completely, press this button to close the front panel.

Tuner features

- **Number/letter entry buttons**
Press buttons #1-6 to recall preset stations.
During direct access tuning, use these buttons to input the frequency of the station.
Use to enter letters (alphabetical) during station name preset.
- **◀◀/▶▶ (TUNE) buttons**
Press the ◀◀ button to decrease the frequency.
Press the ▶▶ button to increase the frequency.
Use to move the cursor left or right during station name input.
- **AM/FM button**
Press the AM button to select the AM band.
Press the FM button to select and switch between FM1, FM2, and FM3 bands.
During station name input, selects digits and symbols.
- **DIRECT/OK button**
Selects the direct access tuning mode, used to input frequencies directly. Press this button again to cancel the mode while it is operating.
During station name input, stores the already input data in memory and ends the input mode.
During Station Name Preset Play mode, selects station.
- **SBF button**
Enters the Station Name Preset Play mode.
During Station Name Preset Play mode, selects station.
- **▶|| button**
Selects the type of characters at the time of entering the station name.

CD/External disc/MP3 control features

- **Number/letter entry buttons**
Use to enter letters during the Search on Initials.
Used to specify the track (disc/file) number used in direct track (disc/file) searches.
Select a disc directly by inputting a disc number with this button during the Direct Disc Search mode.
NOTE
Input "0" to select disc 10.
- **◀◀/▶▶ buttons**
Press the ◀◀ button to search through the tracks and files backward.
Press the ▶▶ button to search through the tracks and files forward.
Use to move the cursor while entering disc name.
- **DISC buttons (For disc changers and media containing MP3 files)**
Press the DISC- button to search through the discs and folders backward.
Press the DISC+ button to search through the discs and folders forward.
Select numbers and symbols while entering disc name.
- **▶|| button**
When a disc is playing, this button pauses the play.
Press the same button again to start play again.
Selects the type of characters at the time of entering the disc name.
- **DIRECT/OK button**
Press this button to select the Direct Disc Search mode.
Selects disc during the Search on Initials mode.
During disc name input, stores the already input data in memory and ends the input mode.
- **SBF button (for disc changers)**
Enters the Search on Initials mode.
Selects disc during the Search on Initials mode.

Basic Operations of remote

External TV control features

- **Number/letter entry buttons**
Press buttons #1-6 to recall preset channels.
During direct access tuning, use these buttons to input the channel of the station.
- **◀◀/▶▶ (TUNE) buttons**
Press the ◀◀ button to make decreasing seeks.
Press the ▶▶ button to make increasing seeks.
- **FM button**
Each time you press the FM button, the TV band switches between the TV1,TV2,Video1, and Video2.
- **DIRECT button**
Selects the direct access tuning mode, used to input a channel directly. Press this button again to cancel the mode while it is operating.

Accessories

External view

.....Number of items

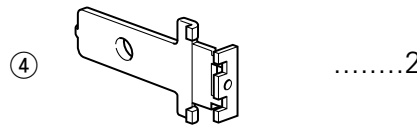
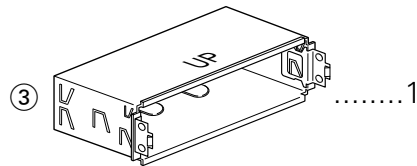
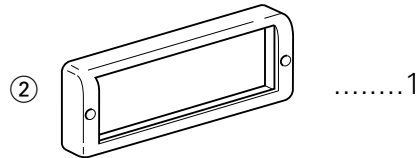
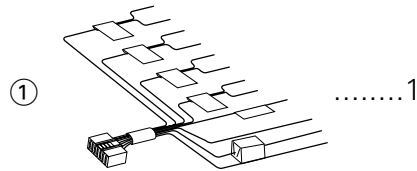

External view

.....Number of items

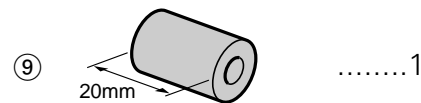
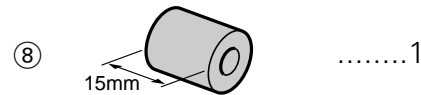
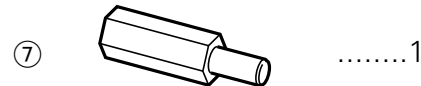
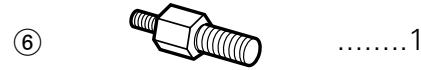

▲CAUTION

The use of any accessories except for those provided might result in damage to the unit. Make sure only to use the accessories shipped with the unit, as shown above.

Installation Procedure

1. To prevent a short circuit, remove the key from the ignition and disconnect the \ominus battery.
2. Make the proper input and output wire connections for each unit.
3. Connect the speaker wires of the wiring harness.
4. Connect the wiring harness wires in the following order: ground, battery, ignition.
5. Connect the wiring harness connector to the unit.
6. Install the unit in your car.
7. Reconnect the \ominus battery.
8. Press the reset button.

▲CAUTION

- If your car's ignition does not have an ACC position, connect the ignition wires to a power source that can be turned on and off with the ignition key. If you connect the ignition wire to a power source with a constant voltage supply, as with battery wires, the battery may die.
- If the console has a lid, make sure to install the unit so that the faceplate will not hit the lid when closing and opening.
- If the fuse blows, first make sure the wires aren't touching to cause a short circuit, then replace the old fuse with one with the same rating.
- Do not let unconnected wires or terminals touch metal on the car or anything else conducting electricity. To prevent a short circuit, do not remove the caps on the ends of the unconnected wires or the terminals.
- Connect the speaker wires correctly to the terminals to which they correspond. The unit may be damaged or fail to work if you share the \ominus wires or ground them to any metal part in the car.
- After the unit is installed, check whether the brake lamps, blinkers, wipers, etc. on the car are working properly.
- Insulate unconnected wires with vinyl tape or other similar material.
- Mount the unit so that the mounting angle is 30° or less.

Connecting Wires to Terminals

⚠WARNING

If you connect the ignition wire (red) and the battery wire (yellow) to the car chassis (ground), you may cause a short circuit, that in turn may start a fire. Always connect those wires to the power source running through the fuse box.

⚠CAUTION

When only two speakers are being connected to the system, connect the connectors either to both the front output terminals or to both the rear output terminals (do not mix front and rear). For example, if you connect the ⊕ connector of the left speaker to a front output terminal, do not connect the ⊖ connector to a rear output terminal.

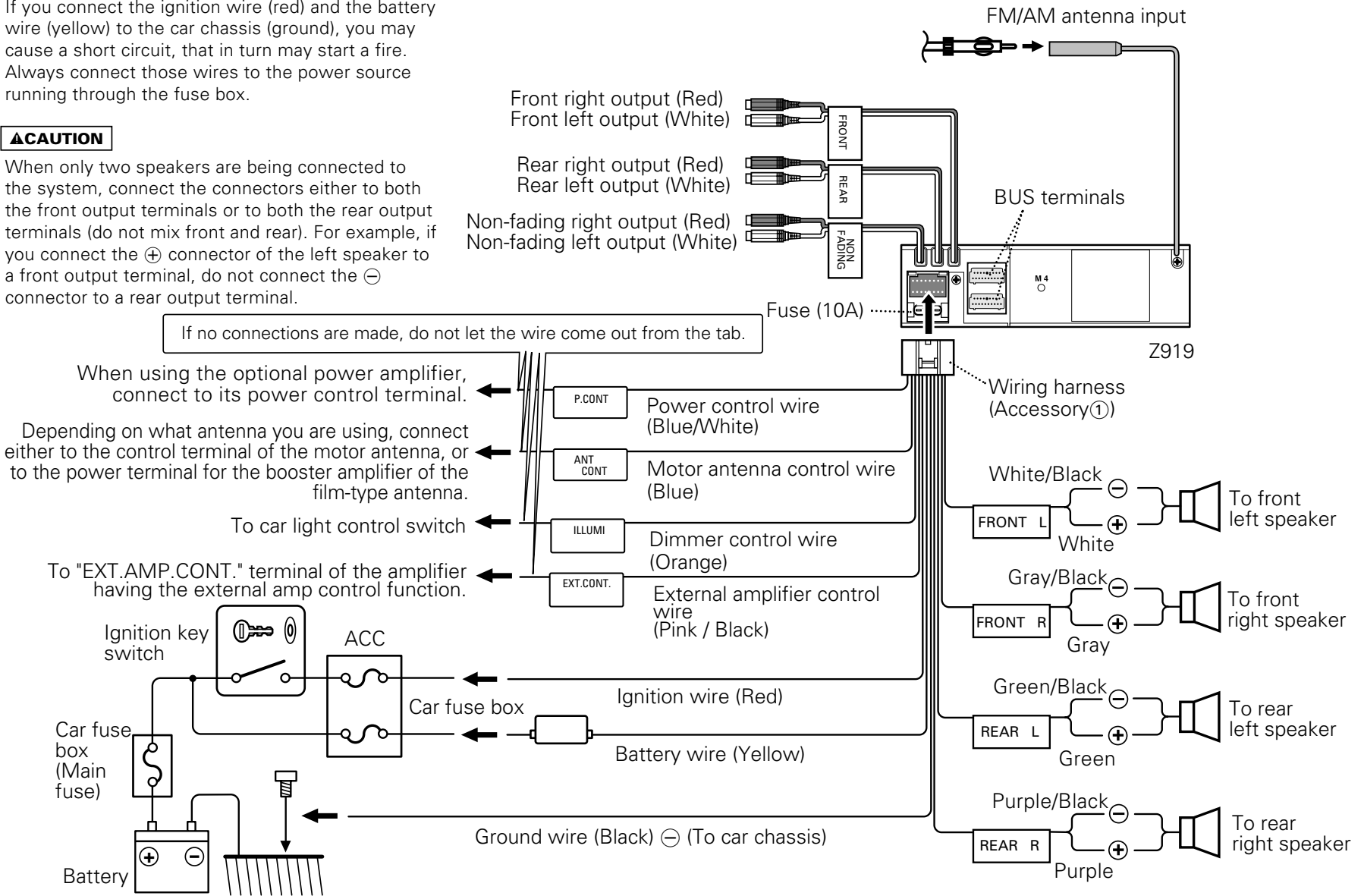

System Connection

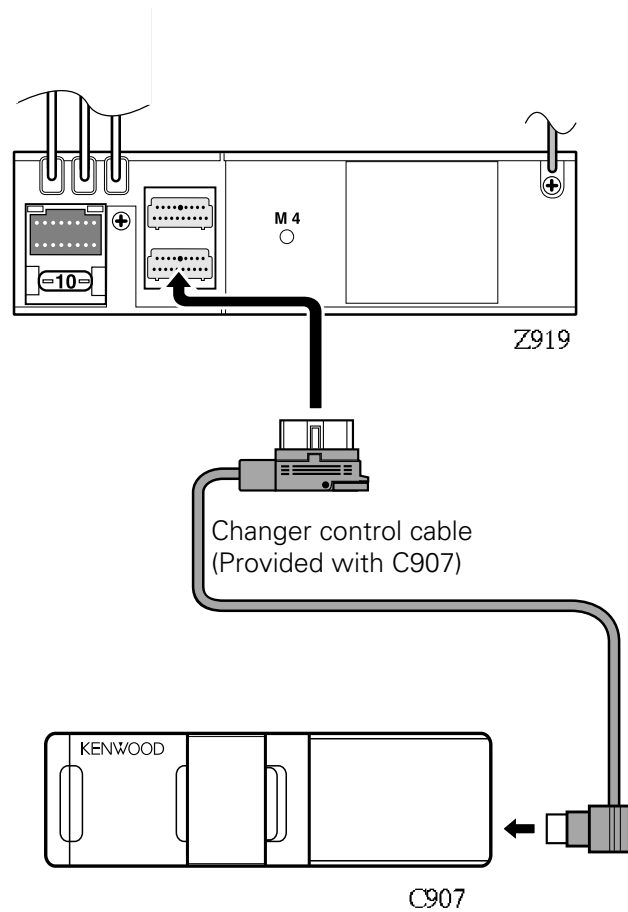

NOTE

- Do not remove the protection caps of the unused BUS terminals.
- Put the protection caps removed from the unit into the unused terminals in the unit connected.

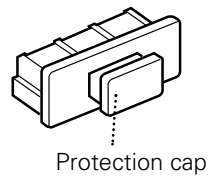

Installation

■ Assembly

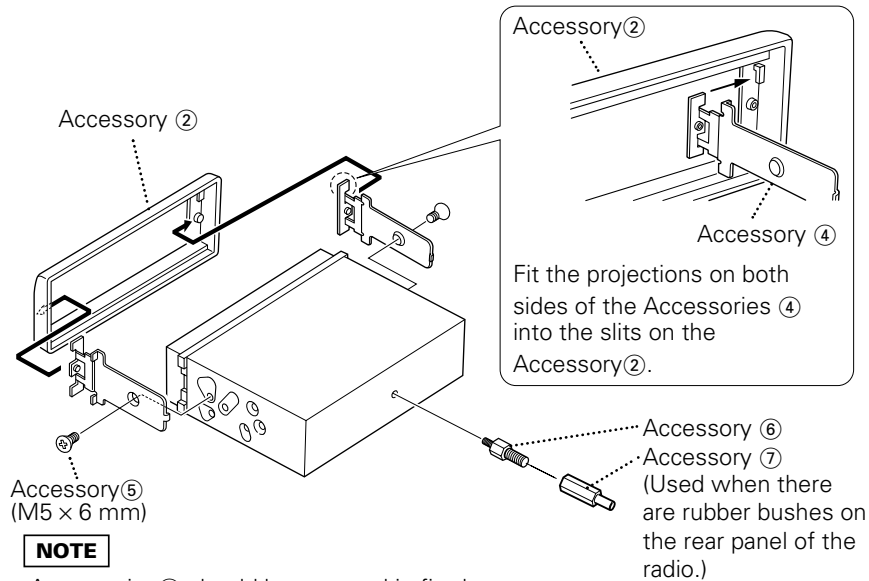

NOTE

Accessories ⑤ should be screwed in firmly. If it is not properly secured, it may rub against the mounting sleeve when the unit is removed, making itself impossible to remove.

CAUTION

- Be sure to press the reset button after installation.
- During installation, do not use any screws except for those provided. The use of different screws might result in damage to the main unit.
- Damage may occur if a screwdriver or similar tool is used with excessive force during the installations.
- When performing a check of the CD operation prior to installation, place this unit in a horizontal position and perform a loading/eject of the CD.

NOTE

- This installation method is a reference example.
- Make sure that the unit is installed securely in place. If the unit is unstable, it may malfunction (for example, the sound may skip).

NOTE How to install the rubber bushes (Accessories ⑧ and ⑨)
When installing, adjust the rubber bushes so that the position of the main unit is aligned with the position of the radio.

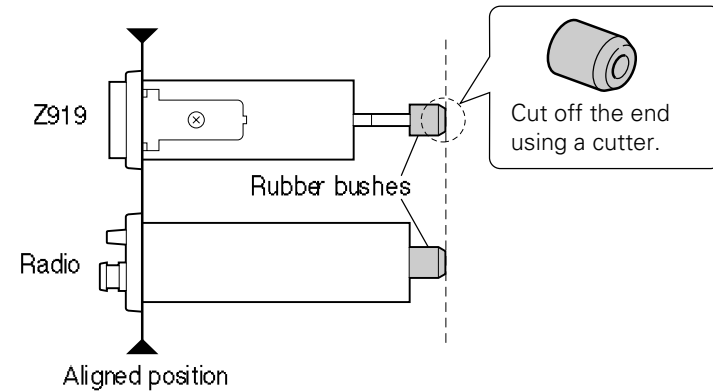

Installation example

Assemble the stepped screw (Accessory ⑥), the joint nut (Accessory ⑦), the rubber bushes (Accessories ⑧ and ⑨), and secure them to the rear panel of the unit.

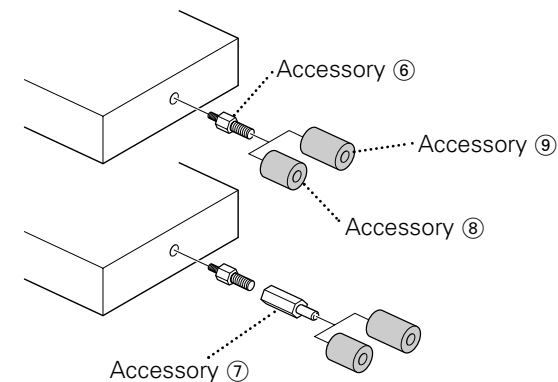

■ Installation

Remove the factory-installed car stereo and install the unit that was assembled in Assembly.

- 1 Install the mounting sleeve (Accessory ③) on the car side with the face labeled "UP" facing upwards.

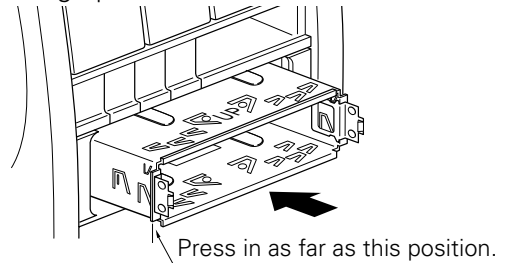

- 2 Bend the tabs of the mounting sleeve (Accessory ③) with a screwdriver or similar utensil and attach it in place.

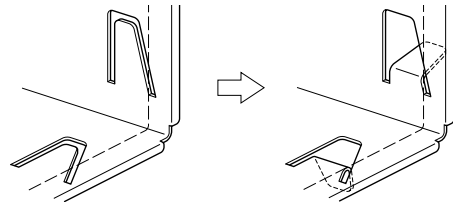

- 3 Connect the wires from the car side, and then insert the assembled unit into the mounting sleeve.

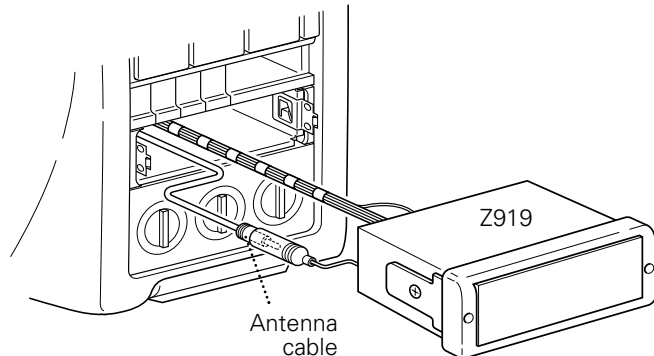

NOTE

In the case of an Audi, a Volkswagen, or any other model where rubber bushes (Accessories ⑧ and ⑨) are used, install the unit so that the rubber bushes on the rear panel fit into the holes on the car side.

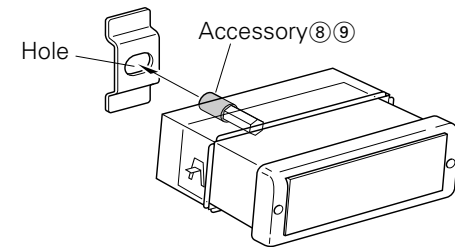

■ Installing in Japanese-Made Cars

Align the holes in the unit (two locations on each side) with the vehicle mounting bracket and secure the unit with the accessory screws.

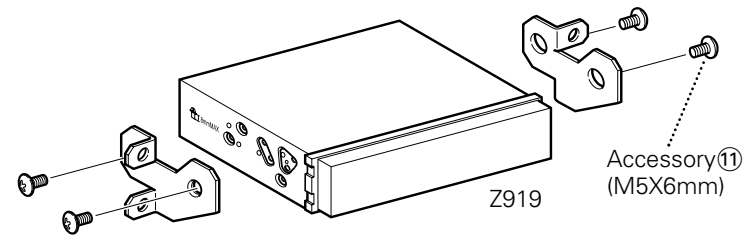

Removing the Unit

■ Removing the Unit

- 1 Screw the removal screws (Accessory⑩) away from you until the lock is released.

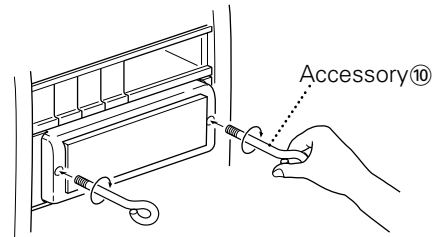

- 2 Pull the unit all the way out with your hands, being careful not to drop it.

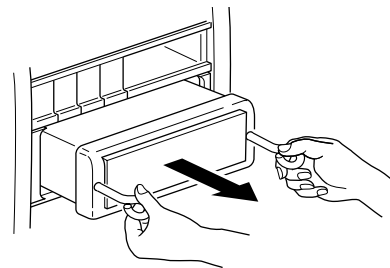

Troubleshooting Guide

What might seem to be a malfunction in your unit may just be the result of slight misoperation or miswiring. Before calling service, first check the following table for possible problems.

PROBLEM	POSSIBLE CAUSE	SOLUTION
The power does not turn on.	The fuse has blown.	After checking for short circuits in the wires, replace the fuse with one with the same rating.
No sound can be heard, or the volume is low.	Attenuator is turned on.	Turn off Attenuator.
	The fader or balance settings are set all the way to one side.	Reset the fader or balance settings.
	The input/output wires or wiring harness are connected incorrectly.	Reconnect the input/output wires or the wiring harness correctly. See the section on "Connecting Wires to Terminals".
Nothing happens when the buttons are pressed.	The computer chip in the unit is not functioning normally.	Press the reset button on the unit (see p.4).
The sound quality is poor or distorted.	One of the speaker wires is being pinched by a screw in the car.	Check the speaker wiring.
	The speakers are not wired correctly.	Reconnect the speaker wires so that each output terminal is connected to a different speaker.
Radio reception is poor.	The car antenna is not extended.	Pull the antenna out all the way.
	The antenna control wire is not connected.	Connect the wire correctly, referring to the section on "Connecting Wires to Terminals".
The memory is erased when the ignition is turned off.	The battery wire has not been connected to the proper terminal.	Connect the wire correctly, referring to the section on "Connecting Wires to Terminals".
	The ignition and battery wire are incorrectly connected.	Connect the wire correctly, referring to the section on "Connecting Wires to Terminals".
A CD ejects as soon as it is loaded.	The CD is upside-down.	Load the CD with the labeled side up.
	The CD is quite dirty.	Clean the CD, referring to the section on "Cleaning CDs" (see p.8).
The sound skips on a CD.	The CD is scratched or dirty.	Clean the CD, referring to the section on "Cleaning CDs" (see p.8).
A track will not play.	Random play has been selected.	Turn off random play.
There is noise during playback.	The CD is soiled with dust or dirt.	If another CD is played back and there is no problem, then the problem is due to the sound quality of the CD itself.

Troubleshooting Guide

English

PROBLEM	POSSIBLE CAUSE	SOLUTION
The sound skips.	The mounting angle exceeds 30°.	Adjust to an angle of less than 30°.
	The mounting is unstable.	Anchor the unit securely. When the sound skips at the same portion even when the car is stopped, the problem lies with the CD.
Cannot play an MP3 file.	Not conforming to ISO 9660 Level 1/2.	Use a medium conforming to ISO 9660 Level 1/2.
	The MP3 file has no or invalid filename extension.	Add the ".MP3" extension to the MP3 file name.
	The media is scratched or dirty.	Clean the media, referring to the section on "Cleaning CDs" (see p.8).
Noise or no sound generated when an MP3 file is played.	The file has the MP3 filename extension while it is not an MP3 file.	Do not use the ".MP3" extension in non-MP3 files.
Takes time before the unit starts playing MP3 files.	The medium contains many folders, files, and hierarchical levels.	The unit checks all files on the loaded medium first. If the medium has many files recorded, it may take a long time for the unit before it starts playing MP3 files.
Fails to play MP3 files in the intended order.	The MP3 files were not written by the CD writer in the order in which you wanted them to be played.	Depending on the CD writer, you may be able to set the order in which MP3 files are to be played by writing them onto a medium with their file names beginning with play sequence numbers such as "01" to "99".
The sound skips when an MP3 file is being played.	The media is scratched or dirty.	Clean the media, referring to the section on "Cleaning CDs" (see p.8).

The following messages are displayed when certain problems are occurring in your system. Take the recommended actions.

EJECT	No disc magazine has been loaded in the changer. The disc magazine is not completely loaded. ⇒ Load the disc magazine properly.
NO DISC	No disc has been loaded in the disc magazine. ⇒ Load a disc into the disc magazine.

NO NAME	<ul style="list-style-type: none"> • An attempt was made to display the name of the station being received but it was not set in memory. • An attempt was made to display the name of the disc being played but it was not set in memory.
NO TEXT	An attempt was made to display the track/disc title of the CD during play, but the CD has no texts.
ERROR 04	<p>No disc has been loaded in the disc magazine.</p> <p>⇒ Load a disc into the disc magazine.</p> <p>The CD is quite dirty. The CD is upside-down. The CD is scratched a lot.</p> <p>⇒ Clean the CD and load it correctly.</p>
ERROR 77	<p>The unit is malfunctioning for some reason.</p> <p>⇒ Press the reset button on the unit. If the "ERROR 77" code does not disappear, consult your nearest service center.</p>
ERROR 99	<p>Something is wrong with the disc magazine. Or the unit is malfunctioning for some reason.</p> <p>⇒ Check the disc magazine. And then press the reset button on the unit. If the "ERROR 99" code does not disappear, consult your nearest service center.</p>
HOLD	<p>The protective circuit in the unit activates when the temperature inside the automatic disc changer exceeds 60°C (140°F), stopping all operation.</p> <p>⇒ Cool down the unit by opening the windows or turning on the air conditioner. As the temperature falls below 60°C (140°F), the disc will start playing again.</p>
H HOLD	<p>The protective circuit in the unit activates when the temperature inside the unit exceeds 60°C (140°F), stopping all operation.</p> <p>⇒ Cool down the unit by opening the windows or turning on the air conditioner. As the temperature falls below 60°C (140°F), the disc will start playing again.</p>
	<p>The CD player is malfunctioning.</p> <p>⇒ Eject the CD and try inserting it again.</p> <p>Contact the Kenwood dealer if this indicator continues blinking or the CD cannot be ejected.</p>
BUS-E50	More than two center units are connected.
BUS-W02	<p>The number switches of two disc changers connected are set to the same number.</p> <p>⇒ You can use without any problem, by setting a switch number of one disc changer to "1" and another to "2".</p>
BUS-W08	More than two TV monitors are connected at the BUS.
READING	<p>The unit is reading the data on the disc.</p> <p>⇒ Normal play will be performed after completion of reading the data on the disc.</p>
CD-ROM AREA	<p>The unit is replaying the data area on the CD-ROM.</p> <p>⇒ You can not hear sound during this indication appears.</p>
Cannot display format	The unit failed to read the MP3 folder name and file name.

Specifications

Specifications subject to change without notice.

FM tuner section

Frequency range (200 kHz space)	87.9 MHz – 107.9 MHz
Usable sensitivity (S/N = 30dB)	9.3dBf (0.8 μ V/75 Ω)
Quieting Sensitivity (S/N = 50dB)	15.2dBf (1.6 μ V/75 Ω)
Frequency response (\pm 3.0 dB)	30 Hz – 15 kHz
Signal to Noise ratio (MONO)	75 dB
Selectivity (\pm 400 kHz)	\geq 80 dB
Stereo separation (1 kHz)	40 dB

AM tuner section

Frequency range (10 kHz space)	530 kHz – 1700 kHz
Usable sensitivity (S/N = 20dB)	28 dB μ (25 μ V)

CD player section

Laser diode	GaAlAs (λ =780 nm)
Digital filter (D/A)	8 Times Over Sampling
D/A Converter	8 level $\Delta\Sigma$
Spindle speed	200 – 500 rpm (CLV)
Wow & Flutter	Below Measurable Limit
Frequency response (\pm 1 dB)	10 Hz – 20 kHz
Total harmonic distortion (1 kHz)	0.01 %
Signal to Noise ratio	96 dB (1 kHz)
Dynamic range	95 dB
Channel separation	90 dB
MP3 decoder	MPEG-1.0 Audio Layer-3 compliant

Audio section

Maximum output power	45 W \times 4
Full bandwidth power (at less than 1% THD)	22 W \times 4
Tone action	
Bass:	100 Hz \pm 10 dB
Treble:	10 kHz \pm 10 dB
Preout level / Load	1500 mV/10 k Ω
Preout impedance	\leq 600 Ω

General

Operating voltage	14.4 V (11 – 16 V allowable)
Current consumption	10 A
Installation size (W \times H \times D)	178 \times 50 \times 160 mm (7 \times 1-15/16 \times 6-5/16 in.)
Weight	1.6 kg (3.5 Lbs)

KENWOOD

Free Manuals Download Website

<http://myh66.com>

<http://usermanuals.us>

<http://www.somanuals.com>

<http://www.4manuals.cc>

<http://www.manual-lib.com>

<http://www.404manual.com>

<http://www.luxmanual.com>

<http://aubethermostatmanual.com>

Golf course search by state

<http://golfingnear.com>

Email search by domain

<http://emailbydomain.com>

Auto manuals search

<http://auto.somanuals.com>

TV manuals search

<http://tv.somanuals.com>