

KENWOOD

DVD/VCD/CD PLAYER

DVF-3070

INSTRUCTION MANUAL

KENWOOD CORPORATION



B60-5357-08 00 (E/X/Y) © 02/12

Before applying power

 **Caution : Read this page carefully to ensure safe operation.**





Units are designed for operation as follows.

- Europe AC 230 V only
- Australia AC 240 V only
- Other countries AC 110 – 240 V

Safety precautions

 **Caution : Read this page carefully to ensure safe operation.**

WARNING : TO PREVENT FIRE OR ELECTRIC SHOCK, DO NOT EXPOSE THIS APPLIANCE TO RAIN OR MOISTURE.

	<p>CAUTION RISK OF ELECTRIC SHOCK DO NOT OPEN</p>		<p>CAUTION: TO REDUCE THE RISK OF ELECTRIC SHOCK, DO NOT REMOVE COVER (OR BACK). NO USER-SERVICEABLE PARTS INSIDE. REFER SERVICING TO QUALIFIED SERVICE PERSONNEL.</p>
	<p>THE LIGHTNING FLASH WITH ARROWHEAD SYMBOL, WITHIN AN EQUILATERAL TRIANGLE, IS INTENDED TO ALERT THE USER TO THE PRESENCE OF UNINSULATED "DANGEROUS VOLTAGE" WITHIN THE PRODUCT'S ENCLOSURE THAT MAY BE OF SUFFICIENT MAGNITUDE TO CONSTITUTE A RISK OF ELECTRIC SHOCK TO PERSONS.</p>		
	<p>THE EXCLAMATION POINT WITHIN AN EQUILATERAL TRIANGLE IS INTENDED TO ALERT THE USER TO THE PRESENCE OF IMPORTANT OPERATING AND MAINTENANCE (SERVICING) INSTRUCTIONS IN THE LITERATURE ACCOMPANYING THE APPLIANCE.</p>		

The marking of products using lasers (For countries other than U.S.A. and U.S.-Military)

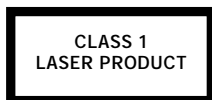

CAUTION

VISIBLE AND INVISIBLE LASER RADIATION WHEN OPEN. DO NOT STARE INTO THE BEAM OR VIEW DIRECTLY WITH OPTICAL INSTRUMENTS.
DO NOT PRESS ON THIS SURFACE

The marking this product has been classified as Class 1. It means that there is no danger of hazardous radiation outside the product.

Location: Back panel

Inside this laser product, a laser diode classified as Class 2 laser radiation is contained as alerted by the internal caution label shown above. Do not stare into beam or view directly with optical instruments.

Location: DVD laser pick-up unit cover inside this product

Unpacking

Unpack the unit carefully and make sure that all the accessories are present.

If any accessories are missing, or if the unit is damaged or fails to operate, notify your dealer immediately. If the unit was shipped to you directly, notify your shipper immediately. Kenwood recommends that you retain the original carton and packing materials in case you need to move or ship the unit in the future.

Keep this manual handy for future reference.

Accessories

Please confirm that the following accessories are present.

Audio video cord (Red, White, Yellow) ...(1)

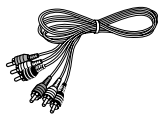

Remote control unit ...(1)

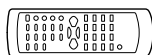

Batteries (R6/"AA" -size) ...(2)

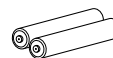

Coaxial cable ...(1)







Please read all of the safety and operating instructions before operating this appliance. Adhere to all warnings on the appliance and in the instruction manual. Follow all the safety and operating instructions. These safety and operating instructions should be retained for future reference.

- 1. Power sources** – The appliance should be connected to a power supply only of the type described in the instruction manual or as marked on the appliance. If you are not sure of the type of power supply to your home, consult your appliance dealer or local power company. For appliances intended to operate from battery power, or other sources, refer to the instruction manual.
- 2. Power-cord protection** – Power-supply cords should be routed so that they are not likely to be walked on or pinched by items placed upon or against them, pay particular attention to cords at plugs, convenience receptacles, and the point where they exit from the appliance.
- 3. Ventilation** – Slots and openings in the cabinet are provided for ventilation and to ensure reliable operation of the appliance and to protect it from overheating, and these openings must not be blocked or covered. The appliance should be situated so that its location or position does not interfere with its proper ventilation.
To maintain good ventilation, do not put records or a table-cloth on the appliance. Place the appliance at least 10 cm away from the walls.
Do not use the appliance on a bed, sofa, rug or similar surface that may block the ventilation openings. This appliance should not be placed in a built-in installation such as a bookcase or rack unless proper ventilation is provided or the manufacturer's instructions have been adhered to.
- 4. Water and moisture** – The appliance shall not be exposed to dripping and splashing - for example, near a bathtub, washbowl, kitchen sink, laundry tub, in a wet basement, or near a swimming pool, etc. Do not place an object containing liquid, such as a flower vase, on the appliance.
- 5. Temperature** – The appliance may not function properly if used at extremely low, or freezing temperatures. The ideal ambient temperature is above +5°C (41°F).
- 6. Heat** – The appliance should be situated away from heat sources such as radiators, heat registers, stoves, or other appliances (including amplifiers) that produce heat. Do not place a flaming object, such as a candle or lantern, on or near the appliance.
- 7. Electric shock** – Care should be taken so that objects do not fall and liquid is not spilled into the enclosure through openings. If a metal objects, such as a hair pin or a needle, comes into contact with the inside of this appliance, a dangerous electric shock may result. For families with children, never permit children to put anything, especially metal, inside this appliance.
- 8. Enclosure removal** – Never remove the enclosure. If the internal parts are touched accidentally, a serious electric shock might occur.
- 9. Cleaning** – Unplug this appliance from the wall outlet before cleaning. Do not use volatile solvents such as alcohol, paint thinner, gasoline, or benzine, etc. to clean the cabinet. Use a clean dry cloth.

- 10. Lightning** – For added protection for this appliance during a lightning storm, or when it is left unattended and unused for long periods of time, unplug it from the wall outlet and disconnect the antenna or cable system. This will prevent damage to the appliance due to lightning and power-line surges.
- 11. Abnormal smell** – If an abnormal smell or smoke is detected, immediately turn the power OFF and unplug the appliance from the wall outlet. Contact your dealer or nearest service center.
- 12. Damage requiring service** – The appliance should be serviced by qualified service personnel when:
 - A.** The power-supply cord or the plug has been damaged.
 - B.** Objects have fallen, or liquid has been spilled into the appliance.
 - C.** The appliance has been exposed to rain or water.
 - D.** The appliance does not appear to operate normally by following the instruction manual. Adjust only those controls that are covered by the instruction manual as an improper adjustment of other controls may result in damage and will often require extensive work by a qualified technician to restore the appliance to its normal operation.
 - E.** The appliance has been dropped, or the enclosure damaged.
 - F.** The appliance exhibits a marked change in performance.
- 13. Servicing** – The user should not attempt to service the appliance beyond that described in the instruction manual. All other servicing should be referred to qualified service personnel.
- 14. Power lines** – An outside antenna system should not be located in the vicinity of overhead power lines or other electric light or power circuits, or where it can fall into such power lines or circuits. When installing an outside antenna system, extreme care should be taken to keep from touching such power lines or circuits as contact with them might be fatal.
- 15. AC outlets** – Do not connect other audio equipment with a power consumption larger than that specified to the AC outlet on the rear panel. Never connect other electrical appliances, such as an iron or toaster, to it to prevent fire or electric shock.
- 16. Overloading** – Do not overload wall outlets, extension cords, or integral convenience receptacles as this can result in a risk of fire or electric shock.
- 17. Attachment** – Do not use attachments not recommended by the appliance manufacturer as they may cause hazards.
- 18. Replacement parts** – When replacement parts are required, be sure the service technician has used replacement parts specified by the manufacturer or have the same characteristics as the original parts. Unauthorized substitutions may result in fire, electric shock, or other hazards.
- 19. Safety check** – Upon completion of any service or repairs to this appliance, ask the service technician to perform safety checks to determine that the appliance is in proper operating condition.

Special features

This document classifies the applications of each feature using the following marks.

-  : Description of a feature that can be used with DVD.
-  : Description of a feature that can be used with CD.
-  : Description of a feature that can be used with VCD.

 **Higher video quality than S-VHS video and LaserDisc**

 **Higher audio quality than music CD**



   **On screen Display (OSD)**

MP3 and JPEG files playback

Contents

Caution : Read the pages marked  carefully to ensure safe operation.

Preparations

Introduction	2
 Before applying power	2
 Safety precautions	2
 IMPORTANT SAFEGUARDS	4
Special features and Contents	5
Special features	5
Contents	5
Discs information	6
Types of playable discs	6
Unplayable discs	6
Icons on the DVD VIDEO discs	6
Region Codes	7
Region codes in the world	7
Video formats	8
Important items	9
Maintenance	9
Reference	9
System Connections	10
Connecting to a TV with video (composite) input terminal	10
Connecting to a TV with S-video input terminal	10
Connecting to a TV with SCART input terminal (For Europe)	11
Connecting to a TV with Component input terminals (For some areas)	11
Connecting to an Audio component	11
Controls and indicators	12
Operation of remote control unit	13
Set Up functions	14
Preparation for Set Up	14
Set up menu	14
Select TV Display	16
Select Picture Mode	16
Select ANGLE mark ON or OFF	17
Select OSD Language	17
Select CAPTIONS ON or OFF (NTSC only)	18
Select Screen Saver on or off	18
Select Audio Output	19
Select LPCM Output	19
Select Dynamic Range	20
Select VIDEO Output	21
Select Audio Language	21

Select Subtitle Language	22
Select Disc Menu Language	22
Select Parental level	23
Change Password	23
Put back to the Default Setting	24
DVD menu language code list	25

Operations

Playback of disc	26
Basic play	26
Disc playback features	27
On screen display	28
Various playback functions	29
Select Audio Language	29
Select the Audio channel	29
Select Subtitle Language	29
Select Subtitle on or off	29
Select Camera angle	30
Random play	30
Repeat play	31
A-B Repeat play	31
Using Bookmarks	32
Using IntroScan function	32
Program play	33
Menu playback	36
Hierarchical structure of VCD menus	36
Playback without using the menu playback function (In case of a P.B.C.-compatible VCD) (To P.B.C. On or Off)	37
MP3/JPEG media playback	38
Guidance of MP3/JPEG	38
Playing back MP3/JPEG files	39
Selects the files to be played back directly	40
Rotating a picture (JPEG files only)	40
MP3/JPEG Repeat play	41
MP3/JPEG Random play	41
MP3/JPEG program playback	42

Knowledge

In case of difficulty	44
Specifications	46

Types of playable discs

The system using this unit does not only play music from CD but can also play the discs listed below to offer you high-quality entertainment of video of movies and live concerts.

Playable Disc	DVD VIDEO		CD (CD-R, CD-RW)		VCD (SVCD*)	
Logo mark on disc						
Disc size	 8cm	 12cm	 8cm	 12cm	 8cm	 12cm
Played sides	One or both	One or both	One side only	One side only	One side only	One side only
Contents	Video + Audio Approx. 41 min. (1 side, 1 layer) Approx. 75 min. (1 side, 2 layers) Approx. 82 min. (2 sides, 1 layer) Approx. 150 min. (2 sides, 2 layers)		Approx. 133 min. (1 side, 1 layer) Approx. 242 min. (1 side, 2 layers) Approx. 266 min. (2 sides, 1 layer) Approx. 484 min. (2 sides, 2 layers)		Max. 20 min. Max. 74 min. (In case of an SVCD, the possible playback time becomes shorter.)	
	Audio		Max. 20 min., digital Max. 80 min., digital			

MP3 media and JPEG picture CD those can be played back with this equipment (CD-R, CD-RW)

- * This unit can play SVCDs, but some functions will not work.
- This unit can play DVD-R, DVD+R, DVD-RW, and DVD+RW discs, but depending on the recording unit, the disc manufacturer, etc., playback sometimes may not be possible.
- This unit may also be incapable of playing certain CD-R/RW discs depending on their properties, recording conditions, etc.

Unplayable discs

This player cannot play back any of the following discs.

<p>DVD AUDIO discs DVD-ROM discs DVD-RAM discs SACD discs CD-ROM discs (Except MP3 and JPEG discs [ISO 9660 level 1])</p> <ul style="list-style-type: none"> • A DVD VIDEO disc with a region code which does not match this unit or without a region code. For details, see "Region Codes". • When the video format of a disc differs from that of the TV in use, the disc cannot be played normally. For details, see "Video Formats". 	<p>VSD discs CDV discs (Only the audio part can be reproduced.) CD-G/CD-EG/CD-EXTRA discs (Only the audio can be reproduced.) Photo CD discs (Never attempt to play them.)</p>
--	--

Icons on the DVD VIDEO discs

Icon	Description
	Indicates the region code where the disc can be played.
	Number of voice languages recorded with the audio function. The number in the icon indicates the number of voice languages. (Max. 8 languages)
	Number of subtitle languages recorded with the subtitle function. The number in the icon indicates the number of subtitle languages. (Max. 32 languages)
	Number of angles provided by the angle function. The number in the icon indicates the number of angles. (Max. 9 angles)
	Aspect ratios that can be selected. "NORMAL/LB" stands for Letter Box and "NORMAL/PS" for Pan/Scan. In the example on the left, the 16:9 video can be converted into letter box video.

Every player of this model has a certain region code assigned to it based on the country where the player is used. When the player is used to play back DVD VIDEO discs, it can only play the DVD VIDEO discs carrying the region codes matching the region code of the player.

The region code for this player is described on the rear panel of the player.

Region codes in the world

The DVD players are given a region code according to the country or area it is marketed, as shown in the following map.

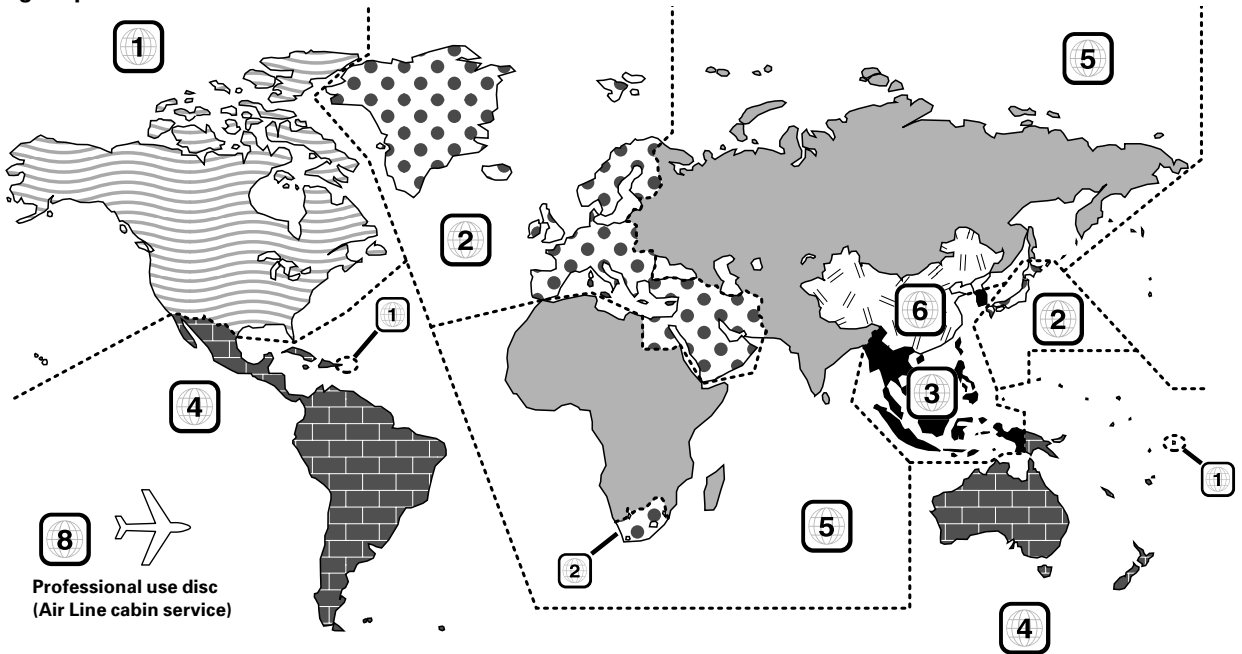

Region codes of the DVD VIDEO discs that can be played with this player

This player can play back a DVD VIDEO disc which carries the corresponding code to the region code of the player shown in the table above, a marking containing the region code of the player or the "ALL" marking shown below. Even when a DVD VIDEO disc does not carry any indication of the region code, it may sometimes be unable to be played on this player due to certain restrictions.



Restrictions due to difference between discs

Some DVD and VCD discs can be played only in certain playback modes according to the intentions of the software producers. As this player plays discs according to their intentions, some functions may not work as intended by you. Please be sure to read the instructions provided with each disc. When an inhibition icon is displayed on the TV screen connected to the player, it indicates that the disc being played is under the restriction as described above.

Inhibition icon



The TV picture display and disc signal systems can be divided roughly into two TV formats (NTSC and PAL).

They are variable depending on countries and areas.

TV formats of major countries

TV Format	Major Countries & Areas
NTSC	Japan, Taiwan, Korea, USA, Canada, Mexico, Philippines, Chile, etc.
PAL	China, U.K., Germany, Australia, New Zealand, Kuwait, Singapore, etc.

(For Europe and Australia)

This unit has a function for changing the video format according to the TV type. () The initial setting of this unit for "TV Type" is PAL. Please confirm the type of your TV.

(For other countries)

This unit has a function for changing the video format according to the TV type. () The initial setting of this unit for "TV Type" is NTSC. Please confirm the type of your TV.

Checking the Video Format ("Select TV Type" →)

Check the video format of the TV to be used

When the video formats are different :

Try playing the disc. If the video formats of the disc and TV do not match, the played video may be black and white or become as shown below.



Top and bottom edges are not displayed.



Top and bottom areas are dark.



Picture turbulence due to sync unmatching.

Maintenance

Maintenance of the unit

When the front panel or case becomes dirty, wipe with a soft, dry cloth. Do not use thinner, benzine, alcohol, etc. for these agents may cause discoloration.

In regard to contact cleaner

Do not use contact cleaners because it could cause a malfunction. Be specially careful not to use contact cleaners containing oil, for they may deform the plastic component.

Reference

Disc handling precautions

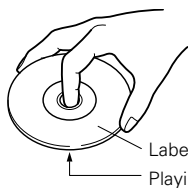

Handling

Hold the disc so that you do not touch the playing surface.

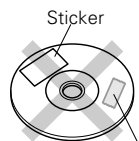

Do not attach paper or tape to either the playing side or the label side of the disc.

Sticky paste

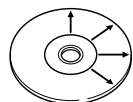

Cleaning

If there are fingerprint marks or foreign matter found on the disc, lightly wipe the disc with a soft cotton cloth (or similar) from the center of the disc outwards in a radial manner.

Storage

When a disc is not to be played for a long period of time, remove it from the player and store it in its case.

Never play a cracked or warped disc

During playback, the disc rotates at high speed in the player. Therefore, to avoid danger, never use a cracked or deformed disc or a disc repaired with tape or adhesive agent. Please do not use discs which are not round because they may cause malfunction.

Disc accessories

The disc accessories (stabilizer, protection sheet, protection ring, etc.) which are marketed for improving the sound quality or protecting discs as well as the disc cleaner should not be used with this system because they may cause malfunction.

Note related to transportation and movement

Before transporting or moving this unit, carry out the following operations.

1. Set the POWER ON/OFF switch to the ON without loading a disc.
2. Wait a few seconds and verify that the display shown appears.

NO DISC

3. Set the POWER ON/OFF switch to OFF.

Caution on condensation

Condensation (of dew) may occur inside the unit when there is a great difference in temperature between this unit and the outside. This unit may not function properly if condensation occurs. In this case, leave the unit for a few hours and restart the operation after the condensation has dried up.

Be specially cautious against condensation in the following circumstances:

When this unit is carried from one place to another across a large difference in temperature, when the humidity in the room where this unit is installed increases, etc.

Make connections as shown below.

When connecting the related system components, refer also to the instruction manuals of the related components.

Caution:

Do not plug in the power lead until all connections are completed.

Malfunction of microcomputer
 If operation is not possible or erroneous display appears even though all connections have been made properly, reset the microcomputer referring to "In case of difficulty". — 44

CAUTION
 Be sure to adhere to the following, or proper ventilation will be blocked causing damage or fire hazard.

- Do not place any objects impairing heat radiation onto the top of the unit.
- Leave some space around the unit (from the largest outside dimension including projection) equal to or greater than, shown below.

Top panel : 50 cm Side pannel : 10 cm Back panel : 10 cm

Connecting to a TV with video (composite) input terminal

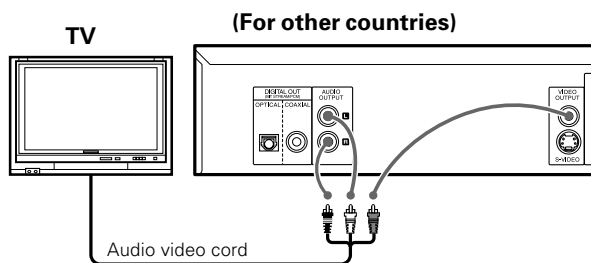
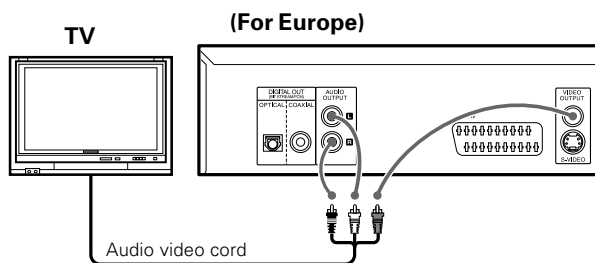

Connecting to a TV with S-video input terminal

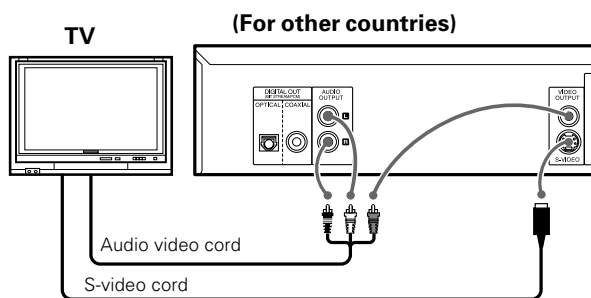
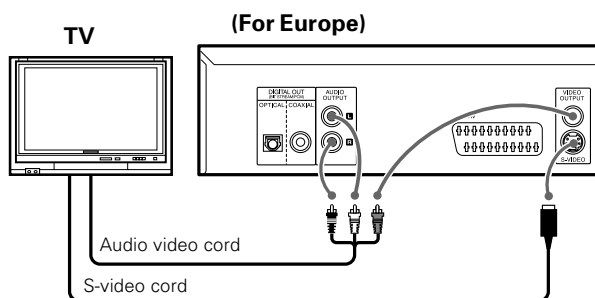

Connecting to a TV with SCART input terminal (For Europe)

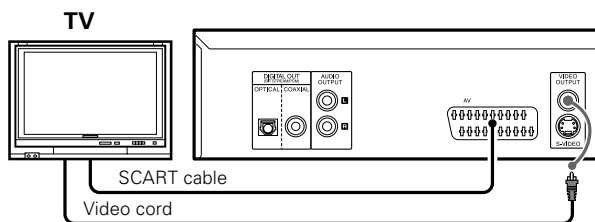

Note When connecting to the S-VIDEO terminal, the SCART terminal, or the COMPONENT VIDEO OUTPUT terminal of this unit, also connect the composite video cord. In addition, perform the VIDEO OUTPUT setting at the SETUP MENU screen. ("Select VIDEO OUTPUT" — 20)
 When SCART (or COMPONENT) terminal connection is made without connecting the composite video cord and this unit is set to S-VIDEO, the monitor will not display correctly. (The setting cannot be changed to RGB or COMPONENT)

DTS disclaimer clause
 When playing DTS-encoded (CDs, DVDs), excessive noise will be exhibited from the analog stereo outputs. To avoid possible damage to the audio system, the consumer should take proper precautions when the analog stereo outputs of the DVD player is connected to an amplification system.
 To enjoy DTS Digital Surround™ playback, an external 5.1 channel DTS Digital Surround™ decoder system must be connected to the digital output (S/P DIF, AES/EBU, or TosLink) of the DVD player.

Preparations

Connecting to a TV with Component input terminals (For some areas)

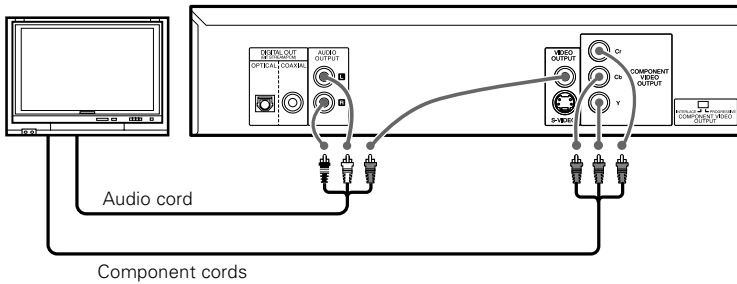

[For some areas]

Select the scanning method of the Component Video output using the COMPONENT VIDEO OUTPUT switch on the rear panel.

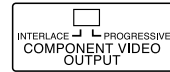

INTERLACE: Scanning method is fixed at interlaced scanning.

PROGRESSIVE: When progressive scanning is unavailable with certain discs, the scanning method is switched automatically to interlaced scanning. When the scanning method is changed, the scanning status will be displayed for a few seconds.

Connecting to an Audio component

For playback of DTS audio, please connect an AV receiver or an AV amplifier which can decode DTS by digital connection.

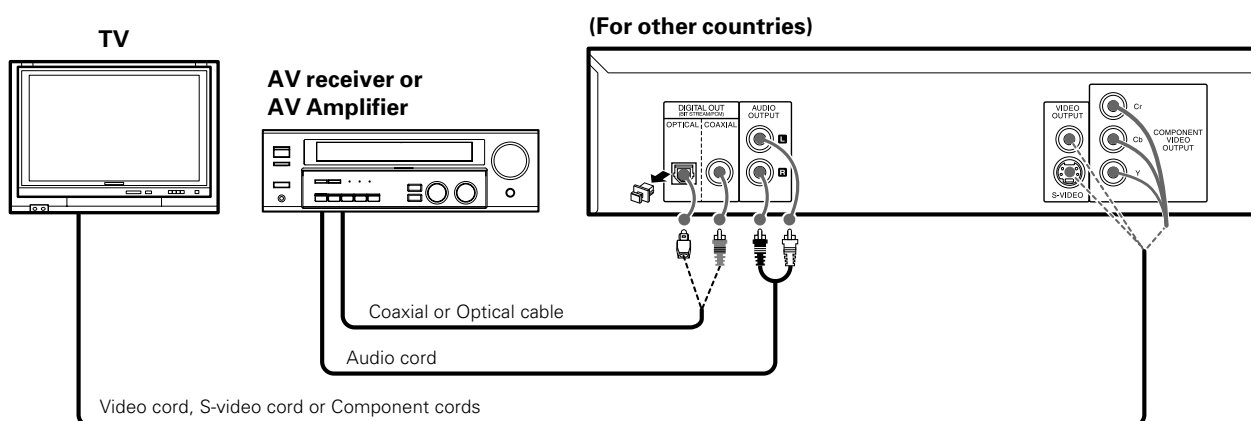
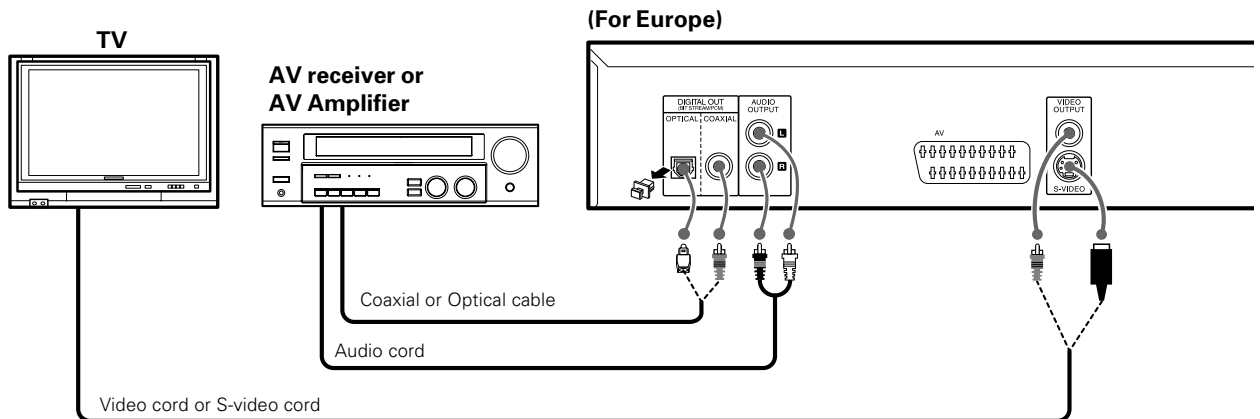

When connecting to the S-VIDEO terminal, the SCART terminal, or the COMPONENT VIDEO OUTPUT terminal of this unit, also connect the composite video cord. In addition, perform the VIDEO OUTPUT setting at the SETUP MENU screen. ("Select VIDEO OUTPUT" - [20])

When SCART (or COMPONENT) terminal connection is made without connecting the composite video cord and this unit is set to S-VIDEO, the monitor will not display correctly. (The setting cannot be changed to RGB or COMPONENT)



1. In case an associated system component is connected, also read the instruction manual of the component.
2. Insert the optical-fiber cable straight into the connector until it clicks.
3. Never bend or bundle the optical-fiber cable.

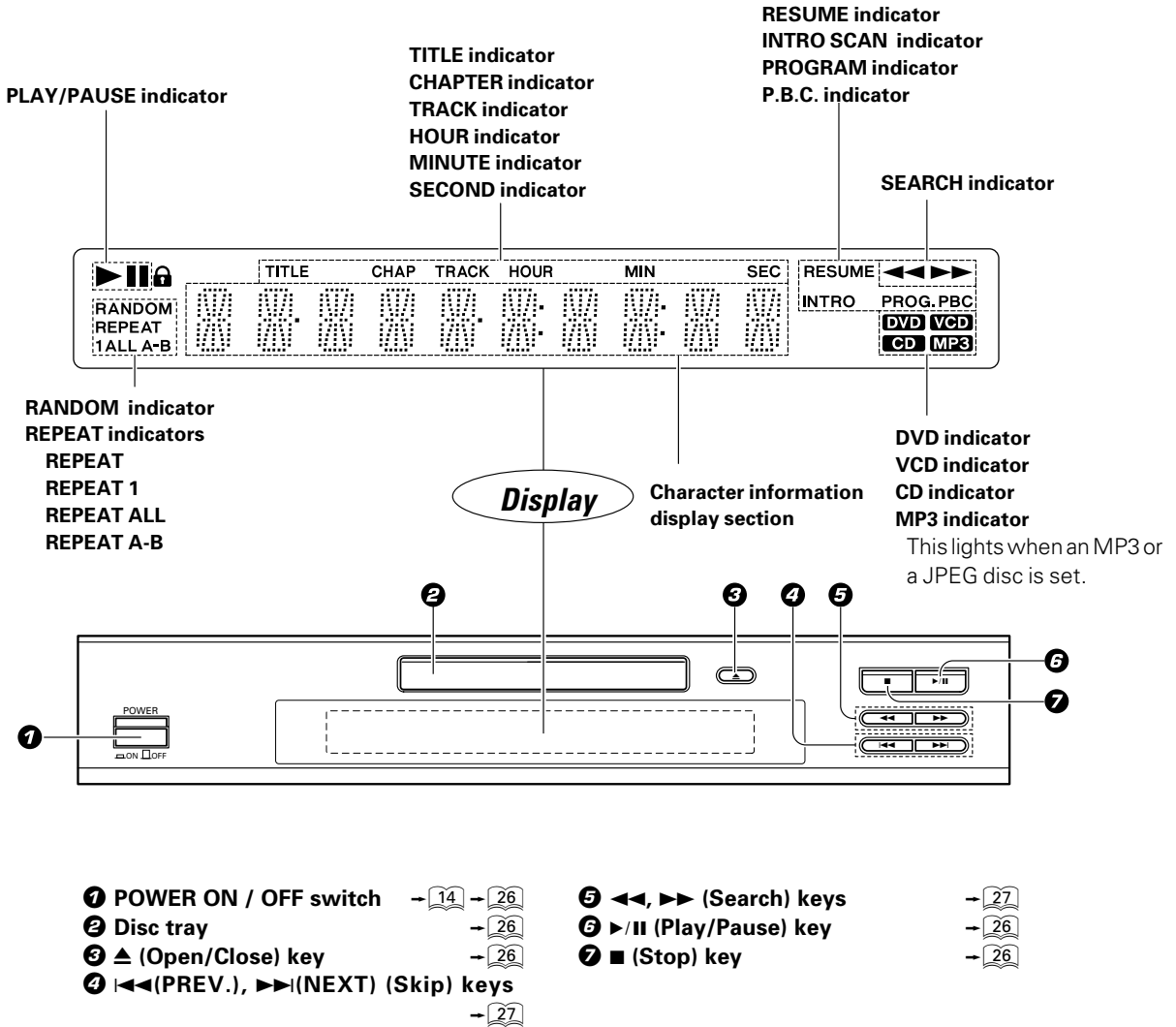

CAUTION

The power in this equipment will not be completely cut off from the AC wall outlet when the main switch is turned OFF.

DIMMER function

The display brightness of the main unit can be changed.

DIMMER



Switching as shown below is done each time the DIMMER key on the remote control is pressed.

- ① Bright
- ② Dim 1
- ③ Dim 2

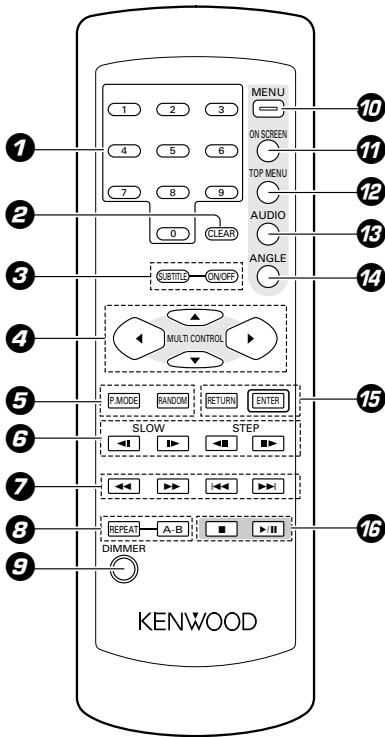

Model : RC-D0307 (Infrared ray system)

The keys on the remote control unit with the same names as on the main unit have the same function as the keys on the main unit.

- | | | | |
|-----------------------------------|-----------------------|-------------------------|-------------------------------|
| 1 Numeric keys | - 23 - 28 | 8 REPEAT key | - 30 - 31 - 33 - 39 - 41 |
| 2 CLEAR key | - 42 | A-B Repeat key | - 31 |
| 3 SUBTITLE key | - 29 | 9 DIMMER key | - 12 |
| | (SUBTITLE) ON/OFF key | 10 MENU key | - 16 - 24 - 26 |
| 4 Cursor Up (▲), Down (▼), | - 16 - 24 | 11 ON SCREEN key | - 28 |
| Left (◀) and Right (▶) keys | - 16 - 24 | 12 TOP MENU key | - 26 - 32 |
| 5 P.MODE key | - 33 - 42 | 13 AUDIO key | - 29 |
| RANDOM key | - 30 - 32 - 41 | 14 ANGLE key | - 30 |
| 6 SLOW (Back slow/ | - 28 | 15 RETURN key | - 14 |
| Forward slow) keys | - 27 | ENTER key | - 16 - 24 - 33 - 34 - 39 - 40 |
| 7 STEP (Back step/ | - 27 | 16 (Stop) key | - 26 |
| Forward step) keys | - 27 | ▶/ (Play/Pause) key | - 26 |
| ◀◀ (PREV.) key/▶▶ | - 27 | | |
| (NEXT) key (Skip key) | - 27 | | |

Preparations

Loading batteries

1 Remove the cover.

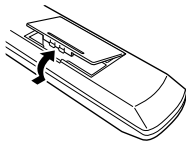

2 Insert batteries.

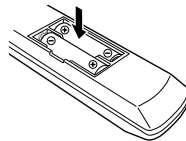

- Insert two R6/LR6 ("AA"-size) batteries following the polarity indications.

3 Close the cover.

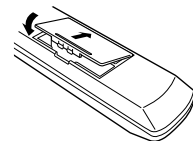

Operation

Insert the power plug into a power outlet, press the POWER ON / OFF switch of the main unit to ON, then press the desired remote control key.

- When pressing more than one remote control keys successively, press the keys securely by leaving an interval of 1 second or more between pressing of keys.

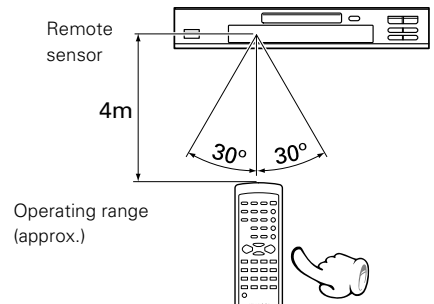

1. The provided batteries are intended for use in operation checking, and their service life may be short.
2. When the remote controllable distance becomes short, replace both of the batteries with new ones.
3. If direct sunlight or the light of a high-frequency fluorescent lamp (inverter type, etc.) is incident to the remote sensor, malfunction may occur. In such a case, change the installation position to avoid malfunction.

Preparation for Set Up

❶ Set the POWER ON/OFF switch to the ON () position.

- After the power is switched ON, there is a delay of about 3 seconds before the display is lit.

❷ Set TV Format according to the connected TV type. (Initial Settings –  8)

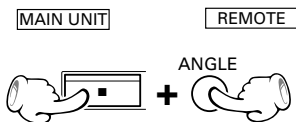

While no disc is inserted, hold the  (Stop) key on the main unit depressed and keep pressing the ANGLE key on the remote control. Each time these keys are being held down, the setting changes as follows.

- ① MULTI (NTSC/PAL switchable)
- ② NTSC
- ③ PAL

Set up menu

The SETUP functions are the following diverse functions. Please change them according to your use environment.

GENERAL SETUP

TV DISPLAY

This sets the screen size (4:3 or 16:9 aspect ratio) according to the connected TV.

NORMAL/PS (Pan Scan)

Choose this setting if you want the movie to fill the entire screen of your TV. You won't see part of the picture (particularly the right and left edge).

Some disc produced in a wide screen format can't be cropped in this fashion, which means the black bars would appear at the top and the bottom of the screen.

NORMAL/LB (Letter Box)

Choose this setting if you would prefer to see movies in their original aspect ratio. You will see the entire frame of the movie, but it will occupy a smaller portion of the screen. This setting may result in the movie appearing with black bars at the top and bottom of the screen.

WIDE

Choose this setting if your DVD player is connected to a widescreen TV.

PIC MODE

This adjusts the screen quality according to the material being played back.

AUTO

The picture quality is adjusted automatically.

FILM

Choose this setting to reproduce the picture quality of FILM material.

VIDEO

Choose this setting to reproduce the picture quality of VIDEO material.

SMART

Choose this setting to reproduce progressive and interlaced materials with limited motion.

SSMART

Choose this setting to reproduce progressive and interlaced materials with motion (motion adaptive deinterlacing).

ANGLE MARK

When this is set to **ON**, the ANGLE mark () will be displayed when a multiangle scene is reached during playback of a DVD. (**OFF**)

OSD LANG

This switches the language for the on-screen display. (**ENGLISH**)

CAPTIONS (NTSC only)

This switches the CLOSED CAPTION ON or OFF. (**OFF**)

"closed caption" is a subtitle display system developed for hearing-impaired persons, but it is also a very effective system for learning foreign languages. When your TV is compatible with "closed caption" and you select **ON**, you can use the CLOSED CAPTION function.

SCR SAVER

This switches the screen saver ON or OFF. (**OFF**)

When **SCR SAVER** is **ON**, the screen saver function will operate after approx. 3 minutes have passed with a still picture (display of KENWOOD).

The items in are the initial set values.

How to use the RETURN key

When the RETURN key is pressed, the display returns to the MAIN PAGE.



AUDIO SETUP**AUDIO OUT**

This selects the format of the audio output from the **DIGITAL OUT** terminal.

SPDIF/RAW

Choose this when connecting to an amplifier with built-in Dolby digital or DTS decoder.

When a DVD recorded with Dolby digital or DTS is played back, a bitstream signal will be put out. When a disc recorded with linear PCM is played back, a linear PCM signal will be put out.

SPDIF/PCM

Choose this for PCM output.

When a DVD recorded with Dolby digital is played back, output will be made converted to 2-channel PCM. In case of a DVD recorded with DTS, output will be made as bitstream.

LPCM OUTPUT

This selects the clock frequency for linear PCM output.

LPCM 48k

Sets the linear PCM output to 48 kHz.

Even in case of 96 kHz digital signal, DVD will deliver 48 kHz signal out.

LPCM 96k

In case of 96 kHz digital signal, DVD will deliver 96 kHz signal out. In this case your receiver should control 96 kHz signal. Depending on the disc, output of a 96 kHz signal may be prohibited. In such a case, the output will be converted down to a 48 kHz signal.

DYNAMIC

At the time of Dolby digital DVD playback, the difference of the maximum volume and the minimum volume are compressed. Adjustment is possible in 8 steps, and the range is largest (compression ratio 0) at the time of "OFF" and smallest (large compression ratio) at the time of "FULL". (**OFF**)

PREFERENCES**VIDEO OUTPUT**

Choose "S-VIDEO" in case of connection to the **S-VIDEO** terminals on the rear, choose "RGB" in case of connection to the **AV** terminal or choose "COMPONENT" in case of connection to **COMPONENT** terminal. Output will not be made to the not selected terminals. (→**[10]**→**[11]**) (**S-VIDEO**)

AUDIO

Choose the language for the **AUDIO** output. (**ENGLISH** *)

SUB TITLE

Choose the language for **SUB TITLE**. (**ENGLISH** *)

DISC MENU

Choose the language for the menu recorded on the DISC. (**ENGLISH** *)

PARENTAL

This can restrict playback of adult-oriented DVD discs that you do not want to be seen by children. However, even when a DVD disc is marked "Adult-oriented" or so on the label, its viewing cannot be restricted unless the restriction level is recorded in the disc itself. (**8**)

Parental lock level:

Level 8: All DVDs can be played back.(Factory preset)

Level 7 to 2: DVDs for general audiences/children can be played back. (DVDs for adults are prohibited.)

Level 1: DVDs for children can be played back. (DVDs for adults/general audiences are prohibited.)

PASSWORD

The password for **PARENTAL** setting, change, cancellation, etc. is set.

DEFAULTS

This resets all settings, except for **PARENTAL** and **PASSWORD**, to the factory defaults.

When the language marked with an asterisk (*) is specified by the disc, that specification has priority.

Please refer to pages 14 and 15 for setup.

DVD VCD Select TV Display

- ① During stop mode, press MENU key on the remote.



- ② Press Cursor up/down (▲/▼) keys on the remote to select the GENERAL SETUP, then press the ENTER key to access the sub features

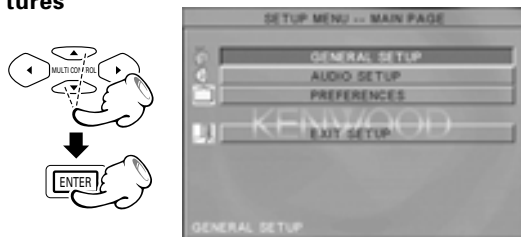

- ③ Press Cursor up/down (▲/▼) keys on the remote to select TV DISPLAY, then press the Cursor right (▶) key to access the sub features

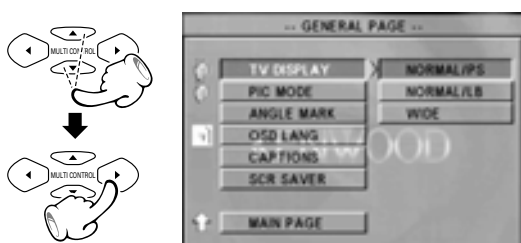

- ④ Press Cursor up/down (▲/▼) keys on the remote to select TV Display type, then press the ENTER key.

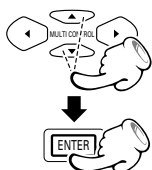

- ⑤ Press Cursor left (◀) key on the remote to return to previous menu.

- ⑥ Press Cursor up/down (▲/▼) keys on the remote to select MAIN PAGE, then press the ENTER key.

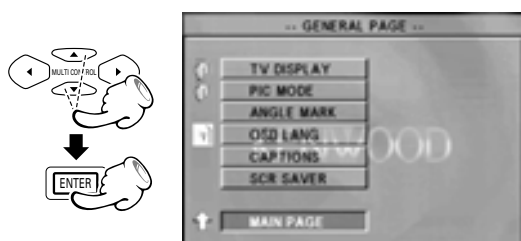

- ⑦ Press Cursor up/down (▲/▼) keys on the remote to select EXIT SETUP, then press the ENTER key.

DVD VCD Select Picture Mode

- ① During stop mode, press MENU key on the remote.



- ② Press Cursor up/down (▲/▼) keys on the remote to select the GENERAL SETUP, then press the ENTER key to access the sub features

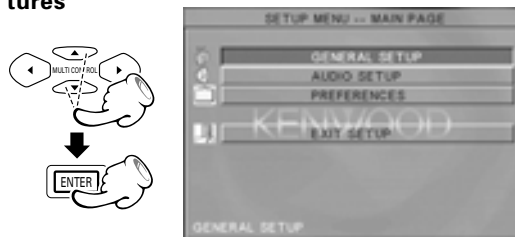

- ③ Press Cursor up/down (▲/▼) keys on the remote to select PIC MODE, then press the Cursor right (▶) key to access the sub features

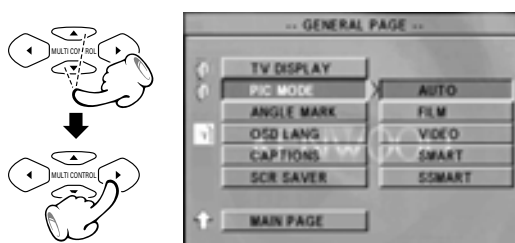

- ④ Press Cursor up/down (▲/▼) keys on the remote to select specific mode, then press the ENTER key.

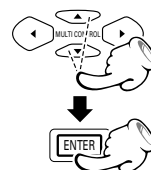

- ⑤ Press Cursor left (◀) key on the remote to return to previous menu.

- ⑥ Press Cursor up/down (▲/▼) keys on the remote to select MAIN PAGE, then press the ENTER key.

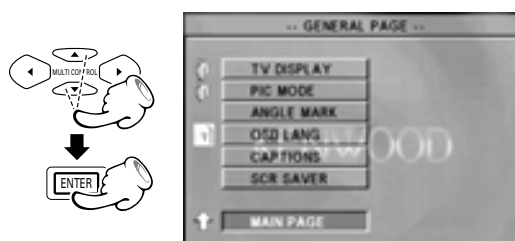

- ⑦ Press Cursor up/down (▲/▼) keys on the remote to select EXIT SETUP, then press the ENTER key.

Please refer to pages 14 and 15 for setup.

DVD Select ANGLE mark ON or OFF

- ① During stop mode, press MENU key on the remote.

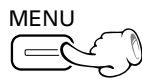

- ② Press Cursor up/down (▲/▼) keys on the remote to select the GENERAL SETUP, then press the ENTER key to access the sub features

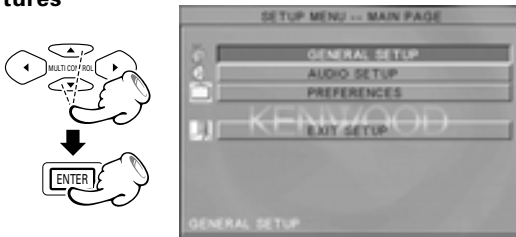

- ③ Press Cursor up/down (▲/▼) keys on the remote to select ANGLE MARK, then press the Cursor right (▶) key to access the sub features

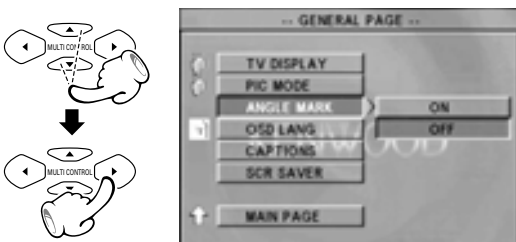

- ④ Press Cursor up/down (▲/▼) keys on the remote to select ON or OFF, then press the ENTER key.

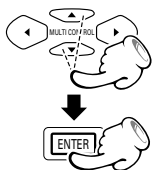

- ⑤ Press Cursor left (◀) key on the remote to return to previous menu.

- ⑥ Press Cursor up/down (▲/▼) keys on the remote to select MAIN PAGE, then press the ENTER key.

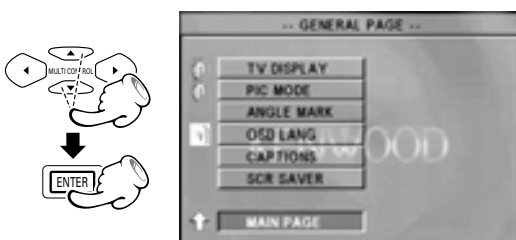

- ⑦ Press Cursor up/down (▲/▼) keys on the remote to select EXIT SETUP, then press the ENTER key.

DVD VCD CD Select OSD Language

- ① During stop mode, press MENU key on the remote.

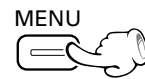

- ② Press Cursor up/down (▲/▼) keys on the remote to select the GENERAL SETUP, then press the ENTER key to access the sub features

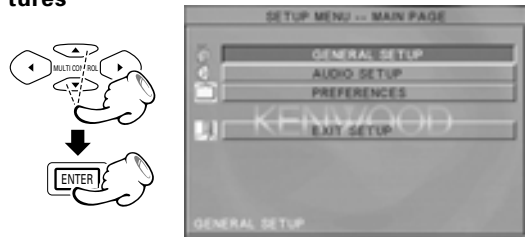

- ③ Press Cursor up/down (▲/▼) keys on the remote to select OSD LANG, then press the Cursor right (▶) key to access the sub features

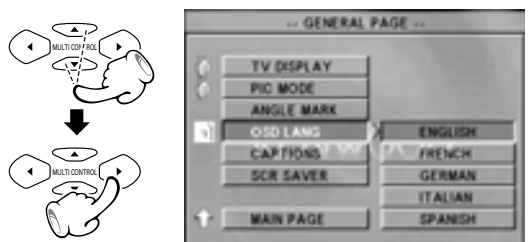

- ④ Press Cursor up/down (▲/▼) keys on the remote to select specific language, then press the ENTER key.

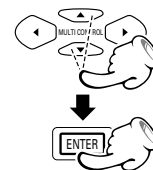

- ⑤ Press Cursor left (◀) key on the remote to return to previous menu.

- ⑥ Press Cursor up/down (▲/▼) keys on the remote to select MAIN PAGE, then press the ENTER key.

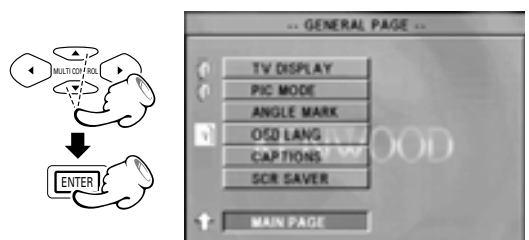

- ⑦ Press Cursor up/down (▲/▼) keys on the remote to select EXIT SETUP, then press the ENTER key.

Please refer to pages 14 and 15 for setup.

DVD Select **CAPTIONS ON or OFF** (NTSC only)

- ① During stop mode, press MENU key on the remote.



- ② Press Cursor up/down (▲/▼) keys on the remote to select the GENERAL SETUP, then press the ENTER key to access the sub features

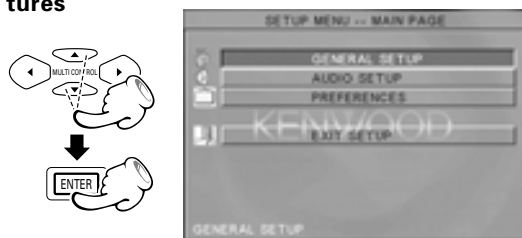

- ③ Press Cursor up/down (▲/▼) keys on the remote to select CAPTIONS, then press the Cursor right (▶) key to access the sub features

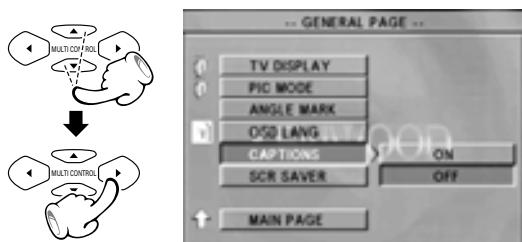

- ④ Press Cursor up/down (▲/▼) keys on the remote to select ON or OFF, then press the ENTER key.

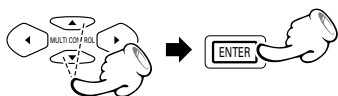

- ⑤ Press Cursor left (◀) key on the remote to return to previous menu.

- ⑥ Press Cursor up/down (▲/▼) keys on the remote to select MAIN PAGE, then press the ENTER key.

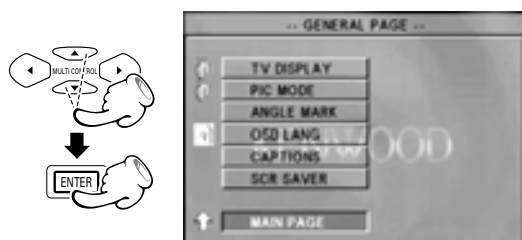

- ⑦ Press Cursor up/down (▲/▼) keys on the remote to select EXIT SETUP, then press the ENTER key.

DVD **VCD** **CD** Select **Screen Saver on or off**

- ① During stop mode, press MENU key on the remote.



- ② Press Cursor up/down (▲/▼) keys on the remote to select the GENERAL SETUP, then press the ENTER key to access the sub features

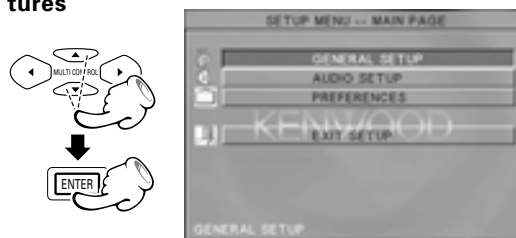

- ③ Press Cursor up/down (▲/▼) keys on the remote to select SCR SAVER, then press the Cursor right (▶) key to access the sub features

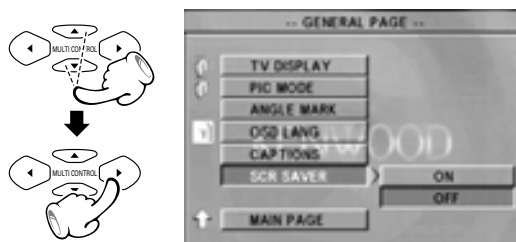

- ④ Press Cursor up/down (▲/▼) keys on the remote to select ON or OFF, then press the ENTER key.

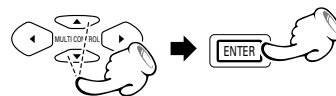

- ⑤ Press Cursor left (◀) key on the remote to return to previous menu.

- ⑥ Press Cursor up/down (▲/▼) keys on the remote to select MAIN PAGE, then press the ENTER key.

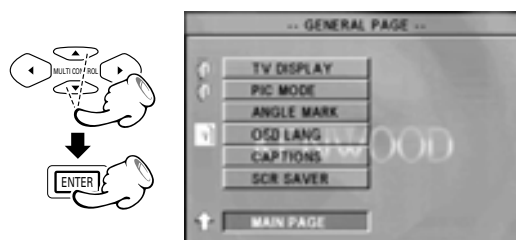

- ⑦ Press Cursor up/down (▲/▼) keys on the remote to select EXIT SETUP, then press the ENTER key.

Please refer to pages 14 and 15 for setup.

DVD Select Audio Output

- 1 During stop mode, press MENU key on the remote.



- 2 Press Cursor up/down (▲/▼) keys on the remote to select the AUDIO SETUP, then press the ENTER key to access the sub features

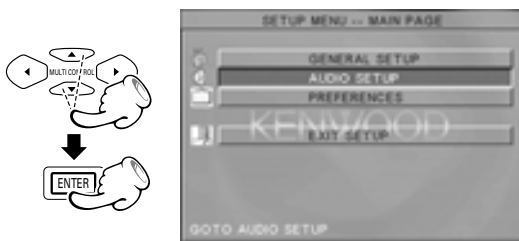

- 3 Press Cursor up/down (▲/▼) keys on the remote to select AUDIO OUT, then press the Cursor right (▶) key to access the sub features

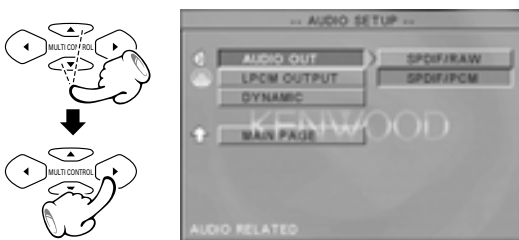

- 4 Press Cursor up/down (▲/▼) keys on the remote to select specific output mode, then press the ENTER key.

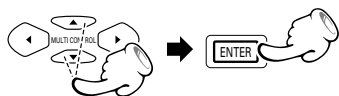

- 5 Press Cursor left (◀) key on the remote to return to previous menu.

- 6 Press Cursor up/down (▲/▼) keys on the remote to select MAIN PAGE, then press the ENTER key.

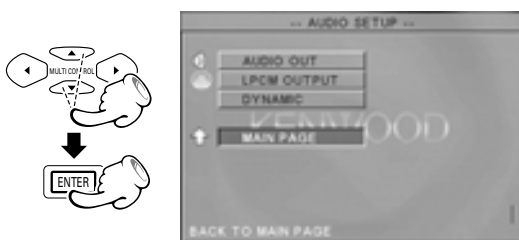

- 7 Press Cursor up/down (▲/▼) keys on the remote to select EXIT SETUP, then press the ENTER key.

DVD Select LPCM Output

LPCM 48k : Even in case of 96 kHz digital signal, DVD will deliver 48 kHz signal out.

LPCM 96k : In case of 96 kHz digital signal, DVD will deliver 96 kHz signal out. In this case your receiver should control 96 kHz signal.

- 1 During stop mode, press MENU key on the remote.



- 2 Press Cursor up/down (▲/▼) keys on the remote to select the AUDIO SETUP, then press the ENTER key to access the sub features



- 3 Press Cursor up/down (▲/▼) keys on the remote to select LPCM OUTPUT, then press the Cursor right (▶) key to access the sub features

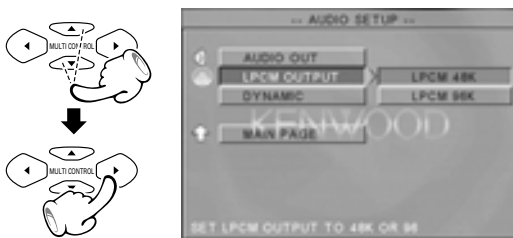

- 4 Press Cursor up/down (▲/▼) keys on the remote to select specific output mode, then press the ENTER key.

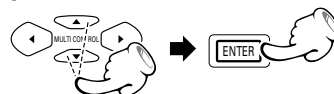

- 5 Press Cursor left (◀) key on the remote to return to previous menu.

- 6 Press Cursor up/down (▲/▼) keys on the remote to select MAIN PAGE, then press the ENTER key.

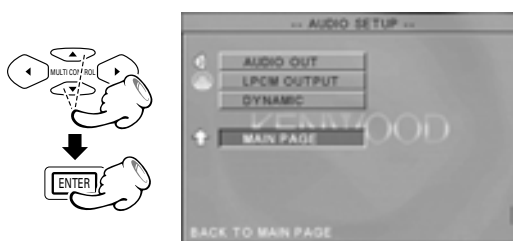

- 7 Press Cursor up/down (▲/▼) keys on the remote to select EXIT SETUP, then press the ENTER key.

Please refer to pages 14 and 15 for setup.

DVD Select Dynamic Range

This function operates only at the time of playback of DVDs recorded with Dolby Digital.

- ❶ During stop mode, press MENU key on the remote.

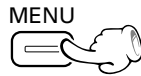

- ❷ Press Cursor up/down (▲/▼) keys on the remote to select the AUDIO SETUP, then press the ENTER key to access the sub features



- ❸ Press Cursor up/down (▲/▼) keys on the remote to select DYNAMIC, then press the Cursor right (▶) key to access the sub features

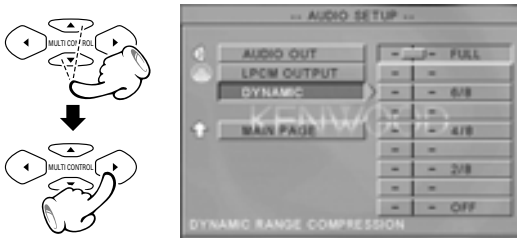

- ❹ Press Cursor up/down (▲/▼) keys on the remote to select specific dynamic range, then press the ENTER key.

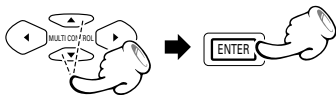

- ❺ Press Cursor left (◀) key on the remote to return to previous menu.

- ❻ Press Cursor up/down (▲/▼) keys on the remote to select MAIN PAGE, then press the ENTER key.

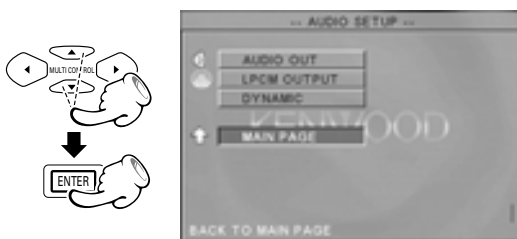

- ❼ Press Cursor up/down (▲/▼) keys on the remote to select EXIT SETUP, then press the ENTER key.



Please refer to pages 14 and 15 for setup.

DVD VCD Select VIDEO Output

- ➊ During stop mode, press MENU key on the remote.



- ➋ Press Cursor up/down (▲/▼) keys on the remote to select the PREFERENCE, then press the ENTER key to access the sub features

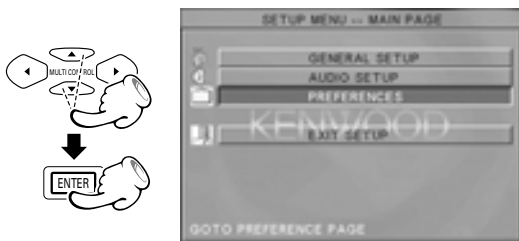

- ➌ Press Cursor up/down (▲/▼) keys on the remote to select VIDEO OUTPUT, then press the Cursor right (▶) key to access the sub features

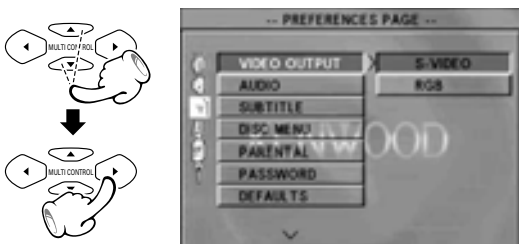

- ➍ Press Cursor up/down (▲/▼) keys on the remote to select S.VIDEO or Cr, Cb, Y, then press the ENTER key.

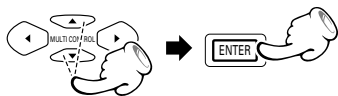

- ➎ Press Cursor left (◀) key on the remote to return to previous menu.

- ➏ Press Cursor up/down (▲/▼) keys on the remote to select MAIN PAGE, then press the ENTER key.

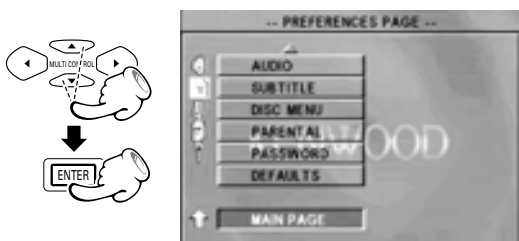

- ➐ Press Cursor up/down (▲/▼) keys on the remote to select EXIT SETUP, then press the ENTER key.

DVD Select Audio Language

- ➊ During stop mode, press MENU key on the remote.



- ➋ Press Cursor up/down (▲/▼) keys on the remote to select the PREFERENCE, then press the ENTER key to access the sub features

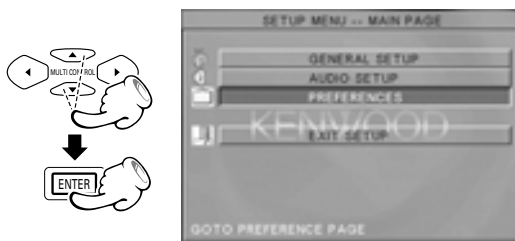

- ➌ Press Cursor up/down (▲/▼) keys on the remote to select AUDIO, then press the Cursor right (▶) key to access the sub features

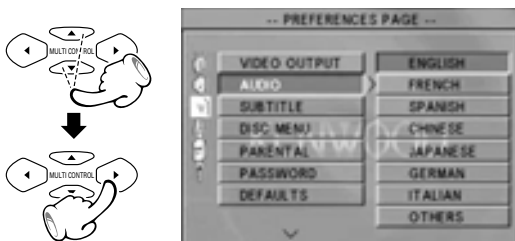

- ➍ Press Cursor up/down (▲/▼) keys on the remote to select specific language, then press the ENTER key.

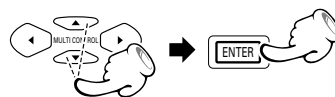

To select other language

- ➊ Select "OTHER" and press the ENTER key.
- ➋ Input 4 digit code by press numeric keys on the remote.
- ➌ Press the ENTER key.
(DVD menu language code list - 25)

- ➎ Press Cursor left (◀) key on the remote to return to previous menu.

- ➏ Press Cursor up/down (▲/▼) keys on the remote to select MAIN PAGE, then press the ENTER key.

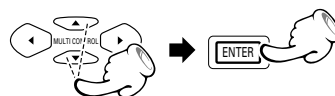

- ➐ Press Cursor up/down (▲/▼) keys on the remote to select EXIT SETUP, then press the ENTER key.

Please refer to pages 14 and 15 for setup.

DVD Select Subtitle Language

- ① During stop mode, press MENU key on the remote.

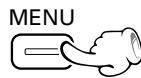

- ② Press Cursor up/down (▲/▼) keys on the remote to select the PREFERENCE, then press the ENTER key to access the sub features

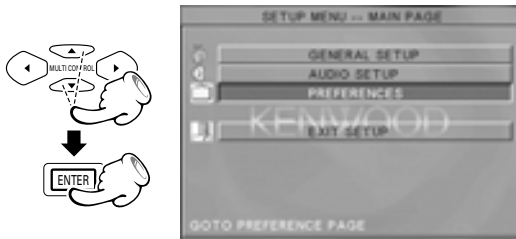

- ③ Press Cursor up/down (▲/▼) keys on the remote to select SUBTITLE, then press the Cursor right (▶) key to access the sub features

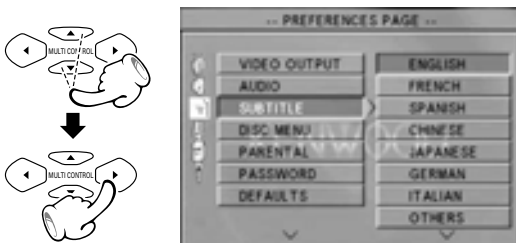

- ④ Press Cursor up/down (▲/▼) keys on the remote to select specific language, then press the ENTER key.

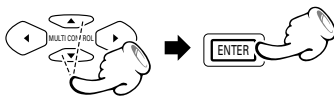

To select other language

- ① Select "OTHER" and press the ENTER key.
- ② Input 4 digit code by press numeric keys on the remote.
- ③ Press the ENTER key.
(DVD menu language code list - 25)

- ⑤ Press Cursor left (◀) key on the remote to return to previous menu.

- ⑥ Press Cursor up/down (▲/▼) keys on the remote to select MAIN PAGE, then press the ENTER key.

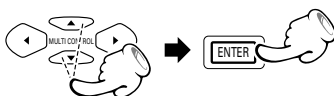

- ⑦ Press Cursor up/down (▲/▼) keys on the remote to select EXIT SETUP, then press the ENTER key.

DVD Select Disc Menu Language

- ① During stop mode, press MENU key on the remote.

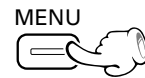

- ② Press Cursor up/down (▲/▼) keys on the remote to select the PREFERENCE, then press the ENTER key to access the sub features

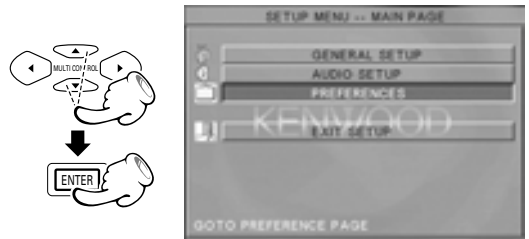

- ③ Press Cursor up/down (▲/▼) keys on the remote to select DISC MENU, then press the Cursor right (▶) key to access the sub features

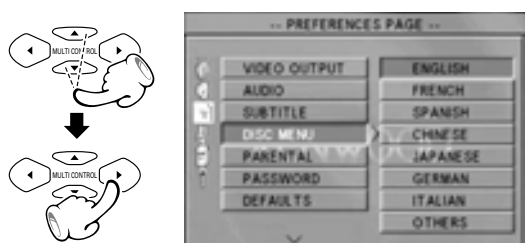

- ④ Press Cursor up/down (▲/▼) keys on the remote to select specific language, then press the ENTER key.



To select other language

- ① Select "OTHER" and press the ENTER key.
- ② Input 4 digit code by press numeric keys on the remote.
- ③ Press the ENTER key.
(DVD menu language code list - 25)

- ⑤ Press Cursor left (◀) key on the remote to return to previous menu.

- ⑥ Press Cursor up/down (▲/▼) keys on the remote to select MAIN PAGE, then press the ENTER key.

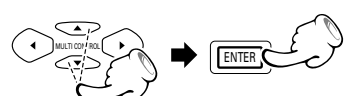

- ⑦ Press Cursor up/down (▲/▼) keys on the remote to select EXIT SETUP, then press the ENTER key.

Please refer to pages 14 and 15 for setup.

DVD Select Parental level

This part of DVD rating lets you determine how your player will react discs that contain movies that are rated (in the U.S.A. the Motion Pictures Association of America rates movies as G, PG, PG-13, etc.).

- 1 During stop mode, press MENU key on the remote.



- 2 Press Cursor up/down (▲/▼) keys on the remote to select the PREFERENCE, then press the ENTER key to access the sub features

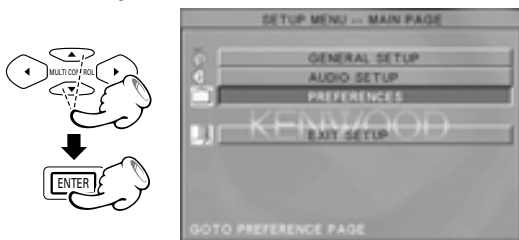

- 3 Press Cursor up/down (▲/▼) keys on the remote to select PARENTAL, then press the Cursor right (▶) key to access the sub features

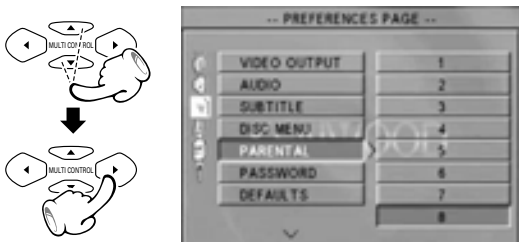

- 4 Press Cursor up/down (▲/▼) keys on the remote to select specific level, then press the ENTER key.

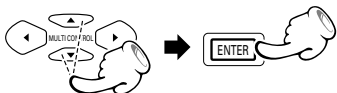

- 5 Enter the password, then press the ENTER key.

The password set at the time of shipping from the factory is "0000".

Refer to the item "Change Password" when the password is to be changed.

- 6 Press Cursor left (◀) key on the remote to return to previous menu.

- 7 Press Cursor up/down (▲/▼) keys on the remote to select MAIN PAGE, then press the ENTER key.

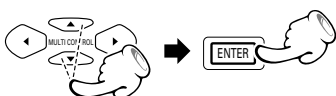

- 8 Press Cursor up/down (▲/▼) keys on the remote to select EXIT SETUP, then press the ENTER key.

DVD Change Password

- 1 During stop mode, press MENU key on the remote.



- 2 Press Cursor up/down (▲/▼) keys on the remote to select the PREFERENCE, then press the ENTER key to access the sub features

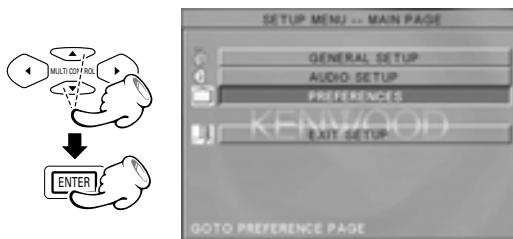

- 3 Press Cursor up/down (▲/▼) keys on the remote to select PASSWORD, then press the Cursor right (▶) key to access the sub features

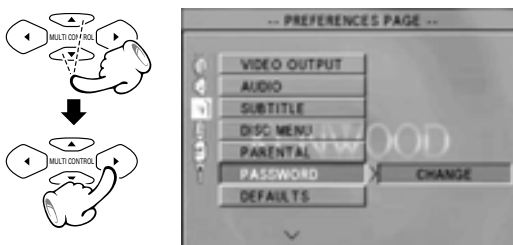

- 4 press the ENTER key to select CHANGE.

- 5 Enter old password, new password and enter new password again to confirm, then press the ENTER key. (The password set at the time of shipping from the factory is "0000".)



- 6 Press Cursor up/down (▲/▼) keys on the remote to select MAIN PAGE, then press the ENTER key.

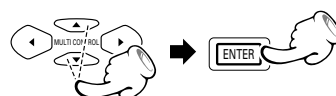

- 7 Press Cursor up/down (▲/▼) keys on the remote to select EXIT SETUP, then press the ENTER key.

Please refer to pages 14 and 15 for setup.



Put back to the Default Setting

- ① During stop mode, press MENU key on the remote.

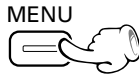

- ② Press Cursor up/down (▲/▼) keys on the remote to select the PREFERENCE, then press the ENTER key to access the sub features



- ③ Press Cursor up/down (▲/▼) keys on the remote to select DEFAULTS, then press the Cursor right (▶) key to access the sub features

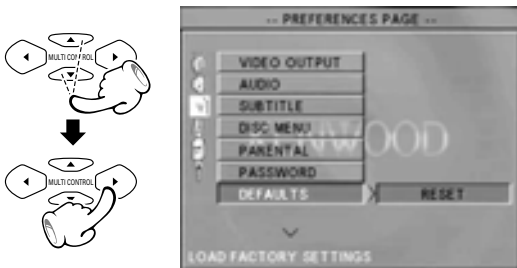

- ④ press the ENTER key to select RESET.



- ⑤ Press Cursor left (◀) key on the remote to return to previous menu.

- ⑥ Press Cursor up/down (▲/▼) keys on the remote to select MAIN PAGE, then press the ENTER key.

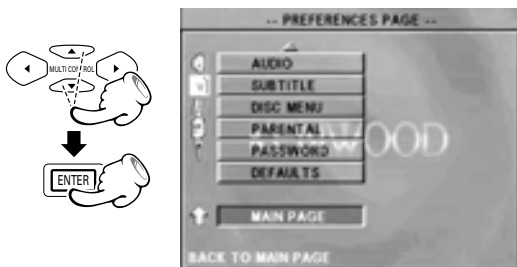

- ⑦ Press Cursor up/down (▲/▼) keys on the remote to select EXIT SETUP, then press the ENTER key.

DVD menu language code list

Code No.	Language
1027	Afar
1028	Abkhazian
1032	Afrikaans
1039	Amharic
1044	Arabic
1045	Assamese
1051	Aymara
1052	Azerbaijani
1053	Bashkir
1057	Byelorussian
1059	Bulgarian
1060	Bihari
1069	Bislama
1066	Bengali; Bangla
1067	Tibetan
1070	Breton
1079	Catalan
1093	Corsican
1097	Czech
1103	Welsh
1105	Danish
1109	German
1130	Bhutani
1142	Greek
1144	English
1145	Esperanto
1149	Spanish
1150	Estonian
1151	Basque
1157	Persian
1165	Finnish
1166	Fiji
1171	Faeroese
1174	French
1181	Frisian
1183	Irish
1186	Scots Gaelic
1194	Galician
1196	Guarani
1203	Gujarati
1209	Hausa
1217	Hindi
1226	Croatian
1229	Hungarian
1233	Armenian
1235	Interlingua

Code No.	Language
1239	Interlingue
1245	Inupiak
1248	Indonesian
1253	Icelandic
1254	Italian
1257	Hebrew
1261	Japanese
1269	Yiddish
1283	Javanese
1287	Georgian
1297	Kazakh
1298	Greenlandic
1299	Cambodian
1300	Kannada
1301	Korean
1305	Kashmiri
1307	Kurdish
1311	Kirghiz
1313	Latin
1326	Lingala
1327	Laothian
1332	Lithuanian
1334	"Latvian, Lettish"
1345	Malagasy
1347	Maori
1349	Macedonian
1350	Malayalam
1352	Mongolian
1353	Moldavian
1356	Marathi
1357	Malay
1358	Maltese
1363	Burmese
1365	Nauru
1369	Nepali
1376	Dutch
1379	Norwegian
1393	Occitan
1403	(Afan) Oromo
1408	Oriya
1417	Punjabi
1428	Polish
1435	"Pashto, Pushto"
1436	Portuguese
1463	Quechua
1481	Rhaeto-Romance

Code No.	Language
1482	Kirundi
1483	Romanian
1489	Russian
1491	Kinyarwanda
1495	Sanskrit
1498	Sindhi
1501	Sangro
1502	Serbo-Croatian
1503	Shinghalese
1505	Slovak
1506	Slovenian
1507	Samoan
1508	Shona
1509	Somali
1511	Albanian
1512	Serbian
1513	Siswati
1514	Sesotho
1515	Sundanese
1516	Swedish
1517	Swahili
1521	Tamil
1525	Tegulu
1527	Tajik
1528	Thai
1529	Tigrinya
1531	Turkmen
1532	Tagalog
1534	Setswana
1535	Tonga
1538	Turkish
1539	Tsonga
1540	Tatar
1543	Twi
1557	Ukrainian
1564	Urdu
1572	Uzbek
1581	Vietnamese
1587	Volapuk
1613	Wolof
1632	Xhosa
1665	Yoruba
1684	Chinese
1697	Zulu

Basic play

Preparation

MAIN UNIT

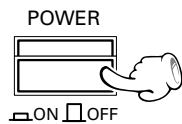

- Set the **POWER ON/OFF** switch to the ON () position.
- After the power is switched ON, there is a delay of about 3 seconds before the display is lit.

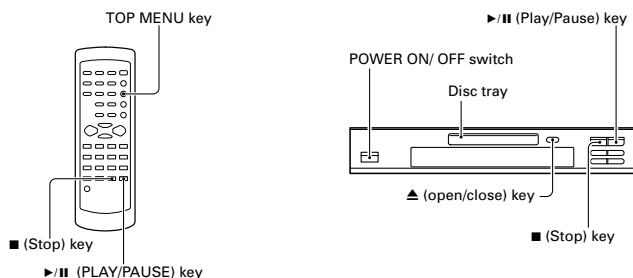

1 Load a disc.

MAIN UNIT

- 1 Open the tray.



- 2 Place a disc.

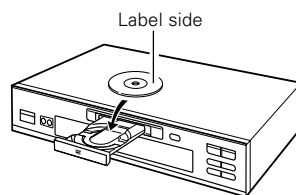

2 Start playback.

MAIN UNIT

REMOTE



- When the ►/|| key or open/close (▲) key is pressed while a tray is open, the tray closes automatically, and then playback begins.

When a Disc Menu appears on the screen

In case of interactive DVDs, a Disc Menu appears on the screen. Then press **ENTER** to select specific menu you want to play by using Cursor keys.

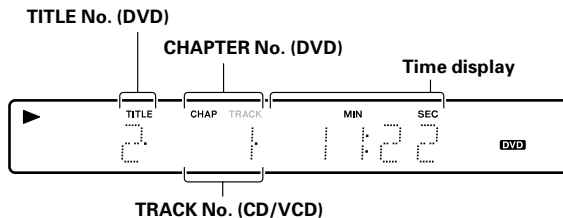

- Each press pauses and plays the disc alternately.

When a menu screen is recorded on the DVD disc, the menu screen will be displayed when the TOP MENU key or MENU key is pressed. At the menu screen, the menu can be selected by pressing the Cursor keys.

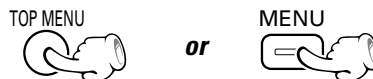

To stop playback

MAIN UNIT

REMOTE



RESUME playback (only DVD)

When the ■ (Stop) key has been pressed once during playback to stop the playback, and then playback is started again, play will start from the point where the playback had been stopped. This is called the RESUME function. When the ■ (Stop) key is pressed again during stop, the RESUME function is cancelled.

Disc playback features



- You won't hear the sound (audio) on the DVD and VCD when you're using the Skip, Search, Step or Slow motion features.
- Playback features are not available during the opening credits of a movie.

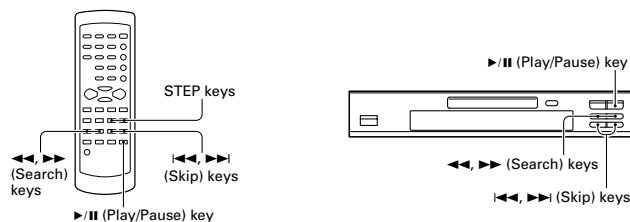

CD DVD VCD **Skipping chapters or tracks**

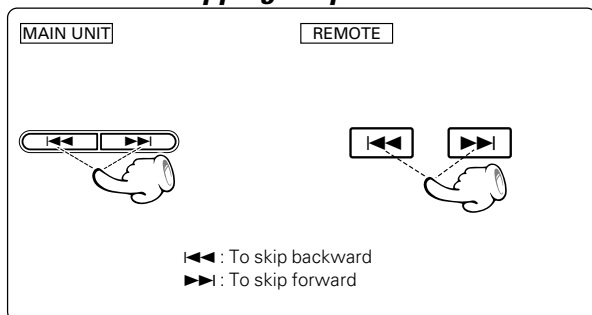

- The chapter (or track) in the direction of the key pressed is skipped, and the selected chapter (or track) will be played from the beginning.
- When the ◀▶ key is pressed once during playback, the chapter (or track) being played will be played from the beginning.



- The Chapter feature won't work if the disc isn't formatted with separate chapters.

CD DVD VCD **Searching**

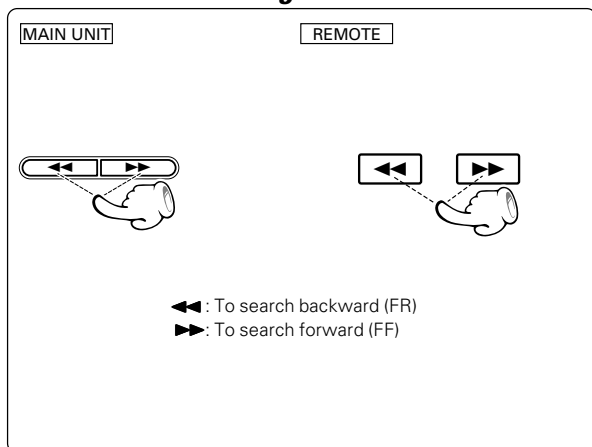

- During playback, press the ◀▶ or ▶▶ key.
- Each press switches the searching speed.
 - ① FF 2 X (▶▶ key) or FR 2 X (◀▶ key)
 - ② FF 4 X (▶▶ key) or FR 4 X (◀▶ key)
 - ③ FF 8 X (▶▶ key) or FR 8 X (◀▶ key)
 - ④ FF 16X (▶▶ key) or FR 16X (◀▶ key)
 - ⑤ Normal playback

- Press the ▶|| key at any time to resume normal playback.

DVD VCD **STEP (freeze frame and frame advance)**

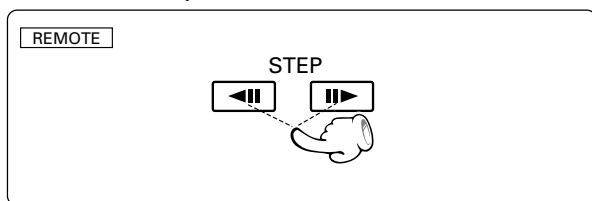

- During playback, press the **STEP** keys.
- Each time you press the keys, the picture advances one frame.
- Press the ▶|| key to resume normal playback.

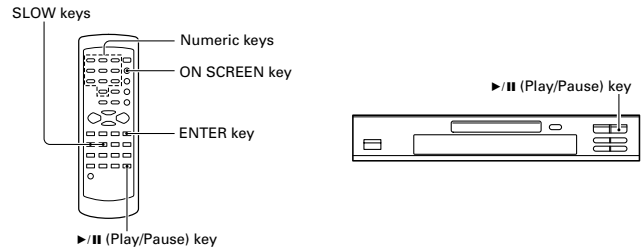

DVD VCD Slow motion playback

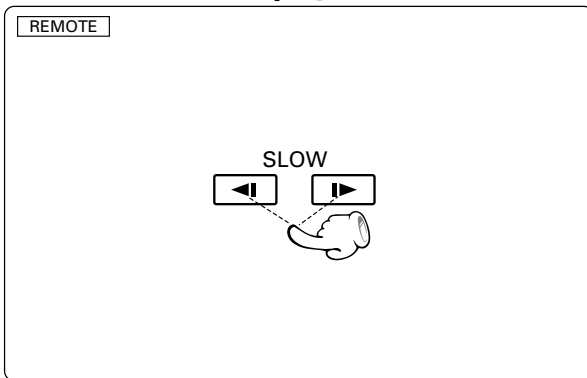

- During playback, press the **SLOW** keys.
- Each press switches the motion speed.

(At the time of DVD playback)

- ① SF 1/4 (▶ key) or SR 1/4 (◀ key)
- ② SF 1/8 (▶ key) or SR 1/8 (◀ key)
- ③ SF 1/16 (▶ key) or SR 1/16 (◀ key)
- ④ Normal playback

(At the time of VCD playback)

(Slow Reverse is not possible)

- ① SF 1 /4 (▶ key)
- ② SF 1 /8 (▶ key)
- ③ SF 1 /16 (▶ key)
- ④ Normal playback

- Press the ▶/|| key to resume normal playback.

CD DVD VCD Playback from desired track or title

Because DVD VIDEO discs use digital technology, a title can be divided into individual chapters (similar to tracks on a CD).

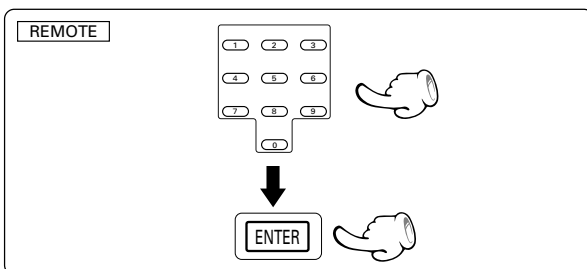

- Select the desired track No. (CD, VCD) or title No. (DVD)
- ① Press the numeric keys as shown below

(Example) To select track No. 23 : **2** **3**

- ② Press the **ENTER** key.



- P.B.C. on mode of VCD, the Selecting a Track function may not work. → 37

DVD CD VCD On screen display

The elapsed time or the remaining time for the chapter or the track can be displayed on the monitor (TV) screen.

Press the **ON SCREEN** key on the remote.

Each press the key switches the display.

At the time of DVD playback.

ON SCREEN



- ① Title number and chapter number display.
(Example) TITLE 01/02 CHAPTER 05/15
00:05:12 (elapsed time of the title)
- ② **"TITLE REMAIN"**
Remaining time of the title being played.
- ③ **"CHAPTER ELAPSED"**
Elapsed time of the chapter being played.
- ④ **"CHAPTER REMAIN"**
Remaining time of the chapter being played.
- ⑤ **"OFF"**

At the time of CD/VCD playback.

- ① **"SINGLE ELAPSED"**
Elapsed time of the track being played.
(Example) 22:23 TRACK 05/15
- ② **"SINGLE REMAIN"**
Remaining time of the track being played.
- ③ **"TOTAL ELAPSED"***
Elapsed time of the disc being played.
- ④ **"TOTAL REMAIN"***
Remaining time of the disc being played.
- ⑤ **"OFF"**

Items marked by * are not displayed in P.B.C. on mode of VCD.

DVD Select Audio Language

If the disc was created with different language tracks, you can use the **AUDIO KEY** on the remote to temporarily change the DVD player's Audio setting.

During playback, press the **AUDIO** key on the remote.

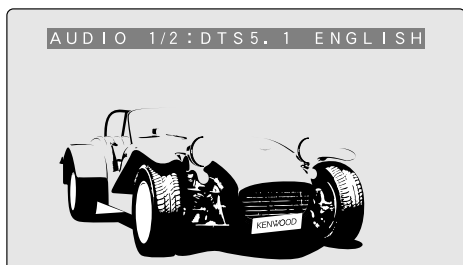

The language is switched each time the **AUDIO** key is pressed.

- The display is switched off when no operation is performed for about 2 seconds.



1. The language feature only works if the disc was created with multiple audio tracks.
2. When you chose an audio language by the **AUDIO** key, you only override the audio language setting in the DVD Player's main menu (in the Language Preferences menu within Setup menu) temporarily.

DVD Select Subtitle Language

You can change the Subtitle language while you're watching a disc (but only if the disc was created with subtitles).

During playback, press the **SUBTITLE** key on the remote.

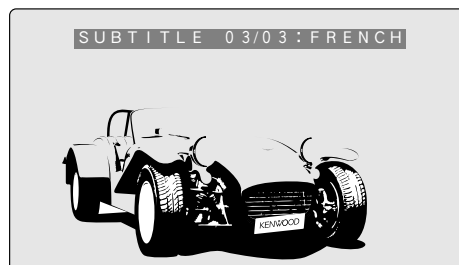

The language is switched each time the **SUBTITLE** key is pressed.

- The display is switched off when no operation is performed for about 2 seconds.



1. The subtitle feature only works if the disc was created with multiple subtitle tracks.
2. The subtitle menu of the disc appears in some discs.

VCD Select the Audio channel

You can choose to play back only the right or the left channel of audio recorded on the disc, or you can select stereo playback.

During VCD playback, press **AUDIO** key on the remote.



Each press the key switches the mode.

- ① LEFT
- ② RIGHT
- ③ STEREO

DVD Select Subtitle on or off

When the **SUBTITLE ON/OFF** key is pressed, subtitles will be displayed. Switching between display of subtitles and no display of subtitles is done each time the key is pressed.

Press **SUBTITLE ON/OFF** key on the remote.



DVD Select Camera angle

Some disc contains multiple angles particular scene or sequence. If the disc only has one angle, this feature won't work.

- 1 During playback, press the ANGLE key on the remote.

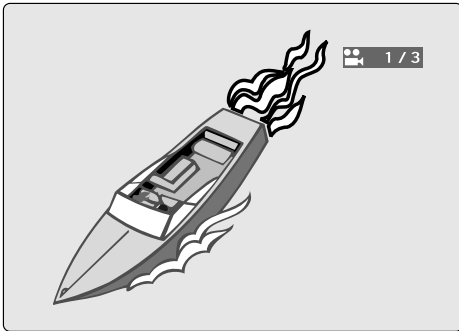

- 2 Select the Camera angle with press the ANGLE key.

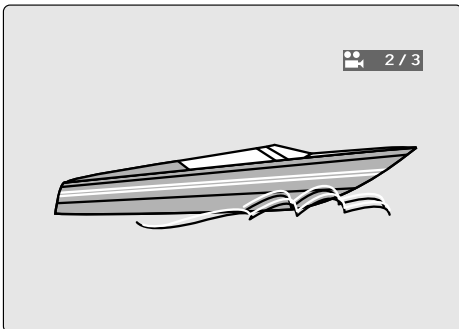

- The display is switched off when no operation is performed for about 2 seconds.

CD VCD Random play

The tracks of the disc are played in random order.

- 1 During stop mode, press the RANDOM key on the remote.



The Random Play display appears

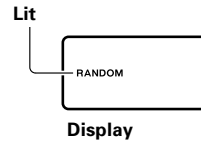
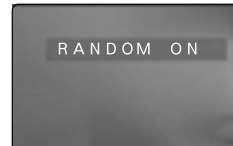

Each time you press RANDOM key on the remote, random play would be on and off.

- 2 Press the play pause (▶/||) key to start random playback.

- The menu is switched off when no operation is performed for about 2 seconds.

"MP3/JPEG Random play" → 41

To cancel random play

- 1 Press the stop (■) key to stop playback.
- 2 Press the RANDOM key to cancel random playback.

To repeat random play

During random playback, press the REPEAT key on the remote.



Each press the key switches the mode.

- 1 REPEAT ONE
- 2 REPEAT ALL
- 3 REPEAT OFF



- After all tracks of a disc have been played in random order, playback will stop.
- When playing a DVD, the Random mode does not work.
- When switching to **RANDOM** mode with a VCD in **P.B.C. ON** mode, the **P.B.C.** mode will become **OFF**.

DVD CD VCD Repeat play

Desired title, chapter, track or disc can be played back repeatedly.

At the time of DVD playback.

- "CHAPTER REPEAT" : Repeat the chapter that is playing.
- "TITLE REPEAT" : Repeat the title that is playing.

At the time of CD/VCD playback.

- "REPEAT ONE" : Repeat the track that is playing.
- "REPEAT ALL" : Repeat the disc that is playing.

During playback, press the REPEAT key on the remote.



Each press the key switches the REPEAT mode

At the time of DVD playback.

- ① "CHAPTER REPEAT ON" : Display lit "REPEAT 1"
- ② "TITLE REPEAT ON" : Display lit "REPEAT ALL"
- ③ "REPEAT OFF"

At the time of CD/VCD playback.

- ① "REPEAT ONE" : Display lit "REPEAT 1"
- ② "REPEAT ALL" : Display lit "REPEAT ALL"
- ③ "REPEAT OFF"



At the time of REPEAT mode "REPEAT" is light.

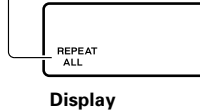

- To cancel repeat playback, press the **REPEAT** key and select "REPEAT OFF".
- The menu is switched off when no operation is performed for about 2 seconds.

"MP3/JPEG Repeat play" → 41



P.B.C. on mode of VCD, the Repeat play function does not work. → 37

DVD CD VCD A-B Repeat play

The A-B repeat function lets you mark a segment to repeat between the beginning "A" and the end "B" of the segment you want to replay.

- ① Press the A-B key on the remote when you want to choose a scene (sound) as the beginning point.

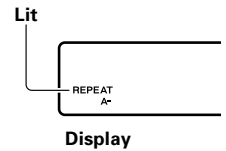

- ② Press the A-B key again to choose a scene (sound) as the end point.



The Repeat B (Repeat A-B) display appears

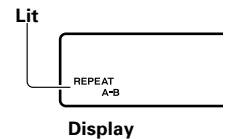

- To cancel A-B Repeat playback, press the **A-B** key.
- The menu is switched off when no operation is performed for about 2 seconds.

DVD CD VCD Using Bookmarks

The bookmark feature lets you mark a point on the disc that you can go to quickly. You can store up to 14 bookmarks.

Create the bookmark

- 1 During playback, press the **RANDOM** key on the remote.

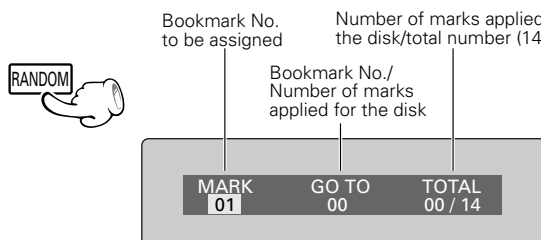

- 2 Press **Cursor up/down (▲/▼)** keys on the remote to select desired bookmark number.
- 3 When you reach the scene you want to mark, press **ENTER** key.

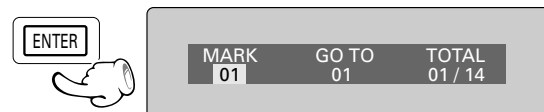

- Up to 14 bookmarks can be applied in the same way for one disc.
- When the **ENTER** key is pressed at a previously marked bookmark, that mark will be changed to the new point.

Recalling a bookmarked scene

- 1 During playback, press the **RANDOM** key on the remote.



- 2 Press the **Cursor right (▶)** key on the remote to recalling a bookmark number.

Set the cursor to this position.

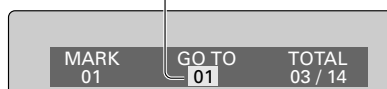

- 3 Press the **Cursor up/down (▲/▼)** key on the remote to select the bookmark number you want to activate, then press **ENTER** key.



- If all 14 bookmarks are in use, you can still mark new scenes, but the previous bookmarks will be erased.
- Depending on the disc, the Bookmark function may not work.
- P.B.C. on mode of VCD, the Bookmark function does not work.

CD VCD Using IntroScan function

CD IntroScan playback

It is possible to play back approx. 10 seconds of the beginning of each track.

- 1 During stop mode, press the **TOP MENU** key on the remote.

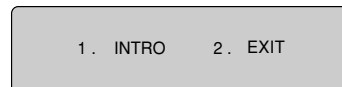

- 2 Press the **"1"** key on the remote to select **INTRO**, then press the **ENTER** key.

- The first 10 seconds of each track play.
- After Intro Scan goes through all of the tracks, it stops.
- When the **ENTER** key or the **TOP MENU** key is pressed during introScan of a track, the unit will return to normal playback starting with that track.

IntroScan ends when 2 (EXIT) is selected.

VCD IntroScan playback

The VCD IntroScan function has three modes.

1. **INTRO** : The first approx. 8 seconds of each track will be played one after another .
2. **DISC** : The beginning of each of the first nine tracks of the disc will be played back sequentially and displayed on the screen. When **SKIP** key is pressed, the next nine screens will be played back and displayed.
3. **TRACK**: The selected track will be played back with the screen display divided into nine parts.

- 1 During stop mode, press the **TOP MENU** key on the remote.



- 2 Select **1 (INTRO)**, **2 (DISC)**, or **3 (TRACK)** with the numeric keys of the remote control and press the **ENTER** key.

At the time of "DISC" or "TRACK", the screen will be displayed divided into nine pictures.

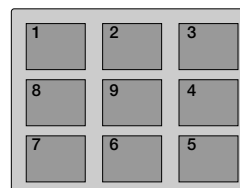

The next nine pictures (nine tracks) will be displayed when the skip up (▶▶) key is pressed.

When the number of one of the pictures is selected with the numeric keys, playback will start from that picture.

P.B.C. on mode of VCD, the IntroScan function does not work.

You can listen to the desired tracks of the current CD or VCD in any desired order.

Program Edit

- 1 During stop mode, press the P.MODE key on the remote.

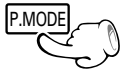

- 2 Select specific track by Press Cursor up/down (▲/▼) keys.



- 3 Select "ADD" icon on the screen to register selected value onto PROGRAM LIST, then press the ENTER key.

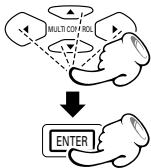

- 4 You can select maximum 21 values by repeating step 2 - 3.

- 5 Select "PLAY" icon on the screen. then press the ENTER key to start program play.

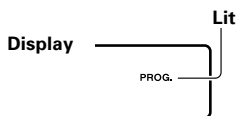

Program edit screen appears.

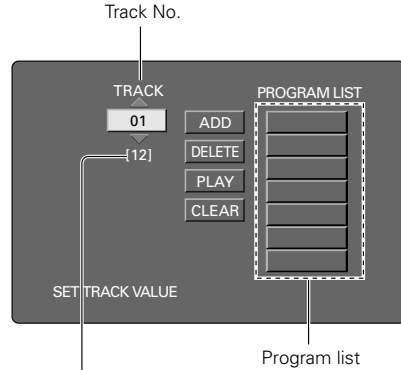

Number of tracks recorded on the disc.



- "ADD" icon : Add value onto "PROGRAM LIST"
- "DELETE" icon : Delete value from "PROGRAM LIST"
- "INSERT" icon : Insert value in "PROGRAM LIST"
- "PLAY" icon : Play program play
- "CLEAR" icon : When this icon is selected and the ENTER key is pressed, the entire contents of the PROGRAM LIST will be deleted, and the Program edit screen also will disappear.

- MP3/JPEG discs can not be programmed with this program mode. (MP3/JPEG program playback → 42)
- The unit stops when the STOP (■) key is pressed. To restart program play, press the P.MODE key, display the program screen, select the "PLAY" icon, and press the ENTER key.

To repeat program play

During program playback, press the REPEAT key on the remote.



Each press the key switches the mode.

- 1 "REPEAT ONE"
- 2 "REPEAT ALL"
- 3 "REPEAT OFF"

Insert track

During stop mode, press the P.MODE key on the remote

- 1 Select specific track to insert by press Cursor up/down (▲/▼) keys.



- 2 Move the cursor with the Cursor right (▶) key to the "PROGRAM LIST" and select the column to be added with the Cursor up/down (▲/▼) keys. (The color of the column where the Cursor is located will change.)

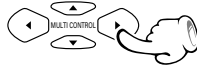

- 3 Press the Cursor left (◀) key, use the Cursor up/down (▲/▼) keys to move the Cursor to the "INSERT" icon, and press the ENTER key.



The new track will be inserted after (below) the selected column.

Program edit screen appears.

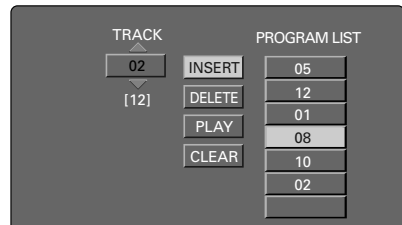

Delete Program

During stop mode, press the P.MODE key on the remote

- 1 Move the cursor with the Cursor right (▶) key to the "PROGRAM LIST" and select the column to be deleted with the Cursor up/down (▲/▼) keys. (The color of the column where the Cursor is located will change.)



- 2 Press the Cursor left (◀) key, use the Cursor up/down (▲/▼) keys to move the Cursor to the "DELETE" icon, and press the ENTER key.

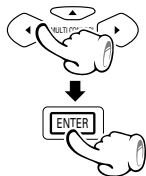

Selected value deletes

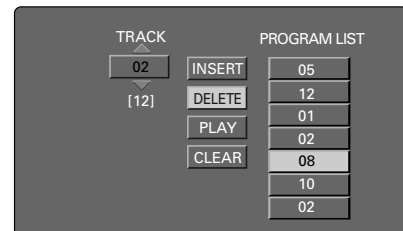

Release Program play

In following case, Program play would be released.

1. When you open and close tray.
2. When you turn power off and on.
3. Press the CLEAR key during display of the Program edit screen.



P.B.C. on mode of VCD, the Program play function does not work. → 37



VCD Hierarchical structure of VCD menus

When an item is selected on the menu screen during playback of a P.B.C.-compatible VCD, another menu with more details items may be displayed. When a number of menus are connected in multiple layers in this way, it is said that the menus have a hierarchical structure. In this structure, the desired scene can be reached by repeating item selections on the menu screens.

Example for a hierarchical structure

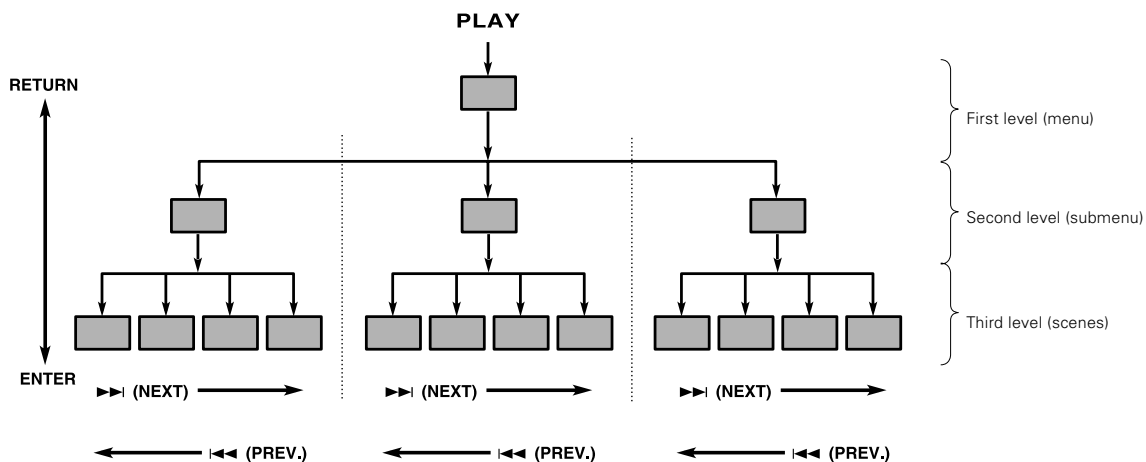

Advancing

When an item is selected on the menu screen with the ENTER (Select) key or the numeric keys, advance is made to the next lower menu level. When the advance destination is the "scene" to be played, the contents will be played.

- When several menus (scenes) can be selected in each level, screen switching is possible with the keys ►► (NEXT) and ◀◀ (PREV.).

Returning

Each time the RETURN key is pressed, return is made to the next higher menu.

Examples of operation keys and indications used during VCD playback

Soft jacket indication	►	◀●	◀◀	►►	► (Select)
KENWOOD operation key	►	RETURN	◀◀	►►	ENTER

- Depending on the software, the jacket indication may differ from the above.

VCD Playback without using the menu playback function (In case of a P.B.C.-compatible VCD) (To P.B.C. On or Off)

During VCD playback or stop mode, press the **-ON/OFF** key on the remote control unit.



- For the track numbers, refer to the disc jacket or other material.
- P.B.C. off mode : Without using menu playback function.

P.B.C. off mode

Goes off

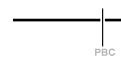

To return to menu playback

Press the **-ON/OFF** key again.

P.B.C. on mode

Lit



Playback will stop when P.B.C. is switched on or off during playback.

Guidance of MP3/JPEG

MP3/JPEG media that can be played back with this equipment

Usable media : CD-ROM, CD-R, CD-RW

Usable formats : ISO9660 level 1 (excluding expanded formats)

Files that can be played back : MP3 files and JPEG files

Creating media for playing back on this equipment

Compressing MP3

Please set up the transfer bit rate setting for the compression software when compressing MP3 files as follow.

MP3 Files : 128kbps recommended (32kbps-320kbps)

- This unit is compatible with 32 kHz, 44.1 kHz(recommended) and 48 kHz sampling frequencies.
- This unit is compatible with ID3-TAG Ver. 1.
- DIGITAL output of MP3 data is done not as MP3 data, but as PCM data.

Naming folders and files

Single-byte characters between A and Z, single-byte numerals between 0 and 9, and the single-byte underscore(_) can be displayed. Ensure that the "mp3" (MP3 files) or "jpg" (JPEG files) extension log is attached to all file names

- Never add the "mp3" extension log to any files other than MP3 files. If the "mp3" extension log is added to any files other than MP3 files, the equipment will assume that they can be played back, and this will produce loud noises in the speakers, resulting in damage of adverse effects.
- Never add the "jpg" extension log to any files other than JPEG files. If the "jpg" extension log is added to any files other than JPEG, the unit will not operate normally.

Confirming media and files

Check to ascertain that MP3 files can be played back correctly on the personal computer in use prior to saving them onto the media. Check to ensure that the saved file can be played back normally.

- It is not possible to confirm that files can be played back correctly while they are being saved onto the media.

When saving files onto media

Ensure that the session is closed or finalized when data has been written on media. There are cases where media on which the session has not been closed or finalized will not be played back correctly with this equipment.

- There are cases where the folder names and file names will not be displayed correctly depending on the software used to save them.
- Do not store files or folders other than MP3 or JPEG on media to be played back with this equipment.
- It is recommended that ten or less sessions are stored when recording MP3 files onto a media.
- In case of a multisession disc, some time may be required until playback begins.
- There are cases where playback is not possible when MP3/JPEG files (CD-ROM) and music CD information (CD-DA) are saved on the same media.

Example for a hierarchical structure

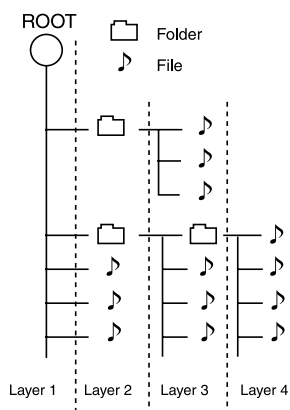

Example for the playback sequence

Playback is made in the order of ① to ⑪ in the following example.

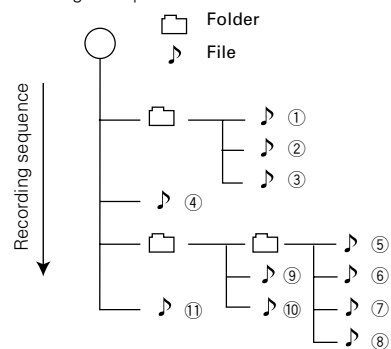

Folder names and file names are displayed up to 8 characters. When folder names and file names are recorded with more than 8 characters, the names will be displayed in abbreviated form.

Playing back MP3/JPEG files

- It is not possible to play back folders and files that exceed the maximum limitations of the media.
- A certain amount of time is required for the player to confirm the media on which MP3/JPEG files have been recorded before playback will commence.

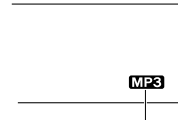

This lights when an MP3 or a JPEG disc is set.

Playback

- 1 During stop mode, press REPEAT key on the remote to select play mode.



- 2 Press Cursor up/down (▲/▼) keys on the remote to select desired file, then press the ENTER key to start playback.

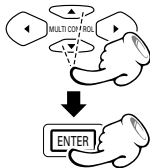

- When JPEG files are displayed, the display is switched automatically from one file to the next. The switching speed differs according to the file size.

To stop playback press the ■ (STOP) key.



- The SMART NAVI screen will be displayed when an MP3 or JPEG disc is set.

Each press switches the play mode.

- 1 FOLDER : Playback the folder that is selected.
- 2 DISC : Playback all files on the disc.
- 3 FOLDER REPEAT : Repeat the folder that is selected.
- 4 DISC REPEAT : Repeat all files on the disc.
- 5 REPEAT ONE : Repeat the file that is selected.

Play mode display

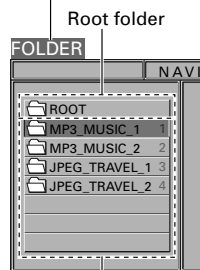

Folders and files in the root folder

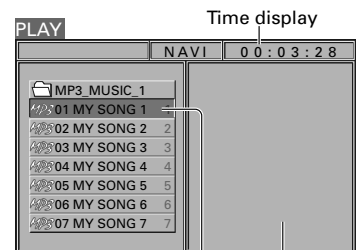

Selected file

Program window

Skipping files

During playback, press the ◀◀ or ▶▶ key.



◀◀ : To skip backward
▶▶ : To skip forward

Note When the play mode is "FOLDER", "FOLDER REPEAT" or "REPEAT ONE", skipping to outside the folder being played is not possible.

Searching (only for MP3 files)

During playback, press the ◀◀ or ▶▶ key.



- Each press switches the searching speed.

- 1 FF 2 X (▶▶ key) or FR 2 X (◀◀ key)
- 2 FF 4 X (▶▶ key) or FR 4 X (◀◀ key)
- 3 FF 6 X (▶▶ key) or FR 6 X (◀◀ key)
- 4 FF 8 X (▶▶ key) or FR 8 X (◀◀ key)
- 5 Normal playback

Selects the files to be played back directly

Press the numeric keys on the remote to enter the desired file number or folder number.

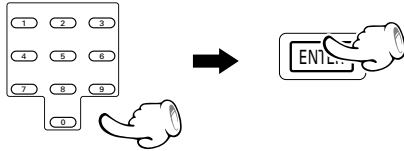

(Example)

To select track No. 23 : **2** **3**

- When a folder is selected, the contents of the selected folder will be displayed.
- When a file is selected, playback of the selected file will start.

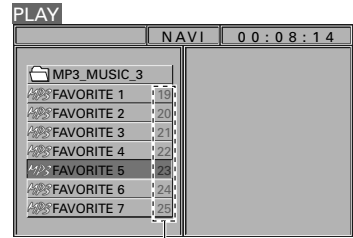

File numbers and folder numbers



For selection of a number, refer to the file numbers on the SMART NAVI screen.

The file numbers shown on the display of the main unit differ from the file numbers entered directly with the numeric keys, as the numbers for each folder are displayed.

Rotating a picture (JPEG files only)

It is possible to rotating a picture.

During JPEG file playback, press the Cursor (◀/▶/▲/▼) keys on the remote.

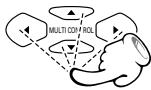

Switching as shown below is done when the cursor keys are pressed.

- ▶ key : 90° rotation in clockwise direction
- ◀ key : 90° rotation in counterclockwise direction
- ▲ key : Vertical mirror image
- ▼ key : Horizontal mirror image

Display examples

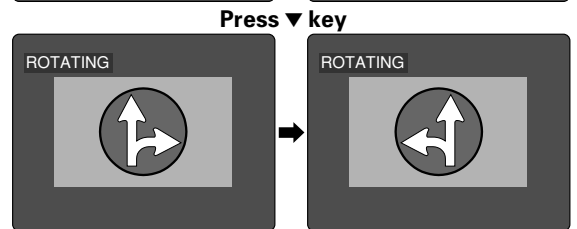
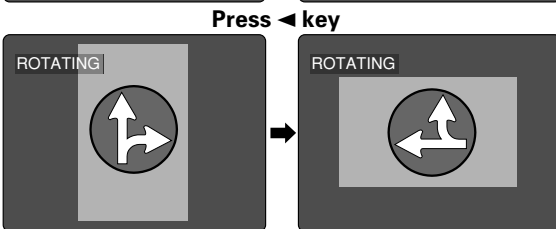
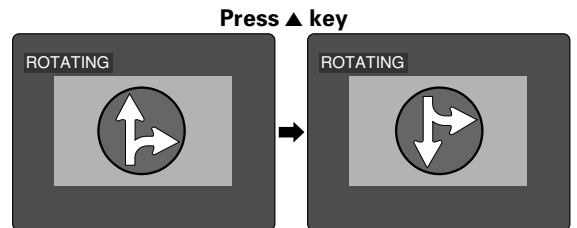
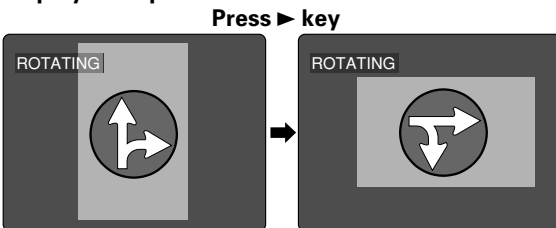

MP3/JPEG Repeat play

Preform operation in REPEAT mode always under observation of the SMART NAVI screen.

Desired folders or discs can be played back repeatedly.

- "REPEAT ONE" : Repeat the file that is selected.
- "FOLDER REPEAT" : Repeat the folder that is selected.
- "DISC REPEAT" : Repeat the disc that is played.

- 1 During stop mode, press the REPEAT key on the remote.



At the time of REPEAT mode
"REPEAT" is light.



- 2 Press Cursor up/down (▲/▼) keys on the remote to select desired file, then press the ENTER key or the play/pause (▶/||) key to start playback.

Each press switches the play mode.

- 1 FOLDER : Playback the folder that is selected.
- 2 DISC : Playback all files on the disc.
- 3 FOLDER REPEAT : Repeat the folder that is selected.
- 4 DISC REPEAT : Repeat all files on the disc.
- 5 REPEAT ONE : Repeat the file that is selected.



Do not select DISCREPEAT when files other than MP3 and JPEG have been recorded on the disc.

MP3/JPEG Random play

The files of a folder are played in random order.

- "RANDOM ON" : The files of a folder being played will be selected in random order for playback.

- 1 During stop mode, press the RANDOM key on the remote.



At the time of RANDOM mode
"RANDOM" is light.



Each time you press RANDOM key on the remote, random play would be on and off.

- 2 Select a file in the folder to be played, press the play/pause (▶/||) key, and start random playback.

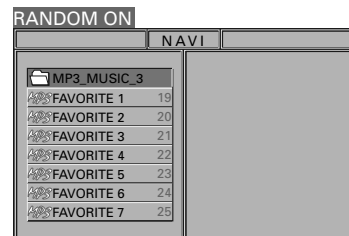

- In case of **RANDOM ON** mode, playback will stop after all files in the folder have been played back once.

To cancel random play

- 1 Press the stop (■) key to stop playback.



- 2 Press the RANDOM key to cancel random playback.



To random repeat play

During stop mode, press the RANDOM key, then press the REPEAT key on the remote.

- In case of **RANDOM REP** mode, all files in the folder will be played back repeatedly. It is also possible that the same file will be played back twice in a row.

To cancel random repeat play

Press the stop (■) key to stop random repeat playback, then press the REPEAT or RANDOM key.

MP3/JPEG program playback

You can listen to the desired files of the current MP3/JPEG disc in any desired order.

Program Edit

- ① During stop mode, press the P.MODE key on the remote.



- ② Press Cursor up/down (▲/▼) keys on the remote to select the file, then press the ENTER key.

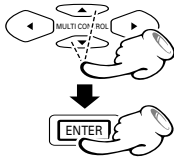

- The selected file go to program window.
- You can select a maximum of about 100 files by repeating step ②. However, note that the maximum number of programmable files depending on the number of files and folders in the MP3/JPEG disc and on the total number of characters used in the file and folder names.

- ③ Press the ■ (Stop) key and confirm the program.



- After the ■ (Stop) key has been pressed and the program has been confirmed, the program no longer can be changed.

- ④ Press ►/|| key to start program playback.

- Confirm that the cursor is at the position of a "file" and press the ►/|| key. Playback is not possible when the cursor is at the position of a "folder".

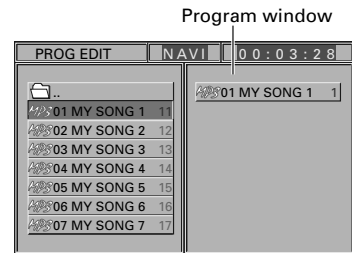

PROG END display



Delete Program

During program edit mode, press the Cursor up/down keys in the program window, select the file to be deleted, and press the CLEAR key.



- After the ■ (Stop) key has been pressed and the program has been confirmed, the program no longer can be changed.
- All programs can be canceled by pressing the P.MODE key during stop in program mode. All programs also can be canceled by opening the disc tray.

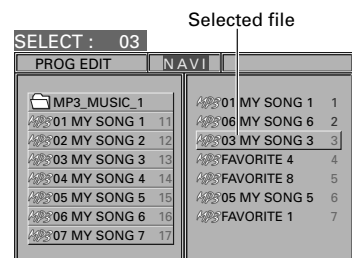

Program repeat play is not available with MP3 discs.

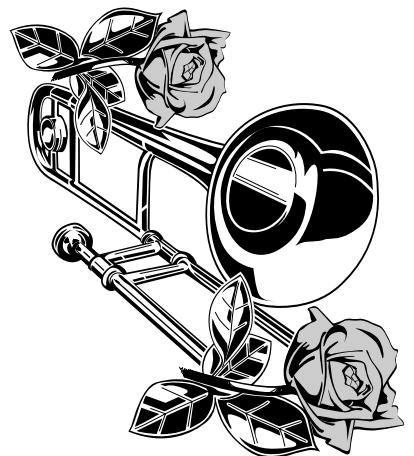

What appears to be a malfunction may not always be serious. If your unit should not perform as expected, consult the table below to see if the problem can be corrected before seeking help from your dealer or service representative.

Operation to reset

The microprocessor may fall into malfunction (impossibility to operate erroneous display, etc.) when the power cord is unplugged while power is ON or due to an external factor.

In this case, switch off the power, wait for several seconds, and then switch the power on again.

Return to the factory defaults by resetting the microprocessor is done as shown as follows.



- ① Press the **MENU** key on the remote to enter **SETUP MENU**.
- ② Select the **PREFERENCE**, then press the **ENTER** key.
- ③ Select **DEFAULTS**, press the Cursoe right (▶) key to select **RESET**.
- ④ Press the numeric keys as shown below.
Press **[1]**, **[3]**, **[9]**, **[7]**, then press the **ENTER** key.

When resetting is done according to this method, all settings, including the settings for password and parental level, will be reset to the factory defaults.

DVD player unit

Symptom	Cause	Remedy
Playback does not start when the ▶/ key is pressed.	<ul style="list-style-type: none"> ● There is no disc in the player. ● There are no signals recorded on the side of the disc being played. 	<ul style="list-style-type: none"> ● Load a disc and press the ▶/ key. ● Turn the disc over and properly place it on the disc tray.
Playback starts but no image/sound is seen heard.	<ul style="list-style-type: none"> ● The TV is not turned on. ● The connection cords are not properly connected. 	<ul style="list-style-type: none"> ● Turn on the TV. ● Properly reconnect the connection cords. → [10] → [11]
The picture is disrupted when the image is fast forwarded or fast reversed.	<ul style="list-style-type: none"> ● The picture is slightly disrupted during fast forward and fast reverse operations. 	<ul style="list-style-type: none"> ● This is not a malfunction.
No sound is heard.	<ul style="list-style-type: none"> ● The audio output cords are not properly connected. ● The volume control of the TV or amplifier is not adjusted properly. ● The player is in a special playback mode. 	<ul style="list-style-type: none"> ● Properly connect the audio cords. → [10] → [11] ● Set the sound volume to an appropriate level. ● Press the ▶/ key to resume normal playback mode.
The picture does not look good or the picture/sound quality is poor.	<ul style="list-style-type: none"> ● A nearby device is generating noise. ● The disc is dirty. ● The disc is damaged. ● There is condensation on the optical lens. 	<ul style="list-style-type: none"> ● Separate this unit as far as possible from the device you think is generating the noise. ● Refer to the "Disc handling precautions" section and wipe dirt from the disc. → [9] ● Use a new disc. ● Refer to the "Caution on condensation" section and evaporate the condensation. → [9]
It takes a while for the disc to start playing.	<ul style="list-style-type: none"> ● Time is required for the unit to detect the disc type and size and for the rotation of the motor to stabilize. This is not a malfunction. 	<ul style="list-style-type: none"> ● Approximately 10 to 20 seconds are required for a disc to start playing, although the time differs depending on the disc.
The tray opens automatically.	<ul style="list-style-type: none"> ● The disc is not placed horizontally. 	<ul style="list-style-type: none"> ● Properly place the disc on the tray.
The top and bottom of the screen cannot be seen, or the screen becomes black-and-white.	<ul style="list-style-type: none"> ● The video format of the disc being played does not match that of the connected TV monitor. 	<ul style="list-style-type: none"> ● Refer to the "Video formats" section ,and use a disc with the appropriate video format for your TV or a TV with the appropriate video format for the disc. → [8]
The subtitle is not displayed.	<ul style="list-style-type: none"> ● The DVD disc being played does not contain the recording of subtitles. ● The subtitle mode is set to off. 	<ul style="list-style-type: none"> ● The subtitle cannot be displayed when the DVD disc being played does not contain the recording of subtitles. ● Press the SUBTITLE ON/OFF key to switch on the subtitle mode. → [29]
The voice (or subtitle) language cannot be changed.	<ul style="list-style-type: none"> ● The DVD disc being played does not contain the recording of more than one audio (or subtitle) language. 	<ul style="list-style-type: none"> ● The voice (or subtitle) language cannot be changed when the DVD disc being played does not contain the recording of more than one voice (or subtitle) language.
The viewing angle cannot be changed.	<ul style="list-style-type: none"> ● The DVD disc being played does not contain the recording of more than one angle. ● You are attempting to switch the angle in a DVD section where more than one angle is not recorded. 	<ul style="list-style-type: none"> ● The viewing angle cannot be changed when the DVD disc being played does not contain the recording of more than one angle. ● More than one viewing angle may be recorded only in limited sections in a disc.

DVD player unit

Symptom	Cause	Remedy
Playback will not start even after a title is selected.	<ul style="list-style-type: none"> A viewing restriction (PARENTAL) has been set for the disc. 	<ul style="list-style-type: none"> Check the viewing restriction level (PARENTAL) setting.
The parental level cannot be changed.	<ul style="list-style-type: none"> You have forgotten the password. 	<ul style="list-style-type: none"> Set the initial setup to the factory setup with the following procedure. <ol style="list-style-type: none"> Press the MENU key on the remote to enter SETUP MENU. Select the PREFERENCE, then press the ENTER key. Select DEFAULTS, press the Cursor right (▶) key to select RESET. Press the numeric keys as shown below. Press 1, 3, 9, 7, then press the ENTER key. The password set at the time of shipping from the factory is "0000".
The voice or subtitle language selected in the initial setting is not played.	<ul style="list-style-type: none"> The DVD disc being played does not contain the recording of the selected voice or subtitle language. The initial playback language is specified by the DVD disc. The DVD specifications provide for selection at the menu screen. 	<ul style="list-style-type: none"> Use a DVD disc containing the recording of the selected voice or subtitle language. Press SUBTITLE or the AUDIO key on the remote and select the language. → [29] Select at the menu screen of the disc.
Menu screen messages are not shown in the desired language.	<ul style="list-style-type: none"> The menu language function (MENU) is not set to desired language. 	<ul style="list-style-type: none"> Select disc menu language. → [22]
A VCD cannot be played using menus.	<ul style="list-style-type: none"> The VCD disc being played is not compatible with P.B.C. 	<ul style="list-style-type: none"> Menu playback is available only with VCD discs recorded with P.B.C.
"THE PLAYER IS LOCKED" will be displayed on the TV screen (the  mark on the display of the main unit will be lit), and disk tray opening/closing operation will not be accepted.	<ul style="list-style-type: none"> Operation is prohibited. 	<ul style="list-style-type: none"> Press the MENU key of the remote control for several seconds while holding the stop (■) key on the main unit pressed. "THE PLAYER IS UNLOCKED" will be displayed (the  mark will not be lit, and operation will become possible.

Remote control unit

Symptom	Cause	Remedy
Remote control operation is not possible.	<ul style="list-style-type: none"> Batteries are exhausted. The remote control is too far away from the system, the controlling angle is deviated or there is an obstacle in between. 	<ul style="list-style-type: none"> Replace with new batteries. Operate the unit inside the remote controllable range.

Inhibition icon

Symptom	Cause	Remedy
 <p>The inhibition icon is displayed and remote control is not possible.</p>	<ul style="list-style-type: none"> Playback is restricted intentionally by the software producer. 	<ul style="list-style-type: none"> The operation is inhibited. Please try another operation.

Manufactured under license from Dolby Laboratories. "Dolby" and the double-D symbol are trademarks of Dolby Laboratories.

"DTS" and "DTS Digital Out" are trademarks of Digital Theater Systems, Inc.



[Type]		[Video Section]	
System	DVD video player	Video output format	NTSC/PAL
Signal read system	Semiconductor laser	Video compression	
Wave length	For DVD; 640 to 660 nm	DVD	MPEG-2
	For CD; 770 to 810 nm	Composite video output level	
Power class	Class 2 (IEC)	1 Vp-p (75 Ω load, sync. negative)
[D/A Conversion Section]		S-video output level	
D/A conversion	24 Bit	(Y-signal)	1 Vp-p (75 Ω load, sync. negative)
Oversampling ... 8 fs (Sampling frequency; 44.1, 48 kHz)		(C-signal)	
..... 4 fs (Sampling frequency; 96 kHz)		NTSC	0.286 Vp-p (75 Ω)
		PAL	0.300 Vp-p (75 Ω)
[Audio section]		Component Video output level (For U.S. Military)	
Frequency response		(Y-signal)	1 Vp-p (75 Ω)
Sampling frequency ; 44.1 kHz	4 Hz ~ 20 kHz	(Cb-signal)	0.648 Vp-p (75 Ω)
Sampling frequency ; 48 kHz	4 Hz ~ 22 kHz	(Cr-signal)	0.648 Vp-p (75 Ω)
Sampling frequency ; 96 kHz	4 Hz ~ 38 kHz	RGB output level (SCART) (For Europe)	0.7 Vp-p (75 Ω)
Signal to noise ratio	More than 98 dB	Horizontal resolution	More than 480 lines
Dynamic range	More than 92 dB	Video signal to noise ratio	More than 70 dB
Total harmonic distortion	Less than 0.005 % (1 kHz)		
Channel separation	More than 95 dB (1 kHz)	[General]	
Wow and flutter	Below measurable limit	Power consumption	12 W
Analog output level/impedance	2 V / 570 Ω	Dimensions	W : 440 mm (17-5/16")
Digital output level/impedance			H : 75 mm (2-15/16")
COAXIAL	0.5 Vp-p / 75 Ω		D : 282 mm (11-1/8")
OPTICAL	-21 dBm ~ -15 dBm (Wave length 660 nm)	Weight (net)	3.1 kg (6.8 lb)

 **KENWOOD follows a policy of continuous advancements in development. For this reason specifications may be changed without notice.**

- Sufficient performance may not be exhibited at extremely cold locations (Where water freezes).

KENWOOD

For your records

Record the serial number, found on the back of the unit, in the spaces designated on the warranty card, and in the space provided below. Refer to the model and serial numbers whenever you call upon your dealer for information or service on this product.

Model _____ Serial Number _____

Free Manuals Download Website

<http://myh66.com>

<http://usermanuals.us>

<http://www.somanuals.com>

<http://www.4manuals.cc>

<http://www.manual-lib.com>

<http://www.404manual.com>

<http://www.luxmanual.com>

<http://aubethermostatmanual.com>

Golf course search by state

<http://golfingnear.com>

Email search by domain

<http://emailbydomain.com>

Auto manuals search

<http://auto.somanuals.com>

TV manuals search

<http://tv.somanuals.com>