

KENWOOD

Marine iPod/USB Receiver

KMR-700U

INSTRUCTION MANUAL

Kenwood Corporation



Take the time to read through this instruction manual.

Familiarity with installation and operation procedures will help you obtain the best performance from your new Marine iPod/USB Receiver.

For your records

Record the serial number, found on the back of the unit, in the spaces designated on the warranty card, and in the space provided below. Refer to the model and serial numbers whenever you call upon your Kenwood dealer for information or service on the product.

Model KMR-700U Serial number _____

US Residence Only

Register Online

Register your Kenwood product at
www.Kenwoodusa.com

© B64-4406-10/01 (KW)

Contents

Before use	3	Favorite Control	17
Getting Started	4	Favorite Preset Memory	
Connecting iPod or USB device		Favorite Preset Recall	
Removing iPod or USB device		Favorite Preset Memory Delete	
Clock & Date Adjustment		Favorite Name Setting	
Basic Operation	6	Satellite Radio tuner control (Optional accessory)	19
General functions		Basic Operation	
Tuner functions		Category and Channel Search	
iPod & USB device play functions		Remote control (Optional accessory) setup	20
Menu System	8	Remote control ID setup	
Display Settings	9	Remote control ID delete	
Display Type Selection		Dual zone control setup	
Display Side Selection		Appendix	21
Text Display Selection		Accessories/ Installation Procedure	23
Auxiliary Input Display Setting		Connecting Wires to Terminals	24
Tuner Operation	11	Installation	25
Auto memory entry		Troubleshooting Guide	26
iPod/USB device Operation	12	Specifications	28
Drive Search			
Music Search			
Music Search for iPod			
Searching for Music by Initial			
Related Search			
Audio Adjustments	14		
Audio Control			
Adjusting the detail of Audio Control			
Audio Setup			
Audio Preset Memory			
Audio Preset Recall			
Dual zone control			
Other Functions	16		
Backup memory delete			

The "AAC" logo is trademark of Dolby Laboratories.

iPod is a trademark of Apple Inc., registered in the U.S. and other countries.

iPhone is a trademark of Apple Inc.

"Made for iPod" means that an electronic accessory has been designed to connect specifically to iPod and has been certified by the developer to meet Apple performance standards.

"Works with iPhone" means that an electronic accessory has been designed to connect specifically to iPhone and has been certified by the developer to meet Apple performance standards.

Apple is not responsible for the operation of this device or its compliance with safety and regulatory standards.

Before use

▲WARNING

To prevent injury or fire, take the following precautions:

- To prevent a short circuit, never put or leave any metallic objects (such as coins or metal tools) inside the unit.

▲CAUTION

This unit, except for the panel, and Hideaway Unit are not provided with waterproof feature. Install this unit, except for the panel, and the hideaway unit to the water-free place.

Water may get inside the unit when the panel is open. Take caution to avoid water from getting inside the unit, when connecting or replacing iPod or USB device.

Water inside may damage this unit, generate smoke or fire, or cause electrical shock.

How to reset your unit

- If this unit or the connected unit fails to operate properly, press the Reset button.

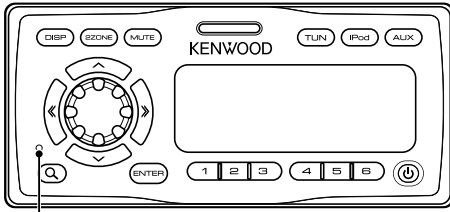

Reset button

Cleaning the Unit

If the faceplate of this unit is stained, wipe it with a dry soft cloth such as a silicon cloth.

If the faceplate is stained badly, wipe the stain off with a cloth moistened with neutral cleaner, then wipe it again with a clean soft dry cloth.



- Applying spray cleaner directly to the unit may affect its mechanical parts. Wiping the faceplate with a hard cloth or using a volatile liquid such as thinner or alcohol may scratch the surface or erase printed characters.

About remote controls

Maximum of 3 remote controls (KCA-RC107MR; optional accessory) can be connected to this unit. For details on how to use the remote control, refer to the operation manual attached to it.

When connecting the remote control to this unit, you should register the remote control ID. For details, refer to <Remote control ID setup> (page 20).



- If you experience problems during installation, consult your Kenwood dealer.
- When you purchase optional accessories, check with your Kenwood dealer to make sure that they work with your model and in your area.
- Characters that conform to ISO 8859-1 can be displayed.
- In this document, the description indicator will light means a status is displayed. Refer to <Display Type Selection> (page 9) for the details of the status display.
- The illustrations of the display and the panel appearing in this manual are examples used to explain more clearly how the controls are used. Therefore, what appears on the display in the illustrations may differ from what appears on the display on the actual equipment, and some of the illustrations on the display may be inapplicable.
- Do not disassemble the product. The faceplate of the main unit has a water resistant rating of IPX5. If the facepanel is disassembled the integrity of the IPX5 can be compromised.
- Use this unit with the faceplate closed, except when connecting iPod or USB device. IPX5 waterproof feature is only provided when the faceplate is closed.

Getting Started

Connecting iPod or USB device

1 Press the Release button.

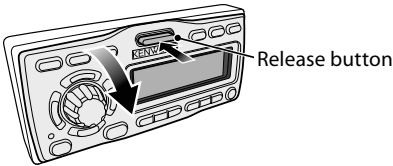

Pull the faceplate open, while supporting it with your hand.

2 Remove the terminal cover.

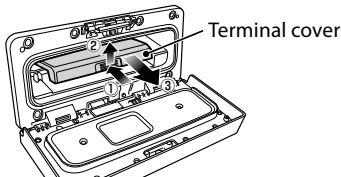

3 Pull out the terminal to be used, and then replace the terminal cover.

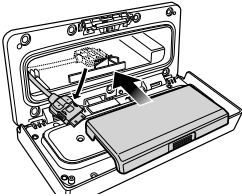

4 Connect iPod and USB device to the terminal.

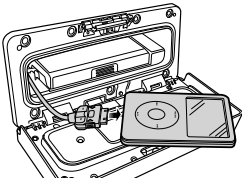

5 Insert the connected iPod and USB device into the cushion bag (accessory), and place it on the terminal cover.

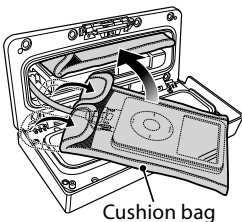

- Be sure to use the cushion bag which protects iPod or USB device against shock.
- Do not overload the opened faceplate. If you do so, the faceplate may be damaged.

6 Close the faceplate.

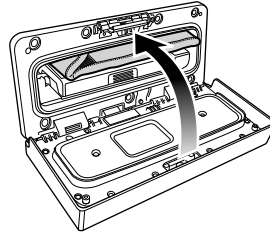

Removing iPod or USB device

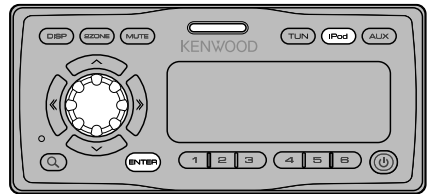

1 Enter Remove mode

Press the [iPod] button for at least 2 second. "REMOVE" is displayed.

2 Select the device to be removed

Select the device to be removed by turning the [VOL] knob, and press the [ENTER] button.

3 Turn the [VOL] knob to select "YES", and then press the [ENTER] button.

4 Press the Release button.

Pull the faceplate open, while supporting it with your hand.

5 Remove the device.

Only the device selected in step 2 can be removed.



- Keep the unused terminal in the terminal cover to avoid being damaged.

Cancelling the Remove mode

Press the [iPod] button for at least 1 second.

Clock & Date Adjustment

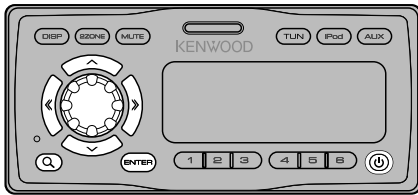

1 Turn the power ON

Press the [] button.

2 Enter Menu mode

Press the [Q] button for at least 1 second.

"MENU" is displayed.

3 Select the "Clock Adjust" display

Turn the [VOL] knob.

4 Enter Clock adjustment mode

Press the [ENTER] button for at least 1 second.

The clock display blinks.

5 Adjusting Clock

Adjustment item	Operation
Selecting the item (hours or minutes)	Press the [<<] or [>>] button.
Adjust each item	Turn the [VOL] knob.

6 Exit Clock adjustment mode

Press the [Q] button.

7 Select the "Date Adjust" display

Turn the [VOL] knob.

8 Enter Date adjustment mode

Press the [ENTER] button for at least 1 second.

The date display blinks.

9 Adjusting Date

Operation type	Operation
Selecting the item (month, day, or year)	Press the [<<] or [>>] button.
Adjust each item	Turn the [VOL] knob.

10 Exit Date adjustment mode

Press the [Q] button.

11 Select the "Date Mode" display

Turn the [VOL] knob.

12 Enter Date format mode

Press the [ENTER] button for at least 1 second.

The date is displayed.

13 Select Date format

Turn the [VOL] knob.

Select from 7 types.

14 Exit Menu mode

Press the [Q] button twice.



- The clock and date adjustment is defaulted when power supply cable is removed from the battery.

Basic Operation

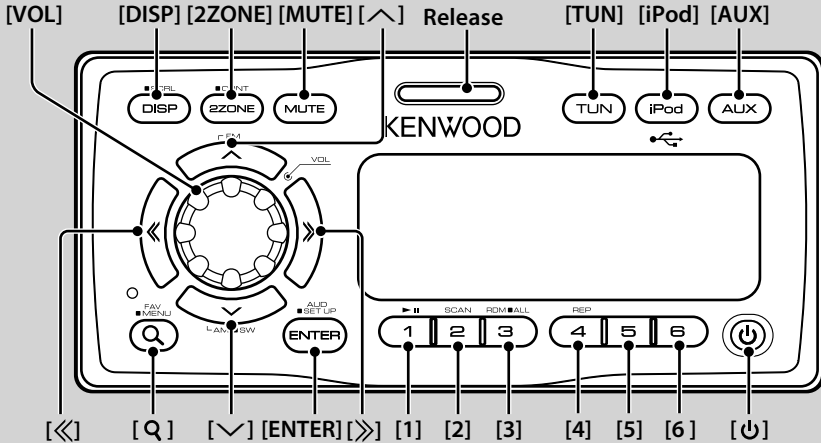

General functions

Power button: [⏻]

Power turns ON and OFF each time this button is pressed.

Volume control: [VOL] knob

Turn the knob to adjust the volume.

Volume mute: [MUTE]

Volume returns to the original level, when this button is pressed again.

Plays music from iPod or USB device: [iPod]

Switches the playing source to iPod or USB device each time this button is pressed.

Tuner/SIRIUS radio reception: [TUN]

Switches between Tuner and SIRIUS Satellite Radio (optional accessory) reception each time this button is pressed.

Switching to AUX source: [AUX]

Switches the source to the device connected to AUX IN.

Dual Zone control: [2ZONE]

Output different sounds to front and rear channels from different sources. For further details, refer to <Dual zone control> (page 16).

Subwoofer output: [∨]

Switches between ON ("SUBWOOFER ON") and OFF ("SUBWOOFER OFF") each time this button is pressed for at least 2 seconds.

Switching display: [DISP]

Changing the information displayed. Refer to <Display Settings> (page 9).

Text/Title scroll: [DISP]

Scrolls the text display when pressed for at least 1 second.

Drop open the faceplate: Release

Tuner functions

FM band: [^]

Switches between FM1, FM2, and FM3 each time the [^] button is pressed.

AM band: [v]

Switches to AM.

Tuning: [<<] / [>>]

Changes the frequency.



- Use the "Seek Mode" in <Menu system> (page 8) to change the tuning mode.
- During reception of stereo stations the "ST" indicator is ON.

Preset memory: [1] - [6]

Memorizes the station selected when pressing for at least 2 seconds.

Preset tuning: [1] - [6]

Recalls the memorized station.

iPod & USB device play functions

Pause and play: [1]

Switches between pause and play each time this button is pressed.

Music search: [<<] / [>>]

Changes the music when this button is pressed. Fast reverses or forwards the music while pressing. (No sound is output while playing audio file.)

Folder search: [^] / [v]

Changes the folder containing the audio file.

Search mode: [Q]

Allows music search or favorite preset/recall. Refer to <Music Search> (page 12), <Music Search for iPod> (page 12), and <Favorite Control> (page 17).

File/ Folder repeat play: [4]

Switches between File Repeat ("File Repeat ON"), Folder Repeat ("Folder Repeat ON"), and OFF ("Repeat OFF") when pressed.



- The folder repeat operation cannot be performed while iPod is playing.

Scan play: [2]

Successfully plays the intro of the music in the folder. When Scan Play is turned on, "File Scan ON" is displayed.



- The Scan play operation cannot be performed while iPod is playing.
- Location played with "File Scan"
 - Audio file: First 10 seconds
 - Music Editor media: First 10 seconds or the part picked by Intro Skip.
 - During Intro Skip, turn the control knob left or right to change the song.
 - The scan method depends on the Music Editor setting. See the Music Editor help for details.

Random play: [3]

Randomly plays the music in the folder. When Random Play is turned on, "Folder Random ON" is displayed.

All random play: [3]

All music in iPod or USB device are played at random. All random play function is turned ON when pressed for at least 1 second.

When All random Play is turned on, "All Random ON" is displayed.



- The time required to turn on the all random function may become longer depending on the number of songs in iPod or the folder structure.
- If the browse item is changed to search for music while the all random function is on, the all random function is turned off and the songs in the browse item are played at random.

Menu System

Set up the following functions.

Item	Setting	Entry	Setting overview	Condition	Page
"Skip Search"	"0.5%"/"1%"/ "5%"/"10%"		Sets the ratio of skip performed with <Music Search for iPod>.	iPod	12
"Beep"	"OFF"/"ON"		Setting the operation check sound (beep sound) ON/OFF.	—	—
"Clock Adjust"	—	1 sec.	Sets the clock.	—	5
"Date Adjust"	—	1 sec.	Sets the date.	—	5
"Date Mode"	—	1 sec.	Sets the date display format.	—	5
"ILM Dimmer"	"Auto"/"Manual"/ "OFF"		Sets whether the key illumination is dimmed in conjunction with the light switch of the vessel or it is dimmed constantly.	—	**
"ILM Effect"	"OFF"/"ON"		Sets whether the key illumination brightness is changed in conjunction with the key operation.	—	—
"DISP Dimmer"	"Auto"/"Manual"/ "OFF"		Sets whether the display illumination is dimmed in conjunction with the light switch of the vessel or it is dimmed constantly.	—	**
"Contrast"	"1" – "10"		Adjusting the display contrast.	—	—
"DISP N/P"	"POS1 1"/"2" /"NEGA 1"/"2"		Switches the panel display between positive or negative.	—	**
"AMP"	"OFF"/"ON"		Turns on/off the built-in amplifier.	—	**
"Supreme"	"OFF"/"ON"		Turns ON/OFF the Supreme function.	USB	**
"Seek Mode"	"Auto1"/"Auto2"/ "Manual"		Selects the tuning mode of the radio.	TUN	**
"Seek Mode"	"Channel"/"Preset"		Sets the seek mode of satellite radio.	SAT	19
"Auto Memory"	—	2 sec.	Memorizes six stations with good reception automatically.	TUN	11
"CRSC"	"OFF"/"ON"		Switches to Monaural to decrease noise when reception is poor.	FM	—
"ESN="	—		Displays the Electronic Serial Number of satellite radio.	SAT	—
"Name Set"	—	1 sec.	Sets the display when switched to AUX source.	AUX	10
"Scroll"	"Auto"/"Manual"		Specifies whether the text is scrolled automatically.	—	—
"Favorite Delete"	—	1 sec.	Deletes Favorite Preset Memory.	—	17
"Built in AUX"	"OFF"/"ON"		Sets whether to display AUX during source selection.	—	—
"Audio Preset"	—	1 sec.	Registering the value setup by Audio Control.	—	15
"Backup MEM DEL"	—	1 sec.	Initializes the settings of "MENU", etc.	—	16
"SYS F/W VER"	—		Display the firmware version and update the firmware.	—	—

*Factory setting

** Refer to <Menu Glossary> (page 22).

Displayed item is depending on currently selected source or mode. The mark in Condition column shows the condition to which the item is displayed.

USB : Can be set during USB source.

iPod : Can be set only during playback of the iPod source.

TUN : Can be set during Tuner source.

FM : Can be set during FM reception.

AUX : Can be set while accessing AUX source.

SAT : Can be set during Satellite radio source.

— : Can be set during all sources.



- Refer to the respective page for information on how to set the items with reference page number.
- Only the items available to the current source are displayed.
- Strong electrical fields (such as from power lines) may cause unstable sound quality when CRSC is turned ON. In such a situation, turn it OFF.

1 Enter menu mode

Press the [**Q**] button for at least 1 second.

"MENU" is displayed.

2 Select the menu item

Tune the [**VOL**] knob.

3 Set the menu item

Press the [**<<**] or [**>>**] button.

Usually, menu items are set by pressing the [**<<**] or [**>>**] button. Some items, however, requires that the [**ENTER**] button being pressed for at least 1 or 2 seconds, before the settings can be made. **1 sec.** or **2 sec.** icon is displayed in the "Entry" column for such an item.

4 Exit menu mode

Press the [**Q**] button.

Display Settings

Display Type Selection

Shown below are examples of display types.

Display	Display Type
"TYPE [A]"	Displays 4 lines of text.
"TYPE [B]"	Displays 3 lines of text and the status (ON/OFF indicator for each function).
"TYPE [C]"	Displays 3 lines of text.
"TYPE [D]"	Displays 2 lines of text and the status (ON/OFF indicator for each function).

1 Enter Display setup mode

Press the [DISP] button.

2 Select the Display type select item

Tune the [VOL] knob.

Select the "Type Select" display.

3 Enter Display type select mode

Press the [ENTER] button.

4 Select the Display type

Tune the [VOL] knob.

5 Exit Display type select mode

Press the [DISP] button.

To exit the display setup mode, press the [DISP] button for at least 1 second.



- The source icon and the text title at left side of the display can be changed.
- To change the text to be displayed, refer to <Text Display Selection> (page 10).

Display Side Selection

Setup the left side of the display.

1 Enter Display setup mode

Press the [DISP] button.

2 Select the Display side select item

Tune the [VOL] knob.

Select the "Side Select" display.

3 Enter Display side select mode

Press the [ENTER] button.

4 Select the Display side

Tune the [VOL] knob.

You can select among the title of the displayed text, icon for the source being played, and none.

5 Exit Display side select mode

Press the [DISP] button.

To exit the display setup mode, press the [DISP] button for at least 1 second.

Display Settings

Text Display Selection

The following display text appears differently depending on display type setting;

In Tuner source

Information	Display (TypeA,B/ C,D)
Frequency	"Frequency"/"FREQ"
Clock	"Clock"/"Clock"
Date	"Date"/"Date"
Display off	"Blank"/"Blank"

In iPod/ USB source

Information	Display (TypeA,B/ C,D)
Music title & Artist name	"Title/Artist"/"Title"
Album name & Artist name	"Album/Artist"/"Album"
Folder name	"Folder Name"/"Folder"
File name	"File Name"/"File"
Play time & Music number	"P-Time"/"P-Time"
Clock	"Clock"/"Clock"
Date	"Date"/"Date"
Display off	"Blank"/"Blank"

In Auxiliary input source

Information	Display (TypeA,B/ C,D)
AUX name	"Source Name"/"SRC Name"
Clock	"Clock"/"Clock"
Date	"Date"/"Date"
Display off	"Blank"/"Blank"

In SIRIUS source (Optional)

Information	Display (TypeA,B/ C,D)
Channel Name	"Channel Name"/"CH Name"
Music Title	"Song Title"/"Song"
Artist Name	"Artist Name"/"Artist"
Composer Name	"Composer Name"/"Composer"
Category Name	"Category Name"/"Category"
Label Name	"Label Name"/"Label"
Comment	"Comment"/"Comment"
Channel Number	"Channel Number"/"CH Number"
Clock	"Clock"/"Clock"
Date	"Date"/"Date"
Display off	"Blank"/"Blank"

1 Enter Display setup mode

Press the [DISP] button.

2 Select the Display text select item

Tune the [VOL] knob.

Select the "Text Select" display.

3 Enter Display text select mode

Press the [ENTER] button.

4 Select the text display part

Press the [^] or [v] button.

The selected text display part blinks.

5 Select the Display text

Tune the [VOL] knob.

6 Exit Display text select mode

Press the [DISP] button.

To exit the display setup mode, press the [DISP] button for at least 1 second.



- If the selected display item does not have any information, alternative information is displayed.
- When selecting "Folder Name" while playing an iPod, names will be displayed depending on currently selected browsing items.
- If all characters cannot be displayed while playing an iPod, the file number in the list is displayed.

Information	Display
Music title	"TITLE****"
Folder name	"FLD****"
File name	"FILE****"

Auxiliary Input Display Setting

Selecting the display when changing to Auxiliary input source.

1 Select Auxiliary input source

Press the [AUX] button.

2 Select Name set item

Select the "Name Set" display.

For how to select Menu items, refer to <Menu System> (page 8).

3 Enter Name set mode

Press the [ENTER] button for at least 1 second.

The presently selected Auxiliary input display is displayed.

4 Select the Auxiliary input display

Turn the [VOL] knob.

"AUX"/"DVD"/"PORTABLE"/"GAME"/"VIDEO"/"TV"

5 Exit Name set mode

Press the [Q] button.



- When operation stops for 10 seconds, the name at that time is registered, and the Auxiliary input display setting mode closes.

Tuner Operation

Auto memory entry

Putting stations with good reception in the memory automatically.

1 Select Auto memory item

Select the "Auto Memory" display.

For how to select Menu items, refer to <Menu System> (page 8).

2 Execute Auto Memory Entry

Press the [ENTER] button for at least 2 seconds.

When 6 stations that can be received are put in the memory, auto memory entry closes.

iPod/USB device Operation

Drive Search

Selecting the device inserted in the Multi Card Reader.

1 Put the playback to pause

Press the [1] button.

2 Select a device

Press the [^] or [v] button.

3 Restart playback

Press the [1] button.



- This unit is compliant with Multi Card Readers with a maximum of 4 slots.
- If a device is inserted during connection of the Multi Card Reader, it is not recognized. Select the Remove mode with reference to <Removing iPod or USB device> (page 4), remove the Card Reader, and then insert the memory.
- When Dual zone control function is on, <Drive Search> function can be used only for Front channel.

Function of USB source

Music Search

Selecting the music you want to listen to from the device or media being played.

1 Enter Search mode

Press the [Q] button.

"SEARCH/FAVORITE" is displayed.

2 Enter Music search mode

Turn the [VOL] knob.

Displays the current Audio file name.

3 Search for music

Operation type	Operation
Movement between folders/files	Turn the [VOL] knob.
Selection of folder/file	Press the [ENTER] button.
Return to previous folder	Press the [◀] button.
Return to root folder	Press the [◀] button for at least 1 second.

"◀" or "▶" beside the displayed folder name indicates that this folder is preceded or followed by another folder.

A file name is displayed with "♪" indicator.

A folder name is displayed with "■" indicator.

Canceling the Search mode

Press the [Q] button twice.



- Music Search cannot be performed during Random play.

Function of iPod source

Music Search for iPod

Search for the song (in iPod) you want to play.

1 Enter Search mode

Press the [Q] button.

"SEARCH/FAVORITE" is displayed.

2 Enter Music search mode

Turn the [VOL] knob.

Displays the current music name.

3 Search for music

Operation type	Operation
Movement between items	Turn the [VOL] knob.
Skip Search	Press the [◀◀] or [▶▶] button.
Selection of item	Press the [ENTER] button.
Return to previous item	Press the [^] button.
Return to Top menu	Press the [^] button for at least 2 second.
Search by initial	Press the [Q] button for at least 1 second. Refer to the next section <Searching for Music by Initial>.

Scroll bar is displayed on the right side of the screen.

Canceling the Search mode

Press the [Q] button twice.



- Skip Search: The number of songs to be skipped is determined by the ratio of the total number of songs in the list which is selected. Set the ratio with "Skip Search" in <Menu System> (page 8). Keep pushing Control knob for 3 seconds or longer skips songs at 10% regardless of the setting.
- If no characters included in a song name can be displayed, the browse item name and digits are displayed.

Items	Display	Items	Display
Playlists	"PLIST****"	Podcasts	"PDC****"
Artists	"ART****"	Genres	"GEN****"
Albums	"ALB****"	Composers	"COM****"
Songs	"PRGM****"		

Function of iPod source

Searching for Music by Initial

You can select an alphabetic character from the list in the browse item (artist, album, etc.) selected now.

1 Enter Search mode

Press the [Q] button.

2 Enter Music search mode

Turn the [VOL] knob.

Displays the current music name.

3 Start the alphabet search

Press the [Q] button for at least 1 second.

"A B C" is displayed.

4 Select the initial to be searched for

Operation type	Operation
Move to the next character.	Turn the [VOL] knob.
Move to the next row.	Press the [^] or [v] button.

5 Determine the selected initial

Press the [ENTER] button.

Start search. When search is completed, the music search mode will start again at the last selected character position.

Canceling the alphabet search

Press the [Q] button.



- The time of search by alphabet may become long depending on the number of songs in iPod or the folder structure.
- When selecting an initial in the alphabet search, entering "*" searches symbols and entering "1" searches digits.
- If the first character string begins with an article "a", "an", or "the" in the alphabet search mode, it is searched for by the next word.

Function of iPod source

Related Search

Browses for music of the same artist or genre as the one being played.

1 Enter Related Search mode

Press the [5] button.

2 Select browsing item

Turn the [VOL] knob and press the [ENTER] button when the desired browse item is selected.

Display	Browses music
"Browse Artist"	Displays the album of the same artist.
"Browse Album"	Displays music in the album in which the one being played is included.
"Browse Genre"	Displays the artist of the same genre.
"Browse Composer"	Displays the album including music created by the same artist.

3 Search for music

Operation type	Operation
Movement between items	Turn the [VOL] knob.
Selection of item	Press the [ENTER] button.
Return to previous item	Press the [^] button.

Canceling the Related Search

Press the [5] button.



- Related search cannot be performed while playing a Podcast.
- When the music being played has no information on browsing items or no music was found, "Not Found" is displayed.

Audio Adjustments

Audio Control

You can adjust following Audio Control items;

Adjustment Item	Display	Range
Rear volume	"Rear volume"	0 — 35
Subwoofer level	"Sub-W Level"	-15 — +15
System Q	"User", "Rock", "Pops", "Easy", "Top40", "Jazz", "Game", "Natural"	User setting, Rock, Pops, Easy, Top 40, Jazz, Game, Natural
Bass level	"Bass Level"	-8 — +8
Middle level	"Middle Level"	-8 — +8
Treble level	"Treble Level"	-8 — +8
Balance	"Balance"	Left 15 — Right 15
Fader	"Fader"	Rear 15 — Front 15



- Source tone memory: You can set Bass, Middle, and Treble for each source.
- "User": The ranges selected lastly for Bass level, Middle level, and Treble level are recalled automatically.

1 Select the source to adjust

Press the [TUN], [iPod], or [AUX] button.

2 Enter Audio Control mode

Press the [ENTER] button.

3 Select the Audio item to adjust

Turn the [VOL] knob.

4 Adjust the Audio item

Press the [<<] or [>>] button.

5 Exit Audio Control mode

Press the [ENTER] button.

Adjusting the detail of Audio Control

You can adjust the following Basic Audio Items in detail: Bass level, Middle level, and Treble level.

Bass level

Adjustment Item	Display	Range
Bass Center Frequency	"Bass FREQ"	40, 50, 60, 70, 80, 100, 120, 150 Hz
Bass Q Factor	"BassQ Factor"	1.00, 1.25, 1.50, 2.00
Bass Extend	"Bass EXT"	OFF, ON

Middle level

Adjustment Item	Display	Range
Middle Center Frequency	"MID FREQ"	0.5, 1.0, 1.5, 2.0 kHz
Middle Q Factor	"MID Q Factor"	1.0, 2.0

Treble level

Adjustment Item	Display	Range
Treble Center Frequency	"TRE FREQ"	10.0, 12.5, 15.0, 17.5 kHz

1 Select the Basic Audio item

For how to select Basic Audio items, see <Audio Control> (page 14).

2 Enter Detail adjustment mode of Audio Control

Press the [ENTER] button for at least 1 second.

3 Select the Detail Audio item to adjust

Turn the [VOL] knob.

4 Adjust the Detail Audio item

Press the [<<] or [>>] button.

5 Exit the Detail Audio Control mode

Press the [ENTER] button for at least 1 second.

Mode returns to Audio Control mode.



- When you set the Bass Extend to ON, low frequency response is extended by 20%.

Audio Setup

You can set up the Sound system with the below adjustments;

Adjustment Item	Display	Range
Front High Pass Filter	"HPF Front"	Through, 40, 60, 80, 100, 120, 150, 180, 220 (Hz)
Rear High Pass Filter	"HPF Rear"	Through, 40, 60, 80, 100, 120, 150, 180, 220 (Hz)
Low Pass Filter	"LPF SW"	50, 60, 80, 100, 120, Through (Hz)
Subwoofer Phase	"SW Phase"	Reverse (180°), Normal (0°)
Volume offset	"Volume Offset"	-8 — ±0 (AUX: -8 — +8)
Speaker Setting	"SP SEL"	OFF, 5/4inch, 6x9/6inch, O.E.M.
Loudness	"Loudness"	ON, OFF



- Volume offset: Sets each source's volume in relation to the main volume.

1 Select the source to adjust

Press the [TUN], [iPod], or [AUX] button.

2 Enter Audio Setup mode

Press the [ENTER] button for at least 1 second.

3 Select the Audio Setup item to adjust

Turn the [VOL] knob.

4 Adjust the Audio setup item

Press the [<<] or [>>] button.

5 Exit Audio Setup mode

Press the [ENTER] button.

Audio Preset Memory

Registering the values setup within Sound Controls. These settings cannot be erased by the Reset button.

1 Setup Sound Control

Refer to the following operations to setup the Sound Control.

- <Audio Control> (page 14)
- <Adjusting the detail of Audio Control> (page 14)
- <Audio Setup> (page 14)

2 Select Audio Preset item

Select the "Audio Preset" display.

For how to select Menu items, refer to <Menu System> (page 8).

3 Enter Audio Preset mode

Press the [ENTER] button for at least 1 second.

"Recall" is displayed.

4 Select the Audio Preset Memory

Turn the [VOL] knob.

Select the "Memory" display.

5 Determine whether to put the Audio Preset in the memory

Press the [ENTER] button.

"Memory?" is displayed.

6 Put the Audio Preset in the memory

Turn the [VOL] knob to select "YES", and then press the [ENTER] button.

"Memory Completed" is displayed.

7 Exit Audio Preset mode

Press the [Q] button.



- The memory only holds one audio setting and not settings for each source.
- The following items cannot be registered.
Volume, Balance, Fader, Loudness, Volume offset, Dual Zone System, Rear Volume

Audio Preset Recall

Recalling the sound setup registered by <Audio Preset Memory> (page 15).

1 Select the source

For how to select source item, refer to <General function> of <Basic Operation> (page 6).

2 Select Audio Preset item

Select the "Audio Preset" display.

For how to select Menu items, refer to <Menu System> (page 8).

3 Enter Audio Preset mode

Press the [ENTER] button for at least 1 second.

4 Select the Audio Preset Recall

Turn the [VOL] knob.

Select the "Recall" display.

5 Determine whether to recall the Audio Preset

Press the [ENTER] button.

"Recall?" is displayed.

6 Recall the Audio Preset

Turn the [VOL] knob to select "YES", and then press the [ENTER] button.

"Recall Completed" is displayed.

7 Exit Audio Preset mode

Press the [Q] button.



- The User memory of "System Q" in <Audio Control> (page 14) is changed to the value which was recalled.
- The source tone memory item of <Audio Control> (page 14) is changed to the value which was recalled by the selected source.

Audio Adjustments

Dual zone control

Connecting USB or iPod to the unit when the dual zone function is set to on, the front and rear channels are switched to the USB/iPod source.

1 Enter Dual zone control mode

Press the [ZZONE] button.

2 Switch Dual Zone ON/OFF

Turn the [VOL] knob.

To switch the dual zone function to ON, select "ZZONE: ON".

3 Select the channel to set the source

Press [∨] button, and then press [◀] or [▶] button.

Select the channel with [◀] or [▶] button.

4 Select the source

Turn the [VOL] knob.

5 Exit Dual zone control mode

Press the [ZZONE] button.



- Adjust the volume of Front channel by [VOL] knob.
- Adjust the volume of Rear channel by <Audio Control> (page 14).
- The Audio Controls have no effect on the rear source.
- When iPod or USB source is selected for the front channel, only the same selection is available for the rear channel. For example, when iPod is selected for the front channel, only iPod can be selected for the rear channel, and not the USB.
- When the dual zone function is set to ON, you can control the front channel by using the remote control KCA-RC107MR (optional accessory). You can also allow the rear channel to be controlled by remote control.

Other Functions

Backup memory delete

Initializes the settings of "MENU", etc.

1 Enter Menu mode

Press the [Q] button for at least 1 second.

"MENU" is displayed.

2 Select Backup memory delete item

Select the "Backup MEM DEL" display.

For how to select Menu items, refer to <Menu System> (page 8).

3 Enter Backup memory delete mode

Press the [ENTER] button for at least 1 second.

"Backup MEM DEL?" is displayed.

4 Delete the Backup memory

Turn the [VOL] knob to select "YES", and then press the [ENTER] button.

"Reboot" is displayed and the unit reboots.

Favorite Control

Favorite Preset Memory

Registering the operation procedure to select your favorite broadcast station or iPod Playlists/ Artists, etc.

1 Display a favorite item

Source	Setting Item
TUNER/SIRIUS	Preset Memory. Refer to <Preset tuning> (page 7).
iPod	List selection screen for Playlists/ Artists/ Albums, etc. Refer to <Music Search for iPod> (page 12).

"FAV" is displayed when the operation procedure can be registered.

iPod setting

The desired list in the first hierarchy can be registered.

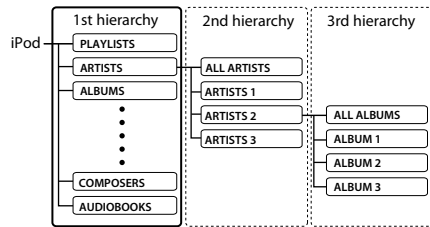

2 Enter Search mode (In SIRIUS source only)

Press the [Q] button.

"SEARCH/FAVORITE" is displayed.

3 Enter Favorite mode

Press the [Q] button.

Registered favorite items are displayed.

4 Select the number to put in the memory

Turn the [VOL] knob.

5 Put the Favorite Preset in the memory

Press the [ENTER] button for at least 1 second.

Canceling the Favorite mode

Press the [Q] button.



- Registering the operation procedure to an existing preset number overwrites the existing procedure.
- Register up to 6 Favorite Preset Memory settings. The memory cannot be erased by the Reset button.
- The <Audio control> (page 14) items can also be registered using the same steps.
- If the items in the second or lower hierarchy are changed, the list in iPod will be changed by adding or deleting songs after the FAVORITE registration. Due to this, the list registered in this unit will be different from the list in iPod. The FAVORITE registration should be performed again after editing the items in iPod.

Favorite Preset Recall

Retrieving an item registered to Favorite.

1 Enter Search mode (In iPod/USB/SIRIUS source only)

Press the [Q] button.

"SEARCH/FAVORITE" is displayed.

2 Enter Favorite mode

Press the [Q] button.

Registered favorite items are displayed.

3 Select the number to recall in the Favorite memory

Turn the [VOL] knob.

4 Recall the Favorite Preset

Press the [ENTER] button.

Canceling the Favorite mode

Press the [Q] button.



- When iPod is selected for the source, the list selection screen for Playlists/ Artists/ Albums, etc. is displayed. Songs will not be automatically played.
- When Dual zone control function is on, <Favorite Preset Recall> function can call only <Audio control>.

Favorite Preset Memory Delete

Deleting an item registered to Favorite.

1 Select Favorite delete item

Select the "Favorite Delete" display.

For how to select Menu items, refer to <Menu System> (page 8).

2 Enter Favorite delete mode

Press the [ENTER] button for at least 1 second.

Registered favorite items are displayed.

3 Select the number you want to delete

Turn the [VOL] knob.

Select "ALL" if you want to delete all.

4 Delete the selected Favorite Preset

Press the [ENTER] button.

"Delete?" is displayed.

5 Turn the [VOL] knob to select "YES"; and then press the [ENTER] button.

"Completed" is displayed.

Exit Favorite Preset Memory Delete mode.

Favorite Control

Favorite Name Setting

Giving a name to Preset Memory registered to Favorite.

1 Enter Search mode (In iPod/USB/SIRIUS source only)

Press the [Q] button.

"SEARCH/FAVORITE" is displayed.

2 Enter Favorite mode

Press the [Q] button.

Registered favorite items are displayed.

3 Select the number you want to Name set

Turn the [VOL] knob.

4 Enter Favorite name set mode

Press the [DISP] button for at least 1 second.

Select the "FAVORITE NAME SET" display.

5 Enter the name

Operation type	Operation
Move the cursor to the enter character position	Press the [<<] or [>>] button.
Select the character type*	Press the [ENTER] button.
Select the characters	Turn the [VOL] knob.

* Each time you press the [ENTER] button, the character type alternates between the types shown in the table below.

Character type	
	Alphabet upper case
	Alphabet lower case
	Numbers and symbols

6 Exit Favorite name set mode

Press the [DISP] button.

Canceling the Name set

Press the [Q] button.

Satellite Radio tuner control (Optional accessory)

Basic Operation

Selecting Satellite Radio source

Press the [TUN] button.

Select the "SIRIUS" display.



- You need to register to the service provider to receive the service by Satellite Radio. Consult the service provider if "CALL ... TO SUBSCRIBE" appears.
- The radio may take a little time to start receiving after you select the Satellite Radio source.
- If the signal reception fails, "Acquiring Signal"/ "No Signal" appears.

Switching Seek Mode

Select Seek Mode item

Select the "Seek Mode" display.

For how to select menu items, refer to <Menu System> (page 8).

Display	Operation
"Channel"	Normal manual seeking control.
"Preset"	Search in order of the channels in the Preset memory.

Select the channel

Press the [<<] or [>>] button.

Selecting the Preset Band

Press the [^] button.

Each time you press the button, the preset band alternates between the SR1, SR2, SR3 and SR4.

Channel Scan

Press the [^] button for at least 1 seconds.

Pressing this button for 2 seconds or longer allows you to check individual channel for 10 seconds each. Pressing this button again for 2 seconds or longer allows you to exit this mode.

Preset Memory

Press the desired [1] — [6] button for at least 2 seconds.

Preset Tuning

Press the desired [1] — [6] button.

Category and Channel Search

Selecting the channel and category you want to receive.

1 Enter Category and Channel Search mode

Press the [Q] button.

2 Select the Category

Turn the [VOL] knob to select Category, and then press the [ENTER] button.

3 Select the Channel

Turn the [VOL] knob to select Channel, and then press the [ENTER] button.

Cancelling Category and Channel Search mode

Press the [Q] button.



- You cannot Channel search until the category information is acquired.

Remote control (Optional accessory) setup

Remote control ID setup

When connecting the remote control KCA-RC107MR (Optional accessory) to this unit, you should register the ID for KCA-RC107MR.

1 Enter Remote control setup mode

Press the [ZZONE] button for at least 1 second.

2 Select the Remote control ID setup item

Turn the [VOL] knob to select "Remote ID Set", and then press the [ENTER] button.

Remote control ID list is displayed. "Yes" indicates that this ID is already registered. "No" indicates that this ID is available.

3 Enable Remote control ID registration

Press the [ENTER] button.

"Registering..." is displayed.

4 Register Remote control ID

For KCA-RC107MR, press the [ENTER], [SRC], or [DISP] button.

Button	Remote control ID
[ENTER]	ID1 is registered.
[SRC]	ID2 is registered.
[DISP]	ID3 is registered.

"ID# Setup Completed" is displayed.

5 End Remote control setup mode

Press the [ZZONE] button.

Canceling Remote control ID setup

Press the [ZZONE] button for at least 1 second.



- When removing KCA-RC107MR, delete the registered remote control ID, as described in <Remote control ID delete> (page 20).

Remote control ID delete

Delete the ID registered for the remote control KCA-RC107MR (optional accessory).

1 Enter Remote control setup mode

Press the [ZZONE] button for at least 1 second.

2 Select the Remote control ID delete item

Turn the [VOL] knob to select "Remote ID Delete", and then press the [ENTER] button.

List of the IDs registered for remote controls is displayed.

3 Select the remote control ID to be deleted

Turn the [VOL] knob.

4 Delete the Remote control ID

Press the [ENTER] button.

"Remote ID# Delete?" is displayed.

5 Turn the [VOL] knob to select "YES", and then press the [ENTER] button.

"ID# Delete Completed" is displayed.

6 End Remote control setup mode

Press the [ZZONE] button.

Canceling Remote control ID delete

Press the [ZZONE] button for at least 1 second.

Dual zone control setup

When the dual zone function is set to ON, select the channel, either front or rear, to be controlled by the remote control KCA-RC107MR (optional accessory).

1 Enter Remote control setup mode

Press the [ZZONE] button for at least 1 second.

2 Select the Dual zone control setup item

Turn the [VOL] knob to select "Remote Zone Select", and then press the [ENTER] button.

Current settings are displayed for the registered remote control IDs.

3 Select the target remote control ID

Press the [^] or [v] button.

4 Select the target channel

Press the [◀] or [▶] button.

Display	Controlled channel during dual zone mode
"Front"	Front channel is controlled.
"Rear"	Rear channel is controlled.

5 End Remote control setup mode

Press the [ZZONE] button.

Appendix

About Audio file

• Playable Audio file

AAC-LC (.m4a), MP3 (.mp3), WMA (.wma), WAV (.wav)

• Playable USB device

USB mass storage class

• Playable USB device file system

FAT16, FAT32

Although the audio files are complied with the standards listed above, the play maybe impossible depending on the types or conditions of media or device.

• Playable order of the Audio file

In the example of folder/file tree shown below, the files are played in the order from ① to ⑩.

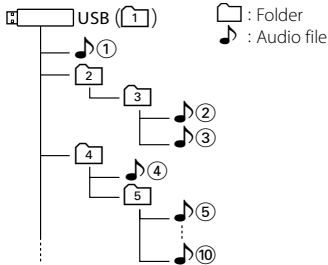

An online manual about audio files is put on the site, www.kenwood.com/audiofile/. On this online manual, detailed information and notes which are not written in this manual are provided. Make sure to read through the online manual as well.



- In this manual, the word "USB device" is used for flash memories and digital audio players which have USB terminals.

iPod/iPhone that can be connected to this unit

Made for

- iPod nano (1st generation) • iPod nano (2nd generation)
- iPod nano (3rd generation) • iPod nano (4th generation)
- iPod with video • iPod classic
- iPod touch (1st generation) • iPod touch (2nd generation)

Works with

- iPhone
- iPhone 3G



- Update iPod/iPhone software to the latest version.



- If you start playback after connecting the iPod, the music that has been played by the iPod is played

first.

In this case, "RESUMING" is displayed without displaying a folder name, etc. Changing the browse item will display a correct title, etc.

- You cannot operate iPod if "KENWOOD" or "✓" displayed on iPod.

About USB device

- When the USB device is connected to this unit, it can be charged up provided that this unit is powered.
- You cannot connect a USB device via a USB hub.
- Take backups of the audio files used with this unit. The files can be erased depending on the operating conditions of the USB device. We shall have no compensation for any damage or loss of stored data.
- No USB device comes with this unit. You need to purchase a commercially available USB device.

About Satellite Radio tuner (Optional)

This unit supports Satellite Radio tuners which are released by SIRIUS.

Refer to the instruction manual of Satellite radio tuner.

About KENWOOD "Music Editor" of PC application

- "Music Editor" is recorded in the CD-ROM attached to this unit.
- Refer to the user's manual recorded in the installation CD-ROM and Help of "Music Editor" for the operation method of "Music Editor".
- The unit can play USB device created by "Music Editor".
- Information about "Music Editor" upgrade is put on the site, www.kenwood.com/cs/ce/.

Appendix

Menu Glossary

- **AMP**

Selecting "OFF" turns off the built-in amplifier. Turning off the built-in amplifier improves the quality of the sound from Preout.

- **ILM Dimmer**

Reduces the key illumination brightness. Auto: Dims the illumination in conjunction with the Light switch of the vehicle.

Manual: Dims the illumination constantly. OFF: Does not dim the illumination.

- **DISP Dimmer**

Reduces the display illumination brightness. Auto: Dims the illumination in conjunction with the Light switch of the vehicle.

Manual: Dims the illumination constantly. OFF: Does not dim the illumination.

- **DISP N/P**

Switches the panel display between positive or negative. In addition, you can reverse it in conjunction with the interior light.

POS11 : Displays the text in the positive.

POS12 : When the interior light is off, the text is displayed in the positive; when the interior light is on, the text is displayed in the negative.

NEGA1 : Displays the text in the negative.

NEGA2 : When the interior light is off, the text is displayed in the negative; when the interior light is on, the text is displayed in the positive.

- **Seek Mode**

Select a tuning mode of the radio.

Tuning mode	Display	Operation
Auto seek	"Auto1"	Automatic search for a station.
Preset station seek	"Auto2"	Search in order of the stations in the Preset memory.
Manual	"Manual"	Normal manual tuning control.

- **Supreme**

Technology to extrapolate and supplement with proprietary algorithm, the high-frequency range that is cut off when encoding at low bit rate (less than 128Kbps, Sampling frequency is 44.1kHz). Supplementing is optimized by compression format (AAC, MP3 or WMA) and processed according to bit rate.

The effect is negligible with music that is encoded at high bit rate, variable bit rate or has minimal high frequency range.

▲CAUTION

Use of controls or adjustments or performance of procedures other than those specified herein may result in hazardous radiation exposure. In compliance with Federal Regulations, following are reproductions of labels on, or inside the product relating to laser product safety.

Kenwood Corporation
2967-3, ISHIKAWA-MACHI,
HACHIOJI-SHI
TOKYO, JAPAN

KENWOOD CORP. CERTIFIES THIS EQUIPMENT
CONFORMS TO DHHS REGULATIONS NO.21 CFR
1040. 10, CHAPTER 1, SUBCHAPTER J.

Location : Bottom Panel

FCC WARNING

This equipment may generate or use radio frequency energy. Changes or modifications to this equipment may cause harmful interference unless the modifications are expressly approved in the instruction manual. The user could lose the authority to operate this equipment if an unauthorized change or modification is made.





FCC NOTE

This equipment has been tested and found to comply with the limits for a Class B digital device, pursuant to Part 15 of the FCC Rules. These limits are designed to provide reasonable protection against harmful interference in a residential installation. This equipment may cause harmful interference to radio communications, if it is not installed and used in accordance with the instructions. However, there is no guarantee that interference will not occur in a particular installation. If this equipment does cause harmful interference to radio or television reception, which can be determined by turning the equipment off and on, the user is encouraged to try to correct the interference by one or more of the following measures:

- Reorient or relocate the receiving antenna.
- Increase the separation between the equipment and receiver.
- Connect the equipment into an outlet on a circuit different from that to which the receiver is connected.
- Consult the dealer or an experienced radio/TV technician for help.

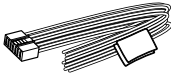
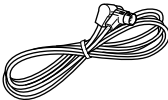
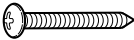
Accessories/ Installation Procedure

Accessories

①	1
②	1
③	7
④	2
⑤	1
⑥	1

Installation Procedure

1. To prevent a short circuit, remove the key from the ignition and disconnect the ⊖ battery.
2. Make the proper input and output wire connections for each unit.
3. Connect the speaker wires of the wiring harness.
4. Connect the wiring harness wires in the following order: ground, battery, ignition.
5. Connect the wiring harness connector to the unit.
6. Install the unit in your vessel.
7. Reconnect the ⊖ battery.
8. Press the reset button.

▲WARNING

If you connect the ignition wire (red) and the battery wire (yellow) to the negative ground point, you may cause a short circuit, that in turn may start a fire. Always connect those wires to the power source running through the fuse box.



- Mounting and wiring this product requires skills and experience. For safety's sake, leave the mounting and wiring work to professionals.
- Make sure to ground the unit to a negative 12V DC power supply.
- Do not install the unit in a spot exposed to direct sunlight or excessive heat or humidity.
- Do not use your own screws. Use only the screws provided. If you use the wrong screws, you could damage the unit.
- If the power is not turned ON ("Protect" is displayed), the speaker wire may have a short-circuit or touched the chassis of the vehicle and the protection function may have been activated. Therefore, the speaker wire should be checked.
- If your vessel ignition does not have an ACC position, connect the speaker wire to a power source that can be turned on and off with the key or other control switch. If the receiver is left on for an extended period of time the battery may die.
- If the fuse blows, first make sure the wires aren't touching to cause a short circuit, then replace the old fuse with one with the same rating.
- Insulate unconnected wires with vinyl tape or other similar material. To prevent a short circuit, do not remove the caps on the ends of the unconnected wires or the terminals.
- Connect the speaker wires correctly to the terminals to which they correspond. The unit may be damaged or fail to work if you share the ⊖ wires or ground them to any metal part in the vessel.
- When only two speakers are being connected to the system, connect the connectors either to both the front output terminals or to both the rear output terminals (do not mix front and rear). For example, if you connect the ⊕ connector of the left speaker to a front output terminal, do not connect the ⊖ connector to a rear output terminal.
- After installing the unit, check to make sure that electrical equipment such as the signal lamps and gauges operate normally.
- Mount the unit so that the mounting angle is 30° or less.

Connecting Wires to Terminals

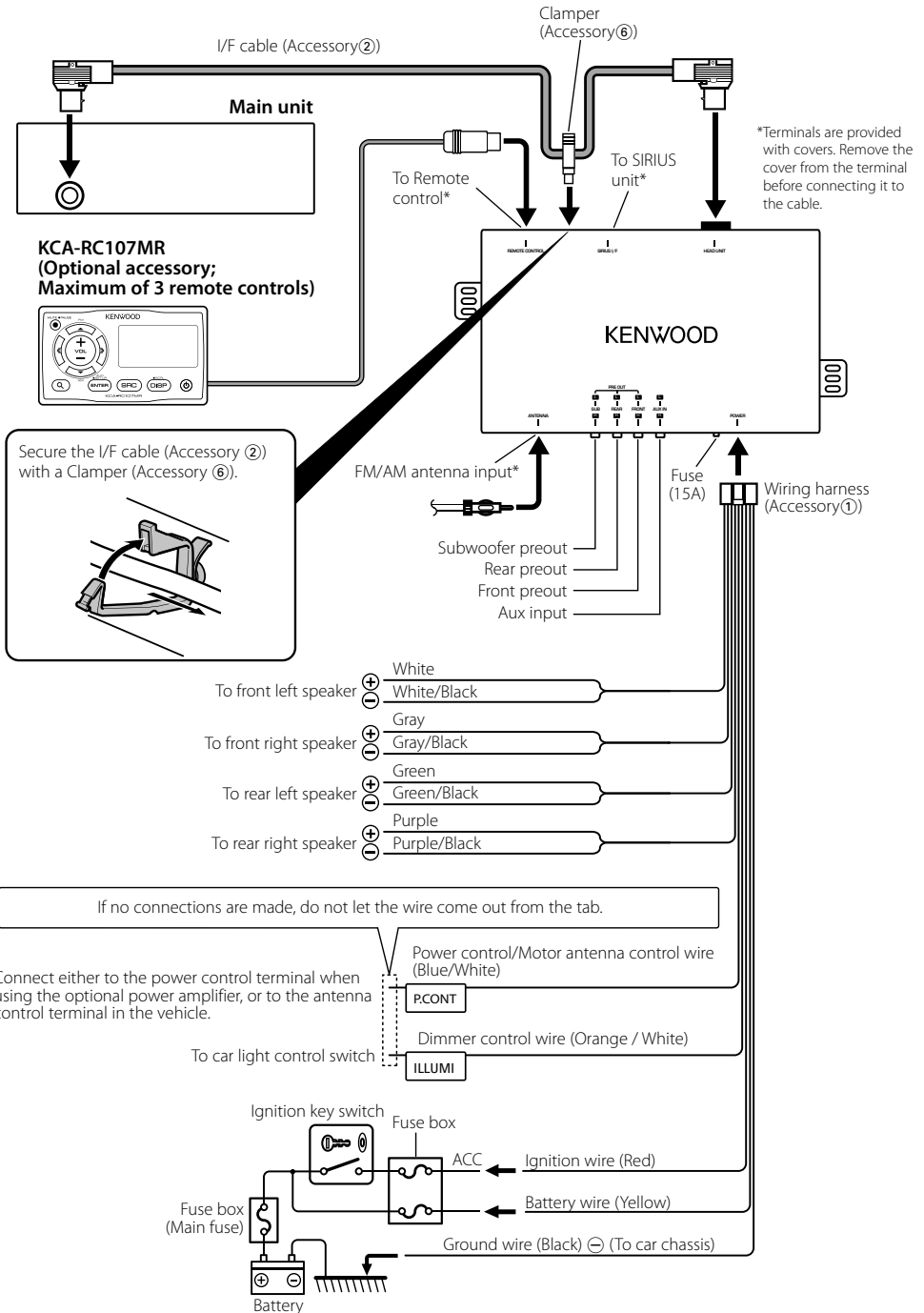

Installation

Main unit Installation

- 1 Attach the template (accessory ⑤) at the installation position.
- 2 Tap holes (main unit mounting hole x 1, screw holes x 7) on the mounting surface based on the template (accessory ⑤).

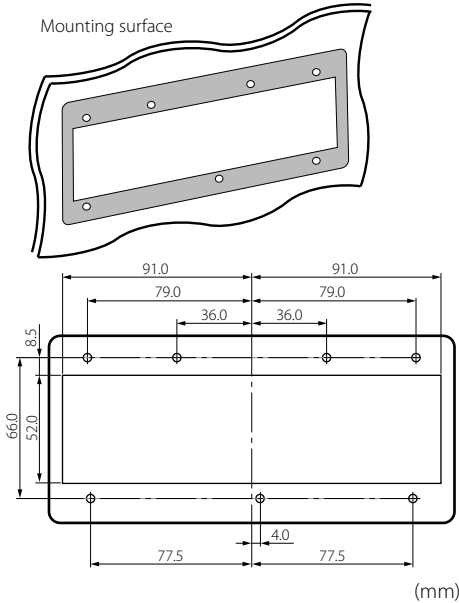

- Decide the size of screw holes according to the mounting surface material.

- 3 Remove the template (accessory ⑤).
- 4 Install the main unit.

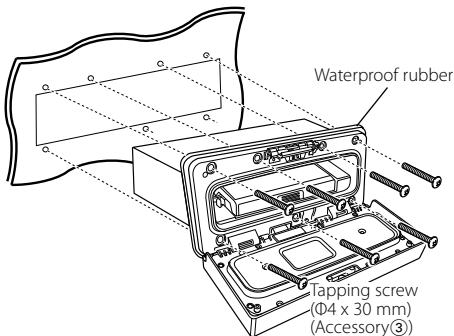

- Install the main unit together with the waterproof rubber. Waterproof feature is only provided with the waterproof rubber attached.

Hideaway unit Installation

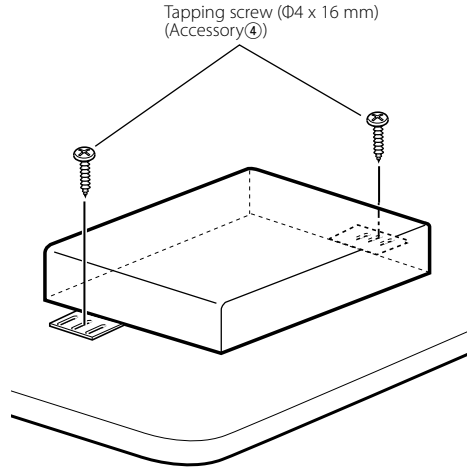



- Install the hideaway unit in a place free from water exposure.
- Before installation, check that no fuel tank, pipe, nor wire exists at backside of the mounting surface, to prevent screws from penetrating into such component.

Troubleshooting Guide

Some functions of this unit may be disabled by some settings made on this unit.

- !** • **Cannot set up the subwoofer.**
 - **Cannot set up the low pass filter.**
 - **No output from the subwoofer.**
 - ▶ • <Subwoofer output> of <Basic Operation> (page 6) is not set to On.
-

- !** • **Cannot set up the subwoofer.**
 - **Cannot set up the High Pass Filter.**
 - **Cannot set up the Fader.**
 - **No Audio control effect on AUX.**
 - **Cannot set up the subwoofer position of Manual position setting.**
 - ▶ • <Subwoofer output> of <Basic Operation> (page 6) is not set to On.
 - The Dual zone function is enabled.  <Basic Operation> (page 6)
-

- !** • **Cannot set up the subwoofer phase.**
 - ▶ The Low Pass Filter is set to Through.  <Audio Setup> (page 14)
-

- !** • **Cannot select the output destination of the subsource in the Dual zone.**
 - **Cannot adjust the volume of the rear speakers.**
 - ▶ The Dual zone function is disabled.  <Basic Operation> (page 6)
-

What might seem to be a malfunction in your unit may just be the result of slight misoperation or miswiring. Before calling service, first check the following table for possible problems.

General

? The Touch Sensor Tone does not sound.

- ✓ The preout jack is being used.
 -  The Touch Sensor Tone cannot be output from the preout jack.
-

Tuner source

? Radio reception is poor.

- ✓ The car antenna is not extended.
 -  Pull the antenna out all the way.
-

Audio file source

? The sound skips when an Audio file is being played.

- ✓ The recording condition is bad.
 -  Record the media again or use another media.
-

The messages shown below display your systems condition.

Protect (Blink):

The speaker wire has a short-circuit or touches the chassis of the vehicle, and then the protection function is activated.

- Wire or insulate the speaker cable properly and press the reset button. If the "Protect" code does not disappear, consult your nearest service center.

No Device:

The USB device is selected as a source although no USB device is connected.

- Change the source to any source other than USB. Connect an USB device, and change the source to USB again.

N/A Device:

- An unsupported USB device is connected.
- Connection to the iPod has failed.
- Check that the connected iPod is an iPod that is supported. See <About Audio file> (page 21) for information on supported iPods.

No Music Data/No Music:

- The connected USB device contains no playable audio file.
- Media was played that does not have data recorded that the unit can play.

USB Error:

Some trouble may have occurred to the connected USB device.

- Remove the USB device, then cycle the power switch to ON. If the same display is repeated, use another USB device.

REMO ERROR:

Some trouble may have occurred to the connected Remoto control.

- Remove the Remoto control and then reconnect it.

USB REMOVE (Blink):

The Remove mode has been selected for the USB device. You can remove the USB device safely.

iPod REMOVE (Blink):

The Remove mode has been selected for the iPod. You can remove the iPod safely.

FAV : No Memory:

The procedure is not registered to Favorite Preset Memory

NO ACCESS:

The procedure preset with Favorite Control cannot be available. The preset content may not be recalled depending on the selected source or mode.

Specifications

FM tuner section

Frequency range
: 87.9 MHz – 107.9 MHz
Usable sensitivity (S/N = 30dB)
: 9.3dBf (0.8 μ V/75 Ω)
Quieting Sensitivity (S/N = 50dB)
: 15.2dBf (1.6 μ V/75 Ω)
Frequency response (\pm 3 dB)
: 30 Hz – 15 kHz
Signal to Noise ratio (MONO)
: 70 dB
Selectivity (\pm 400 kHz)
: \geq 80 dB
Stereo separation (1 kHz)
: 40 dB

AM tuner section

Frequency range (10 kHz space)
: 530 kHz – 1700 kHz
Usable sensitivity (S/N = 20dB)
: 28 dB μ (25 μ V)

USB Interface

USB Standard
: USB1.1/ 2.0 (Full speed)
Maximum Supply current
: 500 mA
D/A Converter
: 24 Bit
Frequency response (\pm 1 dB)
: 10 Hz – 20 kHz
Total harmonic distortion (1 kHz)
: 0.010 %
Signal to Noise ratio (1 kHz)
: 105 dB
Dynamic range
: 93 dB
File System
: FAT16/ 32
MP3 decode
: Compliant with MPEG-1/2 Audio Layer-3
WMA decode
: Compliant with Windows Media Audio
AAC decode
: AAC-LC “.m4a” files
WAV signal
: Linear-PCM

Audio section

Maximum output power
: 50 W x 4
Full Bandwidth Power (at less than 1% THD)
: 22 W x 4
Speaker Impedance
: 4 – 8 Ω
Tone action
Bass : 100 Hz \pm 8 dB
Middle : 1 kHz \pm 8 dB
Treble : 10 kHz \pm 8 dB
Preout level / Load (USB)
: 4000 mV/10 k Ω
Preout impedance
: \leq 600 Ω

Auxiliary input

Frequency response (\pm 1 dB)
: 20 Hz – 20 kHz
Input Maximum Voltage
: 1200 mV
Input Impedance
: 10 k Ω

General

Operating voltage (11 – 16V allowable)
: 14.4 V
Maximum Current consumption
: 15 A
Installation Size (W x H x D)
Main unit: 180 x 50 x 138 mm
7-1/16 x 1-15/16 x 5-7/16 inch
Dimensions (W x H x D)
Main unit: 197 x 90 x 188 mm
7-3/4 x 3-9/16 x 7-3/8 inch
Hideaway unit: 243 x 52 x 169 mm
9-9/16 x 2-1/16 x 6-5/8 inch
Weight
Main unit: 2.25 lbs (1.02 kg)
Hideaway unit: 2.14 lbs (0.97 kg)

Specifications subject to change without notice.



This symbol mark indicates that Kenwood manufactured this product so as to decrease harmful influence on the environment.

Free Manuals Download Website

<http://myh66.com>

<http://usermanuals.us>

<http://www.somanuals.com>

<http://www.4manuals.cc>

<http://www.manual-lib.com>

<http://www.404manual.com>

<http://www.luxmanual.com>

<http://aubethermostatmanual.com>

Golf course search by state

<http://golfingnear.com>

Email search by domain

<http://emailbydomain.com>

Auto manuals search

<http://auto.somanuals.com>

TV manuals search

<http://tv.somanuals.com>