

EQplus AUDIO PROCESSOR



OPERATING MANUAL

EQplus AUDIO PROCESSOR

OPERATING MANUAL

September 2004



**Julius D. Jones
19 Vanessa Lane
Staatsburg, N.Y. (12580)
(845) 889-4253**

E-mail: Julius@W2IHY.COM

Home Page: [http:// www.w2ihy.com](http://www.w2ihy.com)

© 2004 W2IHY, ALL RIGHTS RESERVED

TABLE OF CONTENTS

Introduction	4
Front Panel Controls	5 - 9
Rear Panel Controls	10 - 11
Schematic (Front Panel)	12 - 13
Schematic (Rear Panel)	14
Rear Panel Controls	15
Getting Started Tutorial	16-19
Internal Wiring	20
Audio Out Cable wiring	21 - 24

INTRODUCTION

EQplus

AUDIO PROCESSOR

The EQplus is the next generation of audio processing equipment from W2IHY Technologies. The EQplus was designed to be directly attached to the world famous W2IHY 8 Band EQ. The EQplus provides features such as Audio Compression, Downward Expansion, Effects and connectivity to 3 radios. All these features, and more, were designed in a way that makes the EQplus easy to use. Extensive testing was done by amateurs on many different radios on AM, FM and SSB so that the product would be ready for you to use problem free. Buying the EQplus gives you the availability to Amateur Service unrivaled in the hobby. We feel so confident that you will be delighted with the EQplus that we offer a 30 day money back, no questions asked guarantee. The EQplus represents the new reference point for easy to use amateur radio audio equipment.

If I did not think you would be delighted with The EQplus I would have not put my call sign on it. Thanks for your purchase and we appreciate your business.

Julius D, Jones (W2IHY)

FRONT PANEL CONTROLS

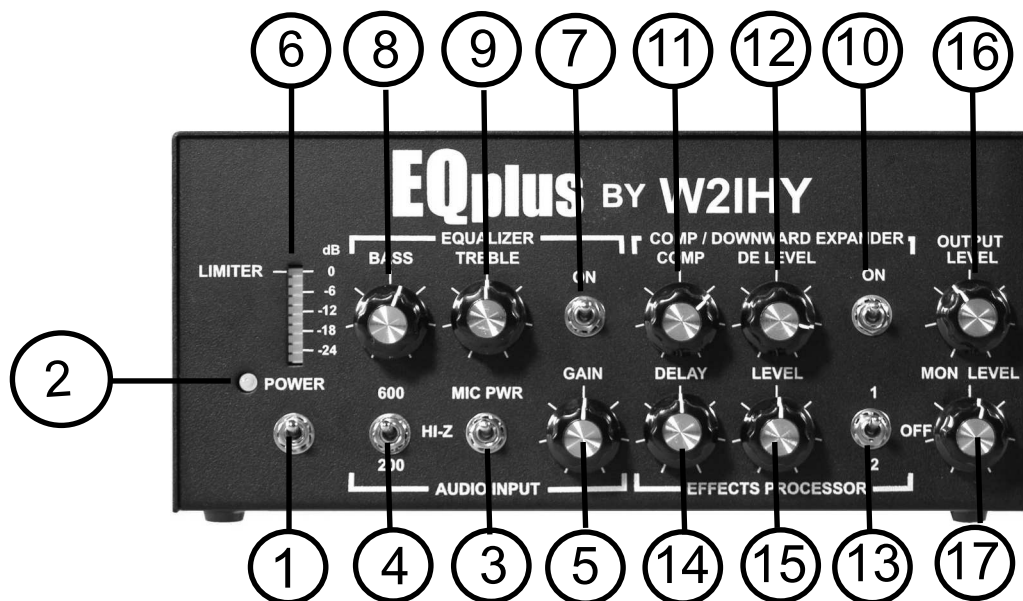

This section describes each of the controls on the front panel. You should read through this section now. Some of the descriptions will be more meaningful after you first work through the Getting Started Tutorial.

(1) Power On/Off Switch (S1)

This switch turns the unit's power on and off.

(2) Power on LED (LED1)

This LED goes on when power is on in the unit.

(3) Audio Input Mic PWR (Power) Switch (S6)

Turning this switch on puts +5V onto what is plugged into the Mic In and Aux Input connectors. The Mic power switch must be on if you have any of the following microphones connected directly into the EQplus:

- ICOM HM12, HM36, SM6 etc..
- Heil microphones made specifically for ICOM radio's such as the HMI and ICM
- Elecraft MH2 (made for the Elecraft radio by Heil Sound)

FRONT PANEL CONTROLS

(4) Audio Input Impedance Switch (S5)

This 3 position toggle switch is used to change the input impedance of the Mic and Aux Inputs (19,20 & 21). Input Impedances of 200 ohms, 600 ohms and 50K ohms (HI-Z) may be selected.

(5) Mic In Gain (R12)

This potentiometer, when turned clockwise, can increase the Audio Input signal levels up to about +40dBv. The mic gain should be changed **while speaking into the microphone**, until 3 or 4 green Bar Graph (7) LED's are illuminated. Audio levels should be maintained in the green and yellow ranges of the LED Bar Graph(6) .

(6) LED Bar Graph

The 10 segment LED Bar Graph indicates peak to peak EQplus internal audio levels. The position of the Equalizer (7) and Compressor / Downward Expander (10) switches control what internal function is being indicated. The tables below defines what the LED Bar Graph is indicating.

EQplus BAR GRAPH MONITORING

Compressor	Equalizer	Bar graph monitoring
off	off	Output of Audio Amp
off	on	Output of Equalizer
on	off	Output of Compressor
on	on	Output of Compressor

The pictorial below shows the EQplus Audio Chain

EQplus AUDIO CHAIN

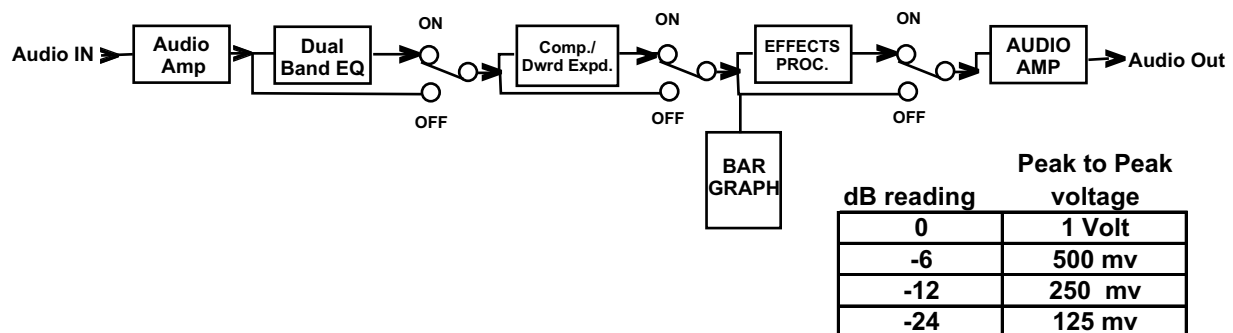

FRONT PANEL CONTROLS

(7) Equalizer On/Off Switch (S3)

This switch turns the Equalizer on and off. When the equalizer is off, adjusting the bass and treble controls have no effect on the output audio.

(8) Equalizer Bass (R37)

This rotary potentiometer works only when the Equalizer Switch (7) is on. Turning this control clockwise increases the amount of bass boost. Turning this control counterclockwise decreases the amount of bass boost. The detent at the half way point of rotation represents 0 dB of boost. Each case marking represents 4dB.

(9) Equalizer Treble (R38)

This rotary potentiometer works only when the Equalizer Switch (7) is on. Turning the control clockwise increases the amount of treble boost. Turning this control counterclockwise decreases the amount of treble boost. The detent at the half way point of rotation represents 0 dB of boost. Each case marking represents 4dB.

(10) Compressor / Downward Expander On/Off Switch (S2)

When the switch is in the off position the compressor and downward expander have no effect on the EQplus's audio.

(11) Compressor / Downward Expander COMPRESSOR (COMP) POTENTIOMETER (R22)

This potentiometer works only if the Compressor / Downward Expander switch (10) is on. The COMP potentiometer controls the amount of compression that will be done by the unit. If the COMP potentiometer is turned fully counterclockwise then there will be no compression introduced (0 dB) to incoming signals. If the COMP potentiometer is rotated fully clockwise then

FRONT PANEL CONTROLS

Incoming signals will have up to 20dB of compression introduced. The EQplus compressor circuitry contains a limiter that is preset at the factory. The limiter is set to limit the processed signals to 375 millivolts (-9 dB). When this level is reached the 1-st yellow LED on the bar graph will be on and the top Red (Limiting) LED will turn on. Additional increases in audio level, using either the Audio Input Gain Potentiometer or the Equalizer Potentiometers, will result in a small increase in output from the compressor's circuitry. The good news is that the EQplus can produce high levels of compression while maintaining fidelity and very low distortion levels. The RF compressors in many radio's have difficulty attaining high levels of compression with low levels of distortions. RF compressors roll off the low end audio response of the signals they process. The net result of the EQplus compressor is up to 20dB of signal compression with very low distortion and little to no change in overall audio bandwidth. .

(12) Compressor / Downward Expander Downward Expander Level (DE LEVEL) POTENTIOMETER (R47)

This potentiometer works only if the Compressor / Downward Expander switch (10) is on. The Downward Expander removes unwanted audible sounds such as fan noise. The Downward Expander is operated by turning the DE LEVEL Control clockwise just to the point where unwanted sounds are removed.

(13) EFFECTS PROCESSOR PROGRAM SELECT / OFF SWITCH (S4)

This 3 position toggle switch is used to select one of two effects or to turn the Effects Processor off. When the Effects Processor is off the Effects Processor Delay and Level controls will not modify internal EQplus audio. The toggle switch in position 1 selects Effect 1. Effect 1 emulates dampening sound reflecting multiple times from a surface. The toggle switch in the position 2 selects Effect 2. Effect 2 emulates sound reflecting once from a surface.

FRONT PANEL CONTROLS

(14) EFFECTS PROCESSOR DELAY Potentiometer (R42)

This potentiometer works only if the Effects Processor 3 position toggle switch is selecting either effect 1 or effect 2. The Delay control, when rotated clockwise increases, by up to about 80 milliseconds, the time that audio waveform is delayed. The delayed waveform is then mixed with the original non delayed waveform. The mixed waveform is next sent to the output of the EQplus.

When the pot is turned clockwise, at the halfway point, there is a detent. This represents a starting point for adjusting the Effects Processor Delay..

(15) EFFECTS PROCESSOR LEVEL Potentiometer (R47)

This potentiometer works only if the Effects Processor 3 position toggle switch is selecting either effect 1 or effect 2. The Level control, when rotated clockwise, increases the amplitude that the delayed audio waveform is combined with the original non delayed waveform.

When the pot is turned clockwise, at the halfway point, there is a detent. This represents a starting point for adjusting the Effects Processor Level.

(16) OUTPUT LEVEL Potentiometer (R44)

This potentiometer varies the output level from about 10 millivolts to about 1 volt peak to peak.

(17) Monitor (Mon) LEVEL Potentiometer (R39)

This potentiometer adjusts the audio level into the Phones Connector (24).

REAR PANEL CONTROLS

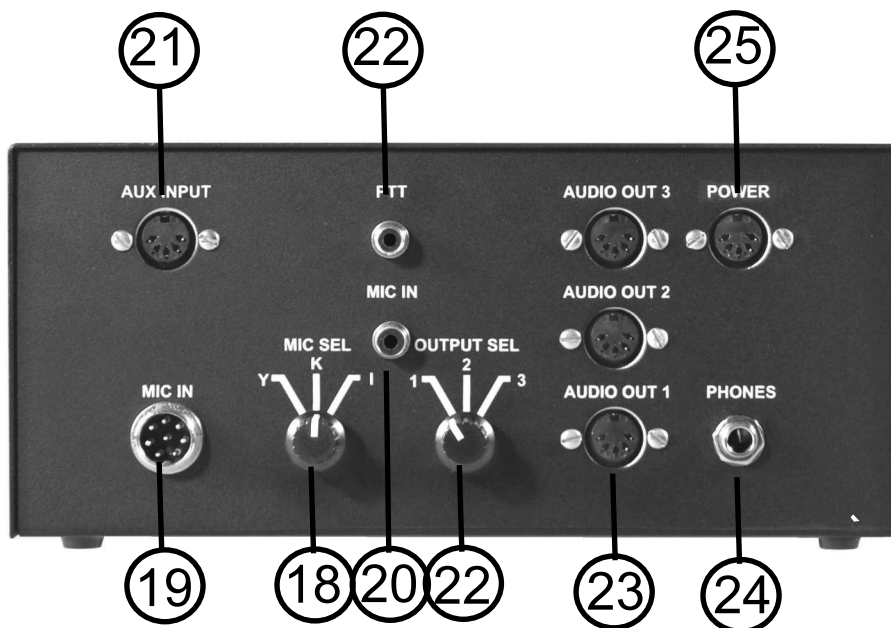

(18) MIC SELECT

This three position switch selects the YAESU, KENWOOD or ICOM microphone plugged into the 8 pin Mic Input (19). (Other microphones supported with mic adapters)

(19) MIC INPUT

This Input uses an 8 Pin microphone male connector. The impedance of this input is set by the Audio Input 3 position toggle switch (4). Do not use this connector when RCA Mic In (20) or the Aux Input (21) is being used.

J8 Pin	Icom	Ken	Yaesu
1	+Mic	+Mic	
2	+5V	PTT	+5V
5	PTT	+5V	PTT Gnd
6	PTT Gnd		PTT
7	Gnd	- Mic	Gnd
8		Gnd	+Mic

REAR PANEL CONTROLS

(20) MIC INPUT

This RCA female connector is used as a microphone input. This connector works independent of the Mic Select switch (18) and may be used for another audio input source such as a microphone. The impedance of this input is set by the Audio Input 3 position toggle switch (4).

(21) AUX INPUT

This 5 Pin Din connector allows audio to be brought into the EQplus from an external device..This connector works independent of the Mic Select switch (18) and may be used for another audio input source such as a W2IHY 8 Band EQ. The impedance of this input is set by the Audio Input 3 position toggle switch (4).

AUX INPUT 5 Pin Male DIN

Din connectors shown
on side to be soldered

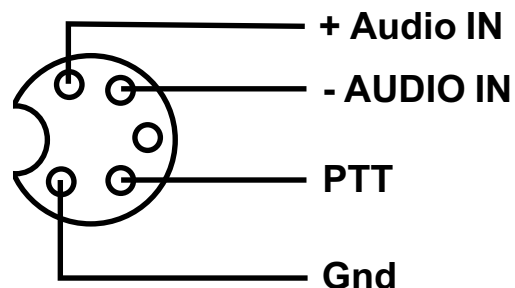

(22) PTT INPUT

This female RCA connector is for push to talk control. A foot switch or other device may be connected. Grounding the center of the connector grounds the push to talk line on the selected Audio Output.

(22) OUTPUT SELECT

This three position rotary switch directs audio to one of 3 5 Pin DIN connectors (Output1, Output 2 or Output 3.)

REAR PANEL CONTROLS

(23) AUDIO OUTPUTS 1,2 and 3

The audio output and PTT outputs of the EQplus uses these 5 pin DIN's. When the Audio Output Rotary switch (22) is in the "1" position, audio is active at Audio Output 1. When the Audio Output Rotary switch (22) is in the "2" position, audio is active at Audio Output 2. When the Audio Output Rotary Switch (22) is in the "3" position, audio is active at Audio Output 3. The diagram below shows the configuration of each of the 3 outputs.

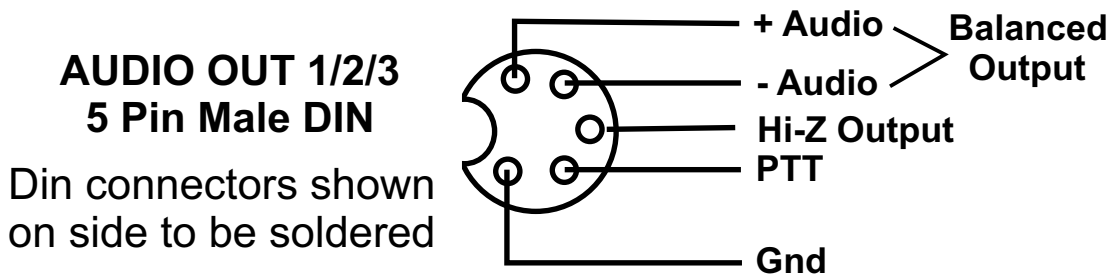

(24) PHONES

This 1/4" Stereo headphone connector can be used to monitor audio from the EQplus. The output level of this connector is controlled by the Monitor Level control(1). **Important: Unless headphones using 1/4" stereo connectors are used, the EQplus monitor will not operate properly.**

(An inline adapter should be used with headsets that do not use 1/4" stereo connectors. Stores like Radio Shack have such adapters available.)

(25) Power

5 Pin Din connector. 7 - 14 VDC input at 100 ma

**Power
5 Pin Male DIN**

Din connectors shown
on side to be soldered

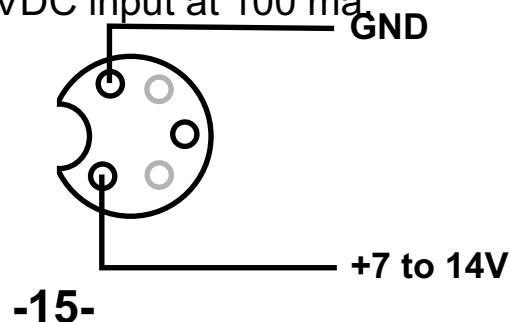

GETTING STARTED TUTORIAL

Before plugging the power transformer into the wall, preset the EQplus controls as indicated:

Power , Equalizer, Compressor/ Downward and Effects Processor all off. Connect your microphone into the **Mic In** rear connector. Turn the **Mic Select** to select the microphone you will be using. If you are not using a mic but an external audio source like a W2IHY EQ, connect your audio source into the Aux Input. (If you are using a W2IHY EQ, then connect a cable between the Mic Out of the EQ and the Aux Input of the EQplus.)

Plug the power transformer (power cube) into the wall and into the Power connector of the EQplus. Attach the audio cable between your transceiver/transmitter and the **Audio Out** of the EQplus.

If you are using a mic into the EQ plus and you are using an electret mic such as an ICOM Hm12, Hm36, Sm6,... or a Heil Mic made for ICOM radios, then turn the front panel Audio Input Mic Pwr switch on. Set the Audio Input impedance (4) for the impedance of the mic that is connected into the MIC IN. Most amateur radio mics are 600 ohms.

If you are using a W2IHY 8 Band EQ or other audio device into the EQ plus make, sure the front panel Audio Input Mic PWR Switch (3) is off. Set the Audio Input impedance (4) to 600 ohms.

Adjusting the Audio Input Level using a Mic into the EQplus

Turn on the power on the 8 band EQ and the EQ plus. Connect a mic into the EQplus 8 pin **MIC IN Connector (19)**. Turn the rear mounted **Mic Select switch (18)** to the correct manufacturer the mic is wired for (Yaesu/Kenwood/ICOM). While talking into your mic, adjust the **Audio Input Gain (5)** so that 2 or 3 Green LED's on the bar graph light up.

Adjusting the Audio Input Level using a W2IHY 8 Band EQ into the EQplus

Turn on the power on the 8 band EQ and the EQ plus. Connect a mic into the 8 Band EQ. While talking into your mic, adjust the

GETTING STARTED TUTORIAL

Audio Input Gain (5) so that 2 or 3 Green Bar Graph LED's light up. This may require adjusting both the Mic Gain control on the 8 Band EQ and the Audio Gain control on the EQplus.

Using The EQplus headphone (PHONES) Monitor

Connect a set of stereo headsets into the 1/4 inch "**Phones**" Connector located in the back of the EQplus. Talk into the mic to hear audio coming from the EQplus. Adjust the headset volume by turning the front panel **Monitor Level** control (17)

Adjusting an External Equalizer connected to the EQplus

If you are using an external audio device, such as a W2IHY 8 Band EQ, use the same equalizer settings you were using prior to using the EQplus.

Adjusting the EQPlus Dual Band EQ

Turn the **Equalizer Switch** (7) on. Turning the **Treble** potentiometer (9) clockwise up will increase the amount of high frequencies present in the **Audio Out** (23) The detent midway through the rotation is 0dB gain point. Turning the **Bass** potentiometer (8) clockwise will increase the amount of low frequencies present in the **Audio Out** (23) The detent midway through the rotation is the 0dB gain point. Experimentation will be required to determine the optimal settings for the Equalizer.

USING THE COMPRESSOR/ DOWNWARD EXPANDER

- With the Compressor/ Downward Expander off, the audio level, as seen on the LED Bar Graph, should be adjusted so that 2 or 3 green LED's are on. This level may be adjusted using the **Audio Input Gain** control (5).
- Turn the **Compressor / Downward Expander on** (10). Turn the **DE (Downward Expander)** control (12) fully counter clockwise. This will effectively turn the Downward Expander off.

GETTING STARTED TUTORIAL

- Turn the **Compressor** control (11) fully counter clockwise. This setting passes uncompressed audio thru the compressor. Turning the compressor control clockwise increase the amount of compression. Set the compression to the desired level. You can turn the compression levels up to a point where talking into the mic causes the RED Limiting LED to come on . The Red LED coming on indicates that additional increases in audio signal levels, into the compressor, will result in minimal signal level increase at the output of the compressor. Limiting of audio signal levels occur when the Compressor is on and the internal audio signals exceed -9db (first yellow LED on). The EQplus creates no perceptible distortion to audio that is heavily compressed.
- The **Downward Expander** (12) can be used to reduce background noise. The EQplus monitor may be used to assist in adjustment of the Downward Expander. Connect your stereo headsets into the rear panel 1/4" stereo **Phones** connector (24). Listen to audio from the EQplus while talking into the mic. Adjust the front panel **Monitor Level** control (1) to a comfortable listening level. When you are not talking, listen in the headsets for background noise. Turn the **DE LEVEL** (Downward Expansion) control (12) clockwise. You should hear the background noise level reduce as you turn this control clockwise. As you continue to turn the control knob clockwise there will be a point where the background noise will disappear. At the point where the background noise disappears talk into your mic to make sure you have not turned the Downward Expander control too far. Turning the control too far will result in choppy and or distorted audio. If the monitored audio is choppy or distorted then turn the **Downward Expander** knob counterclockwise until the audio heard is clear.

ADJUSTING THE EFFECTS

The EFFECTS PROCESSOR adjusts audio to add resonance and ambiance. The **Delay** control (14) sets the time that audio is delayed before it is mixed back into the non delayed audio.

GETTING STARTED TUTORIAL

The Level control (15) sets the amplitude that the audio delayed by the Effects Processor combines with the non delayed audio. Through experimentation, the user can find what Effects Processor Delay and Level settings are best for their voice characteristics. Both the Delay and Level controls have detents half way through the rotation of the control. The detents may be used as a starting point for adjusting the Effects Processor Controls. The Effects Processor creates 2 different effects. Program 1 (**Effects Processor toggle switch** (13) up towards 1) simulates audio reflecting from a surface multiple times. Program 2 (**Effects Processor toggle switch** (13) selecting 2) simulates audio reflecting from a surface once.

With your radio connected to the EQplus, adjust the **Output Level** control (16) to a level that properly drives your radio. Turning the Output Level control clockwise increases the output of the EQplus. Turning the Output Level counterclockwise decreases the output of the EQplus.

INTERNAL WIRING

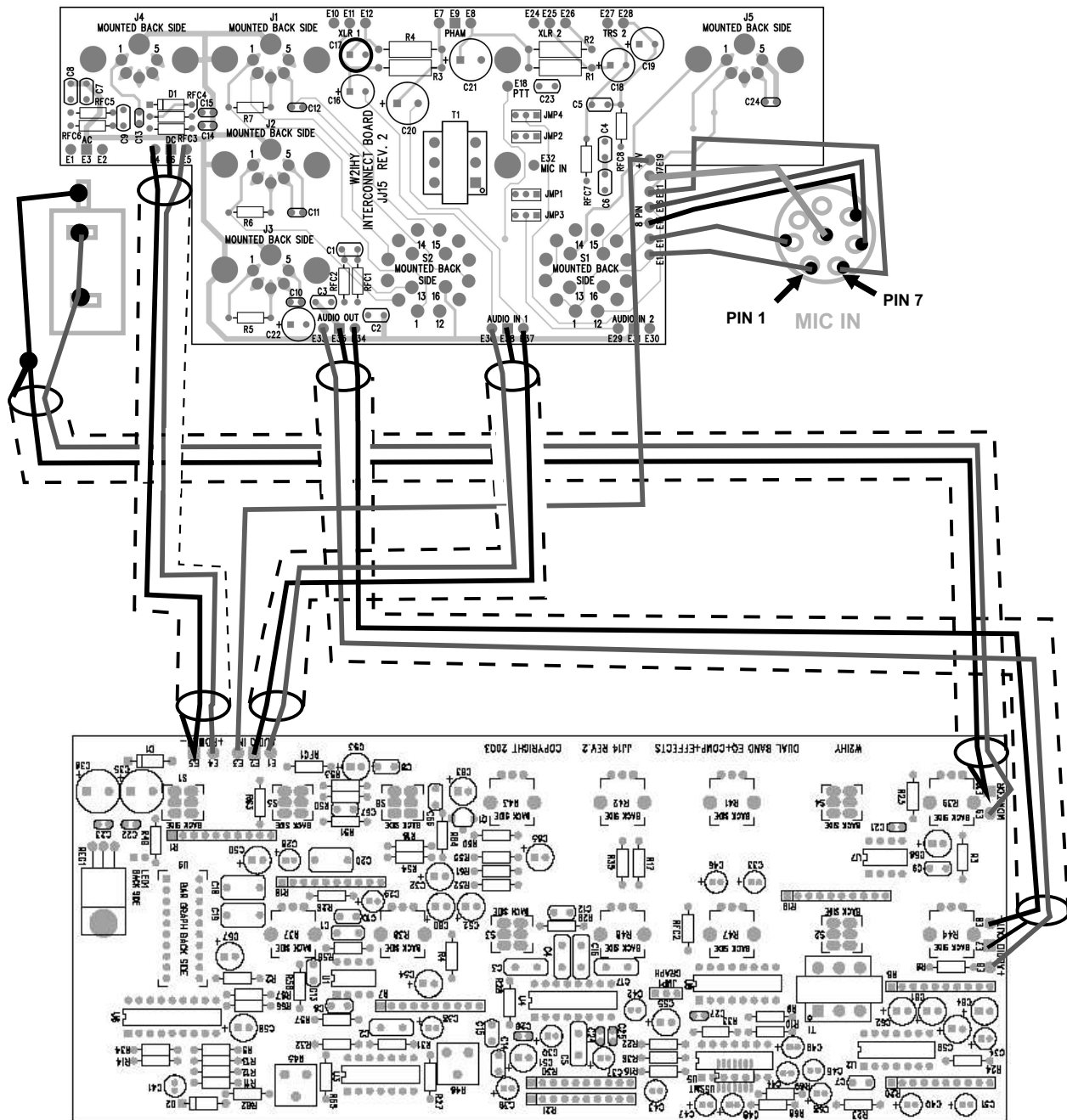

AUDIO OUT CABLE WIRING

5 PIN DIN AUDIO OUTPUT CONNECTION

AUDIO OUT 1/2/3
5 Pin Male DIN
Din connectors shown
on side to be soldered

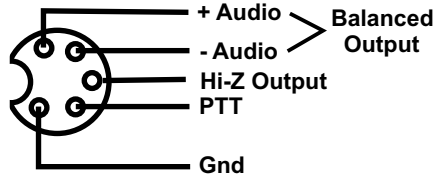

Low Impedance Balanced Output to Low Impedance Radio

AUDIO OUT 1/2/3
5 Pin Male DIN
Din connectors shown
on side to be soldered

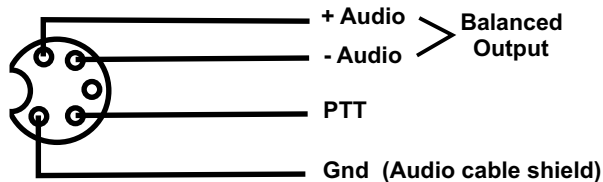

Low Impedance Unbalanced Output to Low Impedance Radio

AUDIO OUT 1/2/3
5 Pin Male DIN
Din connectors shown
on side to be soldered

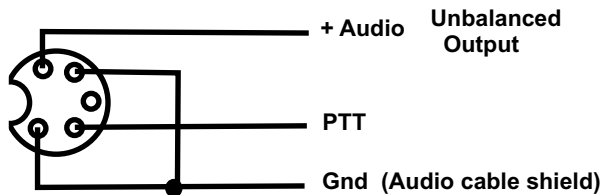

Low Impedance Unbalanced Output to High Impedance Radio

AUDIO OUT 1/2/3
5 Pin Male DIN
Din connectors shown
on side to be soldered

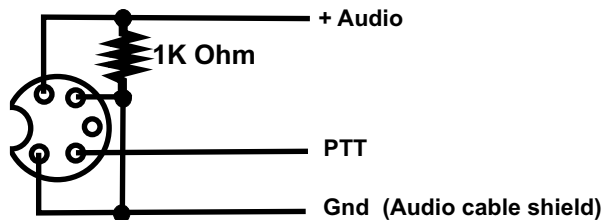

High Impedance Unbalanced Output to High Impedance Radio

AUDIO OUT 1/2/3
5 Pin Male DIN
Din connectors shown
on side to be soldered

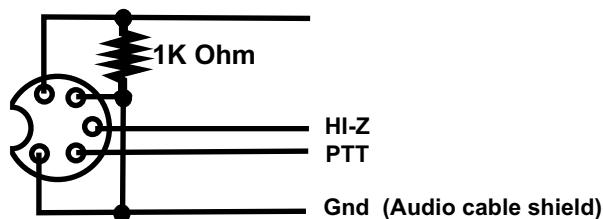

DIN connectors shown on the side to be soldered
DO NOT SOLDER TO SHIELD OF DIN

AUDIO OUT CABLE WIRING

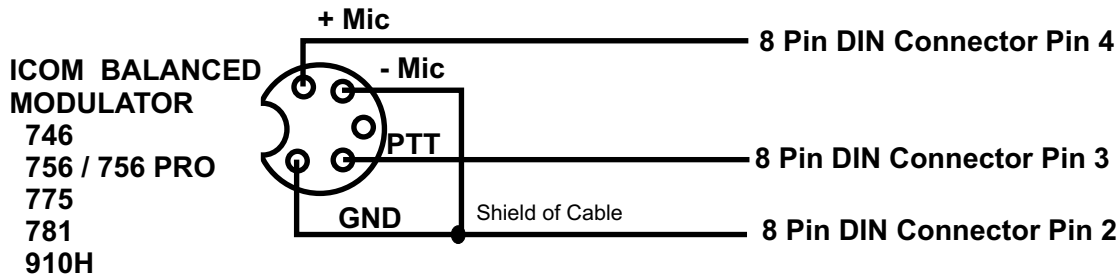
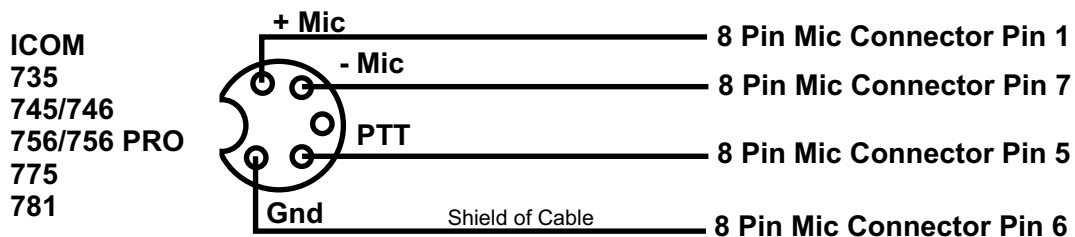
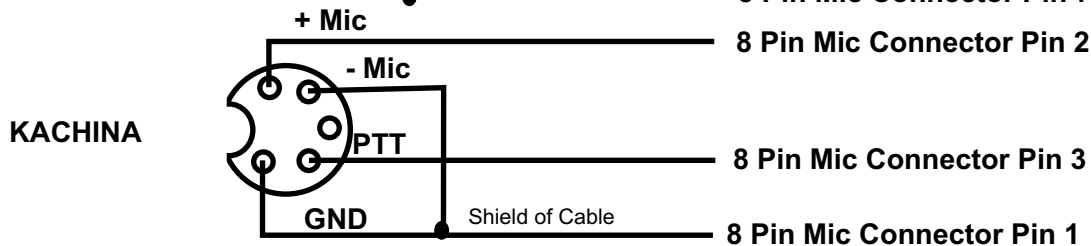
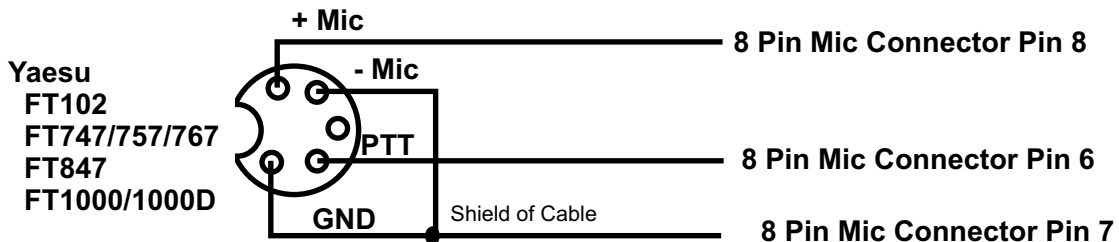
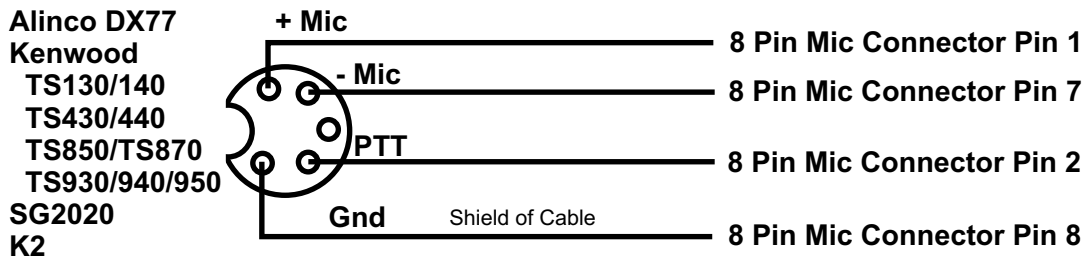
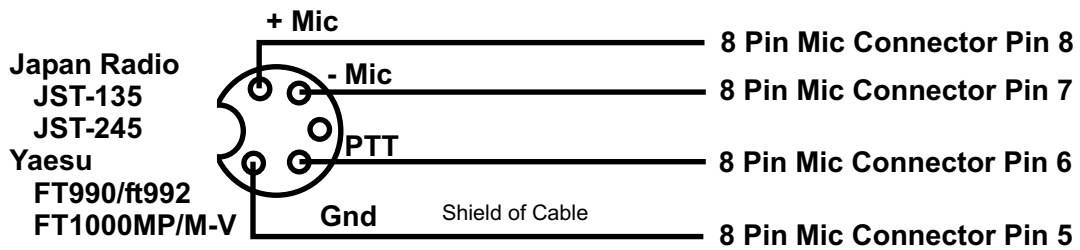

DIN connectors shown on the side to be soldered
DO NOT SOLDER TO SHIELD OF DIN

AUDIO OUT & POWER CABLE WIRING

DRAKE T4XB
COLLINS 32S 1, 32S3
COLLINS KWM2A

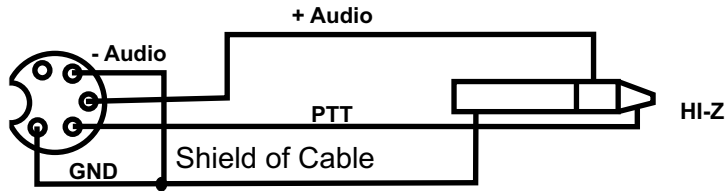

COLLINS 32V2, 32V3
Hallicrafters
E.F. Johnson

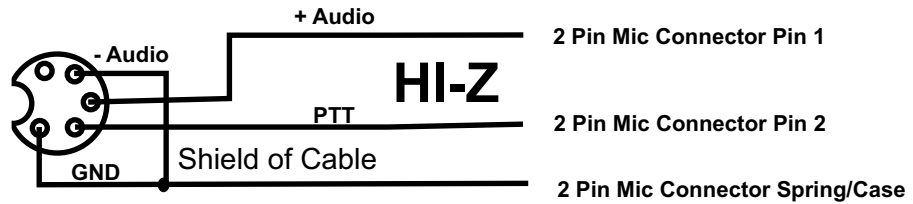

DRAKE TR7

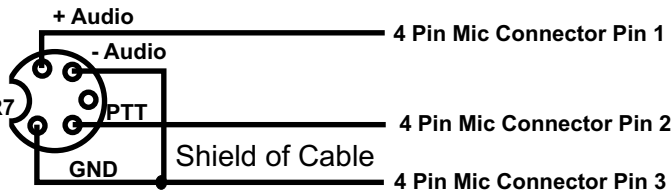

4 PIN TEN TEC
EXCEPT ORION

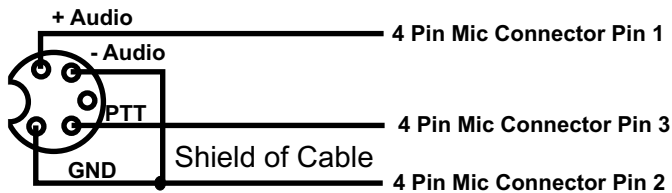

TEN TEC
ORION

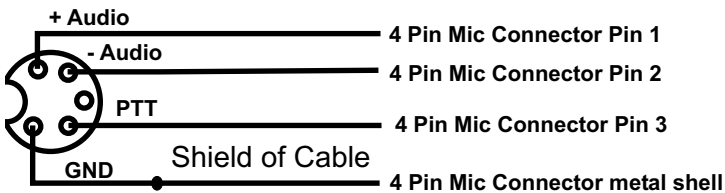

Kenwood
TS520/TS530
TS820/TS830

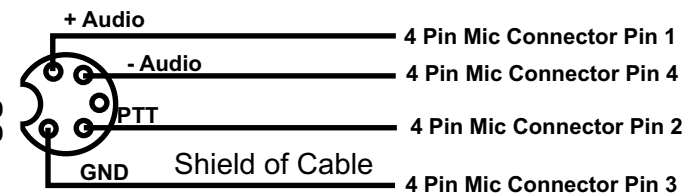

Yaesu
FT101E
FT901DM

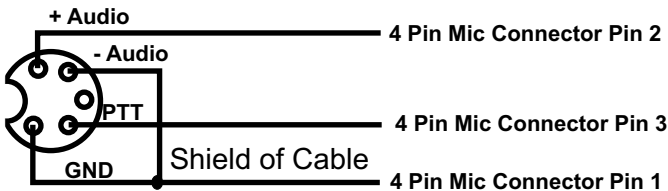

Galaxy

Power

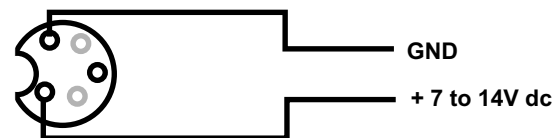

DIN connectors shown on the side to be soldered
DO NOT SOLDER TO SHIELD OF DIN

AUDIO OUT CABLE WIRING

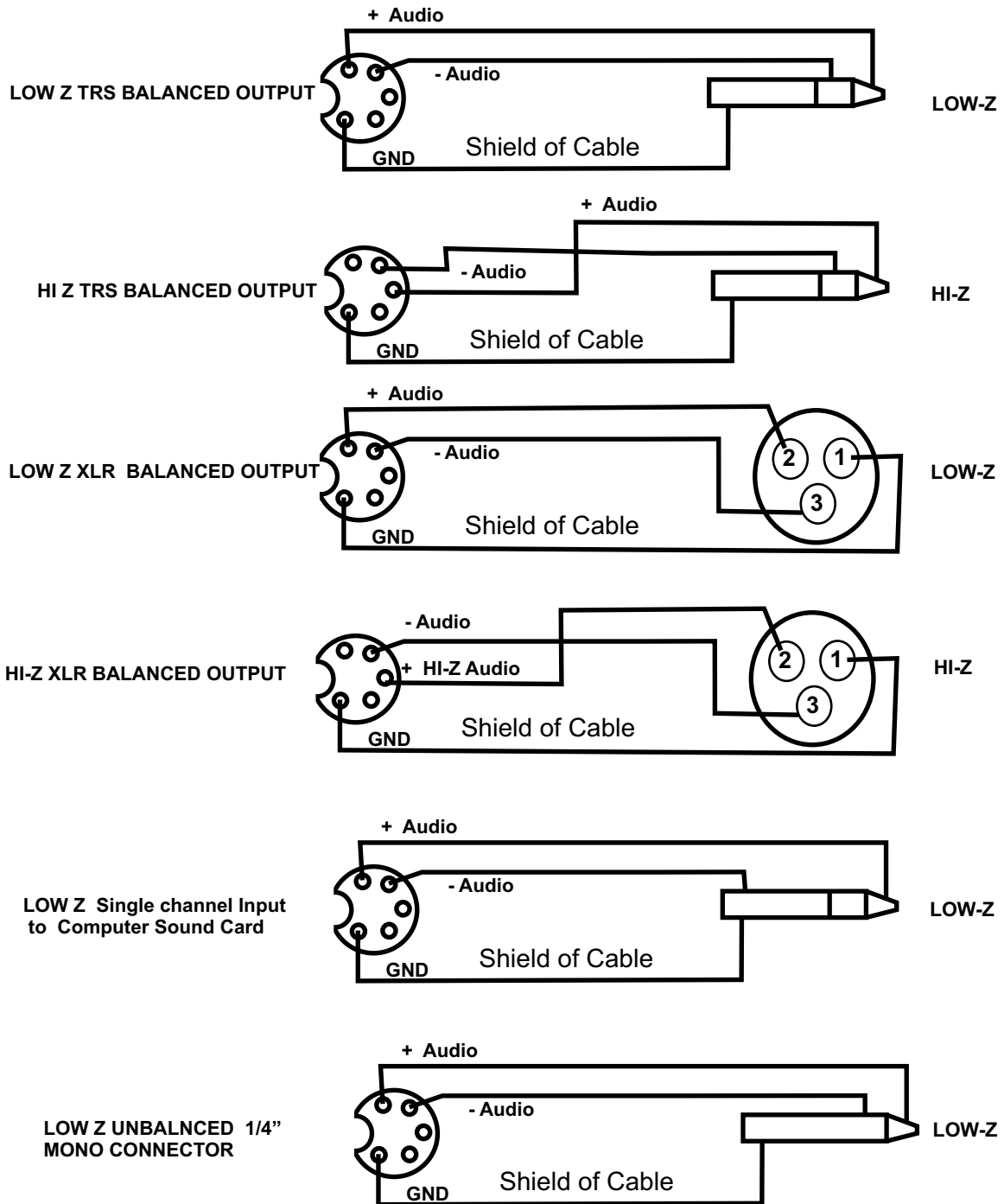

DIN connectors shown on the side to be soldered
DO NOT SOLDER TO SHIELD OF DIN

Free Manuals Download Website

<http://myh66.com>

<http://usermanuals.us>

<http://www.somanuals.com>

<http://www.4manuals.cc>

<http://www.manual-lib.com>

<http://www.404manual.com>

<http://www.luxmanual.com>

<http://aubethermostatmanual.com>

Golf course search by state

<http://golfingnear.com>

Email search by domain

<http://emailbydomain.com>

Auto manuals search

<http://auto.somanuals.com>

TV manuals search

<http://tv.somanuals.com>