

# KENWOOD

MINIDISC PERSONAL STEREO SYSTEM

## MDX-F1

---

### INSTRUCTION MANUAL





KENWOOD CORPORATION



B60-4535-10 01 (MA) (M) AP 9909

## Safety precautions

**WARNING :** TO PREVENT FIRE OR ELECTRIC SHOCK, DO NOT EXPOSE THIS APPLIANCE TO RAIN OR MOISTURE.

	<p><b>CAUTION</b> RISK OF ELECTRIC SHOCK DO NOT OPEN</p>		<p>CAUTION: TO REDUCE THE RISK OF ELECTRIC SHOCK, DO NOT REMOVE COVER (OR BACK). NO USER-SERVICEABLE PARTS INSIDE. REFER SERVICING TO QUALIFIED SERVICE PERSONNEL.</p>
	<p>THE LIGHTNING FLASH WITH ARROWHEAD SYMBOL, WITHIN AN EQUILATERAL TRIANGLE, IS INTENDED TO ALERT THE USER TO THE PRESENCE OF UNINSULATED "DANGEROUS VOLTAGE" WITHIN THE PRODUCT'S ENCLOSURE THAT MAY BE OF SUFFICIENT MAGNITUDE TO CONSTITUTE A RISK OF ELECTRIC SHOCK TO PERSONS.</p>		
	<p>THE EXCLAMATION POINT WITHIN AN EQUILATERAL TRIANGLE IS INTENDED TO ALERT THE USER TO THE PRESENCE OF IMPORTANT OPERATING AND MAINTENANCE (SERVICING) INSTRUCTIONS IN THE LITERATURE ACCOMPANYING THE APPLIANCE.</p>		

### The marking of products using lasers (Except for some areas)

**CLASS 1  
LASER PRODUCT**

The marking is located on the rear panel and says that the component uses laser beams that have been classified as Class 1. It means that the unit is utilizing laser beams that are of a weaker class. There is no danger of hazardous radiation outside the unit.



# Contents

## Preparation section

Before applying power .....	2
Safety precautions .....	2
Special features .....	4
System connection .....	5
Controls and indicators .....	6
Main unit .....	6
Display .....	7
Operation of remote control unit .....	8
Setting the current time .....	9

## Operation

Let's put out some sound .....	10
Basic use method .....	10
Listening through headphones .....	10
Adjusting the bass and treble .....	11
AUTO POWER SAVE function .....	12
Playback of CD .....	13
Listening in the desired sequence (program playback) .....	15
Repeated playback .....	16
Listening to an unexpected title sequence (random playback) .....	17
Playback of Mini Disc .....	18
Searching a desired track by its title (TITLE SEARCH) .....	20
Title display .....	21
Listening in the desired sequence (program playback) .....	22
Repeated playback .....	23
Playback of tape .....	24
To wind tape at high speed .....	25
To stop playback .....	25
Selection of reverse mode .....	25
Selection of TAPE EQ. ....	25
Receiving broadcast station .....	26
Presetting radio stations automatically (auto preset) .....	27
One-by-one presetting (manual preset) .....	27

Let's recording .....	28
Recording on MD .....	28
Recording on TAPE .....	30
Convenient Recording Methods .....	32
One-touch recording (CD→MD/ CD→TAPE) .....	32
Program recording (CD → MD/CD → TAPE) .....	33
Program recording (MD→TAPE) .....	34
MD Edit Functions .....	35
Assigning a title to a disc or track .....	35
Changing or deleting a title .....	37
Moving several tracks at a time (QUICK MOVE) .....	38
Moving a single track (TRACK MOVE) .....	39
Dividing a track (TRACK DIVIDE) .....	40
Combining two tracks (TRACK COMBINE) .....	41
Erasing a single track (TRACK ERASE) or erasing all tracks on a disc (ALL ERASE) .....	42
Timer operation .....	44
Setting the O.T.T. timer .....	44
Setting the Program Timer .....	45
Execution and cancellation of timer .....	47
Sleep timer (SLEEP) .....	47

## Knowledge section

Important Items .....	48
Maintenance .....	48
Reference .....	49
Handling of discs .....	50
Notes on cassette tape .....	51
SCMS (Serial Copy Management System) .....	51
In case of difficulty .....	52
Specifications .....	56

# Special features

## An MD recorder is equipment

An MD recorder with high digital sound quality is equipment. Digital copying from a CD is also easy. This recorder has many functions like recording and display of names for discs and titles, changing the sequence of tracks, etc.

## CD player and auto-reverse cassette deck as standard equipment

A CD player and auto-reverse cassette deck are also provided in addition the MD recorder, making the unit an integrated minidisc personal stereo system for enjoyment of multiple music sources.

## Convenient Recording Methods

Various versatile recording functions are provided according to the use purposes.

- One-touch recording : Recording of one CD or one track by pressing a single key
- Program recording : Any desired tracks can be recorded in the desired sequence

## One-touch operation function

Even when the power is off (STANDBY mode), pressing any of the CD ▶/II, MD ▶/II, TAPE ◀▶ key or TUNER FM/AM key turns the system on and starts playback (reception) of the source.

## Convenient timer functions

**Wake-up timer(O.T.T.) :** Timer operates only once.

**Two-program timer :** Timer playback, timer recording and AI timer playback can be programmed.

- AI timer: An Artificial Intelligence increases the volume gradually after the power is turned on by the timer.

**Sleep timer :** Power turns off automatically when the set time has elapsed. Convenient for sleeping while listening to music, for example.

## In regard to demonstration

This unit is equipped with a demonstration function. The demonstration consists of sequential change of display and indicators showing the operations, but the audio itself does not change. The demonstration function can be cancelled as follows.

- Even when DEMO is ON, stations with weak radio waves are muted and their sound cannot be heard.
- This operates automatically when a power failure has occurred or the plug of the power cable has been pulled while the power was ON. Cancellation is possible by pressing the key during the demonstration.

**DEMO OFF (To cancel demonstration):**

Press the "SET/Demo" key when DEMO is ON.

**DEMO ON (To execute demonstration):**

After turning power ON, press and hold the SET/Demo key (for more than 2 seconds) (In stop mode of CD, MD or TAPE).



## Unpacking

Unpack the unit carefully and make sure that all accessories are put aside so they will not be lost.

Examine the unit for any possibility of shipping damage. If your unit is damaged or fails to operate, notify your dealer immediately. If your unit was shipped to you directly, notify the shipping company without delay. Only the consignee (the person or company receiving the unit) can file a claim against the carrier for shipping damage.

We recommend that you retain the original carton and packing materials for use should you transport or ship the unit in the future.

Keep this manual handy for future reference.

### Accessories

Please confirm that the following accessories are present.

Power cord (1)

Loop antenna (1)

Remote control unit (1)

R6/SUM-3 batteries for remote (2)

AC plug adaptor (1)

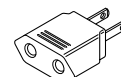
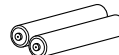
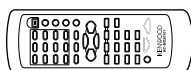
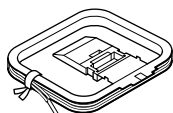

- Power cord differ depending on the country and sales area.

# System connection

**CAUTION** Note on Connection  
 Connect the components as shown in the diagram.  
 Only plug the power cord into a power outlet once  
 connections are completed.

**Malfunction of microcomputer**  
 If operation is not possible or erroneous display appears even though all connections have been made properly, reset the microcomputer referring to "In case of difficulty".

→ 52

## FM outdoor antenna

(separately available in audio stores)

When the receiving condition is poor, lay a coaxial cable from the antenna to indoors and connect to the FM 75Ω terminals.

## AM loop antenna

The supplied antenna is for indoor use. Place it as far as possible from the main system, TV set and power cord, and set it to a direction which provides the best reception.

## FM rod antenna

Extend and orient in the direction providing the best receiving condition.

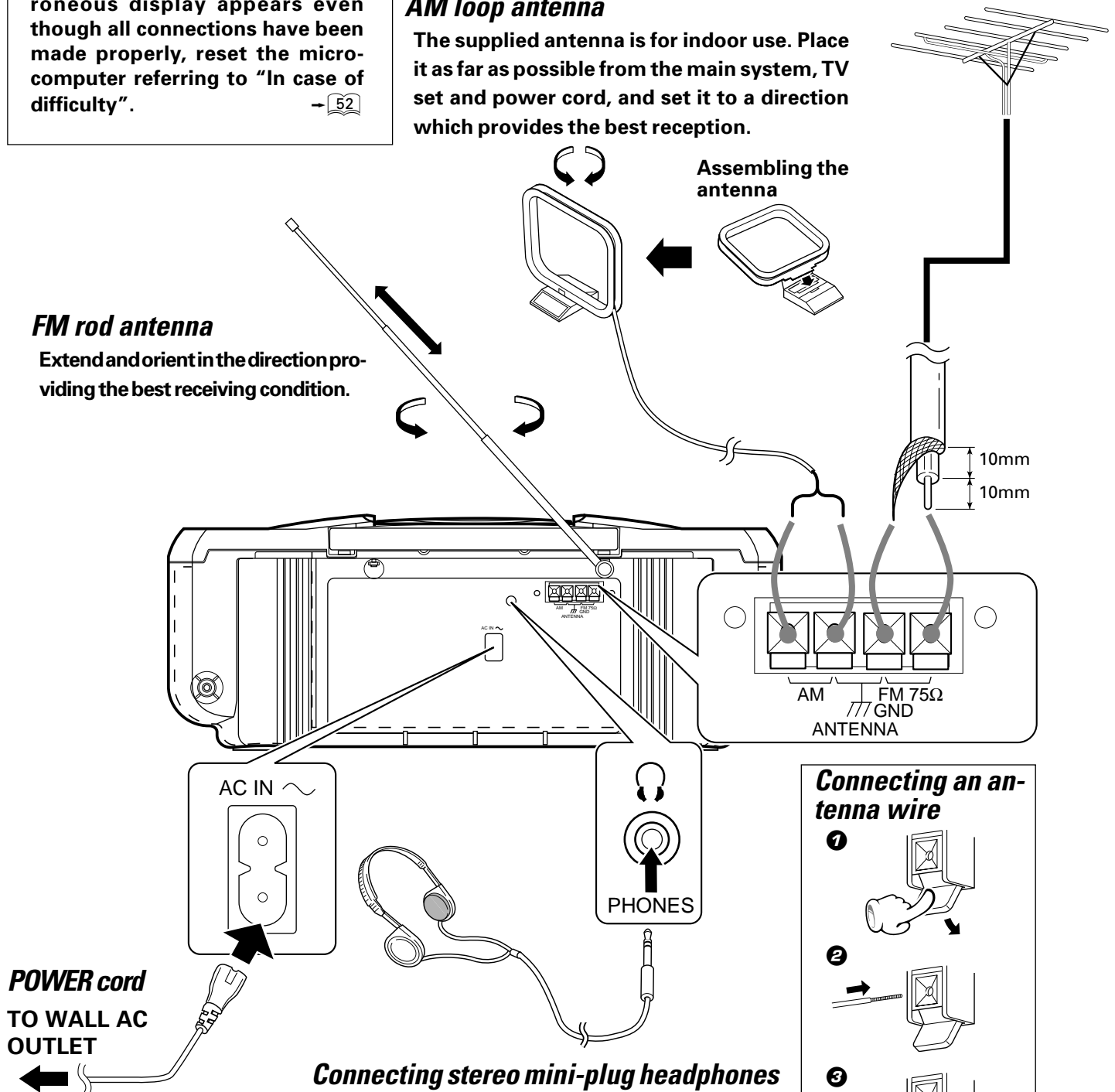

### Connecting an antenna wire

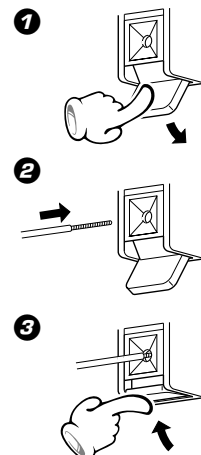

## Connecting stereo mini-plug headphones (separately available in audio stores)

Unplug the headphones from the PHONES jack when listening through speakers.

1. Be sure to insert all connection cords securely. If their connections are imperfect, the sound may not be produced or noise may interfere.
2. It is dangerous to install the outdoor antenna by yourself. Please have your dealer or a specialist install it.
3. When this unit is installed too close to a TV, color irregularities may be produced on the TV screen.



# Main unit

## Top panel



## Front panel

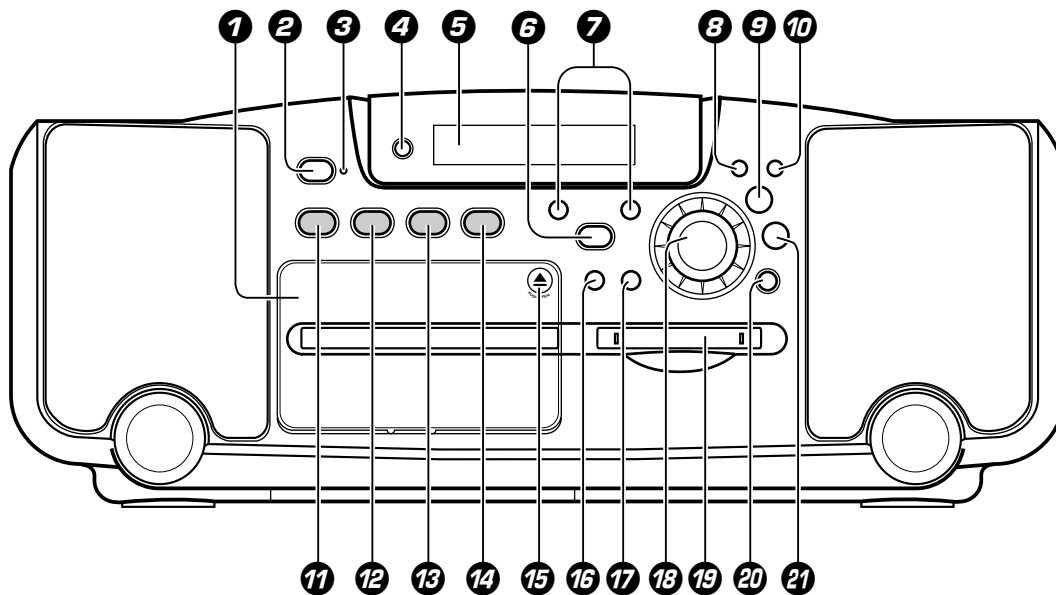

Preparation section

- |  |                         |                                       |              |
|--|-------------------------|---------------------------------------|--------------|
| <b>1</b> Cassette holder                       | → 24                    | <b>11</b> "TUNER FM/AM" key           | → 26         |
| <b>2</b>   / ⏻ (POWER) key                     | → 9                     | <b>12</b> "CD ▶/⏸" key                | → 13         |
| <b>3</b> "STANDBY/TIMER" indicator             | → 9 → 47                | <b>13</b> "MD ▶/⏸" key                | → 18         |
| <b>4</b> Remote sensor                         |                         | <b>14</b> "TAPE ◀▶" key               | → 24         |
| <b>5</b> Display                               |                         | <b>15</b> PUSH OPEN button            | → 24         |
| <b>6</b> (■) STOP key (CD/MD/TAPE/TUNING MODE) | → 9 → 14 → 19 → 25 → 26 | <b>16</b> "TAPE REC" key              | → 30         |
| <b>7</b> ◀◀ / ▶▶ key (CD/MD/TAPE/tuner tuning) | → 14 → 19 → 25          | <b>17</b> "MD REC" key                | → 28         |
| <b>8</b> "SOUND" key                           | → 11                    | <b>18</b> "VOLUME/MULTI CONTROL" knob | → 7 → 9 → 10 |
| <b>9</b> "MENU" key                            | → 7 → 9                 | <b>19</b> Mini Disc insertion slot    |              |
| <b>10</b> "REPEAT" key                         | → 16                    | <b>20</b> EJECT (▲) key               | → 19         |
|  |                         | <b>21</b> "SET/Demo" key              | → 4 → 7 → 9  |

### About the one-touch operation function

This unit incorporates the one-touch operation function for the user's convenience.

With this function, pressing any key enclosed in    (11~12) while the unit is in standby mode immediately start playback (or reception).

# Display

(The displays given in this manual are approximations only. They may differ from what actually appears on the display.)

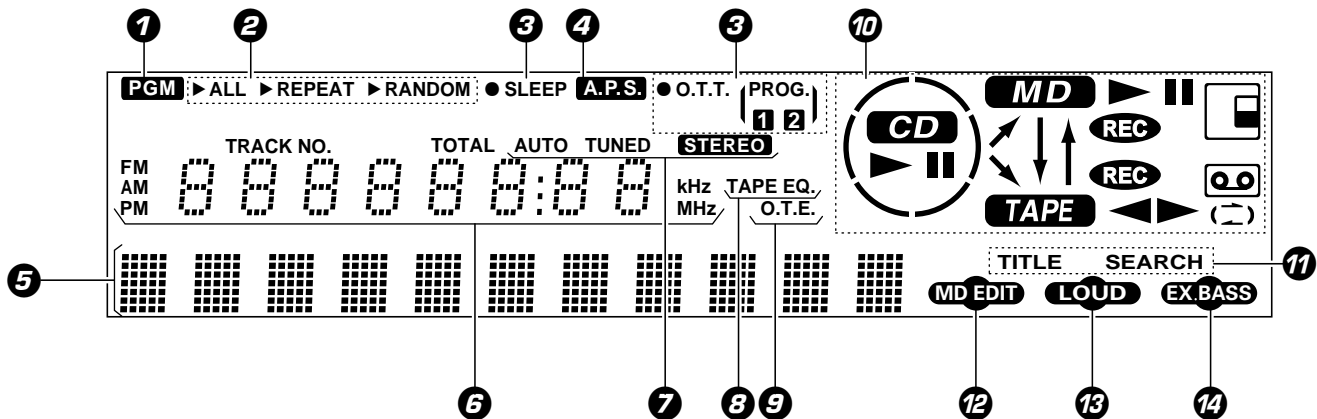

- ❶ PGM (program) indication
- ❷ Indication related to CD and MD
- ❸ Timer-related indicators
- ❹ A.P.S. (Auto Power Save) indicator
- ❺ Character information display section (dot display)  
Shows character information including the input selection, volume level and disc/track title.
- ❻ Character information display section  
Frequency indication, time indication, track No., program No., etc.
- ❼ Tuner-related indicators
- ❽ TAPE EQ. indication
- ❾ O.T.E. (ONE TOUCH EDIT) indication  
Appears during one-touch recording.
- ❿ Selector-related indicators
- ⓫ TITLE SEARCH indication
- ⓬ MD EDIT indication
- ⓭ LOUD (Loudness) indication
- ⓮ EX.BASS (extra bass) indication

## About the VOLUME/MULTI CONTROL knob (Main unit)

- ❶ Press the MENU key.
- ❷ Rotate the VOLUME/MULTI CONTROL knob to select an item.
- ❸ Press the SET/Demo key to set or enter the selection of the item.

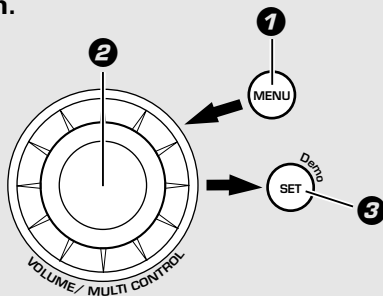

Turning the knob switches the function as shown in the display.

TAPE RVS.	?	→ 25
REC MODE	?	→ 32
AUTO PRESET	(TUNER only)	→ 27
TIMER SET	?	→ 44
A.P.S. SET	?	→ 12

- The function of the control knob returns to the normal mode when it has not been operated for 5 seconds.

The keys on the remote control unit with the same names as on the main unit have the same function as the keys on the main unit.

Preparation section

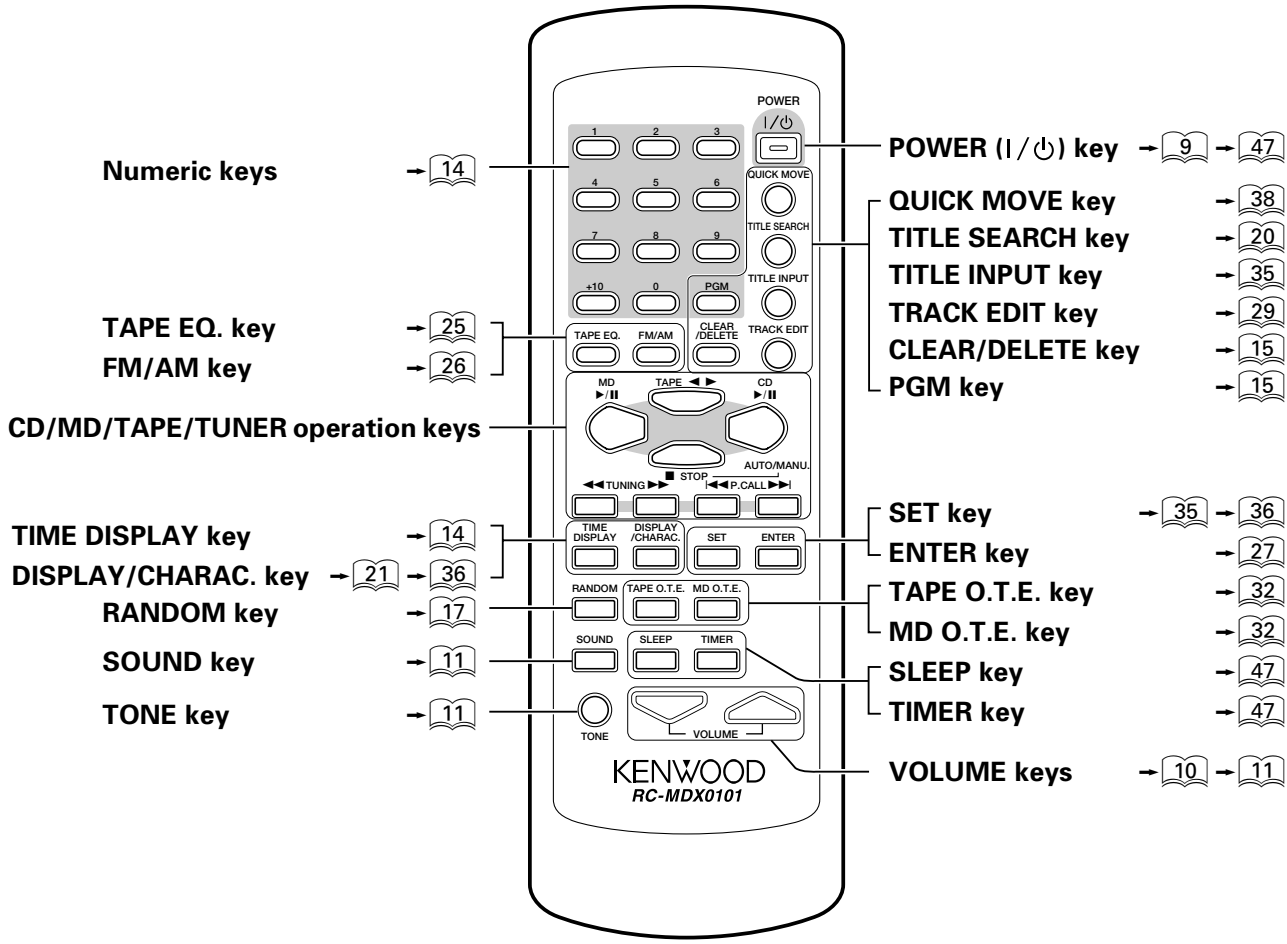

**Loading batteries**

❶ Remove the cover.

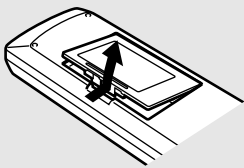

❷ Insert batteries.

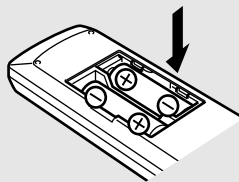

❸ Close the cover.

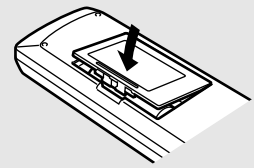

● Insert two R6 ("AA"-size) batteries following the polarity indications.

**Operation**

After plugging the power cord of this unit, press the **POWER (I / ⏻)** key of the remote control unit to turn the system ON. When the system is turned ON, press the key of the function to be operated.

Press the **POWER (I / ⏻)** key again for OFF.

The unit enters standby mode in which only the "STANDBY/TIMER" indicator is lit.

- When pressing more than one remote control keys successively, press the keys securely by leaving an interval of 1 second or more between keys.
- The standard remote control range is within about 6 meters from the main unit front panel and within 30 degrees to the left or right of the center line from the front. Be sure to point the remote control unit to the front panel.



1. The provided batteries are intended for use in operation checking, and their service life may be short.
2. When the remote controllable distance becomes short, replace both of the batteries with new ones.
3. If direct sunlight or the light of a high-frequency fluorescent lamp (inverter type, etc.) is incident to the remote sensor, malfunction may occur. In such a case, change the installation position to avoid malfunction.



# Setting the current time

MDX-F1 (EN)

The current time of the day must be set before using the timer.

## Preparation

Press the power (I/⏻) key to turn power on.

(Main unit)

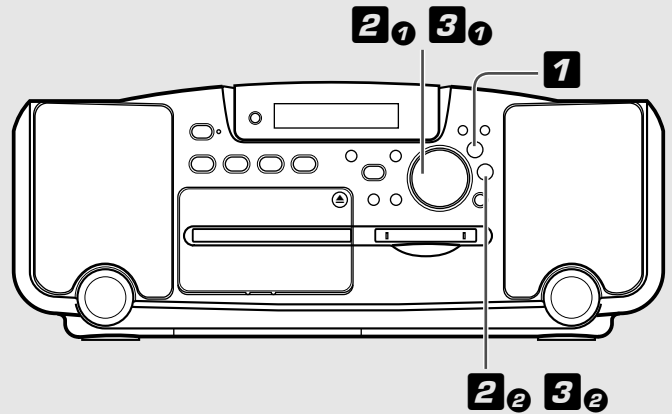
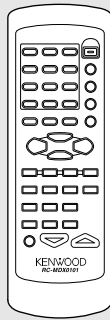

### 1 Press and hold the MENU key for more than 2 seconds.



- The "CLOCK" display starts to blink during time setting.

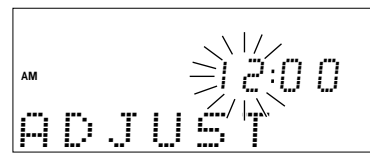

- The time display starts to blink.

### 2 Enter the figure of hour.

1

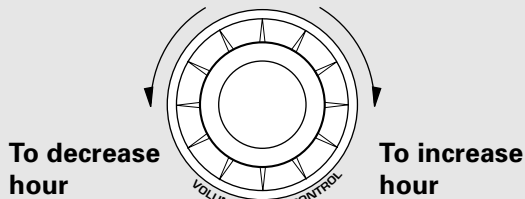

2

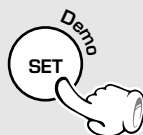

#### Example: Adjustment to 8:07

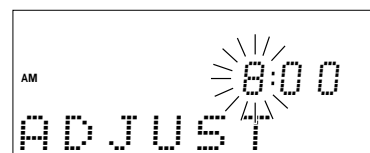

- The time of the day is represented in 12-hour AM/PM method.
- Press the **SET/Demo** key. The hour is entered and the minute display starts to blink.

### 3 Enter the figure of minute.

1

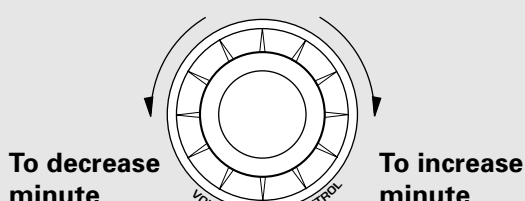

2



#### Example: Adjustment to 8:07



- If you make a mistake, restart from the beginning.
- To adjust correct time, press the **SET/Demo** key at the same moment as a time announcement.
- After a power failure of more than 10 minutes or the power cord has been unplugged for more than 10 minutes, the current time should be set again.
- When the time of day has been set by pressing the **SET/Demo** key, the display shows "COMPLETE!".
- ":" (colon) blinks when the time of day has already been set.

### To display the time

(In standby mode)

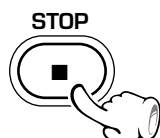

(Displayed for 5 sec.)

## Basic use method

### Standby mode

While the standby indicator of the unit is lit, a small amount of current is flowing into the unit's internal circuitry to back up the memory. This condition is referred to as the standby mode of the unit. While the unit is in the standby mode, it can be turned ON from the remote control unit.

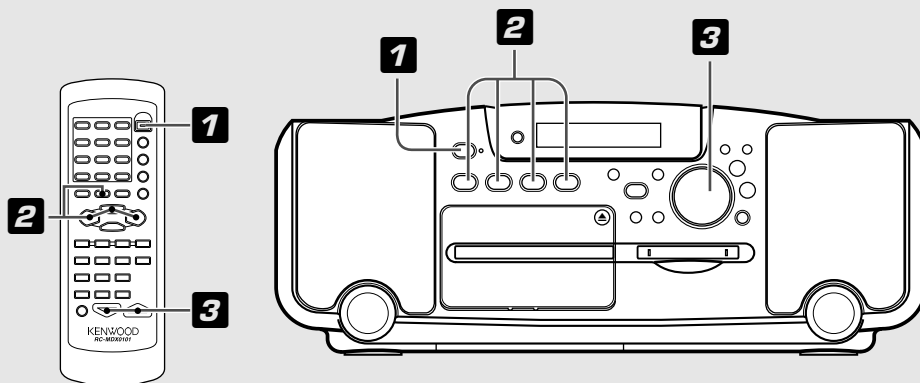

### 1 Press the | / ⏻ (POWER) key to turn power on.

When the “| / ⏻ (POWER)” key is pressed while the unit is ON, the unit is switched off and the “STANDBY/TIMER” indicator lights up.

The indicators lights in green when the OTT, PROG 1 or PROG 2 timer is activated. → 47

- Pressing the CD ▶/||, MD ▶/||, TAPE ◀◀ or TUNER FM/AM key also turns power on and starts playback (reception) of the corresponding input. (One-touch operation)

### 2 Selecting the desired output.

To play a CD : Press the CD ▶/|| key. → 13

To play a MD : Press the MD ▶/|| key. → 18

To play a TAPE : Press the TAPE ◀◀ key. → 24

To play a TUNER  
: Press the TUNER FM/AM key. → 26

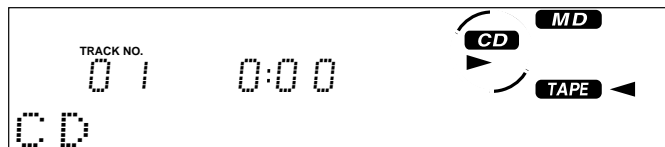

When CD has been selected.

### 3 Volume adjustment.

(Main unit)

(Remote control)

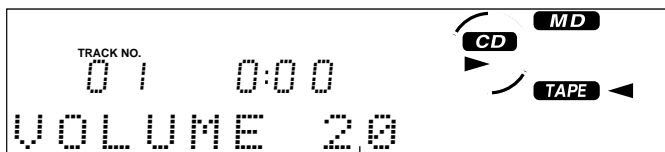
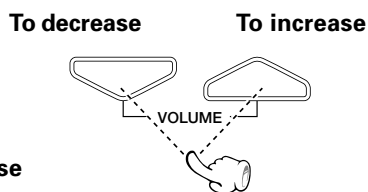
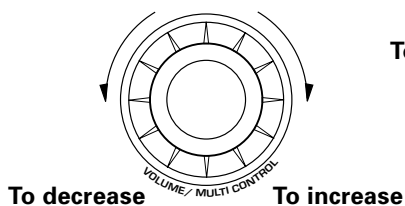

Volume display

### Listening through headphones

Insert the plug of the headphones into the PHONES jack on the rear panel.

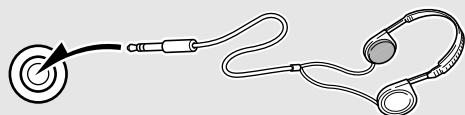

PHONES

- Headphones with a stereo mini plug can be connected.
- The sounds from all speakers are cut off.

## Adjusting the bass and treble

### One-touch enhancement of bass and treble

**"EX.BASS" (Extra Bass)** : Enhances the bass tone regardless of the current volume.

**"LOUD" (Loudness)** : Enhanced both the bass and treble tones according to the current volume. (Effective during low-volume listening)



Each press switches the modes as follows.

- ① "EX.BASS" lights.
  - ② "LOUD" lights.
  - ③ Both indicators off.
- The tone adjusted using the "TONE" key (see below).

### Fine adjustment of bass and treble (Remote control only)

① Press the TONE key.



(Go to step ② within 5 seconds.)

② Adjust the VOLUME keys.

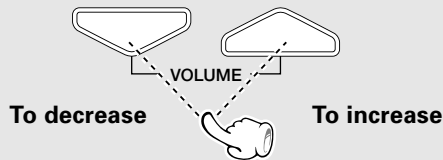

Each press switches the operation.

- ① "BASS" (low frequency) adjustment
- ② "TREBLE" (high frequency) adjustment
- ③ Normal mode

- The levels of both "BASS" and "TREBLE" can be adjusted in 2 steps in the range between -8 and +8.
- If tone control is started while the "LOUD" or "EX.BASS" indicator is lit, the "LOUD" or "EX.BASS" setting is canceled.  
 (The adjustment using the "TONE" key cannot be used simultaneously with the adjustment using the "EX.BASS" and/or "LOUD" switch.)

**AUTO POWER SAVE function**

When the unit is ON and the unit is left for 30 minutes with CD, MD and TAPE not operating, the unit is switched off automatically by this function. This is convenient when you forget to turn power off after listening. This function can be activated or deactivated by the following operation.

- If the current input is TUNER, the auto power save function is activated only when the volume is set to 0.

① Select "A.P.S. SET?" from the menu.

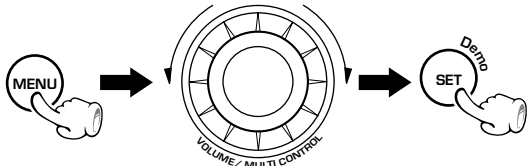

(Press the "SET/Demo" key while the "?" mark is blinking)

② Select.

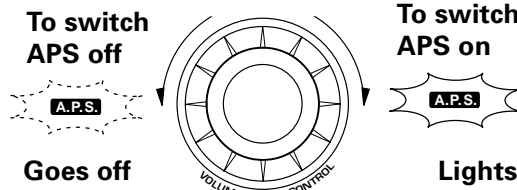

③ Press the SET/Demo key.



# Playback of CD

MDX-F1 (EN)



If you load a disc in the CD player in advance while the power is off, pressing the CD ▶/II key turns power on automatically and starts the disc playback.

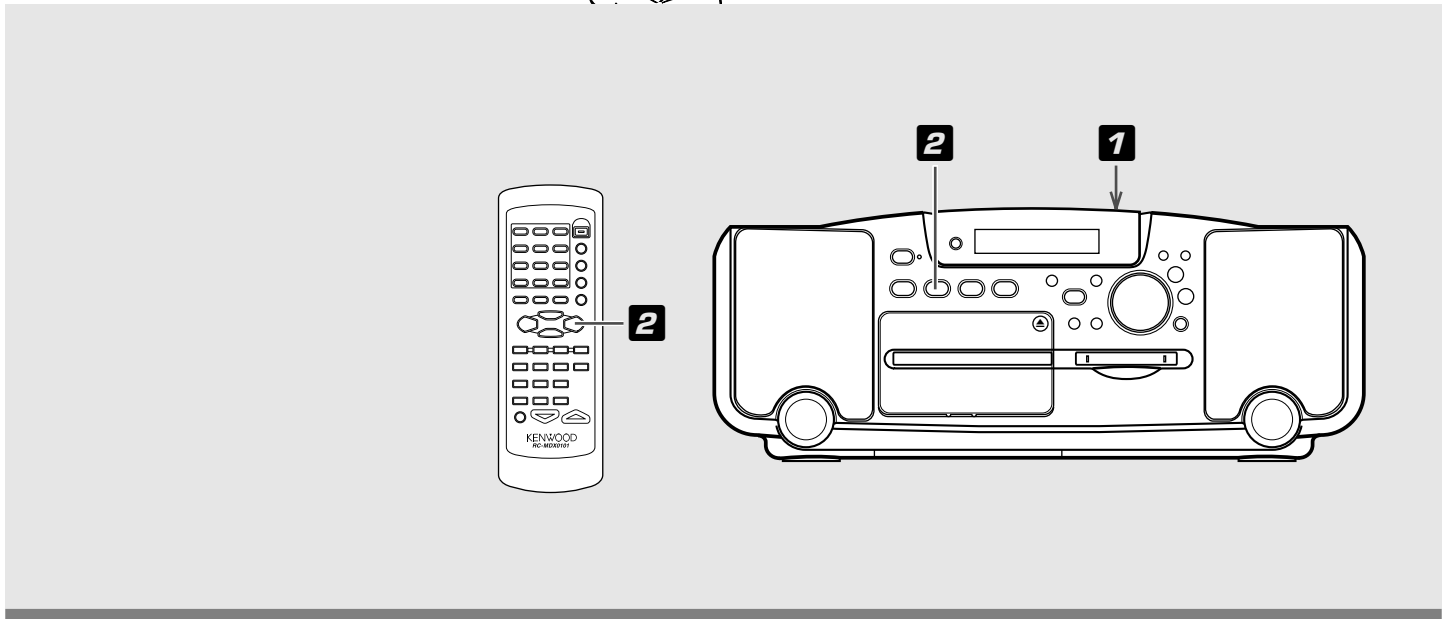

## 1 Load a disc.

- 1 Open the CD cover.  
(by pressing the PUSH OPEN button)
- 2 Place a disc.
- 3 Close the CD cover.

The label side must be on top.

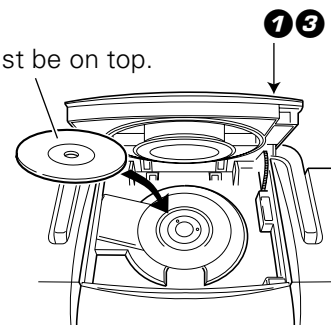

- Do not touch the played side of disc.
- Be sure to place a disc horizontally. Placing it with an inclination will result in malfunction.

## 2 Start playback.

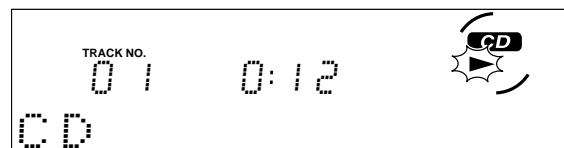
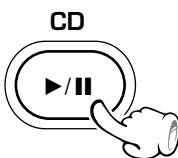

- After a few seconds, play starts from track No.1.

**To pause playback**

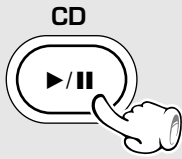

- Each press pauses and plays the CD alternately.

**Skipping tracks**

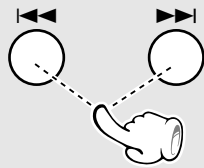

To skip backward

To skip forward

- The track in the direction of the key pressed is skipped, and the selected track will be played from the beginning.
- When the ◀◀ key is pressed once during playback, the track being played will be played from the beginning.
- Operation also is possible with the keys ◀◀ and ▶▶ of the remote control unit.

**Playback from desired track**

Select the desired track No.

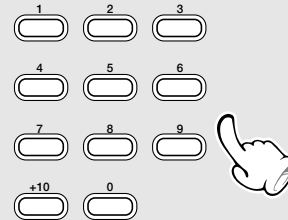

Press the numeric keys as shown below....

To select track No. 23 : [+10] [+10] [3]

To select track No. 40 : [+10] [+10] [+10] [+10] [0]

- If the "PGM" indicator is lit, stop the CD recorder and press the PGM key of the remote control unit to turn the indicator off.

**To fast forward and backward (Remote control unit only)**

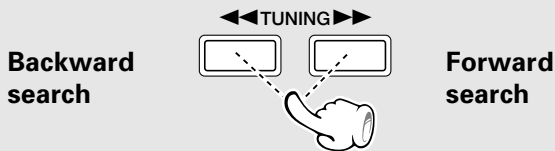

Backward search

Forward search

- Playback starts from the position where the key is released.

**To stop playback**

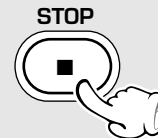

**Ejecting the disc**

- Press the key before making sure that the disc is stopped.



**Time display on CD player**

(Remote control unit only)

Each press of the TIME DISPLAY key changes the displayed contents.

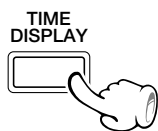

- ① 1:23 (Elapsed time of track being played)
- ② - 2:37 (Remaining time of track being played)
- TOTAL
- ③ 23:45 (Elapsed time of entire disc)
- TOTAL
- ④ - 36:15 (Remaining time on entire disc)

- Only time information ① and ② can be displayed during repeats playback or random playback.

Operation

# Listening in the desired sequence (program playback)

Use the following procedure to program desired tracks in a desired order. (up to 32 tracks)

Select the "CD" input. (Also press the to enter stop mode.) → 13

## 1 Let the "PGM" indicator light.

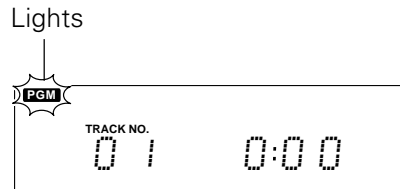

## 2 Select track numbers in the order you want to play them.

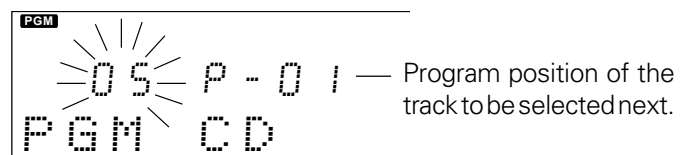
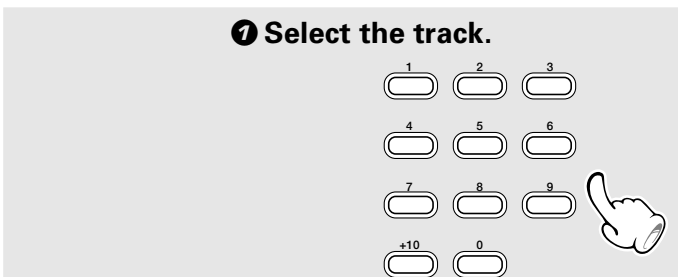

(Go to step 2 within 8 seconds.)

### 2 Confirm the selection.

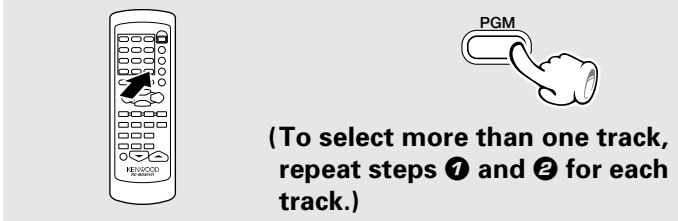

Press the numeric keys as shown below....

To select track No. 23 :

To select track No. 40 :

- Up to 32 tracks can be programmed. When "FULL" is displayed, no more tracks can be programmed.
- If you made a mistake, press the **CLEAR/DELETE** key and enter the track No. again.
- When a track No. is entered, the track will be added to the end of the existing program.
- "-- : --" is displayed when the total programmed period has attained 100 minutes or more.

## 3 Start playback.

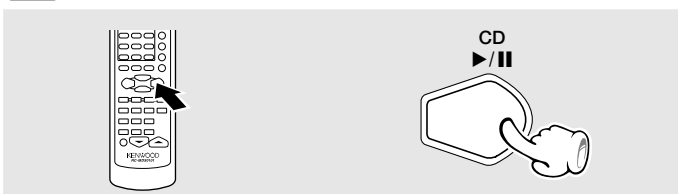

- Tracks will be played in the order they were programmed (following the program numbers).
- When the or the key is pressed during play, the program will jump to the preceding or the following track respectively.
- When the key is pressed once during playback, the play position returns to the beginning of the current track being played.

### To stop playback

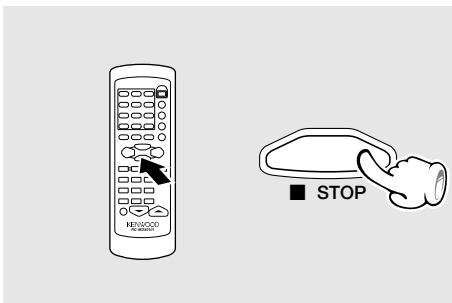

### To quit the program mode

**Clearing tracks from the end**

Press in stop mode

**CLEAR/DELETE**

PGM

-- P-14

(Example when the track in P-14 is canceled)

- Each time the key is pressed, the last track in the program is cleared.

**Clearing all tracks**

Goes off

PGM

- The entire program is cleared.

# Repeated playback

You can repeatedly listen to a favorite track or disc. (The REPEAT key is provided only on the main unit.)

Select the "CD" input. → 13

## Setup for repeating a single track or all tracks

1 Confirm that the "PGM" indicator is not lit.

Confirm that this is not lit.

(If the "PGM" indicator is lit, press the PGM key to turn it off.)

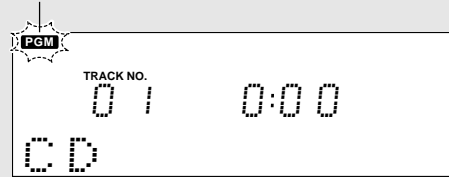

2 Select "REPEAT".



Each press switches the repeat mode.

- 1 "REPEAT"  
Repeats playback of a single track.
- 2 "ALL REPEAT"  
Repeats playback of all tracks in a disc.
- 3 Off.... Repeat deactivated

Lights

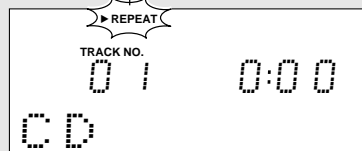

Lights

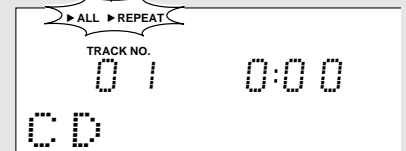

Operation

## Setup for repeating selected tracks

1 Program the track sequence according to steps 1 to 2 of "Listening in the desired sequence". → 15

Lights Lights

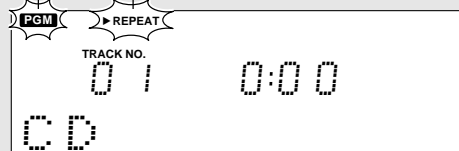

2 Select "REPEAT".



Each press switches the repeat mode.

- 1 "REPEAT"  
All of the programmed tracks will be played repeatedly.
- 2 Off.... Repeat deactivated

• The "REPEAT" and "PGM" indicators light up.

## Start playback

When the single repeat, select the track number. → 14

(Remote control unit)

(Main unit)

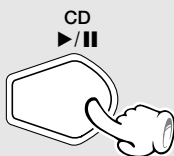
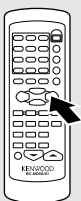

## To stop repeated playback

Press the REPEAT key repeatedly until the repeat mode is switched off.

• The "REPEAT" or "ALL REPEAT" indicator turns off and the repeat play mode is canceled.



# Listening to an unexpected title sequence (random playback)

As the titles each time are selected randomly, the music can be enjoyed without getting tired of it. (Remote control only)

Select the "CD" input. → 13

## 1 Confirm that the "PGM" indicator is not lit.

(If the "PGM" indicator is lit, press the PGM key to turn it off.)

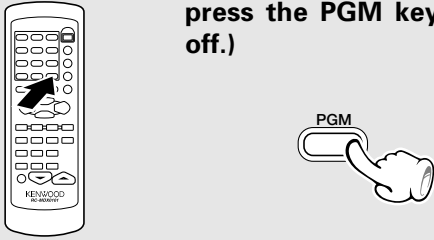

Confirm that this is not lit.

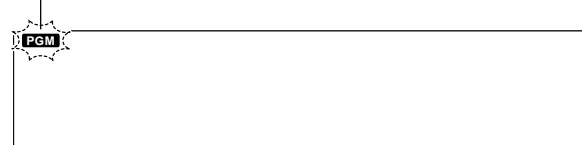

## 2 Press the RANDOM key.



Each press switches the modes as follows.

- ① "RANDOM" on ... Random playback
- ② "RANDOM" off ... Normal playback



- Playback stops after each title has been played once.
- The random playback can also be repeated by pressing the **REPEAT** key.

## To select another track in the middle of playing one

Press the ►►| key to select another track randomly.

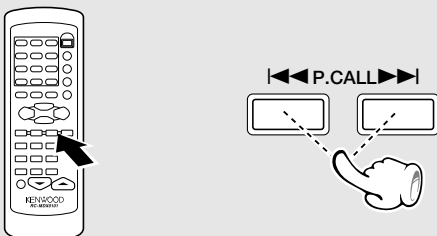

- Pressing the ◀◀ key once returns to the beginning of the track being played.

## To cancel random playback

Press so that the "RANDOM" indicator goes off.

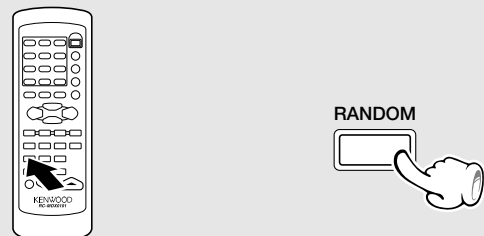

- The "RANDOM" indicator goes off and the playback in order of the tracks starts from the track being played.



If you load a disc in the MD recorder in advance while the power is off, pressing the MD ▶/|| key turns power on automatically and starts the disc playback.

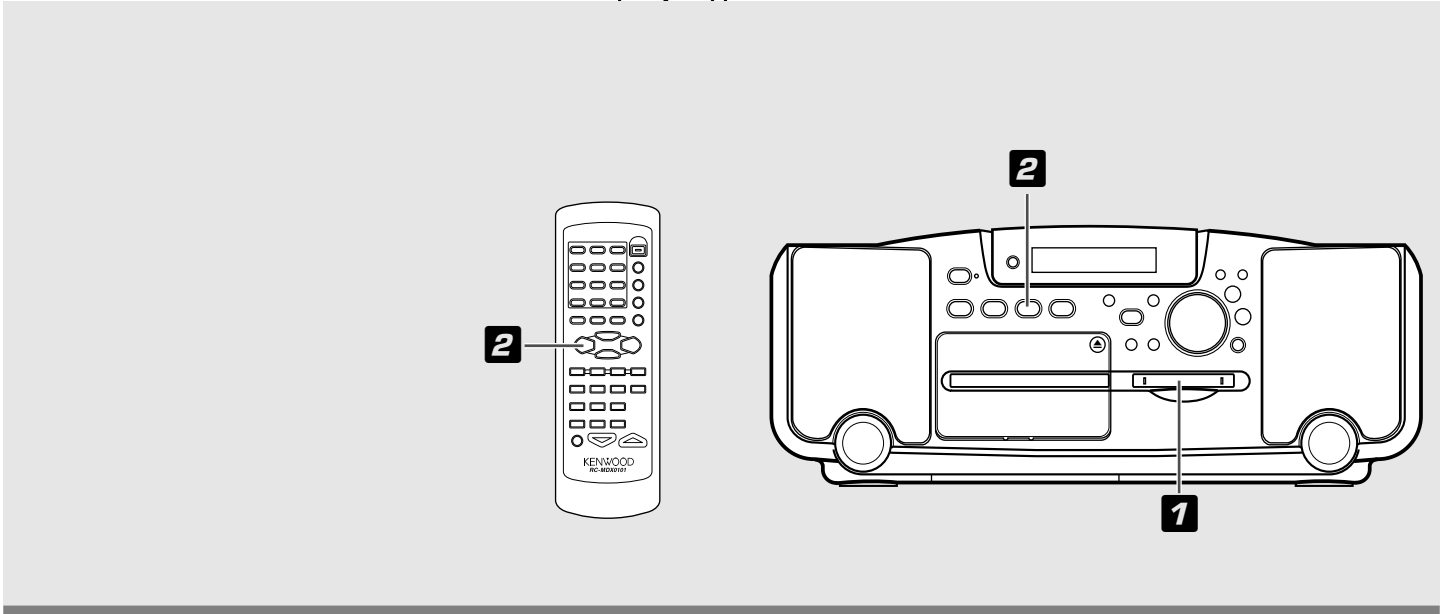

## 1 Load a Mini Disc.

Turn power on and insert a Mini Disc into the insertion slot of the main body.

- When a title has been recorded for the disc, the title is displayed.

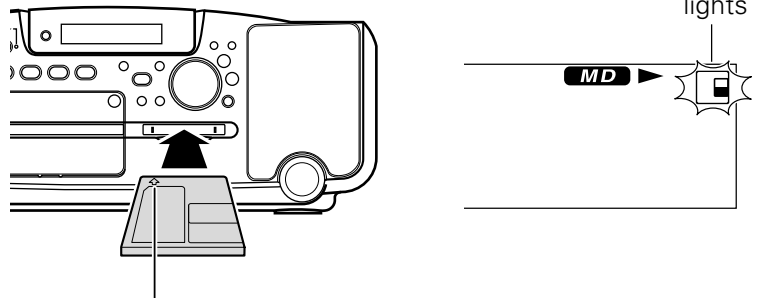

In the direction of the arrow

The display changes.

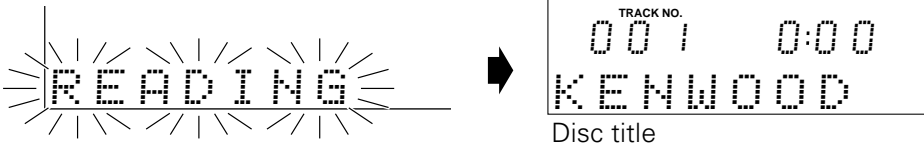

### CAUTION

The MD cannot be loaded or ejected while the unit is in standby mode. Do not force insert a Mini Disc during the STANDBY mode, for this may damage the mechanism.

## 2 Start playback.

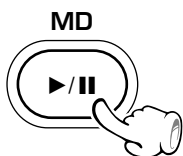

- In a few seconds, playback starts from track No. 1.

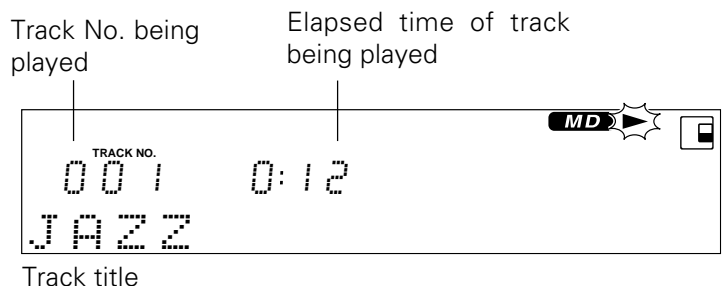

**To pause playback**



- Each press pauses and plays the MD alternately.

**Skipping tracks**



- The track in the direction of the key pressed is skipped, and the selected track will be played from the beginning.
- When the ◀◀ key is pressed once during playback, the track being played will be played from the beginning.
- Operation also is possible with the keys ◀◀ and ▶▶ of the remote control unit.

**To fast forward and backward (Remote control unit only)**

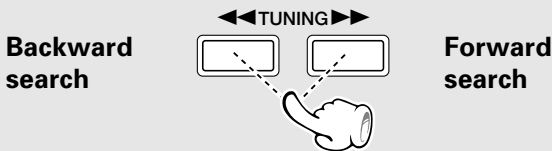

- Playback starts from the position where the key is released.

**Time display on MD recorder (Remote control unit only)**

Each press of the TIME DISPLAY key changes the displayed contents.

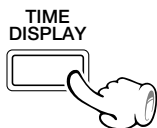

- ① 1:23 (Elapsed time of track being played)
- ② - 2:37 (Remaining time of track being played)
- TOTAL
- ③ 23:45 (Elapsed time of entire disc)
- TOTAL
- ④ - 36:15 (Remaining time on entire disc)

**Playback from desired track**

Select the desired track No.

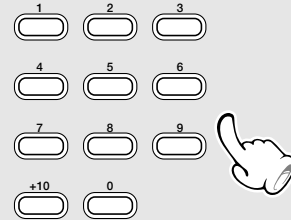

Press the numeric keys as shown below....

To select track No. 23 : [+10] [+10] [3]

To select track No. 40 : [+10] [+10] [+10] [+10] [0]

- If the "PGM" indicator is lit, stop the MD recorder and press the PGM key of the remote control unit to turn the indicator off.

**To stop playback**

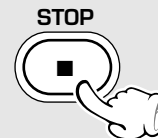

**Ejecting the disc**



- The minidisc comes out from the minidisc insertion slot.

**Disc recorded in monaural mode**

This unit is capable of playing a disc recorded in the monaural mode. As the amount of data required to record information in the monaural mode is half the amount required in the stereo mode, the play (record) time of a disc recorded in the monaural mode is twice (max. 160 minutes) that of a disc recorded in the stereo mode.

# Searching a desired track by its title (TITLE SEARCH)

When the titles of the tracks recorded on a minidisc for recording are entered in advance, search by title is possible for the tracks to be played. (Assigning a title to a disc or track → 35)

## 1 Select the "MD" input



## 2 Press the ■ key to enter stop mode.

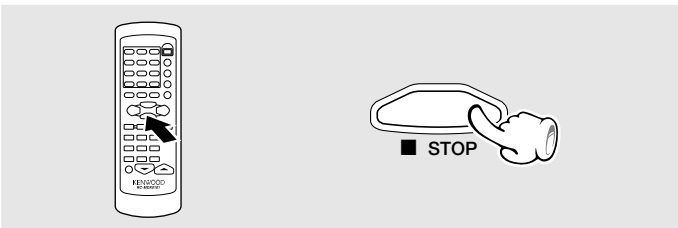

## 3 Press the TITLE SEARCH key



(To abort operation, press the TITLE SEARCH key again)

## 4 Select the desired track with the ◀◀ or ▶▶ key.

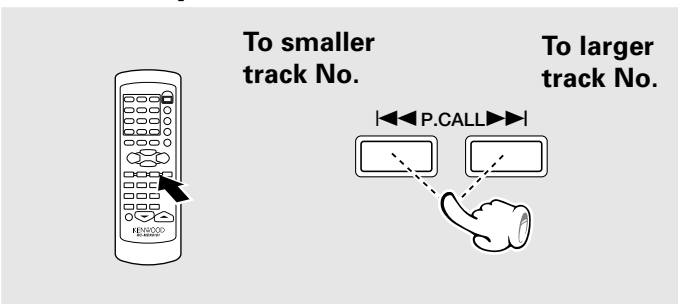

## 5 Start playback



- When the "PGM" indicator is lit, press the PGM key on the remote control unit to switch it off.

Goes off



Track title

- With a track to which no title has been assigned, the track number and "NO TITLE" are displayed.
- Track selection is possible with the ◀◀ or ▶▶ key of the main unit.

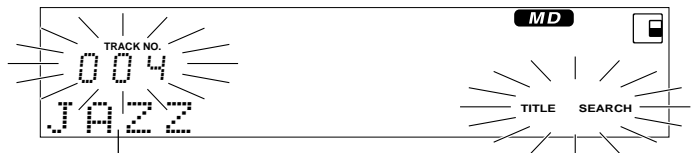

← Scrolled display

(successive movement of characters toward the left)

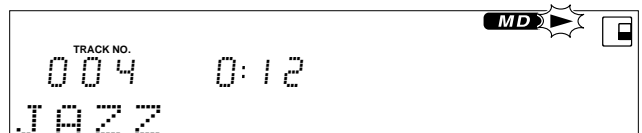

## Title display

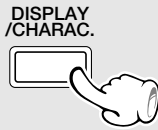

When a title recorded in a MD disc is too long to be displayed in the dot display, press this key to scroll the display and view the characters which has not be displayed.

This key is also used to switch the dot display modes (see figures below).

(When pressed during stop or playback)  
Each press switches the information.

① Title display

KENWOOD

② Title scroll display

NWOOD

(Return to ① after title scroll display.)

③ Pressing during title scroll display ② shows the available recording time of the MD.

001 R54:32

(The display returns to ① in 5 seconds.)

- When no track name (track title) and no disc name (disc title) has been recorded, "NO TITLE" is displayed.
- "BLANK DISC" is displayed when not even one track has been recorded. (When there is a disc title, the disc title will be displayed.)

(When pressed during MD recording)

Each press switches the information.

① Recording input display

CD

② Available recording time of MD

001 R54:32

# Listening in the desired sequence (program playback)

Use the following procedure to program desired tracks in a desired order. (up to 32 tracks)

Select the "MD" input. (Also press the  to enter stop mode.) → 18

## 1 Let the "PGM" indicator light.

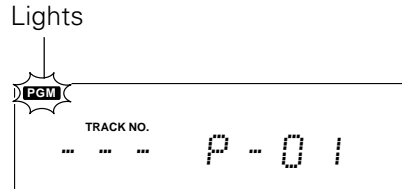

## 2 Select track numbers in the order you want to play them.

**1 Select the track.**

(Go to step 2 within 8 seconds.)

**2 Confirm the selection.**

(To select more than one track, repeat steps 1 and 2 for each track.)

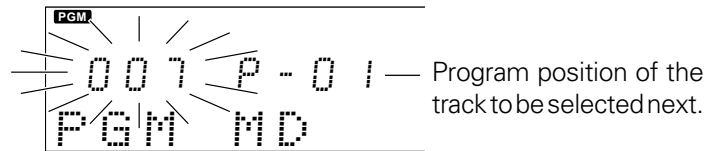

Press the numeric keys as shown below....

To select track No. 23 :   
 To select track No. 40 :

- Up to 32 tracks can be programmed. When "FULL" is displayed, no more tracks can be programmed.
- If you made a mistake, press the **CLEAR/DELETE** key and enter the track No. again.
- When a track No. is entered, the track will be added to the end of the existing program.
- "-- :--" is displayed when the total programmed period has attained 100 minutes or more.

## 3 Start playback.

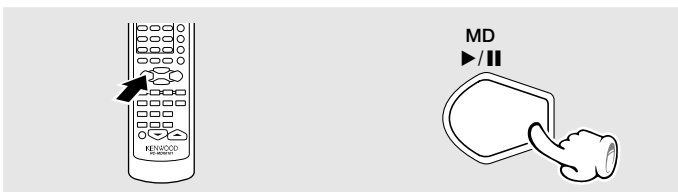

- Tracks will be played in the order they were programmed (following the program numbers).
- When the or the key is pressed during play, the program will jump to the preceding or the following track respectively.
- When the key is pressed once during playback, the play position returns to the beginning of the current track being played.

### To stop playback

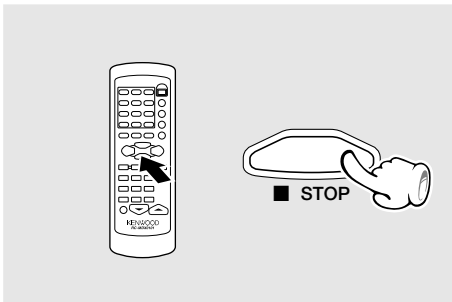

### To quit the program mode

**Clearing tracks from the end**

Press in stop mode

(Example when the track in P-02 is canceled)

- Each time the key is pressed, the last track in the program is cleared.

### Clearing all tracks

Goes off

- The entire program is cleared.

# Repeated playback

You can repeatedly listen to a favorite track or disc. (The REPEAT key is provided only on the main unit.)

Select the "MD" input. →  18

## Setup for repeating all tracks in a disc

❶ Confirm that the "PGM" indicator is not lit.

(If the "PGM" indicator is lit, press the PGM key to turn it off.)

Confirm that this is not lit.

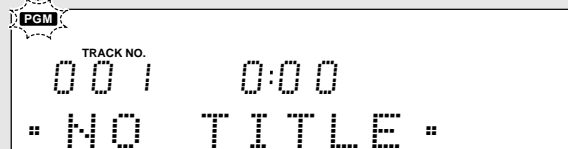

❷ Select "ALL REPEAT".

Each press switches the repeat mode.

REPEAT



① "ALL REPEAT"

Repeats playback of all tracks in a disc.

② Off.... Repeat deactivated

Lights



## Setup for repeating selected tracks

❶ Program the track sequence according to steps ❶ to ❷ of "Listening in the desired sequence". →  22

❷ Select "REPEAT".

Each press switches the repeat mode.

REPEAT



① "REPEAT"

All of the programmed tracks will be played repeatedly.

② Off.... Repeat deactivated

Lights Lights

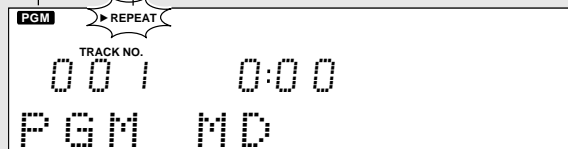

● The "REPEAT" and "PGM" indicators light up.

## Start playback

(Remote control unit)

(Main unit)

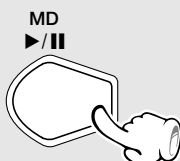
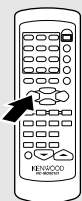

## To stop repeated playback

Press the REPEAT key repeatedly until the repeat mode is switched off.

● The "REPEAT" or "ALL REPEAT" indicator turns off and the repeat play mode is canceled.



If you load a tape in the cassette deck in advance while the power is off, pressing the TAPE key (◀, ▶) turns power on automatically and starts the tape playback.

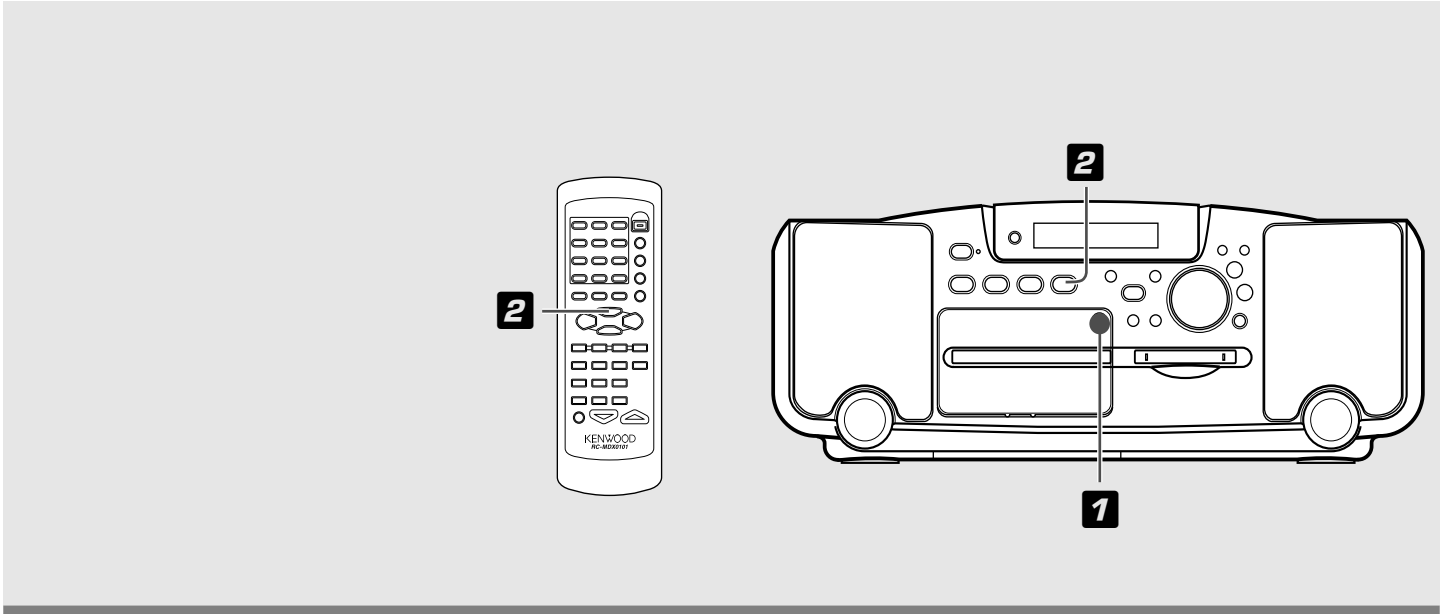

## 1 Load a cassette tape.

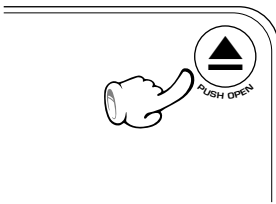

- 1 Open the door. Push the area marked ▲ PUSH OPEN.
- 2 Insert a tape and close the door.

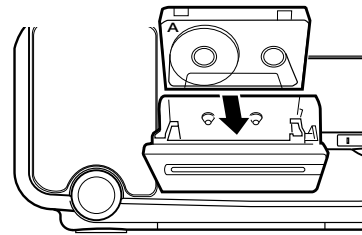

- Normal (TYPE I), high (TYPE II), or metal (TYPE IV) tape selection is set automatically.
- Remove tape slack before loading.
- Close the door securely.
- Do not use a tape which is longer than 100 minutes, for it easily causes troubles such as tape entanglement or cutting.



## 2 Start playback.

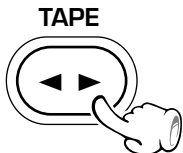

During playback, the tape running direction changes each time the key is pressed.

Displayed when the deck is loaded with a tape.

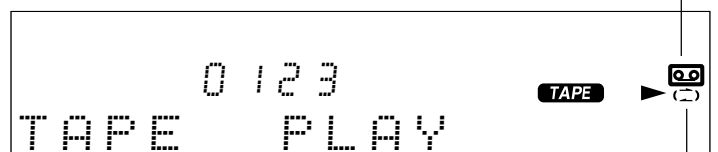

### Transport direction indicators

When playback or recording is started automatically by the one-touch operation function, etc., the tape is transported in the direction used the last time the tape was stopped. (To change the tape transport direction, press the TAPE key (◀, ▶) during playback then press the stop key (■).)

Reverse mode indication



**To wind tape at high speed**

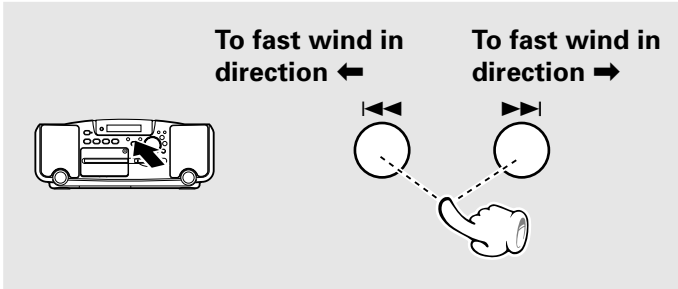

If you are operating the remote control unit, press the ◀◀ or ▶▶ key.

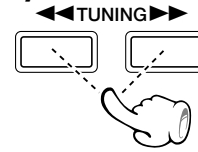

- Press the ■ key to stop fast winding.

**To stop playback**



- Do not take out the cassette tape until the tape transport has stopped completely.

**Selection of reverse mode (Main unit only)**

① Select "TAPE RVS?" from the menu.

Press the "SET/Demo" key while the "?" mark is blinking.

② Select.

"⇐": (REVERSE)  
 "⇨": (ONE-WAY)      "↻": (ENDLESS)

③ Set it.

**Tape counter display (Remote control unit only)**

Each press of the TIME DISPLAY key changes the displayed contents.



The tape counter is set to "0000" when a cassette tape is loaded.

By writing down the counter reading in case you want to interrupt recording (playback) in the middle of the tape, the memo will be helpful as a reference for locating the same position when continuing the recording (playback) the next time. The tape counter figure decrements during recording or playback of the back side (while the ◀ tape transport indicator is lit).

To set the tape counter to "0000", open the cassette holder once. Then the counter will be reset.

- "⇨" : (ONE-WAY)  
Only one side is played back (recorded), and then the tape stops.
- "⇐" : (REVERSE)  
Both sides are played back (recorded), and then the tape stops. (Initial setup)
- "↻" : (ENDLESS)  
Both sides are played back endlessly. (The tape stops after recording onto both sides.)  
The tape stops after recording onto both sides.

**Selection of TAPE EQ. (Remote control unit only)**

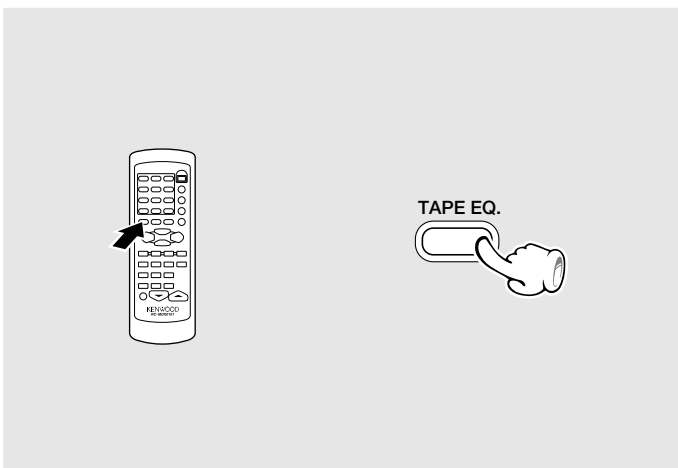

The TAPE EQ. system minimizes the hiss noise heard when playing tape. When playing a tape prerecorded with Dolby NR ON, be sure to set the TAPE EQ. ON for playback.

Lit when "TAPE EQ." is ON



Each press switches the modes as follows.

- ① "TAPE EQ." Light ..... TAPE EQ. is used.
- ② "TAPE EQ." Goes off ... TAPE EQ. is not used.

- Select the TAPE EQ. mode according to the recording condition of the tape.

It is also possible to receive them by one-touch operations by storing up to 40 stations in the preset memory.



When the "TUNER FM/AM" key is pressed, the unit will automatically be switched on and reception status will be reached.

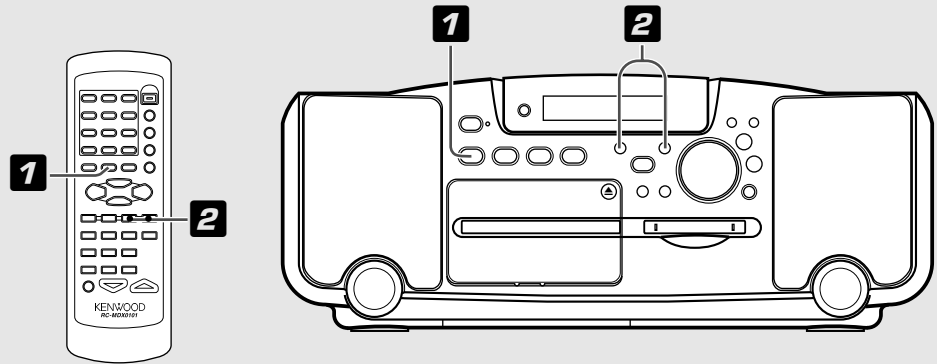

**1** Select the broadcasting band by pressing the TUNER FM/AM key.

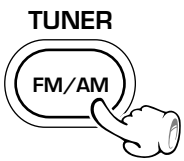

The first press of the key selects the tuner input. After this, each press switches the broadcasting bands alternately.

- ① FM
- ② AM

Reception band indication

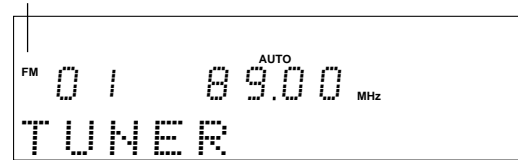

**2** Select the band. (The auto preset operation should be completed before this. → 27)

To receive a preset station (Preset call)

Main unit operation

Remote operation

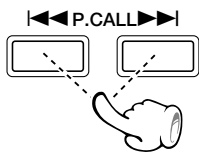
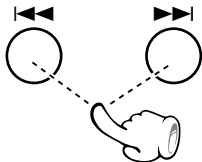

Every time the key (◀◀ or ▶▶) is pressed, the preset stations are switched over as follows.

- Press ▶▶ for the order of 1→2→3 ... 38→39→40→1...
- Press ◀◀ for the order of 40→39→38 ... 3→2→1→40...

- When a key is held depressed, preset stations will be skipped at an interval of about 0.5 second.

When no stations have been memorized

Select the tuning mode according to the current radio wave condition.

When the radio wave condition is good :

Auto tuning mode (Stereo reception)

When the radio wave condition is poor :

Manual tuning mode (Monaural reception)

① Select the auto or manual tuning mode.

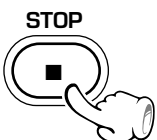

Each press alternates the mode.

- ① Auto tuning ..... "AUTO" lit (Normally, use the Auto tuning mode.)
- ② Manual tuning ... "AUTO" not lit

(Go to step ② within 5 seconds.)

② Tune in a station.

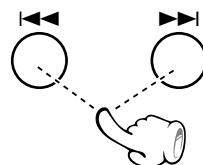

Auto tuning

: The next broadcasting station will be received automatically each time this key is pressed.

Manual tuning

: Press and hold until the desired station is received.

- Radio stations can also be tuned with the TUNING (◀◀, ▶▶) keys of the remote control unit.

The "TUNED" indicator lights when a station is received.

Lights at the time of automatic station selection.

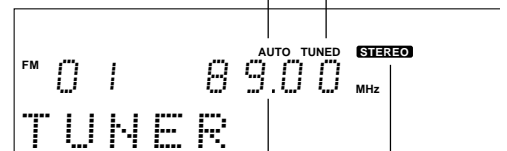

Frequency display

Lights during stereo reception

**Presetting radio stations automatically (auto preset)**

❶ Select the "TUNER" input.

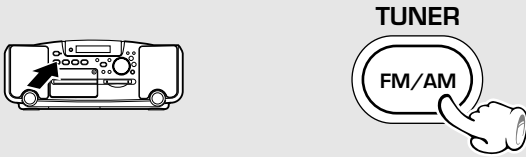

Turning the knob switches the function as shown in the display.

TAPE RVS.	?
REC MODE	?
<b>AUTO PRESET</b>	<b>(TUNER only)</b>
TIMER SET	?
A.P.S. SET	?

❷ Select "AUTO PRESET".

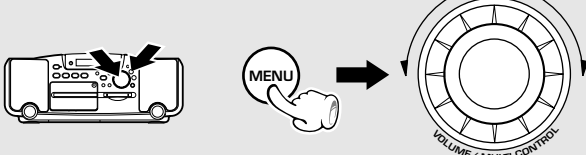

❸ Press the SET/Demo key.

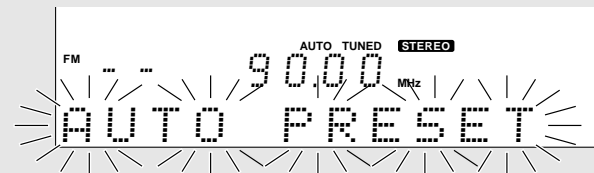

"AUTO PRESET" blinks in the display during the auto preset operation.

- Presetting begins with FM stations then proceeds to the AM stations.
- A maximum of 40 stations of the band presently being received will be preset.
- When there are many stations and the intended station has not been preset, please also use "One-by-one presetting (manual preset)".

**One-by-one presetting (manual preset) (Remote control unit only)**

❶ Press the ENTER key during reception.

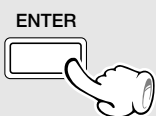

(Proceed to step ❷ while "MEMORY" is lit.)

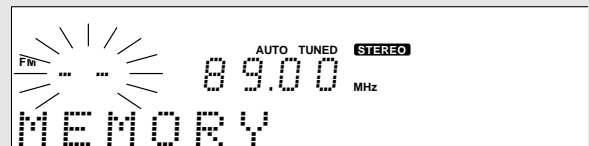

"MEMORY" lights (for approx. 5 sec.)

❷ Select a preset number with the ◀◀ or ▶▶ key.

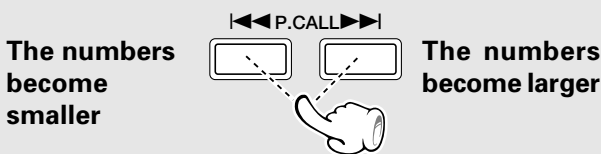

Preset numbers also can be selected with numeric keys.

Press the numeric keys as shown below....

To select track No. 13:

..... +10 3

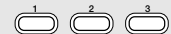

To select track No. 20:

..... +10 +10 0

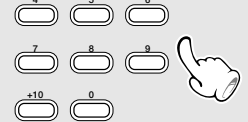

❸ Press the ENTER key again.

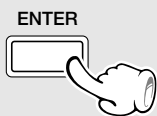

(Repeat steps ❶, ❷, ❸ to preset other stations)

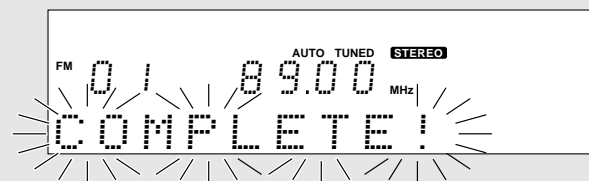

- If several stations are preset under the same number, the previous memory is replaced with the latest memory contents.

**Tuner frequency display (Remote control unit only)**

Each press of the TIME DISPLAY key changes the displayed contents.

①	FM 01	89.00 MHz	(Frequency display)
②	AM	8:45	(Time display)

**This unit cannot record audio in monaural mode.**

## Recording on MD

MD recording is possible as "digital recording", where the digital signal of the CD is used as it is, and as "analog recording", where the analog signal of a broadcast etc. is converted to a digital signal.

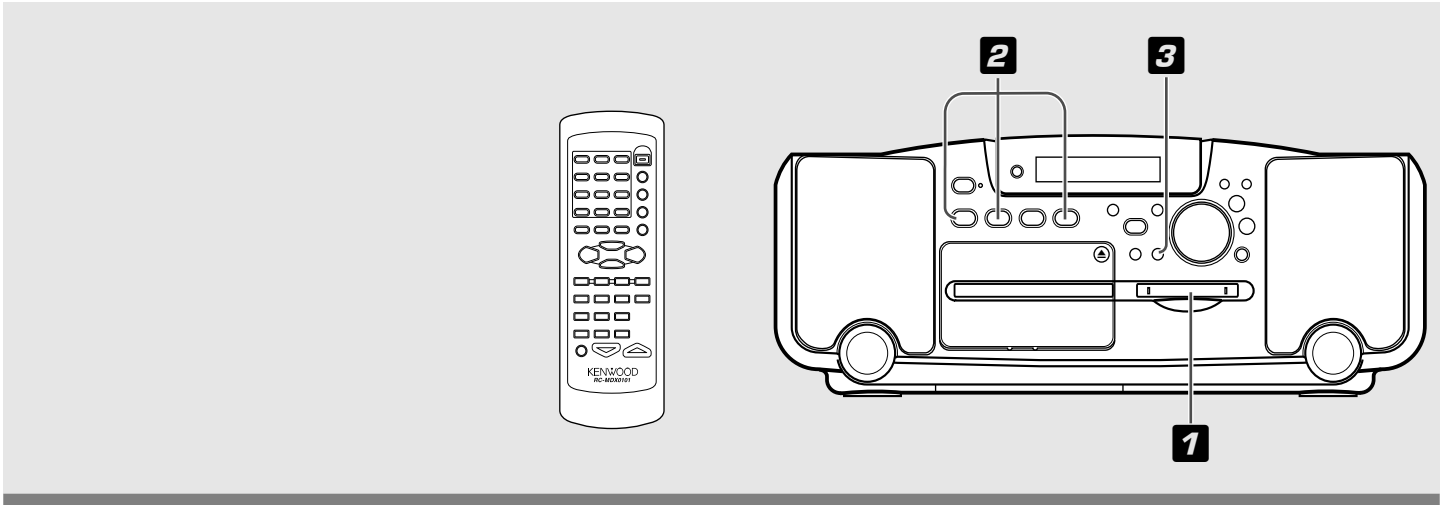

### 1 Make the preparations for recording.

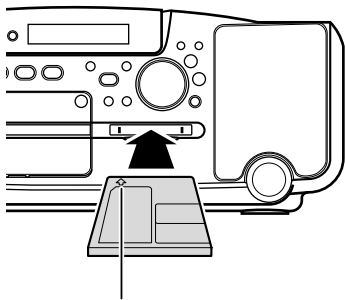

In the direction of the arrow

- ① Open the write protect tab of the Mini Disc to make it recordable. → 50
- ② Load the Mini Disc.

#### CAUTION

The MD cannot be loaded or ejected while the unit is in standby mode. Do not force insert a Mini Disc during the STANDBY mode, for this may damage the mechanism.

### 2 Select the source to be recorded.

Example:  
To select the CD input

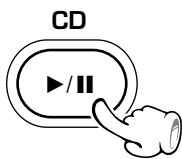

- TUNER (Broadcasts)**  
 : Analog recording  
**CD** : Digital recording  
**TAPE** : Analog recording



The character information display shows the recording input source.

- If a CD or tape has already been loaded, it starts to play now. Press the ■ key to stop it.

### 3 Start recording.



- ① Press the "MD REC" key (the unit enters record-pause mode).
- ② When the preparation is complete, press the "MD REC" key again.
- ③ Play (or tune) the music source to be recorded.

- For recording from a CD, read "One-touch recording".

- Do not apply vibrations or impact during recording.
- The recording onto TAPE is not available during recording onto MD.

### Pause the recording



- The track number is incremented by "1". Press the key again to resume recording.
- Recording can also be started by pressing the "MD REC" key.

### Stop the recording

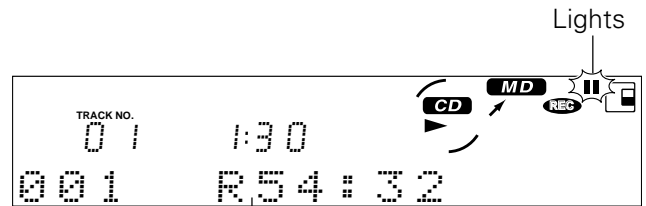

The recordable time for the MD is displayed.

The "WRITING" display indicates that the recorded and edited data are written in the MD. Be careful not to apply impact to the unit during it. If the power cord is unplugged before completion of "WRITING", the recorded and/or edited data may be lost.

### In regard to track numbers at the time of recording

When a part without sound continues for 2 sec. or more during recording, the track number is automatically increased by "1" when the next sound enters. When classic music continues with low sound, the track number may be increased by "1". (The track number is not increased during recording of the tape or tuner input.)

The erroneously set track number can be erased later. When it is desired to increase the track No. during recording, press the TRACK EDIT key during recording to record a track No. at that position.

The track numbers are used at the time of playback to find the start of tracks, for programming, etc.

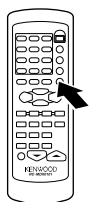

Press during recording.

TRACK EDIT



- With digital recording from a CD, the track number is increased when the track changes.



At the time of recording from a CD, the track number may be incremented when CD playback starts. This occurs because of a signal included in the digital signal from the CD. Delete unwanted track numbers under reference to "TRACK ERASE or ALL ERASE".

→ 42

### In regard to display messages

Recording is not possible when one of the following messages is displayed.

- |  |                             |
|--|-----------------------------|
| "DISC FULL" : The minidisc is full.              | → Erase unrequired tracks.  |
| "PROTECTED" : The write protect tab is open.     | → Close it.                 |
| "PLAY ONLY" : The minidisc is only for playback. | → Insert a recordable disc. |

→ 42

→ 50

# Recording on TAPE

This unit cannot record audio on High (Type I) and Metal (Type IV) cassette tapes.

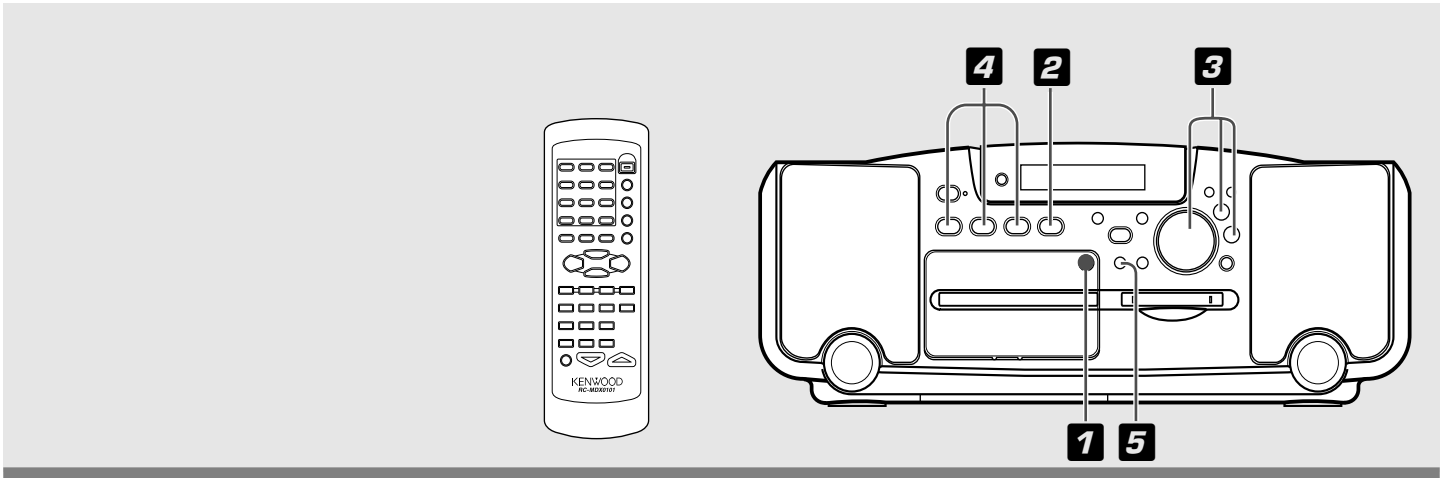

## 1 Load a tape in deck.

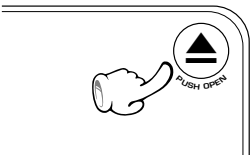

- 1 Open the door of deck.
- 2 Insert a tape.
- 3 Close the door.

- Remove tape slack before loading.

## 2 Select the tape transport direction.

To reverse the transport direction

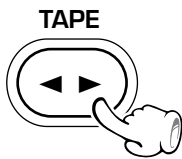

- 1 Press the play key.
- 2 Press the play key again.
- 3 Stop key (■) playback. (< or > lights.)

- When recording is started, the tape is transported in the direction selected in this step.
- Wind the tape to the position where recording is to be started.

## 3 Set the recording condition.

Select the reverse mode.



- 1 Select "TAPE RVS."

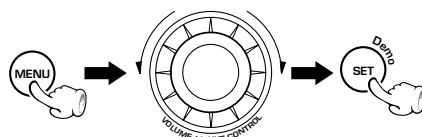

2

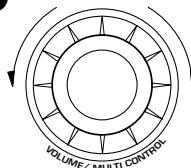

3

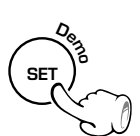

## 4 Select the source to be recorded.

Select an input source other than "TAPE"

CD



Example:  
To select the CD input

TUNER (Broadcasts)

CD  
MD



The character information display shows the recording input source.

- If a CD or MD has already been loaded, it starts to play now. Press the ■ key to stop it.

## 5 Start recording.



- 1 Press the TAPE REC key to start recording.
- 2 Play (or tune) the input source to be recorded.

- The recording level is adjusted automatically.
- Recording stops automatically when the tape side (s) to be recorded have been fully recorded.
- The recording onto MD is not available during recording onto TAPE.

### Pause the recording



- Press the **"TAPE REC"** key during recording. It stops after leaving a non-recorded blank of 4 seconds. (Press the key again to resume recording.)



### Stop the recording



- Do not take out the cassette tape until the tape transport has stopped completely.

### Points in CD recording

When recording CD tracks onto a tape, if you leave the cassette deck in record-pause mode beforehand, the cassette deck recording can be started at the CD starts to be played. (Synchro recording function)

- ① Put the CD player in pause mode.
- ② Select the track to be recorded with the skip (|◀◀, ▶▶|) keys. (The CD player pauses at the beginning of the selected track.)
- ③ Put the cassette deck in Record-pause mode. Press the TAPE REC key successively twice to enter record-pause mode.
- ④ Start playing the CD. (Synchro recording starts)

- Press the stop (■) key to stop recording.
- Synchronized recording from MD also is possible with the same procedure.

## One-touch recording (CD → MD / CD → TAPE)

The one-touch recording can record all tracks in a CD with a one-touch operation (all-track recording). It can also record the current CD track being played from the beginning (single-track recording). Simultaneous recording onto MD and TAPE is not available.

**Be sure to put the MD recorder and cassette deck in stop mode**

### 1 Make the preparations for recording.

#### CD → MD

- ① Insert a recordable disc into the MD recorder.
- ② Insert disc in the CD player.

#### CD → TAPE

- ① Perform steps ① to ③ of the procedure in "Recording on TAPE". → 30
- ② Insert disc in the CD player.

### 2 Check the current play mode of the CD player.

#### All-track recording

If it is in play mode, stop it.

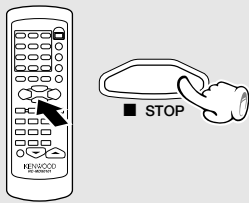

#### Single-track recording

Select the desired CD track and play it.

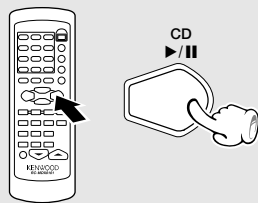

#### All-track recording

If it is in play mode, stop it.

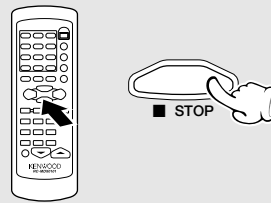

#### Single-track recording

Select the desired CD track and play it.

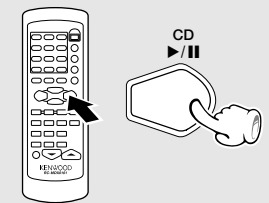

- To record other tracks using "one-touch recording (single-track recording)", repeat steps ② and ③ for each track.
- During CD random playback, one touch recording will not operate.

### 3 Start recording.

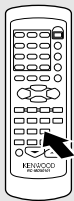

MD O.T.E.

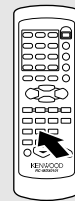

TAPE O.T.E.



- When starting recording from the remote control unit, make sure not to mistake the **MD O.T.E.** key and **TAPE O.T.E.** key.
- When the **MD O.T.E.** or **TAPE O.T.E.** key is pressed for "One-touch recording (single-track recording)", the CD track being played is replayed from the beginning and recording start at the same time.
- Similar recording is also possible from the main unit by selecting "REC MODE" after pressing the **MENU** key.

### To interrupt a recording

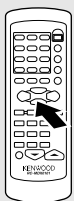

(Recording and playback will be stopped.)

### At the end of the recording

- CD player** : After one-touch all-track recording → Stop.  
After one-touch single-track recording → Pause.
- MD recorder** : Stop is executed and "WRITING" is displayed.
- Cassette deck** : Stop is executed after an unrecorded portion of about 4 sec. has been produced.

The "WRITING" display indicates that the recorded and edited data are written in the MD. Be careful not to apply impact to the unit during it. If the power cord is unplugged before completion of "WRITING", the recorded and/or edited data may be lost.



# Program recording (CD → MD / CD → TAPE)

Desired CD tracks can be programmed in the desired sequence and recorded onto an MD or tape. Simultaneous recording onto MD and TAPE is not available.

**Recording preparation is required.** → 28 → 30  
(Be sure to put the MD recorder and cassette deck in stop mode.)

## 1 Program the desired sequence of CD tracks.

### CD → MD

Perform steps 1 and 2 of the procedure in "Listening in the desired sequence (Program playback)". → 15

### CD → TAPE

Perform steps 1 and 2 of the procedure in "Listening in the desired sequence (Program playback)". → 15

- When the **PGM** key is pressed to cancel the edited contents, the entire editing contents will be erased.
- Tracks programmed beyond the available MD or tape recording time will be interrupted in the middle.

## 2 Start recording.

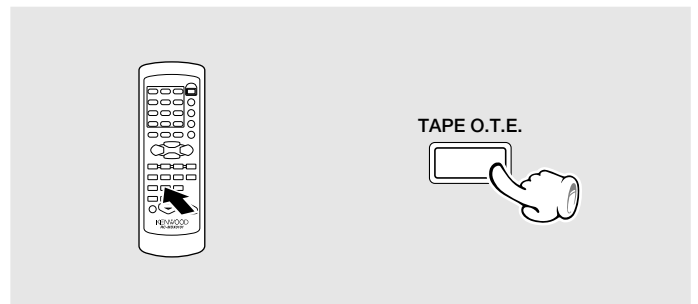
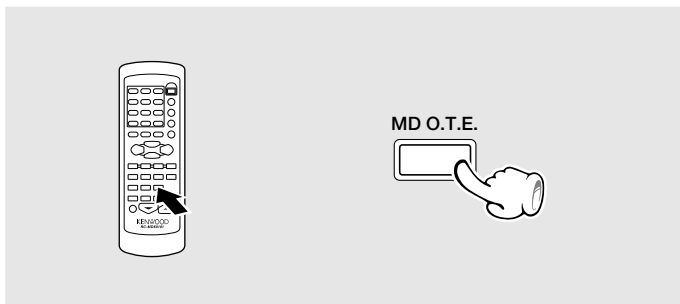

- Recording of the programmed tracks in the programmed order starts.
- When starting recording from the remote control unit, make sure not to mistake the **MD O.T.E.** key and **TAPE O.T.E.** key.
- Similar recording is also possible from the main unit by selecting "**REC MODE**" after pressing the **MENU** key.

### To interrupt a recording

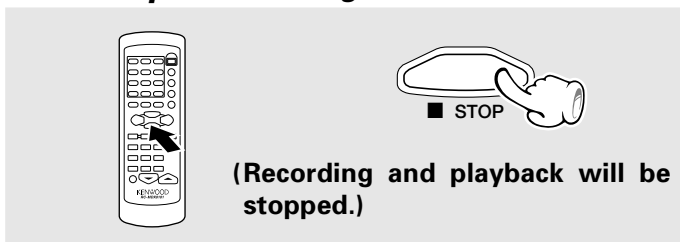

**At the end of the recording**

CD player	: Stop.
MD recorder	: Stop is executed and "WRITING" is displayed.
Cassette deck	: Stop is executed after an unrecorded portion of about 4 sec. has been produced.

The "WRITING" display indicates that the recorded and edited data are written in the MD. Be careful not to apply impact to the unit during it. If the power cord is unplugged before completion of "WRITING", the recorded and/or edited data may be lost.

## Program recording (MD → TAPE)

Desired MD tracks can be programmed in the desired sequence and recorded onto a tape.

**Recording preparation is required.** →  (Be sure to put the cassette deck in stop mode.)

### 1 Program the desired sequence of MD tracks.

Perform steps 1 and 2 of the procedure in "Listening in the desired sequence (Program playback)". → 

- When the **PGM** key is pressed to cancel the edited contents, the entire editing contents will be erased.
- Tracks programmed in excess of the tape recording time will be cut off.

### 2 Press the TAPE REC key twice to enter record-pause mode.

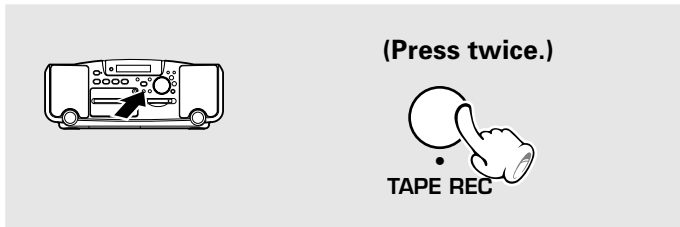

### 3 Press the MD ▶/|| key again. (Start recording.)

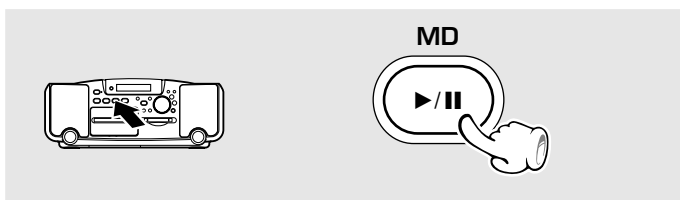

- Starting the MD program playback starts tape recording by synchro recording.

### To interrupt a recording

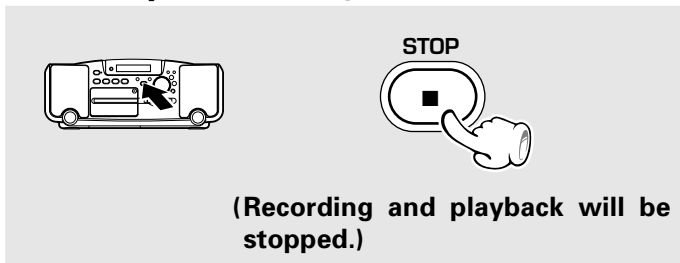

### At the end of the recording

- MD recorder : Stop.
- Cassette deck : Stop is executed after an unrecorded portion of about 4 sec. has been produced.

Operation

# MD Edit Functions

## Assigning a title to a disc or track

When titles are assigned to a disc and its tracks, the titles can not only be displayed during playback but title search (searching a track by the title) is also made possible. The assigned titles can be changed or deleted with the same procedure.

The MD operates on the basis of the information read from the disk into memory. After title input or editing, be sure to eject the minidisc so that the data is written in it by "WRITING".

Select the "MD" input. (Execute operation in stopped condition or during playback.) → 18

### 1 Activate the title input mode.

① Press the TITLE INPUT key.

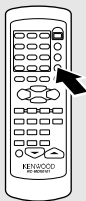

TITLE INPUT



② Select whether the disc title or track title input. (when it is required to title a track).

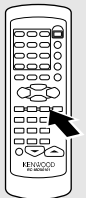

To return

To advance

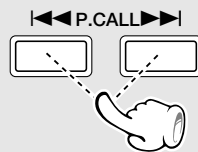

③ Press the SET key.

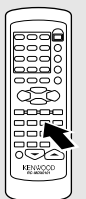

SET



To abort operation, press the TITLE INPUT key again.

Disc titles can be assigned in stop mode. When the MD ►/II key pressed before step ①-③ while assigning a title to a track, the title can be entered while listening to that track.



- It takes a while because data should be read out of the disc.

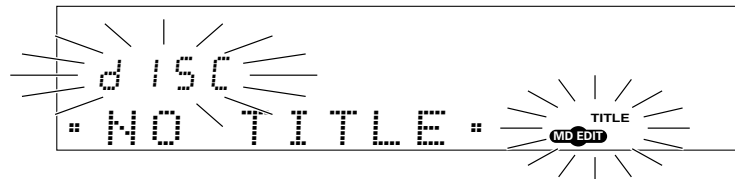

#### In case of disc title

Select "dISC".



#### In case of track title

Select the desired track No.

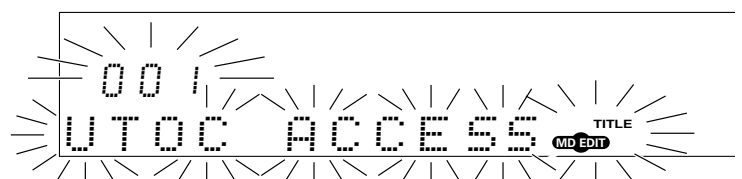

### Total number of title characters

Up to 1792 characters can be input per disc and up to 80 characters can be input per track. A space (blank character) also require the same amount of data as alphanumeric characters. When deleting a title, it is not recommended to overwrite spaces on previous characters but use the CLEAR/DELETE function.

→ 37

Continued on next page →

**2** Input the title.

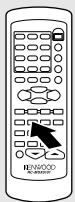

① Select the group of the characters used in the title.

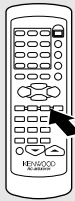
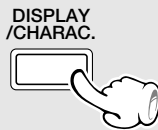

② Select a desired character by placing the selection cursor on it.



③ Press the SET key to enter the selected character.

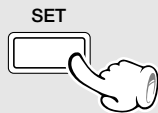

(Input the title characters by repeating ① to ③ for each of them.)

The following types of characters, numbers, and symbols can be selected. Press the DISPLAY/CHARAC. key as often as required to display the desired group of characters.

- A~Z, space (1 blank character)
- a~z, space
- 0~9, symbols, space

● By pressing the ◀◀ or ▶▶ key, the displayed characters are scrolled so any character (in the same group) can be selected.

List of registered symbols (ASCII codes):  
! " # \$ % & ' ( ) \* + , - . / : ; < = > ? @ [ \ ] ^ \_ ` { | } ~ space - ^

Example of disc title

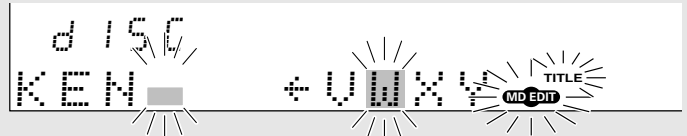

The cursor moves and waits for input of the next character.

**3** Execute title assignment.



① Press the ENTER key.

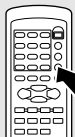
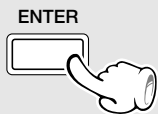

② Press the TITLE INPUT key.

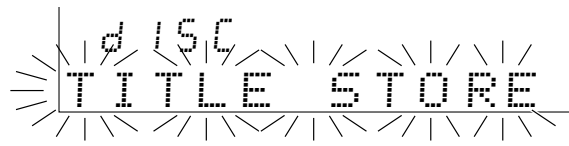
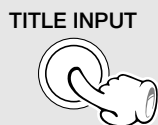

← The title scrolls.

**4** After editing, eject and remove the mini disc.

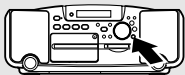

The MD operates on the basis of the information read from the disk into memory. After title input or editing, be sure to eject the minidisc so that the data is written in it by "WRITING".

The "WRITING" display indicates that the recorded and edited data are written in the MD. Be careful not to apply impact to the unit during it. If the power cord is unplugged before completion of "WRITING", the recorded and/or edited data may be lost.

# Changing or deleting a title

The MD operates on the basis of the information read from the disk into memory. After title input or editing, be sure to eject the minidisc so that the data is written in it by "WRITING".

The "WRITING" display indicates that the recorded and edited data are written in the MD. Be careful not to apply impact to the unit during it. If the power cord is unplugged before completion of "WRITING", the recorded and/or edited data may be lost.

Select the "MD" input. (Please execute operation in stopped condition.) → 18

**1** Perform step 1 of "Assigning a title to a disc or track".

→ 35

**2** Change or delete characters one by one.

- Move the cursor to the desired character (the character to be changed).
- Select the character group.
- Select overwrite or insert mode.
- Select the correct character.
- Press the SET key to enter the selected character.

(All characters of a title can be changed by repeating steps 1 to 5.)

The input cursor can be moved with the ◀, ▶ keys.

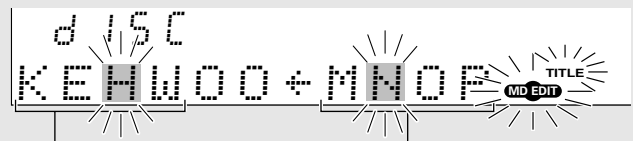

Cursor movement area      Character group

Each press of the TITLE SEARCH key switches the operation.

- ① **Overwrite mode** : To replace characters  
(The cursor "■" becomes large.)
- ② **Insert mode** : To insert characters before the cursor  
(The cursor "■" becomes small.)

- If the title to be changed is too long to be displayed on the display section, press the ◀, ▶ key to scroll the display so that the characters hidden until then appear.

## To clear (delete) a character

- Move the cursor under the character to be cleared.
- Clear (delete) the character.



- The character in the cursor position is cleared (deleted) and the character after it shifts by one column toward the left. Pressing the key successively (or holding it depressed) allows all the title characters to be cleared quickly.

**3** Execute title change or deletion.

- Press the ENTER key.
- Press the TITLE INPUT key.

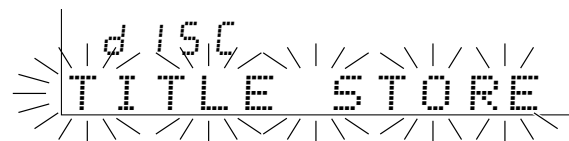

← The title scrolls.

After editing, be sure to eject the minidisc so that the data is written in it by "WRITING".

# Moving several tracks at a time (QUICK MOVE)

The tracks can be reordered in the desired order by moving up to 20 tracks at a time.

Image of simultaneous, multiple track movement

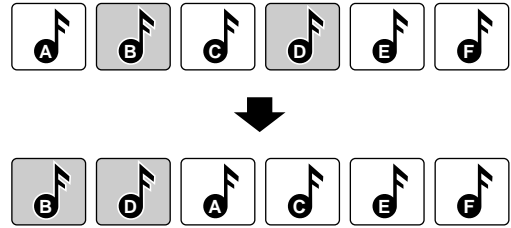

Select the "MD" input. (Please execute operation in stopped condition.) → 18  
Perform the operations in the following procedure while the display is blinking.

**1** Press the QUICK MOVE key then the SET key.

To abort operation, press the QUICK MOVE key again.

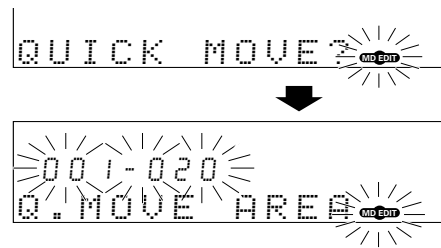
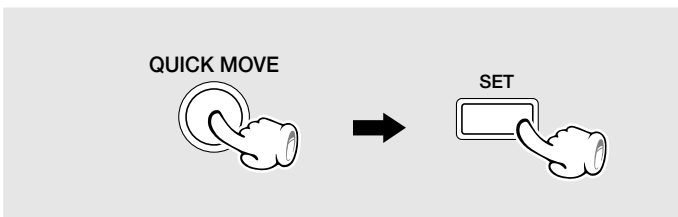

**2** Select the first track number of the movement target range.

Select the first track number of the track movement target range and press the SET key.

Selected track No. 20 tracks (movement range) First track No. of movement target range.

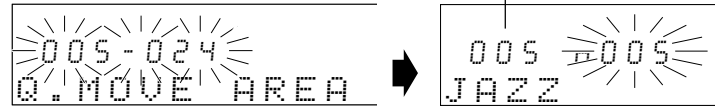
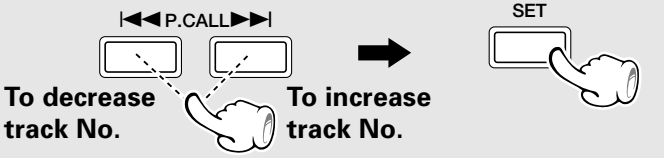

**3** Select tracks numbers in the desired order.

Select the movement destination track number and press the SET key.

(Example)

To move track No. 7 to track No. 5 (the first track position in the movement target range).

Target track No.

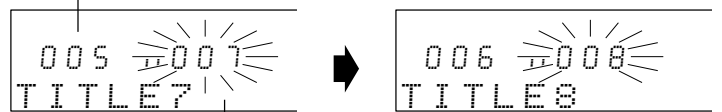
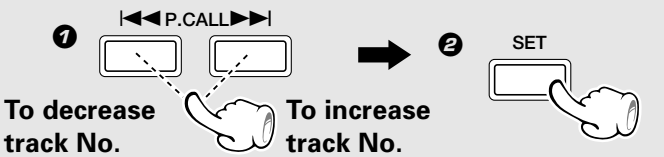

(Repeat steps 1 and 2 until all tracks have been arranged in the desired order.)

Moved track No.

- The display shifts toward the right every time a track number is set.
- Pressing the ◀▶ key allows to check the current order of tracks.

**4** Enter the track movement.

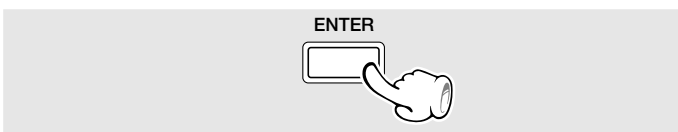

COMPLETE !

- It takes a while until the execution completes.

**5** After editing, eject and remove the mini disc.

With the MD, information is written in the disc when the ejection operation is performed after editing. After title input or editing, be sure to eject the minidisc so that the data is written in it by "WRITING".

The "WRITING" display indicates that the recorded and edited data are written in the MD. Be careful not to apply impact to the unit during it. If the power cord is unplugged before completion of "WRITING", the recorded and/or edited data may be lost.

# Moving a single track (TRACK MOVE)

This procedure shows you how to select and move (insert) a track to the track number you desire. The surrounding tracks are renumbered automatically.

Repeating this procedure lets you arrange the tracks in the order you desire.

Image of moving one track

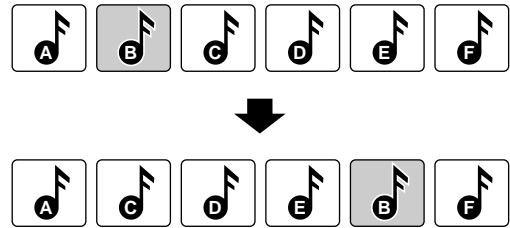

Select the "MD" input. (Please execute operation in stopped condition.) → 18

Perform the operations in the following procedure while the display is blinking.

## 1 Select "MOVE?".

1 Press the TRACK EDIT key.



2 Press the SET key.

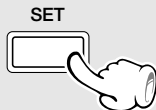

To abort operation, press the TRACK EDIT key again.

Each press switches the operation.

- 1 MOVE ?
- 2 COMBINE ?
- 3 ALL ERASE ?
- 4 (Editing cancelled)

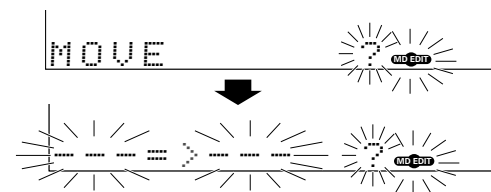

## 2 Select the track to be moved.

Select the movement destination track number and press the SET key.

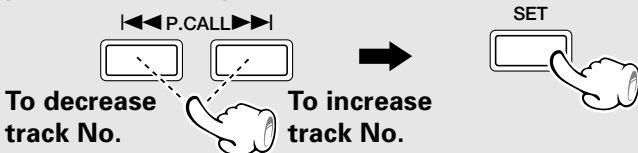

## 3 Select the moving destination track.

Select the movement destination track number and press the SET key.



## 4 Enter the track movement.



## 5 After editing, eject and remove the mini disc.

With the MD, information is written in the disc when the ejection operation is performed after editing. After title input or editing, be sure to eject the minidisc so that the data is written in it by "WRITING".

● It takes a while until the execution completes.

The "WRITING" display indicates that the recorded and edited data are written in the MD. Be careful not to apply impact to the unit during it. If the power cord is unplugged before completion of "WRITING", the recorded and/or edited data may be lost.

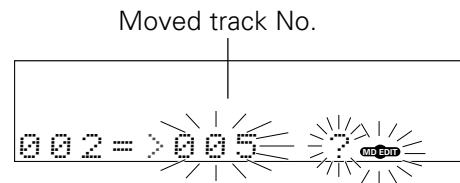
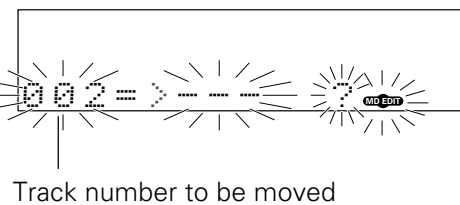

## Dividing a track (TRACK DIVIDE)

Use the following procedure to divide a track into two by inserting a track number in its middle. Note that the track numbers of the tracks located after the divided track are automatically incremented.

Image of track division

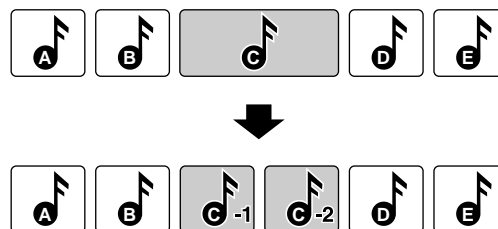

Select the "MD" input. (Perform the operations in the following procedure while the display is blinking.) → 18

### 1 Play the track to be divided.

- This operation is also possible during pause.

### 2 Press the TRACK EDIT key at the desired position.

To abort operation, press the TRACK EDIT key again.

- 1 Press the TRACK EDIT key and select "DIVIDE?".



- 2 Press the SET key.

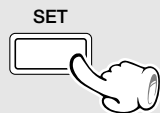

Each press switches the operation.

- 1 DIVIDE ?
- 2 COMBINE ?
- 3 ERASE ?
- 4 (Editing cancelled)

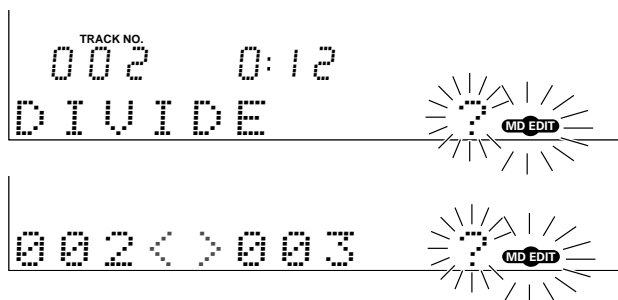

### 3 Enter the track division.

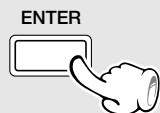

### 4 After editing, eject and remove the mini disc.

With the MD, information is written in the disc when the ejection operation is performed after editing. After title input or editing, be sure to eject the minidisc so that the data is written in it by "WRITING".

The "WRITING" display indicates that the recorded and edited data are written in the MD. Be careful not to apply impact to the unit during it. If the power cord is unplugged before completion of "WRITING", the recorded and/or edited data may be lost.



# Combining two tracks (TRACK COMBINE)

Use the following procedure to combine two tracks into one by deleting a track number. After this operation, the track numbers of tracks located after the combined tracks are decreased automatically.

Image of track combining

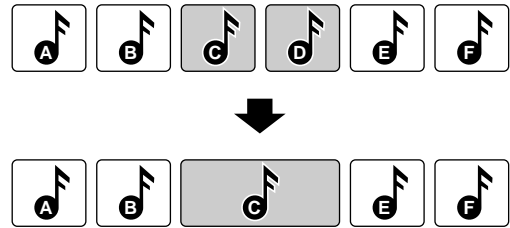

Select the "MD" input. (Perform the operations in the following procedure while the display is blinking.) → 18

## 1 Select "COMBINE ?".

To abort operation, press the TRACK EDIT key again.

"COMBINE ?" cannot be selected if the track being played is the first track of the disc.

① Press the TRACK EDIT key and select "COMBINE?".



When pressed in stop mode

Each press switches the operation.

- ① MOVE ?
- ② COMBINE ?
- ③ ALL ERASE ?
- ④ (Editing cancelled)



② Press the SET key.

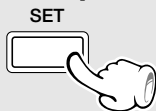

When pressed in play mode

- ① DIVIDE ?
- ② COMBINE ?
- ③ ERASE ?
- ④ (Editing cancelled)



If you combine tracks during playback, go to step ③.

- To combine two tracks during playback, press the TRACK EDIT key while the second track is being played.

## 2 Select the track to be combined.

Select the movement destination track number and press the SET key.

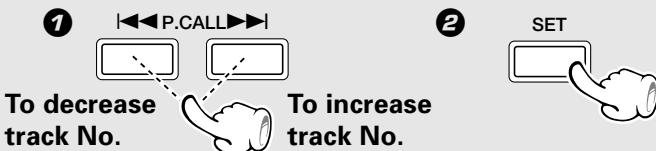

- The track which will be the first half of the track after combination should be longer than 2 seconds.
- The combined track will be given the track number and title of the track which has become the first half after combination. The track numbers of subsequent tracks are corrected automatically.

## 3 Enter the track combination.

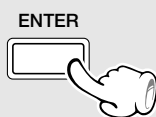

COMPLETE !

## 4 After editing, eject and remove the mini disc.

With the MD, information is written in the disc when the ejection operation is performed after editing. After title input or editing, be sure to eject the minidisc so that the data is written in it by "WRITING".

The "WRITING" display indicates that the recorded and edited data are written in the MD. Be careful not to apply impact to the unit during it. If the power cord is unplugged before completion of "WRITING", the recorded and/or edited data may be lost.

# Erasing a single track (TRACK ERASE) or erasing all tracks on a disc (ALL ERASE)

## TRACK ERASE

During playback, it is possible to erase only the track being played. The track numbers of the tracks after the erased track will be adjusted. Be careful in using this operation because a track cannot be recovered once it has been erased.

## ALL ERASE

During stop, all tracks can be erased. Be careful in using this operation because the tracks cannot be recovered once the entire minidisc has been erased.

Select the "MD" input. (Perform the operations in the following procedure while the display is blinking.) → 

### 1 Make the preparations.

#### To erase one track (TRACK ERASE)

① Start playback.

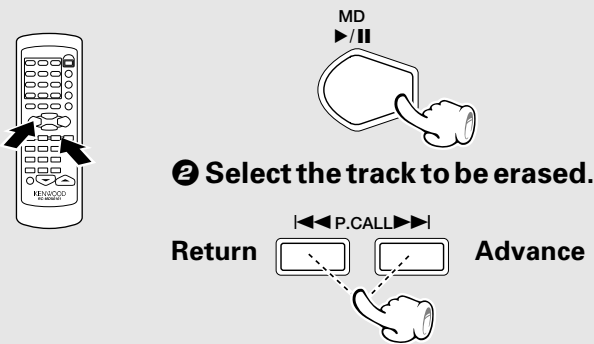

② Select the track to be erased.

#### To erase all tracks (ALL ERASE)

(Enter stop status)

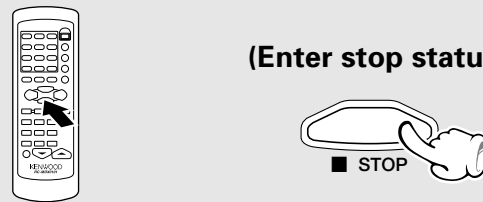

To abort operation, press the TRACK EDIT key again.

### 2 Press the TRACK EDIT key repeatedly.

Select "ERASE ?".

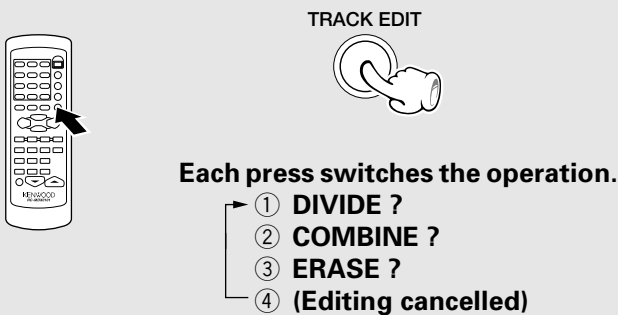

Each press switches the operation.

① Select "ALL ERASE ?".

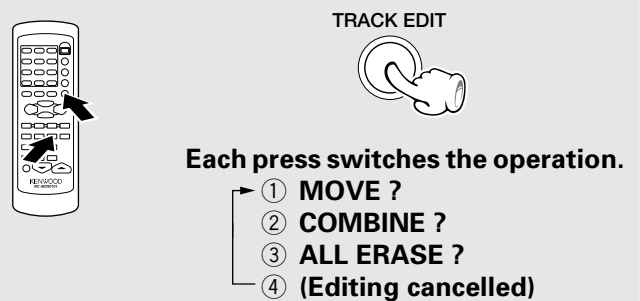

Each press switches the operation.

② Press the SET key.

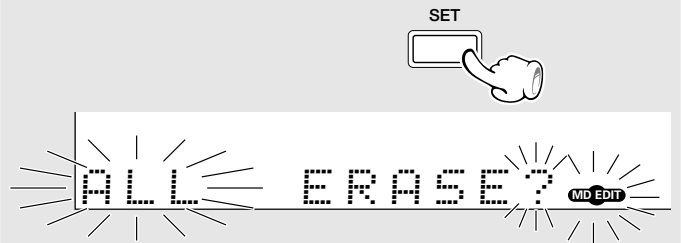

Continued on next page →

**3** *Execute the erase operation.*

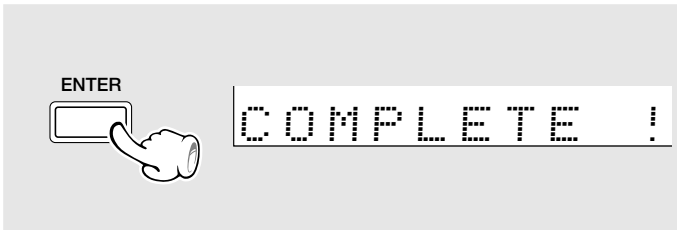

- The track is erased (together with the track title).

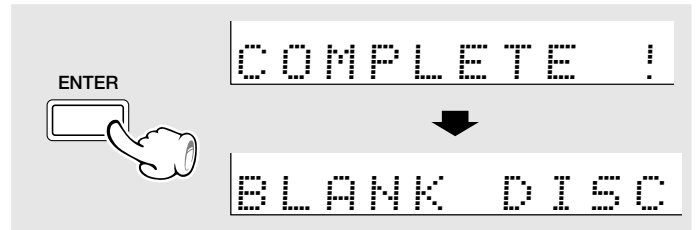

- All tracks on a disc are erased (together with the disc title).

**4** *After editing, eject and remove the mini disc.*

With the MD, information is written in the disc when the ejection operation is performed after editing. After title input or editing, be sure to eject the minidisc so that the data is written in it by "WRITING".

The "WRITING" display indicates that the recorded and edited data are written in the MD. Be careful not to apply impact to the unit during it. If the power cord is unplugged before completion of "WRITING", the recorded and/or edited data may be lost.

## Wake-up timer(O.T.T.)

Playback of the selected input source starts at the specified time, and the unit is switched off after one hour. This timer operates only once directly after setting.

## Timer playback, timer recording (PROG.1, PROG.2)

With each of the two timer programs, a selected source can be played (or radio broadcast can be recorded) in the previously set time period.

## AI timer playback (PROG.1, PROG.2)

The volume increases gradually after start of timer playback.

## Sleep timer (SLEEP)

The unit is turned OFF automatically after the specified period has elapsed.

# Setting the O.T.T. timer

Timer playback is possible simply by setting the time.

The source selected last before the unit was switched off will be played. One hour after start of timer playback, the unit will be switched off automatically.

❶ Select the source to be played.

❷ Select "TIMER SET ?" .

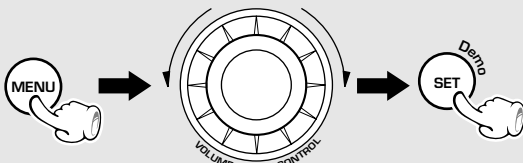

(Press the "SET/Demo" key while the "?" mark is blinking.)

❸ Select "O.T.T. SET ?" .

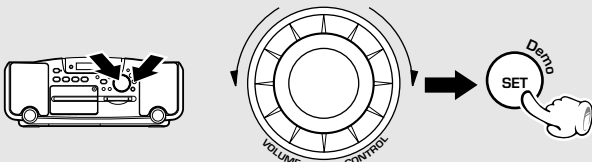

❹ Set the ON time.

The time is returned.      The time is advanced.

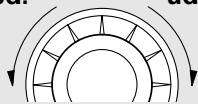

❺ Press the SET/Demo key.

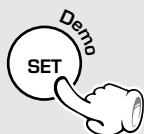

❻ Execute the O.T.T. operation.

Perform steps ❶ and ❸ in the procedure in "Execution and cancellation of timer".



Turning the knob switches the function as shown in the display.

▶ TAPE RVS.	?
▶ REC MODE	?
▶ AUTO PRESET	(TUNER only)
▶ <b>TIMER SET</b>	<b>?</b>
▶ A.P.S. SET	?

Turning the knob switches the function as shown in the display.

①	<b>O.T.T. SET</b>	<b>?</b>
②	PROG. 1 SET	?
③	PROG. 2 SET	?

● The ON time can be set in steps of 5 minutes.

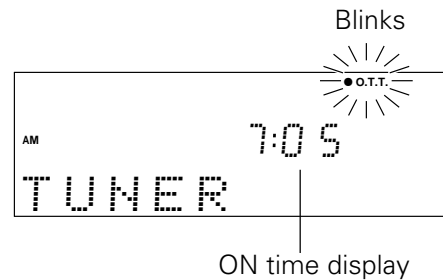

● When the O.T.T. has been set by pressing the "SET/Demo" key, the display shows "COMPLETE !".

# Setting the Program Timer

Two 24-hour timer systems (PROG.1, PROG.2) (which can be used every day) are available. With PROG 1 and PROG 2, two sets of time zones and operation contents can be programmed and executed as required.

## 1 Make preparations for the play (recording).

**To listen to CD**  
 Insert a disc.  
 (Program playback is not possible.)

**To listen to MD**  
 Load a disc.  
 (Program playback is not possible.)

**To listen to tape**  
 Set a tape into.

**To listen to radio**  
 The station should be preset prior to the above. → 27

**For recording**  
 Make preparations for recording.  
 MD → 28  
 TAPE → 30

- Timer reservation is possible for the two types PROG.1 and PROG. 2 at the same time.
- Please make reservations with an interval of at least one minute, so that the operation times of PROG. 1 and PROG. 2 do not overlap.

## 2 Select a program No.

**1 Select "TIMER SET ?".**

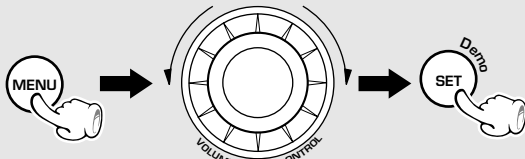

(Press the "SET/Demo" key while the "?" mark is blinking.)

**2 Select "PROG. 1 SET ?" or "PROG. 2 SET ?".**

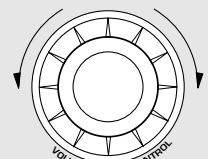

**3 Press the SET/Demo key.**

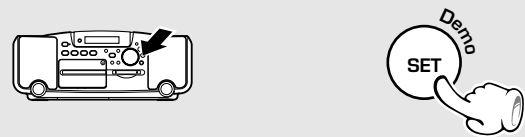

(Press during display of the program contents.)

Turning the knob switches the function as shown in the display.

TAPE RVS.	?
REC MODE	?
AUTO PRESET	(TUNER only)
<b>TIMER SET</b>	<b>?</b>
A.P.S. SET	?

Turning the knob switches the function as shown in the display.

① O.T.T. SET	?
<b>② PROG. 1 SET</b>	<b>?</b>
<b>③ PROG. 2 SET</b>	<b>?</b>

- The selected program No. lights.

Continued on next page →

**3** Set the ON time then the OFF time.

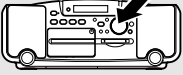

**1** Adjust the time.  
The time is returned. The time is advanced.

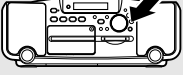

**2** Press the SET/Demo key.

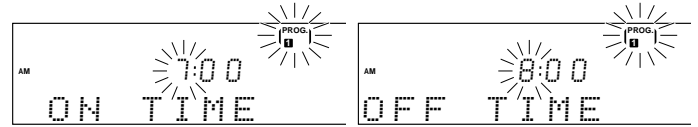
- For each of the ON time and OFF time, enter the figure of "hour" by performing steps 1 and 2 then enter the figure of "minute" in the same manner.
- If you make a mistake, restart from step 2.

**4** Make the desired reservation.



*For timer playback or AI timer playback*

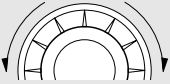

**1** Select the mode.  
(1) Select "PLAY" or "AI PLAY".  
(2) Press the SET/Demo key.

**2** Select the input source.  
(1) Select the source to be played.  
(2) Press the SET/Demo key.

**3** Select the broadcast station (only when TUNER is selected above).  
(1) Select the preset station No.  
(2) Press the SET/Demo key.



**4** Execute the program timer operation.  
Perform steps 1 and 3 in the procedure in "Execution and cancellation of timer". → 47

① **PLAY** ..... Timer play

② **TUNER REC**

③ **AI PLAY** ..... Timer play with gradually increasing volume

① **TUNER** ..... Broadcasts

② **CD**

③ **MD**

④ **TAPE**

- When the "SET/Demo" key is pressed, the display shows "COMPLETE !".

*For timer recording*



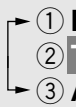

**1** Select the mode.  
(1) Select "TUNER REC".





- ① **PLAY**
- ② **TUNER REC**
- ③ **AI PLAY**

(2) Press the SET/Demo key.

**2** Select the broadcast station  
(1) Select the preset station No.  
(2) Press the SET/Demo key.





**3** Select the record destination.  
(1) Select.

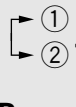

- ① **MD REC**
- ② **TAPE REC**

(2) Press the SET/Demo key.  
• When the "SET/Demo" key is pressed, the display shows "COMPLETE !".



**4** Execute the program timer operation.  
Perform steps 1 and 3 in the procedure in "Execution and cancellation of timer". → 47

# Execution and cancellation of timer

## 1 Select the timer program No. to be used. (Remote control unit only)

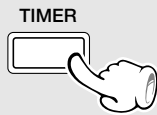
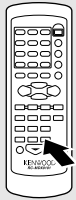

Each press of the key switches the program numbers as follows.

- ① O.T.T..... Executes O.T.T. only.
- ② PROG.1 ..... Execution of program 1 only.
- ③ PROG.2 ..... Execution of program 2 only.
- ④ PROG.1, 2.. Execution of programs 1 and 2.
- ⑤ Off ..... Timer off.

- The selected program No. lights.
- The timer will not function unless a program No. is selected.

## 2 Adjust the listening volume.

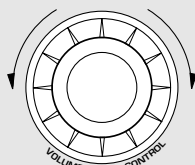
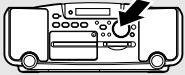

- If **AI PLAY** is selected, the volume is adjusted automatically.
- With timer recording, when the timer turns power on, the muting function is automatically switched on.

## 3 Enter STANDBY mode of power (by pressing the POWER key to off).

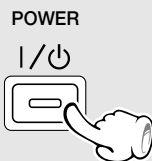
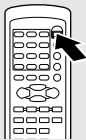

When the timer is activated and power enters the STANDBY mode, the STANDBY/TIMER indicator lights up in green.

- The **STANDBY/TIMER** indicator blinks in green if there is a power failure or the power cord is unplugged from the power outlet in the period when the power is in STANDBY mode after timer execution, or if the timer setting contents are inconsistent. In such a case, restart from setting the current time of the day and timer. → 9

### When timer operation is not required

Press so that all PROG. indicators are OFF.

Press while power is ON.

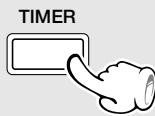

### Indication with O.T.T. timer



- The reservation contents are held in memory.

- To check or modify the reservation contents, restart the timer reservation from the beginning.

## Sleep timer (SLEEP)

Set the number of minutes after which the unit is to be turned OFF.

Set the time.

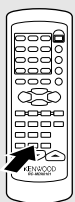

- The unit is turned OFF automatically after the set time has elapsed.
- Each press increases the timer period by 10 minutes. The sleep timer can be set up to 90 minutes.

10→20→30...70→80→90→Cancel→10→20...

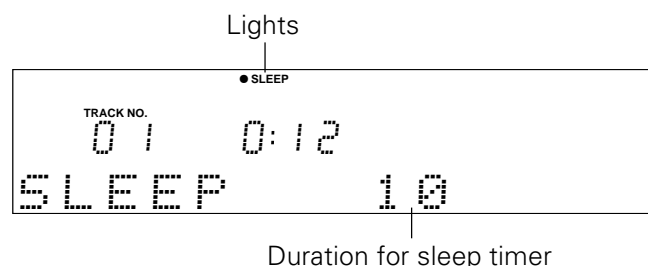

### To cancel

Press the SLEEP key repeatedly until the sleep timer is canceled.

## Maintenance

### Cleaning the head section

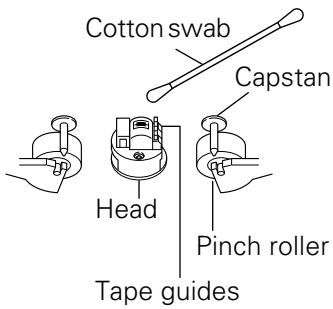

#### Cleaning the heads and peripheral components

For maintaining the best condition of the deck and for longer service life, always keep the heads (recording / playback / erase), capstan and pinch roller clean. To clean them, perform the following:

1. Open the cassette holder.
2. Using a cotton swab dipped in alcohol, clean the head (recording / playback / erase), capstan and pinch roller carefully.

#### Demagnetizing the head

When the recording / playback head is magnetized, the sound quality will deteriorate. In such a case, demagnetize the head using a commercially available demagnetizer (head eraser).



There are precisely aligned parts around the heads, including the tape guides. When cleaning, pay special attention so as not to apply shock to them.

### Maintenance of the unit

When the front panel or case becomes dirty, wipe with a soft, dry cloth. Do not use thinner, benzine, alcohol, etc. for these agents may cause discoloration.

### In regard to contact cleaner

Do not use contact cleaners because it could cause a malfunction. Be specially careful not to use contact cleaners containing oil, for they may deform the plastic component.



# Reference

## Caution on condensation

Condensation (of dew) may occur inside the unit when there is a great difference in temperature between this unit and the outside.

This unit may not function properly if condensation occurs. In this case, leave the unit for a few hours with the power left ON, and restart the operation after the condensation has dried up.

Be specially cautious against condensation in a following circumstance:

When this unit is carried from a place to another across a large difference in temperature, when the humidity in the room where this unit is installed increases, etc.

## WARNING NOTICE:

IN MOST CASES IT IS AN INFRINGEMENT OF COPYRIGHT TO MAKE COPIES OF TAPES OR DISCS WITHOUT THE PERMISSION OF THE COPYRIGHT OWNERS. ANYONE WISHING TO COPY COMMERCIALY AVAILABLE TAPES OR DISCS SHOULD CONTACT THE MECHANICAL COPYRIGHT PROTECTION SOCIETY LIMITED OR THE PERFORMING RIGHTS SOCIETY LIMITED.

US and foreign patents licensed from Dolby Laboratories.

## Memory backup function

<b>Stored contents which are cleared immediately when power plug is unplugged from power outlet</b>	Clock display <b>MD recorder section</b>
<b>Stored contents which are cleared in at least a day after power plug is unplugged from power outlet</b>	<b>Amplifier section</b> "on/standby" status (ON or STANDBY) Input selection Volume control value Tone control levels <b>Tuner section</b> Receiving band Frequency Preset stations Auto tuning setting <b>Cassette deck unit</b> Transport direction DOLBY NR Reverse mode <b>Timer setting contents</b>

## Note related to transportation and movement

Before transporting or moving this unit, carry out the following operations.

- ① Remove the CD or MD from the unit.
- ② Press the ►/|| key of the MD.
- ③ Wait for some time and verify that the display becomes as shown in the figure.

MD NO DISC

- ④ Press the ►/|| key of the CD.
- ⑤ Wait for some time and verify that the display becomes as shown in the figure.

CD NO DISC

- ⑥ Wait a few seconds and turn the unit OFF.

# Handling of discs

## Disc handling precautions

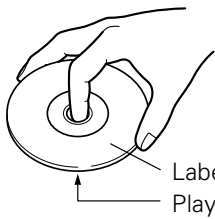

### Handling

Hold the discs so that you do not touch the playing surface.

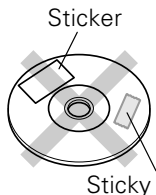

Do not attach paper or tape to either the playing side or the label side of the discs.

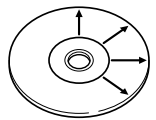

### Cleaning

If fingerprints or foreign matter become attached to the disc, lightly wipe the disc with a soft cotton cloth (or similar) from the center of the disc outwards in a radial manner.

### Storage

When a disc is not to be played for a long period of time, remove it from the player and store it in its case.

## Discs which can be played with this unit

CD (12 cm, 8 cm), and the audio part of CDV, CD-G and CD-EXTRA.

Use discs that comply with the IEC standard, for example a disc carrying the  marking on the label surface.

## Never play a cracked or warped disc

During playback, the disc rotates at high speed in the player. Therefore, to avoid danger, never use a cracked or deformed disc or a disc repaired with tape or adhesive agent. Please do not use discs which are not round because they may cause a malfunction.

## Disc accessories

The disc accessories (stabilizer, protection sheet, protection ring, etc.) which are marketed for improving the sound quality or protecting discs as well as the disc cleaner should not be used with this system because they may cause malfunction.

## Handling of Mini Disc

As the Mini Disc is accommodated inside a cartridge, it can be handled without caring about dust or fingerprint. However, stained or soiled cartridge may cause malfunction. To enjoy beautiful sound for extended period of time, take care on the following points.

### Do not touch the disc directly.

Do not touch the disc by opening the shutter with your hand. The cartridge will be damaged if it is forced open.

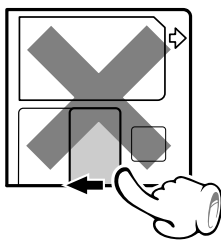

### Storage position

Do not leave Mini Discs in place where the temperature and/or humidity are extremely high (for example, in a place subject to direct sunlight).

### Dust countermeasure

The shutter of the disc cartridge is permanently open while the disc is loaded in the set. Therefore, to prevent dust from penetrating inside the disc, take the disc out of the unit immediately after completion of recording or playback.

### Care

Wipe periodically dust and dirt attached on the cartridge with a dry cloth.

### Write protect tab

To protect recorded contents against accidental erasure, set the write protect tab of the disc open. Return the tab to the original position when you want to record signals on the disc.

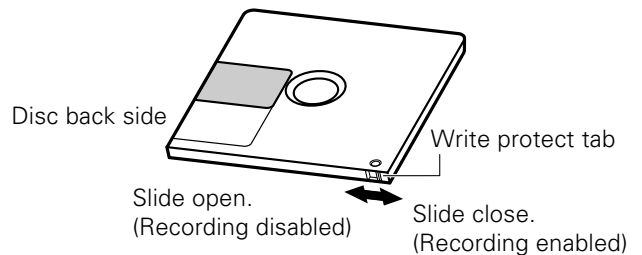

# Notes on cassette tape

## Notes on cassette tape

### Safety tab (accidental erasure prevention tab)

After an important recording has been finished, break the safety tab, to prevent the recorded contents from being erased or recorded on accidentally.

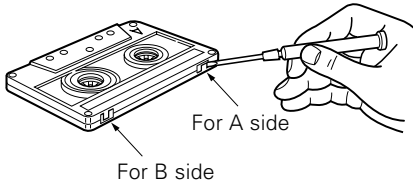

### To store cassette tapes

Do not store the tapes in a place which is subject to direct sunlight, or near equipment that generates heat. Keep the cassette tapes away from any magnetic field.

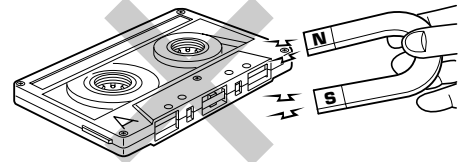

### When there is slack in the tape

In such a case, insert a pencil into the reel hole and wind the reel hub to remove the slack.

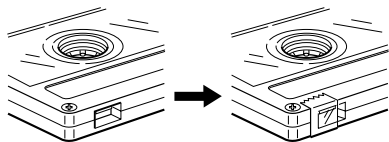
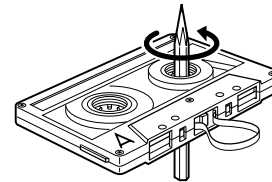

**To re-record** Apply tape only to the position where the tab has been removed.



### 1. Longer tape than 100 minutes cassette tape

Since longer tape than 100 minutes cassette tape is very thin, the tape could adhere to the pinch roller or be easily cut. It is recommended that these tapes not be used with this unit to prevent possible damage.

### 2. Endless tapes

Do not use an endless tape, as this could damage the mechanism of the unit.

# SCMS (Serial Copy Management System)

## SCMS (Serial Copy Management System)

Designed for copyright protection, the SCMS is a prescription that copying of digital signals as they are in the digital form between digital audio equipment is allowable only for one generation.

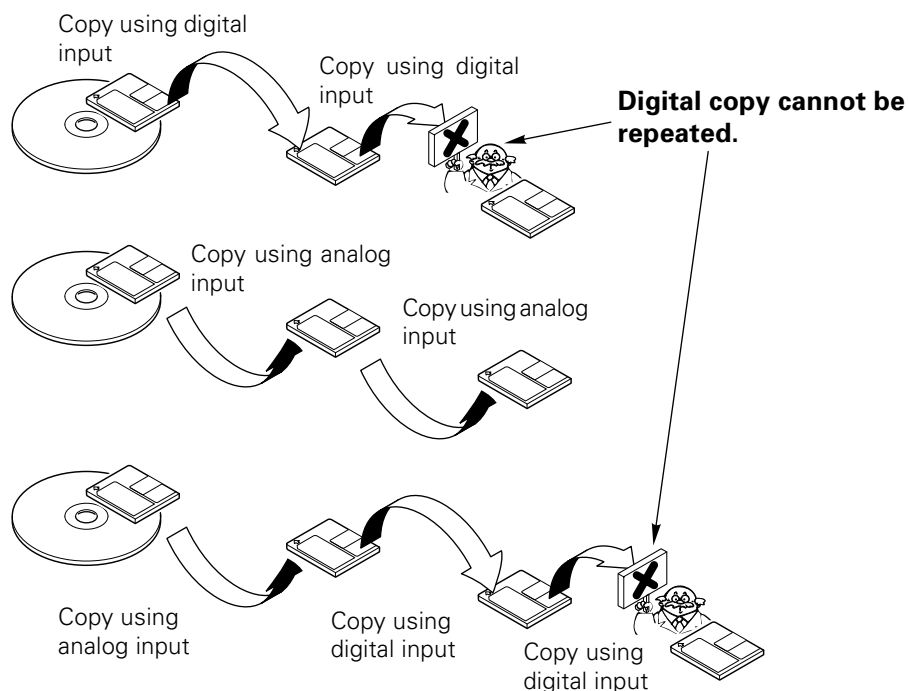

What seems to be a malfunction is not always so. Before calling for service, check the following table according to the symptom of your trouble.

**Operation to reset**

The microcomputer may fall into malfunction (impossibility to operate, erroneous display, etc.) when the power cord is unplugged while unit is ON or due to an external factor. In this case, execute the following procedure to reset the microcomputer and return it to normal condition.

- Please note that resetting the microcomputer clears the contents stored in and it returns to condition when it left the factory.

Unplug the power cord from the power outlet then, while holding the "REPEAT" key depressed, plug the power cord again.

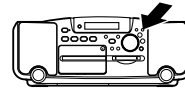

REPEAT



**Amplifier section/Speakers**

Symptom	Cause	Remedy
Sound is not produced.	<ul style="list-style-type: none"> <li>● The volume control is set to the minimum position.</li> <li>● The headphone plug is inserted into the jack.</li> </ul>	<ul style="list-style-type: none"> <li>● Adjust to an required volume. → 10</li> <li>● Unplug the headphone plug. → 10</li> </ul>
No sound from the headphones.	<ul style="list-style-type: none"> <li>● Imperfect insertion.</li> <li>● The volume control is set to the minimum position.</li> </ul>	<ul style="list-style-type: none"> <li>● Insert correctly. → 10</li> <li>● Adjust to an required volume. → 10</li> </ul>

**Tuner section**

Symptom	Cause	Remedy
The clock display blinks without changing the figures.	<ul style="list-style-type: none"> <li>● There was a power failure.</li> <li>● The power cord was unplugged from the outlet.</li> </ul>	<ul style="list-style-type: none"> <li>● Adjust the present time again. → 9</li> <li>● Adjust the present time again.</li> </ul>
Timer operation is not possible.	<ul style="list-style-type: none"> <li>● The present time has not been adjusted or there was a power failure.</li> <li>● The timer ON time and OFF time have not been set.</li> <li>● The timer execution was not set up.</li> </ul>	<ul style="list-style-type: none"> <li>● Adjust the present time referring to "Setting the current time". → 9</li> <li>● Set the timer ON time and OFF time. → 46</li> <li>● Press the <b>TIMER</b> key to set up the execution. → 47</li> </ul>
Radio stations cannot be received.	<ul style="list-style-type: none"> <li>● The antennas have not been connected.</li> <li>● A proper broadcasting band has not been selected.</li> <li>● The frequency of the station to be received is not tuned.</li> </ul>	<ul style="list-style-type: none"> <li>● Connect antennas. → 5</li> <li>● Select a band. → 26</li> <li>● Tune to the frequency of the desired station.</li> </ul>
Noise interferes.	<ul style="list-style-type: none"> <li>● Car ignition noise.</li> <li>● Influence of an electric appliance.</li> <li>● A TV set is installed near the system.</li> </ul>	<ul style="list-style-type: none"> <li>● Install the outdoor antenna in an apart position from the road.</li> <li>● Switch the suspected electric appliance OFF.</li> <li>● Install the TV or the system at an increased distance between them.</li> </ul>
A station has been preset but it cannot be received by pressing the P.CALL key.	<ul style="list-style-type: none"> <li>● The frequency of the preset station is not tunable.</li> <li>● The preset memory has been cleared because the power cord has been unplugged for a long period.</li> </ul>	<ul style="list-style-type: none"> <li>● Preset stations with tunable frequencies. → 27</li> <li>● Preset stations again. → 27</li> </ul>

Knowledge section

**Remote control unit**

Symptom	Cause	Remedy
Remote control operation is not possible.	<ul style="list-style-type: none"> <li>● Batteries are exhausted.</li> <li>● The remote control is too far away from the system, the controlling angle is deviated or there is an obstacle in between.</li> <li>● The component to be played is not loaded with a CD, MD or cassette tape.</li> </ul>	<ul style="list-style-type: none"> <li>● Replace with new batteries. → 8</li> <li>● Operate the unit inside the remote controllable range. → 8</li> <li>● Load a CD, MD or cassette tape in the component to be played.</li> </ul>

**Symptoms related to MD standard**

Symptom	Cause
<b>"DISC FULL" is displayed while the disc still has a remaining recordable time.</b>	<ul style="list-style-type: none"> <li>More than 255 tracks (track No. 256 or more) cannot be recorded. (There may be also cases in which recording is impossible while the track number is less than 256.) In such a case, the REMAIN time display shows "0:00".</li> </ul>
<b>The possible recording time does not increase even when a short track is erased.</b>	<ul style="list-style-type: none"> <li>When the remaining time of the entire disc is less than 12 sec, the remaining time indication on the display becomes "0:00". When the total time of the deleted tracks exceeds 12 sec, the display changes to the recordable time.</li> <li>When a short track is deleted on a repeatedly edited disc, the remaining time may not increase.</li> </ul>
<b>Tracks can not be connected.</b>	<ul style="list-style-type: none"> <li>TRACK COMBINE may sometimes be impossible with a MD which has been subjected to several times of editing.</li> </ul>
<b>The time which has been recorded on the MD and the remaining time do not add up to the maximum recording time (60, 74 or 80 min.).</b>	<ul style="list-style-type: none"> <li>As recording is executed with 2 sec. as the minimum unit, the display time may not coincide.</li> </ul>
<b>When search is performed in a track which has been compiled by editing, the sound is sometimes interrupted.</b>	<ul style="list-style-type: none"> <li>This derives from the restriction in the MD system standard and not a malfunction.</li> </ul>
<b>The track numbers are not assigned correctly.</b>	<ul style="list-style-type: none"> <li>Depending on the contents of the recorded source (CD etc.), the track numbers may not be assigned correctly.</li> </ul>
<b>"READING" is displayed for an abnormally long time.</b>	<ul style="list-style-type: none"> <li>When a new recordable MD (with nothing recorded) is inserted, "READING" is displayed longer than usual.</li> </ul>
<b>The time display becomes inaccurate with a monaurally recorded disc.</b>	<ul style="list-style-type: none"> <li>Monaural recording and stereo recording are executed according to different formats. This is not a malfunction.</li> </ul>
<b>Input of 1792 title characters is not possible.</b>	<ul style="list-style-type: none"> <li>The title recording area is used in units of 7 characters, so that input of 1792 characters may not be possible.</li> </ul>

**MD recorder section (other symptoms)**

Symptom	Cause	Remedy
<b>Sound is not output even when the play key is pressed.</b>	<ul style="list-style-type: none"> <li>No disc has been loaded.</li> <li>A non-recorded disc has been loaded.</li> </ul>	<ul style="list-style-type: none"> <li>Load a disc.</li> <li>Load a prerecorded disc or playback-only disc.</li> </ul>
<b>Recording is not possible</b>	<ul style="list-style-type: none"> <li>The disc is write-protected.</li> <li>An attempt is made to record digital signal from a source while its digital copy has been prohibited by SCMS.</li> <li>A playback-only disc has been loaded.</li> <li>The disc does not have a recordable area.</li> <li>The input selector is set to MD.</li> </ul>	<ul style="list-style-type: none"> <li>Change the position of the write protect tab to the write position or use a recordable disc. → 50</li> <li>Recording is not possible. → 51</li> <li>Use a recordable disc.</li> <li>Use another disc.</li> <li>Set the input selector to the source to be recorded. → 28</li> </ul>
<b>Sound is distorted.</b>	<ul style="list-style-type: none"> <li>A disc in which distorted sound has been recorded is played.</li> </ul>	<ul style="list-style-type: none"> <li>Record again.</li> </ul>
<b>Noise is noticeable.</b>	<ul style="list-style-type: none"> <li>An external noise is induced.</li> </ul>	<ul style="list-style-type: none"> <li>Install the unit at a position apart from an electric appliance or TV set.</li> </ul>
<b>The display goes out for a moment after the unit has been turned ON.</b>	<ul style="list-style-type: none"> <li>Switching is operated too quickly.</li> </ul>	<ul style="list-style-type: none"> <li>This is not a malfunction.</li> </ul>

**MD recorder section (Displayed messages and actions to be taken against them)**

Displayed Message	Meaning	Action
<b>NO DISC</b>	<ul style="list-style-type: none"> <li>No disc is placed on the tray.</li> </ul>	<ul style="list-style-type: none"> <li>Load a disc.</li> </ul>
<b>CAN'T COPY</b>	<ul style="list-style-type: none"> <li>An attempt is made to record digital signal from a source while its digital copy has been prohibited by SCMS.</li> </ul>	<ul style="list-style-type: none"> <li>Recording is not possible.</li> </ul>
<b>DISC FULL</b>	<ul style="list-style-type: none"> <li>There is no recordable area on the disc.</li> <li>An attempt is made to record a 256th track.</li> </ul>	<ul style="list-style-type: none"> <li>Use another recordable disc.</li> <li>More than 256 tracks cannot be recorded per disc.</li> </ul>
<b>TITLE FULL</b>	<ul style="list-style-type: none"> <li>An attempt is made to assign a title with more characters than usable.</li> </ul>	<ul style="list-style-type: none"> <li>Refer to "<b>Total number of title characters</b>".</li> </ul>
<b>BLANK DISC</b>	<ul style="list-style-type: none"> <li>The disc does not contain any recordings.</li> </ul>	<ul style="list-style-type: none"> <li>When playback is required, use a recorded disc.</li> </ul>
<b>NO TRACKS</b>	<ul style="list-style-type: none"> <li>The disc does not contain any tracks but has a disc title.</li> </ul>	<ul style="list-style-type: none"> <li>The disc can be used for recording without any problem.</li> </ul>
<b>READING</b>	<ul style="list-style-type: none"> <li>The TOC *1 data of the disc is being read.</li> </ul>	<ul style="list-style-type: none"> <li>This is a normal operation.</li> </ul>
<b>WRITING</b>	<ul style="list-style-type: none"> <li>The data related to editing or recording is being written in the disc.</li> </ul>	<ul style="list-style-type: none"> <li>This is a normal operation.</li> </ul>
<b>DISC ERROR</b>	<ul style="list-style-type: none"> <li>The contents of UTOC *2 are abnormal.</li> </ul>	<ul style="list-style-type: none"> <li>Perform "<b>ALL ERASE</b>" operation. If this is not possible, use another disc.</li> </ul>
<b>CAN'T EDIT</b>	<ul style="list-style-type: none"> <li>An attempt is made to perform editing beyond the restrictions, for example to erase a track which is too short.</li> </ul>	<ul style="list-style-type: none"> <li>Perform editing following the restrictions.</li> </ul>
<b>?(blinking)</b>	<ul style="list-style-type: none"> <li>This is a message for confirming if editing can really be executed.</li> </ul>	<ul style="list-style-type: none"> <li>Press the <b>ENTER</b> key to execute editing.</li> </ul>
<b>PROTECTED</b>	<ul style="list-style-type: none"> <li>The minidisc is write-protected.</li> </ul>	<ul style="list-style-type: none"> <li>Cancel the write protection.</li> </ul>
<b>PLAY ONLY</b>	<ul style="list-style-type: none"> <li>The minidisc is only for playback.</li> </ul>	<ul style="list-style-type: none"> <li>Insert a minidisc for recording.</li> </ul>
<b>UNIT ERROR</b>	<ul style="list-style-type: none"> <li>This indicates some trouble.</li> </ul>	<ul style="list-style-type: none"> <li>Return to normal condition is made by switching the unit off and then on again.</li> </ul>

\*1 All minidisks contain a Table of Contents (TOC) in addition to sound signals. The TOC is similar to the table of contents in a book and contains information, such as track numbers, track length, and character information, that cannot be rewritten.

\*2 In addition to the TOC, minidisks also contain a special User's Table of Contents (UTOC) that contains track number, track length, and character information, that can be rewritten.

**Memory Backup for the MD Recorder Section**

The contents of the memory are not stored on the disc if the power cord is unplugged. If the power cord is unplugged suddenly or there is a power failure, the information on recording and editing (normally recorded when the minidisc is ejected) may be erased or destroyed before it is recorded on the minidisc. Once the information has disappeared, it can not be recovered. After recording or editing, always remove the minidisc to record the recording or editing information.

**CD player section**

Symptom	Cause	Remedy
<b>A CD is placed in the player but it cannot be played.</b>	<ul style="list-style-type: none"> <li>● The disc is placed upside down.</li> <li>● The disc is extremely dirty.</li> <li>● Dew is condensed on the optics lens.</li> </ul>	<ul style="list-style-type: none"> <li>● Place the disc properly, with the label side facing upward.</li> <li>● Clean the disc referring to <b>"Disc handling precautions"</b>. → 50</li> <li>● Refer to <b>"Caution on condensation"</b> and remove the condensation by evaporation. → 49</li> </ul>
<b>Sound is not produced.</b>	<ul style="list-style-type: none"> <li>● The disc is extremely dirty.</li> <li>● The disc is scratched.</li> </ul>	<ul style="list-style-type: none"> <li>● Clean the disc referring to <b>"Disc handling precautions"</b>. → 50</li> <li>● Try another disc.</li> </ul>
<b>Sound skips.</b>	<ul style="list-style-type: none"> <li>● The disc is dirty.</li> <li>● The player is subject to vibration.</li> </ul>	<ul style="list-style-type: none"> <li>● Clean the disc referring to <b>"Disc handling precautions"</b>. → 50</li> <li>● Install the unit in a place not subject to vibrations.</li> </ul>

**Cassette deck**

Symptom	Cause	Remedy
<b>Sound cannot be produced by pressing the play key.</b>	<ul style="list-style-type: none"> <li>● The head is dirty.</li> <li>● The tape is wound too tight due to irregular winding.</li> <li>● A nonrecorded tape is played.</li> </ul>	<ul style="list-style-type: none"> <li>● Clean the head referring to <b>"Cleaning the head section"</b>. → 48</li> <li>● Try another tape.</li> <li>● Play a recorded tape.</li> </ul>
<b>No operation occurs even when an operation key is pressed.</b>	<ul style="list-style-type: none"> <li>● The cassette holder is not closed completely.</li> <li>● The operation key is pressed in less than 4 seconds after turning the power ON.</li> <li>● The tape is wound too tight due to irregular winding.</li> </ul>	<ul style="list-style-type: none"> <li>● Close the holder completely. → 24</li> <li>● Press operation keys after waiting for more than 4 seconds.</li> <li>● Try another tape.</li> </ul>
<b>The cassette holders cannot be opened by pressing the "▲ push OPEN" button.</b>	<ul style="list-style-type: none"> <li>● The key is pressed during recording or playback.</li> <li>● The microcomputer is malfunctioning due to external noise.</li> </ul>	<ul style="list-style-type: none"> <li>● Press in stop mode.</li> <li>● Reset the microcomputer. → 52</li> </ul>
<b>Sound is harsh or high frequencies are not reproduced.</b>	<ul style="list-style-type: none"> <li>● The head is dirty.</li> <li>● The tape is stretched or shrunk.</li> </ul>	<ul style="list-style-type: none"> <li>● Clean the head referring to <b>"Cleaning the head section"</b>. → 48</li> <li>● Try another tape.</li> </ul>
<b>Noise is noticeable.</b>	<ul style="list-style-type: none"> <li>● The tape head is magnetized.</li> <li>● A tape recorded with Dolby NR ON is played with TAPE EQ. OFF.</li> </ul>	<ul style="list-style-type: none"> <li>● Demagnetize the head referring to <b>"Cleaning the head section"</b>. → 48</li> <li>● Set the TAPE EQ. to on. → 25</li> </ul>
<b>Recording cannot be started by pressing the record key.</b>	<ul style="list-style-type: none"> <li>● The recording protect tab of the cassette has been broken.</li> <li>● The cassette holder is not closed completely.</li> <li>● The <b>TAPE</b> input is selected.</li> <li>● The tape is fully wound to one of the reels.</li> </ul>	<ul style="list-style-type: none"> <li>● Use a cassette with an unbroken recording protect tab or block the hole. → 51</li> <li>● Close the holder completely. → 24</li> <li>● Set the input selector to the source to be recorded. → 30</li> <li>● Change the tape transport direction or reverse the tape insertion orientation. → 24</li> </ul>

**Main unit****[Amplifier section]**

Rated output power during STEREO operation  
 10 % T.H.D., at 4  $\Omega$  ..... 4 W + 4 W

**[Tuner section]****FM tuner section**

Tuning frequency range ..... 87.5 MHz ~ 108 MHz

**MW (AM) tuner section**

Tuning frequency range ..... 531 kHz ~ 1,602 kHz

**[MD recorder section]**

Laser ..... Semiconductor laser

Recording method  
 ..... Field modulation overwrite method

Audio compression ..... ATRAC

D/A Conversion ..... 1 Bit

Wow & flutter ..... Less than unmeasurable limit

**[CD player section]**

Laser ..... Semiconductor laser

D/A Conversion ..... 1 Bit

Oversampling ..... 8 fs (352.8 kHz)

Frequency response ..... 20 Hz~20 kHz

Wow and flutter ..... Less than unmeasurable limit

**[Cassette deck section]**

Track ..... 4-track, 2-channel stereo

Recording system ..... AC bias system  
 (Frequency: 105 kHz)

**Heads**

Playback / recording head ..... 1

Erasing head ..... 1

Motors ..... 1

Fast winding time ..... Approx. 100 seconds  
 (C-60 tape)

**[General]**

Power consumption ..... 38 W

Standby power consumption ..... 0.3 W

Dimensions ..... W: 464 mm

H: 182 mm

D: 243 mm

Weight (net) ..... 5.4 kg

**Speakers**

Enclosure ..... Bass-reflex type

Speaker configuration

Speaker unit ..... 80 mm, cone type



KENWOOD follows a policy of continuous advancements in development. For reason specifications may be changed without notice.

- The full performance may not be exhibited in an extremely cold location (under a water-freezing temperature).

**KENWOOD****For your records**

Record the serial number, found on the back of the unit, in the spaces designated on the warranty card, and in the space provided below. Refer to the model and serial numbers whenever you call upon your dealer for information or service on this product.

Model \_\_\_\_\_ Serial Number \_\_\_\_\_



## Free Manuals Download Website

<http://myh66.com>

<http://usermanuals.us>

<http://www.somanuals.com>

<http://www.4manuals.cc>

<http://www.manual-lib.com>

<http://www.404manual.com>

<http://www.luxmanual.com>

<http://aubethermostatmanual.com>

Golf course search by state

<http://golfingnear.com>

Email search by domain

<http://emailbydomain.com>

Auto manuals search

<http://auto.somanuals.com>

TV manuals search

<http://tv.somanuals.com>