

XV-2020

2x SRX EXPANSION

OWNER'S MANUAL

Thank you, and congratulations on your choice of the Roland XV-2020.

Before using this unit, carefully read the sections entitled: "IMPORTANT SAFETY INSTRUCTIONS" (p. 2), "USING THE UNIT SAFELY" (p. 3), and "IMPORTANT NOTES" (p. 5). These sections provide important information concerning the proper operation of the unit. Additionally, in order to feel assured that you have gained a good grasp of every feature provided by your new unit, Owner's Manual should be read in its entirety. The manual should be saved and kept on hand as a convenient reference.

Listening to the Demo Songs

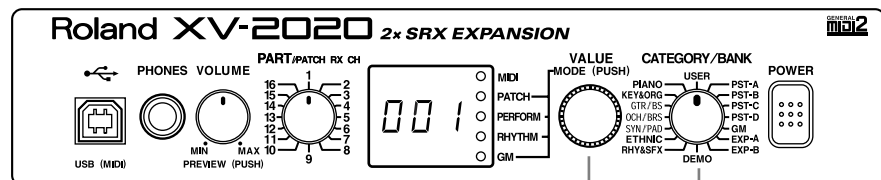

2, 3, 4 1

1. Turn [CATEGORY/BANK] to choose DEMO.
"ALL" flashes on the display.
2. Turn [VALUE] to choose the song you want to hear.
3. Press [VALUE].
The display shows "PLY" and Demo Play starts.
4. Press [VALUE] once more to stop the Performance.

* No data for the music that is played will be output from MIDI OUT.

* MIDI messages received from external instruments are ignored while the Demo Play screen is displayed.

* All rights reserved. Unauthorized use of this material for purposes other than private, personal enjoyment is a violation of applicable laws.

For the U.K.

IMPORTANT: THE WIRES IN THIS MAINS LEAD ARE COLOURED IN ACCORDANCE WITH THE FOLLOWING CODE.

BLUE: NEUTRAL
BROWN: LIVE

As the colours of the wires in the mains lead of this apparatus may not correspond with the coloured markings identifying the terminals in your plug, proceed as follows:

The wire which is coloured BLUE must be connected to the terminal which is marked with the letter N or coloured BLACK.

The wire which is coloured BROWN must be connected to the terminal which is marked with the letter L or coloured RED.

Under no circumstances must either of the above wires be connected to the earth terminal of a three pin plug.

USING THE UNIT SAFELY

INSTRUCTIONS FOR THE PREVENTION OF FIRE, ELECTRIC SHOCK, OR INJURY TO PERSONS

About ⚠ WARNING and ⚠ CAUTION Notices

⚠ WARNING	Used for instructions intended to alert the user to the risk of death or severe injury should the unit be used improperly.
⚠ CAUTION	Used for instructions intended to alert the user to the risk of injury or material damage should the unit be used improperly. * Material damage refers to damage or other adverse effects caused with respect to the home and all its furnishings, as well to domestic animals or pets.

About the Symbols

	The ⚠ symbol alerts the user to important instructions or warnings. The specific meaning of the symbol is determined by the design contained within the triangle. In the case of the symbol at left, it is used for general cautions, warnings, or alerts to danger.
	The ⚡ symbol alerts the user to items that must never be carried out (are forbidden). The specific thing that must not be done is indicated by the design contained within the circle. In the case of the symbol at left, it means that the unit must never be disassembled.
	The ● symbol alerts the user to things that must be carried out. The specific thing that must be done is indicated by the design contained within the circle. In the case of the symbol at left, it means that the power-cord plug must be unplugged from the outlet.

ALWAYS OBSERVE THE FOLLOWING

⚠ WARNING

- Before using this unit, make sure to read the instructions below, and the Owner's Manual.
- Do not open or perform any internal modifications on the unit or its AC adaptor. (The only exception would be where this manual provides specific instructions which should be followed in order to put in place user-installable options; see p. 12.)
- Do not attempt to repair the unit, or replace parts within it (except when this manual provides specific instructions directing you to do so). Refer all servicing to your retailer, the nearest Roland Service Center, or an authorized Roland distributor, as listed on the "Information" page.
- Never use or store the unit in places that are:
 - Subject to temperature extremes (e.g., direct sunlight in an enclosed vehicle, near a heating duct, on top of heat-generating equipment); or are
 - Damp (e.g., baths, washrooms, on wet floors); or are
 - Humid; or are
 - Exposed to rain; or are
 - Dusty; or are
 - Subject to high levels of vibration.
- This unit should be used only with a rack or stand that is recommended by Roland.

- When using the unit with a rack or stand recommended by Roland, the rack or stand must be carefully placed so it is level and sure to remain stable. If not using a rack or stand, you still need to make sure that any location you choose for placing the unit provides a level surface that will properly support the unit, and keep it from wobbling.
- Be sure to use only the AC adaptor supplied with the unit. Also, make sure the line voltage at the installation matches the input voltage specified on the AC adaptor's body. Other AC adaptors may use a different polarity, or be designed for a different voltage, so their use could result in damage, malfunction, or electric shock.
- Do not excessively twist or bend the power cord, nor place heavy objects on it. Doing so can damage the cord, producing severed elements and short circuits. Damaged cords are fire and shock hazards!
- This unit, either alone or in combination with an amplifier and headphones or speakers, may be capable of producing sound levels that could cause permanent hearing loss. Do not operate for a long period of time at a high volume level, or at a level that is uncomfortable. If you experience any hearing loss or ringing in the ears, you should immediately stop using the unit, and consult an audiologist.
- Do not allow any objects (e.g., flammable material, coins, pins); or liquids of any kind (water, soft drinks, etc.) to penetrate the unit.

- Immediately turn the power off, remove the AC adaptor from the outlet, and request servicing by your retailer, the nearest Roland Service Center, or an authorized Roland distributor, as listed on the “Information” page when:
 - The AC adaptor, the power-supply cord, or the plug has been damaged; or
 - Objects have fallen into, or liquid has been spilled onto the unit; or
 - The unit has been exposed to rain (or otherwise has become wet); or
 - The unit does not appear to operate normally or exhibits a marked change in performance.



- In households with small children, an adult should provide supervision until the child is capable of following all the rules essential for the safe operation of the unit.



- Protect the unit from strong impact. (Do not drop it!)



- Do not force the unit’s power-supply cord to share an outlet with an unreasonable number of other devices. Be especially careful when using extension cords—the total power used by all devices you have connected to the extension cord’s outlet must never exceed the power rating (watts/amperes) for the extension cord. Excessive loads can cause the insulation on the cord to heat up and eventually melt through.



- Before using the unit in a foreign country, consult with your retailer, the nearest Roland Service Center, or an authorized Roland distributor, as listed on the “Information” page.



- Always turn the unit off and unplug the AC adaptor before attempting installation of the circuit board (SRX series; p. 12).



- DO NOT play a CD-ROM disc on a conventional audio CD player. The resulting sound may be of a level that could cause permanent hearing loss. Damage to speakers or other system components may result.



CAUTION

- The unit and the AC adaptor should be located so their location or position does not interfere with their proper ventilation.



- Always grasp only the output plug or the body of the AC adaptor when plugging into, or unplugging from, this unit or an outlet.



- Whenever the unit is to remain unused for an extended period of time, disconnect the AC adaptor.



- Try to prevent cords and cables from becoming entangled. Also, all cords and cables should be placed so they are out of the reach of children.



- Never climb on top of, nor place heavy objects on the unit.



- Never handle the AC adaptor body, or its output plugs, with wet hands when plugging into, or unplugging from, an outlet or this unit.



- Before moving the unit, disconnect the AC adaptor and all cords coming from external devices.



- Disconnect all cords coming from external devices before moving the unit.



- Before cleaning the unit, turn off the power and unplug the AC adaptor from the outlet (p. 12).



- Whenever you suspect the possibility of lightning in your area, disconnect the AC adaptor from the outlet.



- Install only the specified circuit board(s) (SRX series). Remove only the specified screws (p. 106).



- Should you remove screws and rubber feet, make sure to put them in a safe place out of children’s reach, so there is no chance of them being swallowed accidentally.



* Microsoft and Windows are registered trademarks of Microsoft Corporation.

* Windows® 98 is known officially as: “Microsoft® Windows® 98 operating system.”

* Screen shots in this documents are reprinted with permission from Microsoft Corporation.

* Windows® 2000 is known officially as: “Microsoft® Windows® 2000 operating system.”

* Windows® Me is known officially as: “Microsoft® Windows® Millennium Edition operating system.”

* Apple and Macintosh are registered trademark of Apple Computer, Inc.

* MacOS is a trademark of Apple Computer, Inc.

* All product names mentioned in this document are trademarks or registered trademarks of their respective owners.

* OMS is a registered trademark of Opcode Systems, Inc.

* FreeMIDI is a trademark of Mark of the Unicorn, Inc.

IMPORTANT NOTES

In addition to the items listed under “USING THE UNIT SAFELY” on p. 3 , please read and observe the following:

Power Supply

- Do not use this unit on the same power circuit with any device that will generate line noise (such as an electric motor or variable lighting system).
- The AC adaptor will begin to generate heat after long hours of consecutive use. This is normal, and is not a cause for concern.
- Before connecting this unit to other devices, turn off the power to all units. This will help prevent malfunctions and/or damage to speakers or other devices.

Placement

- Using the unit near power amplifiers (or other equipment containing large power transformers) may induce hum. To alleviate the problem, change the orientation of this unit; or move it farther away from the source of interference.
- This device may interfere with radio and television reception. Do not use this device in the vicinity of such receivers.
- Noise may be produced if wireless communications devices, such as cell phones, are operated in the vicinity of this unit. Such noise could occur when receiving or initiating a call, or while conversing. Should you experience such problems, you should relocate such wireless devices so they are at a greater distance from this unit, or switch them off.
- To avoid possible breakdown, do not use the unit in a wet area, such as an area exposed to rain or other moisture.

Maintenance

- For everyday cleaning wipe the unit with a soft, dry cloth or one that has been slightly dampened with water. To remove stubborn dirt, use a cloth impregnated with a mild, non-abrasive detergent. Afterwards, be sure to wipe the unit thoroughly with a soft, dry cloth.
- Never use benzine, thinners, alcohol or solvents of any kind, to avoid the possibility of discoloration and/or deformation.

Handling CD-ROMs

- Avoid touching or scratching the shiny underside (encoded surface) of the disc. Damaged or dirty CD-ROM discs may not be read properly. Keep your discs clean using a commercially available CD cleaner.

Additional Precautions

- Please be aware that the contents of memory can be irretrievably lost as a result of a malfunction, or the improper operation of the unit. To protect yourself against the risk of losing important data, we recommend that you periodically save a backup copy of important data you have stored in the unit's memory in another MIDI device (e.g., a sequencer).
- Unfortunately, it may be impossible to restore the contents of data that was stored in another MIDI device (e.g., a sequencer) once it has been lost. Roland Corporation assumes no liability concerning such loss of data.
- Use a reasonable amount of care when using the unit's buttons, sliders, or other controls; and when using its jacks and connectors. Rough handling can lead to malfunctions.

- When connecting / disconnecting all cables, grasp the connector itself—never pull on the cable. This way you will avoid causing shorts, or damage to the cable's internal elements.
- To avoid disturbing your neighbors, try to keep the unit's volume at reasonable levels. You may prefer to use headphones, so you do not need to be concerned about those around you (especially when it is late at night).
- When you need to transport the unit, package it in the box (including padding) that it came in, if possible. Otherwise, you will need to use equivalent packaging materials.
- To prevent the inadvertent disruption of power to your unit (should the plug be pulled out accidentally), and to avoid applying undue stress to the AC adaptor jack, anchor the power cord using the cord hook, as shown in the illustration.

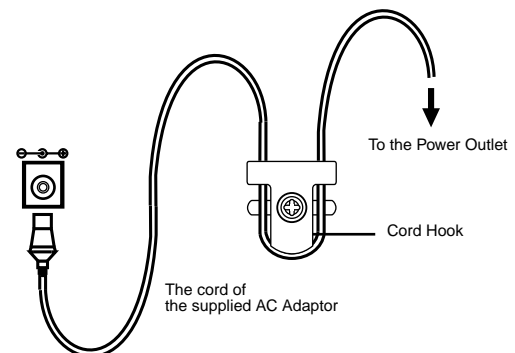

- In some cases, depending on the environment in which the unit is installed, the surface of the panel may sometimes feel rough and grainy. This is due to an infinitesimal electrical charge, which is absolutely harmless. However, if you are concerned about this, connect the ground terminal (see figure) with an external ground. When the unit is grounded, a slight hum may occur, depending on the particulars of your installation. If you are unsure of the connection method, contact the nearest Roland Service Center, or an authorized Roland distributor, as listed on the “Information” page.

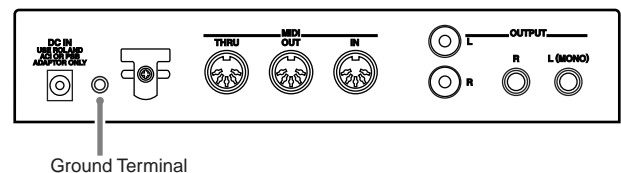

Unsuitable places for connection

- Water pipes (may result in shock or electrocution)
- Gas pipes (may result in fire or explosion)
- Telephone-line ground or lightning rod (may be dangerous in the event of lightning)

Contents

IMPORTANT NOTES	5
Features	8
Front and Rear Panel	9
Getting Ready to Play	10
Attaching the Rubber Feet	10
Installing on the Rack-Mount Adaptor	10
Connecting to MIDI Devices and Audio Equipment	11
Turning the Power On/Off	12
Restoring the Factory Settings (Factory Reset)	12
For Those Using a Computer	13
Installing & Setup the Driver (Windows)	13
Settings and checking	21
Installing & Setup the Driver (Macintosh)	24
Connecting with MIDI Connectors	30
Installing the Included Editor Software	30
About Patches and Performances.....	31
Quick Start	33
Playing Sounds	34
Playing Patches (Phrase Preview)	34
Playing a Patch on the XV-2020 from an External MIDI Device (MIDI Keyboard)	34
Choosing Patches	35
Choosing Patches by Category	37
Choosing a Performance	38
Switching the Mode (Patch, Performance)	39
Using an External MIDI Device to Select Patches and Change Other Settings	40
Advanced Use	43
Creating a Patch.....	44
How a Patch Is Organized	44
Tips for Creating a Patch.....	45
Choosing the Tones That Sound (Tone On/Off)	45
Confirming Tones	45
Patch Parameter	46
More Advanced Editing of Tones	51
Tips for Choosing a Waveform	52
Adjusting Effect Settings	61
Saving Patches You Create	61
Creating a Rhythm Set.....	62
How Percussion Instruments Are Organized	62
Choosing the Tones That Sound (Tone On/Off)	62
Confirming Tones	62
Rhythm Set Parameters	63
Setting up Individual Rhythm Tones	63
Tips for Choosing Rhythm Tone Waveforms	63
Rhythm Parameter	64
Adjusting Effect Settings.....	69
Saving Rhythm Sets You Create	69
Creating a Performance.....	70
How a Performance Is Organized	70
Basic Ways to Use Performances	70
Switching Parts.....	71
Turning a Tone On or Off	71
Confirming Tones	71
Performance Parameters	71

Adjusting Effect Settings	75
Saving Performances You Create	75
Using the XV-2020 Effects.....	76
Turning Effects On/Off	76
Patch/Rhythm Set Mode Settings	77
Performance Mode Settings	78
Multi-Effects Parameter	80
Multi-Effects Parameters.....	82
Saving a Sound You Create	92
Saving Edits to the XV-2020's Internal Memory (WRITE)	92
Initializing a Sound (INITIALIZE)	92
Transmitting Sound Settings (XFER)	93
Establishing Settings for an Entire XV-2020 (SYSTEM COMMON)	94
Other Settings	95
Making USB-Related Settings	95
Checking the Program Version	95
Using the XV-2020 as a General MIDI Sound Module.....	96
Entering GM Mode	96
Initializing the Sound Generator for General MIDI System Basic Settings	96
Playing Back a GM Score	96
Making Effects Settings in GM Mode (EFFECTS)	97
Making Settings for Each Part	98
Examples of Applications Using the XV-2020.....	99
Controlling the XV-2020 in real time Using an External MIDI Device	99
Applications for Patches	100
Changing Part Settings from an External MIDI Device	103
Appendix	105
Installing a Wave Expansion Board	106
Installation de la carte d'extension Wave (French language for Canadian Safety Standard).....	108
Troubleshooting.....	110
Problems when using the XV-2020	110
Problems related to the USB driver	111
Error Messages	116
List of Parameters That Can Be Affected Using the XV-2020	117
XV Editor Screens – Page to Turn to for Info on a Parameter	119
Waveform List	121
Patch List	124
Rhythm Set List.....	130
Performance List.....	135
Demo Song List.....	135
MIDI Implementation	136
Specifications.....	162
INDEX	163

Features

64-Voice Polyphony and 16-Part Multitimbrality

The XV-2020 is a 16-part multitimbral sound generator that produces up to 64 simultaneous polyphonic voices. It provides ample polyphony, even with Patches containing multiple Tones.

Create Amazingly Expressive Tones

With Patches combining four tones using stereo waves, stereo four-wave rhythm tones, and more, you can create even more advanced and complex Patches.

XV-5080/5050 Wave Data Included

With 512 preset Patches and 256 GM2 Patches, you get a total of 768 internal Patches. The XV-2020 also comes equipped with 40 different types of Multi-Effects (MFX).

Accepts SRX Series Wave Expansion Boards

You can install up to two SRX Series Wave Expansion Boards, allowing you to create sounds built on large volumes of wave data.

Equipped with a USB Connector

The XV-2020 has a USB connector on its front panel, so that you can easily connect your computer.

Supports General MIDI system Level 2

The XV-2020 provides a mode compatible with General MIDI System Level 2, the standard format for desktop music (DTM) systems. The upwardly compatible General MIDI 2 standards pick up where the original General MIDI standard left off, offering enhanced expressive capabilities and even greater compatibility. You can play back commercially available General MIDI-compatible song data.

Easy-to-understand, Easy-to-use Operations and Other Useful Features

You can use the CATEGORY/BANK knob to choose sounds by category. There is a Phrase Preview that lets you audition patches through phrases, using just the XV-2020.

Editing Software Included

The XV Editor software allows you to edit the XV-2020's Patches, Rhythms, and Performances on your computer. You can assign parameters to knobs and sliders for intuitive operation as you freely create sounds with your computer.

Front and Rear Panel

Front Panel

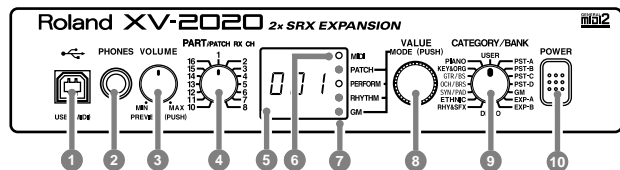

1. USB Connector

Use this for connecting a computer to the XV-2020 using a USB cable (p. 13).

2. PHONES Jack

This is the jack for connecting headphones (sold separately).

* Use headphones with an impedance of 8 to 150 Ohms.

3. VOLUME Knob

This adjusts the volume level for the OUTPUT jack and the PHONES jack. You can also check out a sound using the XV-2020 alone by pressing the VOLUME knob (**Playing Patches (Phrase Preview)** p. 34). When in a mode other than the Patch mode, pressing the VALUE knob while holding down the VOLUME knob switches you to the Edit mode.

4. PART Knob

In the Patch mode, it changes the receive channel. In the Performance mode or the GM mode, it selects the Part to which settings are to be applied.

5. Display

Displays a variety of information about the operation being performed.

6. MIDI Indicator

Lights up when MIDI messages are received.

7. MODE Indicators

The indicator for the currently active mode lights up.

8. VALUE Knob

This changes the setting values for parameters. Turning the knob rapidly makes the value change in larger increments. Pressing the knob switches the mode. Pressing the VALUE knob while holding down the VOLUME knob switches you to the Edit mode.

9. CATEGORY/BANK Knob

Used to switch the sound selection range.

In the Edit mode, it is used to select the parameter to be set. For more information about the CATEGORY/BANK knob's functions in Edit mode, refer to the EDIT PARAMETER SELECT chart on the XV-2020's top panel.

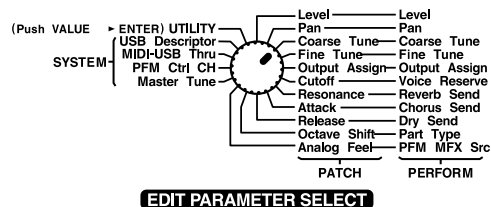

10. POWER Switch

Pressed to switch the power on and off.

Rear Panel

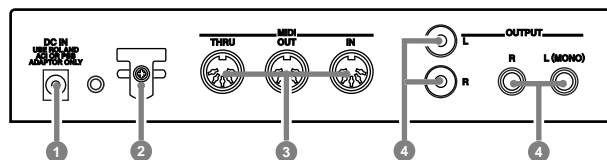

1. AC Adaptor Jack

Accepts connection of the supplied AC adaptor.

2. Cord Hook

To prevent the inadvertent disruption of power to your unit (should the plug be pulled out accidentally), and to avoid applying undue stress to the AC adaptor jack, anchor the power cord using the cord hook.

3. MIDI Connectors (IN, OUT, THRU)

These connectors are used to connect the XV-2020 with other devices for sending and receiving MIDI messages.

MIDI IN: This receives information from other MIDI instruments.

MIDI OUT: This sends information from the XV-2020.

MIDI THRU: This sends out, unaltered, information received from MIDI IN.

4. OUTPUT Jacks (L (MONO), R)

These are for stereo (L/R) output of audio signals to an amp or a mixer. For monaural output, connect to the left (L) jack.

Two types of jacks are provided for the OUTPUT jacks, 1/4" phone jacks (L (MONO), R) and RCA phono jacks (L, R).

Getting Ready to Play

Attaching the Rubber Feet

If you will not be using the separately available RAD-50 rack-mount adaptor, attach the rubber feet that were supplied with the XV-2020, as shown in the figure. Use the small holes on the bottom as a guide for positioning the rubber feet when attaching them.

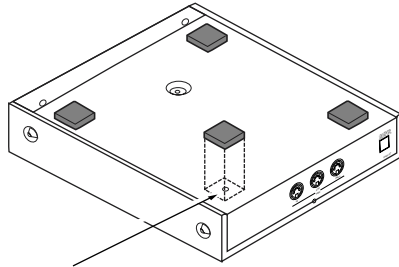

affix the supplied rubber feet onto the bottom of the unit

Installing on the Rack-Mount Adaptor

When installing on the rack-mount adaptor (RAD-50; sold separately), use the screw (M4 x 8) included with the rack-mount adaptor.

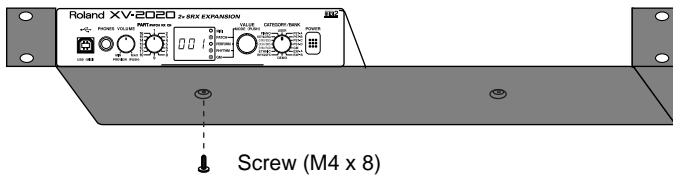

NOTE

When mounting the unit using the rack-mount adaptor, install it onto the rack-mount adaptor without attaching the rubber feet.

Connecting to MIDI Devices and Audio Equipment

The XV-2020 is not equipped with an internal amp or speakers. To hear sound, you will need to connect it to a keyboard amp or audio system, or connect headphones. Refer to the following figure when connecting the XV-2020 with external devices.

If using the XV-2020 with a computer, also refer to the following pages.

- USB connection (Windows) -> p. 13
- USB connection (Macintosh) -> p. 24
- Connection with MIDI cable -> p. 30

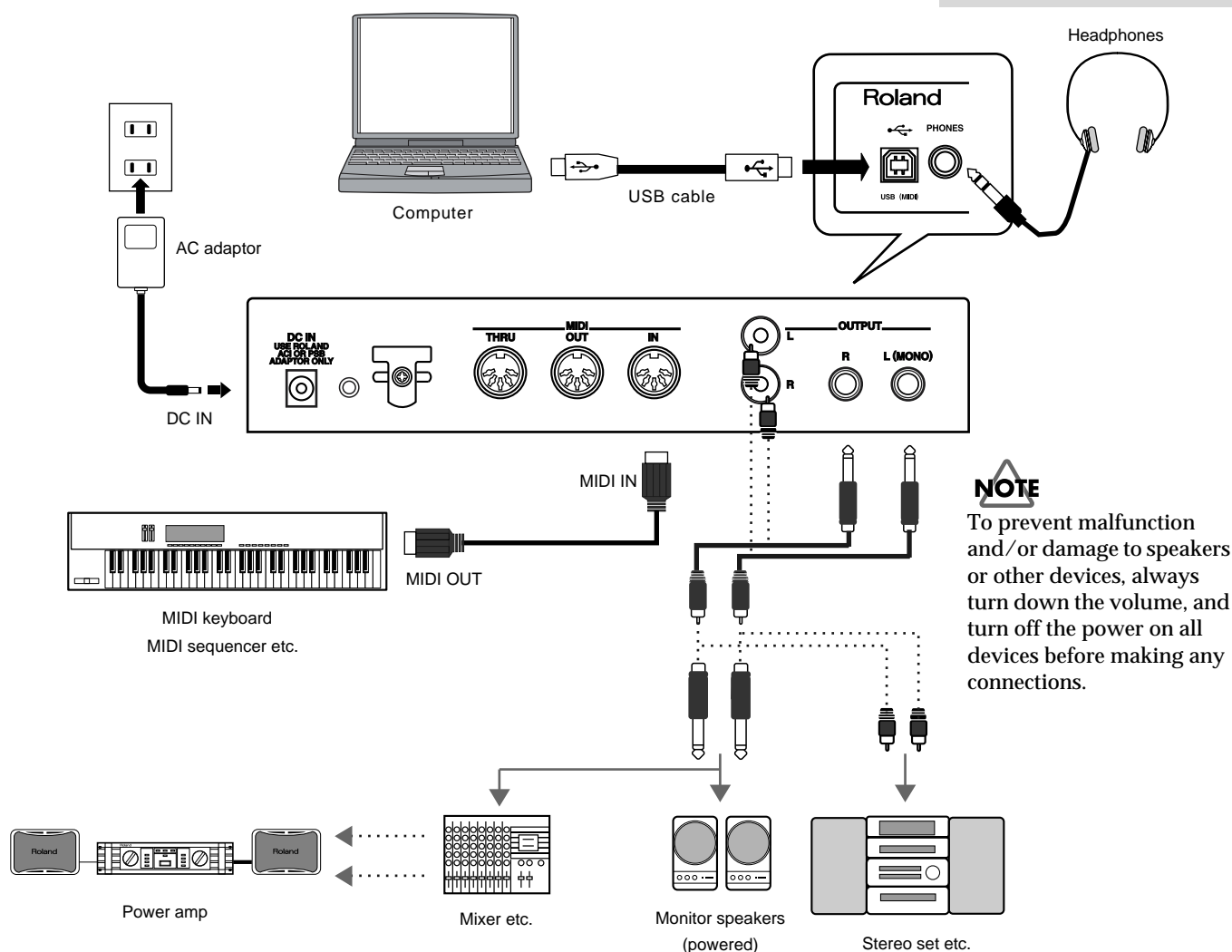

1. Before making any connections, confirm that power to all devices has been turned off.
2. Connect the included AC adaptor to the AC adaptor jack and plug the adaptor into a power outlet.
3. Connect audio and MIDI cables as shown in the diagram. If connecting headphones, plug the headphones into the PHONES jack.

MEMO

We recommend using a stereo connection in order to get the maximum performance from the XV-2020, but for monaural use, make the connection to the L (MONO) OUTPUT jack.

Turning the Power On/Off

Turning On the Power

* Once the connections have been completed (p. 11), turn on power to your various devices in the order specified. By turning on devices in the wrong order, you risk causing malfunction and/or damage to speakers and other devices.

1. Before turning on the power, confirm the following.
 - Are all devices connected properly?
 - Are the volume levels on the XV-2020 and any amp or mixer that is connected turned down to the lowest settings?
2. Press XV-2020's [POWER] to turn on the power.
3. Turn on the power to connected external devices.

Turning Off the Power

1. Before turning off the power, confirm the following.
 - Are the volume levels on the XV-2020 and any amp or mixer that is connected turned down to the lowest settings?
 - Have you saved your data, including data for any sounds you have created? (p. 92)
2. Turn off the power to connected external devices.
3. Press XV-2020's [POWER] to turn off the power.

Restoring the Factory Settings (Factory Reset)

When using the XV-2020 for the first time, start by returning the settings to their factory defaults so that the XV-2020 operates as described in the procedures in the owner's manual.

This returns all settings stored in memory in the XV-2020 to the values they had when the unit was shipped from the factory.

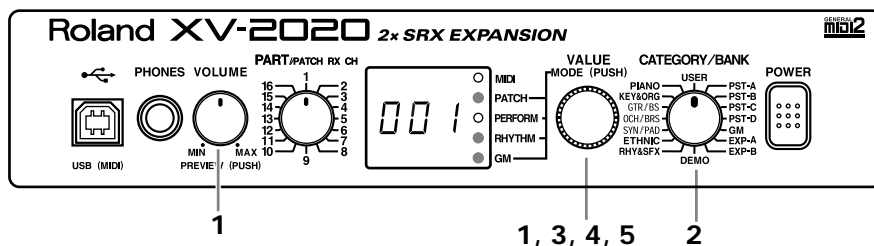

1. While holding down [VOLUME], press [VALUE].
The indication in the display begins flashing, and the mode changes.
2. Turn [CATEGORY/BANK] to choose PIANO (UTILITY).
3. Rotate [VALUE] until "Fct" appears in the display.
4. Press [VALUE]; "Sur" flashes in the display, and a confirmation screen appears.
5. Press [VALUE] once more to execute the factory reset.

* To cancel the procedure, while holding down [VOLUME] and pressing [VALUE].

NOTE

This unit is equipped with a protection circuit. A brief interval (a few seconds) after power up is required before the unit will operate normally.

NOTE

If there is important data you've created that's stored in memory, all such data is discarded, and everything is returned to the factory defaults when a Factory Reset is performed. If you have data that you want to keep, choose [Save SVD File...] from the File menu in XV Editor (included with the XV-2020). Alternatively, you could use an external MIDI device to send a message requesting all data (p. 143).

NOTE

You cannot carry out this procedure when "DEMO" is selected with the [CATEGORY/BANK] knob.

For Those Using a Computer

If you are using music software running on a computer, you can use the computer to operate the XV-2020's controls. Not only can you create and play back song data, you can also have Tones switch automatically.

What's more, you can use the included XV Editor software to create Tones using the computer.

Which type of connection?

You can either use the USB cable, or use the MIDI cable to make a MIDI connection. Depending on the type of connection you are using, install the appropriate driver and make the appropriate settings.

- USB connection (**Windows**) -> p. 13
- USB connection (**Macintosh**) -> p. 24
- Connecting with MIDI cables -> p. 30

Installing & Setup the Driver (Windows)

What is a driver?

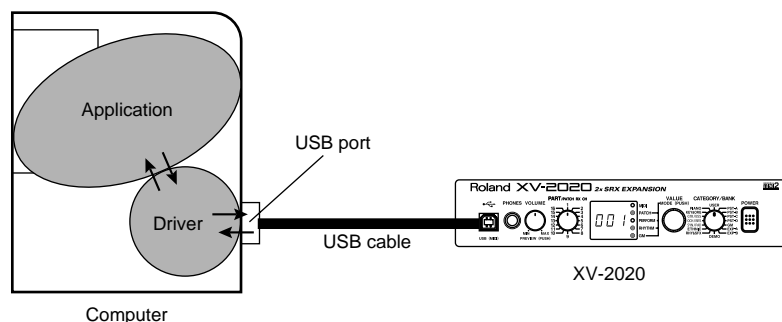

A “**driver**” is software that transfers data between the XV-2020 and application software running on your computer, when your computer and the XV-2020 are connected by a USB cable. The driver sends data from your application to the XV-2020, and from the XV-2020 to your application.

The following items are required for connections and installation. Please have the following items ready.

- XV-2020
- AC adaptor
- USB cable
- XV Editor CD-ROM

The installation procedure will differ depending on your system.

Please proceed to one of the following sections, depending on the system you use.

- Windows XP users p. 14
- Windows 2000 users p. 17
- Windows Me/98 users p. 20

Windows XP users

1. With the XV-2020 disconnected, start up Windows.
Disconnect all USB cables except for a USB keyboard and USB mouse (if used).
2. Open the **System Properties** dialog box.
 1. Click the Windows **Start** menu, and from the menu, select **Control Panel**.
 2. In “**Pick a category,**” click “**Performance and Maintenance.**”
 3. In “**or pick a Control Panel icon,**” click the **System** icon.

3. Open the **Driver Signing Options** dialog box.
Click the **Hardware** tab, and then click **[Driver Signing]**.

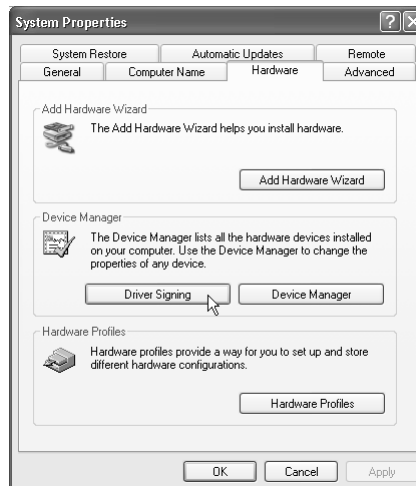

4. Make sure that “**What action do you want Windows to take?**” is set to “**Ignore.**”
If it is set to “**Ignore**”, simply click **[OK]**.
If it is not set to “**Ignore**”, make a note of the current setting (“**Warn**” or “**Block**”). Then change the setting to “**Ignore**” and click **[OK]**



5. Close the **System Properties** dialog box.
Click **[OK]**.
6. Exit all currently running software (applications).
Also close any open windows. If you are using virus checking or similar software, be sure to exit it as well.
7. Prepare the CD-ROM.
Insert the CD-ROM into the CD-ROM drive of your computer.
8. Open the “**Run...**” dialog box.
Click the Windows **start** button. From the menu that appears, select “**Run...**”

NOTE

If you are using Windows XP Professional, you must log on using a user name with an administrative account type (e.g., Administrator). For details on user accounts, please consult the system administrator of your computer.

MEMO

Depending on how your system is set up, the **System** icon may be displayed directly in the **Control Panel** (the Classic display). In this case, double-click the **System** icon.

MEMO

If you changed “**What action do you want Windows to take?**” in step 4, you must restore the previous setting after you have installed the driver. (p. 17)

MEMO

In this manual, the location of folders and files is given in terms of the file path, using \ as the delimiter. For example, **XV-2020\SETUPINF.EXE** indicates the **SETUPINF.EXE** file found in the **XV-2020** folder.

9. In the dialog box that appears, input the following into the “Open” field, and click [OK].
E:\Win2000\XV-2020\SETUPINF.EXE
** The drive name “E:” may be different for your system. Specify the drive name of your CD-ROM drive.*

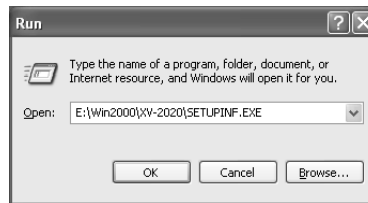

10. The **SetupInf** dialog box will appear.
 You are now ready to install the driver.
** Do not click [OK] at this time.*

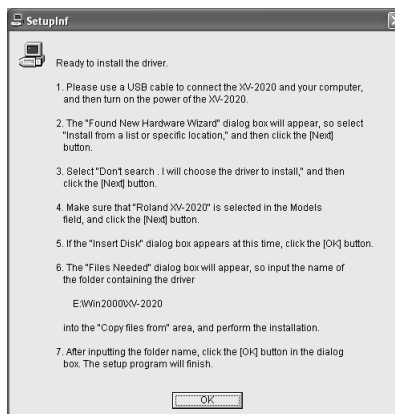

11. Connect the XV-2020.
 1. With the XV-2020’s power switch turned off, connect it to the AC adaptor.
 2. Plug the AC adaptor into an AC power outlet.
 3. Use the USB cable to connect the XV-2020 to your computer.

12. Set the XV-2020’s power switch to the ON position.
 Near the task bar, your computer will indicate “**Found New Hardware.**” Please wait.

13. The **Found New Hardware wizard** will appear.
 Make sure that the screen indicates “**ROLAND XV-2020,**” select “**Install from a list or specific location (Advanced),**” and click [Next].



14. The screen will indicate “**Please choose your search and installation options.**”
 Select “**Don’t search. I will choose the driver to install,**” and click [Next].



MEMO

If a message of “**The driver is already installed**” appears, you can connect the XV-2020 to your computer and use it.

MEMO

This unit is equipped with protection circuit. A brief interval (a few seconds) after power up is required before the unit will operate normally.

For Those Using a Computer

15. Make sure that the “**Model**” field indicates “**ROLAND XV-2020**,” and click [**Next**]. Driver installation will begin.



16. The **Insert Disk** dialog box will appear. Click [**OK**].

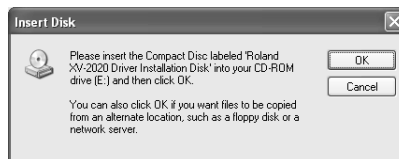

17. The **Files Needed** dialog box will appear. In the “**Copy files from**” area, type “**E:\Win2000XV-2020**” and click [**OK**].

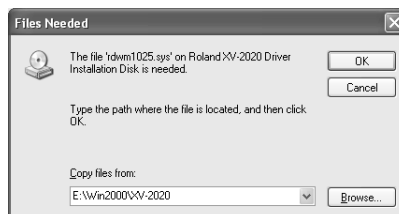

18. The **Found New Hardware wizard** will appear. Make sure that the display indicates “**ROLAND XV-2020**,” and click [**Finish**]. Wait until “**Found New Hardware**” appears near the taskbar.

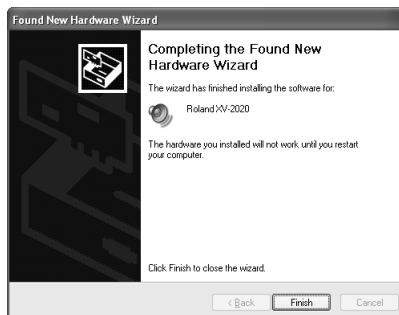

19. Restart Windows.

When driver installation has been completed, the **System Setting Change** dialog box will appear. Click [**Yes**].

If you changed “What action do you want Windows to take?”

If you changed the What action do you want Windows to take? setting in **step 4**, restore the original setting after Windows restarts.

1. If you are using Windows XP Professional, log on to Windows using the user name of an **administrative account** (e.g., Administrator).
2. Click the Windows **start** menu, and from the menu, select **Control Panel**.
3. In “**Pick a category**,” click “**Performance and Maintenance**.”
4. In “**or pick a Control Panel icon**,” click the **System** icon. The **System Properties** dialog box will appear.
5. Click the **Hardware** tab, and then click [**Driver Signing**]. The **Driver Signing Options** dialog box will appear.
6. Return the **What action do you want Windows to take?** setting to the original setting (either “**Warn**” or “**Block**”), and click [**OK**].
7. Click [**OK**]. The **System properties** dialog box will close.

If in step 4 the “What action do you want Windows to take?” setting was not set to “Ignore”, a “Digital signature not found” dialog box will appear.

If “What action do you want Windows to take?” is set to “Warn,”

1. Click [Continue Anyway].
2. Continue the installation.



If “What action do you want Windows to take?” is set to “Block”

1. Click [OK].
2. When the “Found New Hardware Wizard” appears, click [Finish].
3. Perform the installation as described in the “Troubleshooting” section on Device Manager shows “?”, “!”, or “USB Composite Device” (p. 114).



Next, you need to make the driver settings. -> **Settings and checking** (p. 21)

Windows 2000 users

1. With the XV-2020 disconnected, start up Windows.
Disconnect all USB cables except for a USB keyboard and USB mouse (if used).
2. Log on to Windows as a user with administrative privileges (such as Administrator).
3. Open the **System Properties** dialog box.
Click the Windows **Start** button, and from the menu that appears, select **Settings | Control Panel**. In **Control Panel**, double-click the **System** icon.
4. Open the **Driver Signing Options** dialog box.
Click the **Hardware** tab, and then click [Driver Signing].

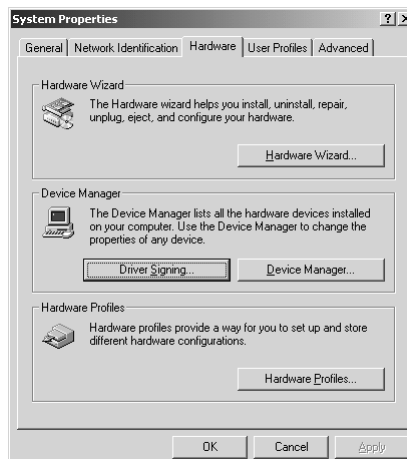

For Those Using a Computer

5. Make sure that “File signature verification” is set to “Ignore.”
If it is set to “Ignore”, simply click [OK].
If it is not set to “Ignore”, make a note of the current setting (“Warn” or “Block”). Then change the setting to “Ignore” and click [OK].



6. Close the **System Properties** dialog box.
Click [OK].

7. Exit all currently running software (applications).

Also close any open windows. If you are using virus checking or similar software, be sure to exit it as well.

8. Prepare the CD-ROM.

Insert the CD-ROM into the CD-ROM drive of your computer.

9. Open the “Run...” dialog box.

Click the Windows **Start** button. From the menu that appears, select “Run...”

10. In the dialog box that appears, input the following into the “Open” field, and click [OK].

E:\Win2000\XV-2020\SETUPINF.EXE

* The drive name “E:” may be different for your system. Specify the drive name of your CD-ROM drive.

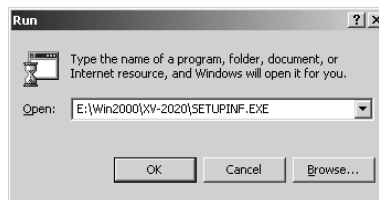

11. The **SETUPINF** dialog box will appear.
You are now ready to install the driver.

* Do not click [OK] at this time.

12. Connect the XV-2020.

1. With the XV-2020's power switch turned off, connect it to the AC adaptor.
2. Plug the AC adaptor into an AC power outlet.
3. Use the USB cable to connect the XV-2020 to your computer.

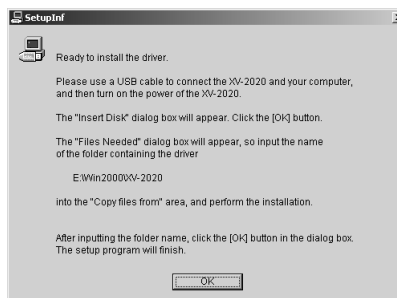

13. Set the XV-2020's power switch to the ON position.

14. The **Insert Disk** dialog box will appear.
Click [OK].

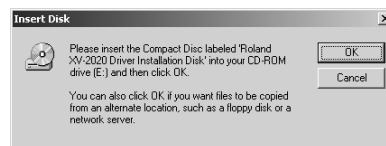

MEMO

If you changed the “File signature verification” setting in step 5, restore the original setting after Windows restarts. (p. 19)

MEMO

In this manual, the location of folders and files is given in terms of the file path, using \ as the delimiter. For example, **XV-2020\SETUPINF.EXE** indicates the **SETUPINF.EXE** file found in the **XV-2020** folder.

MEMO

This unit is equipped with protection circuit. A brief interval (a few seconds) after power up is required before the unit will operate normally.

NOTE

If the Insert disk dialog box does not appear, please read The **The “Insert Disk” dialog box does not appear** (p. 114)

15. The **Files Needed** dialog box will appear.

In the **“Copy files from”** area, type **“E:\Win2000\XV-2020”** and click **[OK]**.

* *The drive name **“E:”** may be different for your system. Specify the drive name of your CD-ROM drive.*

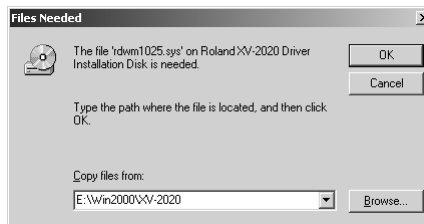

16. The **“Found New Hardware Wizard”** may be displayed.

Verify that **“ROLAND XV-2020”** is displayed, and click **[Finish]**.

17. Restart Windows.

The **System Settings Change** dialog box may appear. Click **[Yes]**. Windows will restart automatically.

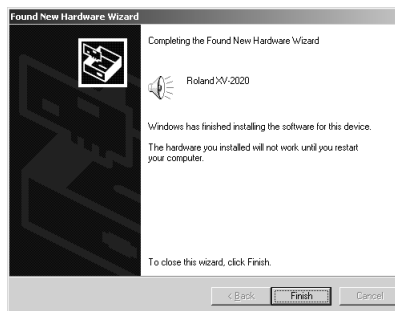

If in step 5 the **“File signature verification”** setting was not set to **“Ignore”**, a **“Digital signature not found”** dialog box will appear.

If **“File signature verification”** is set to **“Warn,”**

1. Click **[Yes]**.
2. Continue the installation.



If **“File signature verification”** is set to **“Block”**

1. Click **[OK]**.
2. When the **“New hardware detection wizard”** appears, click **[Finish]**.
3. Perform the installation as described in the **“Troubleshooting”** section on **Device Manager** shows **“?”**, **“!**”, or **“USB Composite Device”** (p. 114).



If you changed “File signature verification”

If you changed the “File signature verification” setting in **step 5**, restore the original setting after Windows restarts.

1. After Windows restarts, log in to Windows as a user with **administrative privileges**, (such as Administrator).
2. In the Windows desktop, right-click the **My Computer** icon, and from the menu that appears, select **Properties**. The **System Properties** dialog box will appear.
3. Click the **Hardware** tab, and then click **[Driver signature]**. The **Driver Signing Options** dialog box will appear.
4. Return the “File signature verification” setting to the original setting (either “Warn” or “Block”), and click **[OK]**.
5. Click **[OK]**. The **System properties** dialog box will close.

Next, you need to make the driver settings.

-> **Settings and checking** (p. 21)

Windows Me/98 users

1. With the XV-2020 disconnected, start up Windows.
Disconnect all USB cables except for a USB keyboard and USB mouse (if used).
2. Exit all currently running software (applications).
Also close any open windows. If you are using virus checking or similar software, be sure to exit it as well.
3. Prepare the CD-ROM.
Insert the CD-ROM into the CD-ROM drive of your computer.
4. Open the “Run...” dialog box.
Click the Windows **Start** button.
From the menu that appears, select “Run...”

5. In the dialog box that appears, input the following into the “Open” field, and click **[OK]**.
E:\Win98\XV-2020\SETUPINF.EXE

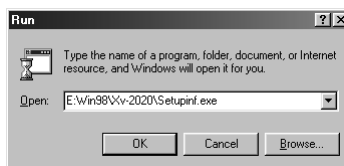

* The drive name “E:” may be different for your system. Specify the drive name of your CD-ROM drive.

6. The **SETUPINF** dialog box will appear.
You are now ready to install the driver.

* Do not click **[OK]** at this time.

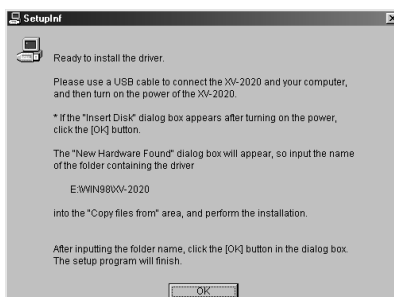

MEMO

In this manual, the location of folders and files is given in terms of the file path, using \ as the delimiter. For example, **Win98\SETUPINF.EXE** indicates the **SETUPINF.EXE** file found in the **Win98** folder.

7. Connect the XV-2020.
 1. With the XV-2020's power switch turned off, connect it to the AC adaptor.
 2. Plug the AC adaptor into an AC power outlet.
 3. Use the USB cable to connect the XV-2020 to your computer.
8. Set the XV-2020's power switch to the **ON** position.

9. If you are using Windows 98, an **Insert Disk** dialog box will appear.
Click **[OK]**.

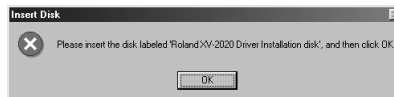

10. The **New Hardware Found** dialog box will appear.
In the **"Copy files from"** area, type **"E:\Win98\XV-2020"** and click **[OK]**.

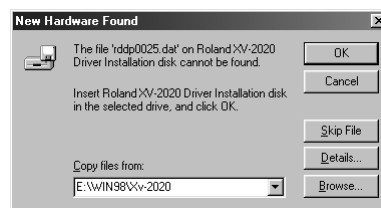

11. Once the driver has been installed, **New Hardware Found** dialog box will close.
In the **SETUPINF** dialog box, click **[OK]**. The **SETUPINF** dialog box will close.

Next, you need to make the driver settings. -> **Settings and checking (p. 21)**

Settings and checking

Specifying the Output Destination for MIDI Data

Windows XP/2000/Me users

1. Open **Control Panel**.
Click the Windows **Start** button, and from the menu that appears, select **Settings | Control Panel**.
 - **Windows XP**
Click the Windows **start** button, and from the menu that appears, select **Control Panel**.
2. Open the **Sounds and Multimedia Properties** dialog box (or in Windows XP, **Sounds and Audio Devices Properties**).
 - **Windows 2000/Me**
In **Control Panel**, double-click the **Sounds and Multimedia** icon to open the **"Sounds and Multimedia Properties"** dialog box.
 - **Windows XP**
In **"Pick a category,"** click **"Sound, Speech, and Audio Devices."** Next, in **"or pick a Control Panel icon,"** click the **sounds and Audio Devices** icon.

MEMO

This unit is equipped with a protection circuit. A brief interval (a few seconds) after power up is required before the unit will operate normally.

NOTE

If you are using Windows 98 and the **Insert Disk** dialog box does not appear, please read The **"Insert Disk"** dialog box does not appear (p. 114).

NOTE

If the **New Hardware Found** dialog box does not appear, re-install the driver using the same procedure as described in The **"Insert Disk"** dialog box does not appear (p. 114).

For Those Using a Computer

3. Click the **Audio** tab.
4. For **MIDI music playback**, click the ▼ located at the right of **[Preferred device]** (or in Windows XP, **[Default device]**), and select the **ROLAND XV-2020**.
5. Click **OK** to complete the settings.

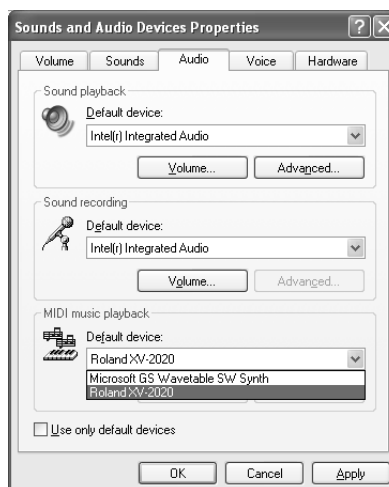

Proceed to the following page.

- Windows XP users -> **Enabling background services** (p. 23)
- Windows 2000/Me users -> The settings are completed.

Windows 98 users

1. Open **Control Panel**.
Click the Windows **Start** button, and from the menu that appears, select **Settings | Control Panel**.
2. Open the **Multimedia Properties** dialog box.
In **Control Panel**, double-click the **Multimedia** icon to open the “**Multimedia Properties**” dialog box.
3. Click the **MIDI** tab.
4. Set “**MIDI output.**”
Select **[Single instrument]**, and choose the **ROLAND XV-2020**.
5. Click **OK** to complete the settings.

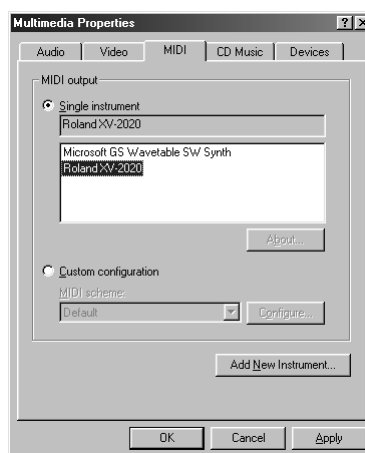

The settings are completed.

Enabling background services

In Windows XP, perform these settings to make MIDI processing occur more smoothly. These settings are unavailable in Windows 2000/Me/98.

1. Click the Windows **start** button, and from the menu that appears, select **Control Panel**.
2. In “**Pick a category,**” click “**Performance and Maintenance.**”
3. In “**or pick a Control Panel icon,**” click the **System** icon.
4. Click the **Advanced** tab.
5. At the right of the Performance field, click [**Settings**]. The **Performance Options** dialog box will appear.
6. Click the **Advanced** tab.
7. In the **Processor Scheduling** field, select “**Background services,**” and click [**OK**].
8. In the **System Properties** dialog box, click [**OK**].

The **System Properties** dialog box will close.

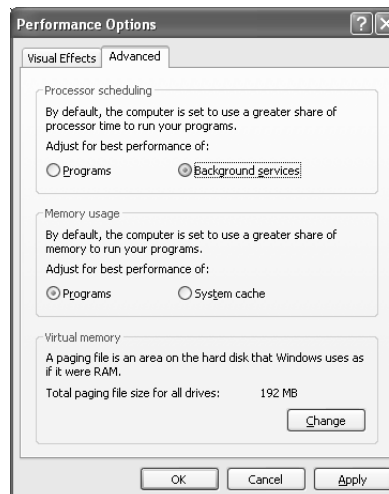

Deleting the USB MIDI Driver

If you were not able to install the XV-2020 driver according to the procedure, or if you are unable to use the XV-2020 even after installing the driver, you must delete the driver.

After deleting the driver, use the procedure described in “**Installing & Setup the Driver (Windows)** (p. 13)” to re-install the driver.

For details on how to delete the driver, refer to the explanation provided in the on-line manual within the XV Editor CD-ROM.

- **Windows XP/2000 users**

In the XV Editor CD-ROM folder Win2000, open the README_E.HTM file and read “To uninstall.”

- **Windows 98 / Me users**

In the XV Editor CD-ROM folder Win98, open the README_E.HTM file and read “To uninstall.”

Installing & Setup the Driver (Macintosh)

What is a driver?

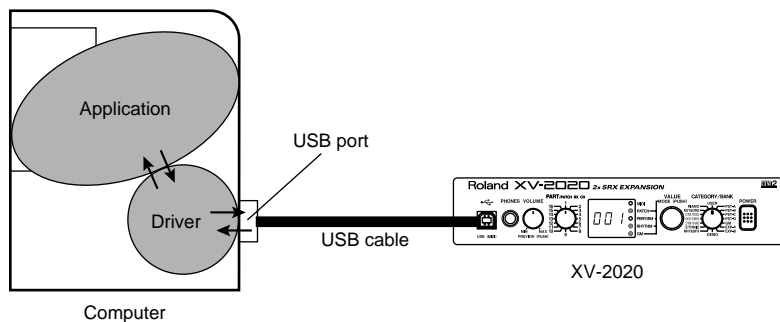

A “**driver**” is software that transfers data between the XV-2020 and application software running on your computer, when your computer and the XV-2020 are connected by a USB cable. The driver sends data from your application to the XV-2020, and from the XV-2020 to your application.

The following items are required for connections and installation. Please have the following items ready.

- XV-2020
- AC adaptor
- USB cable
- XV Editor CD-ROM

1. Turn off the power of the Macintosh and all peripheral devices connected to the Macintosh.
2. With the XV-2020's power switch turned off, connect it to the AC adaptor.
3. Plug the AC adaptor into an AC power outlet.
4. Use the USB cable to connect the XV-2020 to your computer.
5. Turn on the peripheral devices connected to the Macintosh, except for the XV-2020. Then turn on the power of the Macintosh itself.

* *Do not turn on the power of the XV-2020 at this time.*

If the power of the XV-2020 is turned on, a message like the following will appear when the Macintosh is started up. Perform the steps described below as appropriate for the message that is displayed.

If the screen indicates:

“Driver required for USB device `unknown device` is not available. Search for driver on the Internet?”

-> click [Cancel].

If the screen indicates:

“Software required for using device `unknown device` cannot be found. Please refer to the manual included with the device, and install the necessary software.”

-> click [OK].

Use either **OMS** or **FreeMIDI** as the MIDI driver.

- **If you are using OMS** (p. 25)
- **If you are using FreeMIDI** (p. 28)
- * *Either **OMS** or **FreeMIDI** must be installed in your Macintosh, as appropriate for the sequencer software you are using.*
- * *Install **OMS** if using the XV Editor software included with the unit.*

Installing the XV-2020 driver (OMS)

Use the following procedure to install the XV-2020 driver.

The included **XV-2020 OMS driver** is an add-on module for using the XV-2020 with OMS. In order for you to use it, **OMS must already be installed on the hard disk from which you started up.**

If you would like to learn more about OMS, refer to **OMS_2.3_Mac.pdf** (online manual) in the **OMS2.3.8** folder within the **OMS** folder of the CD-ROM.

* *Disconnect the XV-2020 from the Macintosh before you perform the installation.*

1. Exit all currently running software (applications).
If you are using a virus checker or similar software, be sure to exit this as well.
2. Prepare the CD-ROM.
Insert the CD-ROM into the CD-ROM drive.
3. Double-click the **OMS-E** icon (found in the **XV-2020** folder - **XV Driver E** folder of the CD-ROM) to start up the installer.
4. Verify the **installation location**, and click [Install].



MEMO

OMS can be found in the **OMS2.3.8** folder within the **OMS** folder of the CD-ROM.

MEMO

About detailed information for OMS, refer to the Owner's Manual of OMS.

MEMO

You will need the Adobe Acrobat Reader in order to view **OMS_2.3_Mac.pdf**. The latest version of Adobe Acrobat Reader can be downloaded from the Adobe website.
<http://www.adobe.com>
(This URL may change without notice.)

For Those Using a Computer

5. If a message like the following is displayed, click **[Continue]**.
The other currently running applications will exit, and installation will continue.



6. A dialog box will indicate **Installation completed**. Click **[Restart]** to restart your Macintosh.
7. Use the USB cable to connect the XV-2020 to your computer.
 1. With the XV-2020's power switch turned off, connect it to the AC adaptor.
 2. Plug the AC adaptor into an AC power outlet.
 3. Use the USB cable to connect the XV-2020 to your computer.
8. Set the XV-2020's power switch to the ON position.

OMS settings

1. Use the USB cable to connect the XV-2020 and your Macintosh.

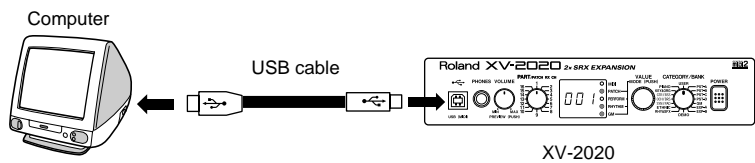

2. Double-click the "OMS Setup" icon.



3. If the "Apple Talk" dialog box appears, click **[Turn It Off]**.
Then, in the dialog box that appears next, click **[OK]**.

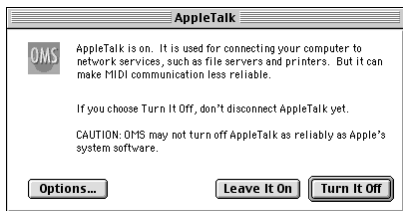

4. The "Create a New Studio setup" dialog box appears. Click **[OK]**.



MEMO

This unit is equipped with a protection circuit. A brief interval (a few seconds) after power up is required before the unit will operate normally.

NOTE

To prevent malfunction and/or damage to speakers or other devices, always turn down the volume, and turn off the power on all devices before making any connections.

MEMO

If you are using the XV-2020 with a sequencer, do not disconnect the MIDI cable connected to the XV-2020 while a song is playing back.

MEMO

If the "Create a New Studio setup" dialog box does not appear, click **[New Studio setup]** in the **[File]** menu.

- The "OMS Driver Search" dialog box appears.
Click [Search].

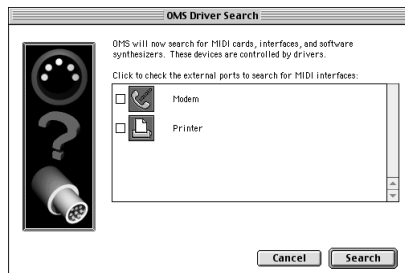

- After the search has been completed, make sure that "Roland XV-2020" is listed in the "OMS Driver Setup" dialog box, and click [OK].

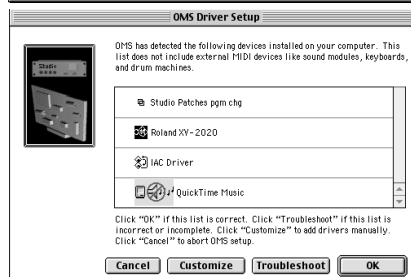

- After making sure that the XV-2020 is listed in the "OMS MIDI Device Setup" dialog box, click the check box for XV-2020, and click [OK].

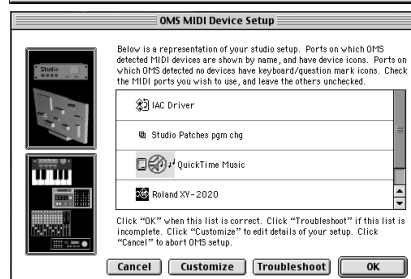

- Change the name of the keyboard icon to "Port 1" or any other names except "XV-2020."

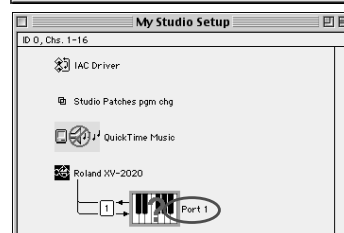

- The "Save" dialog box appears. Input the desired file name, and click [Save].



- Select [Test Studio] in the [Studio Menu] and check it in order to verify whether sound is produced.

- In the "My Studio Setup Window," click the keyboard icon.

When you move the mouse pointer near the keyboard icon, the pointer will change to the shape of an eighth note. Verify that you can hear sound from your XV-2020.

- After you have finished the above check, exit OMS Setup. This completes driver settings.



This completes connections for the XV-2020 and Macintosh, and installation of the MIDI driver. Now, MIDI data can be input and output (recorded and played).

Installing the XV-2020 driver (FreeMIDI)

Use the following procedure to install the XV-2020 driver. The included **XV-2020 FreeMIDI driver** is an add-on module for using the XV-2020 with FreeMIDI. In order to use it, **FreeMIDI must be installed on the hard disk from which you started up.**

- * *Exit all applications before you begin installing the driver.*
- * *Install OMS if using the XV Editor software included with the unit.*
- * *The **XV-2020 FreeMIDI Driver** included on the disc is provided as an additional module that allows the XV-2020 to be used with FreeMIDI. In order to use it, **FreeMIDI must already be installed on the start-up hard disk.***
- * *Disconnect the XV-2020 from the Macintosh before beginning the installation.*

- 1.** Exit all currently running software (applications).
If you are using a virus checker or similar software, be sure to exit this as well.
- 2.** Prepare the CD-ROM.
Insert the CD-ROM into the CD-ROM drive.
- 3.** Double-click the **FM-E** icon (found in the **XV-2020** folder - **XV Driver E** folder of the CD-ROM) to start up the installer.
- 4.** Verify the installation location, and click **[Install]**.
- 5.** If a message like the following is displayed, click **[Continue]**.
The other currently running applications will exit, and installation will continue.
- 6.** A dialog box will indicate Installation completed. Click **[Restart]** to restart your Macintosh.
- 7.** Use the USB cable to connect the XV-2020 to your computer.
 1. With the XV-2020's power switch turned off, connect it to the AC adaptor.
 2. Plug the AC adaptor into an AC power outlet.
 3. Use the USB cable to connect the XV-2020 to your computer.
- 8.** Switch **ON** the XV-2020's Power switch.

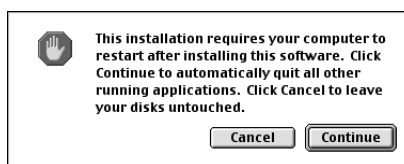

NOTE

This unit is equipped with a protection circuit. A brief interval (a few seconds) after power up is required before the unit will operate normally.

FreeMIDI settings

1. Use the USB cable to connect the XV-2020 and your Macintosh.

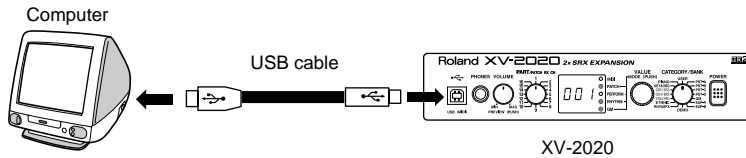

* If using a computer that is not equipped with a USB connector, refer to p. 30.

2. Open the “FreeMIDI Applications” folder, and double-click the “FreeMIDI Setup” icon.



3. The first time FreeMIDI is started up, a “Welcome to FreeMIDI!” dialog box will appear. Click [Continue].
If this is the second or later time, select “FreeMIDI Preferences” from the File menu.

4. In the “FreeMIDI Preferences” dialog box, check “XV-2020 Port” which is located below XV-2020 Driver in MIDI Configuration, and click [OK].

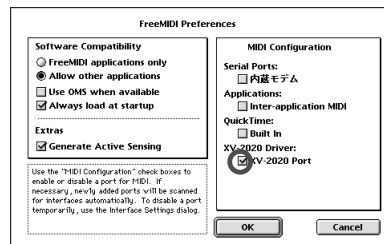

5. The About Quick Setup dialog box appears. Click [Continue].

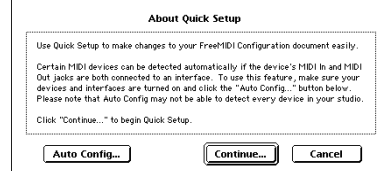

6. In the dialog box that appears, select the “XV-2020” in “Studio Location,” and click [>>>Add>>].

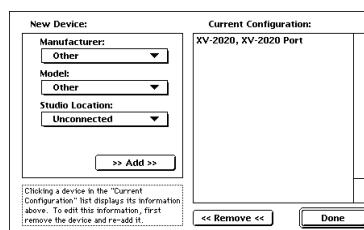

7. When settings are complete, click [Done].
A setting window like the following appears.

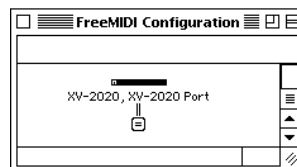

8. From the File menu, select [Save], and save your settings.

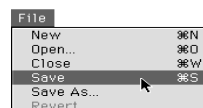

This completes connections for the XV-2020 and Macintosh, and installation of the MIDI driver. Now, MIDI data can be input and output (recorded and played).



To prevent malfunction and/or damage to speakers or other devices, always turn down the volume, and turn off the power on all devices before making any connections.



If you are using the XV-2020 with a sequencer, do not disconnect the MIDI cable connected to the XV-2020 while a song is playing back.



There will be a version number following “FreeMIDI Setup” as the actual icon name.



If the dialog box does not show “XV-2020 Driver,” check whether the XV-2020 is connected correctly, and start up FreeMIDI Setup once again.



If the “About Quick Setup” dialog box is not displayed, select “Quick Setup...” from the “Configuration” menu.

Connecting with MIDI Connectors

A MIDI interface is required for making MIDI connections with a computer. The MIDI interface is connected to the computer, and two MIDI cables connect the MIDI connectors of the MIDI interface to the XV-2020's MIDI connectors.

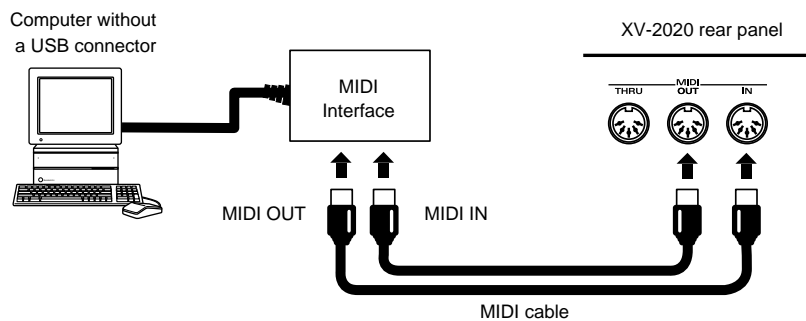

Installing the Included Editor Software

To help you get more out of your XV-2020, it comes with XV Editor software. Use XV Editor to freely create your own original sounds.

Detailed instructions on installing the software can be found in the online manual contained on the XV Editor CD-ROM.

- **Windows users**

In the XV Editor CD-ROM, open the Readme_E.txt.

- **Macintosh users**

In the XV Editor CD-ROM, open the ReadMe.

About Patches and Performances

On the XV-2020, sounds are organized according to units called **Tones**, **Patches**, **Rhythm Sets**, and **Performances**. This section describes the relationship between a Patch and a Performance.

What is a Patch?

The type of sound most commonly played on the XV-2020 is called a **Patch**. A Patch is a combination of **Tones**, which are the smallest units of sound. Each Patch can contain up to four Tones. If we use the analogy of an orchestra, then Patches are the musical instruments of the performers.

* For information on Tones, see p. 44.

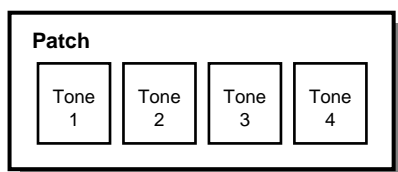

* You can turn the Tones in a Patch on or off. Only Tones that are turned on are heard when you play the Patch (p. 45).

What is a Performance?

It may be easiest to think of a **Performance** as being the orchestra itself.

To continue the orchestra analogy, a Performance is made up of the parts assigned to the respective instruments (called, naturally enough, "Parts"). You can enjoy ensemble play by combining a total of 16 Patches or Rhythm Sets into one such Part.

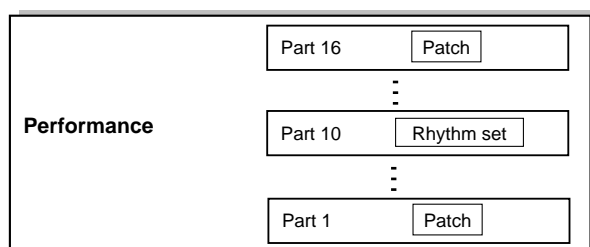

In other words, a Performance allows you to produce sixteen separate sounds with a single XV-2020.

If You're Playing Back Song Data Using an External MIDI Instrument or Sequencing Program

Now let's select an XV-2020 Performance and play back some song data!

Press [VALUE] on the XV-2020 a number of times until the "PERFORM" indicator lights up; you can now select the Performance (Performance Mode, p. 39, p. 70).

* The Patch mode (p. 39) is selected by default. Please be aware that if you try to play song data while in the Patch mode, only the sound of one Part is played.

<MEMO>

Quick Start

Playing Sounds

The XV-2020 comes with a rich palette of onboard sounds, called **Patches**. Let's listen to some Patches in Patch mode.

Playing Patches (Phrase Preview)

Even when there's no MIDI keyboard or sequencer connected, the XV-2020 allows you to audition sounds.

1. Press [VALUE] to make the PATCH indicator lights up.

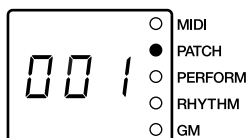

2. Press and hold down [VOLUME].

The Patch plays while [VOLUME] is depressed.

At this time, the currently selected bank USr (USER) and the patch number appear in alternation on the display.

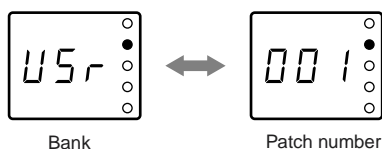

3. Rotate [VALUE] to reselect the Patch, and check out the sounds of other patches.

Playing a Patch on the XV-2020 from an External MIDI Device (MIDI Keyboard)

The XV-2020 produces sound in response to MIDI messages it receives from an external MIDI device such as a MIDI keyboard or sequencer.

Try connecting your MIDI keyboard and playing sounds on the XV-2020.

Connecting the MIDI Keyboard

Connect the MIDI keyboard as shown in the following.

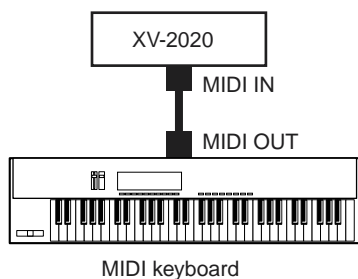

Matching MIDI Channels

In order for the XV-2020 to respond to MIDI data sent by an external MIDI device, both devices must be set to use the same MIDI channel or channels.

Here, in Patch mode, let's set both devices so that they use MIDI Channel 1.

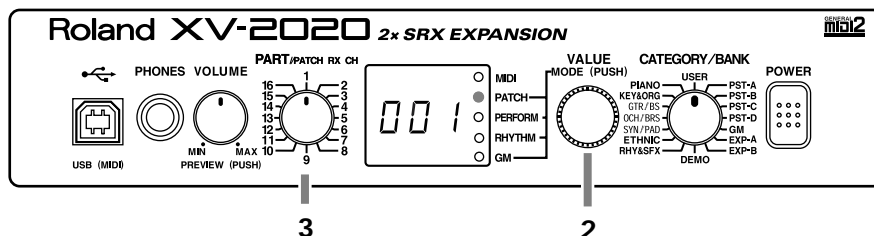

1. Set the send channel of the MIDI keyboard to "1."

Refer to the keyboard's owner's manual for instructions.

2. Press [VALUE] to make the PATCH indicator lights up.

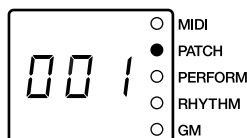

* Immediately after Factory Reset is executed, the Receive channel is set to the channel selected with the [PART] knob.

3. Turn [PART] to choose "1."

Here, 1 becomes the XV-2020's receive channel.

4. Play the MIDI keyboard to hear the currently selected XV-2020 Patch.

MIDI message indicator will lights when a MIDI message is received via MIDI connector or USB connector.

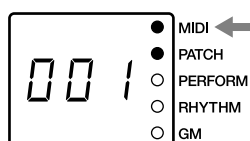

Choosing Patches

You can use either of two methods to choose a patch: choosing by **bank** (display with white text) or choosing by **category** (display in blue text).

Choosing Patches by Bank

Although the XV-2020 contains many Patches, these are organized into eight banks. You can easily switch banks and select Patches using [CATEGORY/BANK].

Playing Sounds

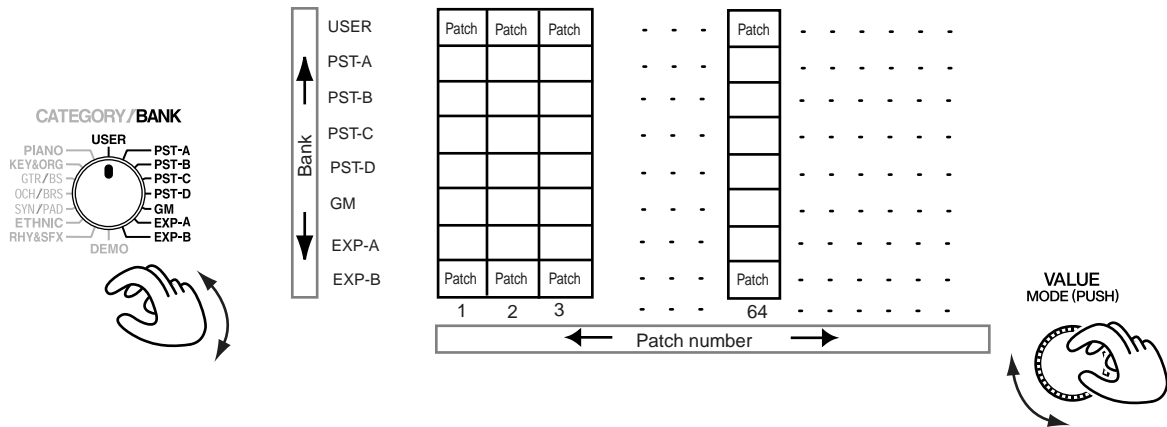

Bank	page	Description
USER	p. 124	There are 128 patches stored in memory, which you can overwrite with patches you create yourself.
PSTA/B/C/D (PRESET)	p. 125	There are 512 patches (with 128 Patches in a single bank) stored in memory, which cannot be overwritten
GM (General MIDI)	p. 129	These are patches for the General MIDI System, which is designed to standardize the specifications for MIDI functions for all manufacturers and models. There are 128 patches stored in memory, which cannot be overwritten.
EXP-A/B	---	These are banks for use with Wave Expansion Boards installed in the slots. Patches are stored in memory on the separately available Wave Expansion Board, and cannot be overwritten.

Procedure

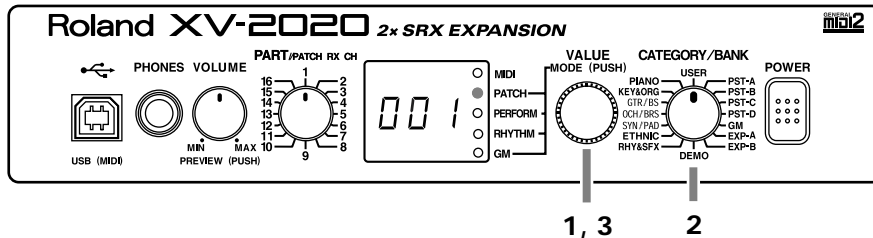

1. Press [VALUE] to make the PATCH indicator lights up.
Press the knob several times, until the PATCH indicator lights up.
2. Turn [CATEGORY/BANK] to choose the bank (USER, PST-A/B/C/D, GM, EXP-A/B)

3. Turn [VALUE] to choose a Patch.

* You can listen to the selected patch sound by holding down [VOLUME]. At this time, the currently selected preset bank USr (USER) and the patch number appear in alternation on the display.

NOTE

You cannot select EXP-A or EXP-B unless a Wave Expansion Board is installed into the corresponding slot.

MEMO

Turning [VALUE] rapidly makes the value change in large increments.

Choosing Patches by Category

On the XV-2020, Patches are grouped into **categories**, such as “piano” and “guitar.” You can easily change to the category you like and select Patches with the [CATEGORY/BANK] knob.

Procedure

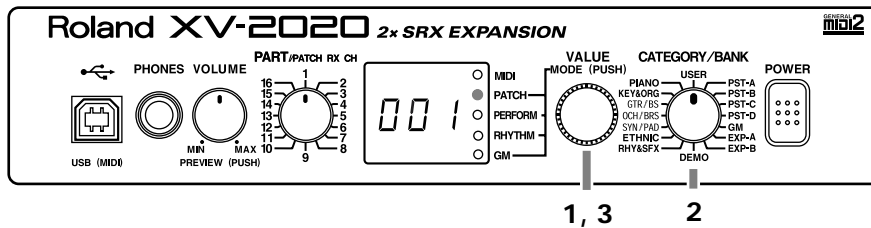

1. Press [VALUE], so the PATCH indicator lights up
Press [VALUE] several times, until the PATCH indicator lights up.
2. Rotate the [CATEGORY/BANK] knob to select the Patch category group.

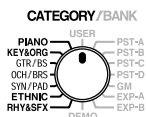

3. Turn [VALUE] to choose the Patch.

* You can listen to the selected patch sound by holding down [VOLUME].
At this time, the currently selected bank and the patch number appear in alternation on the display.

You can select the following categories.

Category Group	XV Editor Display	Category	Contents
PIANO	PNO	AC.PIANO	Acoustic Piano
	EP	EL.PIANO	Electric Piano
KEY&ORGAN	KEY	KEYBOARDS	Other Keyboards (Clav, Harpsichord, etc.)
	BEL	BELL	Bell, Bell Pad
	MLT	MALLET	Mallet
	ORG	ORGAN	Electric and Church Organ
	ACD	ACCORDION	Accordion
	HRM	HARMONICA	Harmonica, Blues Harp
	GTR/BS	AGT	AC.GUITAR
EGT		EL.GUITAR	Electric Guitar
DGT		DIST.GUITAR	Distortion Guitar
BS		BASS	Acoustic and Electric Bass
SBS		SYNTH BASS	Synth Bass
OCH/BRS	STR	STRINGS	Strings
	OCH	ORCHESTRA	Orchestra Ensemble
	HIT	HIT&STAB	Orchestra Hit, Hit
	WND	WIND	Winds (Oboe, Clarinet, etc.)
	FLT	FLUTE	Flute, Piccolo
	BRS	AC.BRASS	Acoustic Brass
	SBR	SYNTH BRASS	Synth Brass
	SAX	SAX	Sax

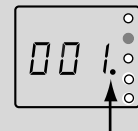

The indicator at the lower right of the patch number lights up when the first patch in any category is called up.



When you select a category group, the Patches are shown in the order PST-A-D, GM, EXP-A, EXP-B, and USER.



Turning the [VALUE] rapidly makes the value change in large increments. Also, you can go to the first patch of each category by pressing in [VALUE] while you rotate it.

Playing Sounds

Category Group	XV Editor Display	Category	Contents
SYN/PAD	HLD	HARD LEAD	Hard Synth Lead
	SLD	SOFT LEAD	Soft Synth Lead
	TEK	TECHNO SYNTH	Techno Synth
	PLS	PULSATING	Pulsating Synth
	FX	SYNTH FX	Synth FX (Noise, etc.)
	SYN	OTHER SYNTH	Poly Synth
	BPD	BRIGHT PAD	Bright Pad Synth
	SPD	SOFT PAD	Soft Pad Synth
	VOX	VOX	Vox, Choir
ETHNIC	PLK	PLUCKED	Plucked (Harp, etc.)
	ETH	ETHNIC	Other Ethnic
	FRT	FRETTED	Fretted Inst (Mandolin, etc.)
RHYTHM&SFX	PRC	PERCUSSION	Percussion
	SFX	SOUND FX	Sound FX
	BTS	BEAT&GROOVE	Beat and Groove
	DRM	DRUMS	Drum Set
	CMB	COMBINATION	Other Patches which use Split and Layer

Choosing a Performance

The collected assignment of Patches or Rhythm Sets to the XV-2020's sixteen Parts is referred to as a "Performance."

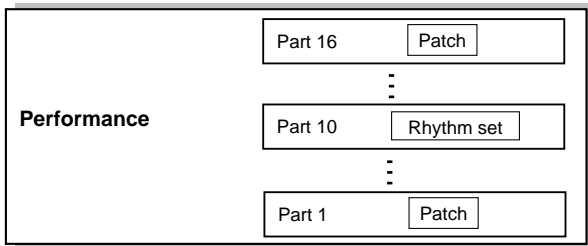

Selecting Performances and Parts

1. Press [VALUE], so the PERFORM indicator lights up.
* Only the PERFORM indicator should be lit.
2. Turn [VALUE] to choose the Performance.
3. Rotate [PART] to change the Part for the currently selected Performance.
* Rotating [PART] while in Performance Play mode switches you to Performance Part Play mode.



Performances can only be selected when the [CATEGORY/BANK] knob is pointed at either USER, PST-A, or PST-B. So, if you're unable to switch Performances, check the position of the knob.

Assigning a New Patch to a Part

Here's how to change the Patch assigned to a Part in a Performance.

1. Press [VALUE] a number of times until both the PERFORM and the PATCH indicators light up.
2. Turn [PART] to choose the part.
3. Rotate [CATEGORY/BANK] to switch the bank, then rotate [VALUE] to select the Patch.

Switching the Mode (Patch, Performance)

The XV-2020's parameters are organized into ten different modes. You can easily switch modes using the [VALUE] knob or [VOLUME] knob.

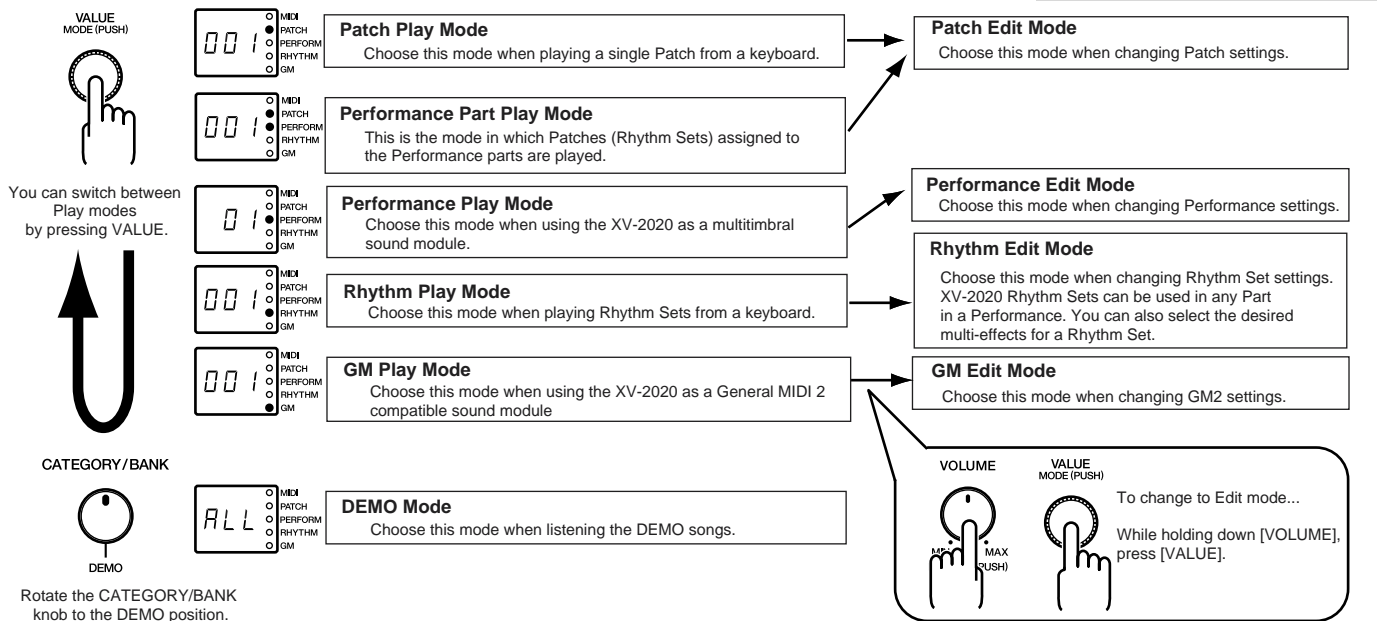

- * Rotating [PART] while in Performance Play mode switches you to Performance Part Play mode.
- * The Patch, Performance, or Rhythm Set in use when the power was last turned off is automatically called up again the next time you turn on the power.

In Edit mode, select the parameters to be edited with the [CATEGORY/BANK] knob. For more on the parameters, refer to the EDIT PARAMETER SELECT table on the XV-2020's upper panel.

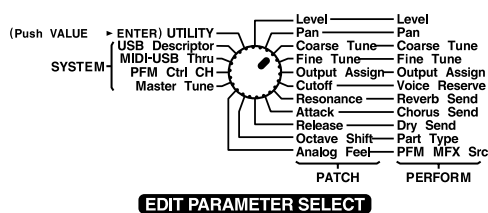

General MIDI is a set of recommendations that standardizes the MIDI capabilities of sound modules. Sound modules and music files that adhere to the General MIDI standard bear the General MIDI logo (). Music files bearing the General MIDI logo can be played back using any General MIDI sound module with essentially the same musical results.

The upwardly compatible General MIDI 2 () recommendations pick up where General MIDI leaves off, offering enhanced expressive capabilities and even greater compatibility.

Issues not covered by the original General MIDI standard - such as how sounds are to be edited, and how effects should be handled - are precisely defined in General MIDI 2. Moreover, the available sounds have been expanded. General MIDI 2 compliant sound modules are capable of reliably playing back music files that carry either the General MIDI or General MIDI 2 logo. In some cases, the conventional form of General MIDI, which does not include the new enhancements, is referred to as "General MIDI 1" as a way of distinguishing it from General MIDI 2.

Using an External MIDI Device to Select Patches and Change Other Settings

Selecting Patches and Rhythm Sets

You can change Patches – including the Patches in each Part of a Performance – and Rhythm Sets on the XV-2020 via MIDI Part.

In this example, after setting the send channel for the external MIDI device and the XV-2020's reception channel (Patch Rx Channel p. 35) to "1," we'll send a MIDI message from the external MIDI device to select the XV-2020 Patch "PB018 (Preset B, No.18"

1. Use a MIDI cable to connect the MIDI OUT connector on the external MIDI device to the XV-2020's MIDI IN connector.
2. Press [VALUE] to make the PATCH indicator lights up.
The XV-2020 reverts to Patch play mode.
3. Set the channel used for transmission by the external MIDI device and the XV-2020's reception channel to the same MIDI channel (see p. 94).
** Immediately after Factory Reset is executed, the Receive channel is set to the channel selected with the [PART] knob.*
4. Send a Bank Select MSB (Control Number 0) value of "87" to the XV-2020.
** If you want to select a Rhythm Set, send a value of "86."*
5. Next, send a Bank Select LSB (Control Number 32) value of "65."
6. Send a Program Change with a value of "18."
The Patch number appearing in the display changes to "18."
Each Patch or Rhythm Set has a corresponding Bank Select number and Program number, as shown below.

Patches		Bank Select number		Program number
Bank	Number	MSB	LSB	
USER	001-128	87	00	001-128
PST-A (PRESET A)	001-128	87	64	001-128
PST-B (PRESET B)	001-128	87	65	001-128
PST-C (PRESET C)	001-128	87	66	001-128
PST-D (PRESET D)	001-128	87	67	001-128
GM (GM2)	001-256	121	0-	001-128
EXP-A (EXPENSION A)	001-	93	0-	001-
EXP-B (EXPENSION B)	001-	93	0-	001-

Rhythm Sets		Bank Select number		Program number
Bank	Number	MSB	LSB	
USER	001-004	86	00	001-004
PST-A (PRESET A)	001-004	86	64	001-004
PST-B (PRESET B)	001-004	86	65	001-004
GM (GM2)	001-009	120	00	001-057
EXP-A (EXPENSION A)	001-	92	0-	001-
EXP-B (EXPENSION B)	001-	92	0-	001-

Selecting Performances

To switch Performances, after matching the send channel for the external MIDI device with the XV-2020's Performance Control channel (p. 94), send the Bank Select number and Program Change messages.

Upon execution of Factory Reset, Performance Ctrl-Ch is set to "16." Here, set the external MIDI device's send channel to "16," then try switching the Performance to "PB029 (Preset B, No.29)".

- 1. Use a MIDI cable to connect the MIDI OUT connector on the external MIDI device to the XV-2020's MIDI IN connector.**

- 2. Press [VALUE] to make the PERFORM indicator lights up.**

The XV-2020 reverts to Performance play mode.

- 3. Set the external MIDI device's send channel to "16."**

For instructions on making this setting, refer to the owner's manual for the external MIDI device.

- 4. Send a Bank Select MSB (Control Number 0) with a value of "85" to the XV-2020.**

- 5. Next, send a Bank Select LSB (Control Number 32) with a value of "65."**

- 6. Send a Program Change with a value of "29."**

The Performance number appearing in the display changes to "29."

Each Performance has a corresponding Bank Select number and Program number, as shown below.

Performances		Bank Select number
Bank	Number	MSB
USER	001-064	85
PST-A (PRESET A)	001-032	85
PST-B (PRESET B)	001-032	85

<MEMO>

Advanced Use

Using the XV Editor software included with the XV-2020 together with your computer gives you more control in editing parameters, and even greater freedom in creating sounds.

You cannot edit every parameter using the XV-2020 alone. For details regarding the parameters that you can edit using only this device, refer to the “**List of Parameters That Can Be Affected Using the XV-2020** (p. 117).”

Connecting the XV-2020 to your computer with a USB cable requires installation of the USB driver.
-> “**For Those Using a Computer** (p. 13)”

For more on installing XV Editor -> Refer to p. 30.

The mode indicators change from solidly lit to flashing whenever a parameter is edited. If you turn off the power or choose another Patch (Rhythm set/Performance) while the indicator is blinked, your new Patch (Rhythm set/Performance) settings will be lost. If you wish to preserve them, save the changed settings using the Write operation. (p. 92)

Creating a Patch

How a Patch Is Organized

The type of sound most commonly played on the XV-2020 is called a **Patch**. Each Patch can contain up to four Tones.

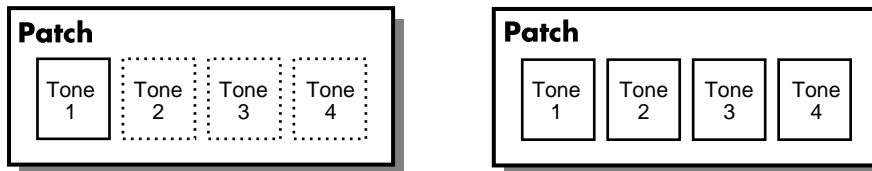

Example 1: A Patch consisting of only one Tone (Tones 2–4 are turned off).

Example 2: A Patch consisting of four Tones.

You can turn the Tones in a Patch on or off. Only Tones that are turned on are heard when you play the Patch. (p. 45)

You can also set the structure of a Patch to specify how Tones 1 and 2 and Tones 3 and 4 are combined. (p. 48)

How a Tone Is Organized

Tones are the smallest programmable unit of sound on the XV-2020, and are the basic building blocks that make up a Patch. You can't play a Tone by itself—it can only be played as part of a Patch or Rhythm Set. A Tone consists of the following five components.

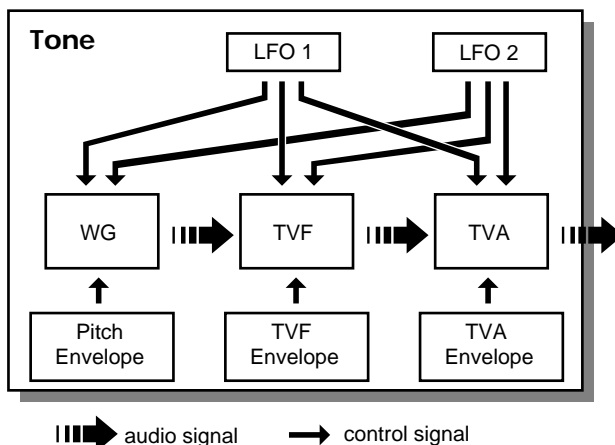

WG (Wave Generator)

This selects the PCM waveform material that provides the basis of the Tone. Two waveforms can be assigned to each Tone.

The XV-2020 has 1083 different waveforms. (See Waveform List p. 121.)

All Patches built into the XV-2020 consist of combinations of Tones based on these waveforms.

TVF (Time Variant Filter)

This specifies how the frequency components of the Tone change.

TVA (Time Variant Amplifier)

This determines how the volume and panning of the Tone change.

Envelope

An envelope applies changes to the Tone over time. There are separate envelopes for pitch, TVF (filter) and TVA (volume). For example, you would use the TVA Envelope to modify the way in which the Tone attacks and decays.

LFO (Low Frequency Oscillator)

Use the LFO to create cyclical changes—or cyclical “modulation”—in a Tone. Each Tone has two LFOs. An LFO can be applied to the Tone’s pitch settings, TVF (filter), and TVA (volume). When an LFO is applied to pitch, a vibrato effect is produced. When an LFO is applied to the TVF cutoff frequency, a wah-wah effect is produced. When an LFO is applied to the TVA volume, a tremolo effect is produced.

Tips for Creating a Patch

- **Choose a Patch that’s similar to the sound you wish to create.**
When you want to create a new sound, it’s a good idea to begin with a Patch that’s close to the sound that you have in mind. Starting with a Patch that bears no resemblance to the one you want to create is likely to result in much more programming work for you. (p. 35)
- **Decide which Tones will sound**
When creating a Patch, it’s important to decide which Tones you want to use. It’s also important to turn off unused Tones to avoid wasting voices, unnecessarily reducing the number of simultaneous notes you can play. (p. 45)
- **Check the way in which the Tones are combined**
Structure Type 1&2 and 3&4 are important parameters that determine how the four Tones are combined. Before you select new Tones, make sure you understand how the currently selected Tones are affecting each other. (p. 48)
- **Turn off effects**
Since the XV-2020 effects have such a profound impact on its sounds, turn off a Patch’s effects during programming so you can more clearly hear the changes you’re making. Actually, sometimes just changing effects settings can give you the sound you want. (p. 76)

Choosing the Tones That Sound (Tone On/Off)

Here’s how to turn on the Tones that you want to hear in a Patch. You can also use the on/off technique described in this section to audition an individual Tone by turning off all the other Tones in a Patch. When using the editing software included with the XV-2020, make the settings in the following screen.



Confirming Tones

You can confirm Tones you have selected by pressing the VOLUME knob (p. 34). You can also confirm the Tones using the Tone editor (XV editor) included with the unit.

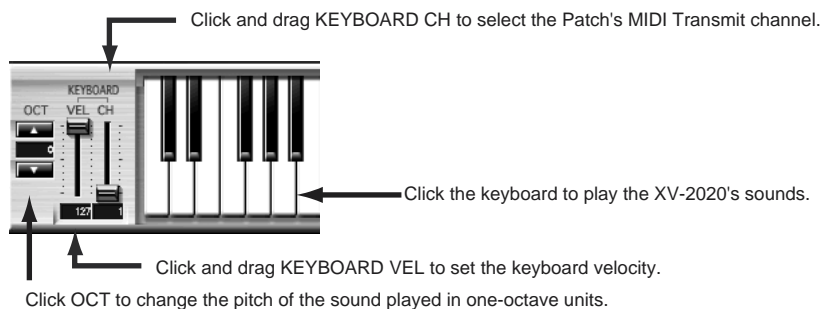

The PATCH indicator change from solidly lit to flashing whenever a parameter is edited. If you turn off the power or choose another Patch while the indicator is blinked, your new Patch settings will be lost. If you wish to preserve them, save the changed settings using the Write operation. (p. 92)

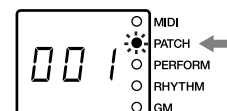

Patch Parameter

Tone-Related Settings

Parameter	Value	Description
TONE SWITCH	OFF, ON	Here's how to turn on the Tones that you want to hear in a Patch. You can also use the on/off technique described in this section to audition an individual Tone by turning off all the other Tones in a Patch.
TONE SELECT	OFF, ON	Selects the Tone to be edited.

PATCH COMMON (Settings Common to the Entire Patch)

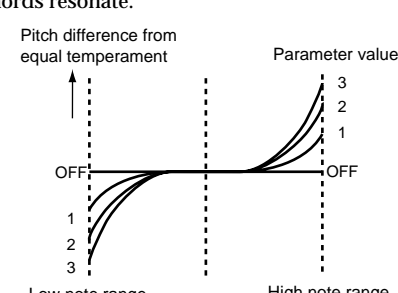
Parameter	Value	Description
PATCH NAME	space, A-Z, a-z, 0-9, ! " # \$ % & ' () * + , - . / : ; < = > ? @ [\] ^ _ `	You can give a Patch a name of up to 12 characters. When using the XV editor, click ► on the left side to name the Tone.
CATEGORY (Patch Category)	PIANO, KEY&ORG, GTR/BS, OCH/BRS, SYN/PAD, ETHNIC, RHY&SFX	Specifies the type, or "category" of the Patch. The Patch Finder uses this setting.
LEVEL (Patch Level)	0-127	Specifies the volume of the Patch. * You can specify the level of each Tone in a Patch using the Tone Level parameter (TVA p. 59).
PAN (Patch Pan)	L64-63R	Sets the stereo position of the Patch. L64 pans the Patch all the way to the left, 0 is center and 63R pans it hard right. * You can specify the pan setting for each Tone in a Patch using the Tone Pan parameter (TVA p. 60). * While each Tone in a Patch has its own Pan position, the Patch pan setting shifts the entire Patch—including all of its Tones—leftward or rightward
OUTPUT ASSIGN	MFX, A, 1, 2, TONE	Specifies the output destination for the Patch. MFX: Sends the Patch into the Multi-Effects. The output destination is determined by the Multi-Effects output setting. A: Output from OUTPUT. 1: Output from L. 2: Output from R. TONE: Sends each Tone in the Patch to its programmed output destination.
OCTAVE SHIFT	-3-+3	Sets the pitch of the Patch in units of an octave.
COARSE TUNE	-48-+48	Adjusts the pitch of all of the Patch's Tones simultaneously in semitone steps over a range of +/-4 octaves.
FINE TUNE	-50-+50	Adjusts the pitch of all of the Patch's Tones simultaneously in 1-cent steps (1/100th of a semitone) over a range of 1/2 semitones up or down.
STRETCH TUNE DEPTH	OFF, 1, 2, 3	This setting allows you to apply "stretch tuning" to the Patch. Acoustic pianos typically use stretch tuning, with their lower range slightly flatter and their higher range slightly sharper than the actual mathematical tuning ratios dictate. Stretch is therefore useful when programming a Patch intended to sound like a real piano. With a setting of OFF, the Patch's tuning is equal temperament. A setting of 3 produces the greatest difference in the pitch of the low and high ranges. This diagram shows the pitch change relative to equal temperament that occurs in the low and high ranges. Stretch has a subtle effect on the way in which chords resonate. 

Parameter	Value	Description
ANALOG FEEL (Analog Feel Depth)	0-127	Specifies the depth of Analog Feel that is applied to the Patch. Traditional analog synthesizers often exhibited a degree of instability in their tuning. The XV-2020's Analog Feel feature can simulate this characteristic.
CLOCK SOURCE (Patch Clock Source)	PATCH, SYSTEM	Selects the timing reference to be used by the Patch. The LFO cycle, M-FX changes, phrase loop (break beats), and Tone delay time can be synchronized to a clock, or tempo. PATCH: Uses the Patch Tempo. SYSTEM: Uses the global System Tempo or clock messages received from an external sequencer.
TEMPO (Patch Tempo)	20-250	Establishes the Patch's tempo when Clock Source is set to "PATCH." <i>* Clock messages for the Patch Tempo are not transmitted from the MIDI OUT connector.</i>
CUTOFF OFFSET	-63-+63	Simultaneously lowers or raises the individual TVF cutoff frequency values of the Tones in the Patch.
RES OFFSET (Resonance Offset)	-63-+63	Simultaneously lowers or raises the individual TVF Resonance values of the Tones in the Patch.
ATTACK TIME OFFSET	-63-+63	Simultaneously lowers or raises the individual TVA ENVELOPE T1 values of the Tones in the Patch.
RELEASE TIME OFFSET	-63-+63	Simultaneously lowers or raises the individual TVA ENVELOPE T4 values of the Tones in the Patch.
VELOCITY SENS OFFSET	-63-+63	Simultaneously lowers or raises the individual TVF VELOCITY V-Cutoff and TVA V-Sens values of the Tones in the Patch.
PRIORITY (Voice Priority)	LAST, LOUDEST	Determines how notes are managed when the XV-2020's maximum polyphony limit is exceeded (64 voices). LAST: Gives priority to the last-played voices. Currently-sounding notes are turned off in order, beginning with the first-played note. LOUDEST: Gives priority to the voices with the loudest volume. Currently-sounding notes are turned off beginning with the lowest-volume voice.
MONO/POLY (Key Mode Assign)	MONO, POLY	Sets how the Patch's notes are played. The MONO setting is effective when playing a solo instrument Patch such as sax or flute. MONO: Only one note sounds at a time POLY: Two or more notes can be played simultaneously.
LEGATO SW (Legato Switch)	OFF, ON	Turn this parameter on when you want to use the Legato feature and off when you don't. Legato is a function that works only when the Key Assign Mode is MONO. When Legato is ON, pressing one key when another is already pressed causes the currently playing note's pitch to change to that of the newly pressed key while continuing to sound. This can be effective when you wish to simulate performance techniques such as a guitarist's hammering on and pulling off strings.
LEGATO RETRIGGER	OFF, ON	The setting determines whether sounds are replayed or not when performing legato. Normally you will leave this parameter "ON." When Delay Key follow is set to OFF, if one key is pressed while another key is held down, only the pitch changes, which with some waveforms may result in an unnatural sound. Set this to "OFF" when performing wind and string phrases or when using modulation with the mono synth keyboard sound. <i>* If the Legato Switch is "OFF," this setting is ignored.</i>
PITCH BEND RANGE UP	0-48	Specifies the pitch change that occurs when the Pitch Bend lever is moved fully to the right (or up on some MIDI controllers).
PITCH BEND RANGE DOWN	-48-0	Specifies the amount of pitch change that's applied to the Patch's pitch when the Pitch Bend lever is moved fully left (or down on some MIDI controllers).
PORTAMENTO SW (Portamento Switch)	OFF, ON	Portamento is a function that causes the Patch's pitch to change smoothly from one note to the next note played. When the Key Mode Assign is MONO, this can be effective in simulating performance techniques such as a violinist's glissando. Turn this switch on when you wish to use.
PORTAMENTO MODE	NORMAL, LEGATO	Chooses the way in which Portamento is applied. NORMAL: Portamento is always applied. LEGATO: Portamento is applied only for notes played legato (i.e., when you press a second key before releasing the first.)
PORTAMENTO TYPE	RATE, TIME	Determines the way in which the pitch difference between the two notes affects the time it takes to glide from one note to the next. RATE: The time it takes depends on the distance between the two pitches. TIME: The time it takes is constant, regardless of how far apart in pitch the notes are.

Creating a Patch

Parameter	Value	Description
PORTAMENTO START	PITCH, NOTE	Portamento begins anew if you press another key during a pitch movement. This setting specifies how the new portamento starts. PITCH: The pitch begins changing immediately to the new note's pitch when its key is pressed. NOTE: The pitch begins changing to the new note's pitch only after it has first reached its original pitch destination.
PORTAMENTO TIME	0-127	Sets the time over which one pitch glides to the next.

PATCH STRUCTURE

Parameter	Value	Description	
TYPE (Structure Type 1&2, 3&4)	1-10	Determines how Tone 1 and 2, and Tone 3 and 4 are connected. <i>* If Type 2-10 is selected, turning off one Tone will cause the other Tone to be connected in the simple order of WG/TVF/TVA.</i> The displayed symbols have the following meanings. B: Booster, R: Ring Modulator	
<div style="display: flex; justify-content: space-between;"> <div style="width: 45%;"> <p>TYPE 1</p> </div> <div style="width: 45%;"> <p>TYPE 2</p> </div> </div> <div style="display: flex; justify-content: space-between;"> <div style="width: 45%;"> <p>TYPE 3</p> </div> <div style="width: 45%;"> <p>TYPE 4</p> </div> </div> <div style="display: flex; justify-content: space-between;"> <div style="width: 45%;"> <p>TYPE 5</p> </div> <div style="width: 45%;"> <p>TYPE 6</p> </div> </div> <div style="display: flex; justify-content: space-between;"> <div style="width: 45%;"> <p>TYPE 7</p> </div> <div style="width: 45%;"> <p>TYPE 8</p> </div> </div> <div style="display: flex; justify-content: space-between;"> <div style="width: 45%;"> <p>TYPE 9</p> </div> <div style="width: 45%;"> <p>TYPE 10</p> </div> </div>	<p>BOOSTER (Booster Gain 1&2, 3&4)</p>	0, +6, +12, +18 dB	Sets the Booster strength when Structure Type has been set to 3 or 4.

[What is a Booster?]
 A Booster amplifies the incoming signal, causing it to distort. This creates an effect similar to the distortion often used on an electric guitar.

[What is a Ring Modulator?]
 A Ring Modulator mathematically multiplies two Tones, creating a new sound that includes inharmonic overtones that were not present in either of the two original Tones. Since the difference in pitch between the two Tones changes the overtone structure, an un-pitched "metallic" sound often results. Ring modulation is therefore especially suitable for creating bells and other metallic sounds.

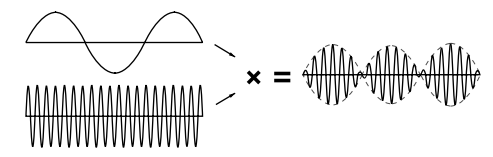

PATCH & VELOCITY KEY RANGE

PATCH VELOCITY RANGE

* Parameters that can be set independently for each Tone are indicated by “#.”

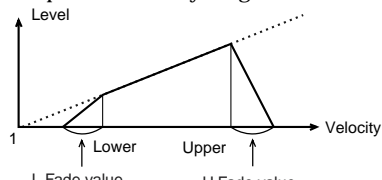
Parameter	Value	Description
VELOCITY CONTROL (TMT Velocity Control)	OFF, ON, RANDOM	Determines whether Velocity messages from a MIDI keyboard or sequencer are recognized (ON), or ignored (OFF). When set to RND, the Patch's constituent Tones sound randomly, regardless of any Velocity messages.
TMT CONTROL SW (TMT Control Switch)	OFF, ON	This setting determines whether or not the TMT is controlled by the Matrix Control. When TMT Velocity Control is set to OFF, turning this parameter on and off is a simple way to switch between playing all Tones or controlling them with the Matrix Control, making this an effective tool for auditioning Tones. [What is a TMT?] With the XV-2020, you can set each Tone's expression range, or “key range.” You can also change the way the Tone responds to the force, or “velocity,” with which a key is pressed. These settings are collectively referred to as the TMT.
FADE LOWER# (TMT Velocity Fade Width Lower)	0-127	Determines what happens to the Tone's level when the Tone is played at a velocity lower than its specified velocity range. Higher settings result in a more gradual change in volume. If you don't want notes played below the specified velocity range to be heard at all, set this to 0.
LOWER# (TMT Velocity Range Lower)	1-UPPER	Sets the lowest velocity at which the Tone sounds.
UPPER# (TMT Velocity Range Upper)	LOWER-127	Sets the highest velocity at which the Tone sounds. * It is not possible to set the Lower value higher than the Upper value, or the Upper value below the Lower value.
FADE UPPER# (TMT Velocity Fade Width Upper)	0-127	Determines what happens to the Tone's level when the Tone is played at a velocity greater than its specified velocity range. Higher settings result in a more gradual change in volume. If you don't want notes played above the specified velocity range to be heard at all, set this to 0. 

PATCH KEY RANGE

* Parameters that can be set independently for each Tone are indicated by “#.”

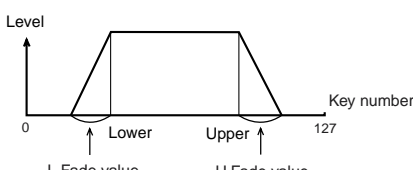
Parameter	Value	Description
FADE LOWER# (TMT Key Fade Width Lower)	0-127	Determines what happens to the Tone's level when a note that's lower than the Tone's specified keyboard range is played. Higher settings result in a more gradual change in volume. If you don't want the Tone to sound at all when a note below the keyboard range is played, set this parameter to 0.
LOWER# (TMT Key Range Lower)	C-1-UPPER	Specifies the lowest note that causes the Tone to sound.
UPPER# (TMT Key Range Upper)	LOWER-G9	Specifies the highest note that causes the Tone to sound. * The Lower value cannot be set to a value greater than Upper value, or vice versa.
FADE UPPER# (TMT Key Fade Width Upper)	0-127	Determines what happens to the Tone's level when a note that's higher than the Tone's specified keyboard range is played. Higher settings result in a more gradual change in volume. If you don't want the Tone to sound at all when a note above the keyboard range is played, set this parameter to 0. 

Creating a Patch

MATRIX CTRL (Patch Matrix Control)

This selects the parameters to be controlled by Matrix Control Source 1–4 and the Sens settings, as well as the specific Tones whose parameters you wish to control. Up to four destination parameters can be selected for each controller and controlled simultaneously.

* Parameters that can be set independently for each Tone are indicated by “#.”

Parameter	Value	Description
SOURCE1–4 (Matrix Control Source1–4)	OFF, CC01–31, CC33–95, BEND, AFTER, SYS1–4, VELOCITY, KEYFOLLOW, TEMPO, LFO1, LFO2, PIT-ENV, TVF-ENV, TVA-ENV	Assign one of the following controllers to Control Source 1–4. If you wish to use a controller that will apply to all Patches, or a controller that cannot be directly selected here, select SYS-CTRL1–4, and then select the controller using the Control Source 1–4 parameters (SYSTEM COMMON).
DESTINATION1–4 (Matrix Control Destination 1–4)	OFF, PITCH, CUTOFF, RESONANCE LEVEL, PAN, DRY LEVEL, CHORUS SEND, REVERB SEND, LFO1/2 PCH DEPTH, LFO1/2 TVF DEPTH, LFO1/2 TVA DEPTH, LFO1 PAN DEPTH, LFO1/2 RATE, PCH ENV A/D/R-TIME, TVF ENV A/D/R-TIME, TVA ENV A/D/R-TIME, TMT, FXM DEPTH, MFX-CTRL1/4	Selects a parameter to be controlled.
SENS1–4 (Matrix Control Sens 1–4)	-63–+63	Adjusts the amount of change that occurs in response to controller changes. Negative (-) values invert the change. For LFO rates, negative (-) values slow down the LFO, and positive (+) values speed it up.
TONE1–4# (Matrix Control Tone Control Switch 1–4)	OFF, ON, REV	Selects the Tone to which the two previous parameter settings are applied. “ON” turns signifies that the Tone is selected for control, “OFF” that it’s not selected, and “REV (REVERSE)” that the change being applied is inverted when applied to this Tone.

PATCH CONTROL SWITCH

These settings determine each Tone’s response to received Pitch Bend, Expression, Pan, Hold1, Damper, and Envelope Mode MIDI messages.

* Parameters that can be set independently for each Tone are indicated by “#.”

Parameter	Value	Description
RCV BENDER# (Tone Receive Bender Switch)	OFF, ON	If you want the Tone to respond to Pitch Bend messages, turn this parameter on. If not, turn it off.
RCV EXP# (Tone Receive Expression Switch)	OFF, ON	If you want the Tone to respond to Expression messages, turn this on. If not, turn it off.
RCV HOLD-1# (Tone Receive Hold 1 Switch)	OFF, ON	Set this to ON if you wish the tone to respond to Hold1 messages—these messages cause sounds to continue playing when a sustain/damper pedal is pressed. Set this to OFF when you don’t want the Tone to respond to Hold1 messages.
REDAMPER# (Tone Redamper Switch)	OFF, ON	If a Hold 1 message is received during the time between a note-off—when you release the key—and the time at which the note actually disappears, any currently sounding notes will be sustained if Redamper is set to ON. To take advantage of this feature, you must also turn on the Tone Receive Hold 1 setting.
RCV PAN MODE# (Tone Receive Pan Mode)	CONTINUOUS, KEY-ON	CONTINUOUS: Pan messages are responded to immediately, instantly changing the stereo position of the Tone. KEY-ON: The stereo location of the Tone is changed only when the next note is played. If a Pan message is received while a note is sounding, its stereo location will not change.
ENV MODE# (Tone Envelope Mode)	NO-SUS, SUSTAIN	When a loop-type waveform is selected, it normally continues to sound as long as a key is pressed. If you want a note to decay naturally even when the key remains pressed, set this to “NO-SUS.” * If a one-shot type Wave is selected, it will not sustain even if this parameter is set to “SUSTAIN.”

PATCH SCALE TUNE

One set of Scale Tune settings can be created in Patch mode.

* *The selected scale applies to MIDI messages received from an external MIDI device as well as to local sound generation.*

Parameter	Value	Description
SCALE TUNE SWITCH	OFF, ON	Turn this on when you wish to use a tuning scale other than equal temperament. The XV-2020 allows you to use temperaments other than equal temperament.
KEY C-B SCALE (Key Scale C-B)	-64+63	Adjusts the pitch of each note in one-cent steps (1/100th of a semitone) relative to its equal-tempered pitch.

- **Equal Temperament**

This scale divides an octave into 12 equal parts using the tuning system that is most widely used in Western music.

- **Pure Temperament (Tonic is C)**

With this tuning, the three fundamental chords sound richer compared to equal temperament. This effect only applies to one key, and transposition can produce less-pleasing results.

- **Arabian Scale**

In this scale, E and B are a quarter note lower, and C#, F# and G# are a quarter-note higher compared to equal temperament. The intervals between G and B, C and E, F and G#, Bb and C#, and Eb and F# have a natural third-the interval between a major third and a minor third. On the XV-2020, you can use Arabian temperament in the three keys of G, C and F.

- **Example: Tonic C**

Note name	Equal temperament	Pure (tonic C)	Arabian scale temperament
C	0	0	-6
C#	0	-8	+45
D	0	+4	-2
Eb	0	+16	-12
E	0	-14	-51
F	0	-2	-8
F#	0	-10	+43
G	0	+2	-4
G#	0	+14	+47
A	0	-16	0
Bb	0	+14	-10
B	0	-12	-49

More Advanced Editing of Tones

You can edit the Tones in a Patch with a tremendous degree of detail. Editable parameters are separated into parameter groups as follows.

- **WG**
Selecting a Waveform (p. 44)
- **LFO**
Applying Vibrato or Tremolo (p. 45)
- **TVF**
Changing the Brightness with a Filter (p. 44)
- **TVA**
Changing the Volume (p. 44)
- **MFX**
Adjusting Effect Settings (p. 76)

Tips for Choosing a Waveform

Because the XV-2020 is designed to create highly realistic sounds, the success of the editing process depends to a large degree on the PCM waveforms upon which Tones are based. Therefore, if you try to create a sound that's totally different from the waveform(s) you're working with, the desired result may be difficult or impossible to achieve.

The XV-2020's internal waveforms fall into the following two groups.

- **One-shot:** These waveforms contain sounds that have short decays. A one-shot waveform records the initial rise and fall of its sound. Some of the XV-2020's one-shot waveforms are sounds that are complete in themselves, such as percussive instrument sounds. The XV-2020 also contains many other one-shot waveforms that are elements of other sounds. These include attack components such as piano-hammer sounds and guitar fret noises.
- **Looped:** These waveforms include sounds with long decays as well as sustained sounds. With looped waveforms, the latter part of the sound plays over and over for as long as the note is held, allowing wave memory to be used more efficiently. The XV-2020's looped waveforms also include components of other sounds, such as piano-string resonant vibrations and the hollow overtones of brass instruments.

The following diagram shows an example of a sound—an electric organ—that combines one-shot and looped waveforms.

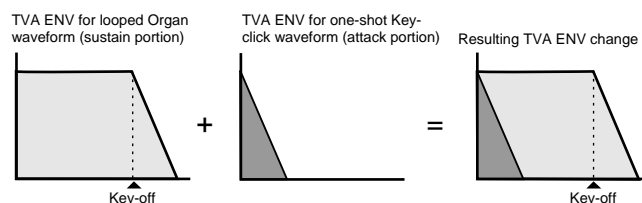

Notes for editing one-shot waveforms

You cannot give a one-shot waveform a longer decay—or make it into a sustaining sound—by using an envelope. If you were to program such an envelope, you would be attempting to shape a portion of the sound that simply doesn't exist, and the envelope would have no effect.

Notes for editing looped waveforms

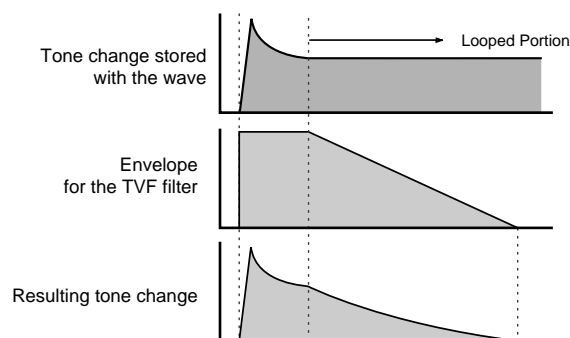

With many acoustic instruments such as piano and sax, extreme timbral changes occur during the first few moments of each note. This initial attack is what defines much of the instrument's character. The XV-2020 provides a variety of waveforms containing realistic acoustic instrument attacks. To obtain the maximum realism when using these waveforms, it's best to leave the filter wide-open during the attack so that all of these important timbral changes are heard. If you use an envelope to modify the attack portion, you may not achieve the result you want. Use enveloping to produce the desired changes in the decay portion of the sound.



If you try to make a waveform's attack seem brighter by lowering the high-frequency content of its decay using the TVF filter, consider the original timbral character of the waveform. If you're making a part of the sound brighter than the original waveform, you should first generate new upper harmonics not present in the original waveform by using the Wave FXM Color and Wave FXM Depth parameters before filtering. This will help you achieve the desired result. To make an entire waveform brighter, try applying an effect such as an enhancer and equalizer before modifying the TVF parameter.

PATCH WG (Patch Wave Group)

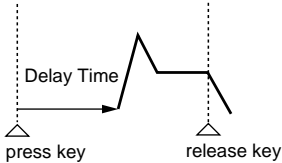
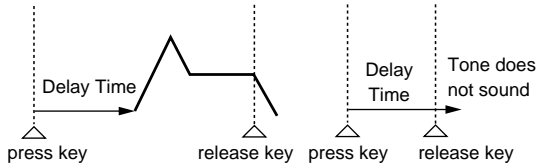
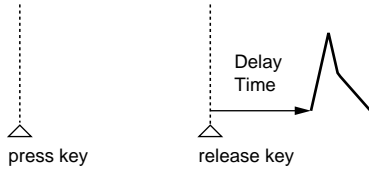
This set of parameters allows you to select the PCM waveform that serves as the basis for the currently selected Tone, apply effects to the waveform, and control its pitch.

Parameter	Value	Description																																																
WAVE GROUP (Wave Group)	INT, EXP-A, EXP-B	Chooses the desired waveform's group. INT: Internal EXP-A, B: Wave Expansion Boards A, B <i>* It's not possible to select EXP-A, B unless a wave expansion board is inserted into the corresponding slot.</i>																																																
WAVE NUMBER L (Wave Number Left)	0001-1083	Chooses the desired waveform. You can choose a separate waveform for the XV-2020's left and right channels. <i>* For monaural tones, assign a waveform to the L channel. No sound will be heard if a waveform is set for only the R channel.</i>																																																
WAVE NUMBER R (Wave Number Right)																																																		
TONE DELAY	This produces a time delay between the moment a key is pressed (or released) and the moment the Tone actually begins to sound. Since you can adjust the timing of each Tone in a Patch, you can create effects in which pressing a single key produces two or more sounds occurring at different times. If you don't wish to use Tone Delay, set Tone Dly to NORMAL and Tone Delay Time to 0.																																																	
TONE DELAY MODE	NORMAL, HOLD, KEY-OFF-NOR, KEY-OFF-DCY	Sets the manner in which the Tone sounds. <i>* If you've selected a Wave that is a decay-type sound (i.e., a sound that fades away naturally even if the key is not released), selecting KEY-OFF-NOR or KEY-OFF-DCY may result in no sound being heard.</i>																																																
	NORMAL: The Tone sounds after the specified Delay Time.	HOLD: The Tone will only sound if the key is held for longer than the specified Delay Time. If the key is released before the Delay Time has elapsed, the Tone will not sound.																																																
																																																		
KEY-OFF-NOR: The Tone doesn't sound while the key is being pressed, but sounds after the specified Delay Time when the key is released.	KEY-OFF-DCY: The Tone doesn't sound while the key is being pressed, but sounds after the specified Delay Time when the key is released. However, for this setting—unlike KEY-OFF-NOR—the TVA envelope of the Tone begins when the key is first pressed. As a result, in most cases, only the decay portion of the sound is heard.																																																	
																																																		
TONE DELAY TIME	0-127, note	Specifies the time after which the Tone sounds when using Tone Delay. When the Structure Type parameter has a setting of 2-10, the outputs of Tones 1 (3) and 2 (4) are combined with Tone 2 (4). Tone 1 (or 3) settings are ignored.																																																
<table border="1" data-bbox="167 1601 821 1848"> <tbody> <tr> <td></td> <td>Sixty-fourth-note triplet</td> <td></td> <td>Sixty-fourth note</td> <td></td> <td>Thirty-second-note triplet</td> <td></td> <td>Thirty-second note</td> </tr> <tr> <td></td> <td>Sixteenth-note triplet</td> <td></td> <td>Dotted thirty-second note</td> <td></td> <td>Sixteenth note</td> <td></td> <td>Eighth-note triplet</td> </tr> <tr> <td></td> <td>Dotted sixteenth note</td> <td></td> <td>Eighth note</td> <td></td> <td>Quarter-note triplet</td> <td></td> <td>Dotted eighth note</td> </tr> <tr> <td></td> <td>Quarter note</td> <td></td> <td>Half-note triplet</td> <td></td> <td>Dotted half note</td> <td></td> <td>Half note</td> </tr> <tr> <td></td> <td>Whole-note triplet</td> <td></td> <td>Dotted half note</td> <td></td> <td>Whole note</td> <td></td> <td>Double-note triplet</td> </tr> <tr> <td></td> <td>Dotted whole note</td> <td></td> <td>Double note</td> <td></td> <td></td> <td></td> <td></td> </tr> </tbody> </table>			Sixty-fourth-note triplet		Sixty-fourth note		Thirty-second-note triplet		Thirty-second note		Sixteenth-note triplet		Dotted thirty-second note		Sixteenth note		Eighth-note triplet		Dotted sixteenth note		Eighth note		Quarter-note triplet		Dotted eighth note		Quarter note		Half-note triplet		Dotted half note		Half note		Whole-note triplet		Dotted half note		Whole note		Double-note triplet		Dotted whole note		Double note					
	Sixty-fourth-note triplet		Sixty-fourth note		Thirty-second-note triplet		Thirty-second note																																											
	Sixteenth-note triplet		Dotted thirty-second note		Sixteenth note		Eighth-note triplet																																											
	Dotted sixteenth note		Eighth note		Quarter-note triplet		Dotted eighth note																																											
	Quarter note		Half-note triplet		Dotted half note		Half note																																											
	Whole-note triplet		Dotted half note		Whole note		Double-note triplet																																											
	Dotted whole note		Double note																																															
GAIN (Wave Gain)	-6, 0, +6, +12 dB	Specifies the gain (or amplitude) of the waveform. An increase of 6 dB doubles the waveform's gain. If you intend to use the Booster to distort the waveform's sound, set this parameter to its highest value.																																																

Creating a Patch

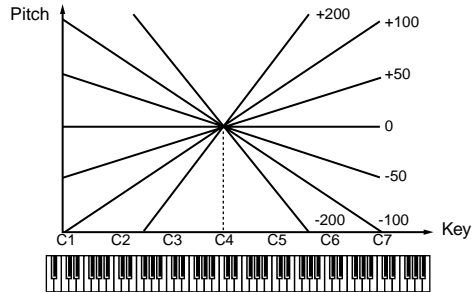
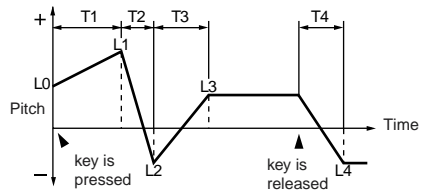
Parameter	Value	Description
FXM ON (Wave FXM Switch)	OFF, ON	Sets whether FXM will be used (ON) or not (OFF). [FXM (Frequency Cross Modulation)] FXM uses a specified waveform to apply frequency modulation to the currently selected waveform, creating complex overtones. This can be useful when creating wilder sounds or sound effects.
TEMPO SYNC (Wave Tempo Sync)	OFF, ON	Determines whether the waveform is synchronized (ON) or not synchronized (OFF) to the Patch's tempo.
FXM COLOR (Wave FXM Color)	1-4	Specifies how FXM will perform its frequency modulation. Higher settings result in a grainier sound, while lower settings result in a more metallic sound.
FXM DEPTH (Wave FXM Depth)	0-16	Specifies the depth of the modulation produced by FXM.
COARSE TUNE (Tone Coarse Tune)	-48--+48	Adjusts the pitch of the Tone in semitone steps over a range of +/-4 octaves.
FINE TUNE (Tone Fine Tune)	-50--+50	Adjusts the pitch of the Tone in 1-cent steps (1/100th of a semitone) over a range of half a semitone up or down.
RANDOM PITCH (Tone Random Pitch Depth)	0-1200	Specifies the width of random pitch deviation that occurs each time a key is pressed. If you don't want a random pitch change, set this parameter to 0. The setting is adjustable in units of 1 cent (1/100th of a semitone).
PITCH KF (Wave Pitch Key follow)	-200--+200	Sets the amount of pitch change that occurs per octave on the keyboard. If you want the pitch to change by one octave for each 12 keys on the keyboard—as on traditional keyboard instruments—set this parameter to +100. For a two-octave pitch change over the span of 12 keys, set this parameter to +200. Negative (-) values cause the Tone's pitch to go down as you go up the keyboard. If you want the same pitch to sound regardless of what key is pressed, set this parameter to 0. 
PITCH ENVELOPE		<p>These parameters determine the amount of pitch enveloping—changes to your basic pitch settings that occur over time—the effect of velocity on the pitch envelope, and the basic characteristics of the pitch envelope itself.</p> 
ENV DEPTH (Pitch Envelope Depth)	-12--+12	
		Determines the amount of pitch enveloping to be used—higher settings result in more extreme enveloping. Negative (-) settings invert the direction of the changes made by the Pitch.

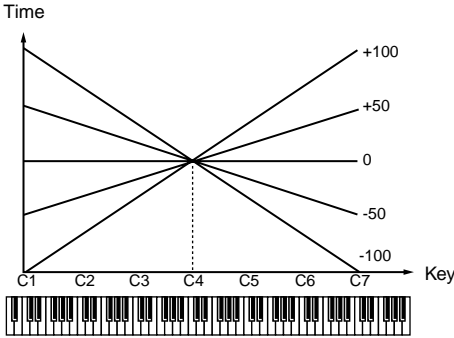
Parameter	Value	Description
ENV TIME KF (Pitch Envelope Time Key-follow)	-100--+100	Use this parameter when you want the keyboard location of notes to affect times T2–T4 of the pitch envelope. Higher values for this parameter cause more extreme changes to the T2–T4 settings as you play further away from Middle C (C4)—at Middle C itself, your original T2–T4 settings are in effect. Positive (+) settings cause the times to be shortened for notes above Middle C. Negative (-) settings cause the times to be lengthened for notes above Middle C. 
ENV VEL SENS (Pitch Envelope Velocity Sensitivity)	-63--+63	Adjust this parameter when you want your keyboard playing dynamics (velocity) to affect the amount of pitch enveloping. With higher settings, there is a greater difference in the amount of enveloping when notes are played softly or when they're played hard. Negative (-) settings reverse the direction of change.
ENV T1 SENS (Pitch Envelope Time 1 Velocity Sensitivity)	-63--+63	Use this parameter when you want keyboard playing dynamics to affect T1 (Time 1) of the pitch envelope. If you want T1 to be sped up for strongly played notes, set this parameter to a positive (+) value. If you want it to be slowed down, set this to a negative (-) value.
ENV T4 SENS (Pitch Envelope Time 4 Velocity Sensitivity)	-63--+63	Use this parameter when you want key release speed to affect T4 (Time 4) of the pitch envelope. If you want T4 to be sped up for quickly released notes, set this parameter to a positive (+) value. If you want it to be slowed down, set this to a negative (-) value.
ENV T1–T4 (Pitch Envelope Time1–4)	0–127	Specify the pitch envelope times. Higher settings lengthen the time until the next pitch is reached. (For example, T2 is the time over which the pitch changes from L1 to L2.)
ENV L0–L4 (Pitch Envelope Level 0–4)	-63--+63	Specify the pitch envelope levels. They determine how much the pitch changes from the reference pitch (the value set with Coarse Tune and Fine Tune) at each point. Positive (+) settings cause the pitch to be higher than the standard pitch, and negative (-) settings cause it to be lower.

PATCH LFO (Applying Vibrato or Tremolo)

The LFO (Low Frequency Oscillator) can alter various Tone settings in a back-and-forth, cyclic manner. Each Tone has two LFOs, and each can apply the desired amount of repetitive change to the Tone's Pitch, TVF cutoff frequency, TVA Level and TVA Pan settings. This can be used as the Matrix Control source (p. 50).

How to Use the LFO

Applying an LFO to the Tone's Pitch settings creates vibrato, applying it to its TVF cutoff frequency creates a wah-wah, and applying it to its TVA Level creates tremolo. When an LFO is applied to the Tone's TVA Pan, the sound moves back and forth, from one side to another, in the stereo field.

Depending on your settings, an LFO can also be used to cyclically exchange two Tones. For example, if you wish to shift back and forth between Tones 1 and 2, select the same LFO settings for both, but set their LFO TVA Depth settings to opposite polarities—set one to a + value, and the other to a - value.

* LFO Since both LFOs have the same parameters, the following explanations apply to both.

Creating a Patch

Parameter	Value	Description																																																
LFO1(2) WAVEFORM (LFO Waveform)	SIN, TRI, SAW-UP, SAW-DW, SQR, RND, BEND-UP, BEND-DW, TRP, S&H, CHS	<p>Chooses the waveform the LFO is to use.</p> <p>SIN: sine wave, TRI: triangle wave, SAW-UP: sawtooth wave,</p> <p>SAW-DW: sawtooth wave (negative polarity),</p> <p>SQR: square wave, RND: random wave,</p> <p>BEND-UP: Once the attack of the waveform output by the LFO is allowed to develop in standard fashion, the waveform then continues without further change.</p> <p>BEND-DW: Once the decay of the waveform output by the LFO is allowed to develop in standard fashion, the waveform then continues without further change.</p> <p>TRP: trapezoidal wave,</p> <p>S&H: sample & hold wave (LFO value is changed one time per cycle),</p> <p>CHS: chaos wave</p> <p>* When setting BEND-UP or BEND-DW, set the Key Sync parameter to "ON." If this is "OFF," BEND-UP and BEND-DW will have no effect.</p>																																																
LFO1(2) OFFSET	-100–+100	Adjusts the basic width of the LFO waveform.																																																
LFO1(2) RATE VALUE	0–127, note	Adjusts the basic modulation rate, or speed, of the LFO.																																																
	<table border="1" style="width: 100%; border-collapse: collapse; text-align: center;"> <tr> <td></td> <td>Sixty-fourth-note triplet</td> <td></td> <td>Sixty-fourth note</td> <td></td> <td>Thirty-second-note triplet</td> <td></td> <td>Thirty-second note</td> </tr> <tr> <td></td> <td>Sixteenth-note triplet</td> <td></td> <td>Dotted thirty-second note</td> <td></td> <td>Sixteenth note</td> <td></td> <td>Eighth-note triplet</td> </tr> <tr> <td></td> <td>Dotted sixteenth note</td> <td></td> <td>Eighth note</td> <td></td> <td>Quarter-note triplet</td> <td></td> <td>Dotted eighth note</td> </tr> <tr> <td></td> <td>Quarter note</td> <td></td> <td>Half-note triplet</td> <td></td> <td>Dotted half note</td> <td></td> <td>Half note</td> </tr> <tr> <td></td> <td>Whole-note triplet</td> <td></td> <td>Dotted half note</td> <td></td> <td>Whole note</td> <td></td> <td>Double-note triplet</td> </tr> <tr> <td></td> <td>Dotted whole note</td> <td></td> <td>Double note</td> <td></td> <td></td> <td></td> <td></td> </tr> </table>		Sixty-fourth-note triplet		Sixty-fourth note		Thirty-second-note triplet		Thirty-second note		Sixteenth-note triplet		Dotted thirty-second note		Sixteenth note		Eighth-note triplet		Dotted sixteenth note		Eighth note		Quarter-note triplet		Dotted eighth note		Quarter note		Half-note triplet		Dotted half note		Half note		Whole-note triplet		Dotted half note		Whole note		Double-note triplet		Dotted whole note		Double note					<p>* The Chaos waveform has no wavelength. When the Chaos waveform is selected, the Rate setting has no effect.</p>
	Sixty-fourth-note triplet		Sixty-fourth note		Thirty-second-note triplet		Thirty-second note																																											
	Sixteenth-note triplet		Dotted thirty-second note		Sixteenth note		Eighth-note triplet																																											
	Dotted sixteenth note		Eighth note		Quarter-note triplet		Dotted eighth note																																											
	Quarter note		Half-note triplet		Dotted half note		Half note																																											
	Whole-note triplet		Dotted half note		Whole note		Double-note triplet																																											
	Dotted whole note		Double note																																															
LFO1(2) RATE DETUNE (LFO1 Rate Detune)	0–127	This setting allows you to adjust the tuning of the LFO waveform.																																																
LFO1(2) DELAY TIME (LFO Delay Time)	0–127	Adjusts the time over which the LFO rises to its full effect or fades away. (Refer to the diagrams for Fade Mode.)																																																
LFO1(2) DELAY KEY FOLLOW (LFO Delay Keyfollow)	-100–+100	Adjusts the value for the LFO1/LFO2 Delay Time parameter depending on the key position, relative to the C4 key (center C). To decrease the time that elapses before the LFO effect is applied—the effect is continuous—with each higher key that is pressed in the upper registers, select a positive value. To increase the elapsed time, select a negative value. Higher values result in greater change. If you don't want the elapsed time before the LFO effect is applied to change according to the key pressed, set this to "0."																																																
		* Refer to the diagrams for Pitch Envelope Time Keyfollow.)																																																
LFO1(2) FADE MODE (LFO Fade Mode)	ON-IN, ON-OUT, OFF-IN, OFF-OUT	Sets how the LFO is applied.																																																
	<p>ON-IN: The LFO fades in after the key is pressed.</p>	<p>ON-OUT: The LFO is immediately applied when the key is pressed, and then fades out.</p>																																																
	<p>OFF-IN: The LFO fades in after the key is released.</p>	<p>OFF-OUT: The LFO is immediately applied when the key is pressed, and begins fading out when the key is released.</p>																																																
LFO1(2) FADE TIME (LFO Fade Time)	0–127	Adjusts the time over which the LFO rises to its full effect or fades away. (Refer to the diagrams for Fade Mode.)																																																

Parameter	Value	Description
LFO1(2) KEY SYNC (LFO Key Sync)	OFF, ON	Sets whether you want the LFO cycle to start in sync with the timing of a key press (ON) or not (OFF).
LFO1(2) PITCH DEPTH	-63--+63	Adjusts how much the LFO affects the Tone's pitch.
LFO1(2) TVF DEPTH	-63--+63	Adjusts how much the LFO affects the Tone's TVF cutoff frequency.
LFO1(2) TVA DEPTH	-63--+63	Adjusts how much the LFO affects the Tone's TVA Level.
LFO1(2) PAN DEPTH	-63--+63	Adjusts how much the LFO affects the Tone's TVA Pan.

* Noise may result from making the LFO PAN DEPTH too deep. To prevent noise, you can either lower the value for the PAN DEPTH, or lower the LFO Rate.

PATCH TVF (Changing the Brightness with a Filter)

The settings for the TVF (Time Variant Filter) allow you to change a Tone's timbral content by altering its brightness or thickness.

Parameter	Value	Description
FILTER TYPE	OFF, LPF, BPF, HPF, PKG, LPF2, LPF3	<p>Selects a filter type. A filter typically reduces, or attenuates, a specific frequency range within a Tone in order to accentuate its other frequencies.</p> <p>OFF: No filter is used.</p> <p>LPF: A Low Pass Filter reduces the volume of frequencies above the cutoff frequency in order to un-brighten the sound. This is the most common filter used in synthesizers.</p> <p>BPF: A Band Pass Filter reduces the volume of frequencies below and above the cutoff frequency range. This is most effective when creating sounds with a strong character since it can accentuate a desired range of frequencies anywhere in the sound.</p> <p>HPF: A High Pass Filter reduces the volume of the frequencies below the cutoff frequency. This is suitable for creating percussive sounds by rolling off their lower frequencies, thus emphasizing their higher ones.</p> <p>PKG: A Peaking Filter emphasizes frequencies around the cutoff frequency by raising their level. You can use this to create wah-wah effects by employing an LFO to change the cutoff frequency cyclically.</p> <p>LPF2: Low Pass Filter 2. This reduces the volume of all frequencies above the cutoff frequency. This differs from LPF in that you can control the amount of the reduction using the TVF ENVELOPE settings while still maintaining a fixed cutoff frequency. This can be very effective with acoustic-instrument-based Tones, since nothing is done to weaken the power and energy of the sound.</p> <p>* This disables the Resonance setting.</p> <p>LPF3: Low Pass Filter 3 reduces the volume of frequencies above the cutoff frequency. While similar to LPF2, it reduces the frequencies more gently than LPF2. This can also be effective with acoustic-instrument-based Tones.</p> <p>* This disables the Resonance setting.</p>
CUTOFF (Cutoff Frequency)	0-127	<p>Adjusts the frequency at which the filter begins to have an effect on the waveform's frequency components. With LPF/LPF2/LPF3 selected for the Filter Type parameter, lower cutoff frequency settings reduce a Tone's upper harmonics for a more rounded, warmer sound. Higher settings make it sound brighter. When Filter Type is BPF, the cutoff frequency setting determines the range of frequencies within the Tone that will be heard. This can be useful when creating sounds that need to stand out. When Filter Type is HPF, higher settings of the cutoff frequency decrease the level of the Tone's low frequencies, preserving its brighter qualities. When Filter Type is PKG, the cutoff frequency setting determines the range of frequencies to be emphasized.</p>

Creating a Patch

Parameter	Value	Description
RES (Resonance)	0-127	<p>Increases the level of the cutoff frequency itself to add a popular classic synth character to the sound. Excessively high settings can produce oscillation, causing the sound to distort.</p>
RES VEL SENS (TVF resonance velocity sensitivity)	-63-+63	<p>Use this parameter when you want velocity to affect the amount of Resonance. With higher settings, there is a greater difference in the amount of Resonance between softly and strongly played notes. Negative (-) values reverse the direction of the change.</p>
CUTOFF KF (Cutoff Key follow)	-200-+200	<p>Use this parameter if you want the cutoff frequency to change according to the key that's pressed. At Middle C (C4), the original Cutoff value is used. Positive (+) settings cause the cutoff frequency to rise for notes higher than Middle C, and negative (-) settings cause the cutoff frequency to fall for notes higher than Middle C. Higher settings produce greater amounts of change to the original Cutoff setting.</p>
VEL CURVE (Cutoff Frequency Velocity Curve)	FIXED, 1-7	<p>Chooses one of seven curves that determine how keyboard playing dynamics (velocity) influence the Tone's cutoff frequency. When V-Curve is set to "FIXED," the cutoff frequency remains unchanged regardless of how hard or soft the keys are played.</p>
VEL SENS (Cutoff Frequency Velocity Sensitivity)	-63-+63	<p>Sets the amount of change to the Cutoff setting to be applied as a result of changes in playing velocity. With higher settings, there is a greater amount of change between softly and strongly played notes. Negative (-) settings reverse the direction of change.</p>
TVF ENVELOPE		
ENV DEPTH (TVF envelope depth)	-63-+63	<p>This adjusts the amount of filter enveloping. Higher settings produce more change. Negative (-) values invert the effect of the TVF envelope.</p>
ENV TIME KF (TVF Envelope Time Key follow)	-100-+100	<p>Use this parameter when you want a note's keyboard position to affect times T2-T4 of the TVF envelope. Higher settings change the times by a greater amount as you move away from Middle C (C4) - at Middle C, the original T1-T4 settings are in effect. Positive (+) settings cause the times to shorten as you play above Middle C. Negative (-) settings cause the times to lengthen as you play above Middle C. (p. 55)</p>

Parameter	Value	Description
ENV VEL CURVE (TVF envelope velocity curve)	FIXED, 1-7	This selects one of seven velocity curves that determine how velocity will affect the depth of the TVF Envelope. When set to "FIXED," the TVF envelope depth remains unchanged, regardless of how hard or soft you play.
ENV VEL SENS (TVF envelope velocity sensitivity)	-63-+63	Use this parameter when you want keyboard playing dynamics (velocity) to affect the depth of the TVF Envelope. With higher settings, there is a greater difference in the TVF envelope depth when you play softly or hard. Negative (-) settings reverse the direction of change.
ENV T1 SENS (TVF Envelope Time 1 Velocity Sensitivity)	-63-+63	Use this parameter when you want keyboard playing dynamics to affect T1 (Time 1) of the TVF envelope. If you want T1 to be sped up for strongly played notes, set this parameter to a positive (+) value. If you want it to be slowed down, set this to a negative (-) value.
ENV T4 SENS (TVF Envelope Time 4 Velocity Sensitivity)	-63-+63	Use this parameter when you want key release speed to affect T4 (Time 4) of the TVF envelope. If you want T4 to be sped up for quickly released notes, set this parameter to a positive (+) value. If you want it to be slowed down, set this to a negative (-) value.
ENV T1-T4 (TVF Envelope Time 1-4)	0-127	Specify the TVF envelope times. Higher settings lengthen the time until the next cutoff frequency level is reached. (For example, T2 is the time over which L1 changes to L2.)
ENV L0-L4 (TVF Envelope Level 0-4)	0-127	Specify the TVF envelope levels. These settings specify how the cutoff frequency changes at each point, relative to the standard cutoff frequency.

PATCH TVA (Changing the Volume)

The TVA (Time Variant Amplifier) controls volume changes to the Tone, as well as its stereo positioning.

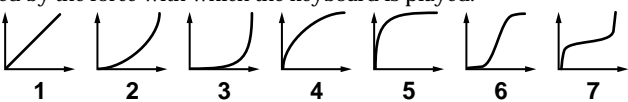
Parameter	Value	Description
LEVEL (Tone Level)	0-127	Sets the Tone's basic volume. This setting is useful primarily for adjusting the volume balance between Tones in a Patch. * The overall volume of the Patch is set by the Patch Level (PATCH COMMON p. 46) setting, raising or lowering the Tone level settings of its individual Tones by the selected amount.
VEL CURVE (TVA Level Velocity Curve)	FIXED, 1-7	Chooses one of seven curves that determine how keyboard playing dynamics (velocity) influence the Tone's volume. When set to "FIXED," the Tone's volume not affected by the force with which the keyboard is played. 
VEL SENS (TVA Level Velocity Sensitivity)	-63-+63	Use this setting when you want keyboard touch (velocity) to affect the Tone volume. Set this to a positive value to have the changes in tone volume increase the more forcefully the keys are played; to make the Tone play more softly as you play harder, set this to a negative value.

BIAS

Use the Bias parameter when you want the position of notes on a keyboard to affect the TVA level.

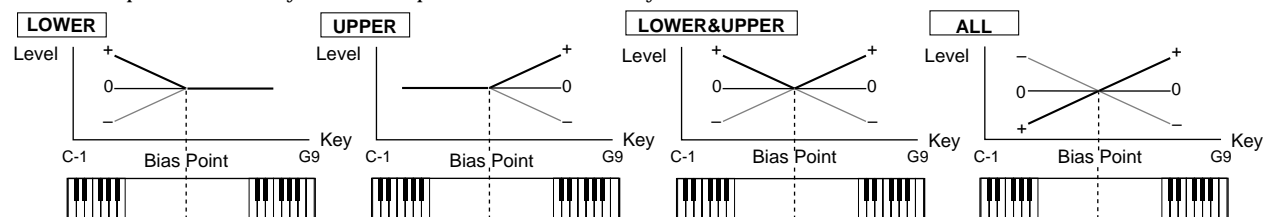

BIAS LEVEL	-100-+100	Adjusts the slope of the volume change that occurs in the selected Bias Direction. Higher settings produce greater amounts of change to the Tone's volume. Negative (-) settings reverse the direction of the change.
BIAS POINT	C-1-G9	Chooses the MIDI key at which the Tone's volume begins to change.
BIAS DIRECTION	LOWER, UPPER, LO&UP, ALL	Determines whether the volume of notes above or below the Bias point—or both—changes according to their distance from the Bias Point. LOWER: Notes below the Bias Point are affected. UPPER: Notes above the Bias Point are affected. LO&UP: Notes below and above the Bias Point are affected. ALL: The volume of notes across the entire keyboard are biased according to the Bias Level slope, based on their distance from the Bias Point.

Creating a Patch

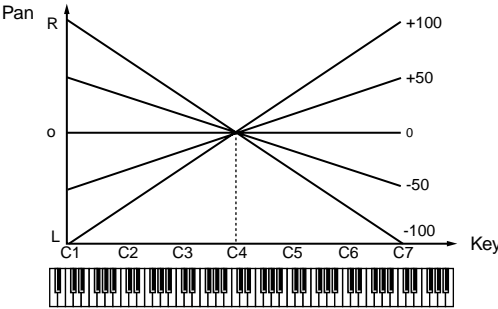
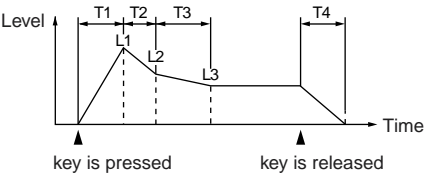
Parameter	Value	Description
PAN (Tone Pan)	L64-63R	Specifies the stereo position of the Tone. L64 places the Tone hard left, 0 puts it dead-center and 63R pans it hard right. * <i>The overall panning of the entire Patch is set by the Patch Pan parameter (PATCH COMMON p. 46), shifting the Tone Pan values of its individual Tones leftward or rightward by the selected amount.</i>
PAN KF (Tone Pan Key follow)	-100-+100	Use this parameter when you want each note's keyboard position to affect its stereo location. Higher settings cause a greater shifting of the Tone's original pan position as you move further away from Middle C (C4), where the original stereo TVA Pan value remains in effect. Positive (+) settings cause notes above Middle C to be panned rightward. Negative (-) settings cause them to be panned leftward. 
RANDOM PAN DEPTH (Tone Random Pan Depth)	0-63	Use this parameter to activate random panning, note-by-note. Higher values result in more extreme fluctuations in the Tone's stereo placement.
ALT PAN DEPTH (Tone Alternate Pan Depth)	L63-63R	This setting causes panning to be alternated between left and right each time a key is pressed. Higher values result in a greater left/right width. You can select the stereo placement of the first key using this parameter—its opposite is used for the second note, and so on back and forth. If you want to alternate the pan position of two Tones, set them to the exact opposite L and R settings.
TVA ENVELOPE This specifies the manner in which keyboard velocity affects the times of the TVA envelope.		
ENV TIME KF (TVA Envelope Time Key follow)	-100-+100	Use this parameter when you want a note's keyboard position to affect times T2-T4 of the TVA envelope. Higher settings change the times by a greater amount as you move away from Middle C (C4)—at Middle C, the original T1-T4 settings are in effect. Positive (+) settings cause the times to shorten as you play above Middle C. Negative (-) settings cause the times to lengthen as you play above Middle C. (p. 55)
ENV T1 SENS (TVA Envelope Time 1 Velocity Sensitivity)	-63-+63	Use this parameter when you want keyboard playing dynamics to affect T1 (Time 1) of the TVA envelope. If you want T1 to be sped up for strongly played notes, set this parameter to a positive (+) value. If you want it to be slowed down, set this to a negative (-) value.
ENV T4 SENS (TVA Envelope Time 4 Velocity Sensitivity)	-63-+63	Use this parameter when you want key release speed to affect T4 (Time 4) of the TVA envelope. If you want T4 to be sped up for quickly released notes, set this parameter to a positive (+) value. If you want it to be slowed down, set this to a negative (-) value.
ENV T1-T4 (TVA Envelope Time 1-4)	0-127	Specify the TVA envelope times. Higher settings lengthen the time until the next volume level is reached. (For example, T2 is the time over which L1 changes to L2.)
ENV L1-L3 (TVA Envelope Level 1-3)	0-127	Specify the TVA envelope levels. These settings specify how the volume changes at each point, relative to the standard volume.
EFFECTS		
SEND LEVEL DRY (Dry Send Level)	Refer to p. 78.	
SEND LEVEL CHO (Tone Chorus Send Level)		
SEND LEVEL REV (Tone Reverb Send Level)		
OUTPUT ASSIGN (Tone Output Assign)		

PATCH MFX (Patch Multi-Effects)

Parameter	Description
TYPE (Multi-Effects Type)	Refer to p. 80.
SEND LEVEL DRY (Multi-Effects Dry Send Level)	
SEND LEVEL CHO (Multi-Effects Chorus Send Level)	
SEND LEVEL REV (Multi-Effects Reverb Send Level)	
OUTPUT ASSIGN (Multi-Effects Output Assign)	
CONTROL SOURCE 1-4 (Multi-Effects Control Source 1-4)	
DESTINATION 1-4 (Multi-Effects Control Destination 1-4)	
SENS 1-4 (Multi-Effects Control Sensitivity 1-4)	

PATCH CHORUS

Parameter	Description
TYPE (Chorus Type)	Refer to p. 80.
LEVEL (Chorus Level)	
OUTPUT SELECT (Chorus Output Select)	

PATCH REVERB

Parameter	Description
TYPE (Reverb Type)	Refer to p. 80.
LEVEL (Reverb Level)	

Adjusting Effect Settings

Refer to **Multi-Effects Parameters** (p. 82).

Saving Patches You Create

Refer to **Saving a Sound You Create** (p. 92).

Creating a Rhythm Set

How Percussion Instruments Are Organized

A Rhythm Set is a collection of Rhythm Tones, each of which represents a percussion instrument played on a single key. An instrument consists of the following four elements.

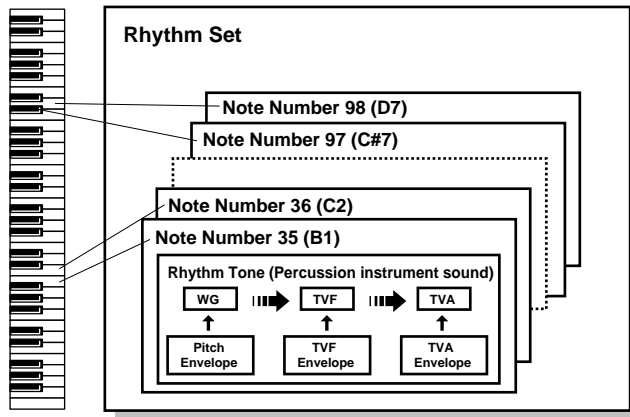

WG (Wave Generator)

This specifies the PCM waveform (or “wave”) that forms the basis of the Rhythm Tone - four waveforms can be assigned to each Rhythm Tone. You can also determine how the pitch of the Rhythm Tone will change.

The XV-2020 has 1083 different waveforms. (See **Waveform List** p. 121.)

All Rhythm Sets built into the XV-2020 consist of Rhythm Tones based on these waveforms.

TVF (Time Variant Filter)

This sets how the frequency characteristics of the Rhythm Tone will change.

TVA (Time Variant Amplifier)

This sets how the Rhythm Tone’s volume and stereo positioning will change.

Envelope

An envelope applies changes to the Rhythm Tone over time. There are separate envelopes for pitch, TVF (filter) and TVA (volume). For example, you would use the TVA Envelope to modify the way in which the Rhythm Tone attacks and decays.

Choosing the Tones That Sound (Tone On/Off)

Refer to p. 45.

Confirming Tones

Refer to p. 45.

The RHYTHM indicator change from solidly lit to flashing whenever a parameter is edited. If you turn off the power or choose another Rhythm set while the indicator is blinking, your new Rhythm sets settings will be lost. If you wish to preserve them, save the changed settings using the Write operation. (p. 92)

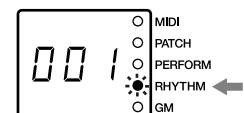

Rhythm Set Parameters

RHYTHM COMMON (Settings Common to the Entire Rhythm Set)

Parameter	Value	Description
RHYTHM NAME (Rhythm set name)	space, A-Z, a-z, 0-9, ! " # \$ % & ' () * + , - . / : ; < = > ? @ [\] ^ _ `	You can name a Rhythm Set using up to 12 alphanumeric characters. When using the XV editor, click ► on the left side to name the Tone.
KEY NAME	space, A-Z, a-z, 0-9, ! " # \$ % & ' () * + , - . / : ; < = > ? @ [\] ^ _ `	You can name a percussion sound (key) using up to 12 alphanumeric characters. When using the XV editor, click ► on the left side to name the Tone.
LEVEL (Rhythm set level)	0-127	This sets the overall volume of the Rhythm Set. * <i>To set the volume of each Rhythm Tone, use the Rhythm Tone Level (p. 67).</i>
OUTPUT ASSGIN (Rhythm output assign)	MFx, A, 1, 2, TONE	This sets the output destination of the Rhythm Set. MFx: The Rhythm Set is sent into the Multi-Effects. A: Output from OUTPUT. 1: Output from L. 2: Output from R. TONE: Each Rhythm Tone in the Rhythm Set is sent to its programmed output destination.
CLOCK SOURCE (Rhythm set clock source)	RHYTHM, SYSTEM	The LFO cycle, M-FX changes, phrase loop (break beats), and Tone delay time can be synchronized to a clock, or tempo. The Clock Source setting selects the timing reference to be used by the Rhythm Set. RHYTHM: The Rhythm Set Tempo will be used. SYSTEM: The global System Tempo or clock messages received from an external sequencer will be used.
TEMPO (Rhythm set tempo)	20-250	When Clock Source is set to "RHYTHM," this setting establishes the Rhythm Set's tempo. * <i>Clock messages for the Rhythm Tempo are not transmitted from the MIDI OUT jack.</i>

Setting up Individual Rhythm Tones

Parameters that can be set for each of the percussion instruments (Rhythm Tones) in Rhythm Sets are organized into the Parameter Groups listed below.

- **EFFECTS:** Patch/Rhythm Set Mode Settings (p. 77)
- **WMT (Wave Mix Table):** Modifying a Rhythm Tone's Waveform and Panning (p. 64)
- **RHYTHM CONTROL:** Other Settings (p. 68)
- **PITCH:** Modifying a Rhythm Tone's Pitch (p. 65)
- **TVF:** Modifying the Brightness of a Sound with a Filter (p. 66)
- **TVA:** Making the Volume Change (p. 67)

Tips for Choosing Rhythm Tone Waveforms

Refer to p. 52.

Creating a Rhythm Set

Rhythm Parameter

RHYTHM KEY VELOCITY RANGE

* Parameters that can be set independently for each Waveform are indicated by "#."

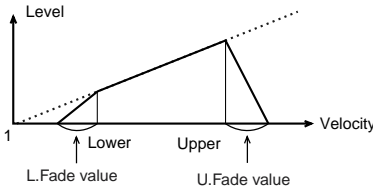
Parameter	Value	Description
VELOCITY CONTROL	OFF, ON, RANDOM	This determines whether Velocity range settings will be recognized (ON), or ignored (OFF). When set to RND, the Rhythm Set's constituent Waves will sound randomly, regardless of any Velocity messages.
FADE LOWER# (Velocity Fade Width Lower)	0-127	This determines what will happen to the waveform's level when it is played at a velocity lower than its specified velocity range. Higher settings produce a more gradual change in volume. If you don't want notes played outside the specified velocity range to be heard at all, set this to 0.
LOWER# (Velocity Range Lower)	1-UPPER	This sets the lowest velocity at which the waveform will sound. This feature is useful when you want different waveforms to be heard depending on how hard you play the Rhythm Set.
UPPER# (Velocity Range Upper)	LOWER-127	This sets the highest velocity at which the waveform will sound. This feature is useful when you want different waveforms to be heard depending on how hard you play the Rhythm Set. * It is not possible to set the Lower value higher than the Upper value, or the Upper value below the Lower value.
FADE UPPER# (Velocity Fade Width Upper)	0-127	This determines what will happen to the waveform's level when it is played at a velocity upper than its specified velocity range. Higher settings produce a more gradual change in volume. If you don't want notes played outside the specified velocity range to be heard at all, set this to 0. 

RHYTHM KEY WMT (Wave Mix Table)

With the XV-2020, up to four stereo Waves can be assigned to a single Rhythm Tone. You can select the way tones sound according to the force with which the keys are played, thus allowing you to create Rhythm Tones featuring great expressive power. This function is called (Wave Mix Table).

* Parameters that can be set independently for each Waveform are indicated by "#."

Parameter	Value	Description
WAVE GROUP#	INT, EXP-A, EXP-B	This selects the desired waveform's group. INT: Internal EXP-A, B: Wave Expansion Board A, B * It is not possible to select a Group of a Wave Expansion Board that is not installed.
WAVE NUMBER L# (Wave number left)	0001-1083	This selects the desired waveform by its number. You can choose a separate waveform for each of the XV-2020's left and right channels. * For monaural tones, assign a waveform to the L channel. No sound will be heard if a waveform is set for only the R channel.
WAVE NUMBER R# (Wave number right)		
TEMPO SYNC# (Wave tempo sync)	OFF, ON	This determines whether the waveform is synchronized (ON) or not synchronized (OFF) to the Rhythm Set's tempo.
GAIN# (Wave gain)	-6, 0, +6, +12 dB	This specifies the gain (or amplitude) of the waveform. The value changes in 6 dB (decibel) steps—an increase of 6 dB doubles the waveform's gain. If you intend to use the Booster to distort the waveform's sound, set this parameter to its maximum value.
LEVEL# (Wave level)	0-127	This adjusts the volume of each of the Rhythm Tone's waveforms to establish the desired volume balance between the waves. * The overall volume of each waveform is determined by the Rhythm Tone Level setting (TVA p. 67) combined with the WMT Wave Tone Level setting.
PAN# (Wave pan)	L64-63R	This establishes the stereo location of the waveform. L64 places it hard left, 0 outs it dead-center and 63R pans it hard right. * The overall panning of the entire Rhythm Tone is set by the Tone Pan parameter (TVA p. 68), offsetting the WMT Wave Pan value.

Parameter	Value	Description
RANDOM PAN# (Wave random pan switch)	OFF, ON	Use this setting to cause the waveform's panning to change randomly each time a key is pressed (ON) or not (OFF). The range of the panning change is set by the Tone Random Pan Depth setting (TVA p. 68).
ALT PAN# (Wave alternate pan switch)	OFF, ON, REV	Set this to ON to pan the Wave according to the Alternate pan depth (TVA p. 68) settings, or to REVERSE when you want the panning reversed. If you do not want the panning to change each time a key is pressed, set this to OFF.
COARSE TUNE# (Wave coarse tune)	-48--+48	This adjusts the pitch of Rhythm Tone in semitone steps (-4- +4 octaves).
FINE TUNE# (Wave fine tune)	-50--+50	This adjusts the pitch of the Rhythm Tone in 1-cent steps (1/100th of a semitone) over a range of half a semitone up or down.
FXM ON# (Wave FXM switch)	OFF, ON	This sets whether FXM will be used (ON) or not (OFF). [FXM (Frequency Cross Modulation)] FXM uses a specified waveform to apply frequency modulation to the currently selected waveform, creating complex overtones. This can be useful when creating wilder sounds or sound effects.
FXM COLOR# (Wave FXM color)	1-4	This specifies how FXM will perform its frequency modulation. Higher settings result in a grainier sound, while lower settings result in a more metallic sound.
FXM DEPTH# (Wave FXM depth)	0-16	This specifies the depth of the modulation produced by FXM.

RHYTHM KEY PITCH (Changing Pitch)

Parameter	Value	Description
COARSE TUNE (Rhythm tone coarse tune)	C-1-G9	This selects the basic pitch at which the Rhythm Tone will play.
FINE TUNE (Rhythm tone fine tune)	-50--+50	This adjusts the pitch of the percussion instrument sound in 1-cent steps (1/100th of a semitone) over a range of half a semitone up or down.
RANDOM PITCH (Random pitch depth)	0-1200	This specifies the width of random pitch deviation that will occur each time a key is pressed. If you don't want random pitch changes, set it to 0. The parameter can be adjusted in units of 1 cent (1/100th of a semitone).
PITCH ENVELOPE These parameters determine the amount of pitch enveloping—changes to your basic pitch settings that occur over time—the effect of velocity on the pitch envelope, and the basic characteristics of the pitch envelope itself.		
ENV DEPTH (Pitch envelope depth)	-12--+12	This determines the amount of pitch enveloping to be used—higher settings result in more extreme enveloping. Negative (-) settings invert the direction of the changes made by the Pitch Envelope.
ENV VEL SENS (Pitch envelope velocity sensitivity)	-63--+63	Adjust this parameter when you want your keyboard playing dynamics (velocity) to affect the amount of pitch enveloping. With higher settings, there will be a greater difference in the amount of enveloping when notes are played softly or when they're played hard. Negative (-) settings will reverse the direction of change.
ENV T1 SENS (Pitch envelope time 1 velocity sensitivity)	-63--+63	Use this parameter when you want keyboard playing dynamics (velocity) to affect T1 (Time 1) of the pitch envelope. With higher settings, the T1 value will change more significantly depending on whether you play softly or with greater force. With positive (+) settings, greater keyboard velocity will reduce the T1 setting. With negative (-) settings, greater keyboard velocity will increase the T1 setting.
ENV T4 SENS (Pitch envelope time 4 velocity sensitivity)	-63--+63	Use this parameter when you want key-off velocity—the speed at which you release a key—to affect T4 (Time 4) of the pitch envelope. With higher settings, the T4 value will change more significantly depending on whether you release the key slowly or quickly. With positive (+) settings, faster key-off velocity will reduce the T4 setting. With negative (-) settings, faster key-off velocity will increase the T4 setting.
ENV T1-T4 (Pitch envelope time 1-4)	0-127	Specify the pitch envelope times. Higher settings lengthen the time until the next pitch is reached. (For example, T2 is the time over which the pitch changes from L1 to L2.)
ENV L0-L4 (Pitch envelope level 0-4)	-63--+63	Specify the pitch envelope levels. They determine how much the pitch changes from the reference pitch (the value set with Coarse Tune and Fine Tune) at each point. Positive (+) settings cause the pitch to be higher than the standard pitch, and negative (-) settings cause it to be lower.

Creating a Rhythm Set

RHYTHM KEY TVF (Modifying the Brightness of a Sound with a Filter)

The settings for the TVF (Time Variant Filter) allow you to change a Rhythm Tone's timbral content by altering its brightness or thickness.

Parameter	Value	Description
FILTER TYPE (Filter type)	OFF, LPF, BPF, HPF, PKG, LPF2, LPF3	<p>This selects a filter type. A filter typically reduces, or attenuates, a specific frequency range within a Tone in order to accentuate its other frequencies.</p> <p>OFF: No filter is used.</p> <p>LPF: A Low Pass Filter reduces the volume of frequencies above the cutoff frequency in order to round off, or un-brighten, the sound. This is the most common filter used in synthesizers.</p> <p>BPF: A Band Pass Filter reduces the volume of frequencies below and above the cutoff frequency range. This is most effective when creating sounds with strong characteristics since it can accentuate a desired range of frequencies anywhere in the sound.</p> <p>HPF: A High Pass Filter reduces the volume of the frequencies below the cutoff frequency. This is suitable for creating percussive sounds by rolling off their lower frequencies, thus emphasizing their higher ones.</p> <p>PKG: A Peaking Filter emphasizes frequencies around the cutoff frequency by raising their level. You can use this to create wah-wah effects by employing an LFO to change the cutoff frequency cyclically.</p> <p>LPF2: Low Pass Filter 2. This reduces the volume of all frequencies above the cutoff frequency. This differs from LPF in that you can control the amount of the reduction using the TVF ENVELOPE settings while still maintaining a fixed cutoff frequency. This can be very effective with acoustic-instrument-based Tones, since nothing is done to weaken the power and energy of the sound.</p> <p>* This disables the Resonance setting.</p> <p>LPF3: Low Pass Filter 3 reduces the volume of frequencies above the cutoff frequency. While similar to LPF2, it filter reduces the frequencies more gently than LPF2. This can be very effective with acoustic-instrument-based Tones, since nothing is done to weaken the power and energy of the sound.</p> <p>* This disables the Resonance setting.</p>
CUTOFF (Cutoff frequency)	0-127	<p>This selects the frequency at which the filter begins to have an effect on the waveform's frequency components. With LPF/LPF2/LPF3 selected for the Filter Type parameter, lower cutoff frequency settings reduce a Rhythm Tone's upper harmonics for a more rounded, warmer sound. Higher settings make it sound brighter.</p> <p>When Filter Type is BPF, the cutoff frequency setting determines the range of frequencies within the Rhythm Tone that will be heard. This can be useful when creating distinctive sounds. When Filter Type is HPF, higher settings of the cutoff frequency decrease the level of the Rhythm Tone's low frequencies, preserving its brighter qualities. When Filter Type is PKG, the cutoff frequency setting determines the range of frequencies to be emphasized.</p>
RES (Resonance)	0-127	<p>This increases the level of the cutoff frequency to add a popular classic synth character to the sound. Excessively high settings can produce oscillation, causing the sound to distort.</p> <div style="text-align: center;"> </div>
TVF VELOCITY		
This sets the amount of change to the original cutoff frequency in response to differences in velocity, as well as the velocity response curve and velocity's effect on Resonance.		
RES VEL SENS (TVF resonance velocity sensitivity)	-63-+63	Use this parameter when you want velocity to affect the amount of Resonance. With higher settings, there is a greater difference in the amount of Resonance between softly and strongly played notes. Negative (-) values reverse the direction of the change.

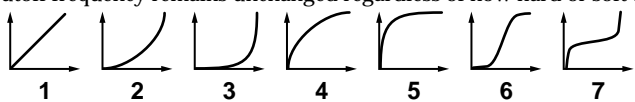
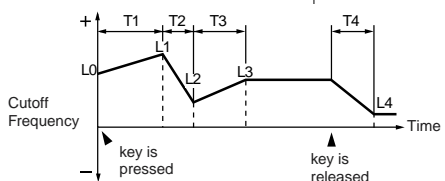
Parameter	Value	Description
VEL CURVE (TVF cutoff velocity curve)	FIXED, 1-7	This selects one of seven curves that determine how keyboard playing dynamics (velocity) influence the Rhythm Tone's cutoff frequency. When V-Curve is set to "FIXED," the cutoff frequency remains unchanged regardless of how hard or soft the keys are played. 
VEL SENS (TVF cutoff velocity sensitivity)	-63-+63	This sets the amount of change to the Cutoff setting to be applied as a result of changes in playing velocity. With higher settings, there is a greater amount of change between softly and strongly played notes. Negative (-) settings reverse the direction of change.
TVF ENVELOPE 		These parameters determine the amount of filter enveloping—changes to your original cutoff frequency setting that occur over time—the effect of velocity on the TVF envelope, and the basic characteristics of the TVF envelope itself.
ENV DEPTH (TVF envelope depth)	-63-+63	This adjusts the amount of filter enveloping. Higher settings produce more change. Negative (-) values invert the effect of the TVF envelope.
ENV VEL CURVE (TVF envelope velocity curve)	FIXED, 1-7	This selects one of seven velocity curves that determine how velocity will affect the depth of the TVF Envelope. The selected curve is displayed graphically to the right of its value.
ENV VEL SENS (TVF envelope velocity sensitivity)	-63-+63	Use this parameter when you want keyboard playing dynamics (velocity) to affect the depth of the TVF Envelope. With higher settings, there is a greater difference in the TVF envelope depth when you play softly or hard. Negative (-) settings reverse the direction of change.
ENV T1 SENS (TVF envelope time 1 velocity sensitivity)	-63-+63	Use this parameter when you want keyboard playing dynamics (velocity) to affect T1 (Time 1) of the TVF envelope. With higher settings, the T1 value will change more significantly depending on whether you play softly or with greater force. With positive (+) settings, greater keyboard velocity will reduce the T1 setting. With negative (-) settings, greater keyboard velocity will increase the T1 setting. Use this parameter when you want velocity to affect T1 (time) of the TVF envelope. For higher settings, there will be a greater difference between softly and strongly played notes. For positive (+) settings, keyboard velocity will speed up the T1 time. For negative (-) settings, keyboard velocity will slow down the T1 time.
ENV T4 SENS (TVF envelope time 4 velocity sensitivity)	-63-+63	Use this parameter when you want key-off velocity—the speed at which you release a key—to affect T4 (Time 4) of the TVF envelope. With higher settings, the T4 value will change more significantly depending on whether you release the key slowly or quickly. With positive (+) settings, faster key-off velocity will reduce the T4 setting. With negative (-) settings, faster key-off velocity will increase the T4 setting.
ENV T1-T4 (TVF envelope time 1-4)	0-127	Specify the TVF envelope times. Higher settings lengthen the time until the next cutoff frequency level is reached. (For example, T2 is the time over which L1 changes to L2.)
ENV L0-L4 (TVF envelope level 0-4)	0-127	Specify the TVF envelope levels. These settings specify how the cutoff frequency changes at each point, relative to the standard cutoff frequency.

RHYTHM KEY TVA (Making the Volume Change)

The TVA (Time Variant Amplifier) controls the Rhythm Tone's volume changes and stereo positioning.

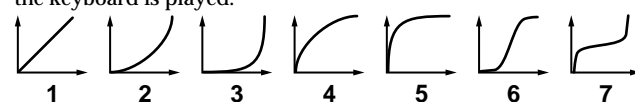
Parameter	Value	Description
LEVEL (Rhythm tone level)	0-127	This sets the Rhythm Tone's basic volume. This setting is useful primarily for adjusting the volume balance between Rhythm Tones in a Rhythm Set. <i>* The overall volume of the Rhythm Set is set by the Level (Rhythm Set Level, p. 63) setting, raising or lowering the Tone level settings of its individual Rhythm Tones by the selected amount.</i>
VEL CURVE (TVA level velocity curve)	FIXED, 1-7	This setting allows you to select from seven velocity curves that determine how the force with which the keyboard is played is to affect the Rhythm Tone's volume. When set to "FIXED," the Rhythm Tone's volume will not be affected by the force with which the keyboard is played. 

Creating a Rhythm Set

Parameter	Value	Description
VEL SENS (TVA level velocity sensitivity)	-63–+63	Use this setting when you want keyboard touch (velocity) to affect the Rhythm Tone volume. Set this to a positive value to have the changes in tone volume increase the more forcefully the keys are played; to make the Rhythm Tone play more softly as you play harder, set this to a negative value.
PAN (Rhythm tone pan)	L64–63R	This specifies the stereo position of the Rhythm Tone. L64 places the Rhythm Tone hard left, 0 puts it dead-center and 63R pans it hard right.
RANDOM PAN DEPTH	0–63	Use this parameter to activate random panning, note-by-note. Higher values result in more extreme fluctuations in the Rhythm Tone's stereo placement.
ALT. PAN DEPTH (Alternate pan depth)	L63–63R	This setting causes panning to be alternated between left and right each time a key is pressed. Higher values result in a greater left/right width. You can select the stereo placement of the first key using this parameter—its opposite will be used for the second note, and so on back and forth. If you want to alternate the pan position of two Rhythm Tones, set them to the exact opposite L and R settings.
TVA ENVELOPE This specifies the manner in which keyboard velocity will affect the times of the TVA envelope.		
ENV T1 SENS (TVA envelope time 1 velocity sensitivity)	-63–+63	Use this parameter when you want keyboard playing dynamics (velocity) to affect T1 (Time 1) of the TVA envelope. With higher settings, the T1 value will change more significantly depending on whether you play softly or with greater force. With positive (+) settings, greater keyboard velocity will reduce the T1 setting. With negative (-) settings, greater keyboard velocity will increase the T1 setting.
ENV T4 SENS (TVA envelope time 4 velocity sensitivity)	-63–+63	Use this parameter when you want key-off velocity—the speed at which you release a key—to affect T4 (Time 4) of the TVA envelope. With higher settings, the T4 value will change more significantly depending on whether you release the key slowly or quickly. With positive (+) settings, faster key-off velocity will reduce the T4 setting. With negative (-) settings, faster key-off velocity will increase the T4 setting.
ENV T1–T4 (TVA envelope time 1–4)	0–127	Specify the TVA envelope times. Higher settings lengthen the time until the next volume level is reached. (For example, T2 is the time over which L1 changes to L2.)
ENV L1–L3 (TVA envelope level1–3)	0–127	Specify the TVA envelope levels. These settings specify how the volume changes at each point, relative to the standard volume.
SEND LEVEL DRY (Dry Send Level)	Refer to p. 78.	
SEND LEVEL CHO (Tone Chorus Send Level)		
SEND LEVEL REV (Tone Reverb Send Level)		
OUTPUT ASSIGN (Tone Output Assign)		

RHYTHM CONTROL (Other Settings)

Parameter	Value	Description
PITCH BEND RANGE (Rhythm tone pitch bend range)	0–48	Specifies the amount of pitch change that will occur when you move the Pitch Bend Lever.
MUTE GROUP	OFF, 1–31	The Mute Group function allows you to designate two or more Rhythm Tones that are not allowed to sound simultaneously. For example, in a real-world acoustic drum set, an open hi-hat and a closed hi-hat sound will never occur simultaneously, since they're produced by the same instrument. To simulate this behavior on the XV-2020, you can set the open and closed hi-hat Rhythm Tones to the same Mute Group. You can have up to 31 Mute Groups per Rhythm Set. If you do not want a Rhythm Tone to use a Mute Group, turn the feature off.
ASSIGN TYPE (Assign type)	MULTI, SINGLE	This setting determines whether a Rhythm Tone note that is playing is stopped when the same note is played again (SINGLE), or whether it will continue to play, layered with the new note.

Parameter	Value	Description
ENV MODE (Rhythm tone envelope mode)	NO-SUS, SUSTAIN	When a loop-type waveform is selected, it will normally continue to sound as long as a key is pressed. If you want a note to decay naturally even when the key remains pressed, set this to "NO-SUSTAIN." * If a one-shot type Wave is selected, it will not sustain even if this parameter is set to "SUSTAIN."
RCV EXP (Rhythm tone receive expression switch)	OFF, ON	If you want the Rhythm Tone to respond to Expression messages, turn this parameter on. If not, turn it off.
RCV HOLD-1 (Rhythm tone receive hold 1 switch)	OFF, ON	If you want the Tone to respond to Hold 1 messages, turn this parameter on. If not, turn it off.
RCV PAN MODE (Rhythm tone receive pan mode)	CONTINUOUS, KEY-ON	CONTINUOUS: Pan messages will be responded to immediately, instantly changing the stereo position of the Rhythm Tone. KEY-ON: The stereo location of the Rhythm Tone will be changed only when the next note is played. If a Pan message is received while a note is sounding, its stereo location will not change.

RHYTHM MFX (Rhythm Multi-Effects)

Parameter	Description
TYPE (Multi-Effects Type)	Refer to p. 80.
SEND LEVEL DRY (Multi-Effects Dry Send Level)	
SEND LEVEL CHO (Multi-Effects Chorus Send Level)	
SEND LEVEL REV (Multi-Effects Reverb Send Level)	
CONTROL SOURCE 1-4 (Multi-Effects Control Source 1-4)	
DESTINATION 1-4 (Multi-Effects Control Destination 1-4)	
SENS 1-4 (Multi-Effects Control Sensitivity 1-4)	

RHYTHM CHORUS

Parameter	Description
TYPE (Chorus Type)	Refer to p. 80.
LEVEL (Chorus Level)	
OUTPUT SELECT (Chorus Output Select)	

RHYTHM REVERB

Parameter	Description
TYPE (Reverb Type)	Refer to p. 80.
LEVEL (Reverb Level)	

Adjusting Effect Settings

Refer to **Patch/Rhythm Set Mode Settings** (p. 77).

Saving Rhythm Sets You Create

Refer to **Saving a Sound You Create** (p. 92).

Creating a Performance

How a Performance Is Organized

In the XV-2020's Performance mode, you can play and control up to 16 instrument sounds at the same time, including Patches and/or Rhythm Sets. Such a set of sounds, as well as an effect setup, can be saved as a "Performance." Each Performance is comprised of 16 "Parts," each of which controls one of its sounds. Because the XV-2020 sound generator can play multiple sounds at the same time, it's called a "multitimbral sound module."

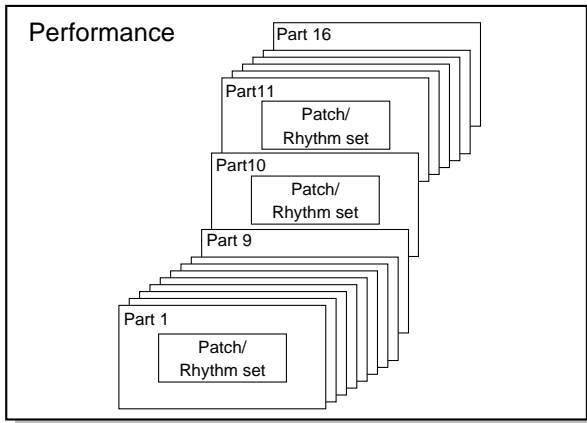

Basic Ways to Use Performances

There are three basic ways to use Performances.

Playing Multiple Layered Patches (Layer)

You can set a number of Parts to the same MIDI reception channel so that their Patches sound at the same time. This type of Performance is referred to as a **Layer**.

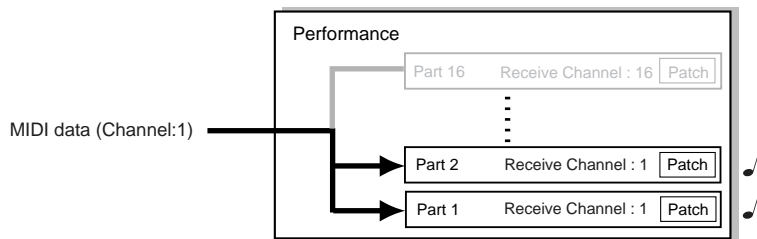

Playing Different Patches In Different Areas of the Keyboard (Split)

In a Performance, you can divide the keyboard into separate ranges and assign a different Patch to each range. This can be done by selecting the same MIDI reception channel for multiple Parts and then changing the pitch range over which each Part plays. This type of keyboard setup is referred to as a **Split**. A split is like a layer in which the Parts' pitch ranges don't overlap (Playing Multiple Layered Patches).

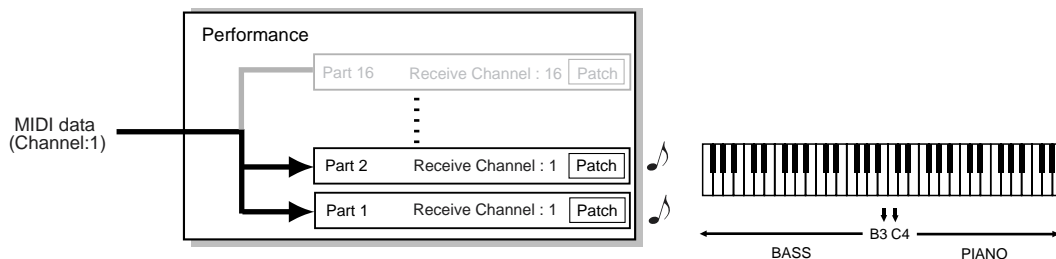

Using the XV-2020 as a Multitimbral Sound Module

In Performance mode, you can use the XV-2020 as a 16-part multitimbral sound module. Let's try choosing some Parts and their sounds, and then play the multiple Parts together as a Performance.

The basic steps for doing this include:

- Choosing the Parts to Play (p. 45)
- Choosing a Patch for each Part (p. 35)
- Setting the Parts' MIDI reception channels (p. 74)

After you've completed setting up your Performance, try playing a sequence from your computer or sequencer using the Performance's sounds.

Switching Parts

You can switch parts by rotating [PART] in Performance Part Play mode or Performance Play mode (numerals correspond to the part numbers).

Turning a Tone On or Off

Refer to **Choosing the Tones That Sound (Tone On/Off)** (p. 45).

Confirming Tones

Refer to **Confirming Tones** (p. 45).

The PERFORM indicator change from solidly lit to flashing whenever a parameter is edited. If you turn off the power or choose another Performance while the indicator is blinking, your new Performance settings will be lost. If you wish to preserve them, save the changed settings using the Write operation. (p. 92)

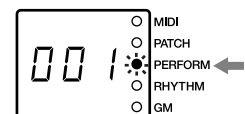

Performance Parameters

PERFORM COMMON (Establishing Settings for an Entire Performance)

Parameter	Value	Description
PERFORM NAME (Performance Name)	space, A-Z, a-z, 0-9, ! " # \$ % & ' () * + , - . / : ; < = > ? @ [¥] ! ^ _ `	You can give a Performance a name of up to 12 characters. When using the XV editor, click ► on the left side to name the Tone.
SOLO PART SELECT	OFF, 1-16	Select the Part whose sound you want to hear. Parts other than the Part you choose here will not sound.
MFX CTRL CH (Multi-Effects Control Channel)	1-16, OFF	Sets the channel that controls Multi-effects assigned to the Performance.
SOURCE MFX (Multi-Effects Source)	Refer to PATCH/RHYTHM MFX, PERFORM MFX (Multi-Effects Settings) (p. 80)	
CHORUS (Chorus Source)	Refer to PATCH/PERFORMANCE CHORUS (Chorus Settings) (p. 80)	
REVERB (Reverb Source)	Refer to PATCH/PERFORMANCE REVERB (Reverb Settings) (p. 80)	

PERFORM PART ALL

* Parameters that can be set independently for each Tone are indicated by "#."

Parameter	Value	Description
MUTE# (Mute Switch)	OFF, MUTE	This silences, or "mutes," the Part when set to MUTE. * Although the Part's sound is muted, the Part still receives MIDI messages. Thus, even when the Part's sound is switched on or off during playback of a song, the Part continues to keep up with the latest received MIDI data.

Creating a Performance

Parameter	Value	Description
SOLO (Solo Part Select)		Refer to the Performance Common column
Parameter	Value	Description
TYPE (Part Type)	PAT, RHY	Select the type of sound the Part plays.
GROUP (Part Group)	USER, PR-A-D, GM, EXP-A, EXP-B	Chooses the group (Bank) to which the desired Patch or Rhythm Set belongs. <i>* It is not possible to choose EXP-A, EXP-B unless a wave expansion board is inserted into the corresponding slot. (p. 105)</i>
NUMBER (Patch/Rhythm Set Number)		Chooses the Rhythm set number to which the desired Patch or Rhythm Set belongs.
LEVEL (Part Level)	0-127	Sets the volume of the Part. This setting's main purpose is to adjust the volume balance between Parts.
PAN (Part Pan)	L64-63R	Specifies the stereo position of the Part's sound. L64 pans the sound hard left, 0 puts it dead-center and 63R pans it hard right.
VEL SENS (Part Velocity Sensitivity)	-63-+63	Raises or lowers the VELOCITY V-Cutoff and the TVA V-Sens settings for each of the Tones in the Part's sound.
OCT SHIFT (Part Octave Shift)	-3-+3	Adjusts the pitch of the Part's sound up or down in units of an octave (+/-3 octaves).
COARSE TUNE (Part Coarse Tune)	-48-+48	Adjusts the pitch of the Part's sound up or down in semitone steps over a range of +/-4 octaves.
FINE TUNE (Part Fine Tune)	-50-+50	Adjusts the pitch of the Part's sound up or down in 1-cent steps (1/100th of a semitone) over a range of half a semitone up or down.

Parameter	Value	Description
PB RANGE (Part Pitch Bend Range)	0-24, PAT	Specifies the amount of pitch change that occurs when you move the Pitch Bend Lever. This overrides the sound's own pitch-bend settings. The amount of pitch change downward or upward that occurs when the lever is moved is the same for both its left and right directions (or down and up on some MIDI controllers). When PATCH is chosen, the bend range settings for the assigned Patch take effect.
MONO/POLY (Part Mono/Poly)	MONO, POLY, PAT	Sets how the Patch's notes play. The MONO setting is effective when playing a solo instrument Patch such as sax or flute. MONO: Only one note sounds at a time. POLY: Two or more notes can be played simultaneously. PAT: The Part uses the Patch's Mono/Poly setting.
LEGATO (Part Legato Switch)	OFF, ON, PAT	Turn this parameter ON when you want to use the Legato feature and OFF when you don't. Legato is a feature that works only when the Key Assign Mode is MONO. When Legato is ON, pressing one key when another is already pressed causes the currently playing note's pitch to change to that of the newly pressed key while continuing to sound. This can be effective when you wish to simulate performance techniques such as a guitarist's hammering on and pulling off strings. When PAT is selected, the Patch's own settings take effect.
PORTAMENTO SW (Part Portamento Switch)	OFF, ON, PAT	Specifies whether the portamento effect is applied (ON) or not (OFF). When PAT is selected, the settings for the assigned Patch take effect. [What is Portamento?] Portamento is an effect that smoothly changes the pitch from the first-played key to the next-played key. When Key Assign is MONO, applying portamento produces an effect similar to the slide performance technique of a violinist. Portamento can also be applied when Key Assign is polyphonic (POLY).
PORTAMENTO TIME (Part Portamento Time)	0-127, PAT	Specifies the time over which the pitch changes. Higher settings cause the pitch change to the next note to take more time. When PAT is chosen, the settings for the assigned Patch take effect.
VIBRATO RATE (Part Vibrato Rate)	-64-+63	Adjusts the vibrato speed (the rate at which the pitch is modulated). The pitch will be modulated more rapidly for higher settings and more slowly with lower settings.
VIBRATO DEPTH (Part Vibrato Depth)	-64-+63	Adjusts the depth of the vibrato effect (the depth at which the pitch is modulated). The pitch will be modulated more greatly for higher settings, and less with lower settings.
VIBRATO DELAY (Part Vibrato Delay)	-64-+63	Adjusts the delay time until the vibrato (pitch modulation) effect begins. Higher settings will produce a longer delay time before vibrato begins, while lower settings produce a shorter time.

Parameter	Value	Description
SEND LEVEL DRY (Part Output Level)	Refer to p. 78.	
SEND LEVEL CHO (Part Chorus Send Level)		
SEND LEVEL REV (Part Reverb Send Level)		
OUTPUT ASGN (Part Output Assign)		
OUTPUT SELECT (Part Output MFX Select)		

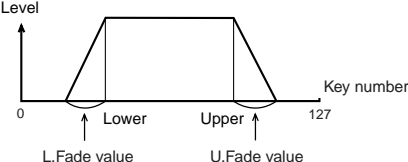
Parameter	Value	Description
VOICE RESERVE	0-63, FULL	<p>Specifies the number of voices that reserved for each Part when more than 64 voices are played simultaneously.</p> <p><i>* It is not possible for the settings of all Parts to total an amount greater than 64.</i></p> <p>[Calculating the Number of Voices Being Used] The number of notes, or "voices," that the XV-2020 can sound simultaneously depends on the number of Tones in the Patches you're using and the number of keys being pressed. For example, if you play one note using a Patch that consists of only one Tone, you'll use up one voice of polyphony. XV-2020 Tones may use two Waveforms. If a Patch's Tone uses two Waveforms, the number of voices it requires is doubled. If two keys are pressed with a Patch that has four Tones, and each Tone uses two Waveforms, a total of sixteen voices are used. This number is obtained by performing the following calculation. Count the number of Tones with two Waveforms and multiply this number by 2. Add the number of Tones that use one Waveform. Multiply this total by the number of keys pressed. The XV-2020 can play up to 64 Tones simultaneously. When you're using the XV-2020 multitimbrally, keep this in mind, and adjust your Voice Reserve settings so that each Part is guaranteed at least the minimum number of voices it requires.</p>
OFFSET	You can determine how a Part plays a sound by setting it to modify the sound's programmed cutoff frequency, Resonance and TVF and TVA Envelope attack and release time settings.	
OFFSET COF (Part Cutoff Offset)	-64--+63	Raises or lowers the TVF cutoff frequency settings for each of the Tones in the Part's sound.
OFFSET RES (Part Resonance Offset)	-64--+63	Raises or lowers the TVF Resonance settings for each of the Tones in the Part's sound.
OFFSET ATK (Part Attack Time Offset)	-64--+63	Raises or lowers the TVF/TVA attack time (T1) settings for each of the Tones in the Part's sound.
OFFSET DCY (Part Decay Time Offset)	-64--+63	Raises or lowers the TVF/TVA attack time (T2 and T3) settings for each of the Tones in the Part's sound.
OFFSET REL (Part Release Time Offset)	-64--+63	Raises or lowers the TVF/TVA release time (T4) settings for each of the Tones in the Part's sound.
FADE LOWER# (Part Keyboard Fade Width Lower)	0-127	Determines what happens to the Part's level when a note that's lower than its specified keyboard range is played. Higher settings result in a more gradual change in volume. If you don't want the Part to sound at all when a note below the keyboard range is played, set this parameter to 0.
LOWER# (Part Keyboard Range Lower)	C-1-UPPER	Specifies the lowest note that causes the Part to play its sound.
UPPER# (Part Keyboard Range Upper)	LOWER-G9	Specifies the highest note that causes the Part to play its sound. <i>* It is not possible to set Lower to a value greater than the Upper value, or Upper to a value less than the Lower value.</i>
FADE UPPER# (Part Keyboard Fade Width Upper)	0-127	<p>Determines what happens to the Part's level when a note that's higher than its specified keyboard range is played. Higher settings result in a more gradual change in volume. If you don't want the Part to sound at all when a note above the keyboard range is played, set this parameter to 0.</p> 

PERFORM MIDI SETTING (Establishing a Part's MIDI Settings)

- * Parameters that can be set independently for each Tone are indicated by “#.”
- * Parameters that can be set independently for each MIDI channel are indicated by “+.”

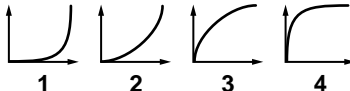
Parameter	Value	Description
RCV CHANNEL# (Receive Channel)	1-16	Sets the MIDI channel to which the Part responds.
RCV MIDI# (Receive Switch)	OFF, ON	This enables (ON) or disables (OFF) the Part's response to received MIDI messages.
RCV PC+ (Receive Program Change Switch)	OFF, ON	Sets whether the Part responds to received MIDI Program Change messages (ON) or not (OFF).
RCV BS+ (Receive Bank Select Switch)	OFF, ON	Sets whether the Part responds to received MIDI Bank Select messages (ON) or not (OFF).
RCV PB+ (Receive Pitch Bend Switch)	OFF, ON	Sets whether the Part responds to received MIDI Bender messages (ON) or not (OFF).
RCV CH PRESS- (Receive Channel Pressure Switch)	OFF, ON	Sets whether the Part responds to received MIDI Aftertouch messages (ON) or not (OFF).
RCV POLY PRESS+ (Receive Polyphonic Pressure Switch)	OFF, ON	Sets whether the Part responds to received MIDI Polyphonic Aftertouch messages (ON) or not (OFF).
RCV MOD+ (Receive Modulation Switch)	OFF, ON	Sets whether the Part responds to received MIDI Modulation messages (ON) or not (OFF).
RCV VOLUME+ (Receive Volume Switch)	OFF, ON	Sets whether the Part responds to received MIDI Volume messages (ON) or not (OFF).
RCV PAN+ (Receive Pan Switch)	OFF, ON	Sets whether the Part responds to received MIDI Pan messages (ON) or not (OFF).
RCV EXP+ (Receive Expression Switch)	OFF, ON	Sets whether the Part responds to received MIDI Expression messages (ON) or not (OFF).
RCV HOLD-1+ (Receive Hold 1 Switch)	OFF, ON	Sets whether the Part responds to received MIDI Hold 1 messages (ON) or not (OFF).
PHASE LOCK+ (Phase Lock Switch)	OFF, ON	This setting activates (ON) or de-activates (OFF) synchronization of the timing of Parts that share a common MIDI channel. * When Part sounds are layered on top of each other as a result of sharing a MIDI channel, there may be a discrepancy in their timing. The Phase Lock feature can synchronize the sounds so that they start precisely at the same time. However, since this delays the sounds slightly in order to line them up, turn this feature off when it's not needed.
VELOCITY CURVE TYPE+	OFF, 1-4	For each Part, you can select from among four velocity curves to find the one that best matches the touch of the MIDI keyboard connected to the XV-2020. Set this to “OFF” if you're using the MIDI keyboard's own velocity curve. 

PART SCALE TUNE

One set of Scale Tune settings can be created in Performance mode.

* *The selected scale applies to MIDI messages received from an external MIDI device as well as to local sound generation.*

Parameter	Value	Description
SCALE TUNE SWITCH	OFF, ON	The XV-2020 allows you to use temperaments other than equal temperament. Turn this on when you wish to use a tuning scale other than equal temperament.
KEY C-B SCALE	-64+63	Adjusts the pitch of each note in one-cent steps (1/100th of a semitone) relative to its equal-tempered pitch.

PERFORM MFX (Performance Multi-effects)

Parameter	Value
TYPE (Multi-Effects Type)	Refer to p. 80.
SEND LEVEL DRY (Multi-Effects Dry Send Level)	
SEND LEVEL CHO (Multi-Effects Chorus Send Level)	
SEND LEVEL REV (Multi-Effects Reverb Send Level)	
CONTROL SOURCE 1-4 (Multi-Effects Control Source1-4)	
DESTINATION 1-4 (Multi-Effects Control Destination 1-4)	
SENS 1-4 (Multi-Effects Control Sensitivity 1-4)	

PERFORM CHORUS (Performance Chorus)

Parameter	Description
TYPE (Chorus Type)	Refer to p. 80.
LEVEL (Chorus Level)	
OUTPUT SELECT (Chorus Output Assign)	
SOURCE (Multi-Effects Source)	

PERFORM REVERB (Performance Reverb)

Parameter	Description
TYPE (Reverb Type)	Refer to p. 80.
LEVEL (Reverb Level)	
SOURCE (Multi-Effects Source)	

Adjusting Effect Settings

Refer to **Multi-Effects Parameters** (p. 82).

Saving Performances You Create

Refer to **Saving a Sound You Create** (p. 92).

Using the XV-2020 Effects

This chapter explains how effects are applied in Patch/Rhythm Set mode or Performance mode.

* *For information about the application of effects in GM mode, refer to “**Making Effects Settings in GM Mode (EFFECTS)** (p. 97).”*

Effect Types

The XV-2020 has the following four onboard effect processors, and settings can be made independently for each.

MFX (Multi-Effects)

The Multi-effects are multi-purpose effects that completely change the sound type by changing the sound itself. Contained are 40 different effects types; select and use the type that suits your aims. In addition to effects types composed of simple effects such as Distortion, Flanger, and other such effects, you can also set up a wide variety of other effects, even connecting effects in series or in parallel. Furthermore, while chorus and reverb can be found among the Multi-effects types, the following chorus and reverb are handled with a different system.

In GM mode, you cannot use Multi-effects.

Chorus

Chorus adds fatness and breadth to the sound.

A GM-exclusive Chorus can be used in GM mode.

Reverb

Reverb adds an ambience to sounds so they seem to be playing in an actual physical space.

A GM-exclusive Reverb is used in GM mode.

* *The XV-2020 does not have a built-in equalizer.*

Turning Effects On/Off

The XV-2020's onboard effects can be turned on/off as a whole.

Turn these settings OFF when you wish to listen to the unprocessed sound as you create a sound, or when you wish to use external effects processors instead of the built-in effects.

When using XV Editor, included with the XV-2020, make the settings in the following screen.

You can also select the effect parameters from the same screen.



Patch/Rhythm Set Mode Settings

Only one Multi-effect, Chorus, or Reverb effect can be set for each Patch or Rhythm Set. You cannot apply differing types of Multi-effects, Chorus, or Reverb to each of the Tones or Rhythm Tones comprising the Patch or Rhythm Set.

Basic Process of Making Effects Settings

When applying effects in Patch/Rhythm Set mode, the following procedure is used to make the settings.

- 1. Setting the Output Method of the Direct Sound (Output Assign -> p. 78)**
Settings determining whether or not the signal passes through the Multi-effects, the jack used to output the sound, and the type of output (stereo or mono) are made for each individual Patch or Rhythm Set, or each Tone or Rhythm Tone.
- 2. Setting the Amount of Each Effect Applied (Send Level-> p. 78)**
Set the level (volume) of each effect signal to be sent for each Tone or Rhythm Tone.
- 3. Making Multi-Effects Settings (->p. 80)**
Select the type of Multi-effects to be used, and set the parameters for the selected Multi-effect.
- 4. Setting the Multi-Effects Controller (-> p. 78)**
When using MIDI messages to change the Multi-effects parameters in realtime, select the Multi-effects controller.
- 5. Setting the Output Destination and Volume for the Sounds Passing Through the Multi-Effects (-> p. 80)**
Select the output jack and set the output level (volume) of the sounds passing through the Multi-effects. You can also apply Chorus or Reverb to the sound that passes through Multi-effects.
- 6. Making Chorus Settings (-> p. 76)**
Select the Chorus type to be used, and set each of the parameters for the selected Chorus.
- 7. Setting the Output Destination and Volume for the Sounds Passing Through the Chorus (-> p. 80)**
Select the output jack and set the output level (volume) of the sounds passing through the Chorus. You can also apply Reverb to the sound that passes through Chorus.
- 8. Making Reverb Settings (-> p. 76)**
Select the Reverb type to be used, and set each of the parameters for the selected Reverb.
- 9. Setting the Output Destination and Volume for the Sounds Passing Through the Reverb (-> p. 81)**
Select the output jack and set the output level (volume) of the sounds passing through the Reverb.

Audio Signal Flow

The audio path of direct sounds or sounds that have been passed through the effects in Patch/Rhythm Set mode is shown in the figure below.

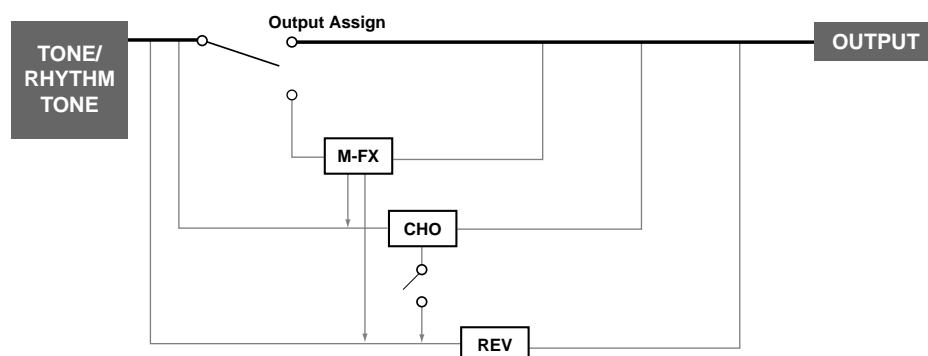

PATCH/RHYTHM KEY TVA

Parameter	Value	Description
SEND LEVEL DRY (Dry Send Level)	0-127	Sets the direct sound's volume for each Tone or Rhythm Tone. When Multi-effects are being applied, this sets the amount of the effect that is applied; when Multi-effects are not applied, this sets the volume of the direct sound.
SEND LEVEL CHO (Tone Chorus Send Level)	0-127	Sets the chorus depth for individual Tone/Rhythm Tone. If you don't want to add the Chorus effect, set it to 0.
SEND LEVEL REV (Tone Reverb Send Level)	0-127	Sets the reverb depth for individual Tone/Rhythm Tone. If you don't want to add the Reverb effect, set it to 0.
OUTPUT ASSIGN (Tone Output Assign)	MFX, A, 1, 2	Sets the direct sound's output method for each Tone or Rhythm Tone. MFX: Output in stereo through Multi-effects. You can also apply Chorus or Reverb to the sound that passes through Multi-effects. A: Output from OUTPUT. 1: Output from L. 2: Output from R.



- When the Output Assign parameter (p. 46)/(p. 63) is set to anything but TONE, the setting made here has no effect.
- When outputting in mono, the Pan setting is disabled.
- Chorus and Reverb are output in mono at all times.



When the STRUCTURE (PATCH:COMMON) parameter has a setting of Type 2-10, the outputs of Tones 1 and 2 will be combined with Tone 2, and the outputs of Tones 3 and 4 will be combined with Tone 4. For this reason, the setting of Tone 1 will follow the setting of Tone 2, and the setting of Tone 3 will follow the setting of Tone 4 (p. 48).



For more on how to set each effect, refer to the pages shown below.

- Multi-effects -> (p. 76)
- Chorus -> (p. 76)
- Reverb -> (p. 76)

Performance Mode Settings

The Multi-effect can be used in a Performance.

While you set the amount of effect applied separately to each individual part, depending on the settings, you can also make the amount of the Tone applied more effective. Furthermore, you can take the Multi-effects you have applied to a Patch in a Part and apply them to the entire Performance, or just part of the Performance.

* On the XV-2020, only the MFX-A settings are valid in Performance mode.

Basic Process of Making Effects Settings

When applying effects in Performance mode, the following procedure is used to make the settings.

- 1. Setting the Output Method Used by the Direct Sound (Output Assign) (-> p. 79)**
 Settings determining whether or not the signal passes through the Multi-effects, the jack used to output the sound, and the type of output (stereo or mono) for each Part. You can also settings for a Patch or Rhythm Set assigned to a Part.
- 2. Setting the Amount of Each Effect Applied (Send Level -> p. 79)**
 Sets the level (volume) of each effect signal to be sent for each Part.
- 3. Making Multi-Effects Settings (-> p. 80)**
 Select the type of Multi-effects to be used, and set the parameters for the selected Multi-effect. You can also Multi-effects settings for a Patch or Rhythm Set assigned to a Part.
- 4. Setting the Multi-Effects Controller (-> p. 80)**
 When using MIDI messages to change the Multi-effects parameters in realtime, select the Multi-effects controller.
- 5. Setting the Output Destination and Volume for the Sounds Passing Through the Multi-Effects (-> p. 80)**
 Select the output jack and set the output level (volume) of the sounds passing through the Multi-effects. You can also apply Chorus or Reverb to the sound that passes through Multi-effects.

6. Making Chorus Settings (-> p. 80)

Select the Chorus type to be used, and set each of the parameters for the selected Chorus.

7. Setting the Output Destination and Volume for the Sounds Passing Through the Chorus (-> p. 80)

Select the output jack and set the output level (volume) of the sounds passing through the Chorus. You can also apply Reverb to the sound that passes through Chorus.

8. Making Reverb Settings (-> p. 80)

Select the Reverb type to be used, and set each of the parameters for the selected Reverb.

9. Setting the Output Destination and Volume for the Sounds Passing Through the Reverb (-> p. 80)

Select the output jack and set the output level (volume) of the sounds passing through the Reverb.

Audio Signal Flow

The audio path of direct sounds or sounds that have been passed through the effects in Performance mode is shown in the figure below.

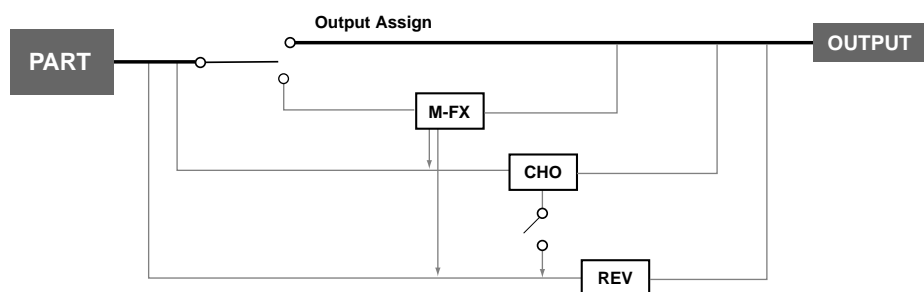

PERFORM PART ALL (Performance Part All Parameter)

Parameter	Value	Description
SEND LEVEL DRY (Part Dry Send Level)	0-127	Sets the direct sound's volume for each Part. When Multi-effects are being applied, this sets the amount of the effect that is applied; when Multi-effects are not applied, this sets the volume of the direct sound.
SEND LEVEL CHO (Part Chorus Send Level)	0-127	Adjusts the amount of Chorus for each Part. If you don't want to add the Chorus effect, set it to 0.
SEND LEVEL REV (Part Reverb Send Level)	0-127	Adjusts the amount of Reverb for each Part. If you don't want to add the Reverb effect, set it to 0.
OUTPUT ASSIGN (Output Assign)	MFx, A, 1, 2, PAT	Sets the direct sound's output method for each Tone or Rhythm Tone. MFx: Output in stereo through Multi-effects. You can also apply Chorus or Reverb to the sound that passes through Multi-effects. A: Output to the OUTPUT jacks in stereo without passing through Multi-effects. 1: Output from L. 2: Output from R. PAT: The Part's output destination is determined by the settings of the Patch or Rhythm Set assigned to the Part.



When outputting in mono, the Pan setting is disabled.

- Chorus and Reverb are output in mono at all times.
- When the settings are such that signals are split and output from the L jack and R jack, and no plug is inserted in the R jack, the sounds from L and R are mixed together, then output from the L jack. This sound comprises the sounds from the L and 2 jacks.



When the Output Assign parameter is set to PATCH, the output level settings for the Patch or Rhythm Set as well as the Part go into effect. If you want the various level settings of the Patch/Rhythm Set to be reflected as they are, set the various Part levels to 127 (maximum).



For more on how to set each effect, refer to the pages shown below.

- Multi-effects -> (p. 80)
- Chorus -> (p. 81)
- Reverb -> (p. 81)

Multi-Effects Parameter

PATCH/RHYTHM MFX, PERFORM MFX (Multi-Effects Settings)

Parameter	Value	Description
TYPE (Multi-Effects Type)	00 (THROUGH) -40	Use this parameter to select from among the 40 available Multi-effects. * For details on Multi-effects parameters, refer to " Multi-Effects Parameters (p. 82)."
SEND LEVEL DRY (Multi-Effects Dry Send Level)	0-127	Adjusts the volume of the sound that has passed through the Multi-effects.
SEND LEVEL CHO (Multi-Effects Chorus Send Level)	0-127	Adjusts the amount of Chorus for the sound that passes through Multi-effects. If you don't want to add the Chorus effect, set it to 0.
SEND LEVEL REV (Multi-Effects Reverb Send Level)	0-127	Adjusts the amount of Reverb for the sound that passes through Multi-effects. If you don't want to add the Reverb effect, set it to 0.
CONTROL SOURCE 1-4 (Multi-Effects Control Source)	OFF, CC01-31, CC33-95, BEND, AFTER, SYS1-4	Selects the Control Source to be used for changing the Multi-effects parameters.
DESTINATION 1-4 (Multi-Effects Control Destination 1-4)	Refer to " Multi-Effects Parameters (p. 82)."	Selects the Multi-effects parameter to be controlled using Ctrl Src 1-4. The parameters that can be selected depend on which type of Multi-effects is set to MFX Type.
SENS 1-4 (Multi-Effects Control Sensitivity 1-4)	-63-+63	If you wish to modify the selected parameter in a positive (+) direction—i.e., a higher value, toward the right, or faster, etc.—from its current setting, select a positive (+) value. If you wish to modify the selected parameter in a negative (-) direction—i.e., a lower value, toward the left, or slower, etc.—from its current setting, select a negative (-) value. Higher numbers produce a greater amount of change.
SOURCE MFX (Multi-Effects Source)	PERFORM, PART 1-16	Selects the Multi-effects parameter settings that will be used by the Performance. If you wish to use the Performance settings, select PERFORM. If you wish to use the settings of the Patch/Rhythm Set assigned to one of the Parts, select the Part number. (When using the XV Editor, you can make this setting in the PERFORM PART ALL screen. p. 71)

PATCH/PERFORMANCE CHORUS (Chorus Settings)

Parameter	Value	Description
TYPE (Chorus Type)	OFF, CHORUS	This determines whether or not chorus is used.
LEVEL (Chorus Level)	0-127	Adjusts the volume of the sound that has passed through chorus.
OUTPUT SELECT (Chorus Output Select)	MAIN, REV, MAIN+REV	Specifies how the sound routed through Chorus will be output. MAIN: Output to the OUTPUT jacks in stereo. REV: Output to Reverb in mono. MAIN+REV: Output to the OUTPUT jacks in stereo, and to Reverb in mono. * Used in Performance mode.
CHORUS (Chorus Source)	PERFORM, PART 1-16	Selects the Chorus parameter settings that will be used by the Performance. If you wish to use the Performance settings, select PERFORM. If you wish to use the settings of the Patch/Rhythm Set assigned to one of the Parts, select the Part number. * Used in Performance mode.

PATCH/PERFORMANCE REVERB (Reverb Settings)

Parameter	Value	Description
TYPE (Reverb Type)	OFF, REVERB	This determines whether or not reverb is used.
LEVEL (Reverb Level)	0-127	Adjusts the volume of the sound that has passed through Reverb.
REVERB (Reverb Source)	PERFORM, PART 1-16	Selects the Reverb parameter settings that will be used by the Performance. If you wish to use the Performance settings, select PERFORM. If you wish to use the settings of the Patch/Rhythm Set assigned to one of the Parts, select the Part number. * Used in Performance mode.

PATCH/RHYTHM/PERFORM CHORUS (Chorus Parameters)

Parameter	Value	Description
RATE	0.05–10.00 Hz	Frequency of modulation
DEPTH	0–127	Depth of modulation
PRE-DELAY	0.0–100.0 ms	Adjusts the time until the chorus is heard.
FEEDBACK	0–127	Adjusts the amount of the chorus sound that's fed back into the effect.
FILTER TYPE	OFF, LPF, HPF	Type of filter OFF: no filter is used LPF: cuts the frequency range above the Cutoff Freq HPF: cuts the frequency range below the Cutoff Freq
CUTOFF	200–8000 Hz	Basic frequency of the filter.
PHASE	0–180 deg	Spatial spread of the sound.

PATCH/RHYTHM/PERFORM REVERB (Reverb Parameters)

These settings allow you to select the desired type of reverb and its characteristics.

Parameter	Value	Description
TYPE	ROOM1, ROOM2, STAGE1, STAGE2, HALL1, HALL2, DELAY, PAN-DELAY	Type of reverb/delay ROOM1: short reverb with high density ROOM2: short reverb with low density STAGE1: reverb with greater late reverberation STAGE2: reverb with strong early reflections HALL1: very clear-sounding reverb HALL2: rich reverb DELAY: conventional delay effect PAN-DELAY: delay effect with echoes that pan left and right
TIME	0–127	Time length of reverberation (Type: ROOM1–HALL2) Delay time (Type: DELAY, PAN-DELAY)
HF DAMP	200–8000 Hz, BYPASS	Adjusts the frequency above which the high-frequency content of the reverb sound is cut, or “damped.” If you don't want to damp the high frequencies, set this parameter to BYPASS.
FEEDBACK	0–127	Adjusts the amount of delay feedback when the Type setting is DELAY or PAN-DELAY.

Multi-Effects Parameters

The multi-effects feature 90 different kinds of effects. Some of the effects consist of two or more different effects connected in series or in parallel.

Parameters marked with a sharp “#” can be simultaneously controlled using the selected controller.

- 1: STEREO EQ (p. 82)
- 2: OVERDRIVE (p. 82)
- 3: DISTORTION (p. 82)
- 4: PHASER (p. 83)
- 5: SPECTRUM (p. 83)
- 6: ENHANCER (p. 83)
- 7: AUTO WAH (p. 83)
- 8: ROTARY (p. 83)
- 9: COMPRESSOR (p. 84)
- 10: LIMITER (p. 84)
- 11: HEXA-CHORUS (p. 84)
- 12: TREMOLO CHORUS (p. 84)
- 13: SPACE-D (p. 85)
- 14: STEREO CHORUS (p. 85)
- 15: STEREO FLANGER (p. 85)
- 16: STEP FLANGER (p. 85)
- 17: STEREO DELAY (p. 86)
- 18: MODULATION DELAY (p. 86)
- 19: TRIPLE TAP DELAY (p. 87)
- 20: QUADRUPLE TAP DELAY (p. 87)
- 21: TIME CONTROL DELAY (p. 87)
- 22: 2 VOICE PITCH SHIFTER (p. 87)
- 23: FB PITCH SHIFTER (p. 88)
- 24: REVERB (p. 88)
- 25: GATED REVERB (p. 88)
- 26: OVERDRIVE -> CHORUS (p. 88)
- 27: OVERDRIVE -> FLANGER (p. 89)
- 28: OVERDRIVE -> DELAY (p. 89)
- 29: DISTORTION -> CHORUS (p. 89)
- 30: DISTORTION -> FLANGER (p. 89)
- 31: DISTORTION -> DELAY (p. 89)
- 32: ENHANCER -> CHORUS (p. 89)
- 33: ENHANCER -> FLANGER (p. 90)
- 34: ENHANCER -> DELAY (p. 90)
- 35: CHORUS -> DELAY (p. 90)
- 36: FLANGER -> DELAY (p. 90)
- 37: CHORUS -> FLANGER (p. 91)
- 38: CHORUS/DELAY (p. 91)
- 39: FLANGER/DELAY (p. 91)
- 40: CHORUS/FLANGER (p. 91)

1: STEREO EQ (Stereo Equalizer)

This is a four-band stereo equalizer (low, mid x 2, high).

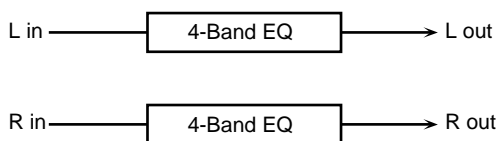

Parameter	Value	Description
Low Freq	200, 400 Hz	Frequency of the low range
Low Gain	-15-+15 dB	Gain of the low frequency range
Mid1 Freq	200-8000 Hz	Frequency of Middle Range 1
Mid1 Gain	-15-+15 dB	Gain of Middle Range 1
Mid1 Q	0.5, 1.0, 2.0, 4.0, 8.0	Width of Middle Range 1 Select a higher Q value to narrow Middle Range 1.
Mid2 Freq	200-8000 Hz	Frequency of Middle Range 2
Mid2 Gain	-15-+15 dB	Gain of Middle Range 2
Mid2 Q	0.5, 1.0, 2.0, 4.0, 8.0	Width of Middle Range 2 Select a higher Q value to narrow Middle Range 2.
High Freq	2000, 4000, 8000 Hz	Frequency of the high range
High Gain	-15-+15 dB	Gain of the high frequency range
Level #	0-127	Output level

2: OVERDRIVE

Creates a soft distortion similar to that produced by vacuum tube amplifiers.

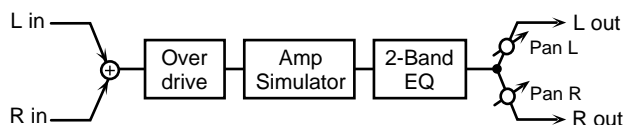

Parameter	Value	Description
Drive #	0-127	Amount of distortion Also changes the volume.
Amp Type	SMALL, BUILT-IN, 2-STACK, 3-STACK	Type of guitar amp SMALL: small amp BUILT-IN: single-unit type amp 2-STACK: large double-stack amp 3-STACK: large triple-stack amp
Low Gain	-15-+15 dB	Gain of the low frequency range
High Gain	-15-+15 dB	Gain of the high frequency range
Level	0-127	Output level
Pan #	L64-63R	Stereo location of the OVERDRIVE output

3: DISTORTION

Produces a more intense distortion than Overdrive. The parameters are the same as for “2: OVERDRIVE.”

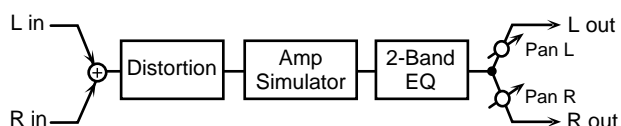

4: PHASER

Adds a phase-shifted sound to the original sound, producing a swirling modulation that creates spaciousness and depth.

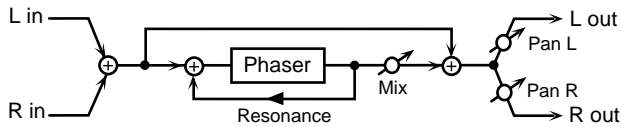

Parameter	Value	Description
Manual #	100-8000 Hz	Adjusts the basic frequency at which the sound will be modulated.
Rate #	0.05-10.00 Hz	Frequency of modulation
Depth	0-127	Depth of modulation
Resonance	0-127	Amount of feedback
Mix Level	0-127	Level of the phase-shifted sound
Level	0-127	Output Level
Pan	L64-63R	Stereo location of the PHASER output

5: SPECTRUM

This is a type of filter that modifies the timbre by boosting or cutting the level of specific frequencies. It is similar to an equalizer, but has eight frequency points fixed at locations most useful for adding character to the sound.

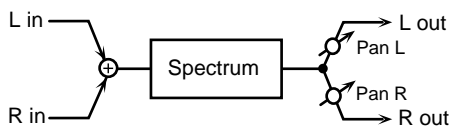

Parameter	Value	Description
250Hz Gain	-15+15 dB	Gain of each frequency band
500Hz Gain		
1000Hz Gain		
1250Hz Gain		
2000Hz Gain		
3150Hz Gain		
4000Hz Gain		
8000Hz Gain		
Band Width Q	0.5, 1.0, 2.0, 4.0, 8.0	Simultaneously adjusts the width of the adjusted ranges for all of the frequency bands.
Level #	0-127	Output level
Pan #	L64-63R	Stereo location of the SPECTRUM output

6: ENHANCER

Controls the overtone structure of the high frequencies, adding sparkle and brightness to the sound.

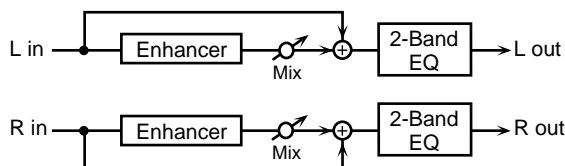

Parameter	Value	Description
Sens #	0-127	Sensitivity of the enhancer
Mix #	0-127	Level of the overtones generated by the enhancer
Low Gain	-15+15 dB	Gain of the low frequency range of frequencies
High Gain	-15+15 dB	Gain of the high frequency range of frequencies
Level	0-127	Output level

7: AUTO WAH

A filter that turns on and off to create a cyclical change in timbre.

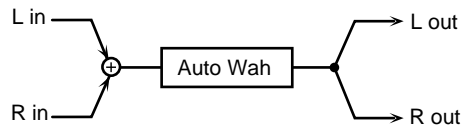

Parameter	Value	Description
Filter Type	L.PF, B.PF	Type of filter L.PF: The wah effect is applied over a wide frequency range. B.PF: The wah effect is applied over a narrow frequency range
Sens	0-127	Adjusts the sensitivity with which the filter is controlled.
Manual #	0-127	Adjusts the center frequency at which the effect is applied.
Peak	0-127	Adjusts the amount of the wah effect that occurs in the range of the center frequency. Set a higher value for Q to narrow the range to be affected.
Rate #	0.05-10.00 Hz	Frequency of modulation
Depth	0-127	Depth of modulation
Level	0-127	Output level

8: ROTARY

The Rotary effect simulates the sound of the rotary speakers often used with the classic electric organs. Since the movement of the high-range and low-range rotors can be set independently, the unique characteristics of these speakers can be simulated quite accurately. This effect is most suitable for electric organ Patches.

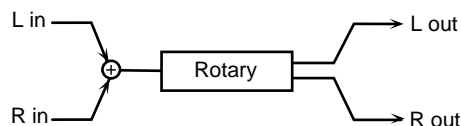

Parameter	Value	Description
Speed #	SLOW, FAST	Simultaneously switches the rotational speed of the low frequency rotor and high frequency rotor. SLOW: Slows down the speed to the Slow Rate. FAST: Speeds up the speed to the Fast Rate.
Low Slow	0.05-10.00 Hz	Slow speed (SLOW) of the low-frequency rotor
Low Fast	0.05-10.00 Hz	Fast speed (FAST) of the low-frequency rotor
Low Accel	0-15	Adjusts the time it takes the low frequency rotor to reach the newly selected speed when switching between fast and slow speeds. Lower values result in longer transitions.
Low Level	0-127	Volume of the low frequency rotor
High Slow	0.05-10.00 Hz	Settings for the high-frequency rotor The parameters are the same as for the low-frequency rotor
High Fast	0.05-10.00 Hz	
High Accel	0-15	
High Level	0-127	
Separation	0-127	Stereo width of the sound
Level #	0-127	Output level

Using the XV-2020 Effects

9: COMPRESSOR

Flattens out high levels and boosts low levels, smoothing out fluctuations in volume.

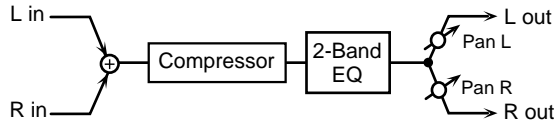

Parameter	Value	Description
Attack	0-127	Sets the speed at which compression starts
Sustain	0-127	Sets the duration of the compression.
Post Gain	0, +6, +12, +18 dB	Adjusts the output gain.
Low Gain	-15-+15 dB	Gain of the low frequency range
High Gain	-15-+15 dB	Gain of the high frequency range
Level #	0-127	Output level
Pan #	L64-63R	Stereo location of the COMPRESSOR output

10: LIMITER

Compresses signals that exceed a specified volume level, preventing distortion from occurring.

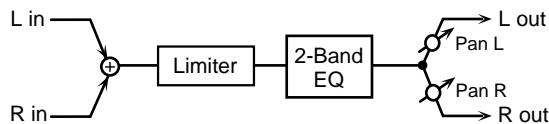

Parameter	Value	Description
Threshold	0-127	Adjusts the volume at which compression begins
Ratio	1.5:1, 2:1, 4:1, 100:1	Compression ratio
Release	0-127	Adjusts the time after the signal volume falls below the Threshold Level until compression is no longer applied.
Post Gain	0, +6, +12, +18 dB	Adjusts the output gain.
Low Gain	-15-+15 dB	Gain of the low frequency range
High Gain	-15-+15 dB	Gain of the high frequency range
Level #	0-127	Output level
Pan #	L64-63R	Stereo location of the LIMITER output

11: HEXA-CHORUS

Uses a six-phase chorus (six layers of chorused sound) to give richness and spaciousness to the sound.

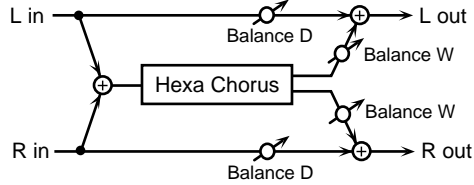

Parameter	Value	Description
Rate #	0.05-10.00 Hz	Frequency of modulation
Depth	0-127	Depth of modulation
Depth Deviation	-20-+20	Adjusts the difference in modulation depth between each chorus layer.
Pre Delay	0.0-100.0 ms	Adjusts the time until chorusing is heard.
Delay Deviation	0-20	Adjusts the differences in Pre Delay between each chorus layer.
Pan Deviation	0-20	Adjusts the difference in stereo location between each chorus layer. 0: All chorus layers are in the center. 20: The chorus layers are spaced at 60-degree intervals relative to the center.
Balance #	D100:0W- D0:100W	Volume balance between the direct sound (D) and the chorus sound (W)
Level	0-127	Output level

12: TREMOLO CHORUS

This is a chorus effect with added Tremolo (cyclic modulation of volume).

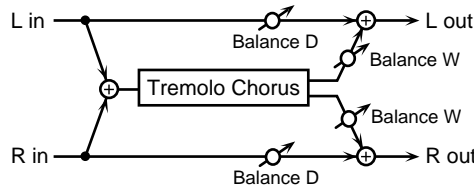

Parameter	Value	Description
Cho Rate	0.05-10.00 Hz	Modulation frequency of the chorus effect
Chorus Depth	0-127	Modulation depth of the chorus effect
Pre Delay	0.0-100.0 ms	Adjusts the time until the chorus sound is heard.
Treml Rate #	0.05-10.00 Hz	Modulation frequency of the tremolo effect
Phase	0-180 deg	Depth of the tremolo effect
Treml Separation	0-127	Spread of the tremolo effect
Balance #	D100:0W- D0:100W	Volume balance between the direct sound (D) and the tremolo chorus sound (W)
Level	0-127	Output level

13: SPACE-D

This is a multiple chorus that applies two-phase modulation in stereo. It creates no audible modulation, yet produces a transparent chorus effect.

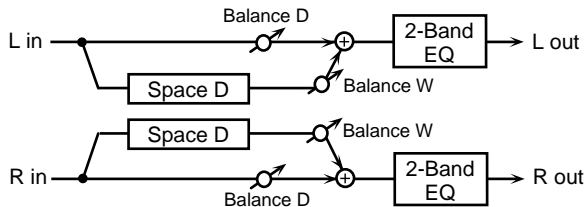

Parameter	Value	Description
Cho Rate #	0.05-10.00 Hz	Frequency of modulation
Cho Depth	0-127	Depth of modulation
Cho Phase	0-180 deg	Spatial spread of the sound
Pre Delay	0.0-100.0 ms	Adjusts the time until the chorus sound is heard.
Low Gain	-15-+15 dB	Gain of the low frequency range
High Gain	-15-+15 dB	Gain of the high frequency range
Balance #	D100:0W- D0:100W	Volume balance between the direct sound (D) and the chorus sound (W)
Level	0-127	Output level

14: STEREO CHORUS

This is a stereo chorus. A filter is provided so that you can adjust the timbre of the chorused sound.

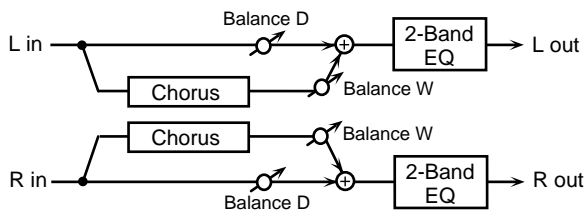

Parameter	Value	Description
Rate #	0.05-10.00 Hz	Frequency of modulation
Depth	0-127	Depth of modulation
Phase	0-180 deg	Spatial spread of the sound
Pre Delay	0.0-100.0 ms	Adjusts the time until the chorus sound is heard.
Filter Type	OFF, LPF, HPF	Type of filter OFF: no filter is used LPF: cuts the frequency range above the Cutoff Freq HPF: cuts the frequency range below the Cutoff Freq
Cutoff Freq	200-8000 Hz	Basic frequency of the filter
Low Gain	-15-+15 dB	Gain of the low frequency range
High Gain	-15-+15 dB	Gain of the high frequency range
Balance #	D100:0W- D0:100W	Volume balance between the direct sound (D) and the chorus sound (W)
Level	0-127	Output level

15: STEREO FLANGER

This is a stereo flanger. (The LFO has the same phase for left and right.) It produces a metallic resonance that rises and falls somewhat like a jet airplane taking off or landing. A filter is provided so that you can adjust the timbre of the flanged sound.

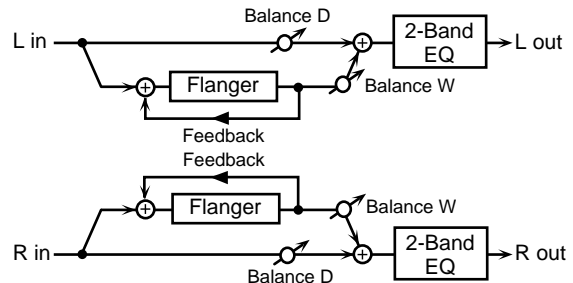

Parameter	Value	Description
Rate #	0.05-10.00 Hz	Frequency of modulation
Depth	0-127	Depth of modulation
Feedback #	-98-+98%	Adjusts the amount of the flanger sound that's fed back into the effect. Negative (-) settings invert the phase.
Phase	0-180 deg	Spatial spread of the sound
Pre Delay	0.0-100.0 ms	Adjusts the time until the flanger sound is heard.
Filter Type	OFF, LPF, HPF	Type of filter OFF: no filter is used LPF: cuts the frequency range above the Cutoff Freq HPF: cuts the frequency range below the Cutoff Freq
Cutoff Freq	200-8000 Hz	Basic frequency of the filter
Low Gain	-15-+15 dB	Gain of the low frequency range
High Gain	-15-+15 dB	Gain of the high frequency range
Balance	D100:0W- D0:100W	Volume balance between the direct sound (D) and the flanger sound (W)
Level	0-127	Output level

16: STEP FLANGER

This is a flanger in which the flanger pitch changes in steps. The speed at which the pitch changes can also be specified in terms of a note value based on a specified tempo.

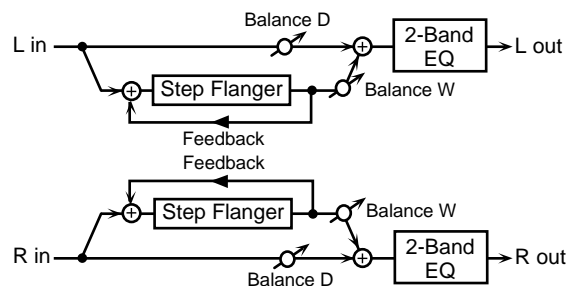

Parameter	Value	Description
Rate	0.05-10.00 Hz	Frequency of modulation
Depth	0-127	Depth of modulation
Feedback #	-98-+98 %	Adjusts the amount of the flanger sound that's fed back into the effect. Negative (-) settings invert the phase.
Phase	0-180 deg	Spatial spread of the sound
Pre Delay	0.0-100.0 ms	Adjusts the time until the flanger sound is heard.
Step Rate #	0.10-20.00 Hz, note *1	Rate (period) of pitch change
Low Gain	-15-+15 dB	Gain of the low frequency range
High Gain	-15-+15 dB	Gain of the high frequency range
Balance	D100:0W-D0:100W	Volume balance between the direct sound (D) and the flanger sound (W)
Level	0-127	Output level

17: STEREO DELAY

This is a stereo delay.

When Mode is **NORMAL**:

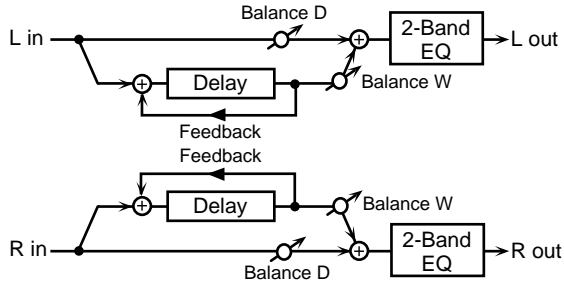

When Mode is **CROSS**:

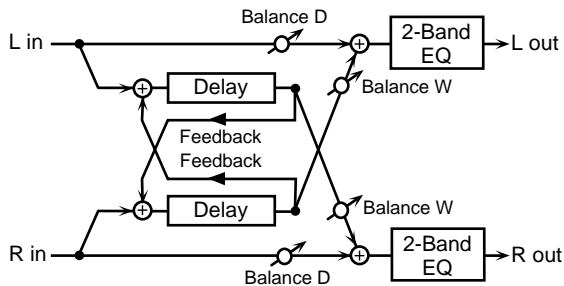

Parameter	Value	Description
Delay L	0.0-500.0 ms	Adjusts the time until the delay sound is heard.
Delay R		
Feedback #	-98-+98 %	Adjusts the amount of the delay sound that's fed back into the effect. Negative (-) settings invert the phase.
Mode	NORMAL, CROSS	Selects the way in which delay sound is fed back into the effect. (See the figures above.)
HF Damp	200-8000 Hz, BYPASS	Adjusts the frequency above which sound fed back to the effect is filtered out. If you don't want to filter out any high frequencies, set this parameter to BYPASS.
Phase L	NORMAL, INVERT	Phase of the delay sound
Phase R		
Low Gain	-15-+15 dB	Gain of the low frequency range
High Gain	-15-+15 dB	Gain of the high frequency range
Balance #	D100:0W-D0:100W	Volume balance between the direct sound (D) and the delay sound (W)
Level	0-127	Output level

18: MODULATION DELAY

Adds modulation to the delayed sound, producing an effect similar to a flanger.

When Mode is **NORMAL**:

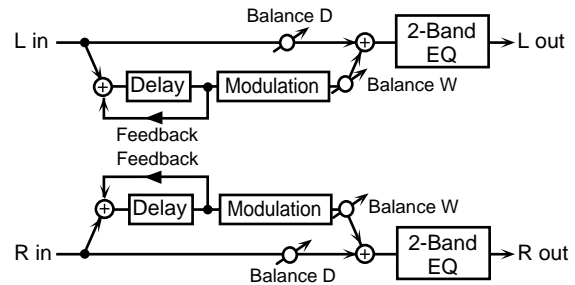

When Mode is **CROSS**:

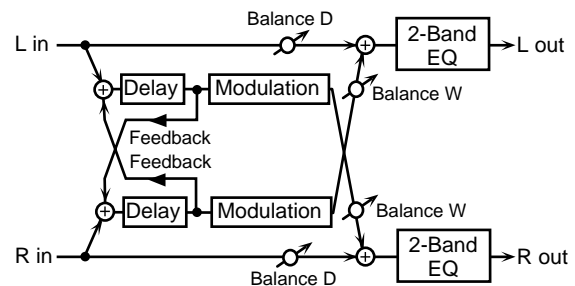

Parameter	Value	Description
Delay Left	0.0-500.0 ms	Adjusts the time until the delay sound is heard.
Delay Right		
Feedback	-98-+98 %	Adjusts the amount of the delay sound that's fed back into the effect. Negative (-) settings invert the phase.
Mode	NORMAL, CROSS	Selects the way in which delay sound is fed back into the effect (See the figures above.)
HF Damp	200-8000 Hz, BYPASS	Adjusts the frequency above which sound fed back to the effect is filtered out. If you don't want to filter out any high frequencies, set this parameter to BYPASS.
Rate #	0.05-10.00 Hz	Frequency of modulation
Depth	0-127	Depth of modulation
Phase	0-180 deg	Spatial spread of the sound
Low Gain	-15-+15 dB	Gain of the low frequency range
High Gain	-15-+15 dB	Gain of the high frequency range
Balance #	D100:0W-D0:100W	Volume balance between the direct sound (D) and the delay sound (W)
Level	0-127	Output level

19: TRIPLE TAP DELAY

Produces three delay sounds; center, left and right.

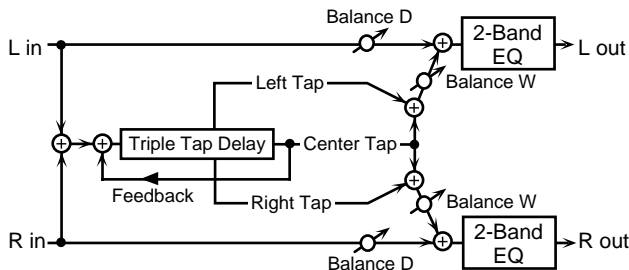

Parameter	Value	Description
Delay C	200-1000	Adjusts the time until the delay sound is heard.
Delay L	ms, note *1	
Delay R		
Feedback #	-98-+98 %	Adjusts the amount of the delay sound that's fed back into the effect. Negative (-) settings invert the phase.
HF Damp	200-8000 Hz, BYPASS	Adjusts the frequency above which sound fed back to the effect is filtered out. If you do not want to filter out any high frequencies, set this parameter to BYPASS.
Delay C Level	0-127	Volume of each delay
Delay L Level		
Delay R Level		
Low Gain	-15-+15 dB	Gain of the low frequency range
High Gain	-15-+15 dB	Gain of the high frequency range
Balance #	D100:0W-D0:100W	Volume balance between the direct sound (D) and the delay sound (W)
Level	0-127	Output level

20: QUADRUPLE TAP DELAY

This effect has four delays.

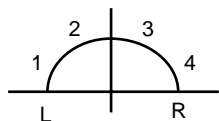
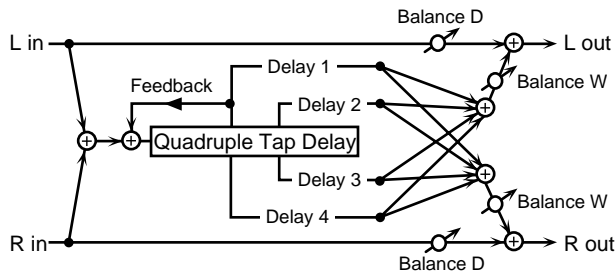

Stereo location of each delay

Parameter	Value	Description
Delay 1	200-1000	Adjusts the time until the delay sound is heard.
Delay 2	ms, note *1	
Delay 3		
Delay 4		
Feedback #	-98-+98 %	Adjusts the amount of the delay sound that's fed back into the effect. Negative (-) settings invert the phase.
HF Damp	200-8000 Hz, BYPASS	Adjusts the frequency above which sound fed back to the effect is filtered out. If you do not want to filter out any high frequencies, set this parameter to BYPASS.
Delay Level 1	0-127	Volume of each delay
Delay Level 2		
Delay Level 3		
Delay Level 4		
Balance #	D100:0W-D0:100W	Volume balance between the direct sound (D) and the delay sound (W)
Level	0-127	Output level

21: TIME CONTROL DELAY

This effect allows you to use a specified controller — the controller selected in EFX Control Source — to control the delay time and pitch in realtime. Lengthening the delay lowers the pitch, and shortening it raises the pitch.

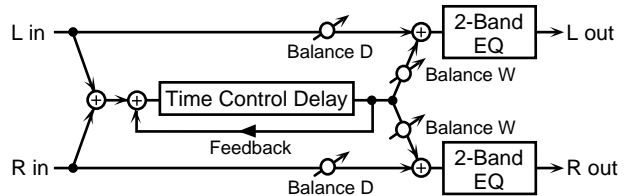

Parameter	Value	Description
Delay #	200-1000 ms	Adjusts the time until the delay is heard.
Acceleration	0-15	Adjusts the time over which the Delay Time changes from the current setting to a specified new setting. The rate of change for the Delay Time directly affects the rate of pitch change.
Feedback #	-98-+98 %	Adjusts the amount of the delay that's fed back into the effect. Negative (-) settings invert the phase.
HF Damp	200-8000 Hz, BYPASS	Adjusts the frequency above which sound fed back to the effect is filtered out. If you do not want to filter out any high frequencies, set this parameter to BYPASS.
Low Gain	-15-+15 dB	Gain of the low frequency range
High Gain	-15-+15 dB	Gain of the high frequency range
Balance	D100:0W-D0:100W	Volume balance between the direct sound (D) and the delay sound (W)
Level	0-127	Output level
Pan	L64-63R	Stereo location of the delay

22: 2 VOICE PITCH SHIFTER

Shifts the pitch of the original sound. This 2-voice pitch shifter has two pitch shifters, and can add two pitch-shifted versions of the original sound.

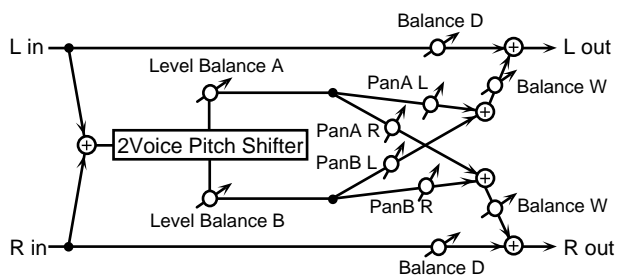

Parameter	Value	Description
Coarse A #1	-24-+12 semi	Adjusts the pitch of Pitch Shift A in semitone steps.
Fine A #1	-100-+100 cent	Adjusts the pitch of Pitch Shift A in 2-cent steps.
Pre Dly A	0.0-500 ms	Adjusts the time until Pitch Shift A is heard.
Pan A	L64-63R	Stereo location of Pitch Shift A
Coarse B #2	-24-+12 semi	Settings for Pitch Shift B The parameters are the same as for Pitch Shift A.
Fine B #2	-100-+100 cent	
Pre Dly B	0.0-500.0 ms	
Pan B	L64-63R	
Mode	1, 2, 3, 4, 5	Setting a higher value for this parameter results in a slower response, but steadier pitch.
Level Bal	A100:0B-A0:100B	Volume balance between Pitch Shift A and Pitch Shift B
Balance	D100:0W-D0:100W	Volume balance between the direct sound (D) and the pitch shifted sound (W)
Level	0-127	Output level

23: FB PITCH SHIFTER

This allows the pitch-shifted sound to be fed back into the effect.

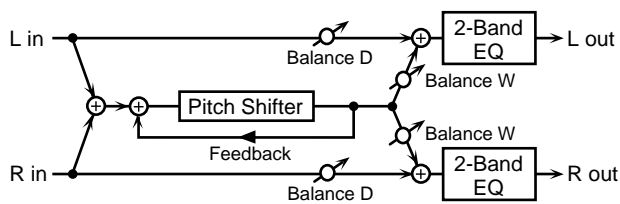

Parameter	Value	Description
Coarse #1	-24+12 semi	Adjusts the pitch of the pitch-shifted sound in semitone steps.
Fine #1	-100+100 cent	Adjusts the pitch of the pitch-shifted sound in 2-cent steps.
Pre Delay	0.0-500.0 ms	Adjusts the time until the pitch shifted sound is heard.
Mode	1, 2, 3, 4, 5	Setting a higher value for this parameter results in a slower response, but steadier pitch.
Feedback #	-98+98 %	Adjusts the amount of the pitch-shifted sound that's fed back into the effect. Negative (-) settings invert the phase.
Low Gain	-15+15 dB	Gain of the low frequency range
High Gain	-15+15 dB	Gain of the high frequency range
Balance	D100:0W-D0:100W	Volume balance between the direct sound (D) and the pitch-shifted sound (W)
Level	0-127	Output level
Pan	L64-63R	Stereo location of the pitch-shifted sound

24: REVERB

Adds reverberation to the sound, simulating an acoustic space.

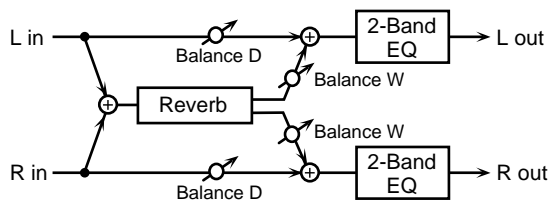

Parameter	Value	Description
Type	ROOM1, ROOM2, STAGE1, STAGE2, HALL1, HALL2	Type of reverb ROOM1 : dense reverb with short decay ROOM2 : sparse reverb with short decay STAGE1 : reverb with fewer early reflections STAGE2 : reverb with strong early reflections HALL1 : clear reverb HALL2 : rich reverb
Pre Delay	0.0-100.0 ms	Adjusts the time until the reverb is heard.
Time #	0-127	Duration of reverberation
HF Damp	200-8000 Hz, BYPASS	Adjusts the frequency above which the reverb is reduced in level. As the frequency is set lower, more of the high frequencies are cut, resulting in a softer and more muted reverb. If you don't want to cut any high frequencies, set this parameter to BYPASS.
Low Gain	-15+15 dB	Gain of the low frequency range
High Gain	-15+15 dB	Gain of the high frequency range
Balance #	D100:0W-D0:100W	Volume balance between the direct sound (D) and the reverb sound (W)
Level	0-127	Output level

25: GATED REVERB

This is a special type of reverb in which the reverb is cut off without being allowed to decay naturally.

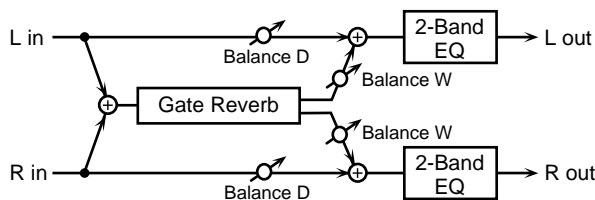

Parameter	Value	Description
Type	NORMAL, REVERSE, SWEEP1, SWEEP2	Type of reverb NORMAL : conventional gated reverb REVERSE : backwards reverb SWEEP1 : the reverb moves from right to left SWEEP2 : the reverb moves from left to right
Pre Delay	0.0-100.0 ms	Adjusts the time until the reverb sound is heard.
Gate Time	5-500 ms	Adjusts the time from when the reverb is first heard until it disappears.
Low Gain	-15+15 dB	Gain of the low frequency range
High Gain	-15+15 dB	Gain of the high frequency range
Balance #	D100:0W-D0:100W	Volume balance between the direct sound (D) and the reverb sound (W)
Level #	0-127	Output level

26: OVERDRIVE -> CHORUS

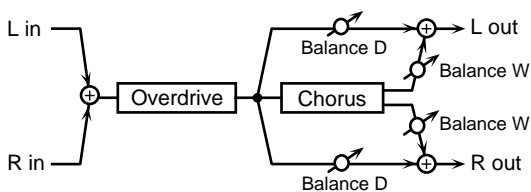

Parameter	Value	Description
OD Drive	0-127	Degree of distortion Also changes the volume.
OD Pan #	L64-63R	Stereo location of the overdrive
Cho Rate	0.05-10.00 Hz	Frequency of modulation
Cho Depth	0-127	Depth of modulation
Cho Delay	0.0-100.0 ms	Adjusts the time until the chorus sound is heard.
Cho Balance #	D100:0W-D0:100W	Adjusts the volume balance between the sound sent through the chorus (W) and the sound that's not sent through the chorus (D).
Level	0-127	Output level

27: OVERDRIVE -> FLANGER

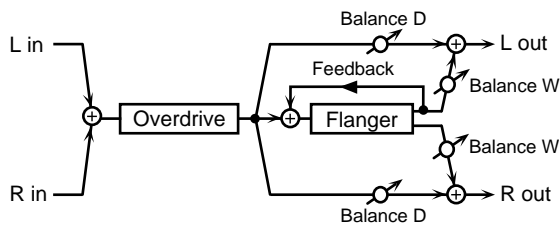

Parameter	Value	Description
OD Drive	0-127	Degree of distortion Also changes the volume.
OD Pan #	L64-63R	Stereo location of the overdrive
Flg Rate	0.05-10.00 Hz	Frequency of modulation
Flg Depth	0-127	Depth of modulation
Flg Feedback	-98-+98 %	Adjusts the amount of the flanger sound that's fed back into the effect. Negative (-) settings invert the phase.
Flg Delay	0.0-100.0 ms	Adjusts the time until the flanger is heard.
Flg Balance #	D100:0W- D0:100W	Adjusts the volume balance between the sound sent through the flanger (W) and the sound that's not sent through the flanger (D).
Level	0-127	Output level

28: OVERDRIVE -> DELAY

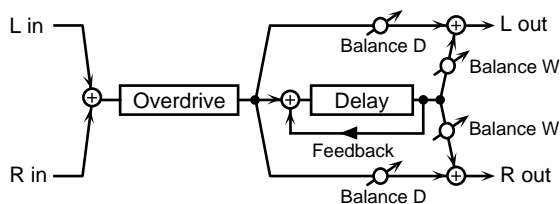

Parameter	Value	Description
OD Drive	0-127	Degree of distortion Also changes the volume.
OD Pan #	L64-63R	Stereo location of the overdrive
Delay Time	0.0-500.0 ms	Adjusts the time until the delay is heard.
Dly Feedback	-98-+98 %	Adjusts the amount of the delay sound that's fed back into the effect. Negative (-) settings invert the phase.
Dly HF Damp	200-8000 Hz, BYPASS	Adjusts the frequency above which sound fed back to the effect is filtered out. If you don't want to filter out any high frequencies, set this parameter to BYPASS.
Dly Balance #	D100:0W- D0:100W	Adjusts the volume balance between the sound sent through the delay (W) and the sound that's not sent through the delay (D).
Level	0-127	Output level

29: DISTORTION -> CHORUS

The parameters are essentially the same as in "26: OD -> CHORUS," with the exception of the following two.

OD Drive -> Dist Drive, OD Pan -> Dist Pan

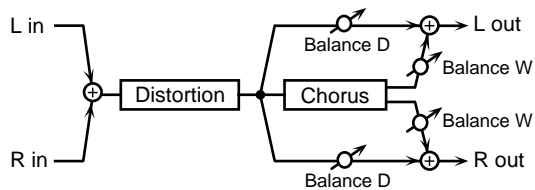

30: DISTORTION -> FLANGER

The parameters are essentially the same as in "27: OD -> FLANGER," with the exception of the following two.

OD Drive -> Dist Drive, OD Pan -> Dist Pan

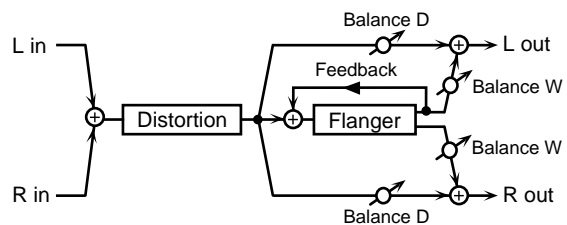

31: DISTORTION -> DELAY

The parameters are essentially the same as in "28: OD -> DELAY," with the exception of the following two.

OD Drive -> Dist Drive, OD Pan -> Dist Pan

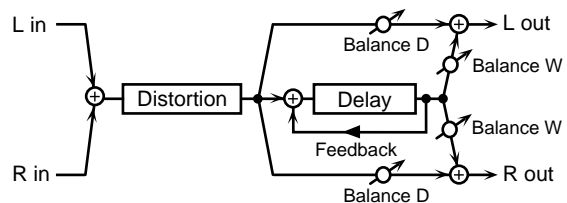

32: ENHANCER -> CHORUS

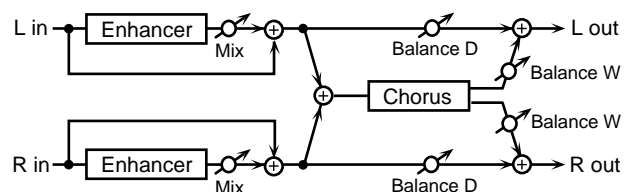

Parameter	Value	Description
Enhancer Sens #	0-127	Sensitivity of the enhancer
Enhancer Mix	0-127	Level of the overtones generated by the enhancer
Cho Rate	0.05-10.00 Hz	Frequency of modulation
Cho Depth	0-127	Depth of modulation
Cho Delay	0.0-100.0 ms	Adjusts the time until the chorus is heard.
Cho Balance #	D100:0W- D0:100W	Adjusts the volume balance between the sound sent through the chorus (W) and the sound that's not sent through the chorus (D).
Level	0-127	Output level

33: ENHANCER -> FLANGER

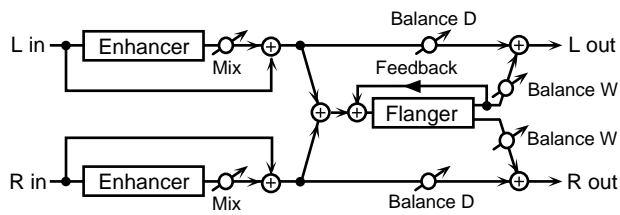

Parameter	Value	Description
Enhancer Sens #	0-127	Sensitivity of the enhancer
Enhancer Mix	0-127	Level of the overtones generated by the enhancer
Flg Rate	0.05-10.00 Hz	Frequency of modulation
Flg Depth	0-127	Depth of modulation
Flg Feedback	-98+98 %	Adjusts the amount of the flanger sound that's fed back into the effect. Negative (-) settings invert the phase.
Flg Delay	0.0-100.0 ms	Adjusts the time until the flanger is heard.
Flg Balance #	D100:0W- D0:100W	Adjusts the volume balance between the sound sent through the flanger (W) and the sound that's not sent through the flanger (D).
Level	0-127	Output level

34: ENHANCER -> DELAY

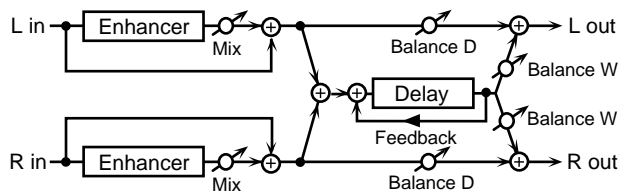

Parameter	Value	Description
Enhancer Sens #	0-127	Sensitivity of the enhancer
Enhancer Mix	0-127	Level of the overtones generated by the enhancer
Delay Time	0.0-500.0 ms	Adjusts the time until the delay is heard.
Dly Feedback	-98+98 %	Adjusts the amount of the delay sound that's fed back into the effect. Negative (-) settings will invert the phase.
Dly HF Damp	200-8000 Hz, BYPASS	Adjusts the frequency above which sound fed back to the effect is filtered out. If you don't want to filter out any high frequencies, set this parameter to BYPASS.
Dly Balance #	D100:0W- D0:100W	Adjusts the volume balance between the sound sent through the delay (W) and the sound that's not sent through the delay (D).
Level	0-127	Output level

35: CHORUS -> DELAY

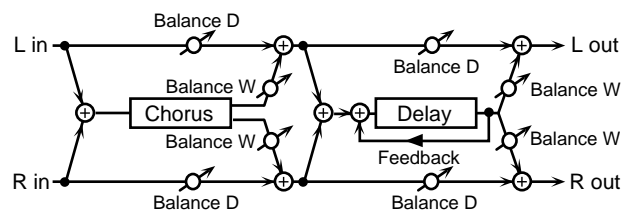

Parameter	Value	Description
Cho Rate	0.05-10.00 Hz	Frequency of modulation
Cho Depth	0-127	Depth of modulation
Cho Delay	0.0-100.0 ms	Adjusts the time until the chorus is heard.
Cho Balance #	D100:0W- D0:100W	Volume balance between the direct sound (D) and the chorus sound (W)
Delay Time	0.0-500.0 ms	Adjusts the time until the delay is heard.
Dly Feedback	-98+98 %	Adjusts the amount of the delay sound that's fed back into the effect. Negative (-) settings invert the phase.
Dly HF Damp	200-8000 Hz, BYPASS	Adjusts the frequency above which sound fed back to the effect is filtered out. If you do not want to filter out any the high frequencies, set this parameter to BYPASS.
Dly Balance #	D100:0W- D0:100W	Adjusts the volume balance between the sound sent through the delay (W) and the sound that's not sent through the delay (D).
Level	0-127	Output level

36: FLANGER -> DELAY

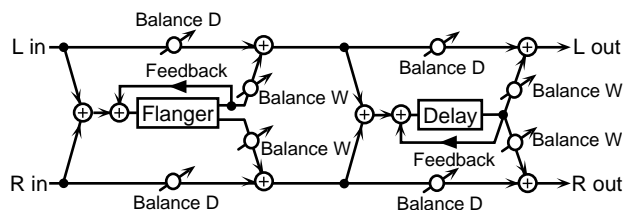

Parameter	Value	Description
Flg Rate	0.05-10.00 Hz	Frequency of modulation
Flg Depth	0-127	Depth of modulation
Flg Feedback	-98+98 %	Adjusts the amount of the flanger sound that's fed back into the effect. Negative (-) settings invert the phase.
Flg Delay	0.0-100.0 ms	Adjusts the time until the flanger is heard.
Flg Balance #	D100:0W- D0:100W	Volume balance between the direct sound (D) and the flanger sound (W)
Delay Time	0.0-500.0 ms	Adjusts the time until the delay sound is heard.
Dly Feedback	-98+98 %	Adjusts the amount of the delay sound that's fed back into the effect. Negative (-) settings invert the phase.
Dly HF Damp	200-8000 Hz, BYPASS	Adjusts the frequency above which sound fed back to the effect is filtered out. If you do not want to filter out any high frequencies, set this parameter to BYPASS.
Dly Balance #	D100:0W- D0:100W	Adjusts the volume balance between the sound sent through the delay (W) and the sound that's not sent through the delay (D).
Level	0-127	Output level

37: CHORUS -> FLANGER

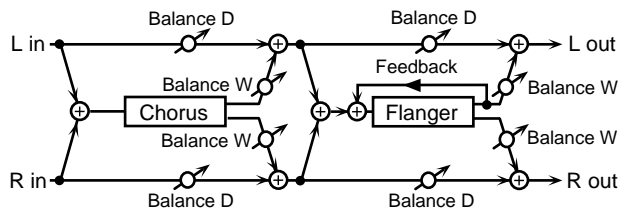

Parameter	Value	Description
Cho Delay	0.0-100.0 ms	Adjusts the time until the chorus is heard.
Cho Rate	0.05-10.00 Hz	Modulation frequency of the chorus effect
Cho Depth	0-127	Modulation depth of the chorus effect
Cho Balance #	D100:0W- D0:100W	Volume balance between the direct sound (D) and the chorus sound (W)
Flg Rate	0.05-10.00 Hz	Modulation frequency of the flanger effect
Flg Depth	0-127	Modulation depth of the flanger effect
Flg Feedback	-98+98 %	Adjusts the amount of the flanger sound that's fed back into the effect. Negative (-) settings invert the phase.
Flg Delay	0.0-100.0 ms	Adjusts the time until the flanger sound is heard.
Flg Balance #	D100:0W- D0:100W	Adjusts the volume balance between the sound sent through the flanger (W) and the sound that's not sent through the flanger (D).
Level	0-127	Output level

38: CHORUS/DELAY

The parameters are the same as for "35: CHORUS -> DELAY." However, the Delay Balance parameter adjusts the volume balance between the direct sound and the delay sound.

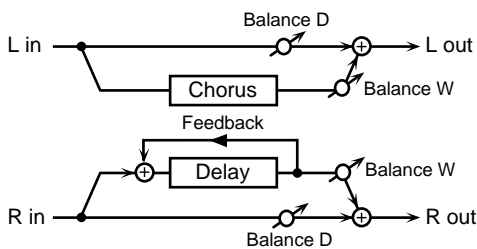

39: FLANGER/DELAY

The parameters are the same as for "36: FLG -> DELAY." However, the Delay Balance parameter adjusts the volume balance between the direct sound and the delay sound.

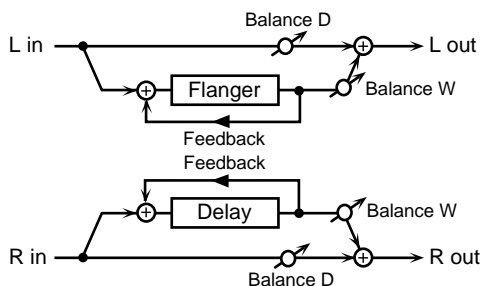

40: CHORUS/FLANGER

The parameters are the same as for "37: CHO -> FLANGER." However, the Flanger Balance parameter adjusts the volume balance between the direct sound and the flanger sound.

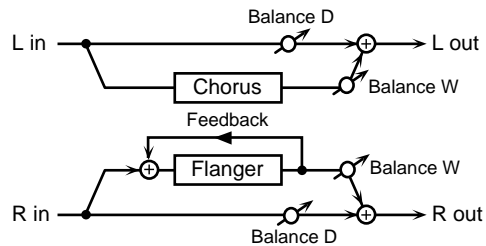

note*1

	Sixteenth note		Eighth-note triplet		Dotted sixteenth note
	Eighth note		Dotted eighth note		Quarter note
	Half-note triplet		Dotted quarter note		Half-note triplet
	Half note				

Saving a Sound You Create

Saving Edits to the XV-2020's Internal Memory (WRITE)

If you turn the power off or select another Patch, Rhythm Set, or Performance after you have modified a Patch, Rhythm Set or Performance, the changes you have made will be lost. If you wish to preserve the data, store it into the XV-2020's USER memory.

Never turn off the power to the XV-2020 while data is being saved

Saving a Patch/Rhythm Set/Performance

Saving from the XV-2020

1. Make sure that the Patch (Rhythm Set/Performance) you wish to save is selected.
2. While holding down [VOLUME], press [VALUE].
3. Turn [CATEGORY/BANK] to select "UTILITY (PIANO)."
4. Rotate [VALUE] until "wrt (wrt)" appears in the display.
5. Press [VALUE] to display the write-destination Patch (Rhythm Set/Performance) number.
6. Rotate [VALUE] to select the write-destination Patch (Rhythm Set/Performance) number.
7. When you press [VALUE], "Sur" flashes in the display, and a screen asking you to confirm whether or not you want to save appears.
8. Press [VALUE] to save the Patch.
 - * To cancel the procedure, while holding down [VOLUME] and pressing [VALUE].
 - * When you save a Performance, only the Performance settings are saved. Settings for the Patches and Rhythm Sets assigned to Parts are not saved, even when these are changed.
 - * You cannot save GM Bank Patch and Rhythm Set settings.

Saving with the Included XV Editor

When using XV Editor, included with the XV-2020, you can click "WRITE" to save data.



- * To load saved Patches (Rhythm Sets/Performances), click "READ."

Initializing a Sound (INITIALIZE)

This feature resets all of the parameters in the current Patch, Performance, Rhythm Set or Rhythm Tone to their standard (INITIALIZE).

- * When you play a Patch, Performance, Rhythm Set or Rhythm Tone, you're actually playing it from the XV-2020's Temporary memory — the Patch, Performance, Rhythm Set or Rhythm Tone is instantly copied into the Temporary memory when you select it. During initialization, only the copy is affected, not the version saved in memory. If you wish to restore all of the XV-2020's settings to their factory values, perform a Factory Reset. (p. 12)
1. Select the Performance, Patch or Rhythm Set you wish to initialize.
 2. While holding down [VOLUME], press [VALUE].
 3. Turn [CATEGORY/BANK] to select "UTILITY (PIANO)."
 4. Rotate [VALUE] until "ini (ini)" appears in the display.
 5. When you press [VALUE], "Sur" flashes in the display, and a screen asking you to confirm whether or not you want to save appears.
 6. When you press [VALUE] once more, the sound is initialized.
 - * To cancel the procedure, hold down [VOLUME] while you press [VALUE].

Transmitting Sound Settings (XFER)

The act of transmitting Patch, Performance, Rhythm Set or System data to an external MIDI device is called a “**Bulk Dump**.” You can perform a bulk dump when two XV-2020s are connected to each other, or when you wish to store Patch, Performance, Rhythm Set or System data on an external MIDI device as a safety backup of your XV-2020 data.

The following describes the relationship between the selected mode and the data that is transmitted.

- Patch Mode:** Parameters for the currently selected Patch
- Rhythm Mode:** Parameters for the currently selected Rhythm Set
- Performance Mode:** Parameters for the currently selected Performance and the Patches and Rhythm Sets assigned to its Parts
- GM Mode:** Bank Select and Program Changes are transmitted not by Exclusive messages, but by means of MIDI Channel messages. For more on the MIDI Channel messages that are transmitted, refer to the MIDI Implementation (p. 136).

1. Select the Performance, Patch, Rhythm Set or GM mode settings you wish to transfer.
2. While holding down [VOLUME], press [VALUE].
3. Turn [CATEGORY/BANK] to select “UTILITY (PIANO).”
4. Rotate [VALUE] until “dtr (d t r)” appears in the display.
5. When you press [VALUE], “Sur” flashes in the display, and screen asking you to confirm whether or not you want to transmit appears.
6. When you press [VALUE] once more, the data is transmitted to the external MIDI device.

* To cancel the procedure, while holding down [VOLUME] and pressing [VALUE].

Establishing Settings for an Entire XV-2020 (SYSTEM COMMON)

SYSTEM COMMON

Parameter	Value	Description
MASTER LEVEL	0-127	Adjusts the volume of the entire XV-2020.
MASTER TUNE	415.3-466.2 Hz	Adjusts the overall tuning of the XV-2020. The setting is expressed as the frequency played by the A4 key.
PATCH REMAIN (Patch Remain Switch)	OFF, ON	This specifies whether you want the notes that are sounding to remain (ON) or turn off (OFF) when you select a new Patch or Rhythm Set in Patch mode. In addition, when "ON" is selected, the Volume and Pan data, and the Key Mode and other settings received via MIDI (CC 5, 7, 10, 65, 68, 71-74, RPN 0, 1, 2, MONO ON, POLY ON) are passed on.
MASTER KEY SHIFT	-24-+24	Shifts the overall pitch of the XV-2020 in semitone steps.
CLOCK SOURCE (System Clock Source)	INT, MIDI, USB	Specifies the tempo clock of the system. INT: The internal clock MIDI: An external clock received via MIDI IN connector USB: An external clock received via USB connector
TEMPO (System Tempo)	20-250	Sets the system tempo. When Clock Source is set to "MIDI" or "USB," the tempo will synchronize to the clock messages received from an external device, so the tempo value will be ignored.
PERFORM CTRL CH (Performance Control Channel)	1-16, OFF	When changing Performances by MIDI messages from the external device, set the transmit channel of the external device and this channel to the same channel. <i>* When you perform a Factory Reset operation, Control Channel is reset to "16."</i>
PATCH RCV CH (Patch/Rhythm Set Receive Channel)	1-16	Set this channel to use an external MIDI device (such as a MIDI keyboard) for playing Patches and Rhythm Sets, or to have Patches or Rhythm Sets changed as the result of MIDI messages.
RCV PC (Receive Program Change Switch)	OFF, ON	Specifies whether Program Change messages will be received (ON), or not (OFF).
RCV BS (Receive Bank Select Switch)	OFF, ON	Specifies whether Bank Select messages will be received (ON), or not (OFF).
SYSTEM CTRL SRC 1-4 (System Control Source1-4)	OFF, CC01-31, 33-95, BEND, AFTER	These settings allow you to choose four MIDI controllers for global use when controlling the parameters of any Patch or Performance. The settings in each Patch or Performance will determine whether the two controllers you choose here will actually be used. In each Patch or Performance, you will also need to specify the parameters to be controlled. OFF: No controller is used. CC01-95: Controller numbers 1-95 (except for 32) BEND: Pitch Bend AFTER: Aftertouch

Other Settings

Making USB-Related Settings

* With these parameters, changes in the settings are not reflected until the power is turned off and then on again. Furthermore, only the XV-2020 can be used to make the settings.

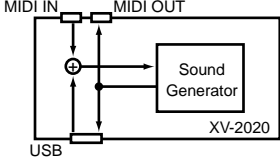
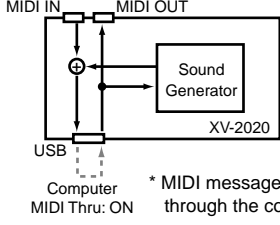
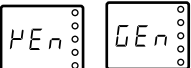
Parameter	Value	Description
MIDI-USB Thru	OFF, ON	<p>OFF:MIDI messages arriving at the MIDI IN and the USB connectors are all sent to the sound generator.</p> <p>ON:MIDI messages arriving at the MIDI IN connector are output as is from the USB connector, while the MIDI messages that arrive at the USB connector are output through the MIDI OUT connector.</p> <p>* When this parameter is set to "ON," the sound generator receives MIDI messages only from the USB connector. For the sound generator to receive MIDI messages from the MIDI IN connector, the MIDI Thru function on your computer must be set to "ON."</p> <div style="display: flex; justify-content: space-around;"> <div style="text-align: center;"> <p>MIDI-USB Thru = OFF</p>  </div> <div style="text-align: center;"> <p>MIDI-USB Thru = ON</p>  </div> </div> <p>* MIDI messages received at MIDI IN are routed through the computer to the sound generator.</p>
USB DESCRIPTOR	VEN, GEN 	<p>VEN (VENDOR): Select this when using the supplied driver with a USB connection.</p> <p>GEN (GENERIC): Select this when using a generic USB driver included with the OS with a USB connection.</p>

* With these parameters, changes in the settings are not reflected until the power is turned off and then on again. Furthermore, only the XV-2020 can be used to make the settings.

Procedure

1. While holding down [VOLUME], press [VALUE].
2. Turn [CATEGORY/BANK] to choose "MIDI-USB Thru" or "USB DESCRIPTOR."
3. Turn [VALUE] to select the desired setting.
4. Press [VALUE] to set (write) the value.
5. While holding down [VOLUME], press [VALUE].

Initialize is executed.

Checking the Program Version

Parameter	Description
PROGRAM VERSION	Shows the version of the XV-2020's system program.

Procedure

1. While holding down [VOLUME], press [VALUE].
2. Turn [CATEGORY/BANK] to choose "UTILITY (PIANO)."
3. When you rotate [VALUE], the program version (number) is displayed.
4. While holding down [VOLUME], press [VALUE].

The XV-2020 exits Edit mode.

Using the XV-2020 as a General MIDI Sound Module

The XV-2020 features a GM mode—a convenient way to play back or create GM score data (music files for General MIDI sound module). You're able to play back commercial GM score data releases and even modify various parameter settings for enhanced musical expression.

Entering GM Mode

Basically GM mode is similar to a special kind of Performance in which a General MIDI System Rhythm Set is assigned to Part 10, and General MIDI System Patches are assigned to other Parts.

But however, you can't store GM mode settings in user memory.

Each time you enter GM mode, the GM Drum Set is assigned to Part 10, and Piano 1 is assigned to other Parts. You can also select other GM Patches and GM Drum Sets for each Part to match the performance.

You cannot use the included XV Editor to edit the parameters in GM mode.

Initializing the Sound Generator for General MIDI System Basic Settings

To play back a GM score correctly, the sound generator must first be initialized to basic GM system settings. The XV-2020's sound generator is initialized in the following situations:

- When the XV-2020 is switched to GM mode
- When it receives a GM System On message from an external MIDI device
- When a GM System On message is encountered in the song data being played back
- When you execute the GM Initialize function

Procedure

1. Press [VALUE], causing the GM indicator to light up, to switch to GM mode.
2. While holding down [VOLUME], press [VALUE].
3. Turn [CATEGORY/BANK] to choose "UTILITY (PIANO)."
4. Press [VALUE] to choose "ini."
5. When you press [VALUE], "Sur" is displayed, and a confirmation screen appears.
6. Press [VALUE].
Initialize is executed.

GM/GM2 System On Message

The GM/GM2 System On messages put the unit in a state that conforms to the General MIDI System and initializes a General MIDI-compatible sound generator.

Playing Back a GM Score

When the XV-2020 is in GM mode, it plays back GM scores correctly. But beyond this, the XV-2020 provides many extended features not defined in GM System specifications, and if you create music files using these extended features, your song may not play back correctly on other GM-compatible sound modules.

The beginning of a GM score normally contains a GM System On message. So if you play back a GM score starting in the top of a song, XV-2020 will switch itself to GM mode. But if you play back a GM score starting in the middle of a song, XV-2020 may not switch itself to GM mode, and the GM score may not play back correctly. So to be safe, it's recommended to manually set the XV-2020 to GM mode before playing back a GM score.

although the XV-2020 can also be compatible with the GS format by receiving a GS Reset MIDI message, Roland's Sound Canvas Series (including the SC-8850 and SC-8820) features a different sound module system and extended tone map, you may be unable to get MIDI data (GS music data) created especially for use only with the Sound Canvas series of devices to play back properly.

Making Effects Settings in GM Mode (EFFECTS)

In GM mode, a GM-exclusive Chorus and Reverb can be used. Chorus and Reverb can be set independently.

- **Chorus:** Adds depth and spaciousness to the sound.
 - **Reverb:** Adds the reverberation characteristics of halls or auditoriums.
- * *In GM mode, you cannot use Multi-effects.*
- * *The XV-2020's onboard effects can be turned on/off as a whole. For details, refer to "Turning Effects On/Off (p. 76)."*

OUTPUT

Parameter	Value	Description
OUTPUT LEVEL (Dry Send Level)	0-127	Sets the direct sound's volume for each Part.
CHORUS SEND LEVEL	0-127	Adjusts the amount of Chorus for each Part. If you don't want to add the Chorus effect, set it to 0.
REVERB SEND LEVEL	0-127	Adjusts the amount of Reverb for each Part. If you don't want to add the Reverb effect, set it to 0.

* *Chorus and Reverb are output in mono at all times.*

GM CHORUS

Parameter	Value	Description
CHORUS TYPE	CHORUS 1-4, FB CHORUS, FLANGER	Selects the type of Chorus. CHORUS 1-4: Chorus1-4 FB CHORUS: Feedback Chorus FLANGER: Flanger
CHORUS RATE	0-127	Specifies the modulation frequency of the Chorus sound.
CHORUS DEPTH	0-127	Sets the depth of the modulations of the Chorus sound.
CHORUS FEEDBACK LEVEL	0-127	Adjusts the amount of Chorus sound that is returned (fed back) to the Chorus. Higher settings will create a more complex Chorus effect.
CHORSUS REVERB SEND LEVEL	0-127	Adjusts the amount of Reverb to be applied to the sound routed through Chorus. If you don't want to add the Reverb effect, set it to 0.

GM REVERB

Parameter	Value	Description
REVERB TYPE	SMALL ROOM, MEDIUM ROOM, LARGE ROOM, MEDIUM HALL, LARGE HALL, PLATE	Selects the type of Reverb. SMALL ROOM: Reverb resembling that obtained in a small room. MEDIUM ROOM: Reverb resembling that obtained in a somewhat larger room. LARGE ROOM: Reverb resembling that obtained in a large room. MEDIUM HALL: Reverb resembling that obtained in a medium-sized concert hall. LARGE HALL: Reverb resembling that obtained in a large concert hall. PLATE: Plate-type reverb effect.
REVERB TIME	0-127	Adjusts the length of the Reverb time.

Making Settings for Each Part

Here you can select the GM Patch/Rhythm Set assigned to each Part, and set the volume, pan, and pitch of each Part.

Parameter	Value	Description
LEVEL (Part Level)	0-127	Adjusts the volume of an individual Part. This setting's main purpose is to adjust the volume balance between Parts.
PAN (Part Pan)	RND, L63-63R	Adjusts the pan of each Part. L64 is far left, 0 is center, and 63R is far right.
COARSE TUNE (Part Coarse Tune)	-48--+48	Adjusts the pitch of the Part's sound up or down in semitone steps (+/-4 octaves).
FINE TUNE (Part Fine Tune)	-50--+50	Adjusts the pitch of the Part's sound up or down in 1-cent steps (+/-50 cents).
PART TYPE	PATCH, RHYTHM	Sets the assignment of a GM Patch (PATCH) or GM Rhythm Set (RHYTHM) to each of the Parts.
NUMBER	001-256/ 001-009	Selects the desired GM Patch or Rhythm Set by its number. <i>* In GM mode, Patches or Rhythm Sets other than the GM Patches and Rhythm Sets in PR-H cannot be selected. Furthermore, GM Patches and Rhythm Sets cannot be edited.</i>
CUTOFF OFFSET (Part Cutoff Offset)	-64--+63	Adjusts the cutoff frequency for the GM Patch or Rhythm Set assigned to a Part.
RESONANCE OFFSET (Part Resonance Offset)	-64--+63	Adjusts the Resonance for the GM Patch or Rhythm Set assigned to a Part.
ATTACK OFFSET (Part Attack Time Offset)	-64--+63	Adjusts the TVA Envelope Attack Time for the GM Patch or Rhythm Set assigned to a Part.
RELEASE OFFSET (Part Release Time Offset)	-64--+63	Adjusts the TVA Envelope Release Time for the GM Patch or Rhythm Set assigned to a Part.
BEND RANGE (Pitch Bend Range)	0-24	Specifies the amount of pitch change in semitones (2 octaves) that will occur when the Pitch Bend Lever is moved. The amount of change when the lever is tilted is set to the same value for both left and right sides.
MONO/POLY (Part MONO/POLY)	MONO, POLY	Set Mono/Poly to MONO when the GM Patch assigned to the Part is to be played monophonically, or to POLY when the GM Patch is to be played polyphonically. <i>* For the Part to which the GM Rhythm Set is assigned, this setting will be ignored.</i>
PORTAMENTO SWITCH (Part Portamento Switch)	OFF, ON	Determines whether the Portamento effect will be applied (ON) or not (OFF). Turn this parameter ON when you want to apply Portamento and OFF when you don't.
PORTAMENTO TIME (Part Portamento Time)	0-127	Adjusts the time over which the pitch will change. Higher settings will cause the pitch change to the next note to take more time.

Examples of Applications Using the XV-2020

This section provides clear, concrete examples describing how the included XV Editor is used with the XV-2020.

Controlling the XV-2020 in real time Using an External MIDI Device

External MIDI controllers – modulation lever, foot switch, expression pedal, etc. – can be used to modify Multi-Effects settings or Tone settings in real time.

Changing Multi-Effects Settings From an External MIDI Device

The parameters that can be changed via MIDI are determined by the selected Multi-Effects (MFX) Type.

This applies to the MFX Type parameters described in pages p. 82 to p. 91 that have an appended “#” mark.

1. Click [PATCH] or [PERFORM].
2. Click the ▼ for [PATCH NAME] or [PERFORM NAME] to select the Patch or Performance to be used.



3. Click [PARAM] for [MFX].
4. Click the ▼ for [TYPE] and select [TYPE (MFX TYPE)].



5. Set the parameter and the value.

PATCH MFX

You cannot choose these parameters when the MFX Type is set to “00 THROUGH.”

CONTROL SOURCE (MFX CONTROL SOURCE1-4)

OFF	No controller is used.
CC01-95	Controller numbers 1-95 (except for 32)
BEND	Pitch Bend
AFTER	Aftertouch
SY51-4	System Control 1-4

DESTINATION (MFX CONTROL DESTINATION1-4)

This chooses the Multi-Effects parameter to be controlled using the MFX Control Source 1-4.

SENS (MFX CONTROL SENS1-4)

If you wish to change the selected parameter in a positive (+) direction – i.e., a higher value, toward the right, or faster, etc. – from its current setting, choose a positive (+) value. If you wish to change the selected parameter in a negative (-) direction – i.e., a lower value, toward the left, or slower, etc. – from its current setting, choose a negative (-) value. Higher numbers produce a greater amount of change.

Changing Tone Settings

You can use the Matrix Control parameter to manipulate Tone settings in real time.

Choosing the MIDI Messages Used for Control and the Parameters to Be Changed

1. Click [PATCH].
2. Click the ▼ for [PATCH NAME] to select the Patch to be used.



3. Click [MATRIX CONTROL].



4. Click the ▼ for [SOURCE 1] through [SOURCE 4] to select the parameter.
5. Using the ▼ for [DESTINATION 1] through [DESTINATION 4], select the parameter to be controlled, and set the SENS and TONE.

Matrix Control

Select the controllers you want to use to control a specific Tone parameter. Four control sources are assigned to each Patch.

SOURCE 1-4 (MATRIX CONTROL1-4 SOURCE)

Assign one of the following controllers to Control Source 1-4. If you wish to use a controller that applies to all Patches, or a controller that cannot be directly specified here, choose SYS-CTRL1-4, and then choose the controller using the Control Source 1-4 parameters (SYSTEM CONTROL SOURCE).

OFF (No controller is used.)
CC01-95 (Controller numbers 1-95 (except for 32))
PITCH BEND
AFTERTOUCH
SYS-CTRL1-4 (System Control 1-4)
VELOCITY
KEYFOLLOW
TEMPO
LFO1(2)
PITCH ENV (Pitch Envelope)
TVF ENV (TVF Envelope)
TVA ENV (TVA Envelope)

MATRIX CONTROL1-4

This select the parameters to be controlled in the Matrix Control 1-4 Source and the Sens settings, as well as the Tone to which they're applied. Up to four parameters can be specified for each controller and controlled simultaneously.

DESTINATION1-4 (MATRIX CONTROL1-4 DESTINATION1-4)

This chooses the parameters to be controlled.

OFF (No control)	---
PITCH	p. 54
CUTOFF (Cutoff Frequency)	p. 57
RESONANCE	p. 57
LEVEL	p. 100
PAN	p. 100
DRY LEVEL	p. 78
CHORUS SEND (Chorus Send Level)	p. 78
REVERB SEND (Reverb Send Level)	p. 78
LFO1(2) PITCH DEPTH	p. 57
LFO1(2) TVF DEPTH	p. 57
LFO1(2) TVA DEPTH	p. 57
LFO1(2) PAN DEPTH	p. 57
LFO1(2) RATE	p. 56
PCH ENV A-TIME (Pitch Envelope Attack Time)	
PCH ENV D-TIME (Pitch Envelope Decay Time)	p. 54
PCH ENV R-TIME (Pitch Envelope Release Time)	
TVF ENV A-TIME (TVF Envelope Attack Time)	
TVF ENV D-TIME (TVF Envelope Decay Time)	p. 58
TVF ENV R-TIME (TVF Envelope Release Time)	
TVA ENV A-TIME (TVA Envelope Attack Time)	
TVA ENV D-TIME (TVA Envelope Decay Time)	p. 60
TVA ENV R-TIME (TVA Envelope Release Time)	
TMT	p. 49
FXM DEPTH (Wave FXM Depth)	p. 54
MFV CTRL 1-4 (MFV CONTROL 1-4)	p. 80

SENS1-4 (MATRIX CONTROL SENS 1-4)

This adjusts the amount of change that occurs in response to controller movements. Negative (-) values invert the change. For example, with LFO Depth, the phase is reversed when a negative Sens value is chosen. With LFO Rate, setting Sens to a negative value increases the cycle length, slowing down the LFO, while setting it to positive value shortens the cycle, speeding it up

TONE1-4 (MATRIX CONTROL1-4, TONE CONTROL SWITCH1-4)

This selects the Tone to be controlled using the two previous parameter settings. "ON" activates the control of a Tone, "OFF" deactivates it, and "REV" reverses the (+) or (-) nature of the change being applied.

Applications for Patches

Syncing the LFO Cycle to the System Tempo

1. Click [PATCH].
2. Click the ▼ for [PATCH NAME] to select the Patch to be synchronized.



3. Click [DETAIL] for PATCH COMMON, then set [CLOCK SOURCE] to [SYSTEM].

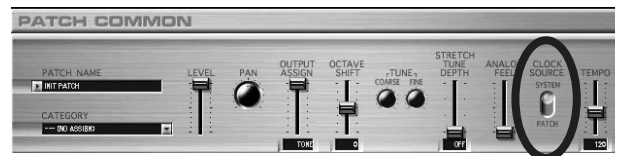
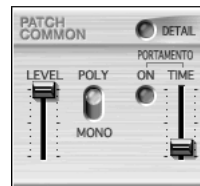

4. Click [DETAIL] for LFO 1, click [RATE], then set each tone's Rate to the note length corresponding to the synchronization tempo.

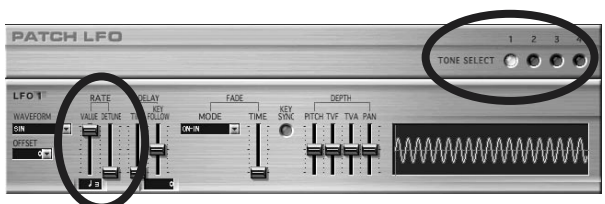

* TONE 1 - TONE 4 are switched with TONE SELECT, at the upper right of the screen.

5. Click [DETAIL] for SYSTEM COMMON, then set [CLOCK SOURCE] to [INT].
- * When the System Clock Source parameter is set to MIDI or USB, you can synchronize the LFO cycle to an external device.
6. If [TEMPO] (System Tempo) changes, the LFO Rate changes along with it.



7. Set the modulation depth as desired using LFO 1 Depth for each Tone.

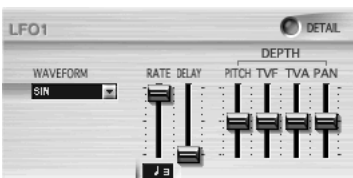

Synchronizing Multi-Effects to the System Tempo

You can change Multi-Effects parameter values in time with the System Tempo when you've selected the following values for the Type MFX parameter.

Type	MFX Parameter
16: STEP FLANGER	Step Rate
19: TRIPLE TAP DELAY	Delay C/L/R
20: QUADRUPLE TAP DELAY	Delay 1-4

Here's an example in which STEP FLANGER is used for the Multi-Effects.

1. Click [PATCH].
2. Click the ▼ for [PATCH NAME] to select the Patch to be used.



3. Click [DETAIL] for PATCH COMMON, then set [CLOCK SOURCE] to [SYSTEM].

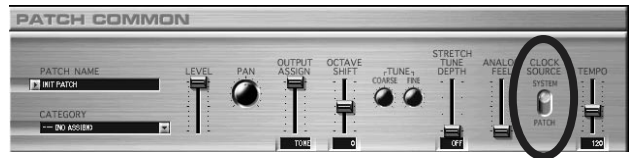
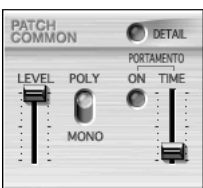

4. Click [PARAM] for [MFX].
This puts you in the PATCH MFX screen.

5. Click [TYPE] and select [16 STEP FLANGER].



6. Make sure that [STEP RATE] is set to a note – not a numerical - value. If necessary, reset it so that it is.

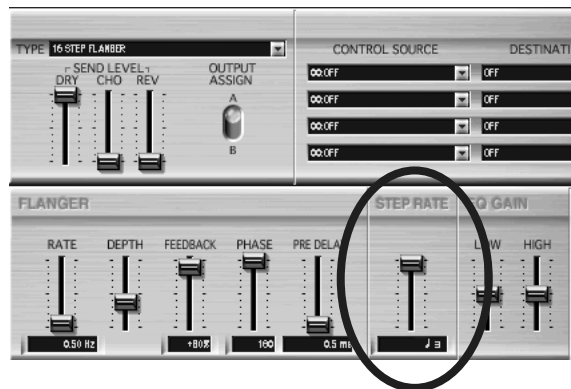

7. Click [DETAIL] for SYSTEM COMMON, then set [CLOCK SOURCE] to [INT].



- * When the System Clock Source parameter is set to MIDI or USB, you can synchronize the LFO cycle to an external device.

8. When [TEMPO] (System Tempo) changes, the STEP FLANGER's Step Rate changes along with it.

Examples of Applications Using the XV-2020

Making a Tone's Delay Time Match the System Tempo

1. Click [PATCH].
2. Click the ▼ for [PATCH NAME] to select the Patch to be used.



3. Click [DETAIL] for PATCH COMMON, then set [CLOCK SOURCE] to [SYSTEM].

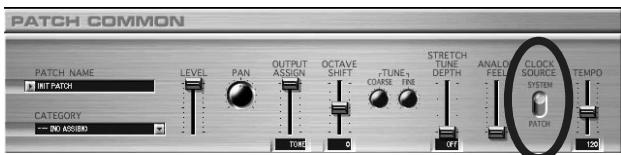

4. Click [DETAIL] for [PATCH WG], then set [TONE DELAY TIME] to the note length corresponding to the synchronization tempo. – not a numerical value – in relation to the synchronization tempo.

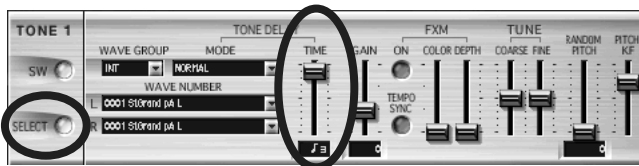

5. Click [DETAIL] for SYSTEM COMMON, then set [CLOCK SOURCE] to [INT].
- * When the System Clock Source parameter is set to MIDI or USB, you can synchronize the LFO cycle to an external device.
6. When [TEMPO] (System Tempo) changes, the Tone's delay time changes along with it.



Playing Phrase Loops at a System's Tempo

An optional Wave Expansion Board can contain Patches based on waveforms that are timed – in BPM – phrase loops. You can play these phrase loops in sync with the System Tempo.

1. Click [PATCH].
2. Click the ▼ for [PATCH NAME] and select the Patch being used in the phrase loop.



3. Click [DETAIL] for PATCH COMMON, then set [CLOCK SOURCE] to [SYSTEM].

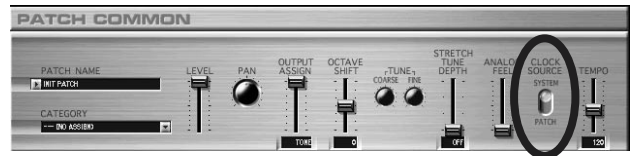
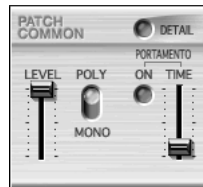

4. Click [DETAIL] for [PATCH WG]. Press [SELECT] to find a Tone that uses phrase-loop waveforms. The wave name appears in the WAVE NUMBER L (R) column. Waveform names that have a BPM number in the first part of the name (such as "132:WAVE NAME") are phrase loop waveforms.

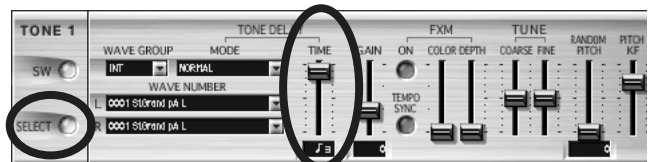

5. Set [TONE DELAY TIME] to 0.
- If you choose a value other than 0, a delay will be applied, and you will not be able to play the Patch normally.

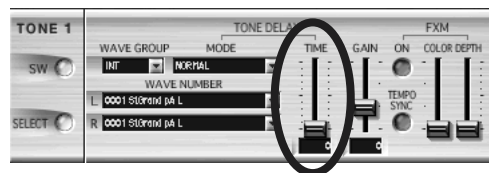

- Click [DETAIL] for SYSTEM COMMON, then set [CLOCK SOURCE] to [INT].



- * When the System Clock Source parameter is set to MIDI or USB, you can synchronize the LFO cycle to an external device.
- When [TEMPO] (System Tempo) changes, the speed of the phrase loop changes along with it.
 - The phrase loop sounds at the system's tempo regardless of which key you press. The settings for pitch and FXM are ignored.

Using a Pedal Switch to Change the Rotary Speed of the Rotary Effect

- Connect a pedal switch (DP-2, DP-6, etc.) to your external MIDI controller (MIDI keyboard, etc.).
- Set the pedal switch of the external MIDI controller to generate FOOT TYPE (CC04) control-change messages.
 - * To learn how to set up the pedal switch, refer to the external MIDI controller's owner's manual.
- Click the ▼ for [PATCH NAME] and select a Patch that uses ROTARY as the Multi-Effect.
- Click [PARAM] for [MFX].



- Set CONTROL SOURCE 1 to CC04.
- Set DESTINATION 1 to SPEED, and SENS 1 to +63.

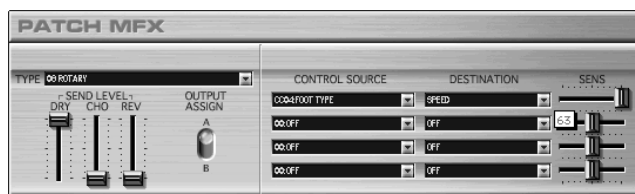

- When you wish to speed up the rotary effect, press the pedal switch. Release the pedal switch to slow down the rotary effect.

Changing Part Settings from an External MIDI Device

By sending Control Change messages for different Part settings, including volume, panning, and pitch, you can change these settings remotely from an external MIDI device connected to the XV-2020. This lets you control fade-ins and fade-outs, open and close filters, and exercise other controls in real time from the external MIDI device.

The parameters that can be used for changing the settings, and the Control Change messages that can be used to change the values, are shown below.

- * For more detailed information about Control Change messages, please refer to "MIDI Implementation" p. 136).
- * To change multi-effects, reverb, or chorus effects from an external MIDI device, send a "System Exclusive message" (p. 140).

Remotely Controlling Volume (p. 136)

- Volume: Controller number 7

Remotely Controlling Stereo Positioning (p. 136)

- Panpot: Controller number 10

Remotely Applying Portamento (p. 136, p. 137)

- Portamento: Controller number 65 (Portamento switch), Controller number 5 (Portamento time)

Remotely Changing Sounds' Attack and Release Time (p. 137)

- Release Time: Controller number 72
- Attack Time: Controller number 73

Remotely Changing the Cutoff Frequency (p. 137)

- Cutoff: Controller number 74

Remotely Changing Resonance (p. 137)

- Resonance: Controller number 71

Remotely Changing the Amount of Internal Chorus/Reverb (p. 145)

- Effect 3 (Chorus Send Level): Controller number 93
- Effect 1 (Reverb Send Level): Controller number 91

Remotely Changing Pitch (p. 141)

- Coarse: Controller number 100 (value is 0), Controller number 101 (value is 2), Controller number 6 (value is 16–112)
- Fine: Controller number 100 (value is 0), Controller number 101 (value is 1), Controller number 6 (value is 32–96), Controller number 38 (value is 0–127)
- * *When changing the Coarse parameter, set the amount of change in pitch using Control Number 6 (Data Entry MSB) value. There is no change in pitch when the value is set to "64." The pitch is raised as the value increases from 64, and is lowered as the value decreases below 64.*
- * *When changing the Fine parameter, set the amount of change in pitch using Control Number 6 (Data Entry MSB) and Control Number 38 (Data Entry LSB) settings. There is no change in pitch when Data Entry MSB is set to "64" and Data Entry LSB to "0." The pitch is raised as the respective values increase, and lowered as the respective values decrease.*

Remotely Specifying the Range of Pitch Bend (p. 138)

- Bend Range: Controller number 100 (value is 0), Controller number 101 (value is 0), Controller number 6 (value is 0–12)

Procedure

1. Enable the external MIDI device to send a Control Change message.

For example, if you want to change the volume level, set the external MIDI device to send Control Number 7 (Volume message). In this case, the MIDI channel is matched to the MIDI channel of the Part whose volume you want to change.

- * *For information on how to set up your external MIDI controller, refer to its owner's manual.*

2. Operate the external MIDI device - adjust its controls, play its sequencer, etc. - to send the desired MIDI messages.

- * *As sound changes occur, displayed parameter values reflect the changes you make.*

About RPN

"RPN" (Registered Parameter Number) is an extended MIDI message activated by a previous Control Change message.

Use an RPN when you want to remotely change the XV-2020's Pitch or Pitch Bend range settings. An RPN has an superior part (RPN MSB) and a subordinate part (RPN LSB). The RPN MSB (Control Number 101) informs the XV-2020 that an RPN setting is to follow, and the RPN LSB (Control Number 100) value tells the XV-2020 which parameter is to be set. Finally, a Data Entry (Control Change 6) message sets the desired value.

Once the XV-2020 has received an RPN parameter, all further Data Entry messages on that MIDI channel are applied to that parameter. In order to prevent accidental changes, once the desired setting has been made for the parameter, we recommend that RPN be set to "Null."

For example, to raise the pitch of a certain Part by one half-step (semitone) send the following Control Change message from the external MIDI device.

- Controller number 100: value "0"
- Controller number 101: value "2"
- Controller number 6: value "65"
- Controller number 100: value "127" <- RPN null
- Controller number 101: value "127" <- RPN null

- * *For more detailed information about RPN messages, please refer to "MIDI Implementation" (p. 136).*

Appendix

Installing a Wave Expansion Board

Two Wave Expansion Boards (SRX series; sold separately) can be installed in the XV-2020.

Waveform data, patches and rhythm sets are stored on the Wave Expansion Board, so you can increase the number of available sounds by installing the board in the XV-2020.

NOTE

Installing a Wave Expansion Board increases the patches and drum sets for Parts, but the number of Parts doesn't change.

The Wave Expansion Board can be installed by removing the top cover.

Cautions When Installing an Wave Expansion Board

- To avoid the risk of damage to internal components that can be caused by static electricity, please carefully observe the following whenever you handle the board.
 - Before you touch the board, always first grasp a metal object (such as a water pipe), so you are sure that any static electricity you might have been carrying has been discharged.
 - When handling the board, grasp it only by its edges. Avoid touching any of the electronic components or connectors.
 - Save the bag in which the board was originally shipped, and put the board back into it whenever you need to store or transport it.
- Do not touch any of the printed circuit pathways or connection terminals.
- Never use excessive force when installing a circuit board. If it doesn't fit properly on the first attempt, remove the board and try again.
- When circuit board installation is complete, double-check your work.
- Install only the specified board, and remove only the specified screws.
- Be careful not to cut your hands on the opening for installing the board.

Expansion Board

1. Before installing the Wave Expansion Board, switch off the power to the XV-2020 and any connected equipment.
2. Detach the cover on the upper portion of the XV-2020. Loosen the screw on the upper portion of the cover.

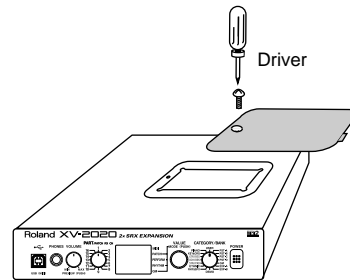

3. Position the board holders so they are oriented.

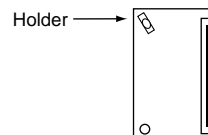

4. Insert the connector for the Wave Expansion Board into the connector on the unit, and at the same time, fit the board holders into the holes.

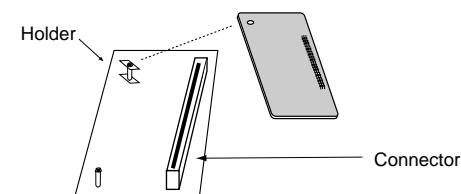

5. Use the tool supplied with the Wave Expansion Board to rotate the board holders to LOCK, securing the Wave Expansion Board in place.

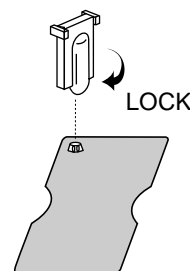

6. Use the (specified) screws you removed in step 2 to reattach the cover.

This completes the installation of the Wave Expansion Board. Next, make sure the board is installed correctly.

Check to make sure the board has been installed properly

1. Press the **POWER** switch on the XV-2020 to switch on the power.
2. Press **[VALUE]** to make the **PATCH** indicator lights up.

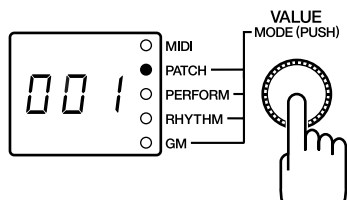

* When you have a Wave Expansion Board installed, "roland XV-2020" is displayed when you turn on the power, and then the letter for the connector to which the board is attached (EXP A or B), and the last two digits of the Wave Expansion Board's model name flash twice in the display.

For example, If you have an SRX-01 "Dynamic Drum Kits" connected to the EXP A connector, "A01" will flash twice.

3. Turn **[CATEGORY/BANK]** to choose EXP-A (B).

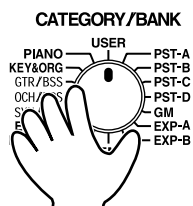

If 001 appears in the display, the Wave Expansion Board has been installed correctly.

* If the display shows "--," it's likely that the Wave Expansion Board is not being recognized correctly. Follow the steps in "**Turning the Power On/Off** (p. 12)" to switch off the power, then reinstall the Wave Expansion Board, making sure you do it correctly.

Installation de la carte d'extension Wave

(French language for Canadian Safety Standard)

French language
for Canadian Safety Standard

Deux cartes d'extension Wave (série SRX; vendues séparément) peuvent être installées dans le XV-2020.

Les données Waveform, les retouches et les groupes de rythme sont stockés sur la carte d'extension Wave; vous pouvez donc augmenter le nombre de sons disponibles en installant la carte dans le XV-2020.

NOTE

Installer une carte d'extension Wave augmente les retouches et les groupes de percussion pour les partitions mais le nombre de partitions ne change pas.

Précautions à prendre lors de l'installation d'une carte d'extension Wave

- Veuillez suivre attentivement les instructions suivantes quand vous manipulez la carte afin d'éviter tout risque d'endommagement des pièces internes par l'électricité statique.
 - Toujours toucher un objet métallique relié à la terre (comme un tuyau par exemple) avant de manipuler la carte pour vous décharger de l'électricité statique que vous auriez pu accumuler.
 - Lorsque vous manipulez la carte, la tenir par les côtés. Évitez de toucher aux composants ou aux connecteurs.
 - Conservez le sachet d'origine dans lequel était la carte lors de l'envoi et remettez la carte dedans si vous devez la ranger ou la transporter.
- Ne pas toucher aux circuits imprimés ou aux connecteurs.
- Ne jamais forcer lors de l'installation de la carte de circuits imprimés. Si la carte s'ajuste mal au premier essai, enlevez la carte et recommencez l'installation.
- Quand l'installation de la carte de circuits imprimés est terminée, vérifiez si tout est bien installé.

Installation d'une carte d'extension Wave

1. Avant d'installer la carte d'extension, éteindre le XV-2020 et tous les appareils qui y sont reliés.
2. Détacher le couvercle de la partie supérieure du XV-2020. Dévisser la vis de la partie supérieure du couvercle.

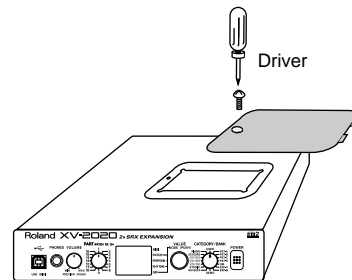

3. Orienter le support à carte tel qu'indiqué sur le schéma.

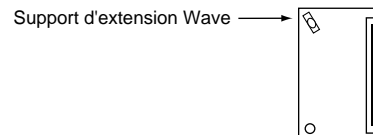

4. Dans l'appareil, vous trouverez des emplacements pour carte à extension de série SRX. En vous référant au schéma ci-dessous, insérer le connecteur de la carte d'extension à l'emplacement correspondant tout en enfonçant simultanément le support à carte dans les trous de celle-ci.

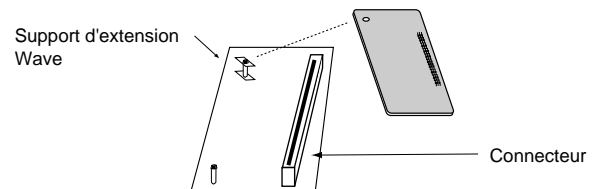

5. À l'aide de l'outil fourni à cet effet avec la carte, faire tourner en position "LOCK" le support à carte afin de bien la fixer.

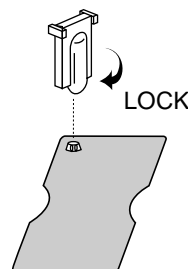

6. Remettre la plaque à sa place et la fixer à l'aide des vis enlevées à l'étape 2.

Ceci complète l'installation de la carte d'extension.

Assurez-vous que la carte a été bien installée

1. Appuyez sur le commutateur du XV-2020 pour l'allumer.
2. Appuyez sur [PATCH] pour que les lampes témoins PATCH s'allument.

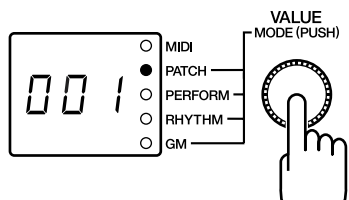

MEMO

Lorsqu'une carte d'extension Wave est installée et que vous allumez l'appareil, vous voyez d'abord l'affichage roland Xv-2020 et ensuite les deux derniers chiffres du numéro de modèle de la carte d'extension Wave clignotent deux fois sur l'affichage. Par exemple, si la carte d'extension Wave SRX-01 «Dynamic Drum Kits» est installée, A01 clignote deux fois sur l'affichage.

3. Tournez [CATEGORY/BANK] pour sélectionner EXP-A.iB).

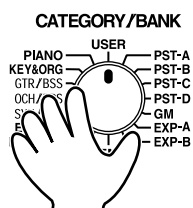

Si 001 s'affiche, la carte d'extension Wave a été installée correctement.

* Si «- -» est affiché, il est probable que la carte d'extension Wave n'est pas correctement reconnue. Suivez les étapes décrites à la rubrique «Éteindre l'appareil» (p. 12) pour éteindre l'appareil; réinstallez ensuite la carte d'extension Wave en vous assurant de le faire correctement.

Troubleshooting

If an unexpected problem occurs while using the XV-2020, read this chapter first. It contains numerous tips for resolving problems.

* If a message appears during operation, consult the following section *Error Messages* (p. 116).

Problems when using the XV-2020

No sound

- **Is the VOLUME lowered?**
Check the VOLUME knob, and the volume settings on the connected amp/mixer, etc.
- **Have connections been made correctly?**
If there is sound in the headphones, it is possible that the connection cables are broken, or that the amp or mixer is malfunctioning. Check the connection cables and other devices once again.
- **Is the Patch mode selected?**
When song data is played back in the Patch mode, only the sound of a single Part is played. Change to the Performance mode, then play the song data. (p. 39)
- **Is the MIDI receive channel correct?**
Make sure that the MIDI transmit channel of the connected device matches the receive channel of the XV-2020 (p. 35).
- **Are the Tone, Patch and Part level settings excessively low?**
Check the level settings of each Tone, Patch and each Part. (Patch p. 46, Part p. 72)
- **Are Tones or Parts turned off?**
Check the on/off settings of each Tone and each Part. (Tone p. 46, Part p. 71)
- **Are the key range settings correct?**
Check the key range settings of each Tone and each Part. (Tone p. 49, Part p. 73)
- **Has the volume been lowered by volume/expression messages received from an external device?**
The volume will return to normal when the power is turned on once again.
- **Are the effect settings correct?**
Check settings such as Effect On/Off (p. 76), and Effect Balance and Level (p. 76).
- **Are the output destination settings correct?**
Check the Output Assign and MFX Output Assign settings. (p. 80)
- **Is MIDI-USB Thru turned on?**
Turn the MIDI-USB Thru parameter off, or turn on the MIDI Thru parameter in the connected computer (p. 95).
- **Is the specified Wave Expansion Board properly installed?**
EXP-A (B) patches and rhythm sets cannot be selected unless the Wave Expansion Board is installed in the designated slot. (p. 105)

Pitch is wrong

- **Is the Master Tune setting correct?**
Check the setting. (p. 94)
- **Is Scale Tune selected?**
Check the setting. (p. 51, p. 75)
- **Are the pitch settings for each Tone and each Part correct?**
Check each setting. (Tone p. 46, Part p. 72)
- **Have pitch bend messages received from an external device caused the pitch to “stick”?**
The pitch will return to normal when the power is turned on.

Effects do not apply

- **Are MFX, CHORUS, and REVERB turned off?**
Check the setting. (p. 76)
- **Are the various effect settings correct?**
If the send levels to each effect are at 0, effects will not apply. Check each setting. (p. 78, p. 79, p. 80)

Even if the send level to each effect is above 0, effects will not apply if the MFX Output Level, Chorus Level, and Reverb Level are set to 0. Check each setting. (p. 80)

If Output Assign is set to PAT (PATCH) for each Part of the Performance, the sound will be output according to the Output Assign settings of the Patch (for each Tone) which is assigned to those Parts. This means that if the Output Assign of (each Tone in) the Patch is set to PAT (PATCH), the MFX sound will not be output. (p. 80)

MIDI messages are not received correctly

- **Are the receive channel and receive switch settings correct?**
Check the settings for the MIDI receive channel (p. 35) and the various switches for reception of MIDI messages (p. 94).
- **Are the exclusive receive settings correct?**
To receive System Exclusive messages, the Device ID number must match that of the transmitting device.
- **Is the DEMO mode selected?**
When the DEMO mode is selected, MIDI messages received from an external device will be ignored.

Song data does not playback correctly

- **Are you playing back from the middle of the song?**
The beginning of a General MIDI score song contains a GM System On message. In some cases, a General MIDI Score cannot be played back correctly unless this message is received.
- **Are you playing back GS format song data?**
Since the XV-2020 is a General MIDI system compatible sound source, there may be cases in which GS format song data will not playback correctly.
- **If playing back GM scores, is the sound generator in GM mode?**
Switch to GM mode (p. 39).
- **Is the Patch mode selected?**
When song data is played back in the Patch mode, only the sound of a single Part is played. Change to the Performance mode, then play the song data. (p. 31)

Problems related to the USB driver

If you are using Windows or Macintosh for the first time, and as a result find it difficult to follow the procedural explanations, please refer to the manuals that came with your computer or operating system.

Troubleshooting is organized according to different operating systems. Refer to the icon(s) at the left of the title to find the items you need.



Problems common to Windows and Macintosh



Problems occurring only in Windows



Problems occurring only in Macintosh



Cannot install the driver correctly

- **Is the CD-ROM correctly inserted into your CD-ROM drive?**
Installation is not possible unless the CD-ROM included with the XV-2020 is inserted in your CD-ROM drive. Make sure that the CD-ROM is correctly inserted into your CD-ROM drive.
- **Is the CD-ROM or the lens of the CD-ROM dirty?**
If the CD-ROM or the lens of the CD-ROM drive is dirty, the installer may not work correctly. Clean the disc and/or lens using a commercially-available CD cleaner or lens cleaner.
- **Are you installing the software from a networked CD-ROM drive?**
The software cannot be installed from a networked CD-ROM drive.

- **Is there sufficient free space on your hard disk?**

Delete unneeded files to increase the amount of free space. After deleting the unneeded files, empty the recycling bin.

- **Is the XV-2020 connected correctly?**

Make sure that the USB connector of your computer is connected to the XV-2020 by a USB cable. Check this, and if you are using Windows, close **the Sound and Multimedia Properties** dialog box (Multimedia Properties in Windows 98), re-open the same dialog box once again, and specify the audio and MIDI input/output destinations.

("Specifying the Output Destination for MIDI Data (p. 21)")

- **Is the power of the XV-2020 turned on?**

Make sure that the XV-2020's **POWER switch** has been pressed inward. Check this, and if you are using Windows, close **the Sound and Multimedia Properties** dialog box (**Multimedia Properties** in Windows 98), re-open the same dialog box once again, and specify the MIDI input/output destinations.



- Using the procedure for "Deleting the USB MIDI Driver (p. 23)", delete the USB audio device driver installed in your computer, and then re-install the XV-2020 driver as described in "Installing & Setup the Driver (Windows) (p. 13)". Also check whether there is any "**Unknown device**" in "**Other devices**" or "**Universal Serial Bus Controllers.**" If you find any, delete them.



- **Is OMS or FreeMIDI installed?**

The XV-2020 driver cannot be installed unless **OMS** or **FreeMIDI** are installed. Please install OMS or FreeMIDI. (OMS -> p. 25, FreeMIDI -> p. 28)



XV-2020 is not detected when making OMS or FreeMIDI settings

- **Is the XV-2020 detected?**

Turn the power of the XV-2020 off, then on again.

Reconnect the USB cable.

If other USB devices are connected, connect only the XV-2020.

It is possible that the Macintosh did not correctly detect and initialize the XV-2020. Leave the XV-2020's USB cable connected, and restart your Macintosh. If it is still not detected, shut down your Macintosh, and then restart it.

The XV-2020 will not be detected if it is connected to the USB connector on the Macintosh keyboard. Please connect the XV-2020 to a USB connector on the Macintosh itself.

 **An “Unknown driver found” dialog box appears, and you are unable to install the driver**

 **“Find new hardware wizard” does not execute automatically**

 **“Find new hardware wizard” ends before the process is completed**

- It may take about 15 seconds (or more) after the USB cable is connected for the XV-2020 to be detected.
- **Is the USB cable connected correctly?**
Make sure that the XV-2020 and your computer are correctly connected via a USB cable.
- **Is USB enabled on your computer?**
Refer to the operation manual for your computer, and make sure that USB is enabled.
- **Does your computer meet the USB specifications?**
If you are using a computer that does not fulfill the electrical requirements of the USB specifications, operation may be unstable. In this case, you may be able to solve the problem by connecting a USB hub.
- Does “**Unknown device**” appear for “**Other device**” or “**Universal serial bus controller**”?
Use the following procedure to delete “**Other device**” (Universal Serial Bus Controller) “**Unknown device**,” and then restart your computer.

1. In the Windows **Control Panel**, double-click **System**. The **System Properties** dialog box will appear.
2. Click the **Device Manager** tab. For Windows XP/2000, click the **Hardware** tab, and then click the **[Device Manager]** button.
3. Double-click “**Other device**” or “**Universal Serial Bus Controller**” to display a list of devices.
4. From the list, select the unknown device and click **[Delete]**.
5. In the dialog box that asks you to confirm the deletion, click **[OK]**.
6. Verify that “**Other device**” or “**Unknown device**” is not displayed in the list, and click **[Close]** to close the dialog box.

 **“Found unknown device” appears even though you installed the driver**

If your computer or USB hub has two or more USB connectors, and you connect the XV-2020 to a USB connector to which the XV-2020 has never been connected before, the “**Unknown device**” dialog box may appear even on a computer onto which you have already installed the driver.
Refer to “Installing & Setup the Driver (Windows) (p. 13)”, and install the driver once again. This is not a malfunction.

 **Can’t install/delete/use the driver in Windows XP/2000**

- **Did you log on to Windows as a user with administrative privileges?**
In order to install/delete/re-install the driver in Windows XP/2000, you must be logged into Windows as a user with administrative privileges, such as Administrator. For details, please contact the system administrator for your computer system.
- **Did you make “Driver signature settings”?**
In order to install/re-install the driver, you must make “**Driver Signing**.”
(Windows XP -> p. 14, Windows 2000 -> p. 17)



Windows XP/2000 displays a “Digital signature was not found” dialog box

- **Did you make “Driver signature settings”?**

In order to install/re-install the driver, you must make the settings described in “**Driver Signing.**” (Windows XP -> p. 14, Windows 2000 -> p. 17)



Device Manager shows “?”, “!”, or “USB Composite Device”



The “Insert Disk” dialog box does not appear

Use the following procedure to re-install the driver.

1. Turn off the power of your computer, and start up Windows with all USB cables disconnected (except for keyboard and mouse).
2. After Windows restarts, use a USB cable to connect the XV-2020 to your computer.
3. Turn on the power of XV-2020.
4. Click the Windows [Start] button, and from the menu that appears, choose **Settings | Control Panel.**
5. Double-click the **System** icon. The **System Properties** dialog box will appear.
6. Click the **Device Manager** tab.
7. Check whether you can see an indication of “?**Composite USB Device,**?**USB Device,**!**USB Device,**” or “**USB composite device**” displayed below “**Sound, Video, and Game Controllers, Other Devices,**” or “**Universal Serial Bus Controller.**” If you find any such indication, select it and click [Delete].
8. A dialog box will ask you to confirm **deletion of the device.** Verify the contents of the dialog box, and then click [OK]. In the same way, delete all indications of “?**Composite USB Device,**” “?**USB Device,**” “!**USB Device,**” and “**USB composite device**” that you find.
9. If you find ROLAND XV-2020 USB Driver with a yellow “!” or a red “?” displayed beside it, delete this in the same way.
10. When you have finished deleting the unwanted devices, click [OK] in the **System Properties** dialog box.
11. Turn off the power of the XV-2020, then delete the driver. “Deleting the USB MIDI Driver (p. 23).”
12. Restart Windows. Then install the driver once again.”Installing & Setup the Driver (Windows) (p. 13).”



Operating system becomes unstable

- **Operation becomes unstable when the computer is started up with the XV-2020 already connected**

Please start up your computer with the XV-2020 disconnected, and then connect the XV-2020. On a computer that uses a USB keyboard, starting up the computer with the XV-2020 already connected may cause operation to become unstable. In this case, start up the computer with the XV-2020 disconnected, and then connect the XV-2020.



No sound



- **Have you specified the MIDI data output destination in your operating system?**

On your computer, you will need to specify the XV-2020 as the output destination for MIDI data. For details on how to make this setting, refer to Settings and checking.

(Windows -> p. 21, Macintosh -> p. 26, p. 29)

- **Have you specified the audio data output destination for your playback software?**

Depending on your software, you may need to once again specify the XV-2020 as the MIDI data output destination. For details on this setting, refer to the operation manual for your application.

- **Are you running multiple applications?**
 If multiple applications are running simultaneously, an error message may be displayed. If this occurs, click [OK] and exit the other applications.
 Even if an application window is closed, it is still running if it appears in the taskbar. Be sure to exit unneeded applications displayed in the taskbar.
- **Was the driver installed correctly?**
 In order for you to play back MIDI data via the XV-2020, the driver must be installed. For installation and settings, refer to “Installing & Setup the Driver (Windows) (p. 13)” “Installing & Setup the Driver (Macintosh) (p. 24).”
- **Is your audio playback equipment (e.g., stereo system) connected correctly?**
 Make sure that the USB connector of your computer is connected to the XV-2020 by a USB cable. Make sure that the XV-2020’s OUTPUT jacks are connected by audio cables to the input jacks of your audio playback equipment. For details on connections, refer to “Connecting to MIDI Devices and Audio Equipment (p. 11)”.
- **Is the power of your audio equipment turned on?**
 Make sure that the power is turned on for your audio equipment (e.g., stereo) and the XV-2020.
- **Are the various volume settings of the XV-2020 set appropriately?**
 Use the Volume knob located on the front panel of the XV-2020 to adjust the volume.
- **Is your computer in Suspend or Sleep mode?**
 If so, get your computer to resume normal operation, then exit all applications that are using the XV-2020. Next, turn the XV-2020’s power off, then switch it on again.
- **Did you reconnect the USB cable or turn the power of the XV-2020 off and on?**
 Exit all applications that are using the XV-2020, and turn the power of the XV-2020 off and then on once again.
-  • **Is OMS/FreeMIDI set correctly?**
 As described in “OMS settings (p. 26)” or “FreeMIDI settings (p. 29)” check the OMS or FreeMIDI settings. Also make sure that the device for MIDI IN/OUT is correctly selected in the MIDI settings of your MIDI sequencer software.
-  • **Is the OMS setup enabled?**
 If a diamond-shaped symbol is not displayed at the left edge of the title area in the OMS setup window, the setup is not enabled. From the OMS File menu, choose “**Make Current.**” (“OMS settings (p. 26)”)
-  • **Has your computer been set to enter Sleep mode?**
 If your computer enters Sleep mode, exit the software you are using, and then restart your computer. We recommend that you set your computer to not use Sleep mode.

Can’t play back MIDI

-  • **Has the MIDI device you are using been selected correctly?**
 Make the settings for the MIDI output device again (p. 26, p. 29).
- **Are the track outputs set correctly?**
 MIDI tracks to which no MIDI playback device is assigned will not be heard. If you want to play back a MIDI track, you must make sure that the MIDI device you want to use is displayed in your software as the MIDI output port. For details, refer to the owner’s manual for your software.

Error Messages

An error message appears in the display when an error in operation occurs, or if an operation cannot be processed correctly. When this occurs, continue by following the instructions indicated in the error message.

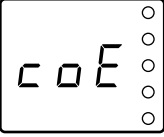
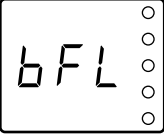
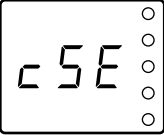
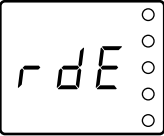
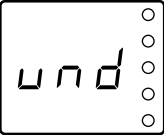
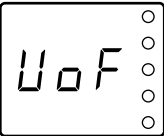
Display	Situation	Action
	There is a problem with the MIDI cable connected to the XV-2020's MIDI IN connector or with an external device. However, this message is also displayed when the power for the external device is turned off.	Check to make sure the MIDI cable is firmly and properly connected. Otherwise confirm that there is no short in the MIDI cable (try switching the MIDI cable to check this).
	More MIDI messages were received in a short time than could be processed correctly.	Reduce the amount of MIDI messages that are transmitted.
	A system exclusive message that was received had an incorrect check sum value.	Correct the check sum value.
	A system exclusive message was not properly received. Repeated appearance of this same error message means that there is a problem with the MIDI message.	Check the content of the received system exclusive message.
	USER data has been damaged.	Restore the factory settings with the Factory Reset procedure.
	It is possible that the power has been turned off for the computer connected to the XV-2020's USB connector.	Check the power of the connected computer.
	It is possible that a USB cable has been pulled out or has a short.	Check the USB cable.

List of Parameters That Can Be Affected Using the XV-2020

Switching modes

Mode	Page	Procedure
Patch Play Mode	p. 35	Press [VALUE] to make the PATCH indicator lights up.
Performance Part Play Mode	p. 38	Press [VALUE] to make the PATCH (RHYTHM) and PERFORM indicators light.
Performance Play Mode	p. 38	Press [VALUE] to make the PERFORM indicator lights up.
Rhythm Play Mode	p. 35	Press [VALUE] to make the RHYTHM indicator lights up.
GM Play Mode	p. 96	Press [VALUE] to make the GM indicator lights up.
Patch Edit Mode	p. 44	In Patch Play Mode, while holding down [VOLUME], press [VALUE].
Performance Edit Mode	p. 70	In Performance Play Mode and Performance Part Play Mode, while holding down [VOLUME], press [VALUE].
Rhythm Edit Mode	p. 62	In Rhythm Play Mode, while holding down [VOLUME], press [VALUE].
GM Edit Mode	p. 96	In GM Play Mode, while holding down [VOLUME], press [VALUE].

SYSTEM parameter

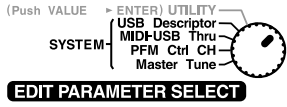
Parameter	Page	Procedure
Master Tune	p. 94	While holding down [VOLUME], press [VALUE]. Turn [CATEGORY/BANK] to choose the parameter you want to set. -> Turn [VALUE] to select the desired setting. -> Pressing [VALUE] to set values (Write). -> While holding down [VOLUME], press [VALUE]. * Changes made to the MIDI-USB Thru and USB Descriptor settings are not reflected until the power is turned off, then on again.
Performance Control Channel	p. 94	
MIDI-USB thru	p. 95	
USB Descriptor	p. 95	

PATCH parameter

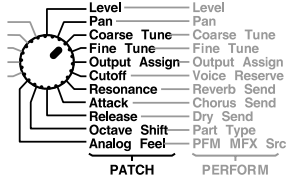
Parameter	Page	Procedure
LEVEL	p. 46	Press [VALUE] to make the PATCH indicator lights up. ->
PAN	p. 46	While holding down [VOLUME], press [VALUE]. ->
COARSE TUNE	p. 46	Turn [CATEGORY/BANK] to choose the parameter you want to set. ->
FINE TUNE	p. 46	Turn [VALUE] to select the desired setting. ->
OUTPUT ASSIGN	p. 46	
CUTOFF OFFSET	p. 47	
RESONANCE OFFSET	p. 47	
ATTACK TIME OFFSET	p. 47	
RELEASE TIME OFFSET	p. 47	
OCTAVE SHIFT	p. 46	
ANALOG FEEL	p. 47	

PERFORMANCE parameter

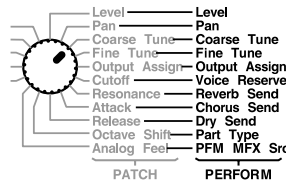
Parameter	Page	Procedure
PART LEVEL	p. 72	Press [VALUE] to make the PERFORM indicator lights up. ->
PART PAN	p. 72	While holding down [VOLUME], press [VALUE]. ->
PART COARSE TUNE	p. 72	Turn [CATEGORY/BANK] to choose the parameter you want to set. ->
PART FINE TUNE	p. 72	Turn [VALUE] to select the desired setting. ->
PART OUTPUT ASSIGN	p. 73	
PART VOICE RESERVE	p. 73	
PART REVERB SEND LEVEL	p. 79	
PART CHORUS SEND LEVEL	p. 73	
PART DRY SEND LEVEL	p. 73	
PART TYPE (PATCH/RHYTHM)	p. 72	
PERFORMANCE MFX SOURCE	p. 80	

List of Parameters That Can Be Affected Using the XV-2020

RHYTHM parameter

Parameter	Page	Procedure
LEVEL	p. 63	Press [VALUE] to make the RHYTHM indicator lights up. ->
OUTPUT ASSIGN	p. 63	While holding down [VOLUME], press [VALUE]. -> Turn [CATEGORY/BANK] to choose the parameter you want to set. -> Turn [VALUE] to select the desired setting. -> While holding down [VOLUME], press [VALUE].

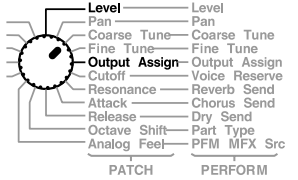

GM parameter

Parameter	Page	Procedure
PART LEVEL	p. 98	Press [VALUE] to make the GM indicator lights up. ->
PART PAN	p. 98	While holding down [VOLUME], press [VALUE]. ->
PART COARSE TUNE	p. 98	Turn [CATEGORY/BANK] to choose the parameter you want to set. ->
PART FINE TUNE	p. 98	Turn [VALUE] to select the desired setting. ->
PART TYPE (PATCH/RHYTHM)	p. 98	Turn [VALUE] to select the desired setting. ->
PART NUMBER	p. 98	While holding down [VOLUME], press [VALUE].
REVERB SEND LEVEL	p. 97	
CHORUS SEND LEVEL	p. 97	
DRY SEND LEVEL	p. 97	

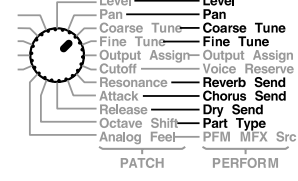

UTILITY parameter

Heading	Page	Procedure
Patch/Rhythm Set/Performance Write	p. 92	While holding down [VOLUME], press [VALUE]. -> Rotating [CATEGORY/BANK] to select UTILITY. -> Rotating [VALUE] to select "wrt". -> Press [VALUE] to select the write-destination Patch number, rotating [VALUE] to select the write-destination number. -> Press [VALUE] to recheck. -> Press [VALUE] to execute
Transmitting Sound Settings	p. 93	While holding down [VOLUME], press [VALUE]. -> Rotating [CATEGORY/BANK] to select UTILITY. -> Rotating [VALUE] to select "dtr". -> Press [VALUE] to recheck. -> Press [VALUE] to execute
Initializing a Sound	p. 92	While holding down [VOLUME], press [VALUE]. -> Rotating [CATEGORY/BANK] to select UTILITY. -> Rotating [VALUE] to select "ini". -> Press [VALUE] to recheck. -> Press [VALUE] to execute
Restoring the Factory Settings	p. 12	While holding down [VOLUME], press [VALUE]. -> Rotating [CATEGORY/BANK] to select UTILITY. -> Rotating [VALUE] to select "Fct". -> Press [VALUE] to recheck. -> Press [VALUE] to execute
Checking the Program Version	p. 95	While holding down [VOLUME], press [VALUE]. -> Rotating [CATEGORY/BANK] to select UTILITY. -> The version is indicated when [VALUE] is rotated

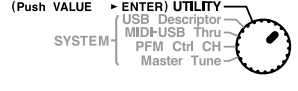

Others

Heading	Page	Procedure
Selecting a Part in a Performance	p. 71	Turn [PART]
PATCH (PART) Receive Channel	p. 94	Turn [PATCH RX CH] ([PART])
Choosing a Patch	p. 35	Turn [CATEGORY/BANK], Turn [VALUE]
Listening to Demo Songs		refer to p. 1

XV Editor Screens – Page to Turn to for Info on a Parameter

PATCH MODE

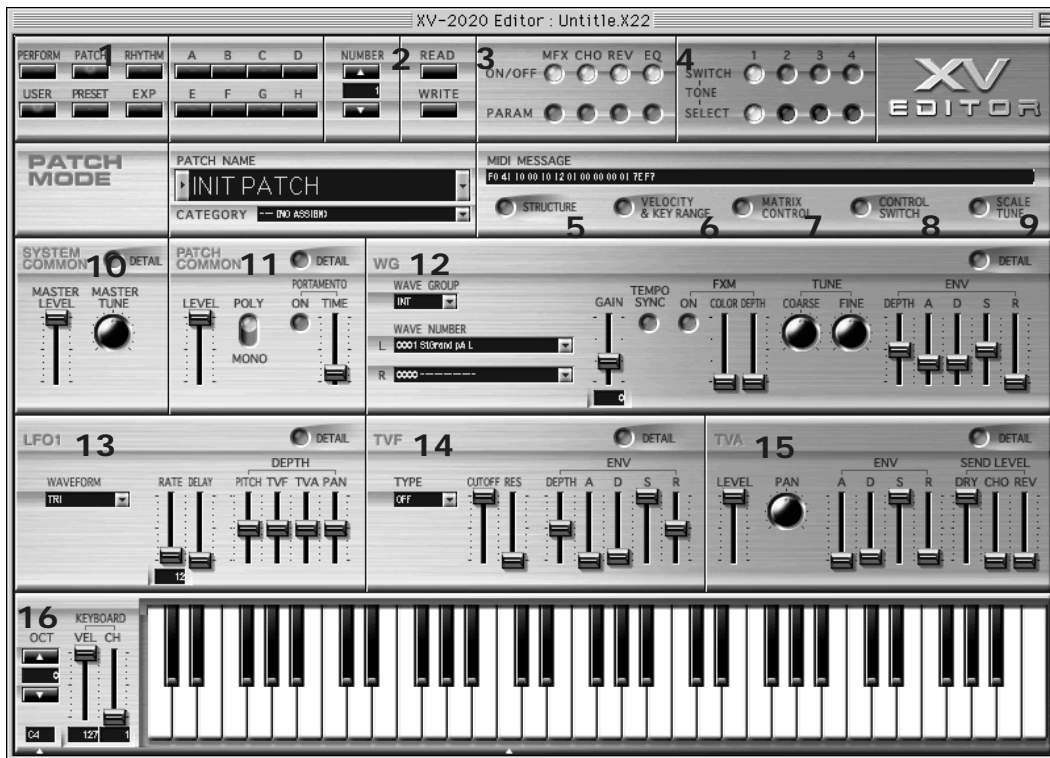

- 1 : p. 44
- 2 : p. 92
- 3 : p. 76
- 4 : p. 45
- 5 : p. 48
- 6 : p. 49
- 7 : p. 50
- 8 : p. 50
- 9 : p. 51
- 10 : p. 94
- 11 : p. 46
- 12 : p. 53
- 13 : p. 55
- 14 : p. 57
- 15 : p. 59
- 16 : p. 45

RHYTHM MODE

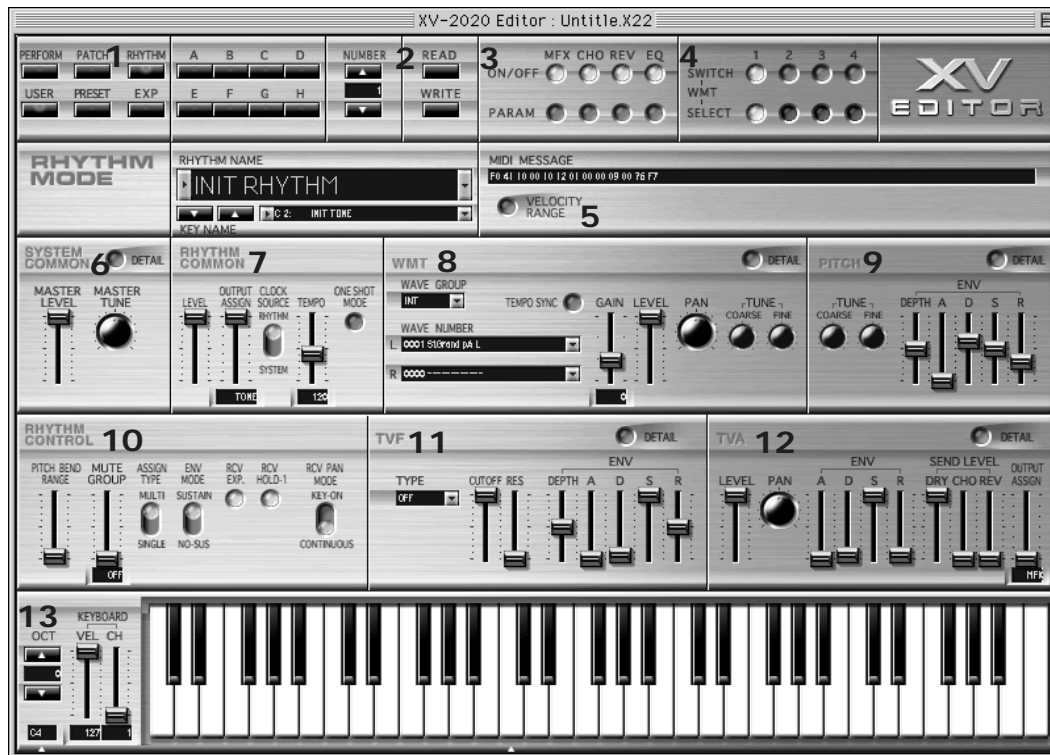

- 1 : p. 62
- 2 : p. 92
- 3 : p. 76
- 4 : p. 45
- 5 : p. 64
- 6 : p. 94
- 7 : p. 63
- 8 : p. 64
- 9 : p. 65
- 10 : p. 68
- 11 : p. 66
- 12 : p. 67
- 13 : p. 45

PERFORMANCE MODE

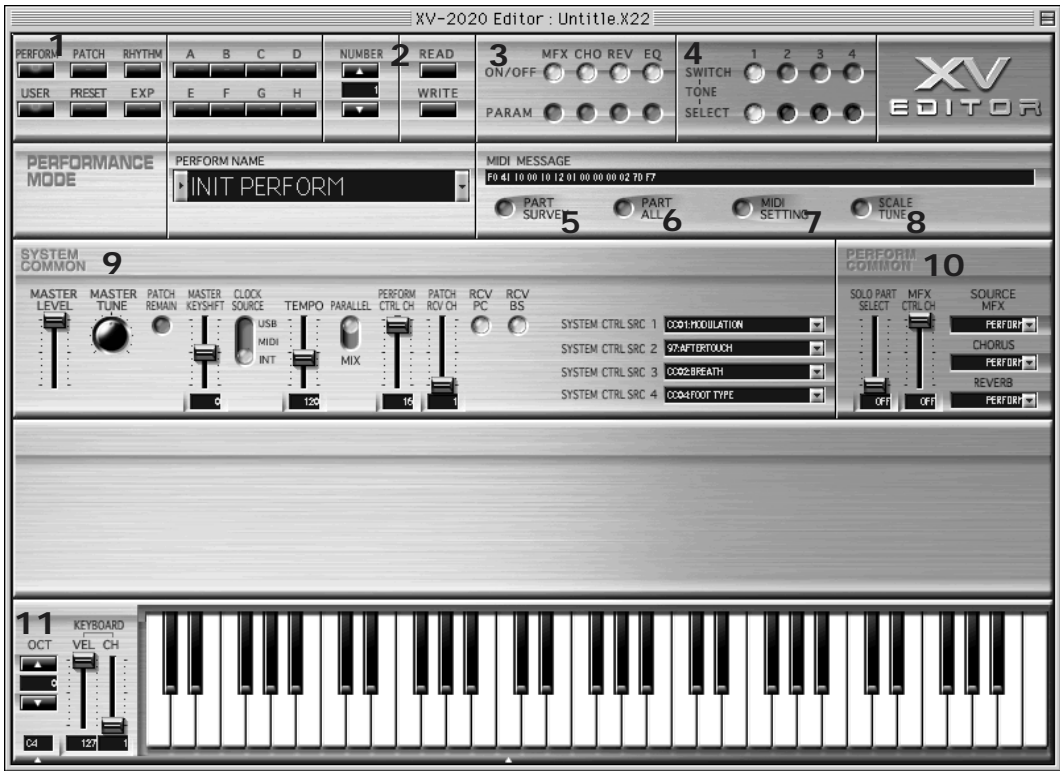

- 1 : p. 70
- 2 : p. 92
- 3 : p. 78
- 4 : p. 45
- 5 : p. 71
- 6 : p. 71
- 7 : p. 74
- 8 : p. 75
- 9 : p. 94
- 10 : p. 71
- 11 : p. 45

Waveform List

No.	Wave Name	No.	Wave Name	No.	Wave Name	No.	Wave Name	No.	Wave Name
1	StGrand pA L	76	Clav 3A	151	Jazz Gtr B	226	Koto A	301	Oboe mf A
2	StGrand pA R	77	Clav 3B	152	Jazz Gtr C	227	Koto B	302	Oboe mf B
3	StGrand pB L	78	Clav 3C	153	LP Rear A	228	Koto C	303	Oboe mf C
4	StGrand pB R	79	Clav 4A	154	LP Rear B	229	Taishokoto A	304	Oboe f A
5	StGrand pC L	80	Clav 4B	155	LP Rear C	230	Taishokoto B	305	Oboe f B
6	StGrand pC R	81	Clav 4C	156	Rock lead 1	231	Taishokoto C	306	Oboe f C
7	StGrand fA L	82	Clav Wave	157	Rock lead 2	232	Pick Bass A	307	E.Horn A
8	StGrand fA R	83	MIDI Clav	158	Comp Gtr A	233	Pick Bass B	308	E.Horn B
9	StGrand fB L	84	HarpsiWave A	159	Comp Gtr B	234	Pick Bass C	309	E.Horn C
10	StGrand fB R	85	HarpsiWave B	160	Comp Gtr C	235	Fingerd Bs A	310	Bassoon A
11	StGrand fC L	86	HarpsiWave C	161	Comp Gtr A+	236	Fingerd Bs B	311	Bassoon B
12	StGrand fC R	87	Jazz Organ 1	162	Mute Gtr 1	237	Fingerd Bs C	312	Bassoon C
13	Ac Piano2 pA	88	Jazz Organ 2	163	Mute Gtr 2A	238	E.Bass	313	T_Recorder A
14	Ac Piano2 pB	89	Organ 1	164	Mute Gtr 2B	239	P.Bass 1	314	T_Recorder B
15	Ac Piano2 pC	90	Organ 2	165	Mute Gtr 2C	240	P.Bass 2	315	T_Recorder C
16	Ac Piano2 fA	91	Organ 3	166	Muters	241	Stick	316	Sop.Sax A
17	Ac Piano2 fB	92	Organ 4	167	Pop Strat A	242	Fretless A	317	Sop.Sax B
18	Ac Piano2 fC	93	60's Organ1	168	Pop Strat B	243	Fretless B	318	Sop.Sax C
19	Ac Piano1 A	94	60's Organ2	169	Pop Strat C	244	Fretless C	319	Sop.Sax mf A
20	Ac Piano1 B	95	60's Organ3	170	JC Strat A	245	Fretless 2A	320	Sop.Sax mf B
21	Ac Piano1 C	96	60's Organ4	171	JC Strat B	246	Fretless 2B	321	Sop.Sax mf C
22	Piano Thump	97	Full Organ	172	JC Strat C	247	Fretless 2C	322	Alto mp A
23	Piano Up TH	98	Full Draw	173	JC Strat A+	248	UprightBs 1	323	Alto mp B
24	Piano Atk	99	Rock Organ	174	JC Strat B+	249	UprightBs 2A	324	Alto mp C
25	MKS-20 P3 A	100	RockOrg1 A L	175	JC Strat C+	250	UprightBs 2B	325	Alto Sax 1A
26	MKS-20 P3 B	101	RockOrg1 A R	176	Clean Gtr A	251	UprightBs 2C	326	Alto Sax 1B
27	MKS-20 P3 C	102	RockOrg1 B L	177	Clean Gtr B	252	Ac.Bass A	327	Alto Sax 1C
28	SA Rhodes 1A	103	RockOrg1 B R	178	Clean Gtr C	253	Ac.Bass B	328	T.Breathy A
29	SA Rhodes 1B	104	RockOrg1 C L	179	Stratus A	254	Ac.Bass C	329	T.Breathy B
30	SA Rhodes 1C	105	RockOrg1 C R	180	Stratus B	255	Slap Bass 1	330	T.Breathy C
31	SA Rhodes 2A	106	RockOrg2 A L	181	Stratus C	256	Slap & Pop	331	SoloSax A
32	SA Rhodes 2B	107	RockOrg2 A R	182	Scrape Gut	257	Slap Bass 2	332	SoloSax B
33	SA Rhodes 2C	108	RockOrg2 B L	183	Strat Sust	258	Slap Bass 3	333	SoloSax C
34	Dyn Rhd mp A	109	RockOrg2 B R	184	Strat Atk	259	Jz.Bs Thumb	334	Tenor Sax A
35	Dyn Rhd mp B	110	RockOrg2 C L	185	OD Gtr A	260	Jz.Bs Slap 1	335	Tenor Sax B
36	Dyn Rhd mp C	111	RockOrg2 C R	186	OD Gtr B	261	Jz.Bs Slap 2	336	Tenor Sax C
37	Dyn Rhd mf A	112	RockOrg3 A L	187	OD Gtr C	262	Jz.Bs Slap 3	337	T.Sax mf A
38	Dyn Rhd mf B	113	RockOrg3 A R	188	OD Gtr A+	263	Jz.Bs Pop	338	T.Sax mf B
39	Dyn Rhd mf C	114	RockOrg3 B L	189	Heavy Gtr A	264	Funk Bass1	339	T.Sax mf C
40	Dyn Rhd ff A	115	RockOrg3 B R	190	Heavy Gtr B	265	Funk Bass2	340	Bari.Sax f A
41	Dyn Rhd ff B	116	RockOrg3 C L	191	Heavy Gtr C	266	Syn Bass A	341	Bari.Sax f B
42	Dyn Rhd ff C	117	RockOrg3 C R	192	Heavy Gtr A+	267	Syn Bass C	342	Bari.Sax f C
43	Wurly soft A	118	Dist. Organ	193	Heavy Gtr B+	268	Syn Bass	343	Bari.Sax A
44	Wurly soft B	119	Rot.Org Slw	194	Heavy Gtr C+	269	Syn Bass 2 A	344	Bari.Sax B
45	Wurly soft C	120	Rot.Org Fst	195	PowerChord A	270	Syn Bass 2 B	345	Bari.Sax C
46	Wurly hard A	121	Pipe Organ	196	PowerChord B	271	Syn Bass 2 C	346	Syn Sax
47	Wurly hard B	122	Soft Nylon A	197	PowerChord C	272	Mini Bs 1A	347	Chanter
48	Wurly hard C	123	Soft Nylon B	198	EG Harm	273	Mini Bs 1B	348	Harmonica A
49	E.Piano 1A	124	Soft Nylon C	199	Gt.FretNoise	274	Mini Bs 1C	349	Harmonica B
50	E.Piano 1B	125	Nylon Gtr A	200	Syn Gtr A	275	Mini Bs 2	350	Harmonica C
51	E.Piano 1C	126	Nylon Gtr B	201	Syn Gtr B	276	Mini Bs 2+	351	OrcUnisonA L
52	E.Piano 2A	127	Nylon Gtr C	202	Syn Gtr C	277	MC-202 Bs A	352	OrcUnisonA R
53	E.Piano 2B	128	Nylon Str	203	Harp 1A	278	MC-202 Bs B	353	OrcUnisonB L
54	E.Piano 2C	129	6-Str Gtr A	204	Harp 1B	279	MC-202 Bs C	354	OrcUnisonB R
55	E.Piano 3A	130	6-Str Gtr B	205	Harp 1C	280	Hollow Bs	355	OrcUnisonC L
56	E.Piano 3B	131	6-Str Gtr C	206	Harp Harm	281	Flute 1A	356	OrcUnisonC R
57	E.Piano 3C	132	StlGtr mp A	207	Pluck Harp	282	Flute 1B	357	BrassSectA L
58	MK-80 EP A	133	StlGtr mp B	208	Banjo A	283	Flute 1C	358	BrassSectA R
59	MK-80 EP B	134	StlGtr mp C	209	Banjo B	284	Jazz Flute A	359	BrassSectB L
60	MK-80 EP C	135	StlGtr mf A	210	Banjo C	285	Jazz Flute B	360	BrassSectB R
61	EP Hard	136	StlGtr mf B	211	Sitar A	286	Jazz Flute C	361	BrassSectC L
62	EP Distone	137	StlGtr mf C	212	Sitar B	287	Flute Tone	362	BrassSectC R
63	Clear Keys	138	StlGtr ff A	213	Sitar C	288	Piccolo A	363	Tpt Sect. A
64	D-50 EP A	139	StlGtr ff B	214	E.Sitar A	289	Piccolo B	364	Tpt Sect. B
65	D-50 EP B	140	StlGtr ff C	215	E.Sitar B	290	Piccolo C	365	Tpt Sect. C
66	D-50 EP C	141	StlGtr sld A	216	E.Sitar C	291	Blow Pipe	366	Tb Sect A
67	Celesta	142	StlGtr sld B	217	Santur A	292	Pan Pipe	367	Tb Sect B
68	Music Box	143	StlGtr sld C	218	Santur B	293	BottleBlow	368	Tb Sect C
69	Music Box 2	144	StlGtr Hrm A	219	Santur C	294	Rad Hose	369	T.Sax Sect A
70	Clav 1A	145	StlGtr Hrm B	220	Dulcimer A	295	Shakuhachi	370	T.Sax Sect B
71	Clav 1B	146	StlGtr Hrm C	221	Dulcimer B	296	Shaku Atk	371	T.Sax Sect C
72	Clav 1C	147	Gtr Harm A	222	Dulcimer C	297	Flute Push	372	Flugel A
73	Clav 2A	148	Gtr Harm B	223	Shamisen A	298	Clarinet A	373	Flugel B
74	Clav 2B	149	Gtr Harm C	224	Shamisen B	299	Clarinet B	374	Flugel C
75	Clav 2C	150	Jazz Gtr A	225	Shamisen C	300	Clarinet C	375	FlugelWave

Waveform List

No.	Wave Name	No.	Wave Name	No.	Wave Name	No.	Wave Name	No.	Wave Name
376	Trumpet 1A	451	Voice Aahs B	526	MMM VOX	601	TVF_ Trig	676	Rock SN f R
377	Trumpet 1B	452	Voice Aahs C	527	Lead Wave	602	Org Click	677	Rock Rim p L
378	Trumpet 1C	453	Voice Oohs1A	528	Synth Reed	603	Cut Noiz	678	Rock Rim p R
379	Trumpet 2A	454	Voice Oohs1B	529	Synth Saw 1	604	Bass Body	679	Rock Rim mfL
380	Trumpet 2B	455	Voice Oohs1C	530	Synth Saw 2	605	Flute Click	680	Rock Rim mfR
381	Trumpet 2C	456	Voice Oohs2A	531	Syn Saw 2inv	606	Gt&BsNz MENU	681	Rock Rim f L
382	HarmonMute1A	457	Voice Oohs2B	532	Synth Saw 3	607	Ac.BassNz 1	682	Rock Rim f R
383	HarmonMute1B	458	Voice Oohs2C	533	JD Syn Saw 2	608	Ac.BassNz 2	683	Rock Gst L
384	HarmonMute1C	459	Choir 1A	534	FAT Saw	609	El.BassNz 1	684	Rock Gst R
385	Trombone 1	460	Choir 1B	535	JP-8 Saw A	610	El.BassNz 2	685	Snare Ghost
386	Trombone 2 A	461	Choir 1C	536	JP-8 Saw B	611	DistGtrNz 1	686	Jazz SN p L
387	Trombone 2 B	462	Oohs Chord L	537	JP-8 Saw C	612	DistGtrNz 2	687	Jazz SN p R
388	Trombone 2 C	463	Oohs Chord R	538	P5 Saw A	613	DistGtrNz 3	688	Jazz SN mf L
389	Tuba A	464	Male Ooh A	539	P5 Saw B	614	DistGtrNz 4	689	Jazz SN mf R
390	Tuba B	465	Male Ooh B	540	P5 Saw C	615	SteelGtrNz 1	690	Jazz SN f L
391	Tuba C	466	Male Ooh C	541	P5 Saw2 A	616	SteelGtrNz 2	691	Jazz SN f R
392	French 1A	467	Org Vox A	542	P5 Saw2 B	617	SteelGtrNz 3	692	Jazz SN ff L
393	French 1C	468	Org Vox B	543	P5 Saw2 C	618	SteelGtrNz 4	693	Jazz SN ff R
394	F.Horns A	469	Org Vox C	544	D-50 Saw A	619	SteelGtrNz 5	694	Jazz Rim p L
395	F.Horns B	470	Org Vox	545	D-50 Saw B	620	SteelGtrNz 6	695	Jazz Rim p R
396	F.Horns C	471	ZZZ Vox	546	D-50 Saw C	621	SteelGtrNz 7	696	Jazz Rim mfL
397	Violin A	472	Bell VOX	547	Synth Square	622	Sea	697	Jazz Rim mfR
398	Violin B	473	Kalimba	548	JP-8 SquareA	623	Thunder	698	Jazz Rim f L
399	Violin C	474	JD Kalimba	549	JP-8 SquareB	624	Windy	699	Jazz Rim f R
400	Violin 2 A	475	Kimba Atk	550	JP-8 SquareC	625	Stream	700	Jazz Rim fFL
401	Violin 2 B	476	Wood Crak	551	DualSquare A	626	Bubble	701	Jazz Rim ffR
402	Violin 2 C	477	Block	552	DualSquare C	627	Bird	702	Brush Slap
403	Cello A	478	Gamelan 1	553	DualSquareA+	628	Dog Bark	703	Brush Swish
404	Cello B	479	Gamelan 2	554	JD SynPulse1	629	Horse	704	Jazz Swish p
405	Cello C	480	Gamelan 3	555	JD SynPulse2	630	Telephone 1	705	Jazz Swish f
406	Cello 2 A	481	Log Drum	556	JD SynPulse3	631	Telephone 2	706	909 SN 1
407	Cello 2 B	482	Hooky	557	JD SynPulse4	632	Creak	707	909 SN 2
408	Cello 2 C	483	Tabla	558	Synth Pulse1	633	Door Slam	708	808 SN
409	Cello Wave	484	Marimba Wave	559	Synth Pulse2	634	Engine	709	Rock Roll L
410	Pizz	485	Xylo	560	JD SynPulse5	635	Car Stop	710	Rock Roll R
411	STR Attack A	486	Xylophone	561	Sync Sweep	636	Car Pass	711	Jazz Roll
412	STR Attack B	487	Vibes	562	Triangle	637	Crash	712	Brush Roll
413	STR Attack C	488	Bottle Hit	563	JD Triangle	638	Gun Shot	713	Dry Stick
414	DolceStr.A L	489	Glockenspiel	564	Sine	639	Siren	714	Dry Stick 2
415	DolceStr.A R	490	Tubular	565	Metal Wind	640	Train	715	Side Stick
416	DolceStr.B L	491	Steel Drums	566	Wind Agogo	641	Jetplane	716	Woody Stick
417	DolceStr.B R	492	Pole Ip	567	Feedbackwave	642	Starship	717	RockStick pL
418	DolceStr.C L	493	Fanta Bell A	568	Spectrum	643	Breath	718	RockStick pR
419	DolceStr.C R	494	Fanta Bell B	569	CrunchWind	644	Laugh	719	RockStick fL
420	JV Strings L	495	Fanta Bell C	570	ThroatWind	645	Scream	720	RockStick fR
421	JV Strings R	496	FantaBell A+	571	Pitch Wind	646	Punch	721	Dry Kick
422	JV Strings A	497	Org Bell	572	JD Vox Noise	647	Heart	722	Maple Kick
423	JV Strings C	498	AgogoBells	573	Vox Noise	648	Steps	723	Rock Kick p
424	JP Strings1A	499	FingerBell	574	BreathNoise	649	Machine Gun	724	Rock Kick mf
425	JP Strings1B	500	DIGI Bell 1	575	Voice Breath	650	Laser	725	Rock Kick f
426	JP Strings1C	501	DIGI Bell 1+	576	White Noise	651	Thunder 2	726	Jazz Kick p
427	JP Strings2A	502	JD Cowbell	577	Pink Noise	652	AmbientSN pL	727	Jazz Kick mf
428	JP Strings2B	503	Bell Wave	578	Rattles	653	AmbientSN pR	728	Jazz Kick f
429	JP Strings2C	504	Chime	579	Ice Rain	654	AmbientSN fL	729	Jazz Kick
430	PWM	505	Crystal	580	Tin Wave	655	AmbientSN fR	730	Pillow Kick
431	Pulse Mod	506	2.2 Bellwave	581	Anklungs	656	Wet SN p L	731	JazzDry Kick
432	Soft Pad A	507	2.2 Vibwave	582	Wind Chimes	657	Wet SN p R	732	Lite Kick
433	Soft Pad B	508	Digiwave	583	Orch. Hit	658	Wet SN f L	733	Old Kick
434	Soft Pad C	509	DIGI Chime	584	Tekno Hit	659	Wet SN f R	734	Hybrid Kick
435	Fantasyth A	510	JD DIGIChime	585	Back Hit	660	Dry SN p	735	Hybrid Kick2
436	Fantasyth B	511	BrightDigi	586	Philly Hit	661	Dry SN f	736	Verb Kick
437	Fantasyth C	512	Can Wave 1	587	Scratch 1	662	Sharp SN	737	Round Kick
438	D-50 HeavenA	513	Can Wave 2	588	Scratch 2	663	Piccolo SN	738	MpILmtr Kick
439	D-50 HeavenB	514	Vocal Wave	589	Scratch 3	664	Maple SN	739	70s Kick 1
440	D-50 HeavenC	515	Wally Wave	590	Shami	665	Old Fill SN	740	70s Kick 2
441	Fine Wine	516	Brusky Ip	591	Org Atk 1	666	70s SN	741	Dance Kick
442	D-50 Brass A	517	Wave Scan	592	Org Atk 2	667	SN Roll	742	808 Kick
443	D-50 Brass B	518	Wire String	593	Sm Metal	668	Natural SN1	743	909 Kick 1
444	D-50 Brass C	519	Nasty	594	StrikePole	669	Natural SN2	744	909 Kick 2
445	D-50 BrassA+	520	Wave Table	595	Thrill	670	Ballad SN	745	Rock TomL1 p
446	Doo	521	Klack Wave	596	Switch	671	Rock SN p L	746	Rock TomL2 p
447	Pop Voice	522	Spark VOX	597	Tuba Slap	672	Rock SN p R	747	Rock Tom M p
448	Syn Vox 1	523	JD Spark VOX	598	Plink	673	Rock SN mf L	748	Rock Tom H p
449	Syn Vox 2	524	Cutters	599	Plunk	674	Rock SN mf R	749	Rock TomL1 f
450	Voice Aahs A	525	EML 5th	600	EP Atk	675	Rock SN f L	750	Rock TomL2 f

Waveform List

No.	Wave Name	No.	Wave Name	No.	Wave Name	No.	Wave Name	No.	Wave Name
751	Rock Tom M f	826	Ride 2	901	REV Wet SNfR	976	REV 70s K 1	1051	REV RkRCym2p
752	Rock Tom H f	827	Ride Bell	902	REV Dry SN	977	REV 70s K 2	1052	REV RkRCym2f
753	Rock Flm L1	828	Rock CrCym1p	903	REV PiccloSN	978	REV Dance K	1053	REV JzRCym p
754	Rock Flm L2	829	Rock CrCym1f	904	REV Maple SN	979	REV 909 K 2	1054	REV JzRCymmf
755	Rock Flm M	830	Rock CrCym2p	905	REV OldFilSN	980	REV RkTomL1p	1055	REV JzRCym f
756	Rock Flm H	831	Rock CrCym2f	906	REV 70s SN	981	REV RkTomL2p	1056	REV Ride 1
757	Jazz Tom L p	832	Rock Splash	907	REV SN Roll	982	REV RkTomM p	1057	REV Ride 2
758	Jazz Tom M p	833	Jazz CrCym p	908	REV NatrlSN1	983	REV RkTomH p	1058	REV RideBell
759	Jazz Tom H p	834	Jazz CrCym f	909	REV NatrlSN2	984	REV RkTomL1f	1059	REV RkCCym1p
760	Jazz Tom L f	835	Crash Cymbal	910	REV BalladSN	985	REV RkTomL2f	1060	REV RkCCym1f
761	Jazz Tom M f	836	Crash 1	911	REV RkSNpL	986	REV RkTomM f	1061	REV JzRCym2p
762	Jazz Tom H f	837	Rock China	912	REV RkSNpR	987	REV RkTomH f	1062	REV RkCCym2f
763	Jazz Flm L	838	China Cym	913	REV RkSNmfL	988	REV RkFlmL1	1063	REV RkSplash
764	Jazz Flm M	839	Cowbell	914	REV RkSNmfR	989	REV RkFlmL2	1064	REV JzCCym p
765	Jazz Flm H	840	Wood Block	915	REV RkSNfL	990	REV RkFlm M	1065	REV JzCCym f
766	Maple Tom 1	841	Claves	916	REV RkSNfR	991	REV RkFlm H	1066	REV CrashCym
767	Maple Tom 2	842	Bongo Hi	917	REV RkRimpL	992	REV JzTomL p	1067	REV Crash 1
768	Maple Tom 3	843	Bongo Lo	918	REV RkRimpR	993	REV JzTomM p	1068	REV RkChina
769	Maple Tom 4	844	Cga Open Hi	919	REV RkRimpfL	994	REV JzTomH p	1069	REV China
770	808 Tom	845	Cga Open Lo	920	REV RkRimpfR	995	REV JzTomL f	1070	REV Cowbell
771	Verb Tom Hi	846	Cga Mute Hi	921	REV RkRimfL	996	REV JzTomM f	1071	REV WoodBlck
772	Verb Tom Lo	847	Cga Mute Lo	922	REV RkRimfR	997	REV JzTomH f	1072	REV Claves
773	Dry Tom Hi	848	Cga Slap	923	REV RkGstL	998	REV JzFlm L	1073	REV Conga
774	Dry Tom Lo	849	Timbale	924	REV RkGstR	999	REV JzFlm M	1074	REV Timbale
775	Rock CIHH1 p	850	Cabasa Up	925	REV SnareGst	1000	REV JzFlm H	1075	REV Maracas
776	Rock CIHH1mf	851	Cabasa Down	926	REV JzSNpL	1001	REV MplTom2	1076	REV Guiro
777	Rock CIHH1 f	852	Cabasa Cut	927	REV JzSNpR	1002	REV MplTom4	1077	REV Tamb 1
778	Rock CIHH2 p	853	Maracas	928	REV JzSNmfL	1003	REV 808Tom	1078	REV Tamb 2
779	Rock CIHH2mf	854	Long Guiro	929	REV JzSNmfR	1004	REV VerbTomH	1079	REV Cuica
780	Rock CIHH2 f	855	Tambourine 1	930	REV JzSNfL	1005	REV VerbTomL	1080	REV Timpani
781	Jazz CIHH1 p	856	Tambourine 2	931	REV JzSNfR	1006	REV DryTom H	1081	REV Timp3 pp
782	Jazz CIHH1mf	857	Open Triangl	932	REV JzSNffL	1007	REV DryTom M	1082	REV Timp3 mp
783	Jazz CIHH1 f	858	Cuica	933	REV JzSNffR	1008	REV RkCIH1 p	1083	REV Metro
784	Jazz CIHH2 p	859	Vibraslap	934	REV JzRimpL	1009	REV RkCIH1mf		
785	Jazz CIHH2mf	860	Timpani	935	REV JzRimpR	1010	REV RkCIH1 f		
786	Jazz CIHH2 f	861	Timp3 pp	936	REV JzRimfL	1011	REV RkCIH2 p		
787	CI HiHat 1	862	Timp3 mp	937	REV JzRimfR	1012	REV RkCIH2mf		
788	CI HiHat 2	863	Applause	938	REV JzRimfL	1013	REV RkCIH2 f		
789	CI HiHat 3	864	Syn FX Loop	939	REV JzRimfR	1014	REV JzCIH1 p		
790	CI HiHat 4	865	Loop 1	940	REV JzRimfL	1015	REV JzCIH1mf		
791	CI HiHat 5	866	Loop 2	941	REV JzRimfR	1016	REV JzCIH1 f		
792	Rock OpHH p	867	Loop 3	942	REV Brush 1	1017	REV JzCIH2 p		
793	Rock OpHH f	868	Loop 4	943	REV Brush 2	1018	REV JzCIH2mf		
794	Jazz OpHH p	869	Loop 5	944	REV Brush 3	1019	REV JzCIH2 f		
795	Jazz OpHH mf	870	Loop 6	945	REV JzSwish1	1020	REV CI HH 1		
796	Jazz OpHH f	871	Loop 7	946	REV JzSwish2	1021	REV CI HH 2		
797	Op HiHat	872	R8 Click	947	REV 909 SN 1	1022	REV CI HH 3		
798	Op HiHat 2	873	Metronome 1	948	REV 909 SN 2	1023	REV CI HH 4		
799	Rock PdHH p	874	Metronome 2	949	REV RkRoll L	1024	REV CI HH 5		
800	Rock PdHH f	875	MC500 Beep 1	950	REV RkRoll R	1025	REV RkOpHH p		
801	Jazz PdHH p	876	MC500 Beep 2	951	REV JzRoll	1026	REV RkOpHH f		
802	Jazz PdHH f	877	Low Saw	952	REV Dry Stk	1027	REV JzOpHH p		
803	Pedal HiHat	878	Low Saw inv	953	REV DrySick	1028	REV JzOpHHmf		
804	Pedal HiHat2	879	Low P5 Saw	954	REV Side Stk	1029	REV JzOpHH f		
805	Dance CI HH	880	Low Pulse 1	955	REV Wdy Stk	1030	REV Op HiHat		
806	909 NZ HiHat	881	Low Pulse 2	956	REV RkStk1L	1031	REV OpHiHat2		
807	70s CI HiHat	882	Low Square	957	REV RkStk1R	1032	REV RkPdHH p		
808	70s Op HiHat	883	Low Sine	958	REV RkStk2L	1033	REV RkPdHH f		
809	606 CI HiHat	884	Low Triangle	959	REV RkStk2R	1034	REV JzPdHH p		
810	606 Op HiHat	885	Low White NZ	960	REV Thrill	1035	REV JzPdHH f		
811	909 CI HiHat	886	Low Pink NZ	961	REV Dry Kick	1036	REV PedalHH		
812	909 Op HiHat	887	DC	962	REV Mpl Kick	1037	REV PedalHH2		
813	808 Claps	888	REV Orch.Hit	963	REV RkKik p	1038	REV Dance HH		
814	HumanClapsEQ	889	REV TeknoHit	964	REV RkKik mf	1039	REV 70s CIHH		
815	Tight Claps	890	REV Back Hit	965	REV RkKik f	1040	REV 70s OpHH		
816	Hand Claps	891	REV PhillHit	966	REV JzKik p	1041	REV 606 CIHH		
817	Finger Snaps	892	REV Steel DR	967	REV JzKik mf	1042	REV 606 OpHH		
818	Rock RdCym1p	893	REV Tin Wave	968	REV JzKik f	1043	REV 909 NZHH		
819	Rock RdCym1f	894	REV AmbiSNpL	969	REV Jaz Kick	1044	REV 909 OpHH		
820	Rock RdCym2p	895	REV AmbiSNpR	970	REV Piillow K	1045	REV HClapsEQ		
821	Rock RdCym2f	896	REV AmbiSNfL	971	REV Jz Dry K	1046	REV TghtClps		
822	Jazz RdCym p	897	REV AmbiSNfR	972	REV LiteKick	1047	REV FingSnap		
823	Jazz RdCymmf	898	REV Wet SNpL	973	REV Old Kick	1048	REV RealCLP		
824	Jazz RdCym f	899	REV Wet SNpR	974	REV Hybrid K	1049	REV RkRCym1p		
825	Ride 1	900	REV Wet SNfL	975	REV HybridK2	1050	REV RkRCym1f		

Patch List

USER

No.	Name	Category	Category No.	Voice	Key Assign	No.	Name	Category	Category No.	Voice	Key Assign
1	Grand XV	PNO	PIANO 1	4	POLY	65	HybStringsXV	STR	OCH/BRS 10	4	POLY
2	LFO Trance	PLS	SYN/PAD 67	8	POLY	66	Wind Wood	WND	OCH/BRS 45	4	POLY
3	808 SynBass	SBS	GTR/BS 56	3	MONO	67	NewR&RBrass	BRS	OCH/BRS 58	8	POLY
4	106 Strings	BPD	SYN/PAD 143	5	POLY	68	PortaSynLd	HLD	SYN/PAD 9	2	MONO
5	Soft Lead	SLD	SYN/PAD 32	3	POLY	69	Sine Lead	SLD	SYN/PAD 25	1	MONO
6	XV Strings	STR	OCH/BRS 1	3	POLY	70	Happy Brass	TEK	SYN/PAD 66	8	POLY
7	SmoothRhodes	EP	PIANO 36	4	POLY	71	GermanBounce	PLS	SYN/PAD 69	4	POLY
8	OSC Sync2020	HLD	SYN/PAD 10	1	MONO	72	Waspy Pulse	SYN	SYN/PAD 132	2	POLY
9	Sugar Key	SYN	SYN/PAD 127	2	POLY	73	2020 SquBs	SBS	GTR/BS 75	2	MONO
10	Soft Perky	ORG	KEY&ORG 31	5	POLY	74	Silicon Str	BPD	SYN/PAD 140	4	POLY
11	Flying Waltz	PLS	SYN/PAD 95	4	POLY	75	2.2 Strings	SPD	SYN/PAD 177	5	POLY
12	Silky Way	SPD	SYN/PAD 164	2	POLY	76	Vocals: Ooh	VOX	SYN/PAD 202	4	POLY
13	Now Bass	SBS	GTR/BS 62	3	MONO	77	MountainFolk	PLK	ETHNIC 5	2	POLY
14	SteelRelease	SPD	GTR/BS 4	4	POLY	78	2020 JunoBs	SBS	GTR/BS 70	2	MONO
15	Ambi Voices	TEK	SYN/PAD 55	8	POLY	79	Contemplate	PNO	PIANO 3	2	POLY
16	2020 Bell	BEL	KEY&ORG 15	2	POLY	80	Dreams Sine	EP	PIANO 41	1	POLY
17	Voyager Brs	BRS	OCH/BRS 69	5	POLY	81	Funky D6	KEY	KEY&ORG 2	3	POLY
18	2020SquLead	SLD	SYN/PAD 19	2	POLY	82	Rocker Spin	ORG	KEY&ORG 36	3	POLY
19	Rhodes Trem	EP	PIANO 32	2	POLY	83	LookMaNoFret	BS	GTR/BS 50	3	MONO
20	UltraSmooth	STR	OCH/BRS 9	2	POLY	84	Comp Bass	SBS	GTR/BS 71	1	MONO
21	Sub Zero	SBS	GTR/BS 54	4	MONO	85	Soft Symphny	ORC	OCH/BRS 25	7	POLY
22	JUNO Keys	SYN	SYN/PAD 119	2	POLY	86	Impact	HIT	OCH/BRS 32	4	POLY
23	2020 Digital	BPD	SYN/PAD 145	8	POLY	87	Biggie Brass	BRS	OCH/BRS 63	5	POLY
24	RockPiano Ch	PNO	PIANO 2	3	POLY	88	Solo AltoSax	SAX	OCH/BRS 83	2	MONO
25	Old School	HLD	SYN/PAD 6	4	MONO	89	Classy Pulse	HLD	SYN/PAD 16	2	POLY
26	JX SqrCarpet	SPD	SYN/PAD 168	2	POLY	90	House Piano	TEK	SYN/PAD 33	2	POLY
27	Perky B	ORG	KEY&ORG 42	2	POLY	91	Trance Fair	PLS	SYN/PAD 70	8	MONO
28	P5_TB	HLD	SYN/PAD 1	2	MONO	92	80s Retrosyn	SYN	SYN/PAD 134	2	POLY
29	5ths in 4ths	TEK	SYN/PAD 54	4	POLY	93	2020 Pls Bs	SBS	GTR/BS 78	1	MONO
30	GarageBass	SBS	GTR/BS 68	2	MONO	94	Digital Vox	BPD	SYN/PAD 155	5	POLY
31	Streamer	SYN	SYN/PAD 124	3	POLY	95	Heirborne	SPD	SYN/PAD 180	4	POLY
32	Hurtin'Tubes	DGT	GTR/BS 35	3	POLY	96	Lochscapes	ETH	ETHNIC 15	2	POLY
33	PureSineKey	EP	PIANO 40	1	POLY	97	Detune Bass	SBS	GTR/BS 66	2	MONO
34	Square Keys	BEL	KEY&ORG 8	2	POLY	98	Piano+SftPad	PNO	PIANO 14	4	POLY
35	Clear Guitar	EGT	GTR/BS 14	3	POLY	99	West Coast	PNO	PIANO 16	4	POLY
36	Tap Bass	BS	GTR/BS 41	1	POLY	100	96 Years	ORG	KEY&ORG 47	1	POLY
37	Spectre Vox	BPD	SYN/PAD 154	5	POLY	101	Two+Ensemble	SPD	GTR/BS 13	5	POLY
38	Analogue Str	SPD	SYN/PAD 167	4	POLY	102	2020 Bass 1	SBS	GTR/BS 72	1	MONO
39	SQR+Sub Bs	SBS	GTR/BS 77	1	POLY	103	Morph Pad	SPD	SYN/PAD 194	8	POLY
40	My Orchestra	ORC	OCH/BRS 24	4	POLY	104	TubbyTriangl	HLD	SYN/PAD 17	2	MONO
41	Reel Slam	HIT	OCH/BRS 35	4	POLY	105	Basic Mg	SLD	SYN/PAD 27	2	MONO
42	LegatoBamboo	FLT	OCH/BRS 50	4	MONO	106	House Chord	TEK	SYN/PAD 49	4	MONO
43	Valve Job	BRS	OCH/BRS 60	4	POLY	107	Trance Saws2	SYN	SYN/PAD 137	8	POLY
44	FatSynBrass	SBR	OCH/BRS 77	4	POLY	108	Square Bass	SBS	GTR/BS 76	2	MONO
45	Dreams East	SYN	SYN/PAD 126	2	POLY	109	Spectre	BPD	SYN/PAD 150	4	POLY
46	Solo SoprSax	SAX	OCH/BRS 81	1	MONO	110	Air Pad	SPD	SYN/PAD 186	3	POLY
47	Saw n' 202	TEK	SYN/PAD 64	2	POLY	111	Brite Vox	VOX	SYN/PAD 205	4	POLY
48	Cyber Pad	PLS	SYN/PAD 71	4	POLY	112	Celtic Harp	PLK	ETHNIC 9	2	POLY
49	Cyber SynBs	SBS	GTR/BS 60	2	MONO	113	S-Tone+SYNBS	SBS	GTR/BS 92	2	MONO
50	Pure Tibet	FX	SYN/PAD 107	1	POLY	114	Intentions	TEK	SYN/PAD 56	3	POLY
51	Gluey Pad	SPD	SYN/PAD 165	3	POLY	115	Soaring Hrns	BPD	SYN/PAD 148	6	POLY
52	Hydrogen	BPD	SYN/PAD 160	4	POLY	116	Fat Pad	SPD	SYN/PAD 189	4	POLY
53	Vocals: Boys	VOX	SYN/PAD 200	6	POLY	117	Hall Grand	PNO	PIANO 4	2	POLY
54	CheesyPluk 1	PLK	ETHNIC 11	2	POLY	118	PsychoRhodes	EP	PIANO 34	2	POLY
55	Cairo lead	ETH	ETHNIC 14	3	POLY	119	Wedding Mass	ORG	KEY&ORG 52	5	POLY
56	Warm pF Mix	PNO	PIANO 11	6	POLY	120	StabSawBass	SBS	GTR/BS 74	2	MONO
57	Full Rhodes	EP	PIANO 18	3	POLY	121	GR700 Pad	SPD	SYN/PAD 190	3	POLY
58	2020 Reso Bs	SBS	GTR/BS 61	2	MONO	122	Analog Seq	TEK	SYN/PAD 58	2	POLY
59	Rocker Org	ORG	KEY&ORG 34	6	POLY	123	Predator 2	FX	SYN/PAD 117	8	POLY
60	Soft Nylon	SPD	GTR/BS 2	4	POLY	124	West End Bs	SBS	GTR/BS 64	5	MONO
61	Swell Strat	EGT	GTR/BS 20	1	POLY	125	BPFsweep Mod	BPD	SYN/PAD 161	3	POLY
62	Searing Lead	DGT	GTR/BS 30	3	MONO	126	OvertoneScan	SPD	SYN/PAD 197	4	POLY
63	XV Ac.Bass	BS	GTR/BS 46	4	POLY	127	Tape Q	SFX	RHY&SFX 2	4	POLY
64	D9 Trcker	SBS	GTR/BS 63	2	MONO	128	Gruvacious	BTS	RHY&SFX 3	5	POLY

* For more information on Category, refer to p. 37.

Preset-A

No.	Name	Category	Category No.	Voice	Key Assign	No.	Name	Category	Category No.	Voice	Key Assign
1	Grand XV	PNO	PIANO1	4	POLY	65	Warm Vibes	MLT	24	2	POLY
2	RockPiano Ch	PNO	2	3	POLY	66	Dyna Marimba	MLT	25	1	POLY
3	Contemplate	PNO	3	2	POLY	67	Ambient Wood	MLT	26	2	POLY
4	Hall Grand	PNO	4	2	POLY	68	Nomad Perc	MLT	27	3	POLY
5	64voicePiano	PNO	5	1	POLY	69	Exotic Velo	MLT	28	4	POLY
6	Power Grand	PNO	6	3	POLY	70	Islands Mlt	MLT	29	4	POLY
7	E.Grand	PNO	7	1	POLY	71	Steel Drums	MLT	30	1	POLY
8	RD-1000	PNO	8	3	POLY	72	Soft Perky	ORG	31	5	POLY
9	MIDled Grand	PNO	9	3	POLY	73	Soft B	ORG	32	2	POLY
10	SparklePiano	PNO	10	6	POLY	74	Gospel Spin	ORG	33	3	POLY
11	Warm pF Mix	PNO	11	6	POLY	75	Rocker Org	ORG	34	6	POLY
12	PianoStrings	PNO	12	4	POLY	76	Velvet Organ	ORG	35	4	POLY
13	Y2K Concerto	PNO	13	8	POLY	77	Rocker Spin	ORG	36	3	POLY
14	Piano+SftPad	PNO	14	4	POLY	78	Full Stops	ORG	37	2	POLY
15	R&Ballad Mix	PNO	15	6	POLY	79	Ballad B	ORG	38	3	POLY
16	West Coast	PNO	16	4	POLY	80	Mellow Bars	ORG	39	4	POLY
17	Hit Rhodes	EP	17	3	POLY	81	Soap Opera	ORG	40	1	POLY
18	Full Rhodes	EP	18	3	POLY	82	AugerMentive	ORG	41	3	POLY
19	Player's EP	EP	19	2	POLY	83	Perky B	ORG	42	2	POLY
20	Retro Rhodes	EP	20	3	POLY	84	Klubb Organ	ORG	43	4	POLY
21	Fat Rhodes	EP	21	3	POLY	85	Drew's Bee	ORG	44	3	POLY
22	PingE Piano	EP	22	2	POLY	86	Purple Spin	ORG	45	4	POLY
23	Rholitzer	EP	23	3	POLY	87	Surf's Up!	ORG	46	2	POLY
24	Dig Rhodes	EP	24	2	POLY	88	96 Years	ORG	47	1	POLY
25	Delicate EP	EP	25	2	POLY	89	Glory Us Rok	ORG	48	2	POLY
26	Rhodes Mix	EP	26	3	POLY	90	D-50 Organ	ORG	49	2	POLY
27	D-50 Rhodes	EP	27	4	POLY	91	Cathedral	ORG	50	4	POLY
28	FM BellPiano	EP	28	3	POLY	92	Church Harmn	ORG	51	4	POLY
29	FM Delight	EP	29	2	POLY	93	Wedding Mass	ORG	52	5	POLY
30	Ring E.Piano	EP	30	4	POLY	94	XV Accordion	ACD	53	2	POLY
31	XV Crystal	EP	31	4	POLY	95	Harmo Blues	HRM	54	2	POLY
32	Rhodes Trem	EP	32	2	POLY	96	Nylon Gtr	AGT	GTR/BS1	1	POLY
33	Waterhodes	EP	33	2	POLY	97	Soft Nylon	AGT	2	4	POLY
34	PsychoRhodes	EP	34	2	POLY	98	Steel Away	AGT	3	3	POLY
35	MK-80 Phaser	EP	35	1	POLY	99	SteelRelease	AGT	4	4	POLY
36	SmoothRhodes	EP	36	4	POLY	100	Thick Steel	AGT	5	4	POLY
37	EP+Mod Pad	EP	37	4	POLY	101	XV Steel Gtr	AGT	6	4	POLY
38	Mr.Mellow	EP	38	4	POLY	102	Comp'Steel	AGT	7	4	POLY
39	Wurlie	EP	39	2	POLY	103	12str Guitar	AGT	8	3	POLY
40	PureSineKey	EP	40	1	POLY	104	Nylozzicato	AGT	9	3	POLY
41	Dreams Sine	EP	41	1	POLY	105	SpanishNight	AGT	10	5	POLY
42	Cutter Clav	KEY	KEY&ORG1	2	POLY	106	Hybrid Nylon	AGT	11	3	POLY
43	Funky D6	KEY	2	3	POLY	107	DesertCrystl	AGT	12	4	POLY
44	Phaze Clav	KEY	3	2	POLY	108	Two+Ensemble	AGT	13	5	POLY
45	Nasty Clav	KEY	4	2	POLY	109	Clear Guitar	EGT	14	3	POLY
46	Velo-Rez Clv	KEY	5	1	POLY	110	Jz Gtr Hall	EGT	15	1	POLY
47	Analog Clav	KEY	6	1	POLY	111	LetterFrmPat	EGT	16	4	POLY
48	St.Harpsichd	KEY	7	4	POLY	112	JC Strat	EGT	17	1	POLY
49	Square Keys	BEL	8	2	POLY	113	Twin Strats	EGT	18	3	POLY
50	D-50 Stack	BEL	9	4	POLY	114	Plug n' Play	EGT	19	2	POLY
51	Stacc.Heaven	BEL	10	4	POLY	115	Swell Strat	EGT	20	1	POLY
52	Heavenals	BEL	11	4	POLY	116	Fab 4 Guitar	EGT	21	4	POLY
53	Morning Lite	BEL	12	2	POLY	117	Muted Gtr	EGT	22	1	POLY
54	HolidayCheer	BEL	13	4	POLY	118	Velo-Wah Gtr	EGT	23	1	POLY
55	Prefab Chime	BEL	14	3	POLY	119	Tube Smoke	DGT	24	2	POLY
56	2020 Bell	BEL	15	2	POLY	120	Creamy	DGT	25	2	POLY
57	2.2 Bell Pad	BEL	16	4	POLY	121	Blusey OD	DGT	26	2	POLY
58	Tria Bells	BEL	17	4	POLY	122	Crying Solo	DGT	27	2	POLY
59	Music Bells	BEL	18	2	POLY	123	Feed Me!	DGT	28	4	POLY
60	Childlike	BEL	19	4	POLY	124	RockYurSocks	DGT	29	4	MONO
61	Celestabox	BEL	20	1	POLY	125	Searing Lead	DGT	30	3	MONO
62	Chime Bells	BEL	21	4	POLY	126	Loud Lead	DGT	31	3	POLY
63	Belfry Chime	BEL	22	3	POLY	127	OD 5ths	DGT	32	3	POLY
64	True Vibe	MLT	23	2	POLY	128	Crunch Split	DGT	33	4	POLY

* For more information on Category, refer to p. 37.

Patch List

Preset-B

No.	Name	Category	Category No.	Voice	Key Assign	No.	Name	Category	Category No.	Voice	Key Assign
1	Rezodrive	DGT	GTR/BS34	2	MONO	65	Marcato	STR	5	2	POLY
2	Hurtin'Tubes	DGT	35	3	POLY	66	String Ens	STR	6	4	POLY
3	R&R Chunk	DGT	36	4	POLY	67	Marcato Str	STR	7	4	POLY
4	Power Trip	DGT	37	2	POLY	68	Fat Strings	STR	8	3	POLY
5	Pick Bass	BS	38	1	MONO	69	UltraSmooth	STR	9	2	POLY
6	Hip Bass	BS	39	2	POLY	70	HybStringsXV	STR	10	4	POLY
7	Homey Bass	BS	40	2	MONO	71	ViolinCello	STR	11	4	POLY
8	Tap Bass	BS	41	1	POLY	72	Lead 4x Vlns	STR	12	4	POLY
9	Pop Bass	BS	42	1	POLY	73	ChmbrQuartet	STR	13	4	POLY
10	TremCho Bs	BS	43	2	POLY	74	FullChmbrStr	STR	14	6	POLY
11	Nylon Bass	BS	44	2	POLY	75	Film Octaves	STR	15	4	POLY
12	XV Upright	BS	45	1	POLY	76	Bass Pizz	STR	16	4	POLY
13	XV Ac.Bass	BS	46	4	POLY	77	JP-8 Str 1	STR	17	2	POLY
14	XV Fretless	BS	47	1	POLY	78	JP-8 Str 2	STR	18	3	POLY
15	Basic F'less	BS	48	1	MONO	79	Deep Strings	STR	19	2	POLY
16	8-str F'less	BS	49	2	POLY	80	Hold A Chord	STR	20	6	POLY
17	LookMaNoFret	BS	50	3	MONO	81	Tape Strings	STR	21	2	POLY
18	Slap Bass 1	BS	51	1	POLY	82	Symphonique	ORC	22	4	POLY
19	Slap Bass 2	BS	52	1	MONO	83	Full Orchest	ORC	23	4	POLY
20	Slap Bass 3	BS	53	2	POLY	84	My Orchestra	ORC	24	4	POLY
21	Sub Zero	SBS	54	4	MONO	85	Soft Symphny	ORC	25	7	POLY
22	SinusoidRave	SBS	55	1	MONO	86	Henry VIII	ORC	26	8	POLY
23	808 SynBass	SBS	56	3	MONO	87	Wood Symphny	ORC	27	7	POLY
24	Acid TB	SBS	57	1	MONO	88	Prelude	ORC	28	4	POLY
25	MC-TB Bass	SBS	58	3	MONO	89	TudorFanfare	ORC	29	4	POLY
26	TB Tra Bass	SBS	59	3	MONO	90	Brassy Symph	ORC	30	4	POLY
27	Cyber SynBs	SBS	60	2	MONO	91	4 Hits 4 You	HIT	31	4	POLY
28	2020 Reso Bs	SBS	61	2	MONO	92	Impact	HIT	32	4	POLY
29	Now Bass	SBS	62	3	MONO	93	Phase Hit	HIT	33	3	POLY
30	D9 Trcker	SBS	63	2	MONO	94	Tekno Hit	HIT	34	2	POLY
31	West End Bs	SBS	64	5	MONO	95	Reel Slam	HIT	35	4	POLY
32	TB Squelch	SBS	65	2	POLY	96	OffTheRecord	HIT	36	4	POLY
33	Detune Bass	SBS	66	2	MONO	97	3rdTeenChrd	HIT	37	4	POLY
34	FatPolyBass	SBS	67	3	MONO	98	Auto Chord	HIT	38	4	POLY
35	GarageBass	SBS	68	2	MONO	99	MOVE!	HIT	39	6	MONO
36	2020 OrgBs	SBS	69	3	MONO	100	Oboe mf	WND	40	1	POLY
37	2020 JunoBs	SBS	70	2	MONO	101	Clarinet mp	WND	41	1	POLY
38	Comp Bass	SBS	71	1	MONO	102	SwellEnsembl	WND	42	4	POLY
39	2020 Bass 1	SBS	72	1	MONO	103	ChamberWoods	WND	43	3	POLY
40	2020 Bass 2	SBS	73	1	MONO	104	Flute/Clari	WND	44	2	POLY
41	StabSawBass	SBS	74	2	MONO	105	Wind Wood	WND	45	4	POLY
42	2020 SquBs	SBS	75	2	MONO	106	Flute	FLT	46	2	POLY
43	Square Bass	SBS	76	2	MONO	107	Jazzier Flute	FLT	47	2	POLY
44	SQR+Sub Bs	SBS	77	1	POLY	108	VOX Flute	FLT	48	4	POLY
45	2020 Pls Bs	SBS	78	1	MONO	109	Pan Pipes	FLT	49	2	POLY
46	Grounded Bs	SBS	79	2	MONO	110	LegatoBamboo	FLT	50	4	MONO
47	2pole Bass	SBS	80	2	MONO	111	The Andes	FLT	51	1	POLY
48	4pole Bass	SBS	81	2	MONO	112	Deja Vlute	FLT	52	4	MONO
49	House Bass	SBS	82	3	MONO	113	Majestic Tpt	BRS	53	1	MONO
50	Bass Trap	SBS	83	2	MONO	114	Ballad Trump	BRS	54	4	POLY
51	Bass In Face	SBS	84	2	MONO	115	Mute TP mod	BRS	55	4	POLY
52	Ticker Bass	SBS	85	4	MONO	116	Harmon Mute	BRS	56	1	POLY
53	Klack Bass	SBS	86	2	MONO	117	Tpt Sect	BRS	57	4	POLY
54	Hugo Bass	SBS	87	4	MONO	118	NewR&RBrass	BRS	58	8	POLY
55	Mg Bass	SBS	88	2	MONO	119	Simply Brass	BRS	59	2	POLY
56	New Acid Grv	SBS	89	2	MONO	120	Valve Job	BRS	60	4	POLY
57	8VCO MonoSyn	SBS	90	8	MONO	121	Tower Trumps	BRS	61	5	POLY
58	Wonder Bass	SBS	91	3	MONO	122	BigBrassBand	BRS	62	5	POLY
59	S-Tone+SYNBS	SBS	92	2	MONO	123	Biggie Brass	BRS	63	5	POLY
60	Booty Bass	SBS	93	3	MONO	124	Lil'BigHornz	BRS	64	6	POLY
61	XV Strings	STR	OCH/BRS1	3	POLY	125	Sm.Brass Grp	BRS	65	4	POLY
62	St.Strings	STR	2	2	POLY	126	Trombone	BRS	66	1	POLY
63	Dolce p/m/f	STR	3	6	POLY	127	Trombone Atm	BRS	67	3	POLY
64	Sad Strings	STR	4	6	POLY	128	Massed Horns	BRS	68	3	POLY

* For more information on Category, refer to p. 37.

Preset-C

No.	Name	Category	Category No.	Voice	Key Assign	No.	Name	Category	Category No.	Voice	Key Assign
1	Voyager Brs	BRS	OCH/BRS69	5	POLY	65	Velo Tekno	TEK	45	2	POLY
2	3 Osc Brass	SBR	70	3	POLY	66	Rezoid	TEK	46	4	POLY
3	Poly Brass	SBR	71	3	POLY	67	Booster Bips	TEK	47	2	POLY
4	Brass It!	SBR	72	4	POLY	68	Mental Chord	TEK	48	4	MONO
5	Archimede	SBR	73	3	POLY	69	House Chord	TEK	49	4	MONO
6	Breathy Brs	SBR	74	3	POLY	70	GenderBender	TEK	50	4	MONO
7	Triumph Brs	SBR	75	3	POLY	71	MinorIncident	TEK	51	4	MONO
8	P5 Polymod	SBR	76	2	POLY	72	Winky	TEK	52	8	POLY
9	FatSynBrass	SBR	77	4	POLY	73	Dance Zipper	TEK	53	4	MONO
10	True ANALOG	SBR	78	2	POLY	74	5ths in 4ths	TEK	54	4	POLY
11	Afro Horns	SBR	79	3	POLY	75	Ambi Voices	TEK	55	8	POLY
12	Sop.Sax mf	SAX	80	2	POLY	76	Intentions	TEK	56	3	POLY
13	Solo SoprSax	SAX	81	1	MONO	77	Pick It	TEK	57	3	POLY
14	Alto Sax	SAX	82	3	POLY	78	Analog Seq	TEK	58	2	POLY
15	Solo AltoSax	SAX	83	2	MONO	79	Sequalog	TEK	59	4	POLY
16	XV DynoTenor	SAX	84	3	POLY	80	Plik-Plok	TEK	60	2	POLY
17	Honker Bari	SAX	85	2	POLY	81	Big BPF	TEK	61	4	POLY
18	Sax Choir	SAX	86	4	POLY	82	Agent X	TEK	62	7	POLY
19	Full Saxz	SAX	87	7	POLY	83	Keep :-)	TEK	63	2	POLY
20	Swingin' Bari	SAX	88	3	POLY	84	Saw n' 202	TEK	64	2	POLY
21	P5_TB	HLD	SYN/PAD1	2	MONO	85	RagelnYouth	TEK	65	3	POLY
22	Soaring Saws	HLD	2	6	MONO	86	Happy Brass	TEK	66	8	POLY
23	FXM Saw Lead	HLD	3	4	MONO	87	LFO Trance	PLS	67	8	POLY
24	BOG	HLD	4	3	MONO	88	Syncrosonix	PLS	68	3	POLY
25	Square Roots	HLD	5	2	MONO	89	GermanBounce	PLS	69	4	POLY
26	Old School	HLD	6	4	MONO	90	Trance Fair	PLS	70	8	MONO
27	Retro Lead	HLD	7	2	MONO	91	Cyber Pad	PLS	71	4	POLY
28	Loud SynLead	HLD	8	4	MONO	92	S&H Pad	PLS	72	1	POLY
29	PortaSynLd	HLD	9	2	MONO	93	PressureDome	PLS	73	4	POLY
30	OSC Sync2020	HLD	10	1	MONO	94	Pulsatronic	PLS	74	3	POLY
31	Talking Box	HLD	11	3	MONO	95	Cyber Dreams	PLS	75	3	POLY
32	Blistering	HLD	12	2	MONO	96	Alive	PLS	76	3	POLY
33	MG Interval	HLD	13	4	MONO	97	Trancing Pad	PLS	77	2	POLY
34	Analog Lead	HLD	14	2	MONO	98	Acid JaZZ	PLS	78	5	MONO
35	5th Lead	HLD	15	2	MONO	99	Alternative	PLS	79	2	MONO
36	Classy Pulse	HLD	16	2	POLY	100	Acid Line	PLS	80	1	MONO
37	TubbyTriangl	HLD	17	2	MONO	101	Raggatronic	PLS	81	4	POLY
38	Square Lead	SLD	18	3	POLY	102	Temple of JV	PLS	82	4	POLY
39	2020SquLead	SLD	19	2	POLY	103	Blades	PLS	83	4	POLY
40	Creamer	SLD	20	2	MONO	104	Foiled Again	PLS	84	1	POLY
41	Belly Lead	SLD	21	4	POLY	105	Planet Asia	PLS	85	4	POLY
42	Flyin' High	SLD	22	3	MONO	106	Afterlife	PLS	86	3	POLY
43	SH-2000	SLD	23	2	MONO	107	Cultivate	PLS	87	5	POLY
44	Soft Tooth	SLD	24	2	MONO	108	Paz <=> Zap	PLS	88	1	MONO
45	Sine Lead	SLD	25	1	MONO	109	Strobe Mode	PLS	89	4	POLY
46	Smoothe	SLD	26	2	MONO	110	Albion	PLS	90	2	POLY
47	Basic Mg	SLD	27	2	MONO	111	Running Pad	PLS	91	4	POLY
48	LegatoJupitr	SLD	28	1	MONO	112	Rippling	PLS	92	1	POLY
49	Soaring Sqr	SLD	29	4	MONO	113	Random Pad	PLS	93	4	POLY
50	Soaring Sync	SLD	30	4	MONO	114	SoundtrkDANC	PLS	94	4	POLY
51	Nasal Spray	SLD	31	2	MONO	115	Flying Waltz	PLS	95	4	POLY
52	Soft Lead	SLD	32	3	POLY	116	Phazweep	PLS	96	4	POLY
53	House Piano	TEK	33	2	POLY	117	Mad Bender	PLS	97	6	POLY
54	Techno Dream	TEK	34	3	POLY	118	X-mod Reso	FX	98	1	POLY
55	Organizer	TEK	35	3	POLY	119	Shapeshifter	FX	99	4	POLY
56	Auto TB-303	TEK	36	3	MONO	120	Glistening	FX	100	4	POLY
57	Dist TB-303	TEK	37	2	MONO	121	Atmospherics	FX	101	4	POLY
58	Resojuice	TEK	38	2	MONO	122	Vektogram	FX	102	4	POLY
59	B'on d'moov	TEK	39	3	POLY	123	Feedback VOX	FX	103	4	POLY
60	Con Sequence	TEK	40	2	POLY	124	Helium Queen	FX	104	4	MONO
61	Technoheadz	TEK	41	4	POLY	125	Holographix	FX	105	2	POLY
62	Phunky DC	TEK	42	2	MONO	126	Shattered	FX	106	2	POLY
63	Shortrave	TEK	43	2	POLY	127	Pure Tibet	FX	107	1	POLY
64	Cross Fire	TEK	44	2	POLY	128	X-Tension	FX	108	2	POLY

* For more information on Category, refer to p. 37.

Patch List

Preset-D

No.	Name	Category	Category No.	Voice	Key Assign	No.	Name	Category	Category No.	Voice	Key Assign
1	Dark Side	FX	SYN/PAD109	8	POLY	65	Dimensional	SPD	173	2	POLY
2	Dunes	FX	110	4	POLY	66	Jupiterings	SPD	174	2	POLY
3	The Beast	FX	111	6	POLY	67	3D Flanged	SPD	175	1	POLY
4	Ocean Floor	FX	112	1	POLY	68	Glassy Pad	SPD	176	3	POLY
5	Cyber Space	FX	113	3	POLY	69	2.2 Strings	SPD	177	5	POLY
6	Nexus	FX	114	8	POLY	70	Moving Glass	SPD	178	1	POLY
7	ForestMoon	FX	115	8	POLY	71	ShiftedGlass	SPD	179	2	POLY
8	Planet Meta	FX	116	7	POLY	72	Heirborne	SPD	180	4	POLY
9	Predator 2	FX	117	8	POLY	73	Translucence	SPD	181	4	POLY
10	Flashback	FX	118	4	POLY	74	Darkshine	SPD	182	4	POLY
11	JUNO Keys	SYN	119	2	POLY	75	Shiny Pad	SPD	183	4	POLY
12	Poly Key	SYN	120	3	POLY	76	Analog Drama	SPD	184	3	POLY
13	Poly Saws	SYN	121	4	POLY	77	BandPass Mod	SPD	185	2	POLY
14	Dual Profs	SYN	122	3	POLY	78	Air Pad	SPD	186	3	POLY
15	Saw Mass	SYN	123	4	POLY	79	Soundtraque	SPD	187	2	POLY
16	Streamer	SYN	124	3	POLY	80	Octapad	SPD	188	3	POLY
17	Soft Puff	SYN	125	2	POLY	81	Fat Pad	SPD	189	4	POLY
18	Dreams East	SYN	126	2	POLY	82	GR700 Pad	SPD	190	3	POLY
19	Sugar Key	SYN	127	2	POLY	83	Rotary Pad	SPD	191	4	POLY
20	D50FantaPerc	SYN	128	3	POLY	84	Dawn 2 Dusk	SPD	192	3	POLY
21	Galactic	SYN	129	8	POLY	85	Aurora	SPD	193	4	POLY
22	Pulse Key	SYN	130	3	POLY	86	Morph Pad	SPD	194	8	POLY
23	Wire Pad	SYN	131	3	POLY	87	Sun Dive	SPD	195	7	POLY
24	Waspy Pulse	SYN	132	2	POLY	88	Sabbath Day	SPD	196	4	POLY
25	Glider	SYN	133	2	POLY	89	OvertoneScan	SPD	197	4	POLY
26	80s Retrosyn	SYN	134	2	POLY	90	December Sky	SPD	198	4	POLY
27	Powerwigggle	SYN	135	3	POLY	91	NothrnLights	SPD	199	4	POLY
28	Trance Saws1	SYN	136	8	POLY	92	Vocals: Boys	VOX	200	6	POLY
29	Trance Saws2	SYN	137	8	POLY	93	St. Choir	VOX	201	4	POLY
30	Don't Jump	SYN	138	8	POLY	94	Vocals: Ooh	VOX	202	4	POLY
31	AirSoThin	SYN	139	2	POLY	95	Pvox Oooze	VOX	203	3	POLY
32	Silicon Str	BPD	140	4	POLY	96	RandomVowels	VOX	204	4	POLY
33	PWM Strings	BPD	141	3	POLY	97	Brite Vox	VOX	205	4	POLY
34	Vintage Orch	BPD	142	4	POLY	98	Beauty Vox	VOX	206	3	POLY
35	106 Strings	BPD	143	5	POLY	99	Longing...	VOX	207	3	POLY
36	Modular Life	BPD	144	4	POLY	100	Enlighten	VOX	208	4	POLY
37	2020 Digital	BPD	145	8	POLY	101	Arasian Morn	VOX	209	4	POLY
38	Oscillations	BPD	146	4	POLY	102	Dark Vox	VOX	210	2	POLY
39	Greek Power	BPD	147	4	POLY	103	Belltree Vox	VOX	211	4	POLY
40	Soaring Hrns	BPD	148	6	POLY	104	Spaced Voxx	VOX	212	4	POLY
41	Rolling 5ths	BPD	149	4	POLY	105	Glass Voices	VOX	213	3	POLY
42	Spectre	BPD	150	4	POLY	106	Doos	VOX	214	1	POLY
43	Glass Orbit	BPD	151	3	POLY	107	Wavox	VOX	215	3	POLY
44	Hush Pad	BPD	152	4	POLY	108	Sitar	PLK	ETHNIC1	2	POLY
45	Pivotal Pad	BPD	153	4	POLY	109	Dulcimer	PLK	2	2	POLY
46	Spectre Vox	BPD	154	5	POLY	110	Dulcitar	PLK	3	4	POLY
47	Digital Vox	BPD	155	5	POLY	111	Drone Split	PLK	4	4	POLY
48	Stringsheen	BPD	156	3	POLY	112	MountainFolk	PLK	5	2	POLY
49	Combing	BPD	157	2	POLY	113	EastrnEurope	PLK	6	3	POLY
50	5th Sweep	BPD	158	4	POLY	114	Harp	PLK	7	2	POLY
51	MG Sweep	BPD	159	4	POLY	115	VellHarp)Harm	PLK	8	3	POLY
52	Hydrogen	BPD	160	4	POLY	116	Celtic Harp	PLK	9	2	POLY
53	BPFsweep Mod	BPD	161	3	POLY	117	AmbiPizza	PLK	10	5	POLY
54	Mod DirtyWav	BPD	162	3	POLY	118	CheesyPluk 1	PLK	11	2	POLY
55	X-mod Sweep	BPD	163	1	POLY	119	CheesyPluk 2	PLK	12	2	POLY
56	Silky Way	SPD	164	2	POLY	120	Taj Mahal	ETH	13	1	POLY
57	Gluey Pad	SPD	165	3	POLY	121	Cairo lead	ETH	14	3	POLY
58	Dreamesque	SPD	166	4	POLY	122	Lochscapes	ETH	15	2	POLY
59	Analogue Str	SPD	167	4	POLY	123	Celtic Song	ETH	16	4	POLY
60	JX SqrCarpet	SPD	168	2	POLY	124	Far East	ETH	17	4	POLY
61	Pulsify	SPD	169	4	POLY	125	Slap Timps	PRC	RHY&SFX1	4	POLY
62	JP-8Haunting	SPD	170	4	POLY	126	Tape Q	SFX	2	4	POLY
63	Earth Blow	SPD	171	2	POLY	127	Gruvacious	BTS	3	5	POLY
64	Jet Pad	SPD	172	2	POLY	128	Blue Notes	CMB	4	4	POLY

* For more information on Category, refer to p. 37.

GM (General MIDI)

No.	Name	Voice	LSB	PC	No.	Name	Voice	LSB	PC	No.	Name	Voice	LSB	PC	No.	Name	Voice	LSB	PC
001	Piano 1	4	0	1	065	Chorus Gt.	2	1		129	French Horns	2	0	61	193	Sitar	1	0	105
002	Piano 1w	2	1		066	Mid Tone GTR	1	2		130	Fr.Horn 2	2	1		194	Sitar 2	2	1	
003	European Pf	1	2		067	Muted Gt.	1	0	29	131	Brass 1	3	0	62	195	Banjo	1	0	106
004	Piano 2	4	0	2	068	Funk Pop	1	1		132	Brass 2	2	1		196	Shamisen	1	0	107
005	Piano 2w	1	1		069	Funk Gt.2	2	2		133	Synth Brass1	2	0	63	197	Koto	2	0	108
006	Piano 3	1	0	3	070	Jazz Man	2	3		134	Pro Brass	2	1		198	Taisho Koto	1	1	
007	Piano 3w	1	1		071	Overdrive Gt	2	0	30	135	Oct SynBrass	2	2		199	Kalimba	1	0	109
008	Honky-tonk	2	0	4	072	Guitar Pinch	2	1		136	Jump Brass	3	3		200	Bagpipe	2	0	110
009	Honky-tonk 2	2	1		073	DistortionGt	2	0	31	137	Synth Brass2	2	0	64	201	Fiddle	1	0	111
010	E.Piano 1	2	0	5	074	Feedback Gt.	2	1		138	SynBrass sfz	2	1		202	Shanai	1	0	112
011	St.Soft EP	2	1		075	Dist Rtm GTR	2	2		139	Velo Brass 1	2	2		203	Tinkle Bell	3	0	113
012	FM+SA EP	2	2		076	Gt.Harmonics	1	0	32	140	Soprano Sax	1	0	65	204	Agogo	1	0	114
013	Wurlty	2	3		077	Gt. Feedback	1	1		141	Alto Sax	1	0	66	205	Steel Drums	1	0	115
014	E.Piano 2	2	0	6	078	Acoustic Bs.	1	0	33	142	Tenor Sax	2	0	67	206	Woodblock	1	0	116
015	Detuned EP 2	2	1		079	Fingered Bs.	1	0	34	143	Baritone Sax	1	0	68	207	Castanets	1	1	
016	St.FM EP	2	2		080	Finger Slap	2	1		144	Oboe	2	0	69	208	Taiko	3	0	117
017	EP Legend	2	3		081	Picked Bass	1	0	35	145	English Horn	1	0	70	209	Concert BD	2	1	
018	EP Phase	2	4		082	Fretless Bs.	1	0	36	146	Bassoon	1	0	71	210	Melo. Tom 1	1	0	118
019	Harpichord	1	0	7	083	Slap Bass 1	1	0	37	147	Clarinet	1	0	72	211	Melo. Tom 2	1	1	
020	Coupled Hps.	2	1		084	Slap Bass 2	2	0	38	148	Piccolo	1	0	73	212	Synth Drum	2	0	119
021	Harpsi.w	1	2		085	Synth Bass 1	1	0	39	149	Flute	1	0	74	213	808 Tom	2	1	
022	Harpsi.o	2	3		086	SynthBass101	1	1		150	Recorder	1	0	75	214	Elec Perc	1	2	
023	Clav.	1	0	8	087	Acid Bass	1	2		151	Pan Flute	1	0	76	215	Reverse Cym.	1	0	120
024	Pulse Clav	1	1		088	Clavi Bass	2	3		152	Bottle Blow	2	0	77	216	Gt.FretNoise	1	0	121
025	Celesta	1	0	9	089	Hammer	2	4		153	Shakuhachi	2	0	78	217	Gt.Cut Noise	1	1	
026	Glockenspiel	1	0	10	090	Synth Bass 2	2	0	40	154	Whistle	1	0	79	218	String Slap	1	2	
027	Music Box	1	0	11	091	Beef FM Bass 2	1	1		155	Ocarina	2	0	80	219	Breath Noise	1	0	122
028	Vibraphone	2	0	12	092	RubberBass 2	2	2		156	Square Wave	2	0	81	220	Fl.Key Click	1	1	
029	Vibraphone w	2	1		093	Attack Pulse	1	3		157	MG Square	1	1		221	Seashore	1	0	123
030	Marimba	1	0	13	094	Violin	1	0	41	158	2600 Sine	1	2		222	Rain	1	1	
031	Marimba w	1	1		095	Slow Violin	1	1		159	Saw Wave	2	0	82	223	Thunder	1	2	
032	Xylophone	1	0	14	096	Viola	1	0	42	160	OB2 Saw	1	1		224	Wind	1	3	
033	Tubular-bell	1	0	15	097	Cello	1	0	43	161	Doctor Solo	2	2		225	Stream	2	4	
034	Church Bell	1	1		098	Contrabass	1	0	44	162	Natural Lead	2	3		226	Bubble	2	5	
035	Carillon	1	2		099	Tremolo Str	1	0	45	163	SequencedSaw	2	4		227	Bird	2	0	124
036	Santur	1	0	16	100	PizzicatoStr	1	0	46	164	Syn.Calliope	2	0	83	228	Dog	1	1	
037	Organ 1	2	0	17	101	Harp	1	0	47	165	Chiffer Lead	2	0	84	229	Horse-Gallop	1	2	
038	Trem. Organ	2	1		102	Yang Qin	2	1		166	Charang	2	0	85	230	Bird 2	1	3	
039	60's Organ 1	1	2		103	Timpani	1	0	48	167	Wire Lead	2	1		231	Telephone 1	1	0	125
040	70's E.Organ	2	3		104	Strings	2	0	49	168	Solo Vox	2	0	86	232	Telephone 2	1	1	
041	Organ 2	2	0	18	105	Orchestra	3	1		169	5th Saw Wave	2	0	87	233	DoorCreaking	1	2	
042	Chorus Or.2	2	1		106	60s Strings	2	2		170	Bass & Lead	2	0	88	234	Door	1	3	
043	Perc. Organ	2	2		107	Slow Strings	1	0	50	171	Delayed Lead	2	1		235	Scratch	2	4	
044	Organ 3	2	0	19	108	Syn.Strings1	2	0	51	172	Fantasia	2	0	89	236	Wind Chimes	2	5	
045	Church Org.1	1	0	20	109	Syn.Strings3	2	1		173	Warm Pad	1	0	90	237	Helicopter	2	0	126
046	Church Org.2	2	1		110	Syn.Strings2	2	0	52	174	Sine Pad	2	1		238	Car-Engine	1	1	
047	Church Org.3	2	2		111	Choir Aahs	2	0	53	175	Polysynth	2	0	91	239	Car-Stop	1	2	
048	Reed Organ	1	0	21	112	Chorus Aahs	2	1		176	Space Voice	2	0	92	240	Car-Pass	1	3	
049	Puff Organ	2	1		113	Voice Oohs	1	0	54	177	Itopia	2	1		241	Car-Crash	2	4	
050	Accordion Fr	2	0	22	114	Humming	2	1		178	Bowed Glass	3	0	93	242	Siren	1	5	
051	Accordion It	2	1		115	SynVox	1	0	55	179	Metal Pad	3	0	94	243	Train	1	6	
052	Harmonica	1	0	23	116	Analog Voice	1	1		180	Halo Pad	2	0	95	244	Jetplane	2	7	
053	Bandoneon	2	0	24	117	OrchestraHit	2	0	56	181	Sweep Pad	1	0	96	245	Starship	2	8	
054	Nylon-str.Gt	1	0	25	118	Bass Hit	2	1		182	Ice Rain	2	0	97	246	Burst Noise	2	9	
055	Ukulele	1	1		119	6th Hit	2	2		183	Soundtrack	2	0	98	247	Applause	2	0	127
056	Nylon Gt.o	2	2		120	Euro Hit	2	3		184	Crystal	2	0	99	248	Laughing	1	1	
057	Nylon Gt.2	2	3		121	Trumpet	1	0	57	185	Syn Mallet	1	1		249	Screaming	1	2	
058	Steel-str.Gt	1	0	26	122	Dark Trumpet	1	1		186	Atmosphere	2	0	100	250	Punch	1	3	
059	12-str.Gt	2	1		123	Trombone	1	0	58	187	Brightness	2	0	101	251	Heart Beat	1	4	
060	Mandolin	2	2		124	Trombone 2	1	1		188	Goblin	2	0	102	252	Footsteps	1	5	
061	Steel + Body	2	3		125	Bright Tb	1	2		189	Echo Drops	1	0	103	253	Gun Shot	1	0	128
062	Jazz Gt.	1	0	27	126	Tuba	1	0	59	190	Echo Bell	2	1		254	Machine Gun	1	1	
063	Pedal Steel	1	1		127	MutedTrumpet	1	0	60	191	Echo Pan	2	2		255	Lasergun	1	2	
064	Clean Gt.	1	0	28	128	MuteTrumpet2	1	1		192	Star Theme	2	0	104	256	Explosion	2	3	

Voice: number of voice LSB: Bank Select LSB, MSB is all 121 PC: Program Change Number Key Assign: all POLY

Rhythm Set List

User Group

Note No.	001 R&B Kit	002 House Kit	003 Techno Kit	004 Jazz Kit
28	Dance Kick	House Kick 6	TechnoKick 6	JazzDry Kick
29	Dry Kick	House Kick 5	TechnoKick 5	Pillow Kick
30	R&B SN Roll	House CIHH 3	TechnoCIHH 4	Jazz Swish
31	Hybrid Kick1	House Kick 4	TechnoKick 4	Hybrid Kick
32	R&B SN Ghost	Reso Stick	TechnoSNGhst	Snare Ghost
33	Round Kick	House Kick 3	TechnoKick 3	MplLmtr Kick
34	R&B PdHH	House OpHH 2	TechnoCIHH 3	Jazz PdHH
35	R&B Kick 2	House Kick 2	TechnoKick 2	JazzDry Kick
C2	R&B Kick 1	House Kick 1	TechnoKick 1	Jazz Kick
37	R&B Stick	House Stick	TechnoStick	SideStick
38	R&B SN 1	House SN 1	TechnoSN 1	Jz SN w/Ghst
39	Snare Ghost	House Claps1	808 Clap	Jazz SN Ghst
40	R&B SN 2	House SN 2	TechnoSN 2	Jz SN w/Rim
41	R&B Tom L	House NzTomL	TechnoTom1 L	Jazz Tom L
42	R&B CIHH 1	House CIHH 1	TechnoCIHH 1	Jazz Pedel
43	Rock Flm L	808 Tom L	TechnoTom2 L	Jazz Flm L
44	R&B CIHH 2	House CIHH 2	TechnoCIHH 2	Jazz CIHH
45	R&B Tom M	House NzTomM	TechnoTom1 M	Jazz Tom M
46	R&B OpHH	House OpHH 1	TechnoOpHH	Jazz OpHH
47	Rock Flm M	808 Tom M	TechnoTom2 M	Jazz Flm M
C3	R&B Tom H	House NzTomH	TechnoTom1 H	Jazz Tom H
49	R&B CrCym1	House CrCym	TechnoCrCym	Jazz CrCym
50	Rock Flm H	808 Tom H	TechnoTom2 H	Jazz Flm H
51	Rock RdCym1	House FbkCym	TechnoCym	Jazz RdCym
52	R&B CrCym2	House SN 3	TechnoRvSNRI	Rock RdCym1
53	Rock RdCym2	House FSNaps	808 Crash	Rock RdCym2
54	Tambourine	House CIHH 4	TechnoBrSlap	Tambourine
55	Rock CrCym	House Cowbel	TechnoNzStik	Crash 1
56	Cowbell Lo	House CIHH 5	TechnoCIHH 5	Cowbell Lo
57	Crash	House WBlock	TechnoSNRoll	Crash 2
58	Cowbell Hi	House OpHH 3	TechnoRvJzRI	Cowbell Hi
59	Ride Bell	House Claps2	TechnoSiren	Ride Bell
C4	Bongo Hi	House Cabasa	TechnoLoop	Cga Mute Hi
61	Bongo Lo	House WCrak	TechnoLoNz	Cga Mute Lo
62	Cga Mute Hi	House VoxNz	TechnoRdCym	Cga Slap
63	Cga Open Hi	House Kick 7	TechnoCowbel	Cga Open Hi
64	Cga Open Lo	Timpani	TechnoTel	Cga Open Lo
65	Timbale Hi	House Bird	TechnoTimpni	Timbale Hi
66	Timbale Lo	House Gun 1	TechnoCIHH 6	Timbale Lo
67	R&B AgBel1	House FBell	TechnoRvOHit	AgogoBellsHi
68	R&B AgBel2	House Rattle	TechnoRvTHit	AgogoBellsLo
69	R&B AgBel3	House RvOHit	TechnoRvBHt1	Cabasa Up
70	Maracas	House Noize1	TechnoRvBHt2	Maracas
71	606 CI HiHat	House Noize2	TechnoWBlock	ShortWhistle
C5	606 CI HiHat	House BongoL	TechnoKick 7	Long Whistle
73	606 Op HiHat	House BongoH	TechnoCIHH 7	Short Guiro
74	Long Guiro	House Tambrn	TechnoRim 1	Long Guiro
75	Claves	House Heart	TechnoRim 2	Claves
76	Wood BlockHi	House CgaSlp	TechnoBrRoll	WoodBlock Hi
77	Wood BlockLo	House Cgmute	TehcnolcRain	WoodBlock Lo
78	R&B Pizz	House Tri	TechnoThrill	Mute Cuica
79	R&B Gamelan	House Vibra	TechnoSN 3	Open Cuica
80	Mute Triangl	House FXLoop	TechnoWCrak	Mute Triangl
81	Open Triangl	House Aplase	TechnoScrach	Open Triangl
82	R&B Thrill L	House Chord	TechnoBNz	Cabasa Cut
83	R&B Thrill H	House OrcHit	TechnoSN 4	Spectrum
C6	808 SN	House Spectr	TechnoPunch	Wind Chimes
85	R&B WoodBlk	House Train	TehcnoplInk	Wood Block
86	R&B Cga Slap	House StrSip	TechnoRvRoll	Mute Surdo
87	Dry Tom L	House Crunch	TechnoOSC	Open Surdo
88	Lite Kick	House Tel	TechnoNz 1	Lite Kick
89	Hybrid Kick2	House Bubble	TechnoTkHit	Hybrid Kick
90	Old Kick	Bird	TechnoBubble	Old Kick
91	Pop Voice	House Gun 2	TechnoNz 2	Pop Voice
92	Wind Agogo	House Metro	TechnoNz 3	Wind Agogo
93	OpHH FX 1	House BakHit	TechnoNz 4	OpHH FX 1
94	Anklungs	House TekHit	TechnoPwChrd	Anklungs
95	OpHH FX 2	House SNRoll	TechnoBckHit	OpHH FX 2
C7	Metronome 2	House Loop	TechnoNz 5	Metronome 2
97	R8 Click	R8 Click	R8 Click	R8 Click
98	Metronome 1	Metronome	TechnoNz 6	Metronome 1
99	R&B HClaps	Hand Claps	Hand Claps	Hand Claps
100	Scratch 1	House Tom L	TechnoKick 8	Jazz CrCym
101	Scratch 2	House Tom M	TechnoKick 9	Crash 2
102	Scratch 3	House Rim	TechnoSN 5	Rock RdCym2
103	Syn FX Loop	House Tom H	TechnoCIHH 8	Crash 1

Preset A Group

Note No.	001 <u>R&B Kit</u>	002 <u>House Kit</u>	003 <u>Techno Kit</u>	004 <u>XV Pop Kit</u>
28	Dance Kick	House Kick 6	TechnoKick 6	Dance Kick
29	Dry Kick	House Kick 5	TechnoKick 5	Dry Kick
30	R&B SN Roll	House CIHH 3	TechnoCIHH 4	Rock Roll
31	Hybrid Kick1	House Kick 4	TechnoKick 4	Hybrid Kick1
32	R&B SN Ghost	Reso Stick	TechnoSNGhst	Snare Ghost
33	Round Kick	House Kick 3	TechnoKick 3	Round Kick
34	R&B PdHH	House OpHH 2	TechnoCIHH 3	Rock PdHH
35	R&B Kick 2	House Kick 2	TechnoKick 2	Hybrid Kick2
C2 36	R&B Kick 1	House Kick 1	TechnoKick 1	Old Kick
37	R&B Stick	House Stick	TechnoStick	Side Stick
38	R&B SN 1	House SN 1	TechnoSN 1	Wet SN
39	Snare Ghost	House Claps1	808 Clap	Snare Ghost
40	R&B SN 2	House SN 2	TechnoSN 2	AmbientSN
41	R&B Tom L	House NzTomL	TechnoTom1 L	Maple Tom L
42	R&B CIHH 1	House CIHH 1	TechnoCIHH 1	Rock CIHH 1
43	Rock Flm L	808 Tom L	TechnoTom2 L	Rock Flm L
44	R&B CIHH 2	House CIHH 2	TechnoCIHH 2	Rock CIHH 2
45	R&B Tom M	House NzTomM	TechnoTom1 M	Maple Tom M
46	R&B OpHH	House OpHH 1	TechnoOpHH	Rock OpHH
47	Rock Flm M	808 Tom M	TechnoTom2 M	Rock Flm M
C3 48	R&B Tom H	House NzTomH	TechnoTom1 H	Maple Tom H
49	R&B CrCym1	House CrCym	TechnoCrCym	Crash Cymbal
50	Rock Flm H	808 Tom H	TechnoTom2 H	Rock Flm H
51	Rock RdCym1	House FbkCym	TechnoCym	Rock RdCym1
52	R&B CrCym2	House SN 3	TechnoRvSNRI	Crash 1
53	Rock RdCym2	House FSnaps	808 Crash	Rock RdCym2
54	Tambourine	House CIHH 4	TechnoBrSlap	Tambourine
55	Rock CrCym	House Cowbel	TechnoNzStik	Rock CrCym
56	Cowbell Lo	House CIHH 5	TechnoCIHH 5	Cowbell Lo
57	Crash	House WBlock	TechnoSNRoll	Crash 2
58	Cowbell Hi	House OpHH 3	TechnoRvJzRI	Cowbell Hi
59	Ride Bell	House Claps2	TechnoSiren	Ride Bell
C4 60	Bongo Hi	House Cabasa	TechnoLoop	Cga Mute Hi
61	Bongo Lo	House WCrak	TechnoLoNz	Cga Mute Lo
62	Cga Mute Hi	House VoxNz	TechnoRdCym	Cga Slap
63	Cga Open Hi	House Kick 7	TechnoCowbel	Cga Open Hi
64	Cga Open Lo	Timpani	TechnoTel	Cga Open Lo
65	Timbale Hi	House Bird	TechnoTimpni	Timbale Hi
66	Timbale Lo	House Gun 1	TechnoCIHH 6	Timbale Lo
67	R&B AgBel1	House FBell	TechnoRvOHit	AgogoBellsHi
68	R&B AgBel2	House Rattle	TechnoRvTHit	AgogoBellsLo
69	R&B AgBel3	House RvOHit	TechnoRvBHt1	Cabasa Up
70	Maracas	House Noize1	TechnoRvBHt2	Maracas
71	606 CI HiHat	House Noize2	TechnoWBlock	ShortWhistle
C5 72	606 CI HiHat	House BongoL	TechnoKick 7	Long Whistle
73	606 Op HiHat	House BongoH	TechnoCIHH 7	Short Guiro
74	Long Guiro	House Tambrn	TechnoRim 1	Long Guiro
75	Claves	House Heart	TechnoRim 2	Claves
76	Wood BlockHi	House CgaSlp	TechnoBrRoll	WoodBlock Hi
77	Wood BlockLo	House Cgmute	TehcnolcRain	WoodBlock Lo
78	R&B Pizz	House Tri	TechnoThrill	Mute Cuica
79	R&B Gamelan	House Vibra	TechnoSN 3	Open Cuica
80	Mute Triangl	House FXLoop	TechnoWCrak	Mute Triangl
81	Open Triangl	House Aplase	TechnoScrach	Open Triangl
82	R&B Thrill L	House Chord	TechnoBNz	Cabasa Cut
83	R&B Thrill H	House OrCHit	TechnoSN 4	Spectrum
C6 84	808 SN	House Spectr	TechnoPunch	Wind Chimes
85	R&B WoodBlk	House Train	Tehcnopluk	Wood Block
86	R&B Cga Slap	House StrSip	TechnoRvRoll	Mute Surdo
87	Dry Tom L	House Crunch	TechnoOSC	Open Surdo
88	Lite Kick	House Tel	TechnoNz 1	Lite Kick
89	Hybrid Kick2	House Bubble	TechnoTkHit	Hybrid Kick3
90	Old Kick	Bird	TechnoBubble	Old Kick
91	Pop Voice	House Gun 2	TechnoNz 2	Pop Voice
92	Wind Agogo	House Metro	TechnoNz 3	Wind Agogo
93	OpHH FX 1	House BakHit	TechnoNz 4	OpHH FX 1
94	Anklungs	House TekHit	TechnoPwChrd	Anklungs
95	OpHH FX 2	House SNRoll	TechnoBckHit	OpHH FX 2
C7 96	Metronome 2	House Loop	TechnoNz 5	Metronome 2
97	R8 Click	R8 Click	R8 Click	R8 Click
98	Metronome 1	Metronome	TechnoNz 6	Metronome 1
99	R&B HClaps	Hand Claps	Hand Claps	Hand Claps
100	Scratch 1	House Tom L	TechnoKick 8	Rock CrCym
101	Scratch 2	House Tom M	TechnoKick 9	Rock RdCym2
102	Scratch 3	House Rim	TechnoSN 5	Cowbell Lo
103	Syn FX Loop	House Tom H	TechnoCIHH 8	Crash 1

Rhythm Set List

Preset B Group

Note No.	001 <u>XV Rock Kit</u>	002 <u>Jazz Kit</u>	003 <u>XV Rust Kit</u>	004 <u>OrchestraKit</u>
28	Dance Kick	JazzDry Kick	70s Kick 3	Old Kick
29	Round Kick	Pillow Kick	Old Kick	Round Kick
30	Rock Roll	Jazz Swish	Rock Roll	SN Roll
31	Jazz Kick	Hybrid Kick	909 Kick 2	Jazz Kick
32	Rock Ghost	Snare Ghost	Rock Ghost	Snare Ghost
33	Verb Kick	MplLmtr Kick	909 Kick 1	Verb Kick
34	Rock PdHH	Jazz PdHH	Rock PdHH	Pedal HiHat1
35	Maple Kick	JazzDry Kick	808Kick Long	Concert BD 2
C2 36	Rock Kick	Jazz Kick	Dance Kick 1	Concert BD 1
37	RockStick	SideStick	RockStick	Side Stick
38	Rock SN 1	Jz SN w/Ghst	Old Fill SN	Concert SN
39	Rock Ghost	Jazz SN Ghst	Rock Ghost	Snare Ghost
40	Rock SN 2	Jz SN w/Rim	Rock SN	Snare Roll
41	Rock Tom L	Jazz Tom L	Elec. Tom L2	Timpani
42	Rock CIHH 1	Jazz Pedel	Rock CIHH1	Timpani
43	Rock Flm L	Jazz Flm L	Elec. Tom L1	Timpani
44	Rock CIHH 2	Jazz CIHH	Rock CIHH2	Timpani
45	Rock Tom M	Jazz Tom M	Elec. Tom M	Timpani
46	Rock OpHH	Jazz OpHH	Rock OpHH	Timpani
47	Rock Flm M	Jazz Flm M	Elec. Tom M	Timpani
C3 48	Rock Tom H	Jazz Tom H	Elec. Tom H	Timpani
49	Rock CrCym1	Jazz CrCym	Rock CrCym1	Timpani
50	Rock Flm H	Jazz Flm H	Elec. Tom H	Timpani
51	Rock RdCym1	Jazz RdCym	Rock RdCym1	Timpani
52	Rock China	Rock RdCym1	Rock CrCym2	Timpani
53	Rock RdCym2	Rock RdCym2	Rock RdCym2	Timpani
54	Tambourine	Tambourine	Tambourine 1	Tambourine 1
55	Rock CrCym2	Crash 1	Rock Splash	Crash 1
56	Cowbell Lo	Cowbell Lo	Cowbell	Cowbell
57	Crash	Crash 2	China Cym	Crash 2
58	Cowbell Hi	Cowbell Hi	Vibraslap	Ride 1
59	Ride Bell	Ride Bell	70s Kick 2	Ride 2
C4 60	Cga Mute Hi	Cga Mute Hi	70s Kick 1	Bongo Hi
61	Cga Mute Lo	Cga Mute Lo	Dry Stick	Bongo Lo
62	Cga Slap	Cga Slap	70s SN	Cga Mute Hi
63	Cga Open Hi	Cga Open Hi	Finger Snaps	Cga Open Hi
64	Cga Open Lo	Cga Open Lo	HumanClapsEQ	Cga Open Lo
65	Timbale Hi	Timbale Hi	JD Cowbell	Timbale Hi
66	Timbale Lo	Timbale Lo	70s CI HiHat	Timbale Lo
67	AgogoBellsHi	AgogoBellsHi	AgogoBells	AgogoBellsHi
68	AgogoBellsLo	AgogoBellsLo	70s CI HiHat	AgogoBellsLo
69	Cabasa Up	Cabasa Up	909 NZ HiHat	Cabasa Up
70	Maracas	Maracas	70s Op HiHat	Maracas
71	ShortWhistle	ShortWhistle	Cabasa Up	ShortWhistle
C5 72	Long Whistle	Long Whistle	Long Whistle	Long Whistle
73	Short Guiro	Short Guiro	REV RkOpHH f	Short Guiro
74	Long Guiro	Long Guiro	Tambourine 2	Long Guiro
75	Claves	Claves	REV JzOpHH f	Claves
76	WoodBlock Hi	WoodBlock Hi	Scratch	WoodBlock Hi
77	WoodBlock Lo	WoodBlock Lo	Mute Triangl	WoodBlock Lo
78	Mute Cuica	Mute Cuica	909 CI HiHat	Cuica Hi
79	Open Cuica	Open Cuica	Open Triangl	Cuica Lo
80	Mute Triangl	Mute Triangl	909 CI HiHat	Mute Triangl
81	Open Triangl	Open Triangl	Cabasa	Open Triangl
82	Cabasa Cut	Cabasa Cut	909 Op HiHat	Cabasa Cut
83	Spectrum	Spectrum	Spectrum	Spectrum
C6 84	Wind Chimes	Wind Chimes	Maple Kick	Wind Chimes
85	Wood Block	Wood Block	Woody Stick	Wood Block
86	Mute Surdo	Mute Surdo	Maple SN	Cga Slap
87	Open Surdo	Open Surdo	SN Roll	Dry Tom Lo
88	Lite Kick	Lite Kick	Maple Tom	Applause
89	Hybrid Kick	Hybrid Kick	909 Kick 1	Hybrid Kick2
90	Old Kick	Old Kick	Old Kick	CI HiHat
91	Pop Voice	Pop Voice	808Kick Shrt	Round Kick
92	Wind Agogo	Wind Agogo	909 SN 2	Pedal HiHat2
93	OpHH FX 1	OpHH FX 1	909 SN 1	Natural SN
94	Anklungs	Anklungs	808 SN	Op HiHat
95	OpHH FX 2	OpHH FX 2	Dance Kick 2	Brush Slap
C7 96	Metronome 2	Metronome 2	REV Timpani	Brush Swish
97	R8 Click	R8 Click	R8 Click	Brush Roll
98	Metronome 1	Metronome 1	Metronome	SN Roll
99	Hand Claps	Hand Claps	808 Claps	Orch Cymbal
100	Rock CrCym1	Jazz CrCym	Rock CrCym2	Cabasa Cut
101	Rock China	Crash 2	Rock Splash	Claves
102	Rock RdCym2	Rock RdCym2	Rock RdCym2	Tambourine 2
103	Crash	Crash 1	Rock CrCym1	Orch. Hit

Rhythm Set List

GM (GM2 Group)

Note No.	001 (PC: 1) GM2 STANDARD	002 (PC: 9) GM2 ROOM	003 (PC: 17) GM2 POWER	004 (PC: 25) GM2 ELECTRIC	005 (PC: 26) GM2 ANALOG	006 (PC: 33) GM2 JAZZ
27	High-Q	High-Q	High-Q	High-Q	High-Q	High-Q
28	Slap	Slap	Slap	Slap	Slap	Slap
29	ScratchPush	ScratchPush	ScratchPush	ScratchPush	ScratchPush	ScratchPush
30	ScratchPull	ScratchPull	ScratchPull	ScratchPull	ScratchPull	ScratchPull
31	Sticks	Sticks	Sticks	Sticks	Sticks	Sticks
32	SquareClick	SquareClick	SquareClick	SquareClick	SquareClick	SquareClick
33	Mtrnm.Click	Mtrnm.Click	Mtrnm.Click	Mtrnm.Click	Mtrnm.Click	Mtrnm.Click
34	Mtrnm. Bell	Mtrnm. Bell	Mtrnm. Bell	Mtrnm. Bell	Mtrnm. Bell	Mtrnm. Bell
35	Mix Kick	Mix Kick	Mix Kick	Mix Kick	Mix Kick	Jazz Kick 2
C2 36	Standard KK1	Standard KK1	Power Kick1	Elec Kick 1	TR-808 Kick	Jazz Kick 1
37	Side Stick	Side Stick	Side Stick	Side Stick	808 Rimshot	Side Stick
38	Standard SN1	Standard SN1	Dance Snare1	Elec. Snare	808 Snare 1	Standard SN1
39	909 HandClap	909 HandClap	909 HandClap	909 HandClap	909 HandClap	909 HandClap
40	Elec Snare 3	Elec Snare 3	Elec Snare 3	Elec Snare 2	Elec Snare 3	Elec Snare 3
41	Real Tom 6	Room Tom 5	Rock Tom 4	Synth Drum 2	808 Tom 2	Real Tom 6
42	Close HiHat2	Close HiHat2	Close HiHat2	Close HiHat2	TR-808 CHH	Close HiHat2
43	Real Tom 6	Room Tom 5	Rock Tom 4	Synth Drum 2	808 Tom 2	Real Tom 6
44	Pedal HiHat2	Pedal HiHat2	Pedal HiHat2	Pedal HiHat2	808_chh	Pedal HiHat2
45	Real Tom 4	Room Tom 2	Rock Tom 4	Synth Drum 2	808 Tom 2	Real Tom 4
46	Open HiHat2	Open HiHat2	Open HiHat2	Open HiHat2	TR-808 OHH	Open HiHat2
47	Real Tom 4	Room Tom 2	Rock Tom 4	Synth Drum 2	808 Tom 2	Real Tom 4
C3 48	Real Tom 1	Room Tom 2	Rock Tom 1	Synth Drum 2	808 Tom 2	Real Tom 1
49	Crash Cym.1	Crash Cym.1	Crash Cym.1	Crash Cym.1	808 Crash	Crash Cym.1
50	Real Tom 1	Room Tom 2	Rock Tom 1	Synth Drum 2	808 Tom 2	Real Tom 1
51	Ride Cymbal	Ride Cymbal	Ride Cymbal	Ride Cymbal	Ride Cymbal	Ride Cymbal
52	ChinaCymbal	ChinaCymbal	ChinaCymbal	ReverseCymbal	ChinaCymbal	ChinaCymbal
53	Ride Bell	Ride Bell	Ride Bell	Ride Bell	Ride Bell	Ride Bell
54	Tambourine	Tambourine	Tambourine	Tambourine	Tambourine	Tambourine
55	Splash Cym.	Splash Cym.	Splash Cym.	Splash Cym.	Splash Cym.	Splash Cym.
56	Cowbell	Cowbell	Cowbell	Cowbell	808cowbe	Cowbell
57	Crash Cym.2	Crash Cym.2	Crash Cym.2	Crash Cym.2	Crash Cym.2	Crash Cym.2
58	Vibraslap	Vibraslap	Vibraslap	Vibraslap	Vibraslap	Vibraslap
59	Ride Cymbal	Ride Cymbal	Ride Cymbal	Ride Cymbal	Ride Cymbal	Ride Cymbal
C4 60	Bongo High	Bongo High	Bongo High	Bongo High	Bongo High	Bongo High
61	Bongo Lo	Bongo Lo	Bongo Lo	Bongo Lo	Bongo Lo	Bongo Lo
62	Mute H.Conga	Mute H.Conga	Mute H.Conga	Mute H.Conga	808 Conga	Mute H.Conga
63	Conga Hi Opn	Conga Hi Opn	Conga Hi Opn	Conga Hi Opn	808 Conga	Conga Hi Opn
64	Conga Lo Opn	Conga Lo Opn	Conga Lo Opn	Conga Lo Opn	808 Conga	Conga Lo Opn
65	High Timbale	High Timbale	High Timbale	High Timbale	High Timbale	High Timbale
66	Low Timbale	Low Timbale	Low Timbale	Low Timbale	Low Timbale	Low Timbale
67	Agogo	Agogo	Agogo	Agogo	Agogo	Agogo
68	Agogo	Agogo	Agogo	Agogo	Agogo	Agogo
69	Cabasa	Cabasa	Cabasa	Cabasa	Cabasa	Cabasa
70	Maracas	Maracas	Maracas	Maracas	808marac	Maracas
71	ShrtWhistle	ShrtWhistle	ShrtWhistle	ShrtWhistle	ShrtWhistle	ShrtWhistle
C5 72	LongWhistle	LongWhistle	LongWhistle	LongWhistle	LongWhistle	LongWhistle
73	Short Guiro	Short Guiro	Short Guiro	Short Guiro	Short Guiro	Short Guiro
74	Long Guiro	Long Guiro	Long Guiro	Long Guiro	Long Guiro	Long Guiro
75	Claves	Claves	Claves	Claves	808clave	Claves
76	Woodblock	Woodblock	Woodblock	Woodblock	Woodblock	Woodblock
77	Woodblock	Woodblock	Woodblock	Woodblock	Woodblock	Woodblock
78	Mute Cuica	Mute Cuica	Mute Cuica	Mute Cuica	Mute Cuica	Mute Cuica
79	Open Cuica	Open Cuica	Open Cuica	Open Cuica	Open Cuica	Open Cuica
80	MuteTriangl	MuteTriangl	MuteTriangl	MuteTriangl	MuteTriangl	MuteTriangl
81	OpenTriangl	OpenTriangl	OpenTriangl	OpenTriangl	OpenTriangl	OpenTriangl
82	Shaker	Shaker	Shaker	Shaker	Shaker	Shaker
83	Jingle Bell	Jingle Bell	Jingle Bell	Jingle Bell	Jingle Bell	Jingle Bell
C6 84	Bell Tree	Bell Tree	Bell Tree	Bell Tree	Bell Tree	Bell Tree
85	Castanets	Castanets	Castanets	Castanets	Castanets	Castanets
86	Mute Surdo	Mute Surdo	Mute Surdo	Mute Surdo	Mute Surdo	Mute Surdo
87	Open Surdo	Open Surdo	Open Surdo	Open Surdo	Open Surdo	Open Surdo
88	----	----	----	----	----	----

PC: Program Change Number

Bank Select MSB is all 120, LSB is all 0

Rhythm Set List

GM (GM2 Group)

Note No.	007 (PC: 41) GM2 BRUSH	008 (PC: 49) GM2 ORCHSTRA	009 (PC: 57) GM2 SFX
27	High-Q	Close HiHat2	----
28	Slap	Pedal HiHat2	----
29	ScratchPush	Open HiHat2	----
30	ScratchPull	Ride Cymbal	----
31	Sticks	Sticks	----
32	SquareClick	SquareClick	----
33	Mtrnm.Click	Mtrnm.Click	----
34	Mtrnm. Bell	Mtrnm. Bell	----
35	Jazz Kick 2	Concert BD	----
C2 36	Jazz Kick 1	ConcertBD Mt	----
37	Side Stick	Side Stick	----
38	Brush Swirl	Concert Snr	----
39	Brush Slap1	Castanets	High-Q
40	Brush Swirl	Concert Snr	Slap
41	Real Tom 6	Timpani	ScratchPush
42	Close HiHat2	Timpani	ScratchPull
43	Real Tom 6	Timpani	Sticks
44	Pedal HiHat2	Timpani	SquareClick
45	Real Tom 4	Timpani	Mtrnm.Click
46	Open HiHat2	Timpani	Mtrnm. Bell
47	Real Tom 4	Timpani	Gt.FretNoiz
C3 48	Real Tom 1	Timpani	Gt.CutNoise
49	Crash Cym.1	Timpani	Gt.CutNoise
50	Real Tom 1	Timpani	String Slap
51	Ride Cymbal	Timpani	Fl.KeyClick
52	ChinaCymbal	Timpani	Laughing
53	Ride Bell	Timpani	Screaming
54	Tambourine	Tambourine	Punch
55	Splash Cym.	Splash Cym.	Heart Beat
56	Cowbell	Cowbell	Footsteps
57	Crash Cym.2	Con.Cymbal2	Footsteps
58	Vibraslap	Vibraslap	Applause
59	Ride Cymbal	Concert Cym.	Creaking
C4 60	Bongo High	Bongo High	Door
61	Bongo Lo	Bongo Lo	Scratch
62	Mute H.Conga	Mute H.Conga	Wind Chimes
63	Conga Hi Opn	Conga Hi Opn	Car-Engine
64	Conga Lo Opn	Conga Lo Opn	Car-Stop
65	High Timbale	High Timbale	Car-Pass
66	Low Timbale	Low Timbale	Car-Crash
67	Agogo	Agogo	Siren
68	Agogo	Agogo	Train
69	Cabasa	Cabasa	Jetplane
70	Maracas	Maracas	Helicopter
71	ShrtWhistle	ShrtWhistle	Starship
C5 72	LongWhistle	LongWhistle	Gun Shot
73	Short Guiro	Short Guiro	Machine Gun
74	Long Guiro	Long Guiro	Lasergun
75	Claves	Claves	Explosion
76	Woodblock	Woodblock	Dog
77	Woodblock	Woodblock	HorseGallop
78	Mute Cuica	Mute Cuica	Bird
79	Open Cuica	Open Cuica	Rain
80	MuteTriangl	MuteTriangl	Thunder
81	OpenTriangl	OpenTriangl	Wind
82	Shaker	Shaker	Seashore
83	Jingle Bell	Jingle Bell	Stream
C6 84	Bell Tree	Bell Tree	Bubble
85	Castanets	Castanets	----
86	Mute Surdo	Mute Surdo	----
87	Open Surdo	Open Surdo	----
88	----	Applause	----

PC: Program Change Number

Bank Select MSB is all 120, LSB is all 0

Performance List

USER				Preset-A		Preset-B	
No.	Name	No.	Name	No.	Name	No.	Name
001	BigSweepStak	033	Symphony2020	001	BigSweepStak	001	Symphony2020
002	Suger Bell	034	Barococo	002	Suger Bell	002	Barococo
003	R&B Kit	035	ChildrenSplt	003	R&B Kit	003	ChildrenSplt
004	Trance Split	036	Huge Space	004	Trance Split	004	Huge Space
005	My Orchestra	037	DulcitarStk	005	My Orchestra	005	DulcitarStk
006	Road2Glass	038	NebularVoxx	006	Road2Glass	006	NebularVoxx
007	Analog Stack	039	Asian Dream	007	Analog Stack	007	Asian Dream
008	Flying Keys	040	Pizz Stack	008	Flying Keys	008	Pizz Stack
009	House Kit	041	Pad / SoftLd	009	House Kit	009	Pad / SoftLd
010	Soaring 2020	042	Organ / Lead	010	Soaring 2020	010	Organ / Lead
011	Seven Hills	043	Bass / Lead	011	Seven Hills	011	Bass / Lead
012	TeknoSplit 1	044	S&H / Pad	012	TeknoSplit 1	012	S&H / Pad
013	Nirvana 2020	045	Drone / Pipe	013	Nirvana 2020	013	Drone / Pipe
014	StChorusStak	046	Seq:Template	014	StChorusStak	014	Seq:Template
015	Bell Stack	047	Seq:R&B	015	Bell Stack	015	Seq:R&B
016	Trance Fair	048	Seq:Hip-Hop	016	Trance Fair	016	Seq:Hip-Hop
017	AggressiveXV	049	Seq:Techno	017	AggressiveXV	017	Seq:Techno
018	Techno Kit	050	Seq:House	018	Techno Kit	018	Seq:House
019	PhsDyno&Bs	051	Seq:Trance	019	PhsDyno&Bs	019	Seq:Trance
020	Dawn Choir	052	Seq:Pop	020	Dawn Choir	020	Seq:Pop
021	DulcimaSteel	053	Seq:FunkRock	021	DulcimaSteel	021	Seq:FunkRock
022	TeknoSplit 2	054	Seq:HardRock	022	TeknoSplit 2	022	Seq:HardRock
023	InstantScore	055	Seq:Blues	023	InstantScore	023	Seq:Blues
024	Voltage Ctrl	056	Seq:Ac.Jazz	024	Voltage Ctrl	024	Seq:Ac.Jazz
025	CrystalChoir	057	Seq:Cont.Jz	025	CrystalChoir	025	Seq:Cont.Jz
026	BlisteringLd	058	Seq:BigBand	026	BlisteringLd	026	Seq:BigBand
027	Asian Split	059	Seq:Latin	027	Asian Split	027	Seq:Latin
028	PhasePadStk	060	Seq:World	028	PhasePadStk	028	Seq:World
029	Hybrid Str	061	Seq:NewAge	029	Hybrid Str	029	Seq:NewAge
030	Dear Friends	062	Seq:Orch	030	Dear Friends	030	Seq:Orch
031	Pop Kit	063	Seq:Film	031	Pop Kit	031	Seq:Film
032	Bell Layer	064	Seq:GM2Temp	032	Bell Layer	032	Seq:GM2Temp

Demo Song List

Song Title	Composer / Copyright
1. U feel Me	Kazuhiko Maeda © 2002 Roland Corporation
2. Negativa Trance	Mark Lawrence © 2002 Roland Corporation
3. Eye on the Universe	Takayuki Aihara – STUDIO CARNAVAL © 2002 Roland Corporation
4. First Impression	Scott Wilkie © 2002 Scott Wilkie (ASCAP) www.scottwilkie.com



All rights reserved. Unauthorized use of this material for purposes other than private, personal enjoyment is a violation of applicable laws.

MIDI Implementation

Model: XV-2020
Date: 2002.6.4
Version: 1.00

1. Receive data

■Channel Voice Messages

* Not received in Performance mode when the Receive Switch parameter (Performance Part) is OFF.

●Note off

Status	2nd byte	3rd byte
8nH	kkH	vvH
9nH	kkH	00H
n = MIDI channel number:	0H - FH (ch.1 - 16)	
kk = note number:	00H - 7FH (0 - 127)	
vv = note off velocity:	00H - 7FH (0 - 127)	

* Not received when the Envelope Mode parameter (Patch Tone and Rhythm Tone) is NO-SUS.

●Note on

Status	2nd byte	3rd byte
9nH	kkH	vvH
n = MIDI channel number:	0H - FH (ch.1 - 16)	
kk = note number:	00H - 7FH (0 - 127)	
vv = note on velocity:	01H - 7FH (1 - 127)	

●Polyphonic Key Pressure

Status	2nd byte	3rd byte
AnH	kkH	vvH
n = MIDI channel number:	0H - FH (ch.1 - 16)	
kk = note number:	00H - 7FH (0 - 127)	
vv = Polyphonic Key Pressure:	00H - 7FH (0 - 127)	

* Not received in Performance mode when the Receive Poly Key Pressure parameter (Performance MIDI) is OFF.

●Control Change

- * If the corresponding Controller number is selected for the Patch Control Source 1, 2, 3 or 4 parameter (Patch Common), the corresponding effect will occur.
- * If a Controller number that corresponds to the System Control Source 1, 2, 3 or 4 parameter (System Common) is selected, the specified effect will apply if Patch Control Source 1, 2, 3 or 4 parameter (Patch Common) is set to SYS-CTRL1, SYS-CTRL2, SYS-CTRL3 or SYS-CTRL4.

○Bank Select (Controller number 0, 32)

Status	2nd byte	3rd byte
BnH	00H	mmH
BnH	20H	llH
n = MIDI channel number:	0H - FH (ch.1 - 16)	
mm, ll = Bank number:	00 00H - 7F 7FH (bank.1 - bank.16384)	

- * Not received in Performance mode when the Receive Bank Select (Performance MIDI) is OFF.
- * The Performances, Patches, and Rhythms corresponding to each Bank Select are as follows.
- * The SRX series corresponding to each Bank Select are to see the SRX series owner's manual.

BANK MSB	SELECT LSB	PROGRAM NUMBER	GROUP	NUMBER
085	000	001 - 064	User Performance	001 - 064
	064	001 - 032	Preset Performance A	001 - 032
	065	001 - 032	Preset Performance B	001 - 032
086	000	001 - 004	User Rhythm	001 - 004
	064	001 - 002	Preset Rhythm A	001 - 004
	065	001 - 002	Preset Rhythm B	001 - 004
087	000	001 - 128	User Patch	001 - 128
	064	001 - 128	Preset Patch A	001 - 128
	065	001 - 128	Preset Patch B	001 - 128
092	000 -	001 -	SRX Rhythm	001 -
	:	:	:	:
093	000 -	001 -	SRX Patch	001 -
	:	:	:	:
120	000 -	001 - 057	GM Rhythm	001 - 009
121		001 - 128	GM Patch	001 - 256

○Modulation (Controller number 1)

Status	2nd byte	3rd byte
BnH	01H	vvH
n = MIDI channel number:	0H - FH (ch.1 - 16)	
vv = Modulation depth:	00H - 7FH (0 - 127)	

* Not received in Performance mode when the Receive Modulation parameter (Performance MIDI) is OFF.

○Breath type (Controller number 2)

Status	2nd byte	3rd byte
BnH	02H	vvH
n = MIDI channel number:	0H - FH (ch.1 - 16)	
vv = Control value:	00H - 7FH (0 - 127)	

○Foot type (Controller number 4)

Status	2nd byte	3rd byte
BnH	04H	vvH
n = MIDI channel number:	0H - FH (ch.1 - 16)	
vv = Control value:	00H - 7FH (0 - 127)	

○Portamento Time (Controller number 5)

Status	2nd byte	3rd byte
BnH	05H	vvH
n = MIDI channel number:	0H - FH (ch.1 - 16)	
vv = Portamento Time:	00H - 7FH (0 - 127)	

* In Performance mode the Part Portament Time parameter (Performance Part) will change.

○Data Entry (Controller number 6, 38)

Status	2nd byte	3rd byte
BnH	06H	mmH
BnH	26H	llH
n = MIDI channel number:	0H - FH (ch.1 - 16)	
mm, ll = the value of the parameter specified by RPN/NRPN		
mm = MSB, ll = LSB		

○Volume (Controller number 7)

Status	2nd byte	3rd byte
BnH	07H	vvH
n = MIDI channel number:	0H - FH (ch.1 - 16)	
vv = Volume:	00H - 7FH (0 - 127)	

* Not received in Performance mode when the Receive Volume parameter (Performance MIDI) is OFF.

* In Performance mode the Part Level parameter (Performance Part) will change.

○Balance (Controller number 8)

Status	2nd byte	3rd byte
BnH	08H	vvH
n = MIDI channel number:	0H - FH (ch.1 - 16)	
vv = Balance:	00H - 7FH (0 - 127)	

○Panpot (Controller number 10)

Status	2nd byte	3rd byte
BnH	0AH	vvH
n = MIDI channel number:	0H - FH (ch.1 - 16)	
vv = Panpot:	00H - 40H - 7FH (Left - Center - Right),	

* Not received in Performance mode when the Receive Pan parameter (Performance MIDI) is OFF.

* In Performance mode the Part Pan parameter (Performance Part) will change.

○Expression (Controller number 11)

Status	2nd byte	3rd byte
BnH	0BH	vvH
n = MIDI channel number:	0H - FH (ch.1 - 16)	
vv = Expression:	00H - 7FH (0 - 127)	

* Not received when Tone Receive Expression parameter (Patch Tone or Rhythm Tone) is OFF.

* Not received in Performance mode when Receive Expression parameter (Performance MIDI) is OFF.

○Hold 1 (Controller number 64)

<u>Status</u>	<u>2nd byte</u>	<u>3rd byte</u>
BnH	40H	vvH
n = MIDI channel number:	0H - FH (ch.1 - 16)	
vv = Control value:	00H - 7FH (0 - 127) 0-63 = OFF, 64-127 = ON	

- * Not received when Tone Receive Hold-1 parameter (Patch Tone or Rhythm Tone) is OFF.
- * Not received in Performance mode when Receive Hold-1 parameter (Performance MIDI) is OFF.

○Portamento (Controller number 65)

<u>Status</u>	<u>2nd byte</u>	<u>3rd byte</u>
BnH	41H	vvH
n = MIDI channel number:	0H - FH (ch.1 - 16)	
vv = Control value:	00H - 7FH (0 - 127) 0 - 63 = OFF, 64 - 127 = ON	

- * In Performance mode the Part Portamento Switch parameter (Performance Part) will change.

○Sostenuto (Controller number 66)

<u>Status</u>	<u>2nd byte</u>	<u>3rd byte</u>
BnH	42H	vvH
n = MIDI channel number:	0H - FH (ch.1 - 16)	
vv = Control value:	00H - 7FH (0 - 127) 0 - 63 = OFF, 64 - 127 = ON	

○Soft (Controller number 67)

<u>Status</u>	<u>2nd byte</u>	<u>3rd byte</u>
BnH	43H	vvH
n = MIDI channel number:	0H - FH (ch.1 - 16)	
vv = Control value:	00H - 7FH (0 - 127) 0 - 63 = OFF, 64 - 127 = ON	

○Legato Foot Switch (Controller number 68)

<u>Status</u>	<u>2nd byte</u>	<u>3rd byte</u>
BnH	44H	vvH
n = MIDI channel number:	0H - FH (ch.1 - 16)	
vv = Control value:	00H - 7FH (0 - 127) 0 - 63 = OFF, 64 - 127 = ON	

- * In Performance mode the Part Legato Switch parameter (Performance Part) will change.

○Hold-2 (Controller number 69)

<u>Status</u>	<u>2nd byte</u>	<u>3rd byte</u>
BnH	45H	vvH
n = MIDI channel number:	0H - FH (ch.1 - 16)	
vv = Control value:	00H - 7FH (0 - 127)	

- * A hold movement isn't done.

○Resonance (Controller number 71)

<u>Status</u>	<u>2nd byte</u>	<u>3rd byte</u>
BnH	47H	vvH
n = MIDI channel number:	0H - FH (ch.1 - 16)	
vv = Resonance value (relative change):	00H - 40H - 7FH (-64 - 0 - +63),	

- * In Performance mode the Part Resonance Offset parameter (Performance Part) will change.

○Release Time (Controller number 72)

<u>Status</u>	<u>2nd byte</u>	<u>3rd byte</u>
BnH	48H	vvH
n = MIDI channel number:	0H - FH (ch.1 - 16)	
vv = Release Time value (relative change):	00H - 40H - 7FH (-64 - 0 - +63),	

- * In Performance mode the Part Release Time Offset parameter (Performance Part) will change.

○Attack time (Controller number 73)

<u>Status</u>	<u>2nd byte</u>	<u>3rd byte</u>
BnH	49H	vvH
n = MIDI channel number:	0H - FH (ch.1 - 16)	
vv = Attack time value (relative change):	00H - 40H - 7FH (-64 - 0 - +63),	

- * In Performance mode the Part Attack Time Offset parameter (Performance Part) will change.

○Cutoff (Controller number 74)

<u>Status</u>	<u>2nd byte</u>	<u>3rd byte</u>
BnH	4AH	vvH
n = MIDI channel number:	0H - FH (ch.1 - 16)	
vv = Cutoff value (relative change):	00H - 40H - 7FH (-64 - 0 - +63)	

- * In Performance mode the Part Cutoff Offset parameter (Performance Part) will change.

○Decay Time (Controller number 75)

<u>Status</u>	<u>2nd byte</u>	<u>3rd byte</u>
BnH	4BH	vvH
n = MIDI channel number:	0H - FH (ch.1 - 16)	
vv = Decay Time value (relative change):	00H - 40H - 7FH (-64 - 0 - +63)	

- * In Performance mode the Part Decay Time Offset parameter (Performance Part) will change.

○Vibrato Rate (Controller number 76)

<u>Status</u>	<u>2nd byte</u>	<u>3rd byte</u>
BnH	4CH	vvH
n = MIDI channel number:	0H - FH (ch.1 - 16)	
vv = Vibrato Rate value (relative change):	00H - 40H - 7FH (-64 - 0 - +63)	

- * In Performance mode the Part Vibrato Rate parameter (Performance Part) will change.

○Vibrato Depth (Controller number 77)

<u>Status</u>	<u>2nd byte</u>	<u>3rd byte</u>
BnH	4DH	vvH
n = MIDI channel number:	0H - FH (ch.1 - 16)	
vv = Vibrato Depth Value (relative change):	00H - 40H - 7FH (-64 - 0 - +63)	

- * In Performance mode the Part Vibrato Depth parameter (Performance Part) will change.

○Vibrato Delay (Controller number 78)

<u>Status</u>	<u>2nd byte</u>	<u>3rd byte</u>
BnH	4EH	vvH
n = MIDI channel number:	0H - FH (ch.1 - 16)	
vv = Vibrato Delay value (relative change):	00H - 40H - 7FH (-64 - 0 - +63)	

- * In Performance mode the Part Vibrato Delay parameter (Performance Part) will change.

○General Purpose Controller 5 (Controller number 80)

<u>Status</u>	<u>2nd byte</u>	<u>3rd byte</u>
BnH	50H	vvH
n = MIDI channel number:	0H - FH (ch.1 - 16)	
vv = Control value:	00H - 7FH (0 - 127)	

- * The Tone Level parameter (Patch Tone) of Tone 1 will change.

○General Purpose Controller 6 (Controller number 81)

<u>Status</u>	<u>2nd byte</u>	<u>3rd byte</u>
BnH	51H	vvH
n = MIDI channel number:	0H - FH (ch.1 - 16)	
vv = Control value:	00H - 7FH (0 - 127)	

- * The Tone Level parameter (Patch Tone) of Tone 2 will change.

○General Purpose Controller 7 (Controller number 82)

<u>Status</u>	<u>2nd byte</u>	<u>3rd byte</u>
BnH	52H	vvH
n = MIDI channel number:	0H - FH (ch.1 - 16)	
vv = Control value:	00H - 7FH (0 - 127)	

- * The Tone Level parameter (Patch Tone) of Tone 3 will change.

○General Purpose Controller 8 (Controller number 83)

<u>Status</u>	<u>2nd byte</u>	<u>3rd byte</u>
BnH	53H	vvH
n = MIDI channel number:	0H - FH (ch.1 - 16)	
vv = Control value:	00H - 7FH (0 - 127)	

- * The Tone Level parameter (Patch Tone) of Tone 4 will change.

MIDI Implementation

○Portamento control (Controller number 84)

Status	2nd byte	3rd byte
BnH	54H	kkH
n = MIDI channel number:		0H - FH (ch.1 - 16)
kk = source note number:		00H - 7FH (0 - 127)

- * A Note-on received immediately after a Portamento Control message will change continuously in pitch, starting from the pitch of the Source Note Number.
- * If a voice is already sounding for a note number identical to the Source Note Number, this voice will continue sounding (i.e., legato) and will, when the next Note-on is received, smoothly change to the pitch of that Note-on.
- * The rate of the pitch change caused by Portamento Control is determined by the Portamento Time value.

○Effect 1 (Reverb Send Level) (Controller number 91)

Status	2nd byte	3rd byte
BnH	5BH	vvH
n = MIDI channel number:		0H - FH (ch.1 - 16)
vv = Reverb Send Level:		00H - 7FH (0 - 127)

- * In Performance mode the Part Reverb Send Level parameter (Performance Part) will change.

○Effect 3 (Chorus Send Level) (Controller number 93)

Status	2nd byte	3rd byte
BnH	5DH	vvH
n = MIDI channel number:		0H - FH (ch.1 - 16)
vv = Chorus Send Level:		00H - 7FH (0 - 127)

- * In Performance mode the Part Chorus Send Level parameter (Performance Part) will change.

○RPN MSB/LSB (Controller number 100, 101)

Status	2nd byte	3rd byte
BnH	65H	mmH
BnH	64H	llH
n = MIDI channel number:		0H - FH (ch.1 - 16)
mm = upper byte (MSB) of parameter number specified by RPN		
ll = lower byte (LSB) of parameter number specified by RPN		

<<< RPN >>>

Control Changes include RPN (Registered Parameter Numbers), which are extended. When using RPNs, first RPN (Controller numbers 100 and 101; they can be sent in any order) should be sent in order to select the parameter, then

Data Entry (Controller numbers 6 and 38) should be sent to set the value. Once RPN messages are received, Data Entry messages that is received at the same MIDI channel after that are recognized as changing toward the value of the RPN messages. In order not to make any mistakes, transmitting RPN Null is recommended after setting parameters you need.

This device receives the following RPNs.

RPN	Data entry	Notes
MSB, LSB	MSB, LSB	Notes
00H, 00H	mmH, llH	Pitch Bend Sensitivity
		mm: 00H - 18H (0 - 24 semitones)
		ll: ignored (processed as 00H)
		Up to 2 octave can be specified in semitone steps.

- * In Performance mode, the Part Bend Range parameter (Performance Part) will change.

RPN	Data entry	Notes
00H, 01H	mmH, llH	Channel Fine Tuning
		mm, ll: 20 00H - 40 00H - 60 00H
		(-4096 x 100 / 8192 - 0 - +4096 x 100 / 8192 cent)

- * In Performance mode, the Part Fine Tune parameter (Performance Part) will change.

RPN	Data entry	Notes
00H, 02H	mmH, llH	Channel Coarse Tuning
		mm: 10H - 40H - 70H (-48 - 0 - +48 semitones)
		ll: ignored (processed as 00H)

- * In Performance mode, the Part Coarse Tune parameter (Performance Part) will change.

RPN	Data entry	Notes
00H, 05H	mmH, llH	Modulation Depth Range
		mm: 00 00H - 06 00H
		(0 - 16384 x 600 / 16384 cent)

- * Not received in Patch mode.

7FH, 7FH	---, ---	RPN null
		RPN and NRPN will be set as "unspecified."
		Once this setting has been made, subsequent
		Parameter values that were previously set will
		not change.
		mm, ll: ignored

●Program Change

Status	2nd byte	Notes
CnH	ppH	
n = MIDI channel number:		0H - FH (ch.1 - 16)
pp = Program number:		00H - 7FH (prog.1 - prog.128)

- * Not received in Performance mode when the Receive Program Change parameter (Performance MIDI) is OFF.

●Channel Pressure

Status	2nd byte	Notes
DnH	vvH	
n = MIDI channel number:		0H - FH (ch.1 - 16)
vv = Channel Pressure:		00H - 7FH (0 - 127)

- * Not received in Performance mode when the Receive Channel Pressure parameter (Performance MIDI) is OFF.

●Pitch Bend Change

Status	2nd byte	3rd byte	Notes
EnH	llH	mmH	
n = MIDI channel number:			0H - FH (ch.1 - 16)
mm, ll = Pitch Bend value:			00 00H - 40 00H - 7F 7FH (-8192 - 0 - +8191)

- * Not received when the Tone Receive Bender parameter (Patch Tone) is OFF.

- * Not received in Performance mode when the Receive Pitch Bend parameter (Performance MIDI) is OFF.

■ Channel Mode Messages

* Not received in Performance mode when the Receive Switch parameter (Performance Part) is OFF.

● All Sounds Off (Controller number 120)

<u>Status</u>	<u>2nd byte</u>	<u>3rd byte</u>
BnH	78H	00H

n = MIDI channel number: 0H - FH (ch.1 - 16)

* When this message is received, all notes currently sounding on the corresponding channel will be turned off.

● Reset All Controllers (Controller number 121)

<u>Status</u>	<u>2nd byte</u>	<u>3rd byte</u>
BnH	79H	00H

n = MIDI channel number: 0H - FH (ch.1 - 16)

* When this message is received, the following controllers will be set to their reset values.

<u>Controller</u>	<u>Reset value</u>	
Pitch Bend Change	+/-0 (center)	
Polyphonic Key Pressure	0 (off)	
Channel Pressure	0 (off)	
Modulation	0 (off)	
Breath Type	0 (min)	
Expression	127 (max)	However the controller will be at minimum.
Hold 1	0 (off)	
Sostenuto	0 (off)	
Soft	0 (off)	
Hold 2	0 (off)	
RPN	unset; previously set data will not change	
NRPN	unset; previously set data will not change	

● All Notes Off (Controller number 123)

<u>Status</u>	<u>2nd byte</u>	<u>3rd byte</u>
BnH	7BH	00H

n = MIDI channel number: 0H - FH (ch.1 - 16)

* When All Notes Off is received, all notes on the corresponding channel will be turned off. However, if Hold 1 or Sostenuto is ON, the sound will be continued until these are turned off.

● OMNI OFF (Controller number 124)

<u>Status</u>	<u>2nd byte</u>	<u>3rd byte</u>
BnH	7CH	00H

n = MIDI channel number: 0H - FH (ch.1 - 16)

* The same processing will be carried out as when All Notes Off is received.

● OMNI ON (Controller number 125)

<u>Status</u>	<u>2nd byte</u>	<u>3rd byte</u>
BnH	7DH	00H

n = MIDI channel number: 0H - FH (ch.1 - 16)

* The same processing will be carried out as when All Notes Off is received. OMNI ON will not be turned on.

● MONO (Controller number 126)

<u>Status</u>	<u>2nd byte</u>	<u>3rd byte</u>
BnH	7EH	mmH

n = MIDI channel number: 0H - FH (ch.1 - 16)

mm = mono number: 00H - 10H (0 - 16)

* The same processing will be carried out as when All Notes Off is received.

* In Performance mode, the Part Mono/Poly parameter (Performance Part) will change.

● POLY (Controller number 127)

<u>Status</u>	<u>2nd byte</u>	<u>3rd byte</u>
BnH	7FH	00H

n = MIDI channel number: 0H - FH (ch.1 - 16)

* The same processing will be carried out as when All Notes Off is received.

* In Performance mode, the Part Mono/Poly parameter (Performance Part) will change.

MIDI Implementation

■ System Realtime Message

● Timing Clock

Status
F8H

● Active Sensing

Status
FEH

* When Active Sensing is received, the unit will begin monitoring the intervals of all further messages. While monitoring, if the interval between messages exceeds 420 ms, the same processing will be carried out as when All Sounds Off, All Notes Off and Reset All Controllers are received, and message interval monitoring will be halted.

■ System Exclusive Message

<u>Status</u>	<u>Data byte</u>	<u>Status</u>
F0H	iiH, ddH,eeH	F7H

F0H: System Exclusive Message status
 ii = ID number: an ID number (manufacturer ID) to indicate the manufacturer whose Exclusive message this is. Roland's manufacturer ID is 41H.
 ID numbers 7EH and 7FH are extensions of the MIDI standard; Universal Non-realtime Messages (7EH) and Universal Realtime Messages (7FH).
 dd,....,ee = data: 00H - 7FH (0 - 127)
 F7H: EOX (End Of Exclusive)

Of the System Exclusive messages received by this device, the Universal Non-realtime messages and the Universal Realtime messages and the Data Request (RQ1) messages and the Data Set (DT1) messages will be set automatically.

● Universal Non-realtime System Exclusive Messages

○ Identity Request Message

<u>Status</u>	<u>Data byte</u>	<u>Status</u>
F0H	7EH, dev, 06H, 01H	F7H

<u>Byte</u>	<u>Explanation</u>
F0H	Exclusive status
7EH	ID number (Universal Non-realtime Message)
dev	Device ID (dev: 10H - 1FH, 7FH)
06H	Sub ID#1 (General Information)
01H	Sub ID#2 (Identity Request)
F7H	EOX (End Of Exclusive)

* When this message is received, Identity Reply message (p. 146) will be transmitted.

○ GM1 System On

<u>Status</u>	<u>Data byte</u>	<u>Status</u>
F0H	7EH, 7FH, 09H, 01H	F7H

<u>Byte</u>	<u>Explanation</u>
F0H	Exclusive status
7EH	ID number (Universal Non-realtime Message)
7FH	Device ID (Broadcast)
09H	Sub ID#1 (General MIDI Message)
01H	Sub ID#2 (General MIDI 1 On)
F7H	EOX (End Of Exclusive)

* When this messages is received, this instrument will turn to the GM mode.

○ GM2 System On

<u>Status</u>	<u>Data byte</u>	<u>Status</u>
F0H	7EH 7FH 09H 03H	F7H

<u>Byte</u>	<u>Explanation</u>
F0H	Exclusive status
7EH	ID number (Universal Non-realtime Message)
7FH	Device ID (Broadcast)
09H	Sub ID#1 (General MIDI Message)
03H	Sub ID#2 (General MIDI 2 On)
F7H	EOX (End Of Exclusive)

* When this messages is received, this instrument will turn to the GM mode.

○ GM System Off

<u>Status</u>	<u>Data byte</u>	<u>Status</u>
F0H	7EH, 7F, 09H, 02H	F7H

<u>Byte</u>	<u>Explanation</u>
F0H	Exclusive status
7EH	ID number (Universal Non-realtime Message)
7FH	Device ID (Broadcast)
09H	Sub ID#1 (General MIDI Message)
02H	Sub ID#2 (General MIDI Off)
F7H	EOX (End Of Exclusive)

* When this messages is received, this instrument will return to the Performance mode.

●Universal Realtime System Exclusive Messages

○Master Volume

<u>Status</u>	<u>Data byte</u>	<u>Status</u>
F0H	7FH, 7FH, 04H, 01H, 11H, mmH	F7H

<u>Byte</u>	<u>Explanation</u>
F0H	Exclusive status
7FH	ID number (universal realtime message)
7FH	Device ID (Broadcast)
04H	Sub ID#1 (Device Control)
01H	Sub ID#2 (Master Volume)
11H	Master Volume lower byte
mmH	Master Volume upper byte
F7H	EOX (End Of Exclusive)

- * The lower byte (11H) of Master Volume will be handled as 00H.
- * The Master Level parameter (System Common) will change.

○Master Fine Tuning

<u>Status</u>	<u>Data byte</u>	<u>Status</u>
F0H	7FH, 7FH, 04H, 03H, 11H, mmH	F7H

<u>Byte</u>	<u>Explanation</u>
F0H	Exclusive status
7FH	ID number (universal realtime message)
7FH	Device ID (Broadcast)
04H	Sub ID#1 (Device Control)
03H	Sub ID#2 (Master Fine Tuning)
11H	Master Fine Tuning LSB
mmH	Master Fine Tuning MSB
F7H	EOX (End Of Exclusive)

mm, 11: 00 00H - 40 00H - 7F 7FH (-100 - 0 - +99.9 [cents])

- * The Master Tune parameter (System Common) will change.

○Master Coarse Tuning

<u>Status</u>	<u>Data byte</u>	<u>Status</u>
F0H	7FH, 7FH, 04H, 04H, 11H, mmH	F7

<u>Byte</u>	<u>Explanation</u>
F0H	Exclusive status
7FH	ID number (universal realtime message)
7FH	Device ID (Broadcast)
04H	Sub ID#1 (Device Control)
04H	Sub ID#2 (Master Coarse Tuning)
11H	Master Coarse Tuning LSB
mmH	Master Coarse Tuning MSB
F7H	EOX (End Of Exclusive)

11H: ignored (processed as 00H)
 mmH: 28H - 40H - 58H (-24 - 0 - +24 [semitones])

- * The Master Key Shift parameter (System Common) will change.

●Global Parameter Control

- * Not received in Patch mode.

○Reverb Parameters

<u>Status</u>	<u>Data byte</u>	<u>Status</u>
F0H	7FH, 7FH, 04H, 05H, 01H, 01H, 01H, 01H, ppH, vvH	F7H

<u>Byte</u>	<u>Explanation</u>
F0H	Exclusive status
7FH	ID number (universal realtime message)
7FH	Device ID (Broadcast)
04H	Sub ID#1 (Device Control)
05H	Sub ID#2 (Global Parameter Control)
01H	Slot path length
01H	Parameter ID width
01H	Value width
01H	Slot path MSB
01H	Slot path LSB (Effect 0101: Reverb)
ppH	Parameter to be controlled.
vvH	Value for the parameter.
	pp=0 Reverb Type
	vv = 00H Small Room
	vv = 01H Medium Room
	vv = 02H Large Room
	vv = 03H Medium Hall
	vv = 04H Large Hall
	vv = 08H Plate
	pp=1 Reverb Time
	vv = 00H - 7FH 0 - 127
F7H	EOX (End Of Exclusive)

MIDI Implementation

○Chorus Parameters

Status	Data byte	Status
F0H	7FH, 7FH, 04H, 05H, 01H, 01H, 01H, 01H, 02H, ppH, vvH	F7H

Byte	Explanation
F0H	Exclusive status
7FH	ID number (universal realtime message)
7FH	Device ID (Broadcast)
04H	Sub ID#1 (Device Control)
05H	Sub ID#2 (Global Parameter Control)
01H	Slot path length
01H	Parameter ID width
01H	Value width
01H	Slot path MSB
02H	Slot path LSB (Effect 0102: Chorus)
ppH	Parameter to be controlled.
vvH	Value for the parameter.
	pp=0 Chorus Type
	vv=0 Chorus1
	vv=1 Chorus2
	vv=2 Chorus3
	vv=3 Chorus4
	vv=4 FB Chorus
	vv=5 Flanger
	pp=1 Mod Rate
	vv= 00H - 7FH 0 - 127
	pp=2 Mod Depth
	vv = 00H - 7FH 0 - 127
	pp=3 Feedback
	vv = 00H - 7FH 0 - 127
	pp=4 Send To Reverb
	vv = 00H - 7FH 0 - 127
F7H	EOX (End Of Exclusive)

○Channel Pressure

Status	Data byte	Status
F0H	7FH, 7FH, 09H, 01H, 0nH, ppH, rrH	F7H

Byte	Explanation
F0H	Exclusive status
7FH	ID number (universal realtime message)
7FH	Device ID (Broadcast)
09H	Sub ID#1 (Controller Destination Setting)
01H	Sub ID#2 (Channel Pressure)
0nH	MIDI Channel (00 - 0F)
ppH	Controlled parameter
rrH	Controlled range
	pp=0 Pitch Control
	rr = 28H - 58H -24 - +24 [semitones]
	pp=1 Filter Cutoff Control
	rr = 00H - 7FH -9600 - +9450 [cents]
	pp=2 Amplitude Control
	rr = 00H - 7FH 0 - 200%
	pp=3 LFO Pitch Depth
	rr = 00H - 7FH 0 - 600 [cents]
	pp=4 LFO Filter Depth
	rr = 00H - 7FH 0 - 2400 [cents]
	pp=5 LFO Amplitude Depth
	rr = 00H - 7FH 0 - 100%
F7H	EOX (End Of Exclusive)

○Controller

Status	Data byte	Status
F0H	7FH, 7FH, 09H, 03H, 0nH, ccH, ppH, rrH	F7H

Byte	Explanation
F0H	Exclusive status
7FH	ID number (universal realtime message)
7FH	Device ID (Broadcast)
09H	Sub ID#1 (Controller Destination Setting)
03H	Sub ID#2 (Control Change)
0nH	MIDI Channel (00 - 0F)
ccH	Controller number (01 - 1F, 40 - 5F)
ppH	Controlled parameter
rrH	Controlled range

	pp=0 Pitch Control
	rr = 28H - 58H -24 - +24 [semitones]
	pp=1 Filter Cutoff Control
	rr = 00H - 7FH -9600 - +9450 [cents]
	pp=2 Amplitude Control
	rr = 00H - 7FH 0 - 200%
	pp=3 LFO Pitch Depth
	rr = 00H - 7FH 0 - 600 [cents]
	pp=4 LFO Filter Depth
	rr = 00H - 7FH 0 - 2400 [cents]
	pp=5 LFO Amplitude Depth
	rr = 00H - 7FH 0 - 100%
F7H	EOX (End Of Exclusive)

○Scale/Octave Tuning Adjust

Status	Data byte	Status
F0H	7EH, 7FH, 08H, 08H, fhH, ggH, hhH, ssH...	F7

Byte	Explanation
F0H	Exclusive status
7EH	ID number (Universal Non-realtime Message)
7FH	Device ID (Broadcast)
08H	Sub ID#1 (MIDI Tuning Standard)
08H	Sub ID#2 (scale/octave tuning 1-byte form)
fhH	Channel/Option byte 1
	bits 0 to 1 = channel 15 to 16
	bit 2 to 6 = Undefined
ggH	Channel byte 2
	bits 0 to 6 = channel 8 to 14
hhH	Channel byte 3
	bits 0 to 6 = channel 1 to 7
ssH	12 byte tuning offset of 12 semitones from C to B
	00H = -64 [cents]
	40H = 0 [cents] (equal temperament)
	7FH = +63 [cents]
F7H	EOX (End Of Exclusive)

○Key-based Instrument Controllers

Status	Data byte	Status
F0H	7FH, 7FH, 0AH, 01H, 0nH, kkH, nnH, vvH	F7H

Byte	Explanation
F0H	Exclusive status
7FH	ID number (universal realtime message)
7FH	Device ID (Broadcast)
0AH	Sub ID#1 (Key-Based Instrument Control)
01H	Sub ID#2 (Controller)
0nH	MIDI Channel (00 - 0FH)
kkH	Key Number
nnH	Control Number
vvH	Value
	nn=07H Level
	vv = 00H - 7FH 0 - 200% (Relative)
	nn=0AH Pan
	vv = 00H - 7FH Left - Right (Absolute)
	nn=5BH Reverb Send
	vv = 00H - 7FH 0 - 127 (Absolute)
	nn=5D Chorus Send
	vv = 00H - 7FH 0 - 127 (Absolute)
:	:
F7	EOX (End Of Exclusive)

* This parameter affects drum instruments only.

●Data Transmission

This instrument can use exclusive messages to exchange many varieties of internal settings with other devices.

The model ID of the exclusive messages used by this instrument is 00H 10H.

○Data Request 1RQ1 (11H)

This message requests the other device to transmit data. The address and size indicate the type and amount of data that is requested.

When a Data Request message is received, if the device is in a state in which it is able to transmit data, and if the address and size are appropriate, the requested data is transmitted as a Data Set 1 (DT1) message. If the conditions are not met, nothing is transmitted.

<u>Status</u>	<u>data byte</u>	<u>status</u>
F0H	41H, dev, 00H, 10H, 11H, aaH, bbH, ccH, F7H	
	ddH, ssH, ttH, uuH, vvH, sum	

<u>Byte</u>	<u>Remarks</u>
F0H	Exclusive status
41H	ID number (Roland)
dev	device ID (dev: 10H - 1FH, 7FH)
00H	model ID #1 (XV-2020)
10H	model ID #2 (XV-2020)
11H	command ID (RQ1)
aaH	address MSB
bbH	address
ccH	address
ddH	address LSB
ssH	size MSB
ttH	size
uuH	size
vvH	size LSB
sum	checksum
F7H	EOX (End Of Exclusive)

* The size of data that can be transmitted at one time is fixed for each type of data. And data requests must be made with a fixed starting address and size. Refer to the address and size given in "Parameter Address Map" (p. 146).

* For the checksum, refer to (p. 159).

○Data set 1 DT1 (12H)

<u>Status</u>	<u>Data byte</u>	<u>Status</u>
F0H	41H, dev, 00H, 10H, 12H, aaH, bbH,	F7H
	ccH, ddH, eeH, ... ffH, sum	

<u>Byte</u>	<u>Explanation</u>
F0H	Exclusive status
41H	ID number (Roland)
dev	Device ID (dev: 00H - 1FH, 7FH)
00H	Model ID #1 (XV-2020)
10H	Model ID #2 (XV-2020)
12H	Command ID (DT1)
aaH	Address MSB: upper byte of the starting address of the data to be sent
bbH	Address: upper middle byte of the starting address of the data to be sent
ccH	Address: lower middle byte of the starting address of the data to be sent
ddH	Address LSB: lower byte of the starting address of the data to be sent.
eeH	Data: the actual data to be sent. Multiple bytes of data are transmitted in order starting from the address.
:	:
ffH	Data
sum	Checksum
F7H	EOX (End Of Exclusive)

* The amount of data that can be transmitted at one time depends on the type of data, and data will be transmitted from the specified starting address and size. Refer to the address and size given in "Parameter Address Map" (p. 146).

* Data larger than 256 bytes will be divided into packets of 256 bytes or less, and each packet will be sent at an interval of about 20 ms.

* Regarding the checksum, please refer to (p. 159)

2. Data Transmission

■ Channel Voice Messages

When execute the Data Transfer, following Control Changes and Program Change will transmit.

● Control Change

○ Bank Select (Controller number 0, 32)

Status	2nd byte	3rd byte
BnH	00H	mmH
BnH	20H	llH

n = MIDI channel number: 0H - FH (ch.1 - 16)
 mm, ll = Bank number: 00 00H - 7F 7FH (bank.1 - bank.16384)

○ Portamento Time (Controller number 5)

Status	2nd byte	3rd byte
BnH	05H	vvH

n = MIDI channel number: 0H - FH (ch.1 - 16)
 vv = Portamento Time: 00H - 7FH (0 - 127)

○ Data Entry (Controller number 6, 38)

Status	2nd byte	3rd byte
BnH	06H	mmH
BnH	26H	llH

n = MIDI channel number: 0H - FH (ch.1 - 16)
 mm, ll = the value of the parameter specified by RPN/NRPN
 mm = MSB, ll = LSB

○ Volume (Controller number 7)

Status	2nd byte	3rd byte
BnH	07H	vvH

n = MIDI channel number: 0H - FH (ch.1 - 16)
 vv = Volume: 00H - 7FH (0 - 127)

○ Panpot (Controller number 10)

Status	2nd byte	3rd byte
BnH	0AH	vvH

n = MIDI channel number: 0H - FH (ch.1 - 16)
 vv = Panpot: 00H - 40H - 7FH (Left - Center - Right).

○ Portamento (Controller number 65)

Status	2nd byte	3rd byte
BnH	41H	vvH

n = MIDI channel number: 0H - FH (ch.1 - 16)
 vv = Control value: 00H - 7FH (0 - 127) 0 - 63 = OFF, 64 - 127 = ON

○ Resonance (Controller number 71)

Status	2nd byte	3rd byte
BnH	47H	vvH

n = MIDI channel number: 0H - FH (ch.1 - 16)
 vv = Resonance value (relative change): 00H - 40H - 7FH (-64 - 0 - +63)

○ Release Time (Controller number 72)

Status	2nd byte	3rd byte
BnH	48H	vvH

n = MIDI channel number: 0H - FH (ch.1 - 16)
 vv = Release Time value (relative change): 00H - 40H - 7FH (-64 - 0 - +63)

○ Attack time (Controller number 73)

Status	2nd byte	3rd byte
BnH	49H	vvH

n = MIDI channel number: 0H - FH (ch.1 - 16)
 vv = Attack time value (relative change): 00H - 40H - 7FH (-64 - 0 - +63)

○ Cutoff (Controller number 74)

Status	2nd byte	3rd byte
BnH	4AH	vvH

n = MIDI channel number: 0H - FH (ch.1 - 16)
 vv = Cutoff value (relative change): 00H - 40H - 7FH (-64 - 0 - +63)

○ Decay Time (Controller number 75)

Status	2nd byte	3rd byte
BnH	4BH	vvH

n = MIDI channel number: 0H - FH (ch.1 - 16)
 vv = Decay Time value (relative change): 00H - 40H - 7FH (-64 - 0 - +63)

○Vibrato Rate (Controller number 76)

<u>Status</u>	<u>2nd byte</u>	<u>3rd byte</u>
BnH	4CH	vvH
n = MIDI channel number:	0H - FH (ch.1 - 16)	
vv = Vibrato Rate value (relative change):	00H - 40H - 7FH (-64 - 0 - +63)	

○Vibrato Depth (Controller number 77)

<u>Status</u>	<u>2nd byte</u>	<u>3rd byte</u>
BnH	4DH	vvH
n = MIDI channel number:	0H - FH (ch.1 - 16)	
vv = Vibrato Depth value (relative change):	00H - 40H - 7FH (-64 - 0 - +63)	

○Vibrato Delay (Controller number 78)

<u>Status</u>	<u>2nd byte</u>	<u>3rd byte</u>
BnH	4EH	vvH
n = MIDI channel number:	0H - FH (ch.1 - 16)	
vv = Vibrato Delay value (relative change):	00H - 40H - 7FH (-64 - 0 - +63)	

○Effect 1 (Reverb Send Level) (Controller number 91)

<u>Status</u>	<u>2nd byte</u>	<u>3rd byte</u>
BnH	5BH	vvH
n = MIDI channel number:	0H - FH (ch.1 - 16)	
vv = Reverb Send Level:	00H - 7FH (0 - 127)	

○Effect 3 (Chorus Send Level) (Controller number 93)

<u>Status</u>	<u>2nd byte</u>	<u>3rd byte</u>
BnH	5DH	vvH
n = MIDI channel number:	0H - FH (ch.1 - 16)	
vv = Chorus Send Level:	00H - 7FH (0 - 127)	

○RPN MSB/LSB (Controller number 100, 101)

<u>Status</u>	<u>2nd byte</u>	<u>3rd byte</u>
BnH	65H	mmH
BnH	64H	llH
n = MIDI channel number:	0H - FH (ch.1 - 16)	
mm = upper byte (MSB) of parameter number specified by RPN		
ll = lower byte (LSB) of parameter number specified by RPN		

<<< RPN >>>

Control Changes include RPN (Registered Parameter Numbers), which are extended. When using RPNs, first RPN (Controller numbers 100 and 101; they can be sent in any order) should be sent in order to select the parameter, then

Data Entry (Controller numbers 6 and 38) should be sent to set the value. Once RPN messages are received, Data Entry messages that is received at the same MIDI channel after that are recognized as changing toward the value of the RPN messages. In order not to make any mistakes, transmitting RPN Null is recommended after setting parameters you need.

This device transmits the following RPNs.

RPN	Data entry	Notes
MSB, LSB	MSB, LSB	
00H, 00H	mmH, llH	Pitch Bend Sensitivity mm: 00H - 18H (0 - 24 semitones) ll: ignored (processed as 00H)
00H, 01H	mmH, llH	Channel Fine Tuning mm, ll: 20 00H - 40 00H - 60 00H (-4096 x 100 / 8192 - 0 - +4096 x 100 / 8192 cent)
00H, 02H	mmH, llH	Channel Coarse Tuning mm: 10H - 40H - 70H (-48 - 0 - +48 semitones) ll: ignored (processed as 00H)
00H, 05H	mmH, llH	Modulation Depth Range mm, ll: 00 00H - 06 00H (0 - 16384 x 600 / 16384 cent)
7FH, 7FH	---, ---	RPN null RPN and NRPN will be set as "unspecified." Once this setting has been made, subsequent

●Program Change

<u>Status</u>	<u>2nd byte</u>
CnH	ppH
n = MIDI channel number:	0H - FH (ch.1 - 16)
pp = Program number:	00H - 7FH (prog.1 - prog.128)

MIDI Implementation

System Exclusive Messages

Universal Non-realtime System Exclusive Message and Data Set 1 (DT1) are the only System Exclusive messages transmitted by the XV-2020.

Universal Non-realtime System Exclusive Message

Identity Reply Message

Receiving Identity Request Message, the XV-2020 send this message.

Status	Data byte	Status
F0H	7EH, dev, 06H, 02H, 41H, 10H, 01H, 00H, 03H, 00H, 00H, 00H, 00H	F7H

Byte	Explanation
F0H	Exclusive status
7EH	ID number (Universal Non-realtime Message)
dev	Device ID (dev: 10H - 1FH)
06H	Sub ID#1 (General Information)
02H	Sub ID#2 (Identity Reply)
41H	ID number (Roland)
10H 01H	Device family code
00H 03H	Device family number code
00H 00H 00H 00H	Software revision level
F7H	EOX (End of Exclusive)

Data Transmission

Data set 1 DT1 (12H)

Status	Data byte	Status
F0H	41H, dev, 00H, 10H, 12H, aaH, bbH, ccH, ddH, eeH, ... ffH, sum	F7H

Byte	Explanation
F0H	Exclusive status
41H	ID number (Roland)
dev	Device ID (dev: 00H - 1FH, 7FH)
00H	Model ID #1 (XV-2020)
10H	Model ID #2 (XV-2020)
12H	Command ID (DT1)
aaH	Address MSB: upper byte of the starting address of the data to be sent
bbH	Address: upper middle byte of the starting address of the data to be sent
ccH	Address: lower middle byte of the starting address of the data to be sent
ddH	Address LSB: lower byte of the starting address of the data to be sent.
eeH	Data: the actual data to be sent. Multiple bytes of data are transmitted in order starting from the address.
:	:
ffH	Data
sum	Checksum
F7H	EOX (End Of Exclusive)

* The amount of data that can be transmitted at one time depends on the type of data, and data will be transmitted from the specified starting address and size. Refer to the address and size given in "Parameter Address Map" (p. 146).

* Data larger than 256 bytes will be divided into packets of 256 bytes or less, and each packet will be sent at an interval of about 20 ms.

3. Parameter Address Map

- * Transmission of "*" marked address is divided to some packets. For example, ABH in hexadecimal notation will be divided to 0AH and 0BH, and is sent/received in this order.
- * "<*>" marked address or parameters are ignored when the XV-2020 received them.

1. XV-2020 (ModelID = 00H 10H)

Start Address	Description	
01 00 00 00	Setup	*1-1
02 00 00 00	System	*1-2
10 00 00 00	Temporary Performance	*1-3
11 00 00 00	Temporary Patch/Rhythm (Performance Mode Part 1)	*1-4
11 20 00 00	Temporary Patch/Rhythm (Performance Mode Part 2)	
:	:	
14 60 00 00	Temporary Patch/Rhythm (Performance Mode Part 16)	
1F 00 00 00	Temporary Patch/Rhythm (Patch Mode)	
20 00 00 00	User Performance (01)	*1-3
20 01 00 00	User Performance (02)	
:	:	
20 3F 00 00	User Performance (64)	
30 00 00 00	User Patch (001)	*1-4-1
30 01 00 00	User Patch (002)	
:	:	
30 7F 00 00	User Patch (128)	
40 00 00 00	User Rhythm (001)	*1-4-2
40 10 00 00	User Rhythm (002)	
:	:	
40 30 00 00	User Rhythm (004)	

01-2 System

Offset Address	Description	
00 00 00	System Common	*1-2-1

01-4 Temporary Patch/Rhythm

Offset Address	Description	
00 00 00	Temporary Patch	*1-4-1
10 00 00	Temporary Rhythm	*1-4-2

01-3 Performance

Offset Address	Description	
00 00 00	Performance Common	*1-3-1
00 02 00	Performance Common MFX	*1-3-2
00 04 00	Performance Common Chorus	*1-3-3
00 06 00	Performance Common Reverb	*1-3-4
00 10 00	Performance MIDI (Channel 1)	*1-3-5
00 11 00	Performance MIDI (Channel 2)	
:	:	
00 1F 00	Performance MIDI (Channel 16)	
00 20 00	Performance Part (Part 1)	*1-3-6
00 21 00	Performance Part (Part 2)	
:	:	
00 2F 00	Performance Part (Part 16)	

01-4-1 Patch

Offset Address	Description	
00 00 00	Patch Common	*1-4-1-1
00 02 00	Patch Common MFX	*1-4-1-2
00 04 00	Patch Common Chorus	*1-4-1-3
00 06 00	Patch Common Reverb	*1-4-1-4
00 10 00	Patch TMT (Tone Mix Table)	*1-4-1-5
00 20 00	Patch Tone (Tone 1)	*1-4-1-6
00 22 00	Patch Tone (Tone 2)	
00 24 00	Patch Tone (Tone 3)	
00 26 00	Patch Tone (Tone 4)	

01-4-2 Rhythm

Offset Address	Description	
00 00 00	Rhythm Common	*1-4-2-1
00 02 00	Rhythm Common MFX	*1-4-2-2
00 04 00	Rhythm Common Chorus	*1-4-2-3
00 06 00	Rhythm Common Reverb	*1-4-2-4
00 10 00	Rhythm Tone (Key # 21)	*1-4-2-5
00 12 00	Rhythm Tone (Key # 22)	
:	:	
01 3E 00	Rhythm Tone (Key # 108)	

01-1 Setup

Offset Address	Description	
00 00	0000 0aaa	Sound Mode (1 - 5) PATCH, PERFORM, GM1, GM2, GS
00 01	0aaa 0aaa	(reserved)
00 02	0aaa 0aaa	(reserved)

00 03	0aaa aaaa	(reserved)	
00 04	0aaa aaaa	Performance Bank Select MSB (CC# 0)	(0 - 127)
00 05	0aaa aaaa	Performance Bank Select LSB (CC# 32)	(0 - 127)
00 06	0aaa aaaa	Performance Program Number (PC)	(0 - 127)
00 07	0aaa aaaa	Patch Bank Select MSB (CC# 0)	(0 - 127)
00 08	0aaa aaaa	Patch Bank Select LSB (CC# 32)	(0 - 127)
00 09	0aaa aaaa	Patch Program Number (PC)	(0 - 127)
00 0A	0000 000a	MFX Switch	(0 - 1) BYPASS, ON
00 0B	0000 000a	Chorus Switch	(0 - 1) OFF, ON
00 0C	0000 000a	Reverb Switch	(0 - 1) OFF, ON
00 0D	0000 aaaa	Transpose Value	(59 - 70) -5 - +6
00 0E	0000 0aaa	Octave Shift	(61 - 67) -3 - +3
00 00 00 0F	Total Size		

01-2-1 System Common

Offset Address	Description	
# 00 00	0000 aaaa 0000 bbbb 0000 cccc 0000 dddd	Master Tune (24 - 2024) -100.0 - 100.0 [cent]
00 04	00aa aaaa	Master Key Shift (40 - 88) -24 - +24
00 05	0aaa aaaa	Master Level (0 - 127)
00 06	0000 000a	Scale Tune Switch (0 - 1) OFF, ON
00 07	0000 000a	Patch Remain (0 - 1) OFF, ON
00 08	0000 000a	Mix/Parallel<*> (0 - 1) MIX, PARALLEL
00 09	000a aaaa	Performance Control Channel (0 - 16) 1 - 16, OFF
00 0A	000a aaaa	(reserved)
00 0B	0000 aaaa	Patch Receive Channel (0 - 15) 1 - 16
00 0C	0aaa aaaa	Patch Scale Tune for C (0 - 127) -64 - +63
00 0D	0aaa aaaa	Patch Scale Tune for C# (0 - 127) -64 - +63
00 0E	0aaa aaaa	Patch Scale Tune for D (0 - 127) -64 - +63
00 0F	0aaa aaaa	Patch Scale Tune for D# (0 - 127) -64 - +63
00 10	0aaa aaaa	Patch Scale Tune for E (0 - 127) -64 - +63
00 11	0aaa aaaa	Patch Scale Tune for F (0 - 127) -64 - +63
00 12	0aaa aaaa	Patch Scale Tune for F# (0 - 127) -64 - +63
00 13	0aaa aaaa	Patch Scale Tune for G (0 - 127) -64 - +63
00 14	0aaa aaaa	Patch Scale Tune for G# (0 - 127) -64 - +63
00 15	0aaa aaaa	Patch Scale Tune for A (0 - 127) -64 - +63
00 16	0aaa aaaa	Patch Scale Tune for A# (0 - 127) -64 - +63
00 17	0aaa aaaa	Patch Scale Tune for B (0 - 127) -64 - +63
00 18	0aaa aaaa	System Control 1 Source (0 - 97) OFF, CC01 - CC31, CC33 - CC95, BEND, AFT
00 19	0aaa aaaa	System Control 2 Source (0 - 97) OFF, CC01 - CC31, CC33 - CC95, BEND, AFT
00 1A	0aaa aaaa	System Control 3 Source (0 - 97) OFF, CC01 - CC31, CC33 - CC95, BEND, AFT
00 1B	0aaa aaaa	System Control 4 Source (0 - 97) OFF, CC01 - CC31, CC33 - CC95, BEND, AFT
00 1C	0000 000a	Receive Program Change (0 - 1) OFF, ON
00 1D	0000 000a	Receive Bank Select (0 - 1) OFF, ON
00 1E	0000 000a	System Clock Source (0 - 2) INT, MIDI, USB
# 00 1F	0000 aaaa 0000 bbbb	System Tempo (20 - 250)
00 00 00 21	Total Size	

01-3-1 Performance Common

Offset Address	Description	
00 00	0aaa aaaa	Performance Name 1 (32 - 127) [ASCII]
00 01	0aaa aaaa	Performance Name 2 (32 - 127) [ASCII]
00 02	0aaa aaaa	Performance Name 3 (32 - 127) [ASCII]
00 03	0aaa aaaa	Performance Name 4 (32 - 127) [ASCII]
00 04	0aaa aaaa	Performance Name 5 (32 - 127) [ASCII]
00 05	0aaa aaaa	Performance Name 6 (32 - 127) [ASCII]
00 06	0aaa aaaa	Performance Name 7 (32 - 127) [ASCII]
00 07	0aaa aaaa	Performance Name 8 (32 - 127) [ASCII]
00 08	0aaa aaaa	Performance Name 9 (32 - 127) [ASCII]
00 09	0aaa aaaa	Performance Name 10 (32 - 127) [ASCII]
00 0A	0aaa aaaa	Performance Name 11 (32 - 127) [ASCII]
00 0B	0aaa aaaa	Performance Name 12 (32 - 127) [ASCII]
00 0C	00aa aaaa	Solo Part Select (0 - 32) OFF, 1 - 16, 17 - 32<*>
00 0D	000a aaaa	MFX Control Channel (0 - 16)

00 0E	0000 000a	MFX Control MIDI1<*>	1 - 16, OFF (0 - 1) OFF, ON
00 0F	0000 000a	MFX Control MIDI2<*>	(0 - 1) OFF, ON
00 10	0aaa aaaa	Voice Reserve 1	(0 - 64) OFF, FULL
00 11	0aaa aaaa	Voice Reserve 2	(0 - 64) OFF, FULL
00 12	0aaa aaaa	Voice Reserve 3	(0 - 64) OFF, FULL
00 13	0aaa aaaa	Voice Reserve 4	(0 - 64) OFF, FULL
00 14	0aaa aaaa	Voice Reserve 5	(0 - 64) OFF, FULL
00 15	0aaa aaaa	Voice Reserve 6	(0 - 64) OFF, FULL
00 16	0aaa aaaa	Voice Reserve 7	(0 - 64) OFF, FULL
00 17	0aaa aaaa	Voice Reserve 8	(0 - 64) OFF, FULL
00 18	0aaa aaaa	Voice Reserve 9	(0 - 64) OFF, FULL
00 19	0aaa aaaa	Voice Reserve 10	(0 - 64) OFF, FULL
00 1A	0aaa aaaa	Voice Reserve 11	(0 - 64) OFF, FULL
00 1B	0aaa aaaa	Voice Reserve 12	(0 - 64) OFF, FULL
00 1C	0aaa aaaa	Voice Reserve 13	(0 - 64) OFF, FULL
00 1D	0aaa aaaa	Voice Reserve 14	(0 - 64) OFF, FULL
00 1E	0aaa aaaa	Voice Reserve 15	(0 - 64) OFF, FULL
00 1F	0aaa aaaa	Voice Reserve 16	(0 - 64) OFF, FULL
00 20	0aaa aaaa	Voice Reserve 17<*>	(0 - 64) OFF, FULL
00 21	0aaa aaaa	Voice Reserve 18<*>	(0 - 64) OFF, FULL
00 22	0aaa aaaa	Voice Reserve 19<*>	(0 - 64) OFF, FULL
00 23	0aaa aaaa	Voice Reserve 20<*>	(0 - 64) OFF, FULL
00 24	0aaa aaaa	Voice Reserve 21<*>	(0 - 64) OFF, FULL
00 25	0aaa aaaa	Voice Reserve 22<*>	(0 - 64) OFF, FULL
00 26	0aaa aaaa	Voice Reserve 23<*>	(0 - 64) OFF, FULL
00 27	0aaa aaaa	Voice Reserve 24<*>	(0 - 64) OFF, FULL
00 28	0aaa aaaa	Voice Reserve 25<*>	(0 - 64) OFF, FULL
00 29	0aaa aaaa	Voice Reserve 26<*>	(0 - 64) OFF, FULL
00 2A	0aaa aaaa	Voice Reserve 27<*>	(0 - 64) OFF, FULL
00 2B	0aaa aaaa	Voice Reserve 28<*>	(0 - 64) OFF, FULL
00 2C	0aaa aaaa	Voice Reserve 29<*>	(0 - 64) OFF, FULL
00 2D	0aaa aaaa	Voice Reserve 30<*>	(0 - 64) OFF, FULL
00 2E	0aaa aaaa	Voice Reserve 31<*>	(0 - 64) OFF, FULL
00 2F	0aaa aaaa	Voice Reserve 32<*>	(0 - 64) OFF, FULL
00 30	00aa aaaa	MFX Source	(0 - 32)
00 31	00aa aaaa	MFXB Source<*>	PERFORM, 1 - 16, 17 - 32<*> (0 - 32)
00 32	00aa aaaa	MFXC Source<*>	PERFORM, 1 - 32 (0 - 32)
00 33	00aa aaaa	Chorus Source	PERFORM, 1 - 32 (0 - 32)
00 34	00aa aaaa	Reverb Source	PERFORM, 1 - 16, 17 - 32<*> (0 - 32)
00 00 00 35	Total Size		

01-3-2 Performance Common MFX

Offset Address	Description	
00 00	0aaa aaaa	MFX Type (0 - 40)
00 01	0aaa aaaa	MFX Dry Send Level (0 - 127)
00 02	0aaa aaaa	MFX Chorus Send Level (0 - 127)
00 03	0aaa aaaa	MFX Reverb Send Level (0 - 127)
00 04	0000 00aa	MFX Output Assign (0 - 3) A, B<*>, C<*>, D<*>
00 05	0aaa aaaa	MFX Control 1 Source (0 - 101) OFF, CC01 - CC31, CC33 - CC95, BEND, AFT, SYS1 - SYS4
00 06	0aaa aaaa	MFX Control 1 Sens (1 - 127) -63 - +63
00 07	0aaa aaaa	MFX Control 2 Source (0 - 101) OFF, CC01 - CC31, CC33 - CC95, BEND, AFT, SYS1 - SYS4
00 08	0aaa aaaa	MFX Control 2 Sens (1 - 127) -63 - +63
00 09	0aaa aaaa	MFX Control 3 Source (0 - 101) OFF, CC01 - CC31, CC33 - CC95, BEND, AFT, SYS1 - SYS4
00 0A	0aaa aaaa	MFX Control 3 Sens (1 - 127) -63 - +63
00 0B	0aaa aaaa	MFX Control 4 Source (0 - 101) OFF, CC01 - CC31, CC33 - CC95, BEND, AFT, SYS1 - SYS4
00 0C	0aaa aaaa	MFX Control 4 Sens (1 - 127) -63 - +63
00 0D	000a aaaa	MFX Control Assign 1 (0 - 16) OFF, 1 - 16
00 0E	000a aaaa	MFX Control Assign 2 (0 - 16) OFF, 1 - 16
00 0F	000a aaaa	MFX Control Assign 3 (0 - 16) OFF, 1 - 16
00 10	000a aaaa	MFX Control Assign 4 (0 - 16) OFF, 1 - 16
# 00 11	0000 aaaa 0000 bbbb 0000 cccc 0000 dddd	MFX Parameter 1 (12768 - 52768) -20000 - +20000
# 00 15	0000 aaaa 0000 bbbb 0000 cccc 0000 dddd	MFX Parameter 2 (12768 - 52768) -20000 - +20000

MIDI Implementation

#	00 19	0000 aaaa 0000 bbbb 0000 cccc 0000 dddd	MFX Parameter 3	(12768 - 52768) -20000 - +20000
#	00 1D	0000 aaaa 0000 bbbb 0000 cccc 0000 dddd	MFX Parameter 4	(12768 - 52768) -20000 - +20000
#	00 21	0000 aaaa 0000 bbbb 0000 cccc 0000 dddd	MFX Parameter 5	(12768 - 52768) -20000 - +20000
#	00 25	0000 aaaa 0000 bbbb 0000 cccc 0000 dddd	MFX Parameter 6	(12768 - 52768) -20000 - +20000
#	00 29	0000 aaaa 0000 bbbb 0000 cccc 0000 dddd	MFX Parameter 7	(12768 - 52768) -20000 - +20000
#	00 2D	0000 aaaa 0000 bbbb 0000 cccc 0000 dddd	MFX Parameter 8	(12768 - 52768) -20000 - +20000
#	00 31	0000 aaaa 0000 bbbb 0000 cccc 0000 dddd	MFX Parameter 9	(12768 - 52768) -20000 - +20000
#	00 35	0000 aaaa 0000 bbbb 0000 cccc 0000 dddd	MFX Parameter 10	(12768 - 52768) -20000 - +20000
#	00 39	0000 aaaa 0000 bbbb 0000 cccc 0000 dddd	MFX Parameter 11	(12768 - 52768) -20000 - +20000
#	00 3D	0000 aaaa 0000 bbbb 0000 cccc 0000 dddd	MFX Parameter 12	(12768 - 52768) -20000 - +20000
#	00 41	0000 aaaa 0000 bbbb 0000 cccc 0000 dddd	MFX Parameter 13	(12768 - 52768) -20000 - +20000
#	00 45	0000 aaaa 0000 bbbb 0000 cccc 0000 dddd	MFX Parameter 14	(12768 - 52768) -20000 - +20000
#	00 49	0000 aaaa 0000 bbbb 0000 cccc 0000 dddd	MFX Parameter 15	(12768 - 52768) -20000 - +20000
#	00 4D	0000 aaaa 0000 bbbb 0000 cccc 0000 dddd	MFX Parameter 16	(12768 - 52768) -20000 - +20000
#	00 51	0000 aaaa 0000 bbbb 0000 cccc 0000 dddd	MFX Parameter 17	(12768 - 52768) -20000 - +20000
#	00 55	0000 aaaa 0000 bbbb 0000 cccc 0000 dddd	MFX Parameter 18	(12768 - 52768) -20000 - +20000
#	00 59	0000 aaaa 0000 bbbb 0000 cccc 0000 dddd	MFX Parameter 19	(12768 - 52768) -20000 - +20000
#	00 5D	0000 aaaa 0000 bbbb 0000 cccc 0000 dddd	MFX Parameter 20	(12768 - 52768) -20000 - +20000
#	00 61	0000 aaaa 0000 bbbb 0000 cccc 0000 dddd	MFX Parameter 21	(12768 - 52768) -20000 - +20000
#	00 65	0000 aaaa 0000 bbbb 0000 cccc 0000 dddd	MFX Parameter 22	(12768 - 52768) -20000 - +20000
#	00 69	0000 aaaa 0000 bbbb 0000 cccc 0000 dddd	MFX Parameter 23	(12768 - 52768) -20000 - +20000
#	00 6D	0000 aaaa 0000 bbbb 0000 cccc 0000 dddd	MFX Parameter 24	(12768 - 52768) -20000 - +20000
#	00 71	0000 aaaa 0000 bbbb 0000 cccc 0000 dddd	MFX Parameter 25	(12768 - 52768) -20000 - +20000
#	00 75	0000 aaaa 0000 bbbb 0000 cccc 0000 dddd	MFX Parameter 26	(12768 - 52768) -20000 - +20000
#	00 79	0000 aaaa 0000 bbbb 0000 cccc 0000 dddd	MFX Parameter 27	(12768 - 52768) -20000 - +20000
#	00 7D	0000 aaaa 0000 bbbb 0000 cccc 0000 dddd	MFX Parameter 28	(12768 - 52768) -20000 - +20000
#	01 01	0000 aaaa 0000 bbbb 0000 cccc 0000 dddd	MFX Parameter 29	(12768 - 52768) -20000 - +20000
#	01 05	0000 aaaa 0000 bbbb 0000 cccc		

#	01 09	0000 aaaa 0000 bbbb 0000 cccc 0000 dddd	MFX Parameter 30	(12768 - 52768) -20000 - +20000
#	01 0D	0000 aaaa 0000 bbbb 0000 cccc 0000 dddd	MFX Parameter 31	(12768 - 52768) -20000 - +20000
#	01 0D	0000 aaaa 0000 bbbb 0000 cccc 0000 dddd	MFX Parameter 32	(12768 - 52768) -20000 - +20000
00 00 01 11		Total Size		

01-3-3 Performance Common Chorus

Offset Address	Description			
00 00	0000 aaaa	Chorus Type	(0 - 1) OFF, CHORUS	
00 01	0aaa aaaa	Chorus Level	(0 - 127)	
00 02	0000 00aa	Chorus Output Assign	(0 - 3) A, B<*>, C<*>, D<*>	
00 03	0000 00aa	Chorus Output Select	(0 - 2) MAIN, REV, MAIN+REV	
#	00 04	0000 aaaa 0000 bbbb 0000 cccc 0000 dddd	Chorus Parameter 1	(12768 - 52768) -20000 - +20000
#	00 08	0000 aaaa 0000 bbbb 0000 cccc 0000 dddd	Chorus Parameter 2	(12768 - 52768) -20000 - +20000
#	00 0C	0000 aaaa 0000 bbbb 0000 cccc 0000 dddd	Chorus Parameter 3	(12768 - 52768) -20000 - +20000
#	00 10	0000 aaaa 0000 bbbb 0000 cccc 0000 dddd	Chorus Parameter 4	(12768 - 52768) -20000 - +20000
#	00 14	0000 aaaa 0000 bbbb 0000 cccc 0000 dddd	Chorus Parameter 5	(12768 - 52768) -20000 - +20000
#	00 18	0000 aaaa 0000 bbbb 0000 cccc 0000 dddd	Chorus Parameter 6	(12768 - 52768) -20000 - +20000
#	00 1C	0000 aaaa 0000 bbbb 0000 cccc 0000 dddd	Chorus Parameter 7	(12768 - 52768) -20000 - +20000
#	00 20	0000 aaaa 0000 bbbb 0000 cccc 0000 dddd	Chorus Parameter 8	(12768 - 52768) -20000 - +20000
#	00 24	0000 aaaa 0000 bbbb 0000 cccc 0000 dddd	Chorus Parameter 9	(12768 - 52768) -20000 - +20000
#	00 28	0000 aaaa 0000 bbbb 0000 cccc 0000 dddd	Chorus Parameter 10	(12768 - 52768) -20000 - +20000
#	00 2C	0000 aaaa 0000 bbbb 0000 cccc 0000 dddd	Chorus Parameter 11	(12768 - 52768) -20000 - +20000
#	00 30	0000 aaaa 0000 bbbb 0000 cccc 0000 dddd	Chorus Parameter 12	(12768 - 52768) -20000 - +20000
00 00 00 34		Total Size		

01-3-4 Performance Common Reverb

Offset Address	Description			
00 00	0000 aaaa	Reverb Type	(0 - 1) OFF, REVERB	
00 01	0aaa aaaa	Reverb Level	(0 - 127)	
00 02	0000 00aa	Reverb Output Assign	(0 - 3) A, B<*>, C<*>, D<*>	
#	00 03	0000 aaaa 0000 bbbb 0000 cccc 0000 dddd	Reverb Parameter 1	(12768 - 52768) -20000 - +20000
#	00 07	0000 aaaa 0000 bbbb 0000 cccc 0000 dddd	Reverb Parameter 2	(12768 - 52768) -20000 - +20000
#	00 0B	0000 aaaa 0000 bbbb 0000 cccc 0000 dddd	Reverb Parameter 3	(12768 - 52768) -20000 - +20000
#	00 0F	0000 aaaa 0000 bbbb 0000 cccc 0000 dddd	Reverb Parameter 4	(12768 - 52768) -20000 - +20000
#	00 13	0000 aaaa 0000 bbbb 0000 cccc 0000 dddd	Reverb Parameter 5	(12768 - 52768) -20000 - +20000
#	00 17	0000 aaaa 0000 bbbb 0000 cccc 0000 dddd	Reverb Parameter 6	(12768 - 52768) -20000 - +20000
#	00 1B	0000 aaaa		

#	00 1F	0000 bbbb 0000 cccc 0000 dddd	Reverb Parameter 7	(12768 - 52768) -20000 - +20000
#	00 23	0000 aaaa 0000 bbbb 0000 cccc 0000 dddd	Reverb Parameter 8	(12768 - 52768) -20000 - +20000
#	00 27	0000 aaaa 0000 bbbb 0000 cccc 0000 dddd	Reverb Parameter 9	(12768 - 52768) -20000 - +20000
#	00 2B	0000 aaaa 0000 bbbb 0000 cccc 0000 dddd	Reverb Parameter 10	(12768 - 52768) -20000 - +20000
#	00 2F	0000 aaaa 0000 bbbb 0000 cccc 0000 dddd	Reverb Parameter 11	(12768 - 52768) -20000 - +20000
#	00 33	0000 aaaa 0000 bbbb 0000 cccc 0000 dddd	Reverb Parameter 12	(12768 - 52768) -20000 - +20000
#	00 37	0000 aaaa 0000 bbbb 0000 cccc 0000 dddd	Reverb Parameter 13	(12768 - 52768) -20000 - +20000
#	00 3B	0000 aaaa 0000 bbbb 0000 cccc 0000 dddd	Reverb Parameter 14	(12768 - 52768) -20000 - +20000
#	00 3F	0000 aaaa 0000 bbbb 0000 cccc 0000 dddd	Reverb Parameter 15	(12768 - 52768) -20000 - +20000
#	00 43	0000 aaaa 0000 bbbb 0000 cccc 0000 dddd	Reverb Parameter 16	(12768 - 52768) -20000 - +20000
#	00 47	0000 aaaa 0000 bbbb 0000 cccc 0000 dddd	Reverb Parameter 17	(12768 - 52768) -20000 - +20000
#	00 4B	0000 aaaa 0000 bbbb 0000 cccc 0000 dddd	Reverb Parameter 18	(12768 - 52768) -20000 - +20000
#	00 4F	0000 aaaa 0000 bbbb 0000 cccc 0000 dddd	Reverb Parameter 19	(12768 - 52768) -20000 - +20000
#	00 53	0000 aaaa 0000 bbbb 0000 cccc 0000 dddd	Reverb Parameter 20	(12768 - 52768) -20000 - +20000
	00 00 00 53	Total Size		

01-3-5 Performance MIDI

Offset Address	Description	
00 00	0000 000a	Receive Program Change (0 - 1) OFF, ON
00 01	0000 000a	Receive Bank Select (0 - 1) OFF, ON
00 02	0000 000a	Receive Bender (0 - 1) OFF, ON
00 03	0000 000a	Receive Polyphonic Key Pressure (0 - 1) OFF, ON
00 04	0000 000a	Receive Channel Pressure (0 - 1) OFF, ON
00 05	0000 000a	Receive Modulation (0 - 1) OFF, ON
00 06	0000 000a	Receive Volume (0 - 1) OFF, ON
00 07	0000 000a	Receive Pan (0 - 1) OFF, ON
00 08	0000 000a	Receive Expression (0 - 1) OFF, ON
00 09	0000 000a	Receive Hold-1 (0 - 1) OFF, ON
00 0A	0000 000a	Phase Lock (0 - 1) OFF, ON
00 0B	0000 0aaa	Velocity Curve Type (0 - 4) OFF, 1 - 4
00 00 00 0C	Total Size	

01-3-6 Performance Part

Offset Address	Description	
00 00	0000 aaaa	Receive Channel (0 - 15) 1 - 16
00 01	0000 000a	Receive Switch (0 - 1) OFF, ON
00 02	0000 000a	Receive MIDI1<*> (0 - 1) OFF, ON
00 03	0000 000a	Receive MIDI2<*> (0 - 1) OFF, ON
00 04	0aaa aaaa	Patch Bank Select MSB (CC# 0) (0 - 127)
00 05	0aaa aaaa	Patch Bank Select LSB (CC# 32) (0 - 127)
00 06	0aaa aaaa	Patch Program Number (PC) (0 - 127)
00 07	0aaa aaaa	Part Level (CC# 7) (0 - 127)
00 08	0aaa aaaa	Part Pan (CC# 10) (0 - 127) L64 - 63R
00 09	0aaa aaaa	Part Coarse Tune (RPN# 2) (16 - 112) -48 - +48
00 0A	0aaa aaaa	Part Fine Tune (RPN# 1) (14 - 114) -50 - +50
00 0B	0000 00aa	Part Mono/Poly (MONO ON/POLY ON) (0 - 2) MONO, POLY, PATCH
00 0C	0000 00aa	Part Legato Switch (CC# 68) (0 - 2)

#	00 0D	000a aaaa	Part Pitch Bend Range (RPN# 0)	OFF, ON, PATCH (0 - 25)
#	00 0E	0000 00aa	Part Portamento Switch (CC# 65)	0 - 24, PATCH (0 - 2)
#	00 0F	0000 aaaa	Part Portamento Time (CC# 5)	OFF, ON, PATCH (0 - 128)
#	00 11	0aaa aaaa	Part Cutoff Offset (CC# 74)	0 - 127, PATCH (0 - 127)
#	00 12	0aaa aaaa	Part Resonance Offset (CC# 71)	-64 - +63 (0 - 127)
#	00 13	0aaa aaaa	Part Attack Time Offset (CC# 73)	-64 - +63 (0 - 127)
#	00 14	0aaa aaaa	Part Release Time Offset (CC# 72)	-64 - +63 (0 - 127)
#	00 15	0000 0aaa	Part Octave Shift	(61 - 67) -3 - +3
#	00 16	0aaa aaaa	Part Velocity Sens Offset	(1 - 127) -63 - +63
#	00 17	0aaa aaaa	Keyboard Range Lower	(0 - 127) C-1 - UPPER
#	00 18	0aaa aaaa	Keyboard Range Upper	(0 - 127) LOWER - G9
#	00 19	0aaa aaaa	Keyboard Fade Width Lower	(0 - 127)
#	00 1A	0aaa aaaa	Keyboard Fade Width Upper	(0 - 127)
#	00 1B	0000 000a	Mute Switch	(0 - 1) OFF, MUTE
#	00 1C	0aaa aaaa	Part Dry Send Level	(0 - 127)
#	00 1D	0aaa aaaa	Part Chorus Send Level (CC# 93)	(0 - 127)
#	00 1E	0aaa aaaa	Part Reverb Send Level (CC# 91)	(0 - 127)
#	00 1F	0000 aaaa	Part Output Assign	(0 - 13) MPX, A, B<*>, C<*>, D<*>, 1, 2, 3<*>, 4<*>, 5<*>, 6<*>, 7<*>, 8<*>
#	00 20	0000 00aa	Part Output MPX Select	PATCH (0 - 2) MPXA, MPXB<*>, MPXC<*>
#	00 21	0aaa aaaa	Part Decay Time Offset (CC# 75)	(0 - 127) -64 - +63
#	00 22	0aaa aaaa	Part Vibrato Rate (CC# 76)	(0 - 127) -64 - +63
#	00 23	0aaa aaaa	Part Vibrato Depth (CC# 77)	(0 - 127) -64 - +63
#	00 24	0aaa aaaa	Part Vibrato Delay (CC# 78)	(0 - 127) -64 - +63
#	00 25	0aaa aaaa	Part Scale Tune for C	(0 - 127) -64 - +63
#	00 26	0aaa aaaa	Part Scale Tune for C#	(0 - 127) -64 - +63
#	00 27	0aaa aaaa	Part Scale Tune for D	(0 - 127) -64 - +63
#	00 28	0aaa aaaa	Part Scale Tune for D#	(0 - 127) -64 - +63
#	00 29	0aaa aaaa	Part Scale Tune for E	(0 - 127) -64 - +63
#	00 2A	0aaa aaaa	Part Scale Tune for F	(0 - 127) -64 - +63
#	00 2B	0aaa aaaa	Part Scale Tune for F#	(0 - 127) -64 - +63
#	00 2C	0aaa aaaa	Part Scale Tune for G	(0 - 127) -64 - +63
#	00 2D	0aaa aaaa	Part Scale Tune for G#	(0 - 127) -64 - +63
#	00 2E	0aaa aaaa	Part Scale Tune for A	(0 - 127) -64 - +63
#	00 2F	0aaa aaaa	Part Scale Tune for A#	(0 - 127) -64 - +63
#	00 30	0aaa aaaa	Part Scale Tune for B	(0 - 127) -64 - +63
00 00 00 31	Total Size			

01-4-1-1 Patch Common

Offset Address	Description	
00 00	0aaa aaaa	Patch Name 1 (32 - 127)
00 01	0aaa aaaa	Patch Name 2 (32 - 127 [ASCII])
00 02	0aaa aaaa	Patch Name 3 (32 - 127 [ASCII])
00 03	0aaa aaaa	Patch Name 4 (32 - 127 [ASCII])
00 04	0aaa aaaa	Patch Name 5 (32 - 127 [ASCII])
00 05	0aaa aaaa	Patch Name 6 (32 - 127 [ASCII])
00 06	0aaa aaaa	Patch Name 7 (32 - 127 [ASCII])
00 07	0aaa aaaa	Patch Name 8 (32 - 127 [ASCII])
00 08	0aaa aaaa	Patch Name 9 (32 - 127 [ASCII])
00 09	0aaa aaaa	Patch Name 10 (32 - 127 [ASCII])
00 0A	0aaa aaaa	Patch Name 11 (32 - 127 [ASCII])
00 0B	0aaa aaaa	Patch Name 12 (32 - 127 [ASCII])
00 0C	0aaa aaaa	Patch Category (32 - 127 [ASCII])
00 0D	0000 000a	Tone Type<*> (0 - 1) 4TONES, MULTI-PARTIAL
00 0E	0aaa aaaa	Patch Level (0 - 127)
00 0F	0aaa aaaa	Patch Pan (0 - 127) L64 - 63R
00 10	0000 000a	Patch Priority (0 - 1) LAST, LOUDEST
00 11	0aaa aaaa	Patch Coarse Tune (16 - 112) -48 - +48
00 12	0aaa aaaa	Patch Fine Tune (14 - 114) -50 - +50
00 13	0000 0aaa	Octave Shift (61 - 67) -3 - +3
00 14	0000 00aa	Stretch Tune Depth (0 - 3) OFF, 1 - 3
00 15	0aaa aaaa	Analog Peel (0 - 127)
00 16	0000 000a	Mono/Poly (0 - 1) MONO, POLY
00 17	0000 000a	Legato Switch (0 - 1) OFF, ON
00 18	0000 000a	Legato Retrigger (0 - 1) OFF, ON
00 19	0000 000a	Portamento Switch (0 - 1) OFF, ON
00 1A	0000 000a	Portamento Mode (0 - 1) NORMAL, LEGATO

MIDI Implementation

	00 1B	0000 000a	Portamento Type	(0 - 1) RATE, TIME
	00 1C	0000 000a	Portamento Start	(0 - 1) PITCH, NOTE
	00 1D	0000 000a	Portamento Time	(0 - 127)
#	00 1E	0000 000a	Patch Clock Source	(0 - 1) PATCH, SYSTEM
	00 1F	0000 aaaa 0000 bbbb	Patch Tempo	(20 - 250)
	00 21	0000 000a	One Shot Mode<*>	(0 - 1) OFF, ON
	00 22	0aaa aaaa	Cutoff Offset	(1 - 127) -63 +63
	00 23	0aaa aaaa	Resonance Offset	(1 - 127) -63 +63
	00 24	0aaa aaaa	Attack Time Offset	(1 - 127) -63 +63
	00 25	0aaa aaaa	Release Time Offset	(1 - 127) -63 +63
	00 26	0aaa aaaa	Velocity Sens Offset	(1 - 127) -63 +63
	00 27	0000 aaaa	Patch Output Assign	(0 - 13) MFx, A, B<*>, C<*>, D<*>, 1, 2, 3<*>, 4<*>, 5<*>, 6<*>, 7<*>, 8<*>, TONE
	00 28	0000 000a	TMT Control Switch	(0 - 1) OFF, ON
	00 29	00aa aaaa	Pitch Bend Range Up	(0 - 48)
	00 2A	00aa aaaa	Pitch Bend Range Down	(0 - 48)
	00 2B	0aaa aaaa	Matrix Control 1 Source	(0 - 109) OFF, CC01 - CC31, CC33 - CC95, BEND, AFT, SYS1 - SYS4, VELOCITY, KEYFOLLOW, TEMPO, LF01, LFO2, PIT-ENV, TVF-ENV, TVA-ENV
	00 2C	00aa aaaa	Matrix Control 1 Destination 1	(0 - 33) OFF, PCH, CUT, RES, LEV, PAN, DRY, CHO, REV, PIT-LF01, PIT-LF02, TVF-LF01, TVF-LF02, TVA-LF01, TVA-LF02, PAN-LF01, PAN-LF02, LF01-RATE, LFO2-RATE, PIT-ATK, PIT-DCY, PIT-REL, TVF-ATK, TVF-DCY, TVF-REL, TVA-ATK, TVA-DCY, TVA-REL, TMT, FXM, MFx-CTRL1, MFx-CTRL2, MFx-CTRL3, MFx-CTRL4
	00 2D	0aaa aaaa	Matrix Control 1 Sens 1	(1 - 127) -63 +63
	00 2E	00aa aaaa	Matrix Control 1 Destination 2	(0 - 33) OFF, PCH, CUT, RES, LEV, PAN, DRY, CHO, REV, PIT-LF01, PIT-LF02, TVF-LF01, TVF-LF02, TVA-LF01, TVA-LF02, PAN-LF01, PAN-LF02, LF01-RATE, LFO2-RATE, PIT-ATK, PIT-DCY, PIT-REL, TVF-ATK, TVF-DCY, TVF-REL, TVA-ATK, TVA-DCY, TVA-REL, TMT, FXM, MFx-CTRL1, MFx-CTRL2, MFx-CTRL3, MFx-CTRL4
	00 2F	0aaa aaaa	Matrix Control 1 Sens 2	(1 - 127) -63 +63
	00 30	00aa aaaa	Matrix Control 1 Destination 3	(0 - 33) OFF, PCH, CUT, RES, LEV, PAN, DRY, CHO, REV, PIT-LF01, PIT-LF02, TVF-LF01, TVF-LF02, TVA-LF01, TVA-LF02, PAN-LF01, PAN-LF02, LF01-RATE, LFO2-RATE, PIT-ATK, PIT-DCY, PIT-REL, TVF-ATK, TVF-DCY, TVF-REL, TVA-ATK, TVA-DCY, TVA-REL, TMT, FXM, MFx-CTRL1, MFx-CTRL2, MFx-CTRL3, MFx-CTRL4
	00 31	0aaa aaaa	Matrix Control 1 Sens 3	(1 - 127) -63 +63
	00 32	00aa aaaa	Matrix Control 1 Destination 4	(0 - 33) OFF, PCH, CUT, RES, LEV, PAN, DRY, CHO, REV, PIT-LF01, PIT-LF02, TVF-LF01, TVF-LF02, TVA-LF01, TVA-LF02, PAN-LF01, PAN-LF02, LF01-RATE, LFO2-RATE, PIT-ATK, PIT-DCY, PIT-REL, TVF-ATK, TVF-DCY, TVF-REL, TVA-ATK, TVA-DCY, TVA-REL, TMT, FXM, MFx-CTRL1, MFx-CTRL2, MFx-CTRL3, MFx-CTRL4
	00 33	0aaa aaaa	Matrix Control 1 Sens 4	(1 - 127) -63 +63
	00 34	0aaa aaaa	Matrix Control 2 Source	(0 - 109) OFF, CC01 - CC31, CC33 - CC95, BEND, AFT, SYS1 - SYS4, VELOCITY, KEYFOLLOW, TEMPO, LF01, LFO2, PIT-ENV, TVF-ENV, TVA-ENV
	00 35	00aa aaaa	Matrix Control 2 Destination 1	(0 - 33) OFF, PCH, CUT, RES, LEV, PAN, DRY, CHO, REV, PIT-LF01, PIT-LF02, TVF-LF01, TVF-LF02, TVA-LF01, TVA-LF02, PAN-LF01, PAN-LF02, LF01-RATE, LFO2-RATE, PIT-ATK, PIT-DCY, PIT-REL, TVF-ATK, TVF-DCY, TVF-REL, TVA-ATK, TVA-DCY, TVA-REL, TMT, FXM, MFx-CTRL1, MFx-CTRL2, MFx-CTRL3, MFx-CTRL4
	00 36	0aaa aaaa	Matrix Control 2 Sens 1	(1 - 127) -63 +63
	00 37	00aa aaaa	Matrix Control 2 Destination 2	(0 - 33) OFF, PCH, CUT, RES, LEV, PAN, DRY, CHO, REV, PIT-LF01, PIT-LF02, TVF-LF01, TVF-LF02, TVA-LF01, TVA-LF02, PAN-LF01, PAN-LF02, LF01-RATE, LFO2-RATE, PIT-ATK, PIT-DCY, PIT-REL, TVF-ATK, TVF-DCY, TVF-REL, TVA-ATK, TVA-DCY, TVA-REL, TMT, FXM, MFx-CTRL1, MFx-CTRL2, MFx-CTRL3, MFx-CTRL4
	00 38	0aaa aaaa	Matrix Control 2 Sens 2	(1 - 127) -63 +63
	00 39	00aa aaaa	Matrix Control 2 Destination 3	(0 - 33) OFF, PCH, CUT, RES, LEV, PAN, DRY, CHO, REV, PIT-LF01, PIT-LF02, TVF-LF01, TVF-LF02, TVA-LF01, TVA-LF02, PAN-LF01, PAN-LF02, LF01-RATE, LFO2-RATE, PIT-ATK, PIT-DCY, PIT-REL, TVF-ATK, TVF-DCY, TVF-REL, TVA-ATK, TVA-DCY, TVA-REL, TMT, FXM, MFx-CTRL1, MFx-CTRL2, MFx-CTRL3, MFx-CTRL4
	00 3A	0aaa aaaa	Matrix Control 2 Sens 3	(1 - 127) -63 +63
	00 3B	00aa aaaa	Matrix Control 2 Destination 4	(0 - 33) OFF, PCH, CUT, RES, LEV, PAN, DRY, CHO, REV, PIT-LF01, PIT-LF02, TVF-LF01, TVF-LF02, TVA-LF01, TVA-LF02, PAN-LF01, PAN-LF02, LF01-RATE, LFO2-RATE, PIT-ATK, PIT-DCY, PIT-REL, TVF-ATK, TVF-DCY, TVF-REL, TVA-ATK, TVA-DCY, TVA-REL, TMT, FXM, MFx-CTRL1, MFx-CTRL2, MFx-CTRL3, MFx-CTRL4

	00 3C	0aaa aaaa	Matrix Control 2 Sens 4	(1 - 127) -63 +63
	00 3D	0aaa aaaa	Matrix Control 3 Source	(0 - 109) OFF, CC01 - CC31, CC33 - CC95, BEND, AFT, SYS1 - SYS4, VELOCITY, KEYFOLLOW, TEMPO, LF01, LFO2, PIT-ENV, TVF-ENV, TVA-ENV
	00 3E	00aa aaaa	Matrix Control 3 Destination 1	(0 - 33) OFF, PCH, CUT, RES, LEV, PAN, DRY, CHO, REV, PIT-LF01, PIT-LF02, TVF-LF01, TVF-LF02, TVA-LF01, TVA-LF02, PAN-LF01, PAN-LF02, LF01-RATE, LFO2-RATE, PIT-ATK, PIT-DCY, PIT-REL, TVF-ATK, TVF-DCY, TVF-REL, TVA-ATK, TVA-DCY, TVA-REL, TMT, FXM, MFx-CTRL1, MFx-CTRL2, MFx-CTRL3, MFx-CTRL4
	00 3F	0aaa aaaa	Matrix Control 3 Sens 1	(1 - 127) -63 +63
	00 40	00aa aaaa	Matrix Control 3 Destination 2	(0 - 33) OFF, PCH, CUT, RES, LEV, PAN, DRY, CHO, REV, PIT-LF01, PIT-LF02, TVF-LF01, TVF-LF02, TVA-LF01, TVA-LF02, PAN-LF01, PAN-LF02, LF01-RATE, LFO2-RATE, PIT-ATK, PIT-DCY, PIT-REL, TVF-ATK, TVF-DCY, TVF-REL, TVA-ATK, TVA-DCY, TVA-REL, TMT, FXM, MFx-CTRL1, MFx-CTRL2, MFx-CTRL3, MFx-CTRL4
	00 41	0aaa aaaa	Matrix Control 3 Sens 2	(1 - 127) -63 +63
	00 42	00aa aaaa	Matrix Control 3 Destination 3	(0 - 33) OFF, PCH, CUT, RES, LEV, PAN, DRY, CHO, REV, PIT-LF01, PIT-LF02, TVF-LF01, TVF-LF02, TVA-LF01, TVA-LF02, PAN-LF01, PAN-LF02, LF01-RATE, LFO2-RATE, PIT-ATK, PIT-DCY, PIT-REL, TVF-ATK, TVF-DCY, TVF-REL, TVA-ATK, TVA-DCY, TVA-REL, TMT, FXM, MFx-CTRL1, MFx-CTRL2, MFx-CTRL3, MFx-CTRL4
	00 43	0aaa aaaa	Matrix Control 3 Sens 3	(1 - 127) -63 +63
	00 44	00aa aaaa	Matrix Control 3 Destination 4	(0 - 33) OFF, PCH, CUT, RES, LEV, PAN, DRY, CHO, REV, PIT-LF01, PIT-LF02, TVF-LF01, TVF-LF02, TVA-LF01, TVA-LF02, PAN-LF01, PAN-LF02, LF01-RATE, LFO2-RATE, PIT-ATK, PIT-DCY, PIT-REL, TVF-ATK, TVF-DCY, TVF-REL, TVA-ATK, TVA-DCY, TVA-REL, TMT, FXM, MFx-CTRL1, MFx-CTRL2, MFx-CTRL3, MFx-CTRL4
	00 45	0aaa aaaa	Matrix Control 3 Sens 4	(1 - 127) -63 +63
	00 46	0aaa aaaa	Matrix Control 4 Source	(0 - 109) OFF, CC01 - CC31, CC33 - CC95, BEND, AFT, SYS1 - SYS4, VELOCITY, KEYFOLLOW, TEMPO, LF01, LFO2, PIT-ENV, TVF-ENV, TVA-ENV
	00 47	00aa aaaa	Matrix Control 4 Destination 1	(0 - 33) OFF, PCH, CUT, RES, LEV, PAN, DRY, CHO, REV, PIT-LF01, PIT-LF02, TVF-LF01, TVF-LF02, TVA-LF01, TVA-LF02, PAN-LF01, PAN-LF02, LF01-RATE, LFO2-RATE, PIT-ATK, PIT-DCY, PIT-REL, TVF-ATK, TVF-DCY, TVF-REL, TVA-ATK, TVA-DCY, TVA-REL, TMT, FXM, MFx-CTRL1, MFx-CTRL2, MFx-CTRL3, MFx-CTRL4
	00 48	0aaa aaaa	Matrix Control 4 Sens 1	(1 - 127) -63 +63
	00 49	00aa aaaa	Matrix Control 4 Destination 2	(0 - 33) OFF, PCH, CUT, RES, LEV, PAN, DRY, CHO, REV, PIT-LF01, PIT-LF02, TVF-LF01, TVF-LF02, TVA-LF01, TVA-LF02, PAN-LF01, PAN-LF02, LF01-RATE, LFO2-RATE, PIT-ATK, PIT-DCY, PIT-REL, TVF-ATK, TVF-DCY, TVF-REL, TVA-ATK, TVA-DCY, TVA-REL, TMT, FXM, MFx-CTRL1, MFx-CTRL2, MFx-CTRL3, MFx-CTRL4
	00 4A	0aaa aaaa	Matrix Control 4 Sens 2	(1 - 127) -63 +63
	00 4B	00aa aaaa	Matrix Control 4 Destination 3	(0 - 33) OFF, PCH, CUT, RES, LEV, PAN, DRY, CHO, REV, PIT-LF01, PIT-LF02, TVF-LF01, TVF-LF02, TVA-LF01, TVA-LF02, PAN-LF01, PAN-LF02, LF01-RATE, LFO2-RATE, PIT-ATK, PIT-DCY, PIT-REL, TVF-ATK, TVF-DCY, TVF-REL, TVA-ATK, TVA-DCY, TVA-REL, TMT, FXM, MFx-CTRL1, MFx-CTRL2, MFx-CTRL3, MFx-CTRL4
	00 4C	0aaa aaaa	Matrix Control 4 Sens 3	(1 - 127) -63 +63
	00 4D	00aa aaaa	Matrix Control 4 Destination 4	(0 - 33) OFF, PCH, CUT, RES, LEV, PAN, DRY, CHO, REV, PIT-LF01, PIT-LF02, TVF-LF01, TVF-LF02, TVA-LF01, TVA-LF02, PAN-LF01, PAN-LF02, LF01-RATE, LFO2-RATE, PIT-ATK, PIT-DCY, PIT-REL, TVF-ATK, TVF-DCY, TVF-REL, TVA-ATK, TVA-DCY, TVA-REL, TMT, FXM, MFx-CTRL1, MFx-CTRL2, MFx-CTRL3, MFx-CTRL4
	00 4E	0aaa aaaa	Matrix Control 4 Sens 4	(1 - 127) -63 +63
	00 00 00 4F		Total Size	

01-4-1-2 Patch Common MFx

Offset	Address	Description	
00 00	0aaa aaaa	MFx Type	(0 - 40)
00 01	0aaa aaaa	MFx Dry Send Level	(0 - 127)
00 02	0aaa aaaa	MFx Chorus Send Level	(0 - 127)
00 03	0aaa aaaa	MFx Reverb Send Level	(0 - 127)
00 04	0000 00aa	MFx Output Assign	(0 - 3) A, B<*>, C<*>, D<*>
00 05	0aaa aaaa	MFx Control 1 Source	(0 - 101) OFF, CC01 - CC31, CC33 - CC95, BEND, AFT, SYS1 - SYS4
00 06	0aaa aaaa	MFx Control 1 Sens	(1 - 127) -63 +63
00 07	0aaa aaaa	MFx Control 2 Source	(0 - 101) OFF, CC01 - CC31, CC33 - CC95, BEND, AFT, SYS1 - SYS4
00 08	0aaa aaaa	MFx Control 2 Sens	(1 - 127) -63 +63

00 09	0aaa aaaa	MFX Control 3 Source	(0 - 101) OFF, CC01 - CC31, CC33 - CC95, BEND, AFT, SYS1 - SYS4
00 0A	0aaa aaaa	MFX Control 3 Sens	(1 - 127) -63 - +63
00 0B	0aaa aaaa	MFX Control 4 Source	(0 - 101) OFF, CC01 - CC31, CC33 - CC95, BEND, AFT, SYS1 - SYS4
00 0C	0aaa aaaa	MFX Control 4 Sens	(1 - 127) -63 - +63
00 0D	000a aaaa	MFX Control Assign 1	(0 - 16) OFF, 1 - 16
00 0E	000a aaaa	MFX Control Assign 2	(0 - 16) OFF, 1 - 16
00 0F	000a aaaa	MFX Control Assign 3	(0 - 16) OFF, 1 - 16
00 10	000a aaaa	MFX Control Assign 4	(0 - 16) OFF, 1 - 16
# 00 11	0000 aaaa 0000 bbbb 0000 cccc 0000 dddd	MFX Parameter 1	(12768 - 52768) -20000 - +20000
# 00 15	0000 aaaa 0000 bbbb 0000 cccc 0000 dddd	MFX Parameter 2	(12768 - 52768) -20000 - +20000
# 00 19	0000 aaaa 0000 bbbb 0000 cccc 0000 dddd	MFX Parameter 3	(12768 - 52768) -20000 - +20000
# 00 1D	0000 aaaa 0000 bbbb 0000 cccc 0000 dddd	MFX Parameter 4	(12768 - 52768) -20000 - +20000
# 00 21	0000 aaaa 0000 bbbb 0000 cccc 0000 dddd	MFX Parameter 5	(12768 - 52768) -20000 - +20000
# 00 25	0000 aaaa 0000 bbbb 0000 cccc 0000 dddd	MFX Parameter 6	(12768 - 52768) -20000 - +20000
# 00 29	0000 aaaa 0000 bbbb 0000 cccc 0000 dddd	MFX Parameter 7	(12768 - 52768) -20000 - +20000
# 00 2D	0000 aaaa 0000 bbbb 0000 cccc 0000 dddd	MFX Parameter 8	(12768 - 52768) -20000 - +20000
# 00 31	0000 aaaa 0000 bbbb 0000 cccc 0000 dddd	MFX Parameter 9	(12768 - 52768) -20000 - +20000
# 00 35	0000 aaaa 0000 bbbb 0000 cccc 0000 dddd	MFX Parameter 10	(12768 - 52768) -20000 - +20000
# 00 39	0000 aaaa 0000 bbbb 0000 cccc 0000 dddd	MFX Parameter 11	(12768 - 52768) -20000 - +20000
# 00 3D	0000 aaaa 0000 bbbb 0000 cccc 0000 dddd	MFX Parameter 12	(12768 - 52768) -20000 - +20000
# 00 41	0000 aaaa 0000 bbbb 0000 cccc 0000 dddd	MFX Parameter 13	(12768 - 52768) -20000 - +20000
# 00 45	0000 aaaa 0000 bbbb 0000 cccc 0000 dddd	MFX Parameter 14	(12768 - 52768) -20000 - +20000
# 00 49	0000 aaaa 0000 bbbb 0000 cccc 0000 dddd	MFX Parameter 15	(12768 - 52768) -20000 - +20000
# 00 4D	0000 aaaa 0000 bbbb 0000 cccc 0000 dddd	MFX Parameter 16	(12768 - 52768) -20000 - +20000
# 00 51	0000 aaaa 0000 bbbb 0000 cccc 0000 dddd	MFX Parameter 17	(12768 - 52768) -20000 - +20000
# 00 55	0000 aaaa 0000 bbbb 0000 cccc 0000 dddd	MFX Parameter 18	(12768 - 52768) -20000 - +20000
# 00 59	0000 aaaa 0000 bbbb 0000 cccc 0000 dddd	MFX Parameter 19	(12768 - 52768) -20000 - +20000
# 00 5D	0000 aaaa 0000 bbbb 0000 cccc 0000 dddd	MFX Parameter 20	(12768 - 52768) -20000 - +20000
# 00 61	0000 aaaa 0000 bbbb 0000 cccc 0000 dddd	MFX Parameter 21	(12768 - 52768) -20000 - +20000
# 00 65	0000 aaaa 0000 bbbb 0000 cccc 0000 dddd	MFX Parameter 22	(12768 - 52768) -20000 - +20000
# 00 69	0000 aaaa 0000 bbbb 0000 cccc 0000 dddd	MFX Parameter 23	(12768 - 52768) -20000 - +20000
# 00 6D	0000 aaaa 0000 bbbb 0000 cccc 0000 dddd	MFX Parameter 24	(12768 - 52768)

# 00 71	0000 aaaa 0000 bbbb 0000 cccc 0000 dddd	MFX Parameter 25	(12768 - 52768) -20000 - +20000
# 00 75	0000 aaaa 0000 bbbb 0000 cccc 0000 dddd	MFX Parameter 26	(12768 - 52768) -20000 - +20000
# 00 79	0000 aaaa 0000 bbbb 0000 cccc 0000 dddd	MFX Parameter 27	(12768 - 52768) -20000 - +20000
# 00 7D	0000 aaaa 0000 bbbb 0000 cccc 0000 dddd	MFX Parameter 28	(12768 - 52768) -20000 - +20000
# 01 01	0000 aaaa 0000 bbbb 0000 cccc 0000 dddd	MFX Parameter 29	(12768 - 52768) -20000 - +20000
# 01 05	0000 aaaa 0000 bbbb 0000 cccc 0000 dddd	MFX Parameter 30	(12768 - 52768) -20000 - +20000
# 01 09	0000 aaaa 0000 bbbb 0000 cccc 0000 dddd	MFX Parameter 31	(12768 - 52768) -20000 - +20000
# 01 0D	0000 aaaa 0000 bbbb 0000 cccc 0000 dddd	MFX Parameter 32	(12768 - 52768) -20000 - +20000
00 00 01 11	Total Size		

01-4-1-3 Patch Common Chorus

Offset Address	Description	
00 00	0000 aaaa	Chorus Type (0 - 1) OFF, CHORUS
00 01	0aaa aaaa	Chorus Level (0 - 127)
00 02	0000 00aa	Chorus Output Assign (0 - 3) A, B<*>, C<*>, D<*>
00 03	0000 00aa	Chorus Output Select (0 - 2) MAIN, REV, MAIN+REV
# 00 04	0000 aaaa 0000 bbbb 0000 cccc 0000 dddd	Chorus Parameter 1 (12768 - 52768) -20000 - +20000
# 00 08	0000 aaaa 0000 bbbb 0000 cccc 0000 dddd	Chorus Parameter 2 (12768 - 52768) -20000 - +20000
# 00 0C	0000 aaaa 0000 bbbb 0000 cccc 0000 dddd	Chorus Parameter 3 (12768 - 52768) -20000 - +20000
# 00 10	0000 aaaa 0000 bbbb 0000 cccc 0000 dddd	Chorus Parameter 4 (12768 - 52768) -20000 - +20000
# 00 14	0000 aaaa 0000 bbbb 0000 cccc 0000 dddd	Chorus Parameter 5 (12768 - 52768) -20000 - +20000
# 00 18	0000 aaaa 0000 bbbb 0000 cccc 0000 dddd	Chorus Parameter 6 (12768 - 52768) -20000 - +20000
# 00 1C	0000 aaaa 0000 bbbb 0000 cccc 0000 dddd	Chorus Parameter 7 (12768 - 52768) -20000 - +20000
# 00 20	0000 aaaa 0000 bbbb 0000 cccc 0000 dddd	Chorus Parameter 8 (12768 - 52768) -20000 - +20000
# 00 24	0000 aaaa 0000 bbbb 0000 cccc 0000 dddd	Chorus Parameter 9 (12768 - 52768) -20000 - +20000
# 00 28	0000 aaaa 0000 bbbb 0000 cccc 0000 dddd	Chorus Parameter 10 (12768 - 52768) -20000 - +20000
# 00 2C	0000 aaaa 0000 bbbb 0000 cccc 0000 dddd	Chorus Parameter 11 (12768 - 52768) -20000 - +20000
# 00 30	0000 aaaa 0000 bbbb 0000 cccc 0000 dddd	Chorus Parameter 12 (12768 - 52768) -20000 - +20000
00 00 00 34	Total Size	

01-4-1-4 Patch Common Reverb

Offset Address	Description	
00 00	0000 aaaa	Reverb Type (0 - 1) OFF, REVERB
00 01	0aaa aaaa	Reverb Level (0 - 127)
00 02	0000 00aa	Reverb Output Assign (0 - 3) A, B<*>, C<*>, D<*>
# 00 03	0000 aaaa 0000 bbbb	

MIDI Implementation

MIDI Implementation

#	00 07	0000 cccc 0000 dddd	Reverb Parameter 1	(12768 - 52768) -20000 - +20000
#	00 0B	0000 aaaa 0000 bbbb 0000 cccc 0000 dddd	Reverb Parameter 2	(12768 - 52768) -20000 - +20000
#	00 0F	0000 aaaa 0000 bbbb 0000 cccc 0000 dddd	Reverb Parameter 3	(12768 - 52768) -20000 - +20000
#	00 13	0000 aaaa 0000 bbbb 0000 cccc 0000 dddd	Reverb Parameter 4	(12768 - 52768) -20000 - +20000
#	00 17	0000 aaaa 0000 bbbb 0000 cccc 0000 dddd	Reverb Parameter 5	(12768 - 52768) -20000 - +20000
#	00 1B	0000 aaaa 0000 bbbb 0000 cccc 0000 dddd	Reverb Parameter 6	(12768 - 52768) -20000 - +20000
#	00 1F	0000 aaaa 0000 bbbb 0000 cccc 0000 dddd	Reverb Parameter 7	(12768 - 52768) -20000 - +20000
#	00 23	0000 aaaa 0000 bbbb 0000 cccc 0000 dddd	Reverb Parameter 8	(12768 - 52768) -20000 - +20000
#	00 27	0000 aaaa 0000 bbbb 0000 cccc 0000 dddd	Reverb Parameter 9	(12768 - 52768) -20000 - +20000
#	00 2B	0000 aaaa 0000 bbbb 0000 cccc 0000 dddd	Reverb Parameter 10	(12768 - 52768) -20000 - +20000
#	00 2F	0000 aaaa 0000 bbbb 0000 cccc 0000 dddd	Reverb Parameter 11	(12768 - 52768) -20000 - +20000
#	00 33	0000 aaaa 0000 bbbb 0000 cccc 0000 dddd	Reverb Parameter 12	(12768 - 52768) -20000 - +20000
#	00 37	0000 aaaa 0000 bbbb 0000 cccc 0000 dddd	Reverb Parameter 13	(12768 - 52768) -20000 - +20000
#	00 3B	0000 aaaa 0000 bbbb 0000 cccc 0000 dddd	Reverb Parameter 14	(12768 - 52768) -20000 - +20000
#	00 3F	0000 aaaa 0000 bbbb 0000 cccc 0000 dddd	Reverb Parameter 15	(12768 - 52768) -20000 - +20000
#	00 43	0000 aaaa 0000 bbbb 0000 cccc 0000 dddd	Reverb Parameter 16	(12768 - 52768) -20000 - +20000
#	00 47	0000 aaaa 0000 bbbb 0000 cccc 0000 dddd	Reverb Parameter 17	(12768 - 52768) -20000 - +20000
#	00 4B	0000 aaaa 0000 bbbb 0000 cccc 0000 dddd	Reverb Parameter 18	(12768 - 52768) -20000 - +20000
#	00 4F	0000 aaaa 0000 bbbb 0000 cccc 0000 dddd	Reverb Parameter 19	(12768 - 52768) -20000 - +20000
#	00 53	0000 aaaa 0000 bbbb 0000 cccc 0000 dddd	Reverb Parameter 20	(12768 - 52768) -20000 - +20000
	00 00 00 53	Total Size		

01-4-1-5 Patch TMT (Tone Mix Table)

Offset	Address	Description	
00 00	0000 aaaa	Structure Type 1 & 2	(0 - 9) 1 - 10
00 01	0000 00aa	Booster 1 & 2	(0 - 3) 0, +6, +12, +18 [dB]
00 02	0000 aaaa	Structure Type 3 & 4	(0 - 9) 1 - 10
00 03	0000 00aa	Booster 3 & 4	(0 - 3) 0, +6, +12, +18 [dB]
00 04	0000 00aa	TMT Velocity Control	(0 - 2) OFF, ON, RANDOM
00 05	0000 000a	TMT1 Tone Switch	(0 - 1) OFF, ON
00 06	0aaa aaaa	TMT1 Keyboard Range Lower	(0 - 127) C-1 - UPPER
00 07	0aaa aaaa	TMT1 Keyboard Range Upper	(0 - 127) LOWER - G9
00 08	0aaa aaaa	TMT1 Keyboard Fade Width Lower	(0 - 127)
00 09	0aaa aaaa	TMT1 Keyboard Fade Width Upper	(0 - 127)
00 0A	0aaa aaaa	TMT1 Velocity Range Lower	(1 - 127) 1 - UPPER
00 0B	0aaa aaaa	TMT1 Velocity Range Upper	(1 - 127) LOWER - 127
00 0C	0aaa aaaa	TMT1 Velocity Fade Width Lower	(0 - 127)
00 0D	0aaa aaaa	TMT1 Velocity Fade Width Upper	(0 - 127)
00 0E	0000 000a	TMT2 Tone Switch	(0 - 1) OFF, ON

	00 0F	0aaa aaaa	TMT2 Keyboard Range Lower	(0 - 127) C-1 - UPPER
	00 10	0aaa aaaa	TMT2 Keyboard Range Upper	(0 - 127) LOWER - G9
	00 11	0aaa aaaa	TMT2 Keyboard Fade Width Lower	(0 - 127)
	00 12	0aaa aaaa	TMT2 Keyboard Fade Width Upper	(0 - 127)
	00 13	0aaa aaaa	TMT2 Velocity Range Lower	(1 - 127) 1 - UPPER
	00 14	0aaa aaaa	TMT2 Velocity Range Upper	(1 - 127) LOWER - 127
	00 15	0aaa aaaa	TMT2 Velocity Fade Width Lower	(0 - 127)
	00 16	0aaa aaaa	TMT2 Velocity Fade Width Upper	(0 - 127)
	00 17	0000 000a	TMT3 Tone Switch	(0 - 1) OFF, ON
	00 18	0aaa aaaa	TMT3 Keyboard Range Lower	(0 - 127) C-1 - UPPER
	00 19	0aaa aaaa	TMT3 Keyboard Range Upper	(0 - 127) LOWER - G9
	00 1A	0aaa aaaa	TMT3 Keyboard Fade Width Lower	(0 - 127)
	00 1B	0aaa aaaa	TMT3 Keyboard Fade Width Upper	(0 - 127)
	00 1C	0aaa aaaa	TMT3 Velocity Range Lower	(1 - 127) 1 - UPPER
	00 1D	0aaa aaaa	TMT3 Velocity Range Upper	(1 - 127) LOWER - 127
	00 1E	0aaa aaaa	TMT3 Velocity Fade Width Lower	(0 - 127)
	00 1F	0aaa aaaa	TMT3 Velocity Fade Width Upper	(0 - 127)
	00 20	0000 000a	TMT4 Tone Switch	(0 - 1) OFF, ON
	00 21	0aaa aaaa	TMT4 Keyboard Range Lower	(0 - 127) C-1 - UPPER
	00 22	0aaa aaaa	TMT4 Keyboard Range Upper	(0 - 127) LOWER - G9
	00 23	0aaa aaaa	TMT4 Keyboard Fade Width Lower	(0 - 127)
	00 24	0aaa aaaa	TMT4 Keyboard Fade Width Upper	(0 - 127)
	00 25	0aaa aaaa	TMT4 Velocity Range Lower	(1 - 127) 1 - UPPER
	00 26	0aaa aaaa	TMT4 Velocity Range Upper	(1 - 127) LOWER - 127
	00 27	0aaa aaaa	TMT4 Velocity Fade Width Lower	(0 - 127)
	00 28	0aaa aaaa	TMT4 Velocity Fade Width Upper	(0 - 127)
	00 00 00 29	Total Size		

01-4-1-6 Patch Tone

Offset	Address	Description	
00 00	0aaa aaaa	Tone Level	(0 - 127)
00 01	0aaa aaaa	Tone Coarse Tune	(16 - 112) -48 - +48
00 02	0aaa aaaa	Tone Fine Tune	(14 - 114) -50 - +50
00 03	000a aaaa	Tone Random Pitch Depth	(0 - 30) 0, 1, 2, 3, 4, 5, 6, 7, 8, 9, 10, 20, 30, 40, 50, 60, 70, 80, 90, 100, 200, 300, 400, 500, 600, 700, 800, 900, 1000, 1100,
00 04	0aaa aaaa	Tone Pan	(0 - 127) L64 - 63R
00 05	000a aaaa	Tone Pan Keyfollow	(54 - 74) -100 - +100
00 06	00aa aaaa	Tone Random Pan Depth	(0 - 63)
00 07	0aaa aaaa	Tone Alternate Pan Depth	(1 - 127) L63 - 63R
00 08	0000 000a	Tone Env Mode	(0 - 1) NO-SUS, SUSTAIN
00 09	0000 00aa	Tone Delay Mode	(0 - 3) NORMAL, HOLD, KEY-OFF-NORMAL, KEY-OFF-DECAY
# 00 0A	0000 aaaa 0000 bbbb	Tone Delay Time	(0 - 149) 0 - 127, MUSICAL-NOTES
00 0C	0aaa aaaa	Tone Dry Send Level	(0 - 127)
00 0D	0aaa aaaa	Tone Chorus Send Level (MFX)	(0 - 127)
00 0E	0aaa aaaa	Tone Reverb Send Level (MFX)	(0 - 127)
00 0F	0aaa aaaa	Tone Chorus Send Level (non MFX)	(0 - 127)
00 10	0aaa aaaa	Tone Reverb Send Level (non MFX)	(0 - 127)
00 11	0000 aaaa	Tone Output Assign	(0 - 12) MFX, A, B<*>, C<*>, D<*>, 1, 2, 3<*>, 4<*>, 5<*>, 6<*>, 7<*>, 8<*>
00 12	0000 000a	Tone Receive Bender	(0 - 1) OFF, ON
00 13	0000 000a	Tone Receive Expression	(0 - 1) OFF, ON
00 14	0000 000a	Tone Receive Hold-1	(0 - 1) OFF, ON
00 15	0000 000a	Tone Receive Pan Mode	(0 - 1) CONTINUOUS, KEY-ON
00 16	0000 000a	Tone Redamper Switch	(0 - 1) OFF, ON
00 17	0000 00aa	Tone Control 1 Switch 1	(0 - 2)
00 18	0000 00aa	Tone Control 1 Switch 2	OFF, ON, REVERSE (0 - 2)
00 19	0000 00aa	Tone Control 1 Switch 3	OFF, ON, REVERSE (0 - 2)
00 1A	0000 00aa	Tone Control 1 Switch 4	OFF, ON, REVERSE (0 - 2)
00 1B	0000 00aa	Tone Control 2 Switch 1	OFF, ON, REVERSE (0 - 2)
00 1C	0000 00aa	Tone Control 2 Switch 2	OFF, ON, REVERSE (0 - 2)
00 1D	0000 00aa	Tone Control 2 Switch 3	OFF, ON, REVERSE (0 - 2)
00 1E	0000 00aa	Tone Control 2 Switch 4	OFF, ON, REVERSE (0 - 2)
00 1F	0000 00aa	Tone Control 3 Switch 1	OFF, ON, REVERSE (0 - 2)
00 20	0000 00aa	Tone Control 3 Switch 2	OFF, ON, REVERSE (0 - 2)
00 21	0000 00aa	Tone Control 3 Switch 3	OFF, ON, REVERSE (0 - 2)
00 22	0000 00aa	Tone Control 3 Switch 4	OFF, ON, REVERSE (0 - 2)
00 23	0000 00aa	Tone Control 4 Switch 1	OFF, ON, REVERSE (0 - 2)
00 24	0000 00aa	Tone Control 4 Switch 2	OFF, ON, REVERSE (0 - 2)
00 25	0000 00aa	Tone Control 4 Switch 3	OFF, ON, REVERSE (0 - 2)
00 26	0000 00aa	Tone Control 4 Switch 4	OFF, ON, REVERSE (0 - 2)
00 27	0000 00aa	Wave Group Type	(0 - 3) INT, SR-JV80, SRX, SAMPLE<*>
# 00 28	0000 aaaa 0000 bbbb 0000 cccc		

MIDI Implementation

	0000	bbbb		
	0000	cccc		
	0000	dddd	MFX Parameter 5	(12768 - 52768) -20000 - +20000
#	00 25	0000 0000 0000 0000	MFX Parameter 6	(12768 - 52768) -20000 - +20000
#	00 29	0000 0000 0000 0000	MFX Parameter 7	(12768 - 52768) -20000 - +20000
#	00 2D	0000 0000 0000 0000	MFX Parameter 8	(12768 - 52768) -20000 - +20000
#	00 31	0000 0000 0000 0000	MFX Parameter 9	(12768 - 52768) -20000 - +20000
#	00 35	0000 0000 0000 0000	MFX Parameter 10	(12768 - 52768) -20000 - +20000
#	00 39	0000 0000 0000 0000	MFX Parameter 11	(12768 - 52768) -20000 - +20000
#	00 3D	0000 0000 0000 0000	MFX Parameter 12	(12768 - 52768) -20000 - +20000
#	00 41	0000 0000 0000 0000	MFX Parameter 13	(12768 - 52768) -20000 - +20000
#	00 45	0000 0000 0000 0000	MFX Parameter 14	(12768 - 52768) -20000 - +20000
#	00 49	0000 0000 0000 0000	MFX Parameter 15	(12768 - 52768) -20000 - +20000
#	00 4D	0000 0000 0000 0000	MFX Parameter 16	(12768 - 52768) -20000 - +20000
#	00 51	0000 0000 0000 0000	MFX Parameter 17	(12768 - 52768) -20000 - +20000
#	00 55	0000 0000 0000 0000	MFX Parameter 18	(12768 - 52768) -20000 - +20000
#	00 59	0000 0000 0000 0000	MFX Parameter 19	(12768 - 52768) -20000 - +20000
#	00 5D	0000 0000 0000 0000	MFX Parameter 20	(12768 - 52768) -20000 - +20000
#	00 61	0000 0000 0000 0000	MFX Parameter 21	(12768 - 52768) -20000 - +20000
#	00 65	0000 0000 0000 0000	MFX Parameter 22	(12768 - 52768) -20000 - +20000
#	00 69	0000 0000 0000 0000	MFX Parameter 23	(12768 - 52768) -20000 - +20000
#	00 6D	0000 0000 0000 0000	MFX Parameter 24	(12768 - 52768) -20000 - +20000
#	00 71	0000 0000 0000 0000	MFX Parameter 25	(12768 - 52768) -20000 - +20000
#	00 75	0000 0000 0000 0000	MFX Parameter 26	(12768 - 52768) -20000 - +20000
#	00 79	0000 0000 0000 0000	MFX Parameter 27	(12768 - 52768) -20000 - +20000
#	00 7D	0000 0000 0000 0000	MFX Parameter 28	(12768 - 52768) -20000 - +20000
#	01 01	0000 0000 0000 0000	MFX Parameter 29	(12768 - 52768) -20000 - +20000
#	01 05	0000 0000 0000 0000	MFX Parameter 30	(12768 - 52768) -20000 - +20000
#	01 09	0000 0000 0000 0000	MFX Parameter 31	(12768 - 52768) -20000 - +20000
#	01 0D	0000 0000 0000 0000	MFX Parameter 32	(12768 - 52768)

				-20000 - +20000
00	00	01	11	Total Size

01-4-2-3 Rhythm Common Chorus

Offset	Address	Description		
	00 00	0000	aaaa	Chorus Type (0 - 1) OFF, CHORUS
	00 01	0aaa	aaaa	Chorus Level (0 - 127)
	00 02	0000	00aa	Chorus Output Assign (0 - 3) A, B<*>, C<*>, D<*>
	00 03	0000	00aa	Chorus Output Select (0 - 2) MAIN, REV, MAIN+REV
#	00 04	0000	aaaa	Chorus Parameter 1 (12768 - 52768) -20000 - +20000
		0000	bbbb	
		0000	dddd	
#	00 08	0000	aaaa	Chorus Parameter 2 (12768 - 52768) -20000 - +20000
		0000	bbbb	
		0000	cccc	
#	00 0C	0000	aaaa	Chorus Parameter 3 (12768 - 52768) -20000 - +20000
		0000	bbbb	
		0000	cccc	
#	00 10	0000	aaaa	Chorus Parameter 4 (12768 - 52768) -20000 - +20000
		0000	bbbb	
		0000	cccc	
#	00 14	0000	aaaa	Chorus Parameter 5 (12768 - 52768) -20000 - +20000
		0000	bbbb	
		0000	cccc	
#	00 18	0000	aaaa	Chorus Parameter 6 (12768 - 52768) -20000 - +20000
		0000	bbbb	
		0000	cccc	
#	00 1C	0000	aaaa	Chorus Parameter 7 (12768 - 52768) -20000 - +20000
		0000	bbbb	
		0000	cccc	
#	00 20	0000	aaaa	Chorus Parameter 8 (12768 - 52768) -20000 - +20000
		0000	bbbb	
		0000	cccc	
#	00 24	0000	aaaa	Chorus Parameter 9 (12768 - 52768) -20000 - +20000
		0000	bbbb	
		0000	cccc	
#	00 28	0000	aaaa	Chorus Parameter 10 (12768 - 52768) -20000 - +20000
		0000	bbbb	
		0000	cccc	
#	00 2C	0000	aaaa	Chorus Parameter 11 (12768 - 52768) -20000 - +20000
		0000	bbbb	
		0000	cccc	
#	00 30	0000	aaaa	Chorus Parameter 12 (12768 - 52768) -20000 - +20000
		0000	bbbb	
		0000	cccc	
	00 00	00	34	Total Size

01-4-2-4 Rhythm Common Reverb

Offset	Address	Description		
	00 00	0000	aaaa	Reverb Type (0 - 1) OFF, REVERB
	00 01	0aaa	aaaa	Reverb Level (0 - 127)
	00 02	0000	00aa	Reverb Output Assign (0 - 3) A, B<*>, C<*>, D<*>
#	00 03	0000	aaaa	Reverb Parameter 1 (12768 - 52768) -20000 - +20000
		0000	bbbb	
		0000	dddd	
#	00 07	0000	aaaa	Reverb Parameter 2 (12768 - 52768) -20000 - +20000
		0000	bbbb	
		0000	cccc	
#	00 0B	0000	aaaa	Reverb Parameter 3 (12768 - 52768) -20000 - +20000
		0000	bbbb	
		0000	cccc	
#	00 0F	0000	aaaa	Reverb Parameter 4 (12768 - 52768) -20000 - +20000
		0000	bbbb	
		0000	cccc	
#	00 13	0000	aaaa	Reverb Parameter 5 (12768 - 52768) -20000 - +20000
		0000	bbbb	
		0000	cccc	
#	00 17	0000	aaaa	Reverb Parameter 6 (12768 - 52768) -20000 - +20000
		0000	bbbb	
		0000	cccc	
#	00 1B	0000	aaaa	Reverb Parameter 7 (12768 - 52768) -20000 - +20000
		0000	bbbb	
		0000	cccc	
#	00 1F	0000	aaaa	Reverb Parameter 8 (12768 - 52768) -20000 - +20000
		0000	bbbb	
		0000	cccc	
	00	00	23	Total Size

#	00 27	0000 cccc 0000 dddd	Reverb Parameter 9	(12768 - 52768) -20000 - +20000
#	00 2B	0000 aaaa 0000 bbbb 0000 cccc 0000 dddd	Reverb Parameter 10	(12768 - 52768) -20000 - +20000
#	00 2F	0000 aaaa 0000 bbbb 0000 cccc 0000 dddd	Reverb Parameter 11	(12768 - 52768) -20000 - +20000
#	00 33	0000 aaaa 0000 bbbb 0000 cccc 0000 dddd	Reverb Parameter 12	(12768 - 52768) -20000 - +20000
#	00 37	0000 aaaa 0000 bbbb 0000 cccc 0000 dddd	Reverb Parameter 13	(12768 - 52768) -20000 - +20000
#	00 3B	0000 aaaa 0000 bbbb 0000 cccc 0000 dddd	Reverb Parameter 14	(12768 - 52768) -20000 - +20000
#	00 3F	0000 aaaa 0000 bbbb 0000 cccc 0000 dddd	Reverb Parameter 15	(12768 - 52768) -20000 - +20000
#	00 43	0000 aaaa 0000 bbbb 0000 cccc 0000 dddd	Reverb Parameter 16	(12768 - 52768) -20000 - +20000
#	00 47	0000 aaaa 0000 bbbb 0000 cccc 0000 dddd	Reverb Parameter 17	(12768 - 52768) -20000 - +20000
#	00 4B	0000 aaaa 0000 bbbb 0000 cccc 0000 dddd	Reverb Parameter 18	(12768 - 52768) -20000 - +20000
#	00 4F	0000 aaaa 0000 bbbb 0000 cccc 0000 dddd	Reverb Parameter 19	(12768 - 52768) -20000 - +20000
	00 00 00 53		Reverb Parameter 20	(12768 - 52768) -20000 - +20000
	00 00 00 53	Total Size		

01-4-2-5 Rhythm Tone

Offset	Address	Description	
00 00	0aaa aaaa	Tone Name 1	(32 - 127) 32 - 127 [ASCII]
00 01	0aaa aaaa	Tone Name 2	(32 - 127) 32 - 127 [ASCII]
00 02	0aaa aaaa	Tone Name 3	(32 - 127) 32 - 127 [ASCII]
00 03	0aaa aaaa	Tone Name 4	(32 - 127) 32 - 127 [ASCII]
00 04	0aaa aaaa	Tone Name 5	(32 - 127) 32 - 127 [ASCII]
00 05	0aaa aaaa	Tone Name 6	(32 - 127) 32 - 127 [ASCII]
00 06	0aaa aaaa	Tone Name 7	(32 - 127) 32 - 127 [ASCII]
00 07	0aaa aaaa	Tone Name 8	(32 - 127) 32 - 127 [ASCII]
00 08	0aaa aaaa	Tone Name 9	(32 - 127) 32 - 127 [ASCII]
00 09	0aaa aaaa	Tone Name 10	(32 - 127) 32 - 127 [ASCII]
00 0A	0aaa aaaa	Tone Name 11	(32 - 127) 32 - 127 [ASCII]
00 0B	0aaa aaaa	Tone Name 12	(32 - 127) 32 - 127 [ASCII]
00 0C	0000 000a	Assign Type	(0 - 1) MULTI, SINGLE
00 0D	000a aaaa	Mute Group	(0 - 31) OFF, 1 - 31
00 0E	0aaa aaaa	Tone Level	(0 - 127)
00 0F	0aaa aaaa	Tone Coarse Tune	(0 - 127)
00 10	0aaa aaaa	Tone Fine Tune	C-1 - G9 (14 - 114)
00 11	000a aaaa	Tone Random Pitch Depth	(0 - 30) 0, 1, 2, 3, 4, 5, 6, 7, 8, 9, 10, 20, 30, 40, 50, 60, 70, 80, 90, 100, 200, 300, 400, 500, 600, 700, 800, 900, 1000, 1100, 1200
00 12	0aaa aaaa	Tone Pan	(0 - 127) L64 - 63R
00 13	00aa aaaa	Tone Random Pan Depth	(0 - 63)
00 14	0aaa aaaa	Tone Alternate Pan Depth	(1 - 127)
00 15	0000 000a	Tone Env Mode	(0 - 1) NO-SUS, SUSTAIN
00 16	0aaa aaaa	Tone Dry Send Level	(0 - 127)
00 17	0aaa aaaa	Tone Chorus Send Level	(0 - 127)
00 18	0aaa aaaa	Tone Reverb Send Level	(0 - 127)
00 19	0aaa aaaa	Tone Chorus Send Level (non MFX)	(0 - 127)
00 1A	0aaa aaaa	Tone Reverb Send Level (non MFX)	(0 - 127)
00 1B	0000 aaaa	Tone Output Assign	(0 - 12) MFX, A, B<*>, C<*>, D<*> 1, 2, 3<*>, 4<*>, 5<*>, 6<*>, 7<*>, 8<*>
00 1C	00aa aaaa	Tone Pitch Bend Range	(0 - 48)
00 1D	0000 000a	Tone Receive Expression	(0 - 1) OFF, ON
00 1E	0000 000a	Tone Receive Hold-1	(0 - 1) OFF, ON
00 1F	0000 000a	Tone Receive Pan Mode	(0 - 1) CONTINUOUS, KEY-ON
00 20	0000 00aa	WMT Velocity Control	(0 - 2) OFF, ON, RANDOM

#	00 21	0000 000a	WMT1 Wave Switch	(0 - 1) OFF, ON
#	00 22	0000 00aa	WMT1 Wave Group Type	(0 - 3) INT, SR-JV80, SRX, SAMPLE<*>
#	00 23	0000 aaaa 0000 bbbb 0000 cccc 0000 dddd	WMT1 Wave Group ID	(0 - 16384) OFF, 1 - 16384
#	00 27	0000 aaaa 0000 bbbb 0000 cccc 0000 dddd	WMT1 Wave Number L (Mono)	(0 - 16384) OFF, 1 - 16384
#	00 2B	0000 aaaa 0000 bbbb 0000 cccc 0000 dddd	WMT1 Wave Number R	(0 - 16384) OFF, 1 - 16384
	00 2F	0000 00aa	WMT1 Wave Gain	(0 - 3) -6, 0, +6, +12 [dB]
	00 30	0000 000a	WMT1 Wave FXM Switch	(0 - 1) OFF, ON
	00 31	0000 00aa	WMT1 Wave FXM Color	(0 - 3) 1 - 4
	00 32	000a aaaa	WMT1 Wave FXM Depth	(0 - 16)
	00 33	0000 000a	WMT1 Wave Tempo Sync	(0 - 1) OFF, ON
	00 34	0aaa aaaa	WMT1 Wave Coarse Tune	(16 - 112) -48 - +48
	00 35	0aaa aaaa	WMT1 Wave Fine Tune	(14 - 114) -50 - +50
	00 36	0aaa aaaa	WMT1 Wave Pan	(0 - 127) L64 - 63R
	00 37	0000 000a	WMT1 Wave Random Pan Switch	(0 - 1) OFF, ON
	00 38	0000 00aa	WMT1 Wave Alternate Pan Switch	(0 - 2) OFF, ON, REVERSE
	00 39	0aaa aaaa	WMT1 Wave Level	(0 - 127)
	00 3A	0aaa aaaa	WMT1 Velocity Range Lower	(1 - 127) 1 - UPPER
	00 3B	0aaa aaaa	WMT1 Velocity Range Upper	(1 - 127) LOWER - 127
	00 3C	0aaa aaaa	WMT1 Velocity Fade Width Lower	(0 - 127)
	00 3D	0aaa aaaa	WMT1 Velocity Fade Width Upper	(0 - 127)
	00 3E	0000 000a	WMT2 Wave Switch	(0 - 1) OFF, ON
	00 3F	0000 00aa	WMT2 Wave Group Type	(0 - 3) INT, SR-JV80, SRX, SAMPLE<*>
#	00 40	0000 aaaa 0000 bbbb 0000 cccc 0000 dddd	WMT2 Wave Group ID	(0 - 16384) OFF, 1 - 16384
#	00 44	0000 aaaa 0000 bbbb 0000 cccc 0000 dddd	WMT2 Wave Number L (Mono)	(0 - 16384) OFF, 1 - 16384
#	00 48	0000 aaaa 0000 bbbb 0000 cccc 0000 dddd	WMT2 Wave Number R	(0 - 16384) OFF, 1 - 16384
	00 4C	0000 00aa	WMT2 Wave Gain	(0 - 3) -6, 0, +6, +12 [dB]
	00 4D	0000 000a	WMT2 Wave FXM Switch	(0 - 1) OFF, ON
	00 4E	0000 00aa	WMT2 Wave FXM Color	(0 - 3) 1 - 4
	00 4F	000a aaaa	WMT2 Wave FXM Depth	(0 - 16)
	00 50	0000 000a	WMT2 Wave Tempo Sync	(0 - 1) OFF, ON
	00 51	0aaa aaaa	WMT2 Wave Coarse Tune	(16 - 112) -48 - +48
	00 52	0aaa aaaa	WMT2 Wave Fine Tune	(14 - 114) -50 - +50
	00 53	0aaa aaaa	WMT2 Wave Pan	(0 - 127) L64 - 63R
	00 54	0000 000a	WMT2 Wave Random Pan Switch	(0 - 1) OFF, ON
	00 55	0000 00aa	WMT2 Wave Alternate Pan Switch	(0 - 2) OFF, ON, REVERSE
	00 56	0aaa aaaa	WMT2 Wave Level	(0 - 127)
	00 57	0aaa aaaa	WMT2 Velocity Range Lower	(1 - 127) 1 - UPPER
	00 58	0aaa aaaa	WMT2 Velocity Range Upper	(1 - 127) LOWER - 127
	00 59	0aaa aaaa	WMT2 Velocity Fade Width Lower	(0 - 127)
	00 5A	0aaa aaaa	WMT2 Velocity Fade Width Upper	(0 - 127)
	00 5B	0000 000a	WMT3 Wave Switch	(0 - 1) OFF, ON
	00 5C	0000 00aa	WMT3 Wave Group Type	(0 - 3) INT, SR-JV80, SRX, SAMPLE<*>
#	00 5D	0000 aaaa 0000 bbbb 0000 cccc 0000 dddd	WMT3 Wave Group ID	(0 - 16384) OFF, 1 - 16384
#	00 61	0000 aaaa 0000 bbbb 0000 cccc 0000 dddd	WMT3 Wave Number L (Mono)	(0 - 16384) OFF, 1 - 16384
#	00 65	0000 aaaa 0000 bbbb 0000 cccc 0000 dddd	WMT3 Wave Number R	(0 - 16384) OFF, 1 - 16384
	00 69	0000 00aa	WMT3 Wave Gain	(0 - 3) -6, 0, +6, +12 [dB]
	00 6A	0000 000a	WMT3 Wave FXM Switch	(0 - 1) OFF, ON
	00 6B	0000 00aa	WMT3 Wave FXM Color	(0 - 3) 1 - 4
	00 6C	000a aaaa	WMT3 Wave FXM Depth	(0 - 16)
	00 6D	0000 000a	WMT3 Wave Tempo Sync	(0 - 1) OFF, ON
	00 6E	0aaa aaaa	WMT3 Wave Coarse Tune	(16 - 112) -48 - +48
	00 6F	0aaa aaaa	WMT3 Wave Fine Tune	(14 - 114) -50 - +50
	00 70	0aaa aaaa	WMT3 Wave Pan	(0 - 127) L64 - 63R
	00 71	0000 000a	WMT3 Wave Random Pan Switch	(0 - 1) OFF, ON
	00 72	0000 00aa	WMT3 Wave Alternate Pan Switch	(0 - 2) OFF, ON, REVERSE
	00 73	0aaa aaaa	WMT3 Wave Level	(0 - 127)
	00 74	0aaa aaaa	WMT3 Velocity Range Lower	(1 - 127) 1 - UPPER
	00 75	0aaa aaaa	WMT3 Velocity Range Upper	(1 - 127) LOWER - 127
	00 76	0aaa aaaa	WMT3 Velocity Fade Width Lower	(0 - 127)
	00 77	0aaa aaaa	WMT3 Velocity Fade Width Upper	(0 - 127)

MIDI Implementation

	00 78	0000 000a	WMT4 Wave Switch	(0 - 1) OFF, ON
	00 79	0000 00aa	WMT4 Wave Group Type	(0 - 3) INT, SR-JV80, SRX, SAMPLE<*>
#	00 7A	0000 aaaa 0000 bbbb 0000 cccc 0000 dddd	WMT4 Wave Group ID	(0 - 16384) OFF, 1 - 16384
#	00 7E	0000 aaaa 0000 bbbb 0000 cccc 0000 dddd	WMT4 Wave Number L (Mono)	(0 - 16384) OFF, 1 - 16384
#	01 02	0000 aaaa 0000 bbbb 0000 cccc 0000 dddd	WMT4 Wave Number R	(0 - 16384) OFF, 1 - 16384
	01 06	0000 00aa	WMT4 Wave Gain	(0 - 3) -6, 0, +6, +12 [dB]
	01 07	0000 000a	WMT4 Wave FXM Switch	(0 - 1) OFF, ON
	01 08	0000 00aa	WMT4 Wave FXM Color	(0 - 3) 1 - 4
	01 09	000a aaaa	WMT4 Wave FXM Depth	(0 - 16)
	01 0A	0000 000a	WMT4 Wave Tempo Sync	(0 - 1) OFF, ON
	01 0B	0aaa aaaa	WMT4 Wave Coarse Tune	(16 - 112) -48 - +48
	01 0C	0aaa aaaa	WMT4 Wave Fine Tune	(14 - 114) -50 - +50
	01 0D	0aaa aaaa	WMT4 Wave Pan	(0 - 127) L64 - 63R
	01 0E	0000 000a	WMT4 Wave Random Pan Switch	(0 - 1) OFF, ON
	01 0F	0000 00aa	WMT4 Wave Alternate Pan Switch	(0 - 2) OFF, ON, REVERSE
	01 10	0aaa aaaa	WMT4 Wave Level	(0 - 127)
	01 11	0aaa aaaa	WMT4 Velocity Range Lower	(1 - 127) 1 - UPPER
	01 12	0aaa aaaa	WMT4 Velocity Range Upper	(1 - 127) LOWER - 127
	01 13	0aaa aaaa	WMT4 Velocity Fade Width Lower	(0 - 127)
	01 14	0aaa aaaa	WMT4 Velocity Fade Width Upper	(0 - 127)
	01 15	000a aaaa	Pitch Env Depth	(52 - 76) -12 - +12
	01 16	0aaa aaaa	Pitch Env Velocity Sens	(1 - 127) -63 - +63
	01 17	0aaa aaaa	Pitch Env Time 1 Velocity Sens	(1 - 127) -63 - +63
	01 18	0aaa aaaa	Pitch Env Time 4 Velocity Sens	(1 - 127) -63 - +63
	01 19	0aaa aaaa	Pitch Env Time 1	(0 - 127)
	01 1A	0aaa aaaa	Pitch Env Time 2	(0 - 127)
	01 1B	0aaa aaaa	Pitch Env Time 3	(0 - 127)
	01 1C	0aaa aaaa	Pitch Env Time 4	(0 - 127)
	01 1D	0aaa aaaa	Pitch Env Level 0	(1 - 127) -63 - +63
	01 1E	0aaa aaaa	Pitch Env Level 1	(1 - 127) -63 - +63
	01 1F	0aaa aaaa	Pitch Env Level 2	(1 - 127) -63 - +63
	01 20	0aaa aaaa	Pitch Env Level 3	(1 - 127) -63 - +63
	01 21	0aaa aaaa	Pitch Env Level 4	(1 - 127) -63 - +63
	01 22	0000 0aaa	TVF Filter Type	(0 - 6) OFF, LPF, BPF, HPF, PKG, LFP2, LFP3
	01 23	0aaa aaaa	TVF Cutoff Frequency	(0 - 127)
	01 24	0000 0aaa	TVF Cutoff Velocity Curve	(0 - 7) FIXED, 1 - 7
	01 25	0aaa aaaa	TVF Cutoff Velocity Sens	(1 - 127) -63 - +63
	01 26	0aaa aaaa	TVF Resonance	(0 - 127)
	01 27	0aaa aaaa	TVF Resonance Velocity Sens	(1 - 127) -63 - +63
	01 28	0aaa aaaa	TVF Env Depth	(1 - 127) -63 - +63
	01 29	0000 0aaa	TVF Env Velocity Curve Type	(0 - 7) FIXED, 1 - 7
	01 2A	0aaa aaaa	TVF Env Velocity Sens	(1 - 127) -63 - +63
	01 2B	0aaa aaaa	TVF Env Time 1 Velocity Sens	(1 - 127) -63 - +63
	01 2C	0aaa aaaa	TVF Env Time 4 Velocity Sens	(1 - 127) -63 - +63
	01 2D	0aaa aaaa	TVF Env Time 1	(0 - 127)
	01 2E	0aaa aaaa	TVF Env Time 2	(0 - 127)
	01 2F	0aaa aaaa	TVF Env Time 3	(0 - 127)
	01 30	0aaa aaaa	TVF Env Time 4	(0 - 127)
	01 31	0aaa aaaa	TVF Env Level 0	(0 - 127)
	01 32	0aaa aaaa	TVF Env Level 1	(0 - 127)
	01 33	0aaa aaaa	TVF Env Level 2	(0 - 127)
	01 34	0aaa aaaa	TVF Env Level 3	(0 - 127)
	01 35	0aaa aaaa	TVF Env Level 4	(0 - 127)
	01 36	0000 0aaa	TVA Level Velocity Curve	(0 - 7) FIXED, 1 - 7
	01 37	0aaa aaaa	TVA Level Velocity Sens	(1 - 127) -63 - +63
	01 38	0aaa aaaa	TVA Env Time 1 Velocity Sens	(1 - 127) -63 - +63
	01 39	0aaa aaaa	TVA Env Time 4 Velocity Sens	(1 - 127) -63 - +63
	01 3A	0aaa aaaa	TVA Env Time 1	(0 - 127)
	01 3B	0aaa aaaa	TVA Env Time 2	(0 - 127)
	01 3C	0aaa aaaa	TVA Env Time 3	(0 - 127)
	01 3D	0aaa aaaa	TVA Env Time 4	(0 - 127)
	01 3E	0aaa aaaa	TVA Env Level 1	(0 - 127)
	01 3F	0aaa aaaa	TVA Env Level 2	(0 - 127)
	01 40	0aaa aaaa	TVA Env Level 3	(0 - 127)
	00 00 01 41	Total Size		

2. GS (Model ID = 42H)

System Parameter

Start	Address	Description	
#	40 00 00	0000 aaaa 0000 bbbb 0000 cccc 0000 dddd	Master Tune -100.0 - 100.0 [cent]
	40 00 04	0aaa aaaa	Master Volume (0 - 127)
	40 00 05	0aaa aaaa	Master Key Shift (40 - 88)
	40 00 06	0aaa aaaa	Master Pan -24 - +24 [semitone] (1 - 127) L63 - 63R
	40 00 7F	0aaa aaaa	Mode Set (0, 127) GS-RESET, GS-EXIT

Common Parameter

Start	Address	Description	
	40 01 10	0aaa aaaa	Voice Reserve 1 (0 - 24)
	40 01 11	0aaa aaaa	Voice Reserve 2 (0 - 24)
	40 01 12	0aaa aaaa	Voice Reserve 3 (0 - 24)
	40 01 13	0aaa aaaa	Voice Reserve 4 (0 - 24)
	40 01 14	0aaa aaaa	Voice Reserve 5 (0 - 24)
	40 01 15	0aaa aaaa	Voice Reserve 6 (0 - 24)
	40 01 16	0aaa aaaa	Voice Reserve 7 (0 - 24)
	40 01 17	0aaa aaaa	Voice Reserve 8 (0 - 24)
	40 01 18	0aaa aaaa	Voice Reserve 9 (0 - 24)
	40 01 19	0aaa aaaa	Voice Reserve 10 (0 - 24)
	40 01 1A	0aaa aaaa	Voice Reserve 11 (0 - 24)
	40 01 1B	0aaa aaaa	Voice Reserve 12 (0 - 24)
	40 01 1C	0aaa aaaa	Voice Reserve 13 (0 - 24)
	40 01 1D	0aaa aaaa	Voice Reserve 14 (0 - 24)
	40 01 1E	0aaa aaaa	Voice Reserve 15 (0 - 24)
	40 01 1F	0aaa aaaa	Voice Reserve 16 (0 - 24)
	40 01 30	0aaa aaaa	Reverb Macro (0 - 7)
	40 01 31	0aaa aaaa	Reverb Character (0 - 7)
	40 01 32	0aaa aaaa	Reverb Pre-LPF (0 - 7)
	40 01 33	0aaa aaaa	Reverb Level (0 - 127)
	40 01 34	0aaa aaaa	Reverb Time (0 - 127)
	40 01 35	0aaa aaaa	Reverb Delay Feedback (0 - 127)
	40 01 36	0aaa aaaa	Reverb Send Level to Chorus<*> (0 - 127)
	40 01 38	0aaa aaaa	Chorus Macro (0 - 7)
	40 01 39	0aaa aaaa	Chorus Pre-LPF (0 - 7)
	40 01 3A	0aaa aaaa	Chorus Level (0 - 127)
	40 01 3B	0aaa aaaa	Chorus Feedback (0 - 127)
	40 01 3C	0aaa aaaa	Chorus Delay (0 - 127)
	40 01 3D	0aaa aaaa	Chorus Rate (0 - 127)
	40 01 3E	0aaa aaaa	Chorus Depth (0 - 127)
	40 01 3F	0aaa aaaa	Chorus Send Level to Reverb (0 - 127)

Part Parameter

Start	Address	Description	
#	40 1x 00	0aaa aaaa 0aaa aaaa	Tone Number CCH00 Value (0 - 127) Tone Number PC Value (0 - 127)
	40 1x 02	0aaa aaaa	Rx. Channel (0 - 16)
	40 1x 03	0000 000a	Rx. Pitch Bend 1 - 16, OFF (0 - 1) OFF, ON
	40 1x 04	0000 000a	Rx. Channel Pressure (0 - 1) OFF, ON
	40 1x 05	0000 000a	Rx. Program Change (0 - 1) OFF, ON
	40 1x 06	0000 000a	Rx. Control Change (0 - 1) OFF, ON
	40 1x 07	0000 000a	Rx. Poly Pressure (0 - 1) OFF, ON
	40 1x 08	0000 000a	Rx. Note Message (0 - 1) OFF, ON
	40 1x 09	0000 000a	Rx. RPN (0 - 1) OFF, ON
	40 1x 0A	0000 000a	Rx. NRPN (0 - 1) OFF, ON
	40 1x 0B	0000 000a	Rx. Modulation (0 - 1) OFF, ON
	40 1x 0C	0000 000a	Rx. Volume (0 - 1) OFF, ON
	40 1x 0D	0000 000a	Rx. Panpot (0 - 1) OFF, ON
	40 1x 0E	0000 000a	Rx. Expression (0 - 1) OFF, ON
	40 1x 0F	0000 000a	Rx. Hold-1 (0 - 1) OFF, ON
	40 1x 10	0000 000a	Rx. Portamento (0 - 1) OFF, ON
	40 1x 11	0000 000a	Rx. Sostenuato (0 - 1) OFF, ON
	40 1x 12	0000 000a	Rx. Soft (0 - 1) OFF, ON
	40 1x 13	0aaa aaaa	Mono / Poly Mode (0 - 1) MODE, POLY
	40 1x 14	0aaa aaaa	Assign Mode<*> (0 - 2) SINGLE, LIMITED-MULTI, FULL-MULTI
	40 1x 15	0aaa aaaa	Use for Rhythm Part (0 - 2) OFF, MAP1, MAP2
	40 1x 16	0aaa aaaa	Pitch Key Shift (40 - 88) -24 - +24 [semitone]
#	40 1x 17	0000 aaaa 0000 bbbb	Pitch Offset Fine (8 - 248)
	40 1x 19	0aaa aaaa	Part Level (CC# 7) -12.0 - +12.0 [Hz] (0 - 127)
	40 1x 1A	0aaa aaaa	Velocity Sens Depth (0 - 127) -64 - +63
	40 1x 1B	0aaa aaaa	Velocity Sens Offset (0 - 127) -64 - +63
	40 1x 1C	0aaa aaaa	Part Panpot (CC# 10) (0 - 127) RANDOM, L63 - 63R
	40 1x 1D	0aaa aaaa	Keyboard Range Low (0 - 127)
	40 1x 1E	0aaa aaaa	Keyboard Range High (0 - 127)
	40 1x 1F	0aaa aaaa	CC1 Controller Number (0 - 95)
	40 1x 20	0aaa aaaa	CC2 Controller Number (0 - 95)
	40 1x 21	0aaa aaaa	Chorus Send Level (CC# 93) (0 - 127)
	40 1x 22	0aaa aaaa	Reverb Send Level (CC# 93) (0 - 127)

40 1x 23	0000 000a	Rx. Bank Select<*>	(0 - 1) OFF, ON
40 1x 24	0000 000a	Rx. Bank Select LSB<*>	(0 - 1) OFF, ON
40 1x 30	0aaa aaaa	Tone Modify 1 (Vibrato Rate)	(0 - 127) -64 +63
40 1x 31	0aaa aaaa	Tone Modify 2 (Vibrato Depth)	(0 - 127) -64 +63
40 1x 32	0aaa aaaa	Tone Modify 3 (TVF Cutoff Freq.)	(0 - 127) -64 +63
40 1x 33	0aaa aaaa	Tone Modify 4 (TVF Resonance)	(0 - 127) -64 +63
40 1x 34	0aaa aaaa	Tone Modify 5 (TVF&TVA Env. Attack)	(0 - 127) -64 +63
40 1x 35	0aaa aaaa	Tone Modify 6 (TVF&TVA Env. Decay)	(0 - 127) -64 +63
40 1x 36	0aaa aaaa	Tone Modify 7 (TVF&TVA Env. Release)	(0 - 127) -64 +63
40 1x 37	0aaa aaaa	Tone Modify 8 (Vibrato Delay)	(0 - 127) -64 +63
40 1x 40	0aaa aaaa	Scale Tuning C	(0 - 127) -64 +63 [cent]
40 1x 41	0aaa aaaa	Scale Tuning C#	(0 - 127) -64 +63 [cent]
40 1x 42	0aaa aaaa	Scale Tuning D	(0 - 127) -64 +63 [cent]
40 1x 43	0aaa aaaa	Scale Tuning D#	(0 - 127) -64 +63 [cent]
40 1x 44	0aaa aaaa	Scale Tuning E	(0 - 127) -64 +63 [cent]
40 1x 45	0aaa aaaa	Scale Tuning F	(0 - 127) -64 +63 [cent]
40 1x 46	0aaa aaaa	Scale Tuning F#	(0 - 127) -64 +63 [cent]
40 1x 47	0aaa aaaa	Scale Tuning G	(0 - 127) -64 +63 [cent]
40 1x 48	0aaa aaaa	Scale Tuning G#	(0 - 127) -64 +63 [cent]
40 1x 49	0aaa aaaa	Scale Tuning A	(0 - 127) -64 +63 [cent]
40 1x 4A	0aaa aaaa	Scale Tuning A#	(0 - 127) -64 +63 [cent]
40 1x 4B	0aaa aaaa	Scale Tuning B	(0 - 127) -64 +63 [cent]
40 2x 00	0aaa aaaa	Mod Pitch Control	(40 - 88) -24 +24 [semitone]
40 2x 01	0aaa aaaa	Mod TVF Cutoff Control	(0 - 127) -9600 +9600 [cent]
40 2x 02	0aaa aaaa	Mod Amplitude Control	(0 - 127) -100.0 +100.0 [%]
40 2x 03	0aaa aaaa	Mod LFO1 Rate Control	(0 - 127) -10.0 +10.0 [Hz]
40 2x 04	0aaa aaaa	Mod LFO1 Pitch Control	(0 - 127) 0 - 600 [cent]
40 2x 05	0aaa aaaa	Mod LFO1 TVF Depth	(0 - 127) 0 - 2400 [cent]
40 2x 06	0aaa aaaa	Mod LFO1 TVA Depth	(0 - 127) 0 - 100.0 [%]
40 2x 07	0aaa aaaa	Mod LFO2 Rate Control	(0 - 127) -10.0 +10.0 [Hz]
40 2x 08	0aaa aaaa	Mod LFO2 Pitch Control	(0 - 127) 0 - 600 [cent]
40 2x 09	0aaa aaaa	Mod LFO2 TVF Depth	(0 - 127) 0 - 2400 [cent]
40 2x 0A	0aaa aaaa	Mod LFO2 TVA Depth	(0 - 127) 0 - 100.0 [%]
40 2x 10	0aaa aaaa	Bend Pitch Control	(64 - 88) 0 - 24 [semitone]
40 2x 11	0aaa aaaa	Bend TVF Cutoff Control	(0 - 127) -9600 +9600 [cent]
40 2x 12	0aaa aaaa	Bend Amplitude Control	(0 - 127) -100.0 +100.0 [%]
40 2x 13	0aaa aaaa	Bend LFO1 Rate Control	(0 - 127) -10.0 +10.0 [Hz]
40 2x 14	0aaa aaaa	Bend LFO1 Pitch Control	(0 - 127) 0 - 600 [cent]
40 2x 15	0aaa aaaa	Bend LFO1 TVF Depth	(0 - 127) 0 - 2400 [cent]
40 2x 16	0aaa aaaa	Bend LFO1 TVA Depth	(0 - 127) 0 - 100.0 [%]
40 2x 17	0aaa aaaa	Bend LFO2 Rate Control	(0 - 127) -10.0 +10.0 [Hz]
40 2x 18	0aaa aaaa	Bend LFO2 Pitch Control	(0 - 127) 0 - 600 [cent]
40 2x 19	0aaa aaaa	Bend LFO2 TVF Depth	(0 - 127) 0 - 2400 [cent]
40 2x 1A	0aaa aaaa	Bend LFO2 TVA Depth	(0 - 127) 0 - 100.0 [%]
40 2x 20	0aaa aaaa	CAF Pitch Control	(40 - 88) -24 +24 [semitone]
40 2x 21	0aaa aaaa	CAF TVF Cutoff Control	(0 - 127) -9600 +9600 [cent]
40 2x 22	0aaa aaaa	CAF Amplitude Control	(0 - 127) -100.0 +100.0 [%]
40 2x 23	0aaa aaaa	CAF LFO1 Rate Control	(0 - 127) -10.0 +10.0 [Hz]
40 2x 24	0aaa aaaa	CAF LFO1 Pitch Control	(0 - 127) 0 - 600 [cent]
40 2x 25	0aaa aaaa	CAF LFO1 TVF Depth	(0 - 127) 0 - 2400 [cent]
40 2x 26	0aaa aaaa	CAF LFO1 TVA Depth	(0 - 127) 0 - 100.0 [%]
40 2x 27	0aaa aaaa	CAF LFO2 Rate Control	(0 - 127) -10.0 +10.0 [Hz]
40 2x 28	0aaa aaaa	CAF LFO2 Pitch Control	(0 - 127) 0 - 600 [cent]
40 2x 29	0aaa aaaa	CAF LFO2 TVF Depth	(0 - 127) 0 - 2400 [cent]
40 2x 2A	0aaa aaaa	CAF LFO2 TVA Depth	(0 - 127) 0 - 100.0 [%]
40 2x 30	0aaa aaaa	PAF Pitch Control	(40 - 88) -24 +24 [semitone]
40 2x 31	0aaa aaaa	PAF TVF Cutoff Control	(0 - 127) -9600 +9600 [cent]
40 2x 32	0aaa aaaa	PAF Amplitude Control	(0 - 127) -100.0 +100.0 [%]
40 2x 33	0aaa aaaa	PAF LFO1 Rate Control	(0 - 127) -10.0 +10.0 [Hz]
40 2x 34	0aaa aaaa	PAF LFO1 Pitch Control	(0 - 127) 0 - 600 [cent]
40 2x 35	0aaa aaaa	PAF LFO1 TVF Depth	(0 - 127) 0 - 2400 [cent]
40 2x 36	0aaa aaaa	PAF LFO1 TVA Depth	(0 - 127) 0 - 100.0 [%]
40 2x 37	0aaa aaaa	PAF LFO2 Rate Control	(0 - 127) -10.0 +10.0 [Hz]
40 2x 38	0aaa aaaa	PAF LFO2 Pitch Control	(0 - 127) 0 - 600 [cent]
40 2x 39	0aaa aaaa	PAF LFO2 TVF Depth	(0 - 127) 0 - 2400 [cent]
40 2x 3A	0aaa aaaa	PAF LFO2 TVA Depth	(0 - 127) 0 - 100.0 [%]

40 2x 40	0aaa aaaa	CC1 Pitch Control	(40 - 88) -24 +24 [semitone]
40 2x 41	0aaa aaaa	CC1 TVF Cutoff Control	(0 - 127) -9600 +9600 [cent]
40 2x 42	0aaa aaaa	CC1 Amplitude Control	(0 - 127) -100.0 +100.0 [%]
40 2x 43	0aaa aaaa	CC1 LFO1 Rate Control	(0 - 127) -10.0 +10.0 [Hz]
40 2x 44	0aaa aaaa	CC1 LFO1 Pitch Control	(0 - 127) 0 - 600 [cent]
40 2x 45	0aaa aaaa	CC1 LFO1 TVF Depth	(0 - 127) 0 - 2400 [cent]
40 2x 46	0aaa aaaa	CC1 LFO1 TVA Depth	(0 - 127) 0 - 100.0 [%]
40 2x 47	0aaa aaaa	CC1 LFO2 Rate Control	(0 - 127) -10.0 +10.0 [Hz]
40 2x 48	0aaa aaaa	CC1 LFO2 Pitch Control	(0 - 127) 0 - 600 [cent]
40 2x 49	0aaa aaaa	CC1 LFO2 TVF Depth	(0 - 127) 0 - 2400 [cent]
40 2x 4A	0aaa aaaa	CC1 LFO2 TVA Depth	(0 - 127) 0 - 100.0 [%]
40 2x 50	0aaa aaaa	CC2 Pitch Control	(40 - 88) -24 +24 [semitone]
40 2x 51	0aaa aaaa	CC2 TVF Cutoff Control	(0 - 127) -9600 +9600 [cent]
40 2x 52	0aaa aaaa	CC2 Amplitude Control	(0 - 127) -100.0 +100.0 [%]
40 2x 53	0aaa aaaa	CC2 LFO1 Rate Control	(0 - 127) -10.0 +10.0 [Hz]
40 2x 54	0aaa aaaa	CC2 LFO1 Pitch Control	(0 - 127) 0 - 600 [cent]
40 2x 55	0aaa aaaa	CC2 LFO1 TVF Depth	(0 - 127) 0 - 2400 [cent]
40 2x 56	0aaa aaaa	CC2 LFO1 TVA Depth	(0 - 127) 0 - 100.0 [%]
40 2x 57	0aaa aaaa	CC2 LFO2 Rate Control	(0 - 127) -10.0 +10.0 [Hz]
40 2x 58	0aaa aaaa	CC2 LFO2 Pitch Control	(0 - 127) 0 - 600 [cent]
40 2x 59	0aaa aaaa	CC2 LFO2 TVF Depth	(0 - 127) 0 - 2400 [cent]
40 2x 5A	0aaa aaaa	CC2 LFO2 TVA Depth	(0 - 127) 0 - 100.0 [%]

x: BLOCK NUMBER (0-F)

Part 1 (MIDI ch = 1) x = 1

Part 2 (MIDI ch = 2) x = 2

:

Part 9 (MIDI ch = 9) x = 9

Part10 (MIDI ch = 10) x = 0

Part11 (MIDI ch = 11) x = A

Part12 (MIDI ch = 12) x = B

:

Part16 (MIDI ch = 16) x = F

Drum Setup Parameter

Start Address	Description	
41 m0 00	0aaa aaaa Drum Map Name 1	(32 - 127)
41 m0 01	0aaa aaaa Drum Map Name 2	32 - 127 [ASCII]
41 m0 02	0aaa aaaa Drum Map Name 3	(32 - 127)
41 m0 03	0aaa aaaa Drum Map Name 4	32 - 127 [ASCII]
41 m0 04	0aaa aaaa Drum Map Name 5	(32 - 127)
41 m0 05	0aaa aaaa Drum Map Name 6	32 - 127 [ASCII]
41 m0 06	0aaa aaaa Drum Map Name 7	(32 - 127)
41 m0 07	0aaa aaaa Drum Map Name 8	32 - 127 [ASCII]
41 m0 08	0aaa aaaa Drum Map Name 9	(32 - 127)
41 m0 09	0aaa aaaa Drum Map Name 10	32 - 127 [ASCII]
41 m0 0A	0aaa aaaa Drum Map Name 11	(32 - 127)
41 m0 0B	0aaa aaaa Drum Map Name 12	32 - 127 [ASCII]
41 m1 rr	0aaa aaaa Play Note Number	(0 - 127)
41 m2 rr	0aaa aaaa Level	(0 - 127)
41 m3 rr	0aaa aaaa Assign Group Number	(0 - 127)
41 m4 rr	0aaa aaaa Panpot	NON, 1 - 127
41 m5 rr	0aaa aaaa Reverb Send Level	RANDOM, L63 - 63R (0 - 127)
41 m6 rr	0aaa aaaa Chorus Send Level	0.0 - 1.0 (0 - 127)
41 m7 rr	0000 000a Rx. Note Off	(0 - 1) OFF, ON
41 m8 rr	0000 000a Rx. Note On	(0 - 1) OFF, ON

m: Map number (0 = MAP1, 1 = MAP2)

rr: drum part note number (00H-7FH)

MIDI Implementation

Decimal and Hexadecimal Table

(An "H" is appended to the end of numbers in hexadecimal notation.)
 In MIDI documentation, data values and addresses/sizes of Exclusive messages, etc. are expressed as hexadecimal values for each 7 bits.
 The following table shows how these correspond to decimal numbers.

D	H	D	H	D	H	D	H
0	00H	32	20H	64	40H	96	60H
1	01H	33	21H	65	41H	97	61H
2	02H	34	22H	66	42H	98	62H
3	03H	35	23H	67	43H	99	63H
4	04H	36	24H	68	44H	100	64H
5	05H	37	25H	69	45H	101	65H
6	06H	38	26H	70	46H	102	66H
7	07H	39	27H	71	47H	103	67H
8	08H	40	28H	72	48H	104	68H
9	09H	41	29H	73	49H	105	69H
10	0AH	42	2AH	74	4AH	106	6AH
11	0BH	43	2BH	75	4BH	107	6BH
12	0CH	44	2CH	76	4CH	108	6CH
13	0DH	45	2DH	77	4DH	109	6DH
14	0EH	46	2EH	78	4EH	110	6EH
15	0FH	47	2FH	79	4FH	111	6FH
16	10H	48	30H	80	50H	112	70H
17	11H	49	31H	81	51H	113	71H
18	12H	50	32H	82	52H	114	72H
19	13H	51	33H	83	53H	115	73H
20	14H	52	34H	84	54H	116	74H
21	15H	53	35H	85	55H	117	75H
22	16H	54	36H	86	56H	118	76H
23	17H	55	37H	87	57H	119	77H
24	18H	56	38H	88	58H	120	78H
25	19H	57	39H	89	59H	121	79H
26	1AH	58	3AH	90	5AH	122	7AH
27	1BH	59	3BH	91	5BH	123	7BH
28	1CH	60	3CH	92	5CH	124	7CH
29	1DH	61	3DH	93	5DH	125	7DH
30	1EH	62	3EH	94	5EH	126	7EH
31	1FH	63	3FH	95	5FH	127	7FH

D: decimal
 H: hexadecimal

- * Decimal values such as MIDI channel, bank select, and program change are listed as one greater than the values given in the above table.
- * A 7-bit byte can express data in the range of 128 steps. For data where greater precision is required, we must use two or more bytes. For example, two hexadecimal numbers aa bbH expressing two 7-bit bytes would indicate a value of aa x 128+bb.
- * In the case of values which have a +/- sign, 00H = -64, 40H = +/-0, and 7FH = +63, so that the decimal expression would be 64 less than the value given in the above chart. In the case of two types, 00 00H = -8192, 40 00H = +/-0, and 7F 7FH = +8191. For example, if aa bbH were expressed as decimal, this would be aa bbH - 40 00H = aa x 128+bb - 64 x 128.
- * Data marked "Use nibbled data" is expressed in hexadecimal in 4-bit units. A value expressed as a 2-byte nibble 0a 0bH has the value of a x 16+b.

<Example1> What is the decimal expression of 5AH?

From the preceding table, 5AH = 90

<Example2> What is the decimal expression of the value 12 34H given as hexadecimal for each 7 bits?

From the preceding table, since 12H = 18 and 34H = 52
 18 x 128+52 = 2356

<Example3> What is the decimal expression of the nibbled value 0A 03 09 0D?

From the preceding table, since 0AH = 10, 03H = 3, 09H = 9, 0DH = 13
 ((10 x 16+3) x 16+9) x 16+13 = 41885

<Example4> What is the nibbled expression of the decimal value 1258?

```

16 ) 1258
   78
   ---
    4
    0
    ---
    4
    
```

Since from the preceding table, 0 = 00H, 4 = 04H, 14 = 0EH, 10 = 0AH, the result is: 00 04 0E 0AH.

Examples of Actual MIDI Messages

<Example1> 92 3E 5F

9n is the Note-on status, and n is the MIDI channel number. Since 2H = 2, 3EH = 62, and 5FH = 95, this is a Note-on message with MIDI CH = 3, note number 62 (note name is D4), and velocity 95.

<Example2> CE 49

CnH is the Program Change status, and n is the MIDI channel number. Since EH = 14 and 49H = 73, this is a Program Change message with MIDI CH = 15, program number 74.

<Example3> EA 00 28

EnH is the Pitch Bend Change status, and n is the MIDI channel number. The 2nd byte (00H = 0) is the LSB and the 3rd byte (28H = 40) is the MSB, but Pitch Bend Value is a signed number in which 40 00H (= 64 x 12+80 = 8192) is 0, so this Pitch Bend Value is 28 00H - 40 00H = 40 x 12+80 - (64 x 12+80) = 5120 - 8192 = -3072

If the Pitch Bend Sensitivity is set to 2 semitones, -8192 (00 00H) will cause the pitch to change -200 cents, so in this case -200 x (-3072) (-8192) = -75 cents of Pitch Bend is being applied to MIDI channel 11.

<Example4> B3 64 00 65 00 06 0C 26 00 64 7F 65 7F

BnH is the Control Change status, and n is the MIDI channel number. For Control Changes, the 2nd byte is the control number, and the 3rd byte is the value. In a case in which two or more messages consecutive messages have the same status, MIDI has a provision called "running status" which allows the status byte of the second and following messages to be omitted. Thus, the above messages have the following meaning.

B3	64 00	MIDI ch.4, lower byte of RPN parameter number:	00H
(B3)	65 00	(MIDI ch.4) upper byte of RPN parameter number:	00H
(B3)	06 0C	(MIDI ch.4) upper byte of parameter value:	0CH
(B3)	26 00	(MIDI ch.4) lower byte of parameter value:	00H
(B3)	64 7F	(MIDI ch.4) lower byte of RPN parameter number:	7FH
(B3)	65 7F	(MIDI ch.4) upper byte of RPN parameter number:	7FH

In other words, the above messages specify a value of 0C 00H for RPN parameter number 00 00H on MIDI channel 4, and then set the RPN parameter number to 7F 7FH.

RPN parameter number 00 00H is Pitch Bend Sensitivity, and the MSB of the value indicates semitone units, so a value of 0CH = 12 sets the maximum pitch bend range to +/-12 semitones (1 octave). (On GS sound generators the LSB of Pitch Bend Sensitivity is ignored, but the LSB should be transmitted anyway (with a value of 0) so that operation will be correct on any device.)

Once the parameter number has been specified for RPN or NRPN, all Data Entry messages transmitted on that same channel will be valid, so after the desired value has been transmitted, it is a good idea to set the parameter number to 7F 7FH to prevent accidents. This is the reason for the (B3) 64 7F (B3) 65 7F at the end.

It is not desirable for performance data (such as Standard MIDI File data) to contain many events with running status as given in <Example 4>. This is because if playback is halted during the song and then rewound or fast-forwarded, the sequencer may not be able to transmit the correct status, and the sound generator will then misinterpret the data. Take care to give each event its own status.

It is also necessary that the RPN or NRPN parameter number setting and the value setting be done in the proper order. On some sequencers, events occurring in the same (or consecutive) clock may be transmitted in an order different than the order in which they were received. For this reason it is a good idea to slightly skew the time of each event (about 1 tick for TPQN = 96, and about 5 ticks for TPQN = 480).

* TPQN: Ticks Per Quarter Note

■ Example of an Exclusive Message and Calculating a Checksum

Roland Exclusive messages (RQ1, DT1) are transmitted with a checksum at the end (before F7) to make sure that the message was correctly received. The value of the checksum is determined by the address and data (or size) of the transmitted Exclusive message.

● How to calculate the checksum

(hexadecimal numbers are indicated by "H")

The checksum is a value derived by adding the address, size, and checksum itself and inverting the lower 7 bits.

Here's an example of how the checksum is calculated. We will assume that in the Exclusive message we are transmitting, the address is aa bb cc ddH and the data or size is ee ffH.

$$\begin{aligned} &aa + bb + cc + dd + ee + ff = \text{sum} \\ \text{sum } 128 &= \text{quotient} \dots \text{remainder} \\ 128 - \text{remainder} &= \text{checksum} \end{aligned}$$

<Example1> Setting MFX Type of Performance Common MFX to OVERDRIVE (DT1)

According to the "Parameter Address Map" (p. 146), the start address of Temporary Performance is 10 00 00 00H, the offset address of Performance Common MFX is 02 00H, and the address of MFX Type is 00 00H. Therefore the address of MFX Type of Performance Common MFX is;

$$\begin{array}{r} 10\ 00\ 00\ 00\text{H} \\ \quad 02\ 00\text{H} \\ +) \quad 00\ 00\text{H} \\ \hline 10\ 00\ 02\ 00\text{H} \end{array}$$

OVERDRIVE has the value of 02H.

So the system exclusive message should be sent is;

F0	41	10	00 10	12	10 00 02 00	02	??	F7
(1)	(2)	(3)	(4)	(5)	address	data	checksum	(6)

- | | | |
|------------------------|----------------------|----------------------|
| (1) Exclusive Status | (2) ID (Roland) | (3) Device ID (17) |
| (4) Model ID (XV-2020) | (5) Command ID (DT1) | (6) End of Exclusive |

Then calculate the checksum.

$$\begin{aligned} 10\text{H} + 00\text{H} + 02\text{H} + 00\text{H} + 02\text{H} &= 16 + 0 + 2 + 0 + 2 = 20 \text{ (sum)} \\ 20 \text{ (sum)} \times 128 &= 0 \text{ (quotient)} \dots 20 \text{ (remainder)} \\ \text{checksum} &= 128 - 20 \text{ (remainder)} = 108 = 6\text{CH} \end{aligned}$$

This means that F0 41 10 00 10 12 10 00 02 00 02 6C F7 is the message should be sent.

<Example2> Getting the data (RQ1) of Performance Part 3 in USER:03

According to the "Parameter Address Map" (p. 146), the start address of USER:03 is 20 02 00 00H, and the offset address of Performance Part 3 is 00 22 00H.

Therefore the start address of Performance Part 3 in USER:03 is;

$$\begin{array}{r} 20\ 02\ 00\ 00\text{H} \\ +) \quad 00\ 22\ 00\text{H} \\ \hline 20\ 02\ 22\ 00\text{H} \end{array}$$

As the size of Performance Part is 00 00 00 31H, the system exclusive message should be sent is;

F0	41	10	00 10	11	20 02 22 00	00 00 00 31	??	F7
(1)	(2)	(3)	(4)	(5)	address	data	checksum	(6)

- | | | |
|------------------------|----------------------|----------------------|
| (1) Exclusive Status | (2) ID (Roland) | (3) Device ID (17) |
| (4) Model ID (XV-2020) | (5) Command ID (RQ1) | (6) End of Exclusive |

Then calculate the checksum.

$$\begin{aligned} 20\text{H} + 02\text{H} + 22\text{H} + 00\text{H} + 00\text{H} + 00\text{H} + 00\text{H} + 31\text{H} &= 32 + 2 + 34 + 0 + 0 + 0 + 49 \\ &= 117 \text{ (sum)} \\ 117 \text{ (sum)} \times 128 &= 0 \text{ (quotient)} \dots 117 \text{ (remainder)} \\ \text{checksum} &= 128 - 117 \text{ (remainder)} = 11 = 0\text{BH} \end{aligned}$$

This means that F0 41 10 00 10 11 20 02 22 00 00 00 31 0B F7 is the message should be sent.

<Example3> Getting Temporary Performance data (RQ1)

According to the "Parameter Address Map" (p. 146), the start address of Temporary Performance is assigned as following:

10 00 00 00H	Temporary Performance Common
:	
10 00 20 00H	Temporary Performance Part 1
:	
10 00 2F 00H	Temporary Performance Part 16

As the data size of Performance Controller is 00 00 00 31H, summation of the size and the start address of Temporary Performance Part 16 will be;

$$\begin{array}{r} 10\ 00\ 2F\ 00\text{H} \\ +) \quad 00\ 00\ 00\ 31\text{H} \\ \hline 10\ 00\ 2F\ 31\text{H} \end{array}$$

And the size that have to be got should be;

$$\begin{array}{r} 10\ 00\ 2F\ 31\text{H} \\ -) \quad 10\ 00\ 00\ 00\text{H} \\ \hline 00\ 00\ 2F\ 31\text{H} \end{array}$$

Therefore the system exclusive message should be sent is;

F0	41	10	00 10	11	10 00 00 00	00 00 2F 31	??	F7
(1)	(2)	(3)	(4)	(5)	address	data	checksum	(6)

- | | | |
|------------------------|----------------------|----------------------|
| (1) Exclusive Status | (2) ID (Roland) | (3) Device ID (17) |
| (4) Model ID (XV-2020) | (5) Command ID (RQ1) | (6) End of Exclusive |

Calculating the checksum as shown in <Example 2>, we get a message of F0 41 10 0A 11 10 00 00 00 00 2F 31 10 F7 to be transmitted.

<Example4> Getting data (RQ1) at once;

Temporary Performance data,
Temporary Patch data of whole part in Performance mode,
Temporary Rhythm data of whole part in Performance mode.

According to the "Parameter Address Map" (p. 146), the start address of the above all parameters is assigned as following:

10 00 00 00H	Temporary Performance
11 00 00 00H	Temporary Patch (Performance Mode Part 1)
11 10 00 00H	Temporary Rhythm (Performance Mode Part 1)
:	
14 60 00 00H	Temporary Patch (Performance Mode Part 16)
14 70 00 00H	Temporary Rhythm (Performance Mode Part 16)

The offset address of Rhythm is also assigned as follows:

00 00 00H	Rhythm Common
:	
00 10 00H	Rhythm Tone (Key # 21)
:	
01 3E 00H	Rhythm Tone (Key # 108)

As the data size of Rhythm Tone is 00 00 01 41H, summation of the size and the start address of Temporary Rhythm Tone #108 in Performance mode will be;

$$\begin{array}{r} 14\ 70\ 00\ 00\text{H} \\ \quad 01\ 3E\ 00\text{H} \\ +) \quad 00\ 00\ 01\ 41\text{H} \\ \hline 14\ 71\ 3F\ 41\text{H} \end{array}$$

And the size that have to be got should be;

$$\begin{array}{r} 14\ 71\ 3F\ 41\text{H} \\ -) \quad 10\ 00\ 00\ 00\text{H} \\ \hline 04\ 71\ 3F\ 41\text{H} \end{array}$$

Therefore the system exclusive message should be sent is;

F0	41	10	00 10	11	10 00 00 00	04 71 3F 41	??	F7
(1)	(2)	(3)	(4)	(5)	address	data	checksum	(6)

- | | | |
|------------------------|----------------------|----------------------|
| (1) Exclusive Status | (2) ID (Roland) | (3) Device ID (17) |
| (4) Model ID (XV-2020) | (5) Command ID (RQ1) | (6) End of Exclusive |

Calculating the checksum as shown in <Example 2>, we get a message of F0 41 10 00 10 11 00 00 00 04 71 3F 41 7B F7 to be transmitted.

MIDI Implementation

■The Scale Tune Feature (address: 40 1x 40)

The Scale Tune feature allows you to finely adjust the individual pitch of the notes from C through B. Though the settings are made while working with one octave, the fine adjustments will affect all octaves. By making the appropriate Scale Tune settings, you can obtain a complete variety of tuning methods other than equal temperament. As examples, three possible types of scale setting are explained below.

○Equal Temperament

This method of tuning divides the octave into 12 equal parts. It is currently the most widely used form of tuning, especially in occidental music. On the XV-2020, the default settings for the Scale Tune feature produce equal temperament.

○Just Temperament (Tonic of C)

The principal triads resound much more beautifully than with equal temperament, but this benefit can only be obtained in one key. If transposed, the chords tend to become ambiguous. The example given involves settings for a key in which C is the keynote.

○Arabian Scale

By altering the setting for Scale Tune, you can obtain a variety of other tunings suited for ethnic music. For example, the settings introduced below will set the unit to use the Arabian Scale.

Example Settings

Note name	Equal Temperament	Just Temperament (Key-tone C)	Arabian Scale
C	0	0	-6
C#	0	-8	+45
D	0	+4	-2
Eb	0	+16	-12
E	0	-14	-51
F	0	-2	-8
F#	0	-10	+43
G	0	+2	-4
G#	0	+14	+47
A	0	-16	0
Bb	0	+14	-10
B	0	-12	-49

The values in the table are given in cents. Convert these values to hexadecimal, and transmit them as Exclusive data.

For example, to set the tune (C-B) of the Part 1 Arabian Scale, send the following data:

F0 41 10 42 12 40 11 40 3A 6D 3E 34 0D 38 6B 3C 6F 40 36 0F 76 F7

■ASCII Code Table

Patch Name and Performance Name, etc., of MIDI data are described the ASCII code in the table below.

D	H	Char	D	H	Char	D	H	Char
32	20H	SP	64	40H	@	96	60H	`
33	21H	!	65	41H	A	97	61H	a
34	22H	"	66	42H	B	98	62H	b
35	23H	#	67	43H	C	99	63H	c
36	24H	\$	68	44H	D	100	64H	d
37	25H	%	69	45H	E	101	65H	e
38	26H	&	70	46H	F	102	66H	f
39	27H	'	71	47H	G	103	67H	g
40	28H	(72	48H	H	104	68H	h
41	29H)	73	49H	I	105	69H	i
42	2AH	*	74	4AH	J	106	6AH	j
43	2BH	+	75	4BH	K	107	6BH	k
44	2CH	,	76	4CH	L	108	6CH	l
45	2DH	-	77	4DH	M	109	6DH	m
46	2EH	.	78	4EH	N	110	6EH	n
47	2FH	/	79	4FH	O	111	6FH	o
48	30H	0	80	50H	P	112	70H	p
49	31H	1	81	51H	Q	113	71H	q
50	32H	2	82	52H	R	114	72H	r
51	33H	3	83	53H	S	115	73H	s
52	34H	4	84	54H	T	116	74H	t
53	35H	5	85	55H	U	117	75H	u
54	36H	6	86	56H	V	118	76H	v
55	37H	7	87	57H	W	119	77H	w
56	38H	8	88	58H	X	120	78H	x
57	39H	9	89	59H	Y	121	79H	y
58	3AH	:	90	5AH	Z	122	7AH	z
59	3BH	;	91	5BH	[123	7BH	{
60	3CH	<	92	5CH	\	124	7CH	}
61	3DH	=	93	5DH]	125	7DH	~
62	3EH	>	94	5EH	^			
63	3FH	?	95	5FH	_			

D: decimal

H: hexadecimal

* "SP" is space.

Specifications

XV-2020: 64-Voice Sound Module

(conforms to General MIDI 2 System)

Parts

16

Maximum Polyphony

64 voices

Wave Memory

64 M Bytes (16-bit linear equivalent)

Waveforms: 1083

Expansion Slot

Wave Expansion Board SRX Series: 2 slots

Preset Memory

Patches: 512 (128 x 4 banks) + 256 (General MIDI 2 Patches)

Rhythm Sets: 8 (4 x 2 banks) + 9 (General MIDI 2 Rhythm Sets)

Performances: 64 (32 x 2 banks)

User Memory

Patches: 128

Rhythm Sets: 4

Performances: 64

Effects

Multi-effects: 40 sets

Chorus: 1 set

Reverb: 1 set (8 types)

Display

7 segments, 3 characters (LED)

Connectors

Headphones Jack: Stereo 1/4 inch phone type

USB Connector

Output Jacks (L (MONO), R) (1/4 inch phone type)

Output Jacks (L, R) (RCA phono type)

MIDI Connectors (IN, OUT, THRU)

DC IN Jack

Ground Terminal

Power Supply

DC 9 V (AC Adaptor)

Current Draw

600 mA

Dimensions

218 (W) x 237 (D) x 45 (H) mm

8-5/8 (W) x 9-3/8 (D) x 1-13/16 (H) inches

Weight

1.4 kg / 3 lbs 2 oz (excluding AC Adaptor)

Accessories

Owner's Manual

AC Adaptor (ACI-120C/ACI-230C/PSB-1U)

CD-ROM (XV Editor, USB Driver)

Rubber Feet

Options

Wave Expansion Board: SRX Series

Rack Mount Adaptor: RAD-50

* *In the interest of product improvement, the specifications and/or appearance of this unit are subject to change without notice.*

INDEX

Numerics

2 VOICE PITCH SHIFTER87

A

Analog Feel Depth47

Assign type68

AUTO WAH83

B

bank35

Bank Select40

BIAS59

Booster48

Bulk Dump93

C

Category35, 37

Chorus76

CHORUS -> DELAY90

CHORUS -> FLANGER91

Chorus Parameters81

Chorus Send Level

 Multi-Effects80

 tone78

Chorus Settings80

Chorus Source80

CHORUS/DELAY91

CHORUS/FLANGER91

COARSE TUNE46

COMPRESSOR84

Cutoff Frequency57

Cutoff frequency66

Cutoff Frequency Velocity Curve58

Cutoff Frequency Velocity Sensitivity58

Cutoff Key follow58

CUTOFF OFFSET47

D

DISTORTION82

DISTORTION -> CHORUS89

DISTORTION -> DELAY89

Driver

 Deleting23

 Install (Macintosh)24

 Install (Windows)13

 Settings and checking21

Dry Send Level

 Multi-Effects80

 part79

 tone78

E

ENHANCER83

ENHANCER -> CHORUS89

Envelope44, 62

Expansion Board106

F

Factory Reset12

FB PITCH SHIFTER88

Filter57

FINE TUNE46

FLANGER85

FLANGER/DELAY91

FreeMIDI28

FXM (Frequency Cross Modulation)54, 65

G

GATED REVERB88

General MIDI39

General MIDI 239

GM Mode96

GM/GM2 System On Message96

H

HEXA-CHORUS84

I

INITIALIZE92

K

Key Mode Assign47

L

Layer70

LEGATO RETRIGGER47

Legato Switch47

Level

 chorus80

 GM98

 master94

 part72

 patch46

 reverb80

 rhythm set63

 Rhythm tone67

 Wave64

LFO45, 55

LFO Waveform56

LIMITER84

Low Frequency Oscillator45, 55

M

MASTER KEY SHIFT94

MFX76

MIDI Channels35

MIDI-USB Thru95

Mode39

MODULATION DELAY86

Multi-effects76

Multi-Effects Settings80

multitimbral sound module70

MUTE GROUP68

INDEX

O

OCTAVE SHIFT	46
OFFSET	47, 73
OMS	25
Output Assign	
part	79
patch	46
rhythm set	63
tone	78
OVERDRIVE	82
OVERDRIVE -> CHORUS	88
OVERDRIVE -> DELAY	89
OVERDRIVE -> FLANGER	89

P

Part	31
Part Chorus Send Level	79
Part Coarse Tune	72
Part Fine Tune	72
Part Legato Switch	72
Part Mono/Poly	72
Part Octave Shift	72
Part Pan	72
Part Pitch Bend Range	72
Part Velocity Sensitivity	72
Patch	31, 44
Patch Clock Source	47
PATCH KEY RANGE	49
Patch Matrix Control	50
Patch Pan	46
Patch Parameter	46
Patch Remain Switch	94
PATCH STRUCTURE	48
Patch Tempo	47
Patch/Rhythm Set Receive Channel	94
Patches	34
Performance	31, 38
Performance Control Channel	94
Performance Parameters	71
Phase Lock Switch	74
PHASER	83
Phrase Preview	34
PITCH BEND RANGE	47
PITCH ENVELOPE	54, 65
Pitch Key follow	54
Portamento	47, 72
PROGRAM VERSION	95

Q

QUADRUPLE TAP DELAY	87
---------------------------	----

R

Rack-Mount Adaptor	10
Random pitch depth	65
Receive Bank Select Switch	74, 94
Receive Channel	74
Receive Channel Pressure Switch	74
Receive Expression Switch	74

Receive Hold 1 Switch	74
Receive Modulation Switch	74
Receive Pan Switch	74
Receive Pitch Bend Switch	74
Receive Polyphonic Pressure Switch	74
Receive Program Change Switch	74, 94
Receive Switch	74
Receive Volume Switch	74
Registered Parameter Number	104
Resonance	57, 66
REVERB	88
Reverb	76
Reverb Parameters	81
Reverb Send Level	
Multi-Effects	80
part	79
tone	78
Reverb Source	80
Rhythm set clock source	63
Rhythm Set Parameters	63
Rhythm set tempo	63
Rhythm tone coarse tune	65
Rhythm tone fine tune	65
Ring Modulator	48
ROTARY	83
RPN	104

S

Scale Tune	
Patch	51
Performance	75
SPACE-D	85
SPECTRUM	83
Split	70
STEP FLANGER	85
STEREO CHORUS	85
STEREO DELAY	86
STEREO EQ	82
STEREO FLANGER	85
STRETCH TUNE DEPTH	46
System Clock Source	94
System Control Source1-4	94
System Tempo	94

T

TIME CONTROL DELAY	87
Time Variant Amplifier	44, 62
Time Variant Filter	44, 62
TMT	49
Tone Alternate Pan Depth	60
Tone Coarse Tune	54
TONE DELAY	53
Tone Envelope Mode	50
Tone Fine Tune	54
Tone Pan Key follow	60
Tone Random Pan Depth	60
Tone Random Pitch Depth	54
Tone Receive Bender Switch	50
Tone Receive Expression Switch	50
Tone Receive Hold 1 Switch	50
Tone Receive Pan Mode	50
Tone Redamper Switch	50
Tones	44
TREMOLO CHO	84
TRIPLE TAP DELAY	87
TVA	44, 62
TVA ENVELOPE	60, 68
TVA Level Velocity Curve	59
TVA Level Velocity Sensitivity	59
TVF	44, 62
TVF ENVELOPE	58, 67
TVF VELOCITY	66

U

USB DESCRIPTOR	95
----------------------	----

V

VELOCITY CURVE TYPE	74
Velocity Range	64
VELOCITY SENS OFFSET	47
Voice Priority	47
VOICE RESERVE	73

W

Wave FXM Color	54
Wave FXM Depth	54
Wave Gain	53
Wave Generator	44, 62
Wave Mix Table	64
Wave Tempo Sync	54
WG	44, 62
Windows 2000	17
Windows Me/98	20
Windows XP	14
WRITE	92

X

XFER	93
XV Editor	30

Information

When you need repair service, call your nearest Roland Service Center or authorized Roland distributor in your country as shown below.

AFRICA

EGYPT

Al Fanny Trading Office
9, EBN Hagar A1 Askalany Street,
ARD El Golf, Heliopolis,
Cairo 11341, EGYPT
TEL: 20-2-417-1828

REUNION

Maison FO - YAM Marcel
25 Rue Jules Hermann,
Chaudron - BP79 97 491
Ste Clotilde Cedex,
REUNION ISLAND
TEL: (0262) 218-429

SOUTH AFRICA

**That Other Music Shop
(PTY) Ltd.**
11 Melle St., Braamfontein,
Johannesbourg, SOUTH AFRICA

P.O.Box 32918, Braamfontein 2017
Johannesbourg, SOUTH AFRICA
TEL: (011) 403 4105

Paul Bothner (PTY) Ltd.
17 Werdmuller Centre,
Main Road, Claremont 7708
SOUTH AFRICA

P.O.Box 23032, Claremont 7735,
SOUTH AFRICA
TEL: (021) 674 4030

ASIA

CHINA

**Roland Shanghai Electronics
Co., Ltd.**
5F. No.1500 Pingliang Road
Shanghai, CHINA
TEL: (021) 5580-0800

**Roland Shanghai Electronics
Co., Ltd.
(BEIJING OFFICE)**
10F. No.18 Anhuaxili
Chaoyang District, Beijing,
CHINA
TEL: (010) 6426-5050

HONG KONG

**Tom Lee Music Co., Ltd.
Service Division**
22-32 Pun Shan Street, Tsuen
Wan, New Territories,
HONG KONG
TEL: 2415 0911

INDIA

Rivera Digitec (India) Pvt. Ltd.
409, Nirman Kendra Mahalaxmi
Flats Compound Off. Dr. Edwin
Moses Road, Mumbai-400011,
INDIA
TEL: (022) 2493 9051

INDONESIA

PT Citra Inti Rama
Jl. Cideng Timur No. 15J-150
Jakarta Pusat
INDONESIA
TEL: (021) 6324170

KOREA

Cosmos Corporation
1461-9, Seocho-Dong,
Seocho Ku, Seoul, KOREA
TEL: (02) 3486-8855

MALAYSIA

BENTLEY MUSIC SDN BHD
140 & 142, Jalan Bukit Bintang
55100 Kuala Lumpur, MALAYSIA
TEL: (03) 2144-3333

PHILIPPINES

G.A. Yupangco & Co. Inc.
339 Gil J. Puyat Avenue
Makati, Metro Manila 1200,
PHILIPPINES
TEL: (02) 899 9801

SINGAPORE

Swee Lee Company
150 Sims Drive,
SINGAPORE 387381
TEL: 6846-3676

CRISTOFORI MUSIC PTE LTD

Blk 3014, Bedok Industrial Park E,
#02-2148, SINGAPORE 489980
TEL: 6243-9555

TAIWAN

**ROLAND TAIWAN
ENTERPRISE CO., LTD.**
Room 5, 9fl. No. 112 Chung Shan
N.Road Sec.2, Taipei, TAIWAN,
R.O.C.
TEL: (02) 2561 3339

THAILAND

Theera Music Co., Ltd.
330 Verng NakornKasem, Soi 2,
Bangkok 10100, THAILAND
TEL: (02) 2248821

VIETNAM

Saigon Music
138 Tran Quang Khai St.,
District 1
Ho Chi Minh City
VIETNAM
TEL: (08) 844-4068

AUSTRALIA/ NEW ZEALAND

AUSTRALIA

**Roland Corporation
Australia Pty., Ltd.**
38 Campbell Avenue
Dee Why West, NSW 2089
AUSTRALIA
TEL: (02) 9982 8266

NEW ZEALAND

Roland Corporation Ltd.
32 Shaddock Street, Mount Eden,
Auckland, NEW ZEALAND
TEL: (09) 3098 715

CENTRAL/LATIN AMERICA

ARGENTINA

Instrumentos Musicales S.A.
Av.Santa Fe 2055
(1123) Buenos Aires
ARGENTINA
TEL: (011) 4508-2700

BRAZIL

Roland Brasil Ltda
Rua San Jose, 780 Sala B
Parque Industrial San Jose
Cotia - Sao Paulo - SP, BRAZIL
TEL: (011) 4615 5666

COSTA RICA

**JUAN BANSBACH
Instrumentos Musicales**
Ave.1. Calle 11, Apartado 10237,
San Jose, COSTA RICA
TEL: 258-0211

CHILE

Comercial Fancy II S.A.
Rut.: 96.919.420-1
Nataníel Cox #739, 4th Floor
Santiago - Centro, CHILE
TEL: (02) 688-9540

EL SALVADOR

OMNI MUSIC
75 Avenida Norte y Final
Alameda Juan Pablo II,
Edificio No.4010 San Salvador,
EL SALVADOR
TEL: 262-0788

MEXICO

Casa Veerkamp, s.a. de c.v.
Av. Toluca No. 323, Col. Olivar
de los Padres 01780 Mexico D.F.
MEXICO
TEL: (55) 5668-6699

PANAMA

SUPRO MUNDIAL, S.A.
Boulevard Andrews, Albrook,
Panama City, REP. DE PANAMA
TEL: 315-0101

PARAGUAY

**Distribuidora De
Instrumentos Musicales**
J.E. Olear y ESQ. Manduvira
Asuncion PARAGUAY
TEL: (021) 492-124

URUGUAY

Todo Musica S.A.
Francisco Acuna de Figueroa 1771
C.P.: 11.800
Montevideo, URUGUAY
TEL: (02) 924-2335

VENEZUELA

Musicaland Digital C.A.
Av. Francisco de Miranda,
Centro Parque de Cristal, Nivel
C2 Local 20 Caracas
VENEZUELA
TEL: (212) 285-8586

EUROPE

AUSTRIA

Roland Austria GES.M.B.H.
Siemensstrasse 4, P.O. Box 74,
A-6063 RUM, AUSTRIA
TEL: (0512) 26 44 260

BELGIUM/HOLLAND/ LUXEMBOURG

Roland Benelux N. V.
Houtstraat 3, B-2260, Oevel
(Westerlo) BELGIUM
TEL: (014) 575811

DENMARK

Roland Scandinavia A/S
Nordhavnsvej 7, Postbox 880,
DK-2100 Copenhagen
DENMARK
TEL: 3916 6200

FRANCE

Roland France SA
4, Rue Paul Henri SPAAK,
Parc de l'Esplanade, F 77 462 St.
Thibault, Lagny Cedex FRANCE
TEL: 01 600 73 500

FINLAND

**Roland Scandinavia As,
Filial Finland**
Lauttasarentie 54 B
Fin-00201 Helsinki, FINLAND
TEL: (09) 68 24 020

GERMANY

**Roland Elektronische
Musikinstrumente HmbH.**
Oststrasse 96, 22844 Norderstedt,
GERMANY
TEL: (040) 52 60090

GREECE

**STOLLAS S.A.
Music Sound Light**
155, New National Road
Patras 26442, GREECE
TEL: 2610 435400

HUNGARY

Roland East Europe Ltd.
Warehouse Area 'DEPO' Pf.83
H-2046 Torokbalint, HUNGARY
TEL: (23) 511011

IRELAND

Roland Ireland
Audio House, Belmont Court,
Donnybrook, Dublin 4,
Republic of IRELAND
TEL: (01) 2603501

ITALY

Roland Italy S. p. A.
Viale delle Industrie 8,
20020 Arese, Milano, ITALY
TEL: (02) 937-78300

NORWAY

**Roland Scandinavia Avd.
Kontor Norge**
Lilleakerveien 2 Postboks 95
Lilleaker N-0216 Oslo
NORWAY
TEL: 2273 0074

POLAND

P. P. H. Brzostowicz
UL. Gibraltarska 4,
PL-03664 Warszawa POLAND
TEL: (022) 679 44 19

PORTUGAL

**Tecnologias Musica e Audio,
Roland Portugal, S.A.**
Cais Das Pedras, 8/9-1 Dto
4050-465 PORTO
PORTUGAL
TEL: (022) 608 00 60

ROMANIA

FBS LINES
Piata Libertatii 1,
RO-4200 Gheorgheni
TEL: (095) 169-5043

RUSSIA

MuTek
3-Bogatyrskaya Str. 1.k.1
107 564 Moscow, RUSSIA
TEL: (095) 169 5043

SPAIN

**Roland Electronics
de España, S. A.**
Calle Bolivia 239, 08020
Barcelona, SPAIN
TEL: (93) 308 1000

SWEDEN

**Roland Scandinavia A/S
SWEDISH SALES OFFICE**
Danvik Center 28, 2 tr.
S-131 30 Nacka SWEDEN
TEL: (08) 702 00 20

SWITZERLAND

Roland (Switzerland) AG
Landstrasse 5, Postfach,
CH-4452 Itingen,
SWITZERLAND
TEL: (061) 927-8383

UKRAINE

TIC-TAC
Mira Str. 19/108
P.O. Box 180
295400 Munkachevo, UKRAINE
TEL: (03131) 414-40

UNITED KINGDOM

Roland (U.K.) Ltd.
Atlantic Close, Swansea
Enterprise Park, SWANSEA
SA7 9FJ,
UNITED KINGDOM
TEL: (01792) 700139

MIDDLE EAST

BAHRAIN

Moon Stores
No.16, Bab Al Bahrain Avenue,
P.O.Box 247, Manama 304,
State of BAHRAIN
TEL: 211 005

CYPRUS

Radex Sound Equipment Ltd.
17, Diagorou Street, Nicosia,
CYPRUS
TEL: (022) 66-9426

IRAN

MOCO, INC.
No.41 Nike St., Dr.Shariyati Ave.,
Roberoye Ceraha Mirdamad
Tehran, IRAN
TEL: (021) 285-4169

ISRAEL

**Halilit P. Greenspoon &
Sons Ltd.**
8 Retzif Ha'aliya Hashnya St.
Tel-Aviv-Yafo ISRAEL
TEL: (03) 6823666

JORDAN

AMMAN Trading Agency
245 Prince Mohammad St.,
Amman 1118, JORDAN
TEL: (06) 464-1200

KUWAIT

Easa Husain Al Yousifi Est.
Abdullah Salem Street,
Safat, KUWAIT
TEL: 243-6399

LEBANON

Chahine S.A.L.
Gerge Zeidan St., Chahine Bldg.,
Achrafieh, P.O.Box: 16-5857
Beirut, LEBANON
TEL: (01) 20-1441

QATAR

**Al Emadi Co. (Badie Studio
& Stores)**
P.O. Box 62,
Doha, QATAR
TEL: 4423-554

SAUDI ARABIA

**aDawlah Universal
Electronics APL**
Corniche Road, Aldossary Bldg.,
1st Floor, Alkhobar,
SAUDI ARABIA

P.O.Box 2154, Alkhobar 31952
SAUDI ARABIA
TEL: (03) 898 2081

SYRIA

**Technical Light & Sound
Center**
Khaled Ebn Al Walid St.
Bldg. No. 47, P.O.BOX 13520,
Damascus, SYRIA
TEL: (011) 223-5384

TURKEY

**Barkat muzik aletleri ithalat
ve ihracat Ltd Sti**
Siraselvilir Caddesi Siraselvilir
Pasaji No:74/20
Taksim - Istanbul, TURKEY
TEL: (0212) 2499324

U.A.E.

**Zak Electronics & Musical
Instruments Co. L.L.C.**
Zabeel Road, Al Sherooq Bldg.,
No. 14, Grand Floor, Dubai, U.A.E.
TEL: (04) 3360715

NORTH AMERICA

CANADA

**Roland Canada Music Ltd.
(Head Office)**
5480 Parkwood Way Richmond
B. C., V6V 2M4 CANADA
TEL: (604) 270 6626

Roland Canada Music Ltd.

(Toronto Office)
170 Admiral Boulevard
Mississauga On L5T 2N6
CANADA
TEL: (905) 362 9707

U. S. A.

Roland Corporation U.S.
5100 S. Eastern Avenue
Los Angeles, CA 90040-2938,
U. S. A.
TEL: (323) 890 3700



This product complies with the requirements of European Directive 89/336/EEC.

For EU Countries

FEDERAL COMMUNICATIONS COMMISSION RADIO FREQUENCY INTERFERENCE STATEMENT

This equipment has been tested and found to comply with the limits for a Class B digital device, pursuant to Part 15 of the FCC Rules. These limits are designed to provide reasonable protection against harmful interference in a residential installation. This equipment generates, uses, and can radiate radio frequency energy and, if not installed and used in accordance with the instructions, may cause harmful interference to radio communications. However, there is no guarantee that interference will not occur in a particular installation. If this equipment does cause harmful interference to radio or television reception, which can be determined by turning the equipment off and on, the user is encouraged to try to correct the interference by one or more of the following measures:

- Reorient or relocate the receiving antenna.
- Increase the separation between the equipment and receiver.
- Connect the equipment into an outlet on a circuit different from that to which the receiver is connected.
- Consult the dealer or an experienced radio/TV technician for help.

This device complies with Part 15 of the FCC Rules. Operation is subject to the following two conditions:

- (1) This device may not cause harmful interference, and
- (2) This device must accept any interference received, including interference that may cause undesired operation.

Unauthorized changes or modification to this system can void the users authority to operate this equipment.
This equipment requires shielded interface cables in order to meet FCC class B Limit.

For the USA

For Canada

NOTICE

This Class B digital apparatus meets all requirements of the Canadian Interference-Causing Equipment Regulations.

AVIS

Cet appareil numérique de la classe B respecte toutes les exigences du Règlement sur le matériel brouilleur du Canada.

Performance List /

USER

Preset-A

Preset-B

No.	Name	No.	Name	No.	Name	No.	Name
001	BigSweepStak	033	Symphony2020	001	BigSweepStak	001	Symphony2020
002	Suger Bell	034	Barococo	002	Suger Bell	002	Barococo
003	R&B Kit	035	ChildrenSplt	003	R&B Kit	003	ChildrenSplt
004	Trance Split	036	Huge Space	004	Trance Split	004	Huge Space
005	My Orchestra	037	DulcitarStk	005	My Orchestra	005	DulcitarStk
006	Road2Glass	038	NebularVoxx	006	Road2Glass	006	NebularVoxx
007	Analog Stack	039	Asian Dream	007	Analog Stack	007	Asian Dream
008	Flying Keys	040	Pizz Stack	008	Flying Keys	008	Pizz Stack
009	House Kit	041	Pad / SoftLd	009	House Kit	009	Pad / SoftLd
010	Soaring 2020	042	Organ / Lead	010	Soaring 2020	010	Organ / Lead
011	Seven Hills	043	Bass / Lead	011	Seven Hills	011	Bass / Lead
012	TeknoSplit 1	044	S&H / Pad	012	TeknoSplit 1	012	S&H / Pad
013	Nirvana 2020	045	Drone / Pipe	013	Nirvana 2020	013	Drone / Pipe
014	StChorusStak	046	Seq:Template	014	StChorusStak	014	Seq:Template
015	Bell Stack	047	Seq:R&B	015	Bell Stack	015	Seq:R&B
016	Trance Fair	048	Seq:Hip-Hop	016	Trance Fair	016	Seq:Hip-Hop
017	AggressiveXV	049	Seq:Techno	017	AggressiveXV	017	Seq:Techno
018	Techno Kit	050	Seq:House	018	Techno Kit	018	Seq:House
019	PhsDyno&Bs	051	Seq:Trance	019	PhsDyno&Bs	019	Seq:Trance
020	Dawn Choir	052	Seq:Pop	020	Dawn Choir	020	Seq:Pop
021	DulcimaSteel	053	Seq:FunkRock	021	DulcimaSteel	021	Seq:FunkRock
022	TeknoSplit 2	054	Seq:HardRock	022	TeknoSplit 2	022	Seq:HardRock
023	InstantScore	055	Seq:Blues	023	InstantScore	023	Seq:Blues
024	Voltage Ctrl	056	Seq:Ac.Jazz	024	Voltage Ctrl	024	Seq:Ac.Jazz
025	CrystalChoir	057	Seq:Cont.Jz	025	CrystalChoir	025	Seq:Cont.Jz
026	BlisteringLd	058	Seq:BigBand	026	BlisteringLd	026	Seq:BigBand
027	Asian Split	059	Seq:Latin	027	Asian Split	027	Seq:Latin
028	PhasePadStk	060	Seq:World	028	PhasePadStk	028	Seq:World
029	Hybrid Str	061	Seq:NewAge	029	Hybrid Str	029	Seq:NewAge
030	Dear Friends	062	Seq:Orch	030	Dear Friends	030	Seq:Orch
031	Pop Kit	063	Seq:Film	031	Pop Kit	031	Seq:Film
032	Bell Layer	064	Seq:GM2Temp	032	Bell Layer	032	Seq:GM2Temp

Demo Song List /

Song Title	Composer / Copyright
1. U feel Me	Kazuhiko Maeda © 2002 Roland Corporation
2. Negativa Trance	Mark Lawrence © 2002 Roland Corporation
3. Eye on the Universe	Takayuki Aihara – STUDIO CARNAVAL © 2002 Roland Corporation
4. First Impression	Scott Wilkie © 2002 Scott Wilkie (ASCAP) www.scottwilkie.com



All rights reserved. Unauthorized use of this material for purposes other than private, personal enjoyment is a violation of applicable laws.



Free Manuals Download Website

<http://myh66.com>

<http://usermanuals.us>

<http://www.somanuals.com>

<http://www.4manuals.cc>

<http://www.manual-lib.com>

<http://www.404manual.com>

<http://www.luxmanual.com>

<http://aubethermostatmanual.com>

Golf course search by state

<http://golfingnear.com>

Email search by domain

<http://emailbydomain.com>

Auto manuals search

<http://auto.somanuals.com>

TV manuals search

<http://tv.somanuals.com>