

KENWOOD

KSC-WD250

COMPACT POWERED SUBWOOFER ► page 2-6

INSTRUCTION MANUAL

CAISSON D'EXTRÊME GRAVE AMPLIFIÉ COMPAC ► page 7-11

MODE D'EMPLOI

COMPACTO ALTAVOZ DE SUBGRAVES ► página 12-16

MANUAL DE INSTRUCCIONES

KENWOOD CORPORATION

IMPORTANT SAFEGUARDS

⚠ Read this page carefully to keep your safety.

⚠ WARNING

- Before mounting or wiring etc., be sure to remove the wire from the battery minus terminal.
(Not doing so can cause shorts or fires.)
- When extending the ignition, battery, or ground wires, make sure to use automotive-grade wires or other wires with a 0.75mm² (AWG18) or more to prevent wire deterioration and damage to the wire coating.
- To prevent a short circuit, never put or leave any metallic objects (such as coins or metal tools) inside the speaker.
- **Abnormal smell** – In the event the unit generates smoke or abnormal smell, immediately switch the power OFF. After this, please contact your dealer or nearest service station as soon as possible.
- **Modification** – Do not attempt to open or modify the unit, for this could cause fire hazard or malfunction.
- **Suffocation** – After taking the unit out of the polyethylene bag, be sure to dispose of the polyethylene bag out of the reach of children. Otherwise, they may play with the bag, which could cause hazard of suffocation.

FCC WARNING

This equipment may generate or use radio frequency energy. Changes or modifications to this equipment may cause harmful interference unless the modifications are expressly approved in the instruction manual. The user could lose the authority to operate this equipment if an unauthorized change or modification is made.

⚠ CAUTION

- Do not install the speaker in a spot exposed to direct sunlight or excessive heat or humidity.
- **Water and moisture** – Do not install the speakers in locations which may be subject to water or moisture.
- **Dust and unstable locations** – Do not install the speakers in unstable locations or locations subject to dust.
- If the fuse blows, after checking to see if the wiring cord has shorted, be sure to replace with the stipulated size (amperage) fuse as displayed on the fuse box.
(Using fuses other than the stipulated size can cause fires.)
To replace the fuse, refer to the vehicle instruction manual.
- To prevent a short circuit when replacing a fuse, disconnect the wiring harness at first.
- Do not use gasoline, naphtha, or any type of solvent to clean the speaker. Clean by wiping with a soft, dry cloth.
- Do not connect cables and leads to both RCA cable input jacks and the speaker input terminals simultaneously, for this may cause malfunction or damage.
- When making a hole under a seat, inside the trunk, or somewhere else in the vehicle, check that there is nothing hazardous on the opposite side such as a gasoline tank, brake pipe; or wiring harness, and be careful not to cause scratches or other damage.
- For ground wire mounting, do not fasten the wire to an airbag, steering or brake line system or other critical safety unit bolts or nut.
(Can cause accidents.)
- When mounting, be sure to mount in a place that will not interfere with driving or be dangerous to passengers during sudden braking etc.
(Cause of injury or accidents.)
- After installing the unit, check to make sure that electrical equipment such as the brake lamps, turn signal lamps and windshield wipers operate normally.

Before installing the speaker or making any connections, please read all of this instruction manual carefully, to make sure that you perform these operations correctly.

■ For your records



Record the serial number, found on the right side of the unit, in the spaces designated on the warranty card, and in the space provided below. Refer to this model's name and serial number whenever you call upon your KENWOOD dealer for information or service on this amplifier.

Model KSC-WD250 Serial number _____

■ Safety Precautions

In a situation where the car has been left in direct sunlight with its windows closed and the temperature inside the car has risen to a very high level, switch on the air conditioner or drive the car for awhile with the windows open before operating the car stereo. Do not operate the car stereo until the temperature inside the car has dropped to a normal level.

Parts included

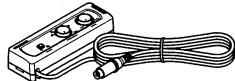
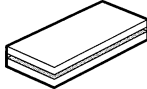
No.	Part Name	Outside Shape	Quantity
①	Bracket		4
②	Tap screw (Ø5 x 22mm)		16
③	Remote control unit (6m)		1
④	Velcro tape		1

Connection

To enhance the bass sound of your car stereo system, this unit can be connected to it as shown in the following examples.

- Do not connect this speaker to other amplifiers. Otherwise, it could damage amplifiers.

■ Examples of applications

• General connection

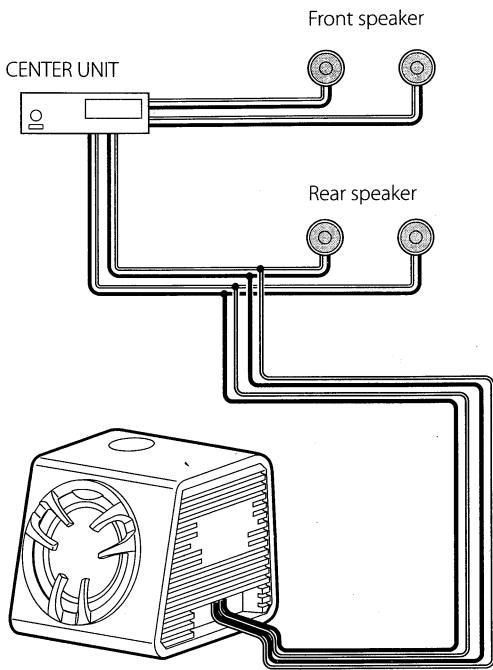

• Connection to center unit with non-fader (subwoofer control)

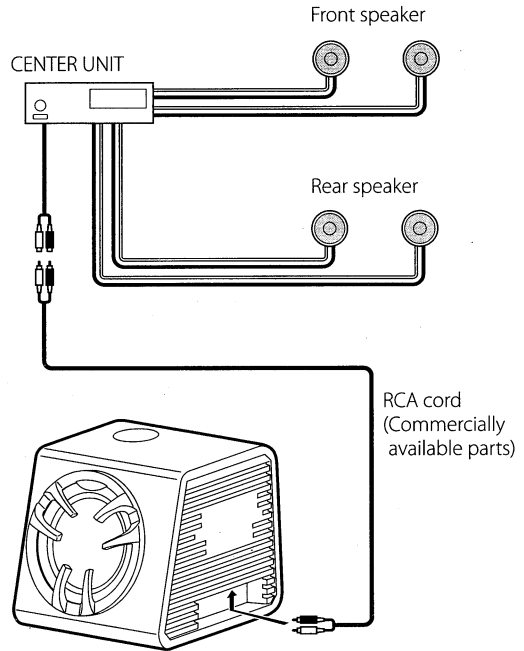

Installation

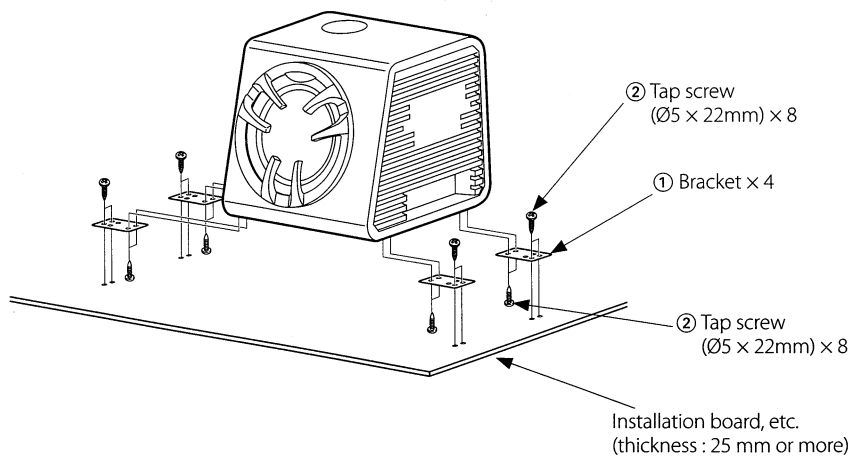

Examples of Connections

Caution: Under any circumstances, never apply inputs to the terminals (A) and (B) simultaneously.

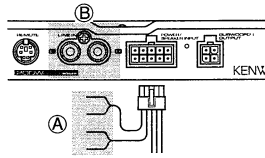

General connection

If there is no power control terminal in the center unit, connect the blue/white wire to the accessory line (ignition key switch ACC position line).

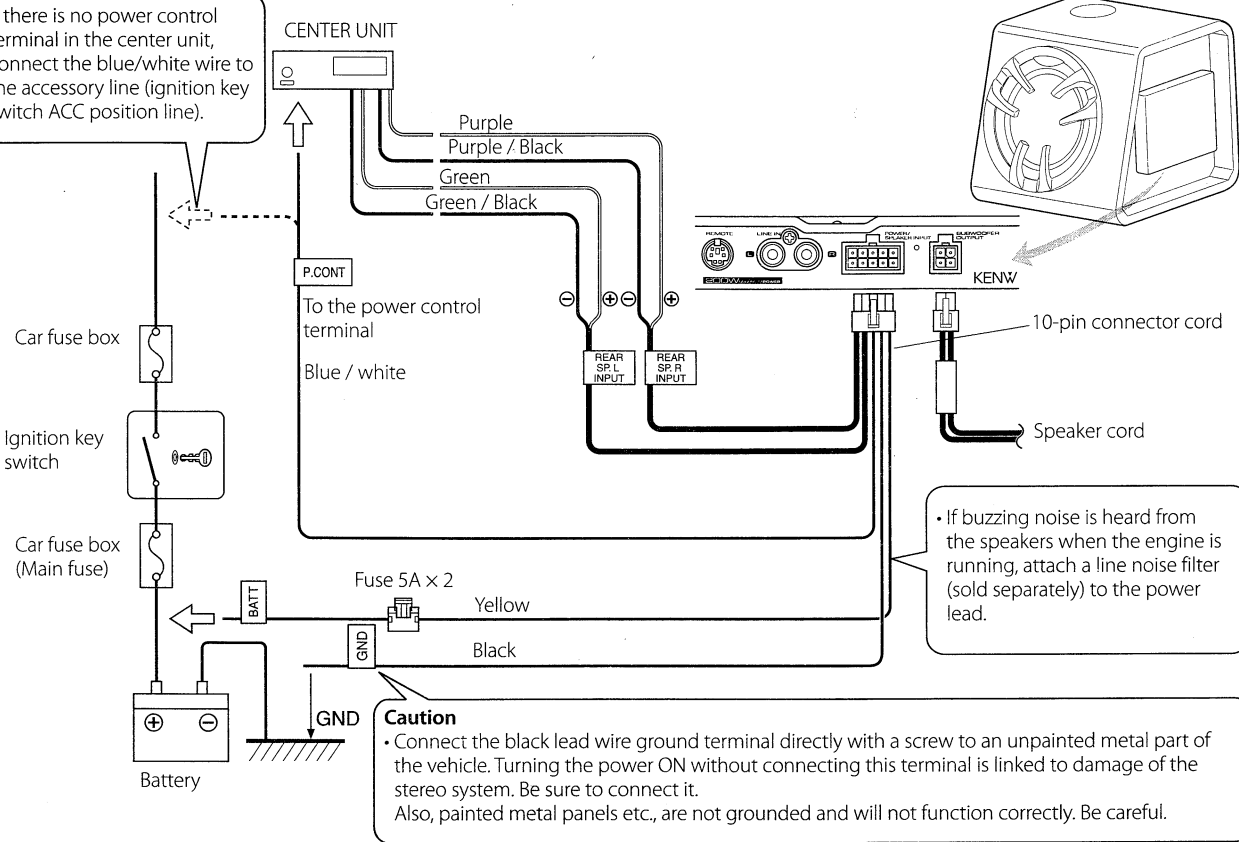

If buzzing noise is heard from the speakers when the engine is running, attach a line noise filter (sold separately) to the power lead.

Caution
 • Connect the black lead wire ground terminal directly with a screw to an unpainted metal part of the vehicle. Turning the power ON without connecting this terminal is linked to damage of the stereo system. Be sure to connect it. Also, painted metal panels etc., are not grounded and will not function correctly. Be careful.

Connection to center unit with non-fader (subwoofer control)

If there is no power control terminal in the center unit, connect the blue/white wire to the accessory line (ignition key switch ACC position line).

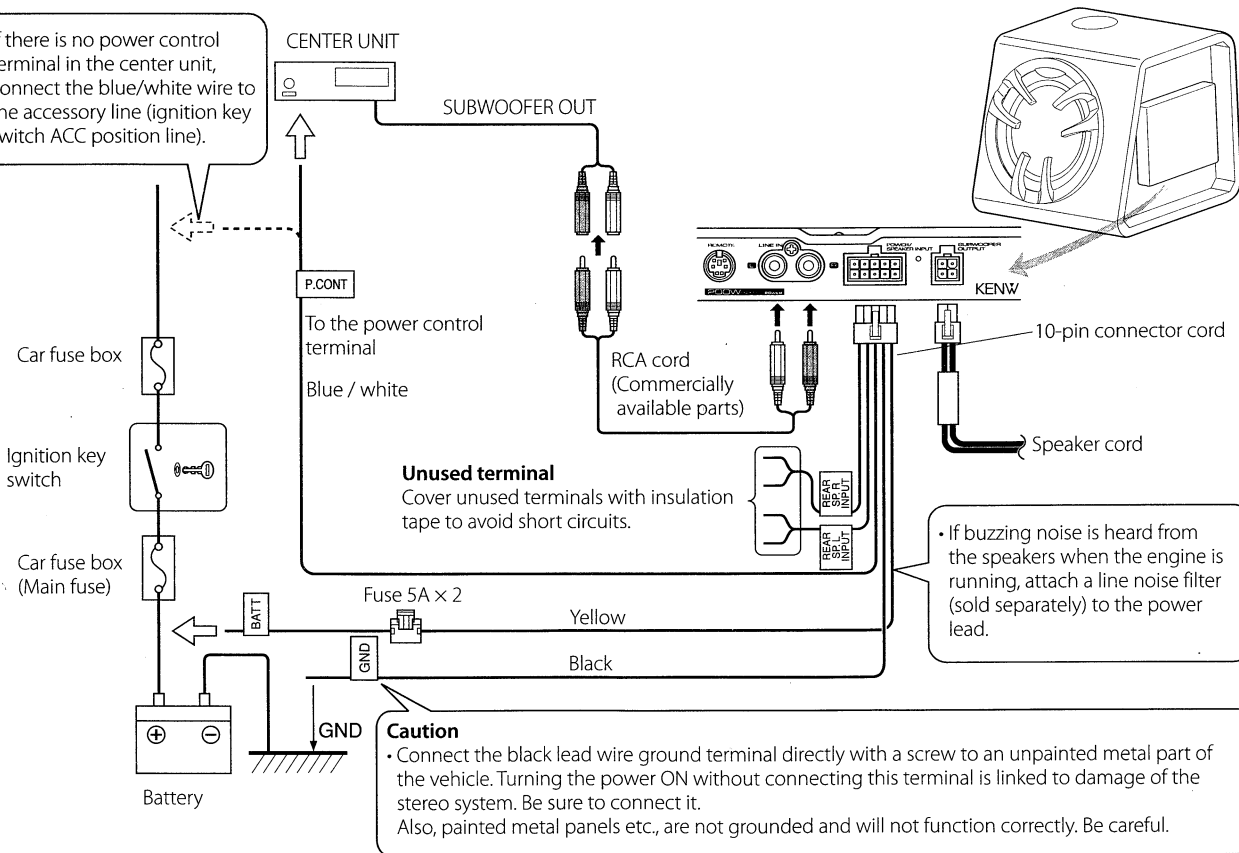

If buzzing noise is heard from the speakers when the engine is running, attach a line noise filter (sold separately) to the power lead.

Caution
 • Connect the black lead wire ground terminal directly with a screw to an unpainted metal part of the vehicle. Turning the power ON without connecting this terminal is linked to damage of the stereo system. Be sure to connect it. Also, painted metal panels etc., are not grounded and will not function correctly. Be careful.

Operation

■ Name of each part

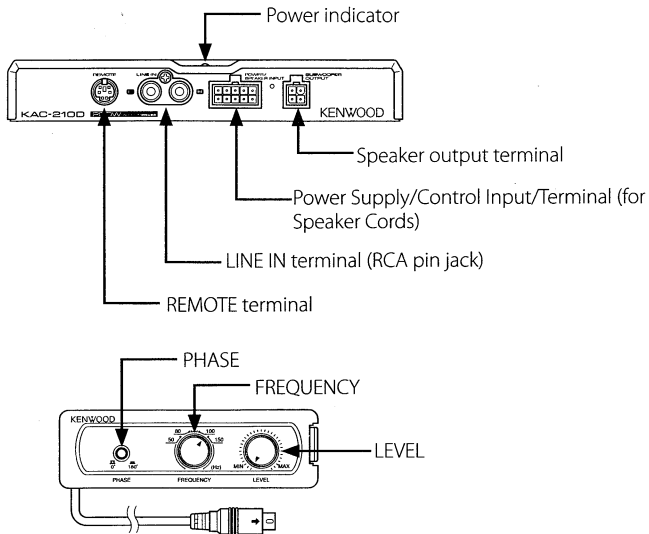

■ Fuse exchange

Exchange with the specified capacity fuse.

Removal: Grasp with your fingers and pull up.

Insertion: Insert the fuse gently into the fuse holder and push in all the way with your finger.

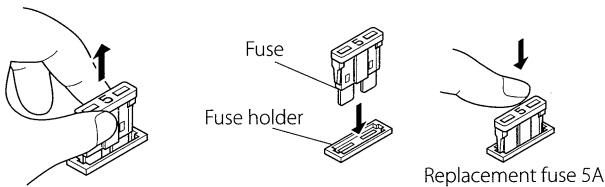

Caution:

Be sure to replace with same capacity (amperage) as displayed on the fuse. This product is 5A.

■ Basic operation

1. Set the crossover frequency.

Turn the LOW PASS FREQUENCY control knob to adjust the balance between the bass from the rear speakers and the bass from this unit as desired.

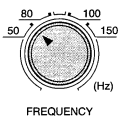

2. Adjust the low frequency level.

Turn the knob to the desired level.

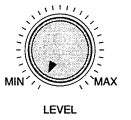

3. Adjust the low frequency phase.

The low frequency tone may be variable depending on the position of the unit, its orientation or the crossover frequency. This can be adjusted by changing the position of the PHASE switch. Set this switch to either position according to your liking.



● Crossover frequency: The frequency at which the high range is cut off.

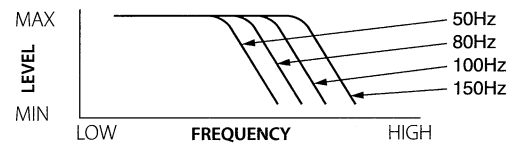

● Connecting the remote control unit

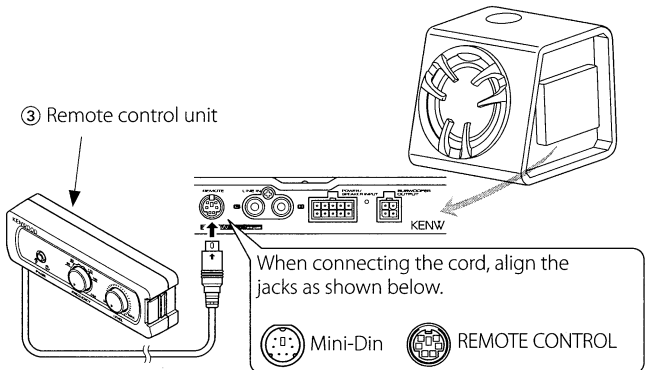

● Installing the remote control unit

Install the remote control unit on the vehicle by the provided Velcro tape.

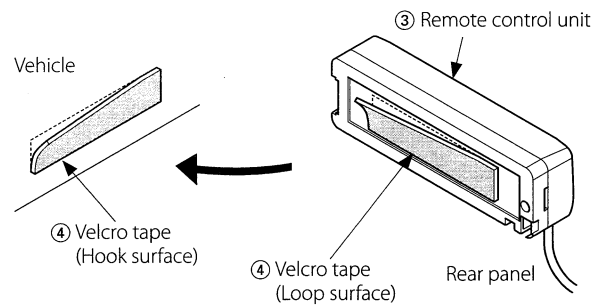

Caution:

Install the remote control unit in a position that does not come in the way of driving operations.

Avoid installing it in a place subject to direct sunlight or direct hot wind from the heater.

Remove dirt from the installation position before attaching the Velcro tape.

Troubleshooting Guide

Often, what appears to be a malfunction is due to user error. Before calling for service, please consult the following table.

Problem	Cause	Remedy
Power cannot be turned on (the POWER indicator does not light).	<ul style="list-style-type: none"> The fuse is blown. 	<ul style="list-style-type: none"> Check the (+)/(-) polarity of the power cord and that the cords are not shorted, then replace with a fuse with the rated capacity. Re-connect the cords correctly by referring to the connection example (on page 4).
	<ul style="list-style-type: none"> The power supply pin (yellow) of the 10-pin connection cord is not connected. The power control pin (blue) of the 10-pin connection cord is not connected. The 10-pin connector is not plugged in completely. The grounding pin (black) of the 10-pin connection cord is not connected. 	<ul style="list-style-type: none"> Connect the cord correctly by referring to the connection example (on page 4). Check the connections of all cords, then connect the (-) cable to the battery. Insert the connector all the way in. Attach the grounding terminal to the metallic section of the vehicle (not a coated surface) by tightly screwing it.
No sound	<ul style="list-style-type: none"> The negative (-) cable of the car battery is disconnected. 	<ul style="list-style-type: none"> Check the connections of all cords, then connect the (-) cable to the battery.
	<ul style="list-style-type: none"> The attenuator of the center unit is set to ON. The LEVEL control is set to the MIN position. The speaker cords are connected improperly. Connection terminals are connected improperly. 	<ul style="list-style-type: none"> Switch the attenuator OFF. Increase the volume to an optimum level. Connect the cords correctly by referring to the connection example (on page 4). Insert the connectors or jacks all the way in to the terminals.
Sound quality is bad (sound is distorted).	<ul style="list-style-type: none"> The LEVEL control is set to the MAX position. 	<ul style="list-style-type: none"> Set the volume to an optimum level.
Unable control	<ul style="list-style-type: none"> Remote control cord is not connected. 	<ul style="list-style-type: none"> Connect remote control cord to remote control terminal.
The sound is unnatural.	<ul style="list-style-type: none"> The speaker cords are connected with incorrect positive (+)/negative (-) polarity. The grounding pin (black) of the 10-pin connection cord is poorly contacted. 	<ul style="list-style-type: none"> Connect the cords correctly by referring to the connection example (on page 4). Attach the grounding terminal to the metallic section of the vehicle (not a coated surface) by tightly screwing it.

Specifications

The following ratings and design are subject to change without notice.

[Amp unit]

Maximum output.....	200W
Frequency Response (System).....	30 – 150Hz
S/N ratio.....	85dB
Low Pass Filter Frequency.....	50Hz, 80Hz, 100Hz, 150Hz (4 steps)
Phase.....	0°, 180°
Sensitivity/ Input Impedance (RCA pin jack).....	210mV / 10kΩ
(Speaker input).....	4.2V / 1kΩ
Power.....	DC14.4V (Operational range 10.5 – 16V)
Maximum current consumption.....	10A
Fuse capacity.....	5A × 2
External size.....	Width 195mm × height 30mm × depth 155mm (7-11/16" × 1-3/16" × 6-1/8")
Weight.....	800g (1.8lb)

[Speaker unit]

Impedance.....	(1.5 Ω + 1.5 Ω) = 0.75 Ω
Woofer.....	10 inch Cone type

[Amp unit] + [Speaker unit]

Net weight.....	11.5kg (25.4 lb)
External size.....	Width 353mm × height 327.5mm × depth 371.7mm (13-7/8" × 12-7/8" × 14-5/8")

Free Manuals Download Website

<http://myh66.com>

<http://usermanuals.us>

<http://www.somanuals.com>

<http://www.4manuals.cc>

<http://www.manual-lib.com>

<http://www.404manual.com>

<http://www.luxmanual.com>

<http://aubethermostatmanual.com>

Golf course search by state

<http://golfingnear.com>

Email search by domain

<http://emailbydomain.com>

Auto manuals search

<http://auto.somanuals.com>

TV manuals search

<http://tv.somanuals.com>