

Setting up your Kenwood KVS Speakers



Introduction

Your Kenwood KVS speakers were designed to meet the demands of today's high-quality music recordings and film soundtracks.

Your new speakers:

- Deliver wide dynamic range and powerful bass response
- Feature quality-built acoustically-optimized enclosures
- Are magnetically-shielded for use in audio/video systems
- Were designed, engineered, and assembled in the USA.

Installing the speakers isn't difficult, but please read and follow all of the instructions in this manual to get maximum performance from your new speakers. If you're also connecting other equipment, such as a receiver, power amplifier, or pre-amplifier, use this manual in combination with the materials that came with those components.

Unpacking

Unpack your new speakers carefully and examine them for shipping damage. If they are damaged or fail to operate, notify your dealer immediately. If your speakers were shipped to you directly, notify the shipping company without delay. Only the person or company who originally received the unit can file a claim against the carrier for shipping damage. Keep the original carton and packing materials in case you need to transport or ship your speakers.

About speaker wire

We ask you to buy the wire separately, since we don't know how much wire you will need. We suggest that you buy wire that is at least 18-gauge or thicker. Remember, the smaller the number, the thicker the wire, so 18-gauge wire is thicker than 20-gauge wire.

Before you run out to buy speaker wire, read the section on 'Placing the speakers' on page 3. You'll need to know where your speakers will go before you buy the speaker wire.

For your records

Record the serial number (found on the back of the unit) on the warranty card, and in the space below. If you need to call your dealer for information or service, you'll need the model and serial numbers. And be sure to save your original receipt.

Model

KVS-

Serial Number

--

KENWOOD

Safety First

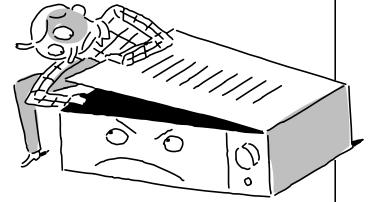

Please read these safety instructions carefully. They can help prevent electrical shock, fire, and damage to the unit.



Safety Precautions

For all units

- 1 Dispose of the packaging materials properly. After you take the unit out of its shipping bag, dispose of the bag, keeping it out of the reach of children and animals. Be aware that the bag could cause suffocation.
- 2 Protect your unit from moisture. Don't place your unit near water—for example, a bathtub, kitchen sink, laundry tub, wet basement or near a swimming pool.

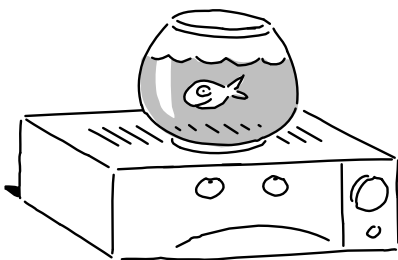

- 3 Keep your unit out of extreme hot and cold. Your unit may not work properly if it is used at extremely low or freezing temperatures. Don't place your unit near radiators, heat registers, stoves or other heat sources.

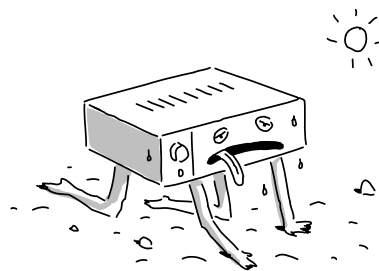

- 4 Don't put objects or liquids into the unit! NEVER permit children to put anything into the unit.
- 5 NEVER try to open the unit or take it apart.
- 6 To clean, use a clean, dry cloth. To avoid damage, NEVER use volatile solvents such as alcohol, paint thinner, gasoline, benzene, etc. to clean the cabinet. If this is an electrically-powered unit, unplug it before cleaning.

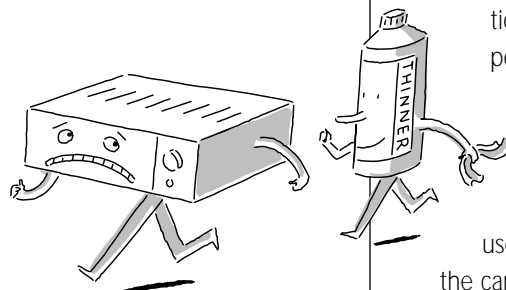

- 7 Do NOT attempt to service this unit. You should take the unit to qualified service personnel for repair when:

- Objects have fallen, or liquids have been spilled into the unit.
- The unit has been exposed to moisture.
- The unit doesn't appear to operate normally or exhibits a marked change in performance.
- The unit has been dropped or the case has been damaged.

- 8 To prevent distortion (and in some cases, discoloration of TV pictures), keep the unit away from sources of magnetic fields, such as TVs, radios, motorized toys, or magnetized objects. If the unit is magnetically-shielded (the manual will state this), it is not subject to these problems.

- 9 Do NOT place the unit on an unstable cart, shelf, stand, tripod, bracket, or table. If you mount the unit, follow the instructions in the manual and, if possible, use a mounting bracket recommended for the unit. If you place the unit on a moveable cart, use caution when moving the cart to avoid overturning it.

Placing the speakers

Finding the best locations for your speakers before you connect them to your amplifier will make routing the wires easier.

Important

Please wait until you've connected all of the cables before plugging the amplifier into the AC wall outlet and turning it on.

- For the best stereo effect, place the speakers 6 ft to 12 ft apart along the same wall, with the main listening area midway between the 2 speakers.
- Placing the speakers in opposite corners of a room does not produce a stereo effect.
- Rotate each speaker slightly toward the center of the listening area—this can improve the stereo effect, especially if the speakers are more than 8 feet apart.

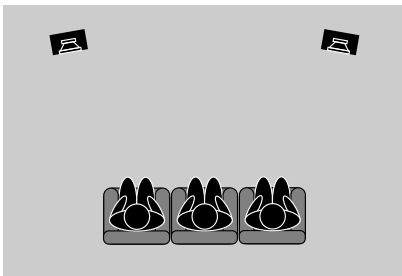

- For KVS-200 speakers, place the speakers near seated ear level. If you place them on shelves, putting them near the front edge of the shelf will help minimize reflections that can interfere with the sound.
- For more bass output, place the speakers with their backs against a wall. The increase may be very slight or it may be more pronounced. If the speakers seem to make male voices sound unnaturally heavy, or 'chesty', try moving the speakers 1 or 2 feet away from the wall.
- Placing the speakers in corners will provide maximum bass output.
- Since these speakers are magnetically shielded, you can place them close to your TV without worrying about picture discoloration. For best sound with video, place the speakers between 2 and 4 feet away from the sides of the TV.

Preparing and connecting the speaker wire

For bare wire

- 1 Strip 1/2" of the plastic cover from the ends of the wire.
- 2 Twist the wire to get rid of the loose strands.



- 3 Follow the instructions on the next page.

For spade lugs (KVS-400 and KVS-300)

- 1 Loosen the plastic caps on the speaker connectors.
- 2 Insert the spade lugs around the posts. If the lug is too narrow, insert one prong through the hole in the post, making sure that the (+) and (-) prongs don't touch each other.
- 3 Tighten the caps.

For banana or dual-banana connectors (KVS-400 and KVS-300)

- 1 Tighten the plastic caps on the speaker connectors.
- 2 Insert the banana connectors all the way into the holes in the center of the caps.

Important

- Make sure your receiver or amplifier's power cord is unplugged from the wall outlet before making any connections.
- Make sure you connect the positive connections of the speakers to the positive connections of the receiver or amplifier, and the negative connections of the speakers to the negative connections of the receiver or amplifier. If these connections are mismatched, you'll get poor bass performance and weak sound-placement characteristics.
- Check to make sure that no strands from one terminal touch any other terminal.

Connecting your KVS-400 or KVS-300 speakers

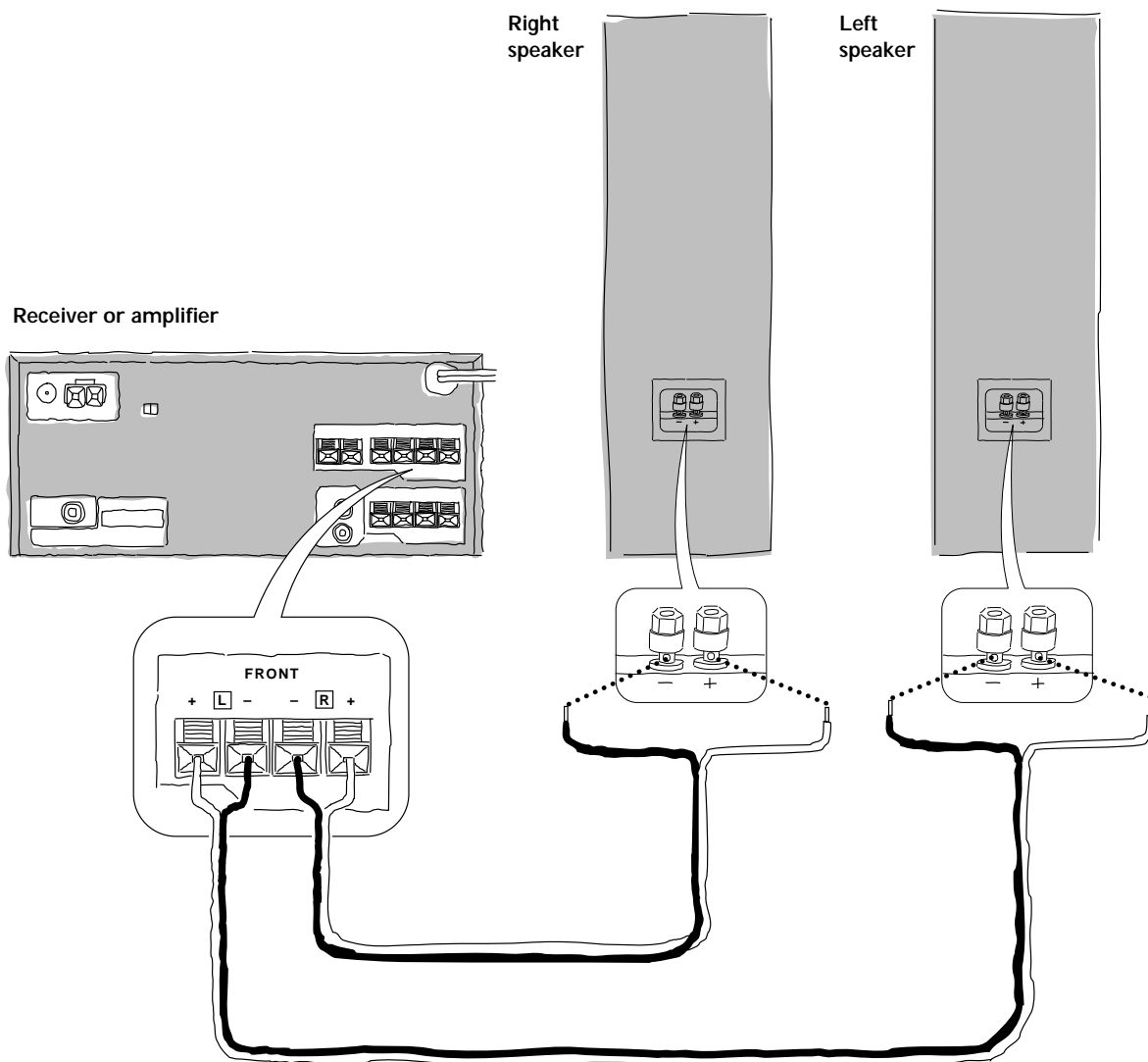

Connecting speaker wire:

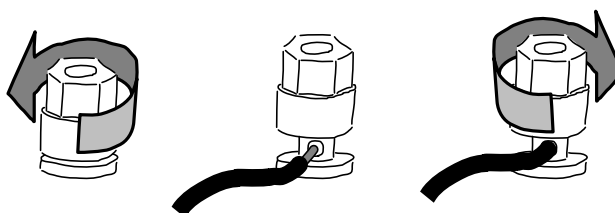

Connecting your KVS-200 speakers

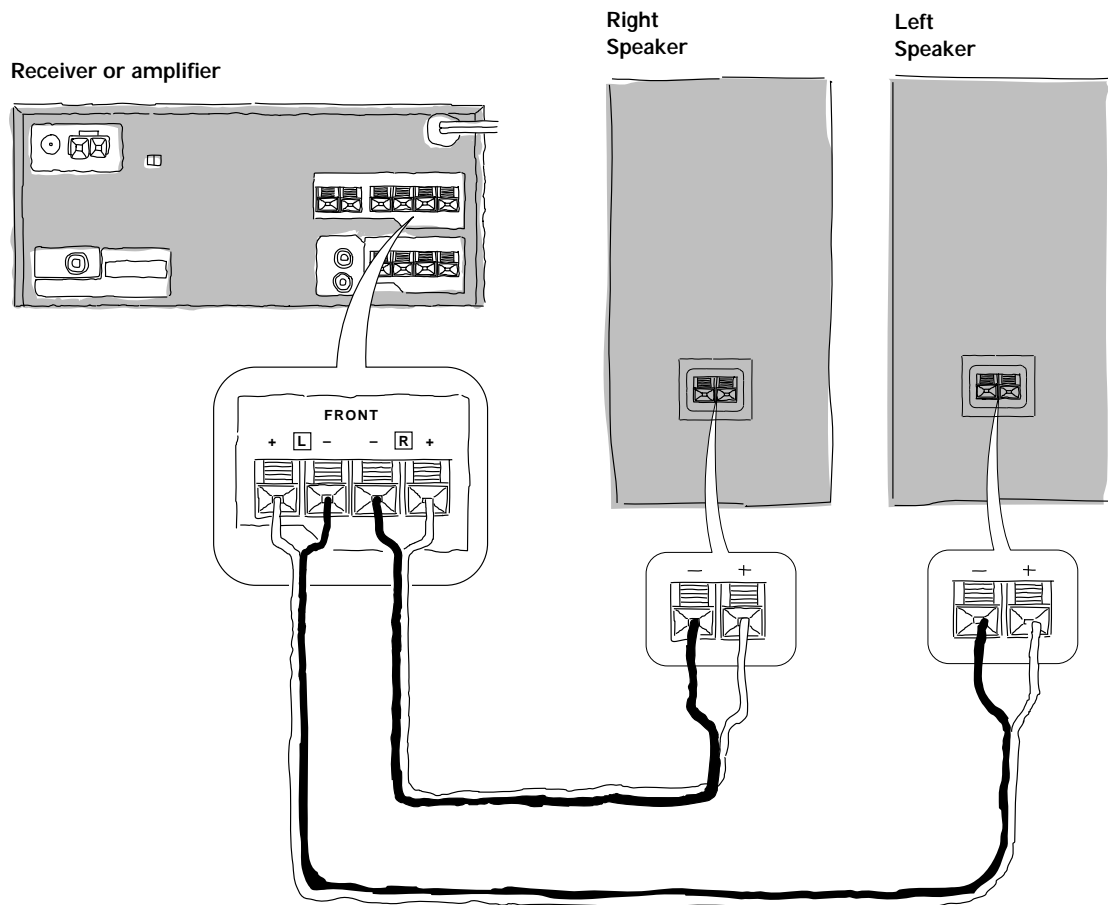

Connecting speaker wire:

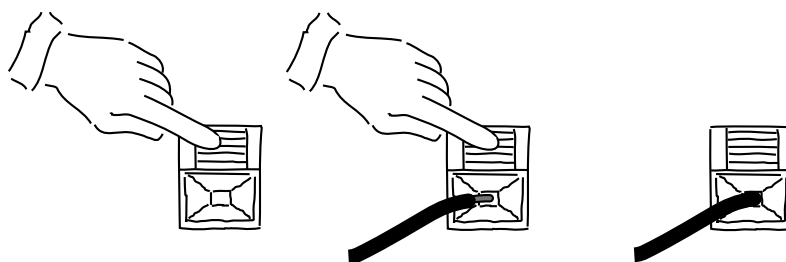

Specifications

Important

Due to product upgrades, specifications may be changed without notice.

KVS-400

Enclosure: Ported
Woofers: 8 in (2)
Midrange: 4 in polypropylene cone type
Tweeter: 3/4 in soft-dome type
Nominal impedance: 8 ohm
Power handling: 140 watts
Frequency response: 40 Hz – 20,000 Hz
Dimensions Width: 11 in
 Height: 38 in
 Depth: 11-1/8 in
Net weight: 40 lbs
Gross weight: 88 lbs
Enclosure finish: High density particle board laminated with PVC sheet

KVS-300

Enclosure: Ported
Woofer: 8 in
Midrange: 4 in polypropylene cone type
Tweeter: 3/4 in soft-dome type
Nominal impedance: 8 ohm
Power handling: 120 watts
Frequency response: 40 Hz – 20,000 Hz
Dimensions Width: 11 in
 Height: 35-7/16 in
 Depth: 11-1/8 in
Net weight: 32 lbs
Gross weight: 71-1/2 lbs
Enclosure finish: High density particle board laminated with PVC sheet

KVS-200

Enclosure: Ported
Woofer: 6-1/2 in
Tweeter: 3/4 in soft-dome type
Nominal impedance: 8 ohm
Power handling: 100 watts
Frequency response: 55 Hz – 20,000 Hz
Dimensions Width: 8-11/16 in
 Height: 17-5/8 in
 Depth: 8-3/4 in
Net weight: 13 lbs
Gross weight: 33 lbs
Enclosure finish: High density particle board laminated with PVC sheet

KENWOOD USA CORPORATION
PO Box 22745
Long Beach, California 90801-5745



Printed on recycled paper using
10% post-consumer waste.

Free Manuals Download Website

<http://myh66.com>

<http://usermanuals.us>

<http://www.somanuals.com>

<http://www.4manuals.cc>

<http://www.manual-lib.com>

<http://www.404manual.com>

<http://www.luxmanual.com>

<http://aubethermostatmanual.com>

Golf course search by state

<http://golfingnear.com>

Email search by domain

<http://emailbydomain.com>

Auto manuals search

<http://auto.somanuals.com>

TV manuals search

<http://tv.somanuals.com>