

KENWOOD

AV SURROUND STEREO AMPLIFIER

**KA-V9500**

**INSTRUCTION MANUAL**

KENWOOD CORPORATION

B60-0291-00 (K, M, Y) 93/87654321 / 92/121110987654321

# Introduction

Your choice of this product indicates that you are a devotee to excellence in sound reproduction.

We appreciate your patronage and take pride in the long tradition of quality components that our company represents.

So that you can get the most out of your unit, we suggest that you take the time to read through this manual before you hook up and operate your system. This will acquaint you with operating features and system-connection considerations so that your listening pleasure will be enhanced right from the start.

You will notice that in all aspects of planning, engineering, styling, operating convenience and adaptability we have sought to anticipate your needs and desires.

**Keep this manual handy for future reference.**

## For your records

Record the serial number, found on the back of the unit, in the spaces designated on the warranty card, and in the space provided below. Refer to the model and serial numbers whenever you call upon your dealer for information or service on this product.

Model \_\_\_\_\_ Serial Number \_\_\_\_\_

## Unpacking

Unpack the unit carefully and make sure that all accessories are put aside so they will not be lost.

Examine the unit for any possibility of shipping damage. If your unit is damaged or fails to operate, notify your dealer immediately. If your unit was shipped to you directly, notify the shipping company without delay. Only the consignee (the person or company receiving the unit) can file a claim against the carrier for shipping damage.

We recommend that you retain the original carton and packing materials for use should you transport or ship the unit in the future.

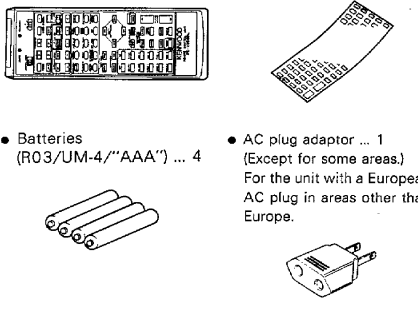

**Accessories**

- Remote control unit ... 1
- Remote control unit entry sheet ... 1
- Batteries (R03/UM-4/"AAA") ... 4
- AC plug adaptor ... 1 (Except for some areas. For the unit with a European AC plug in areas other than Europe.)



## Contents

Caution: Read the pages marked  carefully to ensure safe operation.

Introduction .....	2	Recording a video source .....	23
 Before applying power .....	3	Independent audio/video recording from source being played .....	25
 Safety precautions .....	3	Parametric equalizer operation .....	26
 IMPORTANT SAFEGUARDS .....	4	Presence feature .....	28
System connections .....	6	DOLBY PRO LOGIC, 3 STEREO adjustments .....	30
Controls and indicators .....	10	Playback with DOLBY PRO LOGIC or 3 STEREO .....	32
Remote control operation .....	12	DSP Presence .....	33
On-screen character display .....	17	DSP and DSP.LOGIC playback .....	36
Playing back an audio source .....	18	Surround Information Memory .....	38
Recording an audio source .....	20	Title Edit function .....	39
Recording an audio source while listening to another .....	21	In case of difficulty .....	41
Playing back a video source .....	22	Specifications .....	42

**⚠ Caution: Read this page carefully to ensure safe operation.**

## Before applying power

### For the U.S.A. and Canada

#### Important!

Units shipped to the U.S.A. and Canada are designed for operation on 120 volts AC only.

**Safety precaution for a Polarized AC plug**  
However, some products may be supplied with a non-polarized plug.

**CAUTION:** TO PREVENT ELECTRIC SHOCK DO NOT USE THIS (POLARIZED) PLUG WITH AN EXTENSION CORD, RECEPTACLE OR OTHER OUTLET UNLESS THE BLADES CAN BE FULLY INSERTED TO PREVENT BLADE EXPOSURE.

### For the United Kingdom

#### Important!

Units shipped to the U.K. are designed for operation on 240 volts AC only.

The mains plug must be removed from the wall socket prior to any internal examination.

The wires in this mains lead are coloured in accordance with the following code:

Blue ..... Neutral  
Brown ..... Live

The wires in this mains lead must be connected to the terminals in the plug as follows:

**Wire colour**                      **Plug terminal marking**  
Blue ..... N or Black  
Brown ..... L or Red

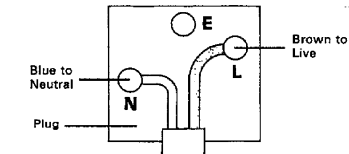

#### Notes:

1. If a 13-amp plug is used, this must be fitted with a 5-amp fuse.
2. If a 3-pin plug with earthing contact is used, no wire must be connected to the E terminal.

### For Australia and Europe

#### Important!

Units shipped to Australia are designed for operation on 240 V AC only.

Units shipped to Europe are designed for operation on 220 V AC only.

### For other countries

#### Important!

Units shipped to countries other than the above countries are equipped with an AC voltage selector switch on the rear panel. Refer to the following paragraph for the proper setting of this switch.

#### AC voltage selection

This unit operates on 110-120 or 220-240 volts AC. The AC voltage selector switch Type A or Type B on the rear panel is set to the voltage that prevails in the area to which the unit is shipped. Before connecting the power cord to your AC outlet, make sure that the setting position of this switch matches your line voltage. If not, it must be set to your voltage in accordance with the following direction.

#### Note:

Our warranty does not cover damage caused by excessive line voltage due to improper setting of the AC voltage selector switch.



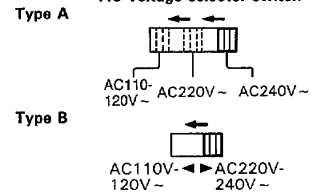

#### AC voltage selector switch



Move switch lever to match your line voltage with a small screwdriver or other pointed tool.  
This unit has two AC voltage selector switches. Be sure to set both of them together whenever the AC voltage switching is required.

## Safety precautions

**WARNING:** TO PREVENT FIRE OR SHOCK HAZARD, DO NOT EXPOSE THIS APPLIANCE TO RAIN OR MOISTURE.

  	CAUTION: TO REDUCE THE RISK OF ELECTRIC SHOCK, DO NOT REMOVE COVER (OR BACK). NO USER-SERVICEABLE PARTS INSIDE. REFER SERVICING TO QUALIFIED SERVICE PERSONNEL.
	THE LIGHTNING FLASH WITH ARROWHEAD SYMBOL, WITHIN AN EQUILATERAL TRIANGLE, IS INTENDED TO ALERT THE USER TO THE PRESENCE OF UNINSULATED "DANGEROUS VOLTAGE" WITHIN THE PRODUCT'S ENCLOSURE THAT MAY BE OF SUFFICIENT MAGNITUDE TO CONSTITUTE A RISK OF ELECTRIC SHOCK TO PERSONS.
	THE EXCLAMATION POINT WITHIN AN EQUILATERAL TRIANGLE IS INTENDED TO ALERT THE USER TO THE PRESENCE OF IMPORTANT OPERATING AND MAINTENANCE (SERVICING) INSTRUCTIONS IN THE LITERATURE ACCOMPANYING THE APPLIANCE.

## IMPORTANT SAFEGUARDS

**Caution : Read this page carefully to ensure safe operation.**

Please read all of the safety and operating instructions before operating this unit. For best results, follow all warnings placed on the unit and adhere to the operating and use instructions. These safety and operating instructions should be retained for future reference.

**1. Power sources** — The unit should be connected to a power supply only of the type described in the operating instructions or as marked on the appliance.

**2. Power-cord protection** — Power-supply cords should be routed so that they are not likely to be walked on or pinched by items placed upon or against them, pay particular attention to cords at plugs, convenience receptacles, and the point where they exit from the unit.

Never pull or stretch the cord.



**3. Grounding or polarization** — The precautions should be taken so that the grounding or polarization means of this unit is not defeated.

**4. Ventilation** — The unit should be situated so that its location or position does not interfere with its proper ventilation.

To maintain good ventilation, do not put records or a table-cloth on the unit. Place the unit at least 10 cm away from the walls.

Do not use the unit on a bed, sofa, rug or similar surface that may block the ventilation openings.

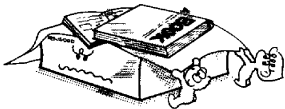

**5. Water and moisture** — The unit should not be used near water — for example, near a bathtub, washbowl, kitchen sink, laundry tub, in a wet basement, or near a swimming pool, etc.

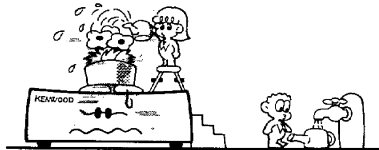

**6. Temperature** — The unit may not function properly if used at extremely low, or freezing temperatures. The ideal ambient temperature is above +5°C (41°F).

**7. Heat** — The unit should be situated away from heat sources such as radiators, heat registers, stoves, or other units (including amplifiers) that produce heat.

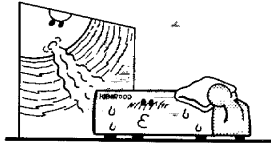

**8. Electric shock** — Care should be taken so that objects do not fall and liquid is not spilled into the enclosure through openings. If a metal object, such as a hair pin or a needle, comes into contact with the inside of this unit, a dangerous electric shock may result. For families with children, never permit children to put anything, especially metal, inside this unit.

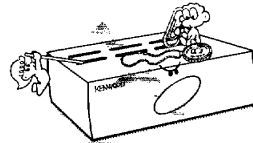

**9. Enclosure removal** — Never remove the enclosure. If the internal parts are touched accidentally, a serious electric shock might occur.

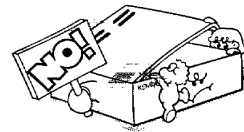

**10. Magnetic fields** — Keep the unit away from sources of magnetic fields such as TV sets, speaker systems, radios, motorized toys or magnetized objects.

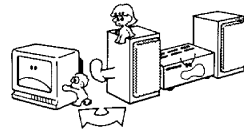

**11. Cleaning** — Do not use volatile solvents such as alcohol, paint thinner, gasoline, or benzine, etc. to clean the cabinet. Use a clean dry cloth.

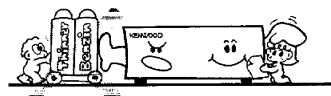

**⚠ Caution : Read this page carefully to ensure safe operation.**

**12. Carts and stands** — An appliance and cart combination should be moved with care. Quick stops, excessive force, and uneven surfaces may cause the appliance and cart combination to overturn.



**13. Nonuse periods** — The power cord of the unit should be unplugged from the outlet when left unused for a long period of time.

**14. Abnormal smell** — If an abnormal smell or smoke is detected, immediately turn the power OFF and pull out the power cord. Contact your dealer or nearest service center.

**POWER OFF!**

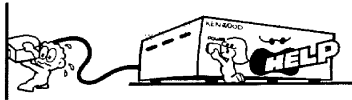

**15. Damage requiring service** — The unit should be serviced by qualified service personnel when:

- A. The power-supply cord or the plug has been damaged; or
- B. Objects have fallen, or liquid has been spilled into the unit; or
- C. The unit has been exposed to rain; or
- D. The unit does not appear to operate normally or exhibits a marked change in performance; or
- E. The unit has been dropped, or the enclosure damaged.

**16. Servicing** — The user should not attempt to service the unit beyond that described in the operating instructions. All other servicing should be referred to qualified service personnel.

**17. Outdoor antenna grounding** — If an outside antenna is connected to the receiver, be sure the antenna system is grounded so as to provide some protection against voltage surges and built up static charges. Section 810 of the National Electrical Code, ANSI/ NFPA No. 70—1984, provides information with respect to proper grounding of the mast and supporting structure, grounding of the lead-in wire to an antenna discharge unit, size of grounding con-

ductors, location of antenna-discharge unit, connection to grounding electrodes, and requirements for the grounding electrode. See Figure.

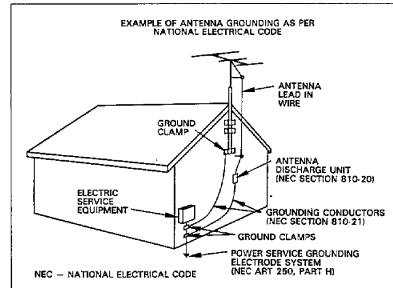

**18. Power lines** — An outdoor antenna should be located away from power lines.

**19. AC outlets** — Do not connect other audio equipment with a power consumption larger than that specified to the AC outlet on the rear panel. Never connect other electrical units, such as an iron or toaster, to it to prevent fire or electric shock.

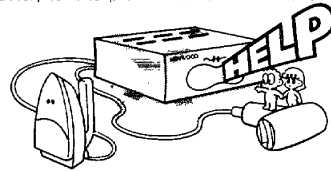

The maximum capacities indicated for the AC outlets on the rear panel of this unit are as follows.

SWITCHED outlets ; 200 W

**Notes:**

- 1. Item 3 is not required except for grounded or polarized equipment.
- 2. Item 17 and 18 are not required except for units provided with antenna terminals.
- 3. Item 17 complies with UL in the U.S.A.

## System connections

Make connection as shown in the diagram. When connecting the related system components, refer also to the instruction manuals of the related components.  
Do not plug in the power lead until all connections are completed.

### ■ Connection of audio components

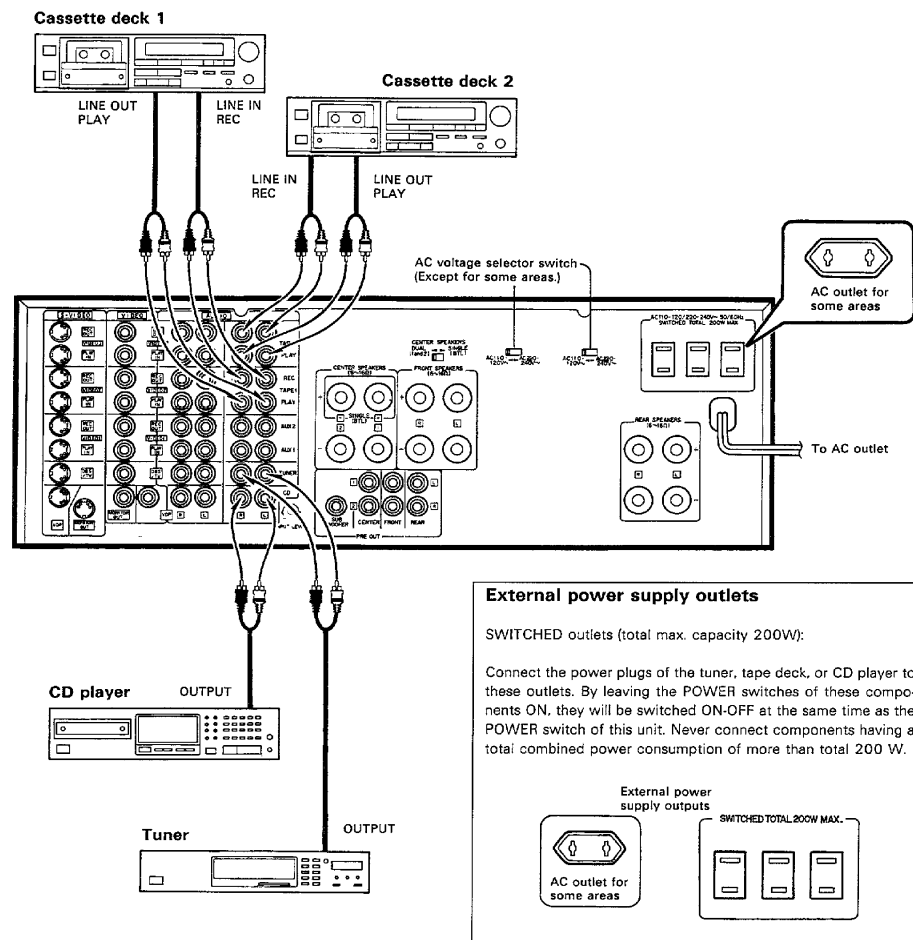

#### Notes:

1. Connect all cords firmly. If connections are loose there could be loss of sound or noise produced.
2. Do not connect up a power source which is larger than that indicated on the socket at the rear of the unit.
3. When plugging and unplugging connection cords after connections are complete, be sure to first remove the power cord from the AC outlet. Plugging/unplugging connection cords without removal of the power cord can cause malfunctions or damage to the unit.

## ■ Connection of video components

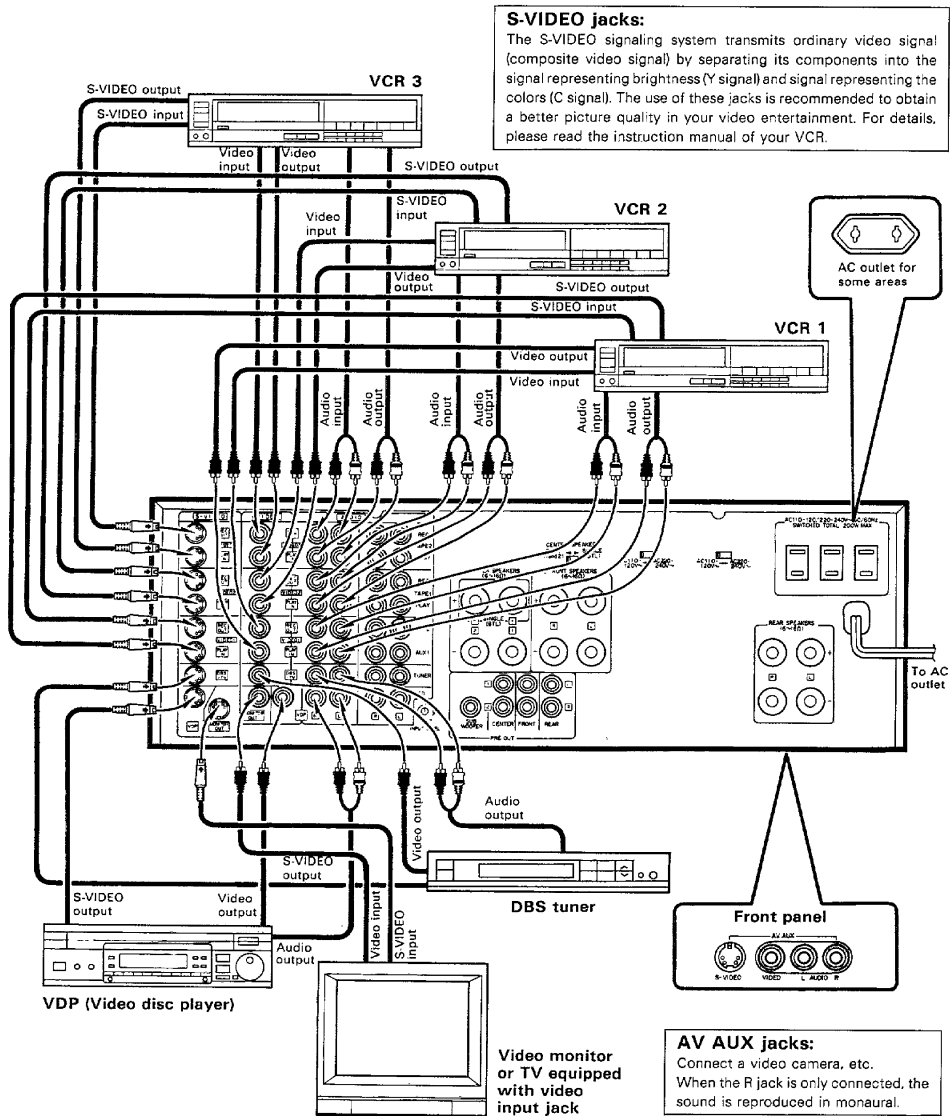

**Note:**

Be always sure to connect the S-VIDEO jack and the corresponding VIDEO jacks to a same component. Connecting them to different components may result in disturbed on-screen characters.

## Speaker connections

Connect the speakers as shown in the figure, paying attention to the core wires not to come contact with other jacks.

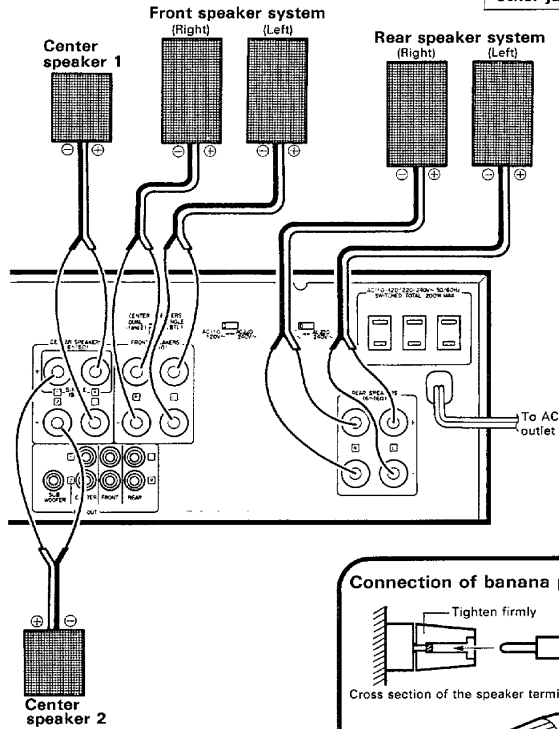

Please refer to the next page when one center speaker is connected.

### Connection of banana plug

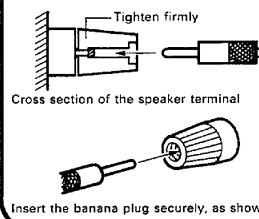

### 1 Process the cord.

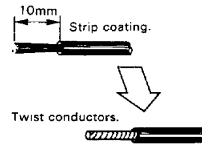

### 2 Turn counterclockwise to loosen.



### 3 Fully insert the cable.



### 4 Turn clockwise to secure the cable.

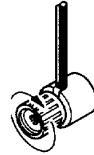

### Notes:

1. Connect all cords firmly. If connections are loose there could be loss of sound or noise produced.
2. Do not connect up a power source which is larger than that indicated on the socket at the rear of the unit.
3. When plugging and unplugging connection cords after connections are complete, be sure to first remove the power cord from the AC outlet. Plugging/unplugging connection cords without removal of the power cord can cause malfunctions or damage to the unit.

### Caution concerning speaker connections

1. Set the POWER switch to OFF before connection the speaker cords.
2. After connecting the lead wires, verify that they do not come into contact with other terminals.
3. Never short-circuit the (+) and (-) speaker cords.
4. Be sure not to inverse the left and right speaker connections or the (+) and (-) terminal polarity. This will cause the acoustic image of instruments to be unclear and the sound to be unnatural.

### WARNING!

Particular attention must be given to making good electrical contact at the amplifier-output and speaker terminals. Poor or loose connections can cause sparking or burning at the terminals because of the very high power that the amplifier can deliver.

### Speaker impedance

Front speakers, Center speakers and rear speakers Use speakers having an impedance of 6 to 16 ohms. In this case, even if only one speaker has an impedance of less than 6 ohms, damage to the amplifier may occur.



### CENTER SPEAKERS switch

Up to two center speakers can be connected to this unit.  
Set the CENTER SPEAKERS switch according to the number of the center speakers.

- ① **When one center speaker is connected:** (the output power is doubled compared to two-speaker operation)  
**Connect the speaker to the SINGLE (BTL) terminals.**

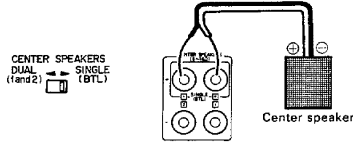

- Sound will not be output correctly if the switch is in the DUAL (1 and 2) position.
- The center balance adjustment is not possible.

- ② **When two center speakers are connected:**

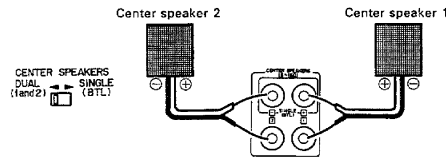

- Sound will not be output correctly if the switch is in the SINGLE (BTL) position.

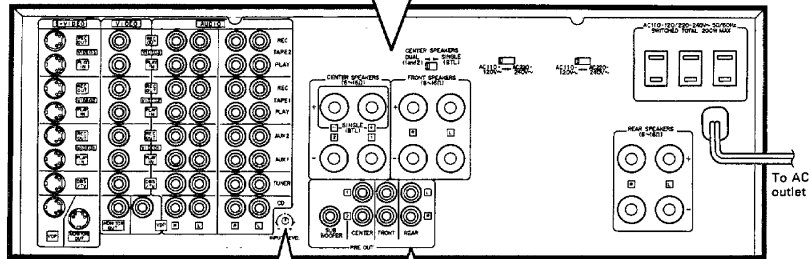

#### INPUT LEVEL control

If the reproduced sound is distorted, adjust this control to suppress distortion. For normal operation, set to the center position.

### Connection of PRE OUT jacks

Sound will not be output from the speakers if they are connected directly to the PRE OUT jacks. The output from these jacks should be connected to speakers with built-in amplifier or to exclusive amplifiers to which the speakers are connected.

- ① **Connection to CENTER, FRONT and REAR jacks**

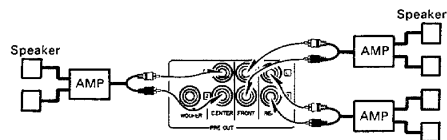

- When the CENTER jacks are connected, be sure to set the CENTER SPEAKERS switch to DUAL (1 and 2) position.
- Use these jacks if you want to listen to the speakers with larger volumes or with different tones.

- ② **Connection to SUB WOOFER jack**

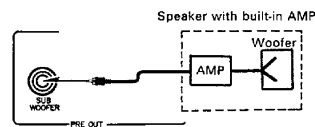

If you want to listen to richer bass sound, connect the exclusive amplifier for the woofer to this jack, and connect the woofer speaker to the amplifier.

# Controls and indicators

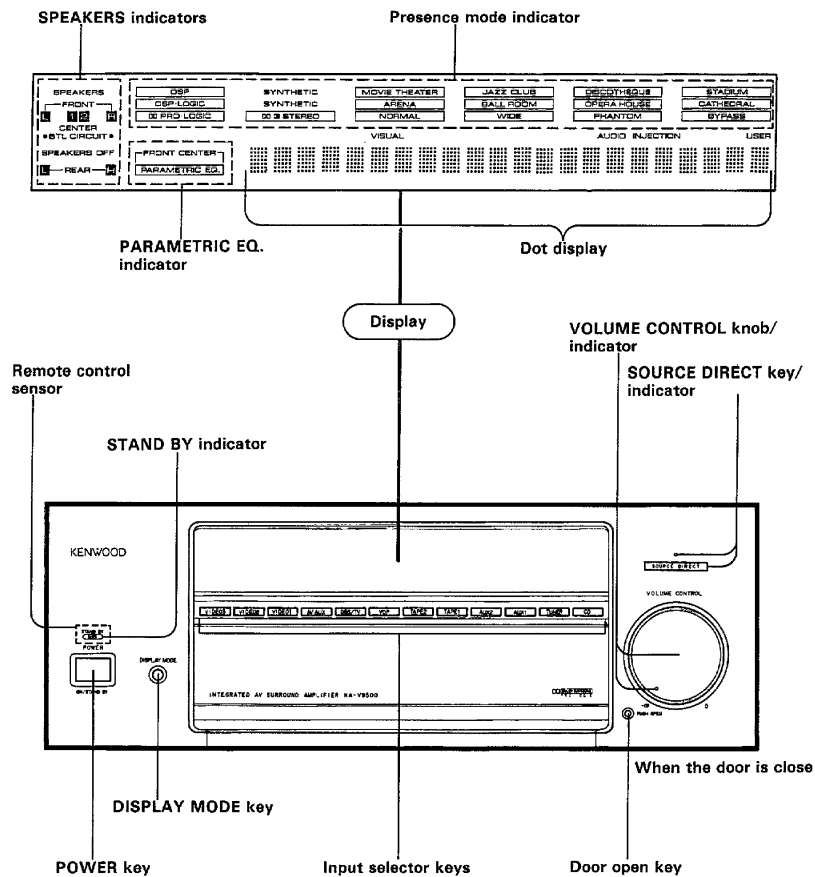

**DISPLAY MODE key**

Every press of this key switches the displayed contents as follows.

Indicators and dot display → Dot display only → OFF

↑

- Both the indicators and dot display are displayed for about 5 seconds after another operation key is pressed.

**STAND BY mode of POWER key**

When the power cord of this system is plugged into an AC outlet, the STAND BY indicator lights up regardless of the ON/OFF setting of the POWER key. This indicates that a small amount of current is being supplied to the unit to back up the memory contents. This mode is referred to as the Stand By mode. While the STAND BY indicator is lit, the power of the system can be switched ON/OFF from the remote control unit.

How to open the door

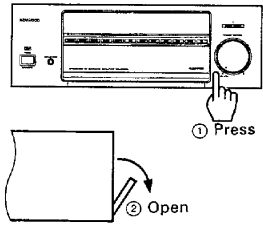

How to close the door

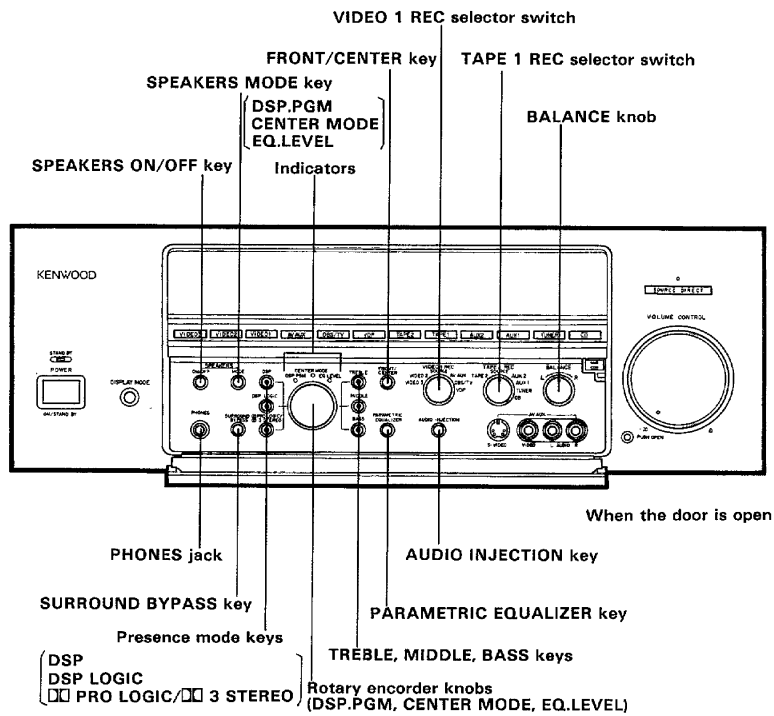
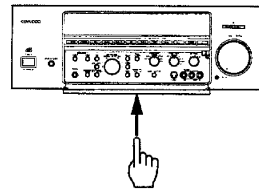

# Remote control operation

## ■ Loading batteries

### 1 Remove the battery cover.

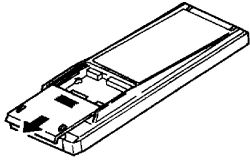

- While gently pressing the battery cover located on the rear of the remote control unit, slide it in the direction of the arrow.

### 2 Insert the provided four batteries.

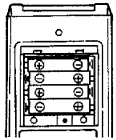

- Make sure that the batteries are inserted as indicated with the polarity markings on the bottom.

**Note:**

The batteries provided are to be used for checking the remote control operations. Their service life may be short.

### 3 Close the battery cover.

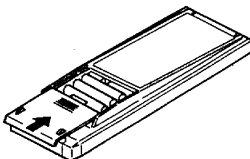

## Replacing batteries

1. If the TRANSMIT indicator does not light even when the operation key is pressed, the batteries are exhausted. Replace the batteries. We recommend that the alkaline batteries (LR03/AM-4) which have longer service life be used.
2. The programmed contents are not immediately lost when the batteries are removed for replacement. However, they could be lost if the unit is left without batteries for more than 3 minutes. In such a case, the programming should be performed again. The function signals of the non-learning, or fixed keys are not lost even in this case.

**Note:**

Avoid using old and new batteries together, as this may cause corrosion.

## ■ Operating range of the remote control unit

The normal operating range may change depending on temperature, humidity, and other environmental conditions, but it is roughly specified as shown in the figure.

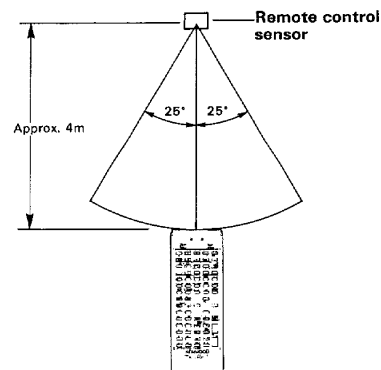

**Model name: RC-V9500L**  
**Transmission system:**  
**infrared pulse system**

**Notes:**

1. If two or more remote control operation keys are to be pressed successively, press each key securely and leave an interval of more than 1 second between presses. Pressing a key immediately after pressing another key may cause malfunction.
2. Malfunction may occur in case direct sunlight or the light of a high-frequency lighting fluorescent lamp enters the remote control light receptor. In such a case, change the installation position of the unit so that the malfunction does not occur.

## Names of controls

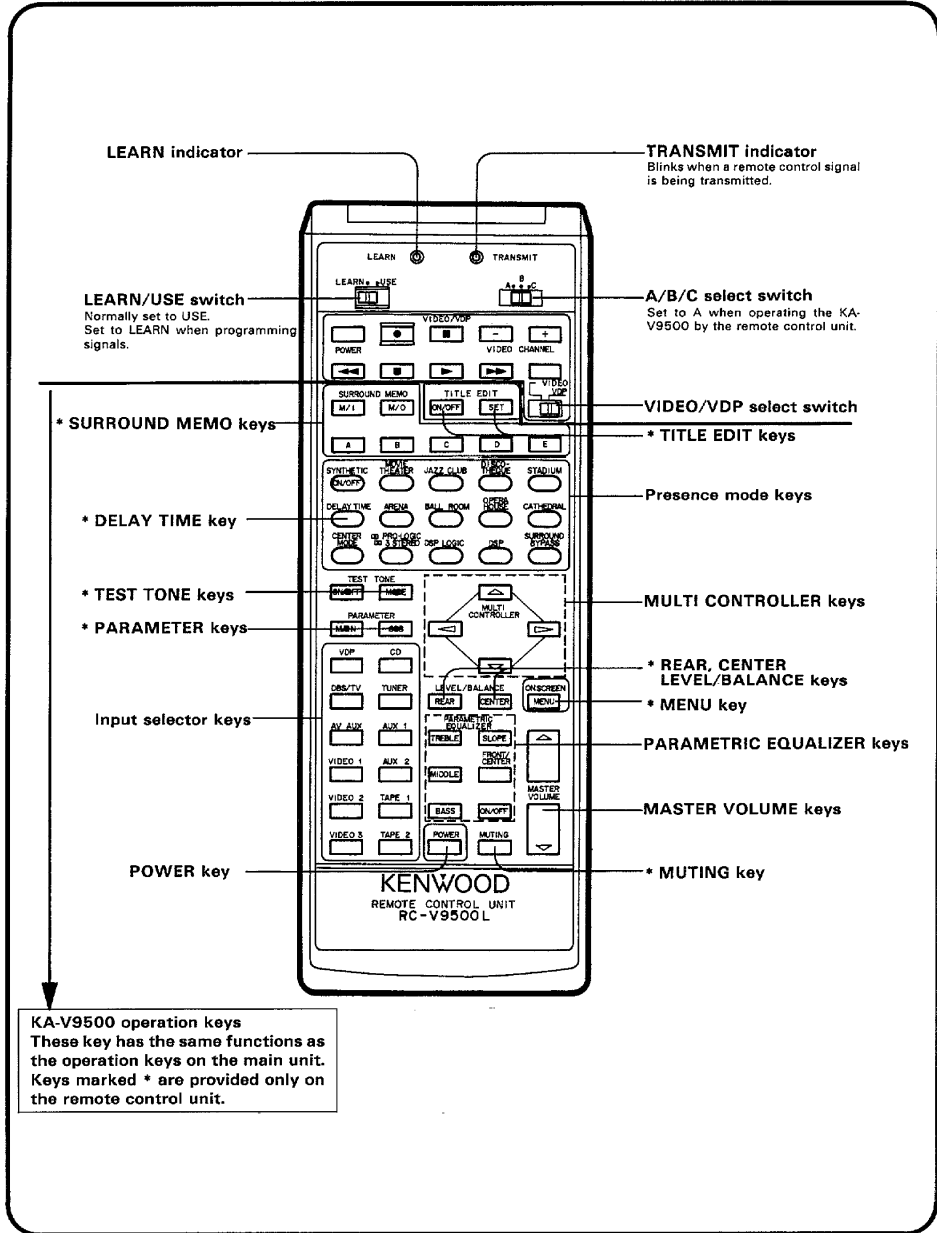

### ■ Using the unit as a programmable remote control unit

The remote control functions of other audio and video components can be programmed (stored) in this unit. For the programming operation, refer to page 17.

Set to USE.

**The programmable keys (learning keys) vary depending on the position of the A/B/C select switch.**

**In "A" position:**  
The remote control functions of a video component can be programmed (stored) under the operations keys in this section.

**In "B" or "C" position:**  
All keys are usable as the programming keys (learning keys). Program (Store) the remote control functions of any other audio or video component under them.

**A/B/C select switch**

**VIDEO/VDP keys**

**VIDEO/VDP select switch**

When both a video cassette recorder and an LD player is used, set this switch to select VIDEO (video cassette recorder) or VDP (LD player). This switch is not valid when the A/B/C switch is in the "C" position.

**KENWOOD**  
REMOTE CONTROL UNIT  
RC-V9500L

For your convenience, it is recommended to write the programmed (stored) functions on the provided entry sheets. Use a oil-ink felt pen, pencil, etc., for writing. For erasing, use an ordinary eraser and rub with a strong force.

■ How to program the remote control functions of other components under the "learning" keys of this remote control unit

**1** Set the LEARN/USE switch to LEARN.

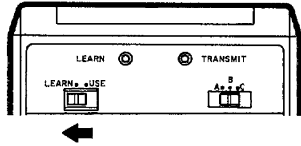

**2** Set the A/B/C select switch to the desired position.

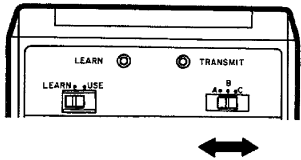

**3** Place the remote control unit of another component with this remote control unit (RC-V9500L) so that their heads (signal transmitters) face each other.

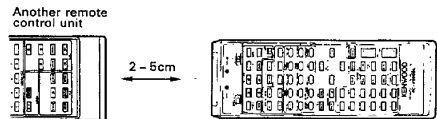

**4** Press the learning key of RC-V9500L under which you want to program the function signal.

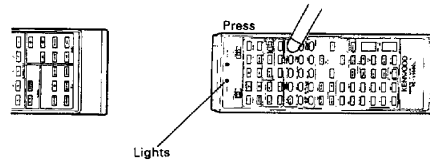

• LEARN indicator will light up.

**5** Within 30 seconds after pressing the key above, press and hold the key of the other remote control unit which contains the function to be programmed (stored).

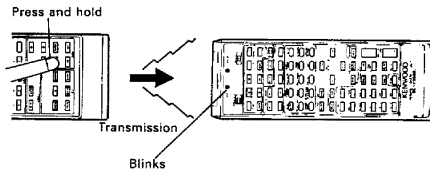

• The LEARN indicator changes from steady lighting to blinking, indicating that the function signal is being programmed.

**6** When the LEARN indicator goes off after blinking twice, release your finger from the key of the other remote control unit

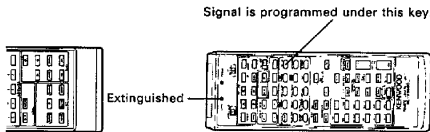

- Be sure to hold the key of the other remote control unit depressed until the LEARN indicator goes out.
- The programming is completed when the LEARN indicator goes out after two times of blinking.
- To program another function signal under another key, repeat steps 4 to 6 above.

■ To check the programmed (stored) contents

1 Set the LEARN/USE switch to USE.



2 Press the key you want to check the function of.

3 Check to see if the intended function is activated.

■ To change the programmed (stored) contents

Re-start the programming (storing) operation.

- The previously-programmed contents are cleared automatically and replaced by the newly-programmed contents.

■ To perform normal remote control operation

1 Set the LEARN/USE switch to USE.



2 Press the "learning" key under which the required function signal has been programmed.

- The TRANSMIT indicator blinks and the remote control function is performed.

■ To clear the whole of the programmed (saved) contents

1 Set the LEARN/USE switch to LEARN.



2 Set the A/B/C switch to "C".



3 Press any key.

- The LEARN indicator lights up.

4 Remove the battery case cover on the rear of the remote control unit.

5 Press the Reset key inside the battery case with a ball-point pen tip, etc.

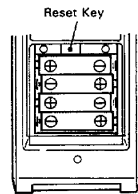

- All of the previously-programmed contents are cleared simultaneously and the remote control unit is reset to the initial condition.

Almost all of the remote control systems used with other AV components use the same infrared system as this unit. This means that this unit is capable of programming the functions of almost all remote-controllable components. Before programming, please read carefully the instruction manuals of other AV components as well as this Instruction Manual.

Notes:

1. If the optical output power of the other remote control unit is too large, programming could fail. In such a case, place the remote control unit at a greater distance from this remote control unit.
2. If both the LEARN indicator and TRANSMIT indicator blink simultaneously, either the key is not a "learning" key which can be used for programming or the current programming is incomplete. In such cases, program the function again under a "learning" key.
3. Programming is also impossible if the other remote control unit uses a signal format other than the infrared system, if it uses a special signal modulation format, or if the storage capacity of this unit has become full.
4. 30 seconds after a "learning" key is pressed, the LEARN indicator goes from on to off (extinguished). As programming is impossible while the indicator is off, press the "learning" key again to light the indicator.
5. If more than one "learning" key is pressed, the function signal is programmed under the last pressed key.
6. Never attempt to program (store) the remote control functions of appliances other than AV components, such as air conditioners.



# On-screen character display

The on-screen character display appears on the monitor TV screen when specific operations are performed. The information on the present setup various modes can be checked by pressing the MENU key on the remote control unit. Whether the on-screen display is displayed or not can also be set.

## ■ Checking the modes Remote control unit only

Example: In case DSP.LOGIC and Parametric Equalizer is ON

**1** Press the MENU key.



• The TV screen changes to the condition shown in Fig. (A)

**2** Press the MENU key more again.



• Every time the key is pressed, the display changes from Fig. (A) to Fig. (K) repeatedly in cycle.

The display which appears when the MENU key is pressed changes according to the mode of the unit.

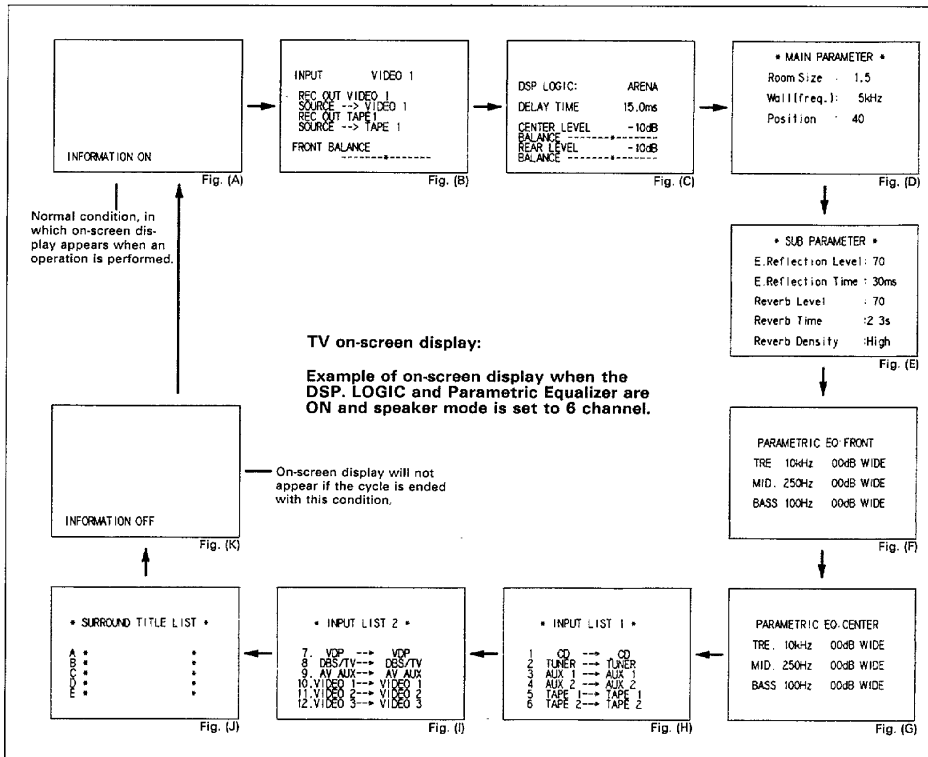

### Notes:

- On-screen displays shown in Fig. (A) and Fig. (K) remains for about 1.5 second. Other displays will not change until the MENU key is pressed.
- If the above cycle is terminated with "INFORMATION OFF" display, the on-screen character display will not appear in later operations.
- If it is required to have on-screen character display afterward, terminate the cycle with "INFORMATION ON".

# Playing back an audio source

## Basic operation procedure

### 1 Minimize the volume.

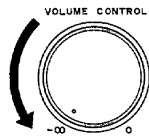

- Turn the VOLUME CONTROL fully counterclockwise.

### 2 Press the POWER key to ON.

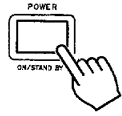

### 3 Press the FRONT SPEAKERS key to ON.

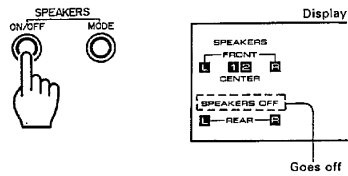

- The **SPEAKERS OFF** indicator goes off.

### 4 Select the desired source to be played.

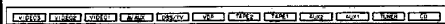

### 5 Play the selected source component.

### 6 Adjust the volume.

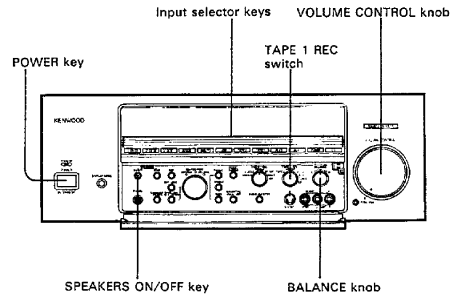
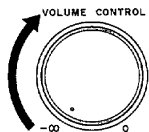

### 7 Adjust the left and right volume balance.

- 1 Turn the BALANCE control lightly clockwise or counterclockwise.

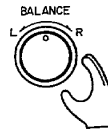

- The left and right volumes vary automatically.

- 2 Release your finger when an optimum balance is obtained.

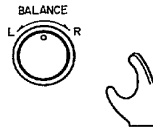

- The BALANCE control knob returns to the CENTER position.

### 8 Adjust the tone.

- For the parametric equalizer, please refer to page 26.

#### Note:

If the TAPE 1 input selector key is selected while the TAPE 1 REC switch is set to TAPE 2, characters "TAPE 1" on the display will blink. In this case, set the TAPE 1 REC switch to SOURCE.

**To mute sound temporarily**  
**Remote control unit only**



- Press again to resume the previous volume.

**SOURCE DIRECT key**

When this key is pressed, the indicator lights up and the source selected by the input selector key can be reproduced with a higher sound quality.

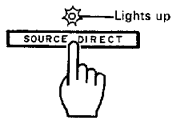

- The unit enters the bypass mode. In this mode, the input audio signal does not pass through the parametric equalizer and balance adjustment circuits, so the tone and balance adjustments are not effective.

**To cancel SOURCE DIRECT function:**

Press again.

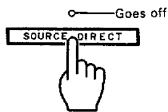

- The SOURCE DIRECT function is also canceled automatically when any Presence mode is selected or SURROUND BYPASS mode is set to ON.

**Note:**

If the reproduced sound is distorted, adjust the INPUT LEVEL control on the rear panel to suppress distortion.

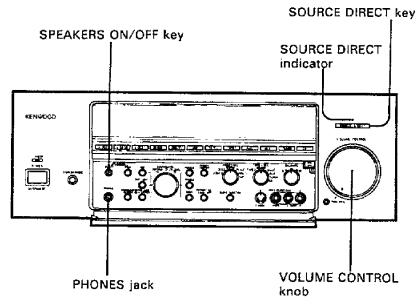
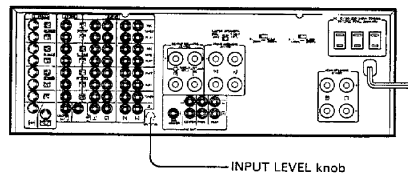

**How to listen through headphones**

- 1 Insert the headphone plug into the PHONES jack.**



- 2 Turn the speakers OFF.**

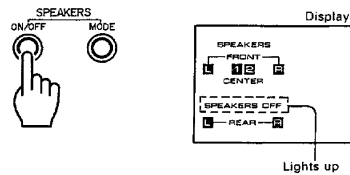

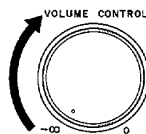

- The [SPEAKERS OFF] indicator lights up.

- 3 Adjust the volume.**



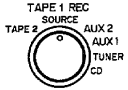
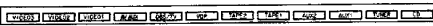

## Recording an audio source



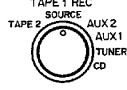

- How to record sound on cassette decks connected to the TAPE 1 and TAPE 2 jacks

- 1 Set the TAPE 1 REC switch to SOURCE.
 
- 2 Select the recording source.
 

- 3 Start recording on the cassette deck(s).
  - Simultaneous recording on TAPE 1 and TAPE 2 is possible.

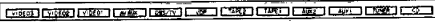
- How to dub sound from cassette deck 1 (connected to TAPE 1 jacks) to cassette deck 2 (connected to TAPE 2 jacks)

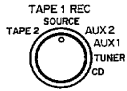
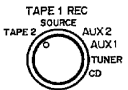
- 1 Set the TAPE 1 REC switch to SOURCE.
 
- 2 Press the TAPE 1 input selector key.
 

- 3 Start recording on cassette deck 2.
- 4 Start playing cassette deck 1.

- How to dub sound from cassette deck 2 (connected to TAPE 2 jacks) to cassette deck 1 (connected to TAPE 1 jacks)

Dubbing while listening to another source	Dubbing while listening to the sound of cassette deck 2
<ol style="list-style-type: none"> <li>1 Select the source to be listened to.                 </li> </ol>	<ol style="list-style-type: none"> <li>1 Set the TAPE 1 REC switch to SOURCE.                </li> </ol>
<ol style="list-style-type: none"> <li>2 Set the TAPE 1 REC switch to TAPE 2.                </li> </ol>	<ol style="list-style-type: none"> <li>2 Press the TAPE 2 input selector key.                 </li> </ol>
<ol style="list-style-type: none"> <li>3 Start recording on cassette deck 1.</li> </ol>	<ol style="list-style-type: none"> <li>3 Start recording on cassette deck 1.</li> </ol>
<ol style="list-style-type: none"> <li>4 Start playing cassette deck 2.</li> </ol>	<ol style="list-style-type: none"> <li>4 Start playing cassette deck 2.</li> </ol>

**Note:**

The signal dubbed, or recorded on the cassette decks cannot be processed by the Surround or PARAMETRIC EQUALIZER control circuitry.

## Recording an audio source while listening to another

The TAPE 1 REC switch of this unit allows to record a sound on cassette deck 1 independently from the source being listened to.

### ■ Independent recording on cassette deck 1

#### 1 Select the source to be listened to.

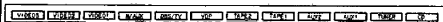

#### 2 Select the source to be recorded onto cassette deck 1.

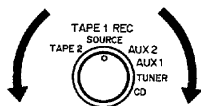

- If the switch is set to SOURCE, the source selected by the input selector key will be recorded.

#### 3 Put cassette deck 1 in the record mode.

#### 4 Adjust the volume.

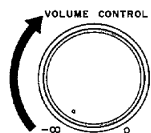

- The source selected by the input selector key is reproduced, while another source can be independently from it.

#### Note:

When TAPE 2 is selected with the TAPE 1 REC switch while the TAPE 1 input selector key is selected, characters "TAPE 1" on the display will blink. In this case, press an input key other than TAPE 1.

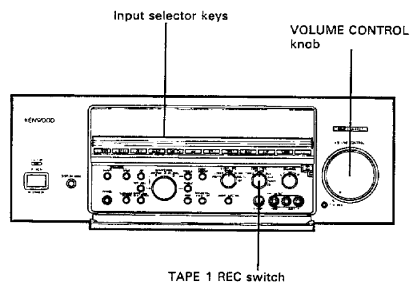

#### TV screen when the TAPE 1 REC switch is set to CD

TV screen:

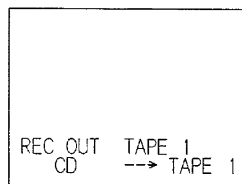

## Playing back a video source

### ■ How to play a video source

**1** Switch ON the power of the monitor TV connected to the MONITOR OUT jacks.

**2** Select the video source to be viewed.

VIDEO3 VIDEO2 VIDEO1 AV/AUX DBS/TV VDP



**3** Start playing the selected video component.

- The picture is reproduced on the monitor TV screen, and the sound is reproduced through the speakers.

**4** Adjust the volume.

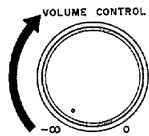

- The audio operation procedure is the same as that described in "Playing back an audio source".

#### Note:

The characters "VIDEO 1" in the display window will blink if the VIDEO 1 is selected with the input selector key when the VIDEO 1 REC switch is set to either VIDEO 2 or VIDEO 3. In this case, set the VIDEO 1 REC switch to SOURCE.

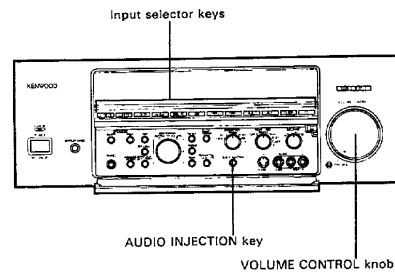

### ■ Audio Injection operation

This feature allows to replace the audio of the video source being played back with the audio of another source.

① Play a video source.

② Press the AUDIO INJECTION key.



③ Select the source to replace the audio.

VIDEO3 VIDEO2 VIDEO1 AV/AUX DBS/TV VDP



To cancel audio injection

Press the AUDIO INJECTION key again.



TV screen when the TUNER audio is selected for Audio Injection

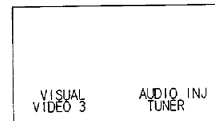

- The Audio Injection function is also canceled when the POWER is switched OFF.

## Recording a video source

### ■ Video/audio recording on video deck(s) 1/2/3

**1** Set the VIDEO 1 REC switch to SOURCE.



**2** Select the source to be recorded.



**3** Start recording on VCR 1.

- The selected source being recorded can be monitored on the monitor TV during recording.

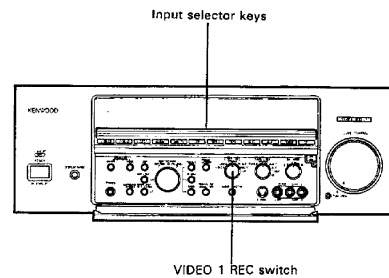

### ■ Dubbing from video deck 1 to video deck 2 or 3

**1** Set the VIDEO 1 REC switch to SOURCE.



**2** Press the VIDEO 1 input selector key.



**3** Put video deck 2 or 3 in the record mode.

**4** Put video deck 1 in the play mode.

- The video and audio of video deck 1 can be monitored during dubbing.

■ Dubbing from video deck 2 to video deck 3

**1** Set the VIDEO 1 REC switch to SOURCE.



**2** Press the VIDEO 2 input selector key.



**3** Put video deck 3 in the record mode.

**4** Put video deck 2 in the play mode.

■ Dubbing from video deck 3 to video deck 2

**1** Set the VIDEO 1 REC switch to SOURCE.



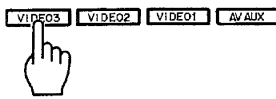

**2** Press the VIDEO 3 input selector key.



**3** Put video deck 2 in the record mode.

**4** Put video deck 3 in the play mode.

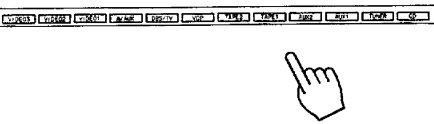
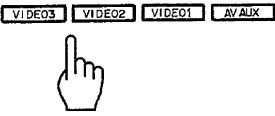
■ Dubbing from video deck 2 or 3 to video deck 1

To monitor the video and audio during dubbing	To listen to another source during dubbing
<p><b>1</b> Set the VIDEO 1 REC switch to SOURCE.</p> 	<p><b>1</b> Select the source to be listened to.</p> 
<p><b>2</b> Press the VIDEO 2 or VIDEO 3 input selector key.</p> 	<p><b>2</b> Set the VIDEO 1 REC switch to VIDEO 2 or VIDEO 3.</p> 
<p><b>3</b> Put video deck 1 in the record mode.</p>	<p><b>3</b> Put video deck 1 in the record mode.</p>
<p><b>4</b> Put video deck 2 or 3 in the play mode.</p>	<p><b>4</b> Put video deck 2 or 3 in the play mode.</p>



## Independent audio/video recording from source being played

The VIDEO 1 REC switch of this unit allows to record the audio/video signals onto the VCR 1 independently from the source selected for playback.

### ■ How to record audio/video on VCR 1 independently from the source being played

#### 1 Select the source to be played back.

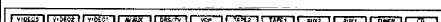

#### 2 Select the source to be recorded onto the VCR 1.

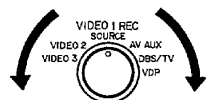

- If the switch is set to SOURCE, the source selected by the input selector key will be recorded.

#### 3 Start recording on the VCR 1.

- You can listen to the source selected by the input selector key, while the VCR 1 records the source selected by the VIDEO 1 REC switch.

#### Note:

If the VIDEO 1 REC switch is set to VIDEO 2 or VIDEO 3 while VIDEO 1 has been selected by the input selector keys, characters "VIDEO1" on the display blinks. In this case, select other source than VIDEO 1 by the input selector keys and try again.

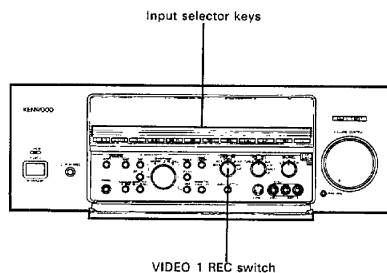

#### Example of on-screen character display

This unit incorporates the model name preset function (see page 40). This function allows to store the model names of other system components so that you can record them by identifying them with the model names.

When the DBS/TV input is recorded to the VIDEO 1 (KV-D958S) output, while the tuner (KT-5020) broadcast input is played.

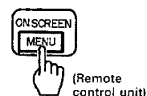

(Remote control unit)

```
INPUT      KT-5020
REC OUT VIDEO 1
DBS/TV    --> KV-D958S
```

# Parametric equalizer operation

## Parametric equalizer

The parametric equalizer is an equalizer system which can adjust the center frequency and curve (Q) slope of each frequency band. With this unit, the center frequency of the BASS band is fixed at 100 Hz and that of the TREBLE band is fixed at 10 kHz, but that of the MIDDLE band can be selected from 250 Hz, 400 Hz, 630 Hz, 1.0 kHz, 1.6 kHz, 2.5 kHz and 4.0 kHz. The slope of the curve (Q) can be selected between WIDE and NARROW for each of the BASS, MIDDLE and TREBLE bands. In addition, these equalizer setting can be given independently to the FRONT and CENTER speakers.

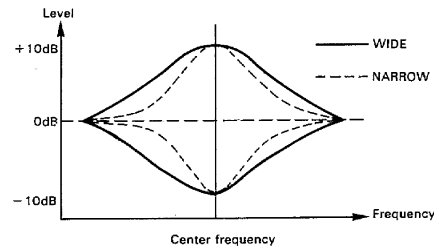

## ■ Preparation for creation of equalizer curve

### 1 Press the PARAMETRIC EQUALIZER key.

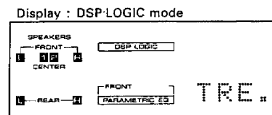
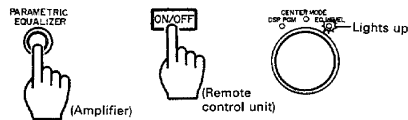

- The EQ LEVEL indicator is displayed.

### 2 Select the FRONT or CENTER speakers.

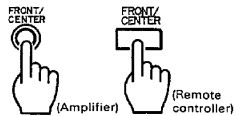

When FRONT is selected

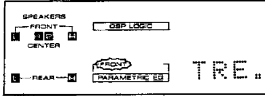

When CENTER is selected

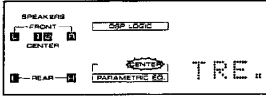

- Every press alternates FRONT ↔ CENTER.
- The equalizer effect can be applied independently to the front and center speakers. However, in the DSP mode, the equalizer effect cannot be applied to the center speaker(s).

### TV screen:

```
PARAMETRIC EQ: FRONT
TRE 10kHz 00dB WIDE
MID. 250Hz 00dB WIDE
BASS 100Hz 00dB WIDE
```

### Display:

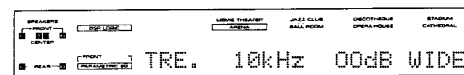

## ■ Adjusting the tone

### Bass frequency adjustment

① Press the BASS key.

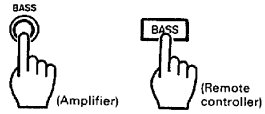

② Adjust the level.

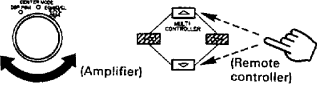

• The adjustment range is within  $\pm 10$  dB.

③ Select the slope of the curve. (Remote control unit)

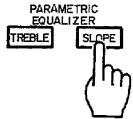

• Every press alternates WIDE and NARROW.

### Middle frequency adjustment

① Press the MIDDLE key.

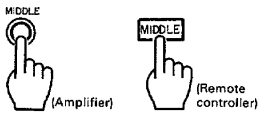

② Select the center frequency.

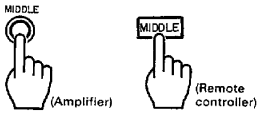

• Every time the MIDDLE key is pressed, the center frequency is switched to 250 Hz, 400 Hz, 630 Hz, 1.0 kHz, 1.6 kHz, 2.5 kHz and 4.0 kHz.

③ Adjust the level.

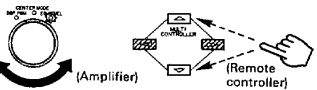

• The adjustment range is within  $\pm 10$  dB.

④ Select the slope of the curve. (Remote control unit)

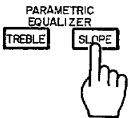

### Treble frequency adjustment

① Press the TREBLE key.

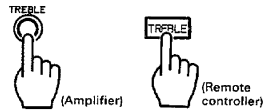

② Adjust the level.

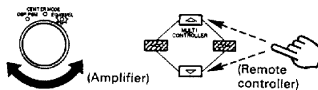

• The adjustment range is within  $\pm 10$  dB.

③ Select the slope of the curve. (Remote control unit)

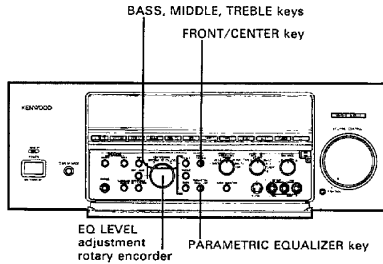
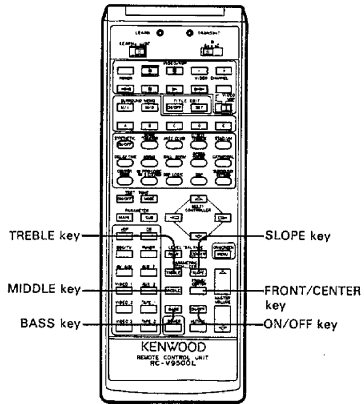
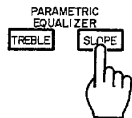

# Presence feature

## Presence effects

Why do we feel the sounds in movie theaters, concert halls and stadiums so powerful and live? Because the sound reaches us not only from the front, but from all other directions surrounding us. To reproduce this ambience as close as possible to the reality, this unit incorporates three types of Surround decoder circuits for use with different types of music sources. Every presence mode provided by these circuits uses a dedicated DSP (Digital Signal Processor) to allow creation of an amazing acoustic field without compromising the sound quality. To make full use of the Presence effects, read the following instructions carefully and perform equipment installation and adjustments that suit your individual listening room.

### ① Digital DOLBY PRO LOGIC Surround

Video and LD software packages marked with  incorporate the same Dolby Surround information as "Dolby Stereo" movies in the recording. The Digital DOLBY PRO LOGIC Surround decoder built into this unit makes it possible to enjoy such software packages with the same audio effects as in movie theaters.

- Set the center speaker mode according to the speaker layout (see page 29).

### ② Digital DOLBY 3 STEREO

When the right and left speakers are installed away from each other, the center sound image becomes fade. DOLBY 3 STEREO mode gives the directivity effect to enhance the center sound image. (Refer to page 29.)

### ③ DSP Presence

An advanced digital signal processing adds to the enjoyment of stereo audio sources such as CD, TAPE and TUNER. This unit creates the DSP Presence sound fields (hall tones) of these sources by means of the 18-bit A/D converters which perform high-level conversion of analog signals into digital signals, as well as of the computer simulation and dedicated DSP (Digital Signal Processor) which create early reflection and reverberation sound signals. By combining these signals, the parameters such as the room sizes, walls and listening positions can be set so that realistic feeling proper to live performances can be reproduced in the living rooms of households.

- This unit provides ten preset DSP Presence sound-field patterns. (See page 33.)
- It is also possible to create the user's own sound fields by combining parameters. (See page 34.)
- Set the SPEAKERS MODE key according to your speaker layout. (See page 29.)

### ④ DSP LOGIC Presence

Video and LD software packages marked with  incorporate the same Dolby Surround information as "Dolby Stereo" movies in the recording. The DSP LOGIC Surround decoder built into this unit makes it possible to enjoy such software packages with the same audio effects as in movie theaters. The DSP LOGIC Surround decoder creates the same realistic feeling as the powerful sound surrounding us in movie theaters, concert halls and stadiums by adding early reflection sound and reverberation sound signals to the output signal from the directivity enhancer circuit.

- This unit provides eight preset DSP LOGIC Presence sound-field patterns. (See page 33.)
- It is also possible to create the user's own sound fields by combining parameters. (See page 34.)
- Set the SPEAKERS MODE key according to your speaker layout. (See page 29.)

The information set in the above mode can be stored in the surround information memory. (Refer to page 38.)

Manufactured under license from Dolby Laboratories Licensing Corporation. Additionally licensed under one or more of the following patents: U.S. numbers 3,632,886, 3,746,792 and 3,959,590; Canadian numbers 1,004,603 and 1,037,877. "Dolby" and the double-D symbol  are trademarks of Dolby Laboratories Licensing Corporation.

## ■ Speaker layouts

It is possible to use either one of two center speakers.

### Standard layout

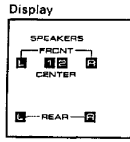
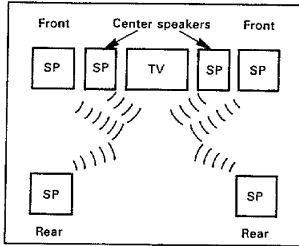

- DOLBY PRO LOGIC mode**  
 Set the center mode according to the center speakers used.  
 ... **NORMAL** (when compact speakers are used)  
 ... **WIDE** (when medium-sized or larger speakers are used)

- DSP and DSP.LOGIC modes**



Press repeatedly until the display becomes as shown on the left.

- Select the desired sound-field pattern (see page 36).

### In case rear (Surround) speakers are not used

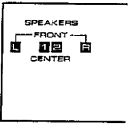
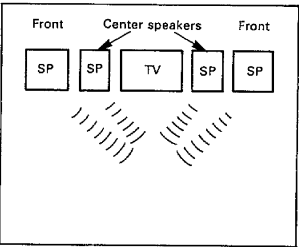

- DOLBY 3 STEREO mode**  
 Set the center mode according to the center speakers used.  
 ... **NORMAL** (when compact speakers are used)  
 ... **WIDE** (when medium-sized or larger speakers are used)

- DSP and DSP.LOGIC modes**



Press repeatedly until the display becomes as shown on the left.

- Select the desired sound-field pattern (see page 36).

### In case center speakers are not used

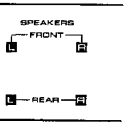
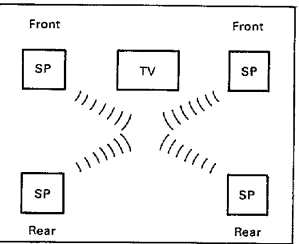

- DOLBY PRO LOGIC mode**  
 Set the center mode to PHANTOM.  
 ... **PHANTOM**

- DSP and DSP.LOGIC modes**



Press repeatedly until the display becomes as shown on the left.

- Select the desired sound-field pattern (see page 36).

### In case only two speakers are used

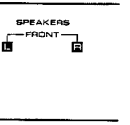
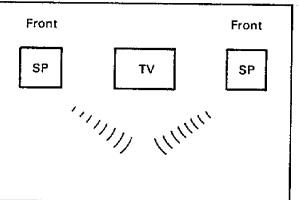

#### DSP mode



Press repeatedly until the display becomes as shown on the left.

- Select the desired sound-field pattern (see page 36).
- The Dolby Surround play is not possible with this layout.

# DOLBY PRO LOGIC, 3 STEREO adjustments (Remote control unit)

## ■ Adjustments in NORMAL or WIDE mode (in DOLBY PRO LOGIC or 3 STEREO mode)

Preparation: Set the parametric equalizer to OFF.

### 1 Enter the DOLBY PRO LOGIC or 3 STEREO mode.



- The DOLBY PRO LOGIC mode and 3 STEREO mode are alternated every time the key is pressed.

### 2 Select the NORMAL or WIDE mode.



- Every time the CENTER MODE key is pressed, the center modes of the DOLBY PRO LOGIC mode are switched in the following order: NORMAL → WIDE → PHANTOM

The center modes of the 3 STEREO mode are switched alternately as follows:  
NORMAL ↔ WIDE

### 3 Turn the test tone ON.

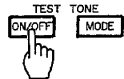

- Press from your listening position.

### 4 Press the TEST TONE MODE key.

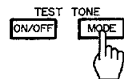

- Every time the key is pressed, noise-like test tone is output from different speakers in order of Left → Center → Right → Rear (Rear speakers are not used in 3 STEREO mode). Holding the key depressed switches the test tone modes every 2 seconds.

### 5 Adjust the balance between all speakers so that their volumes are the same.

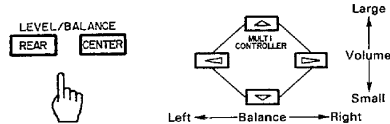

- When two center speakers are used, adjust the left and right balance of them.
- The REAR BALANCE controls are adjusted to make the volume levels from the right and left rear speakers equal.
- The rear speakers are not used in the 3 STEREO mode. In this case, therefore, adjust so that the volumes from the three front speakers are equal.

### 6 Terminate the adjustment.

- Press the TEST TONE ON/OFF key to OFF.

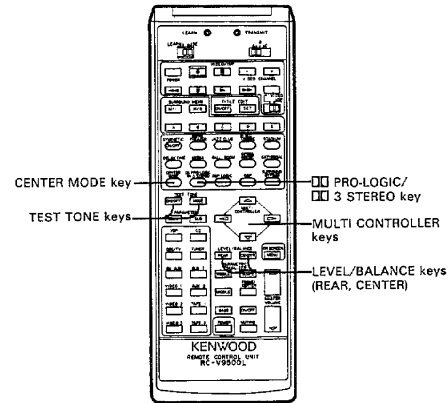

### TV screen during adjustment:

In DOLBY PRO LOGIC, NORMAL or WIDE mode:

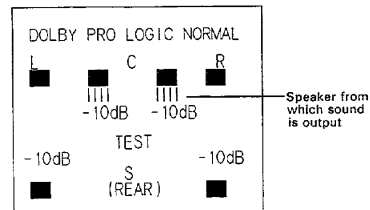

In Dolby 3 Stereo, Normal or Wide mode:

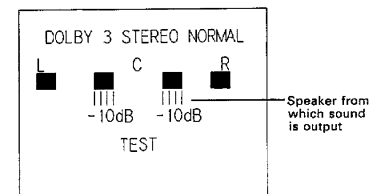

## ■ Adjustments in PHANTOM mode (in DOLBY PRO LOGIC mode only)

Preparation: Set the parametric equalizer to OFF.

### 1 Enter the DOLBY PRO LOGIC mode.



- The DOLBY PRO LOGIC mode and 3 STEREO mode are alternated every time the key is pressed.

### 2 Select the PHANTOM mode.



- Every press of the key switches NORMAL → WIDE → PHANTOM

### 3 Turn the test tone ON.

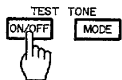

- Press from your listening position.

### 4 Press the TEST TONE MODE key.

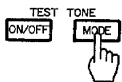

- Every time the key is pressed, a noise-like test tone is output alternately from the front and rear speakers. Holding the key depressed switches the test tone modes every 2 seconds.

### 5 Adjust so that the volumes from the four speakers are almost equal.

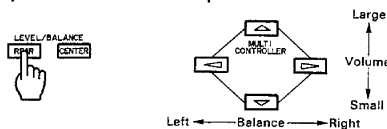

- The REAR BALANCE controls are adjusted to make the volume levels from the right and left rear speakers equal.

### 6 Terminate the adjustment.

- Press the TEST TONE ON/OFF key to OFF.

## ■ Adjustments in input balance

The input balance is adjusted automatically.

"This unit features an automatic input balance control, eliminating the need to adjust L/R input balance for different sources and optimizing performance of the DOLBY PRO LOGIC Surround/DOLBY 3 STEREO decoding by minimizing crosstalk."

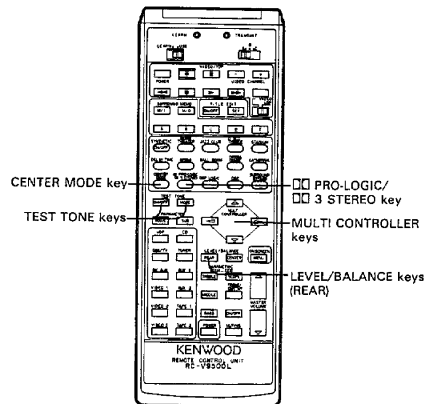

TV screen during adjustment:

In DOLBY PRO LOGIC, PHANTOM mode:

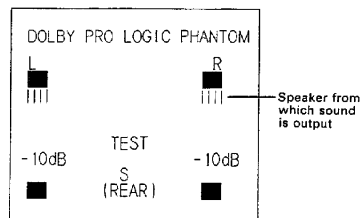

Display:

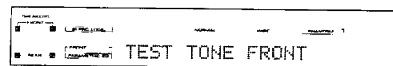

# Playback with DOLBY PRO LOGIC or 3 STEREO

Before start playback, adjust the unit referring to the procedures on pages 30 or 31.

## 1 Enter the DOLBY PRO LOGIC or 3 STEREO mode.



- The DOLBY PRO LOGIC mode and 3 STEREO mode are alternated every time key is pressed.

## 2 Select the center mode.

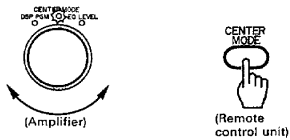

- The mode changes in the order of NORMAL, WIDE, then PHANTOM (except when 3 STEREO).

## 3 Adjust the volume.

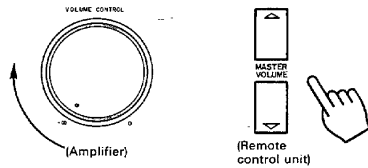

## 4 Set the delay time.

Remote control unit only

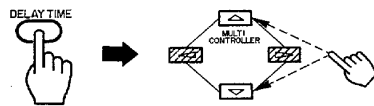

- In the DOLBY PRO LOGIC mode, the delay time can be set within the range from 15 to 30 ms in 0.5 ms steps.
- Refer to "How to set the delay time" on page 35.
- In the DOLBY 3 STEREO mode, the delay time can not be adjusted.

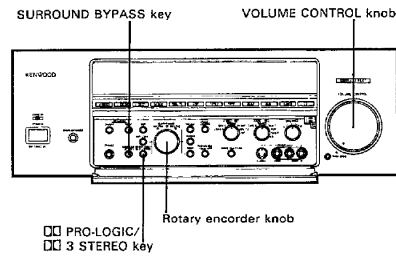
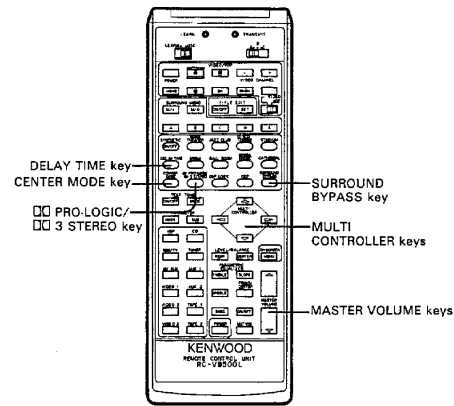

## To cancel

Press the BYPASS key.

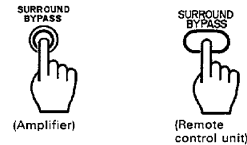

- Be sure to set the Bypass mode whenever the Surround effects are not used.

## Note:

The output from the CENTER SPEAKERS terminals or PRE OUT CENTER jack on the rear panel is output only in the NORMAL and WIDE modes of the DOLBY PRO LOGIC mode and the DOLBY 3 STEREO mode.



## DSP Presence

### DSP (Digital Signal Processor)

The DSP allows to synthesize the early reflection and reverberation sound signals in order to create various sound-field effects without compromising the sound quality of music sources.

This unit provides two DSP Presence modes; the DSP mode and the DSP.LOGIC mode.

#### DSP mode:

Provides eight sound field patterns as well as the SYNTHETIC MOVIE THEATER and SYNTHETIC ARENA modes for use with monaural sources.

#### DSP.LOGIC mode:

Applies a directivity enhancement to the DSP mode to enable even better acoustic image positioning. Eight sound field patterns are available.

### Preset sound field effects using DSP

This unit incorporates 10 kinds of preset sound field patterns, so that various sound field effects can be enjoyed by selecting a preset pattern according to the music source. The main and sub parameters and parametric equalizers are adjusted according to the sound field effect patterns.

In addition, it is also possible to obtain desired sound field patterns by adjusting the parameters forming them. Refer to page 34 for the parameters.

### Kinds and effects of preset sound field patterns

Select an optimum sound pattern according to the music source.

Sound Field Pattern	Effect
MOVIE THEATER	Sound field of a high-quality movie theater.
JAZZ CLUB	Early reflection sound is concentrated in the period from 20 to 70 msec. A realistic and live sound field.
DISCOTHEQUE	Early reflection sound is concentrated in a short period, providing a concentrated feeling of energy rather than expansion.
STADIUM	The interval of early reflection sound is widely dispersed. A sound field like the sound from the PA equipment in an outdoor stadium.
ARENA	Sound field of a wide and deep hall, where the interval of early reflection sound is widely dispersed. The hall size may accommodate an audience of around 2500 people.
BALL ROOM	A hall with a medium size accommodating an audience of around 1300.
OPERA HOUSE	Sound field of an opera house, where the level of early reflection sound is high and the reverberation after it attenuates slowly.
CATHEDRAL	Sound field of a large cathedral, where the early reflection sound has a long delay and the reverberation after it lasts for a long period.
SYNTHETIC MOVIE THEATER SYNTHETIC ARENA	When playing a monaural source, use them in the DSP mode. These patterns cannot be used in the DSP.LOGIC mode.

**DSP parameters**

In addition to the selection of preset sound field patterns, the Surround effect can also be enjoyed by adjusting the following parameters to obtain a sound field that matches your taste.

**1. Main parameters**

- ① **Room Size** ..... Adjusts the interval of early reflection sound waves to simulate the room size. The size of a standard listening room is assumed to be 1, and the parameter can be adjusted in the range from 0.5 to 2.0 in steps of 0.1.
- ② **Wall** ..... Simulates the sound reflected by walls. The higher the set frequency, the harder the simulated walls are (1 to 16 kHz, 1 kHz steps).
- ③ **Position** ..... Defines the listening position. The adjustment range is from 1 to 100. When the parameter becomes larger, the listening position moves to the rear.

**2. Sub parameters**

- ① **Early Reflection Level** ..... Determines the live feeling of the listening room. The adjustment range is from 0 to 100 in steps of 1. Increasing the value increases the live feeling.
- ② **Early Reflection Time** ..... Determines the listening room size and listening point which is the position of the listener. The adjustment range is from 1 to 60 ms in 1 ms steps. Increasing the value increases the simulated distance between the sound source and listener.
- ③ **Reverb level** ..... Represents the level of the reverberation sound. The adjustment range is from 0 to 100 in steps of 1. Increasing the value increases the reflections from the simulated walls.
- ④ **Reverb Time** ..... Adjusts the time until the reverberation sound fades out. The adjustment range is from 0.5 to 4.0 sec. in 0.1 sec. steps.
- ⑤ **Reverb Density** ..... Adjusts the reverberation density to obtain an optimum reverberation according to the music source. The adjustment is performed in three steps of High, Mid and Low.

**Note:**

The Reverb Level, Reverb Time and Reverb Density parameters are not operated with the "MOVIE THEATER", "JAZZ CLUB", "DISCOTHEQUE", "STADIUM" and "SYNTHETIC MOVIE THEATER" patterns.

**Example of a concert hall**

**Types of sound**

As shown in this example of a concert hall, the listener hears the sound of the piano played on the stage as a composite sound consisting of the direct sound from the piano, indirect sound which are reflected by the ceiling and side and back walls before reaching the listener's ears, and reverberation sound which fades after repeating several reflections.

The indirect sound is always transmitted through a longer spatial distance than the direct sound, and the time it takes before reaching the listener is referred to as the delay time. This indirect sound with certain delay time plays a critical role in providing better sound effect and live feeling of the hall. The sound field setting in your listening room may also be dependent on the positions of the speakers. It is recommended to vary and try different delay times to obtain an optimum sound field.

**Variation of sound**

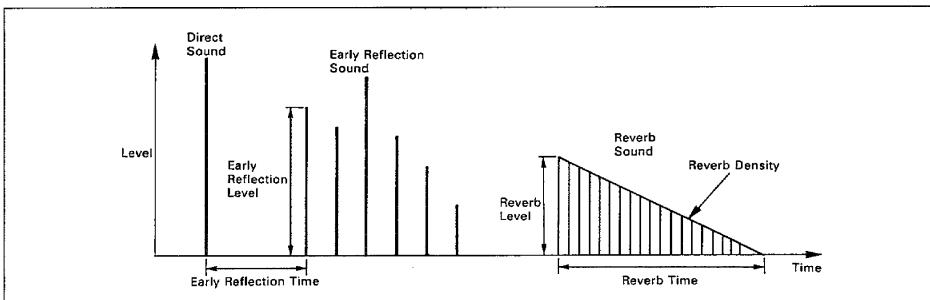

## Parameter adjustments

### ① Room Size

- Adjusts the intervals between early reflection waves.

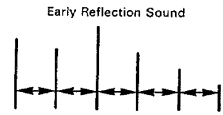

### ② Early Reflection Level

- Adjusts the level of the early reflection.

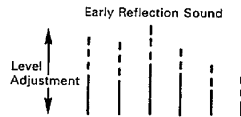

### ③ Early Reflection Time

- Adjusts the period until the early reflection starts.

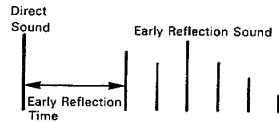

### ④ Reverb Level

- Adjusts the level of the reverberation.

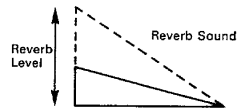

### ⑤ Reverb Time

- Adjusts the period of the reverberation.

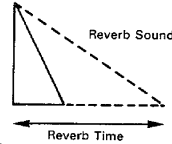

### ⑥ Reverb Density

- Adjusts the density of reverberation waves.

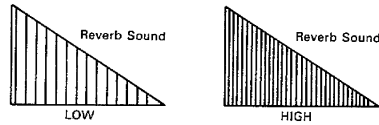

## How to set the delay time

The delay time adjustment is required to compensate for the difference between the distance from your listening position to the front speakers and distance from your listening position to the rear (Surround) speakers. Set the optimum difference based on the following formula.

- Delay time based on the rear speaker position and listening position

$$\text{Delay time} = 20 \text{ ms} + 3 \text{ ms} \times (A_m - B_m)$$

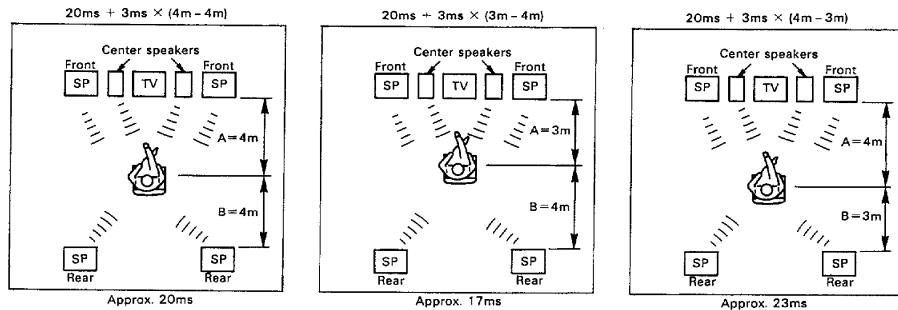

# DSP and DSP.LOGIC playback

## ■ Playback using preset sound field patterns

### 1 Select the DSP or DSP.LOGIC mode.

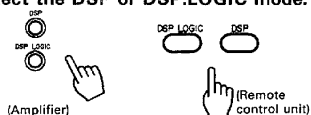

### 2 Select the speaker mode.

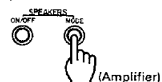

- Refer to page 29.

### 3 Select the desired preset sound field pattern.

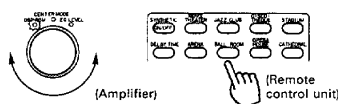

- The main and sub parameters and parametric equalizers are adjusted according to the sound field effect patterns.

### 4 Adjust the center speaker balance.

**Remote control unit only**

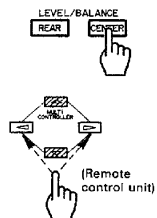

- In case two center speakers are used.

### 5 Set the delay time (DSP.LOGIC mode only).

**Remote control unit only**

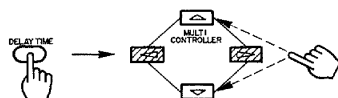

- The delay time can be set in the range from 0 to 80 ms in 0.5 ms steps.
- Refer to "How to set the delay time" on page 35.
- The delay time cannot be set in the speaker modes which do not use the rear speakers.

#### Note:

When the mode is changed from SYNTHETIC MOVIE or SYNTHETIC ARENA to DSP.LOGIC, then the DSP mode is set, the unit automatically set to MOVIE THEATER or ARENA mode.

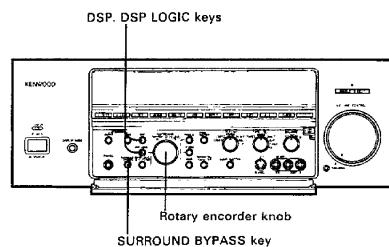
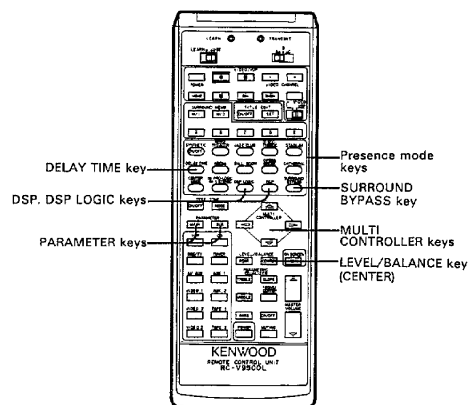

### To cancel

Press the BYPASS key.

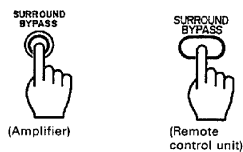

- Be sure to set the bypass mode when Surround playback is not required.

## ■ Creating user's own sound field Remote control unit only

Based on one of the preset patterns built in the unit, it is also possible to create your own sound field by adjusting desired parameters.

Select one of the preset patterns.

### Set the main parameters.

The following parameters are switched in the cycle of ① → ② → ③ every time the MAIN key is pressed.

#### ① Room Size setting

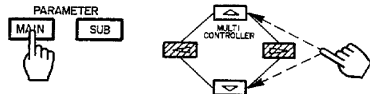

- Adjust in the range from 0.5 to 2.0 in steps of 0.1.

#### ② Wall setting

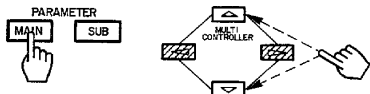

- Adjust in the range from 1 to 16 kHz in 1 kHz steps.

#### ③ Position setting

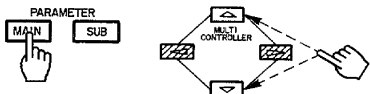

- Adjust in the range from 1 to 100 in steps of 1.

### Adjust the parametric equalizer.

- Refer to page 26 for the adjustment procedure.
- In the DSP mode, the center parametric equalizer is not effective.

#### Notes:

1. When any other sound pattern key is pressed, the whole setting of the parameter and parametric equalizer is canceled and returned to the initial condition which is suitable for the sound field pattern. When it is required to store the setting you created in memory, use the Surround Information Memory function (refer to page 38).

When any other operation key is pressed, the parametric equalizer is not canceled.

2. Parameters "Reverb Level", "Reverb Time" and "Reverb Density" cannot be varied in modes "MOVIE THEATER", "JAZZ CLUB", "DISCOTHEQUE", "STADIUM" and "SYNTHETIC MOVIE THEATER".

### Set the sub parameters.

The following parameters are switched in the cycle of ① → ② → ③ every time the SUB key is pressed.

#### ① Early Reflection Level setting

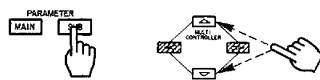

- Adjust in the range from 0 to 100 in steps of 1.

#### ② Early Reflection Time setting

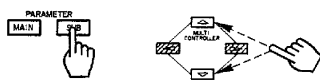

- Adjust in the range from 1 to 60 ms in 1 ms steps.

#### ③ Reverb Level setting

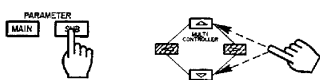

- Adjust in the range from 0 to 100 in steps of 1.

#### ④ Reverb Time setting

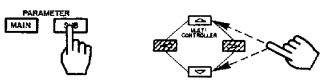

- Adjust in the range from 0.5 to 4.0 sec. in 0.1 sec. steps.

#### ⑤ Reverb Density setting

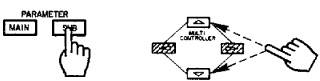

- Adjust in three steps of High, Mid or Low.

#### TV display:

##### Main parameter display

```

* MAIN PARAMETER *
Room Size : 1.5
Wall(freq.): 5kHz
Position : 40
    
```

The parameter whose colon ":" is blinking can be set.

##### Sub parameter display

```

* SUB PARAMETER *
E.Reflection Level: 70
E.Reflection Time : 30ms
Reverb Level : 70
Reverb Time : 2.3s
Reverb Density : High
    
```

# Surround Information Memory

## Surround information memory and Surround title lists functions

For the enjoyment in Surround modes, it is required to set the levels of the channels, delay time, etc., as described on pages 32, 33, 34, 36 and 37. The Surround information memory function makes it possible to store such information in memory.

Example: To enjoy movie in Dolby Pro Logic Surround, Normal mode

- ① Front and Center parametric equalizer curves
- ② Surround mode selection → Dolby Pro Logic
- ③ Center mode selection → NORMAL position
- ④ Channel level adjustments using test tone
- ⑤ Delay time setting

The Surround information is set by the steps above. The Surround Information Memory function allows to store up to five sets of Surround information set in this way in memory. In addition, a name can be assigned to each set of information by means of the Surround Title List function.

### ■ How to save Surround setup in memory

(from the remote control unit only)

**1 Press the M/I (Memory Input) key.**



TV screen

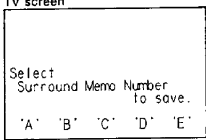

**2 Save the current setup in memory.**

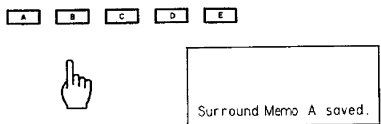

- Press desired one of the [A] to [E] keys.
- The current parametric equalizer curves, Surround mode, delay time, center level, center balance, rear level and rear balance, etc.

**Note:**

If the parametric equalizer is OFF while the source direct function is activated or the Surround mode is Bypass, the display as shown below appears and the Surround information cannot be stored in memory.

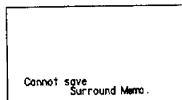

### ■ How to recall a Surround setup

(from the remote control unit only)

**1 Press the M/O (Memory Output) key.**



TV screen

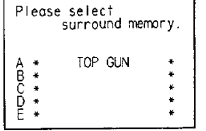

**2 Recall a memory.**

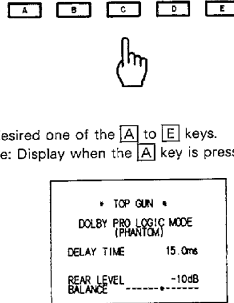

- Press desired one of the [A] to [E] keys.
- Example: Display when the [A] key is pressed

**Note:**

The title name is displayed when it has been input with the Title Edit function. Please also refer to "Title Edit function".

## Title Edit function (Remote control unit)

The input selection display or Surround memory name on the TV screen can be replaced with a desired title. The title characters can be change according to the components.

### Surround title list function

A title (movie name, video production title, etc.) can be saved together with the each Surround setup saved by the Surround information memory function described on page 38 (using max. 16 characters).

### ■ How to make a Surround title list

#### 1 Press the TITLE EDIT ON/OFF key.

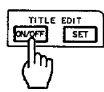

• TITLE EDIT •  
Please select  
MODEL NAME PRESET or  
SURROUND TITLE LIST

#### 2 Select the memory bank to assign the title.

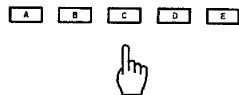

- Press one of memory No. keys [A] to [E] corresponding to the Surround information memory you want to assign a title.

#### 3 Select the desired letter or numeral.

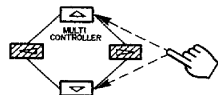

- The characters registered for use in title entry are shown in Table 1 on page 40.
- Example when [A] is pressed at step 2 above.

• TITLE EDIT •  
SURROUND TITLE LIST  
MEMO A  
• TOP 0. • Enter desired character

#### 4 Establish the entry of the selected character.

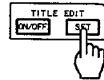

- The selected character is entered, and the character entry cursor moves to the right by one position and blinks there.
- To continue character entry, repeat steps 3 and 4.

#### Move the character position.

If you commit a mistake:

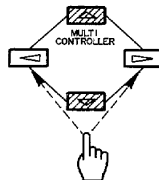

- Move the blinking cursor to the position of the character to be modified.
- Perform steps 3 and 4 to modify the character.

#### 5 Terminate the entry.

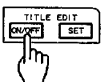

- The entry operation is completed and the title is changed.
- The entered characters appear on the display.

### How to title-edit the model name

This function allows to enter the model name of a component used in your system. (MAX 8 characters)

#### 1 Press the TITLE EDIT ON/OFF key.

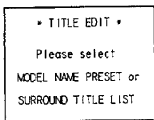
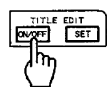

- The display returns to the previous condition if no key has been pressed for about 15 seconds.

#### 2 Select the component for which the model name is to be entered.

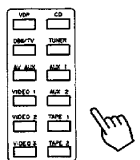

- This can also be selected with the input selector keys on the main unit.

#### 3 Select the desired letter or numeral.

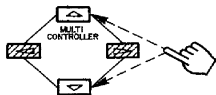

- For the characters registered for use in title entry, refer to Table 1 below.
- TV screen when the CD input selector key is pressed

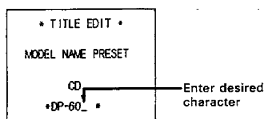

#### 4 Establish the entry of the selected character.



- The selected character is entered, and the character entry cursor moves to the right by one position and blinks there.
- Enter other characters by repeating steps 3 and 4.
- In case of title modification, the previous character is replaced by the newly entered character.

#### Move the character position.

If you commit a mistake:

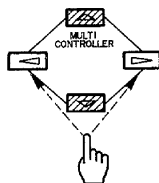

- Move the blinking cursor to the position of the character to be modified.
- Perform steps 3 and 4 to modify the character.

#### 5 End the entry.

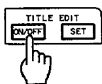

- The entry operation is completed and the title is changed.
- The entered characters appear on the display.

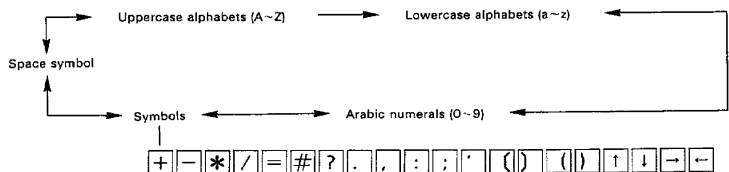
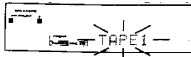

Table 1 83 characters are registered for use in entry. Every time the  $\square$  or  $\square$  key is pressed, the characters are varied in the cycle as shown below.





## In case of difficulty

What appears to be a malfunction may not always be serious. If your unit should not perform as expected, consult the table below to see if the problem can be corrected before seeking help from your dealer or service representative.

Symptom	Cause	Remedy
When the POWER switch is set to ON, the indicators do not light and sound is not reproduced.	<ul style="list-style-type: none"> <li>The power plug is disconnected from the power outlet.</li> </ul>	<ul style="list-style-type: none"> <li>Insert in securely.</li> </ul>
Picture and sound are not reproduced.	<ul style="list-style-type: none"> <li>The connection cords are disconnected.</li> <li>The connection cords are connected improperly.</li> <li>The source component selected by the input selector key is different from that being played.</li> </ul>	<ul style="list-style-type: none"> <li>Connect the cords securely into the jacks.</li> <li>Check connections, and correct as required.</li> <li>Press the input selector key of the component to be listened to.</li> </ul>
Sound is not reproduced.	<ul style="list-style-type: none"> <li>The SPEAKERS key is set to OFF.</li> <li>The speaker cords are disconnected.</li> <li>The speaker cords are short-circuited.</li> </ul>	<ul style="list-style-type: none"> <li>Set the SPEAKERS key to ON.</li> <li>Connect the cords securely to the speaker terminals.</li> <li>Connect the speaker cords properly.</li> </ul>
The sound from the center speaker is not heard or is very low.	<ul style="list-style-type: none"> <li>The setting of the CENTER SPEAKERS switch is not correct for the connection.</li> </ul>	<ul style="list-style-type: none"> <li>Set the CENTER SPEAKERS switch correctly. (Refer to page 9.)</li> </ul>
Sound from the rear speakers is not reproduced or is at a low volume level.	<ul style="list-style-type: none"> <li>The Surround mode is set to BYPASS.</li> <li>The rear level is set to the minimum position.</li> <li>The sound source is in monaural, when the surround mode is set to DOLBY PRO LOGIC.</li> </ul>	<ul style="list-style-type: none"> <li>Set to a desired Surround mode.</li> <li>Increase the rear speaker level to an optimum level.</li> <li>Use the SYNTHETIC MOVIE THEATER or SYNTHETIC ARENA Surround mode.</li> </ul>
Sound is distorted in the setting other than source direct.	<ul style="list-style-type: none"> <li>The input level is too high.</li> </ul>	<ul style="list-style-type: none"> <li>Adjust the INPUT LEVEL control on the rear panel.</li> </ul>
The remote control does not work.	<ul style="list-style-type: none"> <li>The remote controlling distance is too far.</li> <li>The batteries are exhausted.</li> </ul>	<ul style="list-style-type: none"> <li>Operate the remote control unit from a closer position.</li> <li>Replace the batteries.</li> </ul>
The DELAY TIME switch does not work.	<ul style="list-style-type: none"> <li>The Surround mode is Bypass, 3 Stereo or DSP Surround. (Also, even the mode is the DSP Logic Surround mode, the use of rear speakers is not specified by the speaker mode.)</li> </ul>	<ul style="list-style-type: none"> <li>The delay time cannot be adjusted in these mode.</li> </ul>
Characters "TAPE 1" blink on the display. 	<ul style="list-style-type: none"> <li>They blink when ... Input selector key: TAPE 1, TAPE 1 REC switch: TAPE 2.</li> </ul>	<ul style="list-style-type: none"> <li>① Select other input selector key than TAPE 1.</li> <li>② Set the TAPE 1 REC switch to SOURCE.</li> </ul>
Characters "VIDEO 1" blink on the display. 	<ul style="list-style-type: none"> <li>They blink when ... Input selector key: VIDEO 1, VIDEO 1 REC switch: VIDEO 1 or VIDEO 2.</li> </ul>	<ul style="list-style-type: none"> <li>① Set the VIDEO 1 REC switch to SOURCE.</li> <li>② Select other input selector key than VIDEO 1.</li> </ul>

### Notes:

- As this unit is microprocessor-controlled, malfunction may occur due to external noise or interference. In such a case, unplug the power cord from the power outlet and then, while holding the TUNER input selector key depressed, plug the power cord again to the power outlet. (This clears the title and Surround information memory.)
- Do not use contact revitalizer, for this may cause malfunction. Be specially cautious against contact revitalizer containing oil, because it may deform the plastic parts.

### Memory backup feature

This unit is provided with backup circuitry for various memory functions. The memory will be backed up for a period of about 3 days while the power cord of the unit is disconnected from the power outlet. If the memory is cleared, perform the programming or storage operations again.

### Speaker protection circuitry

If the speaker cords are short-circuited, the speaker protection circuitry is activated and the sound is muted. In such a case, switch the POWER key to OFF, remove the short-circuit from the speaker cords, and switch the POWER key ON again. Normal operation will resume.

# Specifications (For U.S.A.)

## AUDIO section

### Continuous rated power output (FTC)

80 watts per channel minimum RMS, both channels driven, at 8  $\Omega$  from 20 Hz to 20,000 Hz with no more than 0.08 % total harmonic distortion.

90 watts per channel minimum RMS, both channels driven, at 6  $\Omega$  from 20 Hz to 20,000 Hz with no more than 0.08 % total harmonic distortion.

### [SURROUND MODE]

### Continuous rated power output Front

90 watts per channel minimum RMS, both channels driven, at 8  $\Omega$  1 kHz with no more than 0.08 % total harmonic distortion.

### Center

45 watts per channel minimum RMS, both channels driven, at 8  $\Omega$  1 kHz with no more than 0.08 % total harmonic distortion.

### Rear

45 watts per channel minimum RMS, both channels driven, at 8  $\Omega$  1 kHz with no more than 0.08 % total harmonic distortion.

Total harmonic distortion  
0.08 % (20 Hz-20 kHz, 80 W, 8 $\Omega$ )

Frequency response  
LINE (CD, TUNER, AUX, TAPE, VDP, DBS/TV,  
AV AUX, VIDEO) ..... 5 Hz - 80 kHz,  
+0 dB, -3 dB

Signal to noise ratio  
LINE (CD, TUNER, AUX, TAPE, VDP, DBS/TV,  
AV AUX, VIDEO) ..... 96 dB(IHF'66)

Input sensitivity/Impedance  
LINE (CD, TUNER, AUX, TAPE, VDP, DBS/TV,  
AV AUX, VIDEO) ..... 200 mV/47 k $\Omega$

Parametric equalizer characteristics  
Adjustment frequencies  
BASS: 100 Hz  
MIDDLE: One of 250 Hz, 400 Hz, 630 Hz, 1 kHz,  
1.6 kHz, 2.5 kHz, 4 kHz  
TREBLE: 10 kHz  
Adjustment range .....  $\pm 10$  dB

Output level/Impedance  
TAPE REC ..... 200 mV/150  $\Omega$   
Front channel preout ..... 1 V/600  $\Omega$   
Center channel preout ..... 1 V/600  $\Omega$   
Rear channel preout ..... 1 V/600  $\Omega$

## VIDEO section

Television format ..... NTSC

### Input level/Impedance

VIDEO (composite) ..... 1Vp-p/75 $\Omega$   
Input (VDP, DBS/TV, VIDEO IN, AV AUX)

S-VIDEO (Luminance signal) ..... 1Vp-p/75 $\Omega$   
(Chrominance signal) .... 0.286Vp-p/75 $\Omega$   
Input (VDP, DBS/TV, VIDEO IN, AV AUX)

Output level/Impedance  
VIDEO (composite) ..... 1Vp-p/75 $\Omega$   
Output (MONITOR OUT, VIDEO OUT)  
S-VIDEO (Luminance signal) ..... 1Vp-p/75 $\Omega$   
(Chrominance signal) .... 0.286Vp-p/75 $\Omega$   
Output (MONITOR OUT, VIDEO OUT)

## GENERAL

Power consumption ..... 5 A (For U.S.A.)  
Dimensions ..... W: 440 mm (17-5/16")  
H : 163 mm (6-7/16")  
D : 424 mm (16-11/16")  
Weight (Net) ..... 17.5 kg (38.5 lb)

Note:  
KENWOOD follows a policy of continuous advancements in development. For this reason specifications may be changed without notice.

The built-in cooling fan starts operating when the temperature inside the unit becomes high to protect circuitry. When the inside temperature becomes low, the cooling fan stops automatically.

## Specifications (For other countries)

### AUDIO section

#### STEREO MODE

Continuous rated power output (FTC)

80 watts per channel minimum RMS, both channels driven, at 8  $\Omega$  from 20 Hz to 20,000 Hz with no more than 0.08 % total harmonic distortion.

#### [SURROUND MODE]

Continuous rated power output

Front (1kHz, 0.08 % T.H.D. at 8 $\Omega$ ). 90 W + 90 W

Center (1kHz, 0.08 % T.H.D. at 8 $\Omega$ ). 45 W + 45 W

Rear (1kHz, 0.08 % T.H.D. at 8 $\Omega$ ). 45 W + 45 W

Total harmonic distortion

0.08 % (20 Hz - 20 kHz, 80 W, 8 $\Omega$ )

Frequency response

LINE (CD, TUNER, AUX, TAPE, VDP, DBS/TV,  
AV AUX, VIDEO).....5 Hz - 80 kHz,  
+0 dB, -3dB

Signal to noise ratio

LINE (CD, TUNER, AUX, TAPE, VDP, DBS/TV,  
AV AUX, VIDEO)

..... 96 dB(IHF'66)

Input sensitivity/Impedance

LINE (CD, TUNER, AUX, TAPE, VDP, DBS/TV,  
AV AUX, VIDEO).....200 mV/47 k $\Omega$

Parametric equalizer characteristics

Adjustment frequencies

BASS: 100 Hz

MIDDLE: One of 250 Hz, 400 Hz, 630 Hz, 1 kHz,  
1.6 kHz, 2.5 kHz, 4 kHz

TREBLE: 10 kHz

Adjustment range .....  $\pm 10$  dB

Output level/Impedance

TAPE REC ..... 200 mV/150  $\Omega$

Front channel preout ..... 1 V/600  $\Omega$

Center channel preout ..... 1 V/600  $\Omega$

Rear channel preout ..... 1 V/600  $\Omega$

### VIDEO section

Television format ..... NTSC

Input level/Impedance

VIDEO (composite) ..... 1Vp-p/75 $\Omega$

Input (VDP, DBS/TV, VIDEO IN, AV AUX)

S-VIDEO (Luminance signal) ..... 1Vp-p/75 $\Omega$

(Chrominance signal) .... 0.286Vp-p/75 $\Omega$

Input (VDP, DBS/TV, VIDEO IN, AV AUX)

Output level/Impedance

VIDEO (composite) ..... 1Vp-p/75 $\Omega$

Output (MONITOR OUT, VIDEO OUT)

S-VIDEO (Luminance signal) ..... 1Vp-p/75 $\Omega$

(Chrominance signal) .... 0.286Vp-p/75 $\Omega$

Output (MONITOR OUT, VIDEO OUT)

### GENERAL

Power consumption ..... 400 W (IEC)

Dimensions ..... W: 440 mm (17-5/16")

H : 163 mm (6-7/16")

D : 424 mm (16-11/16")

Weight (Net) ..... 17.5 kg (38.5 lb)

#### Note:

KENWOOD follows a policy of continuous advancements in development. For this reason specifications may be changed without notice.

The built-in cooling fan starts operating when the temperature inside the unit becomes high to protect circuitry. When the inside temperature becomes low, the cooling fan stops automatically.

**For the U.S.A.  
FCC WARNING:**

This equipment may generate or use radio frequency energy. Changes or modifications to this equipment may cause harmful interference unless the modifications are expressly approved in the instruction manual. The user could lose the authority to operate this equipment if an unauthorized change or modification is made.

**NOTE:**

This equipment has been tested and found to comply with the limits for a CLASS B digital device, pursuant to Part 15 of the FCC Rules. These limits are designed to provide reasonable protection against harmful interference in a residential installation. This equipment may cause harmful interference to radio communications, if it is not installed and used in accordance with the instructions. However, there is no guarantee that interference will not occur in a particular installation. If this equipment does cause harmful interference to radio or television reception, which can be determined by turning the equipment off and on, the user is encouraged to try to correct the interference by one or more of the following measures:

- Reorient or relocate the receiving antenna.
- Increase the separation between the equipment and receiver.
- Connect the equipment into an outlet on a circuit different from that to which the receiver is connected.
- Consult the dealer or an experienced radio/TV technician for help.

**For CANADA  
DOC REGULATION**

"This digital apparatus does not exceed the CLASS B limits for radio noise emissions from digital apparatus as set out in the radio interference regulations of the Canadian Department of Communications."

## Free Manuals Download Website

<http://myh66.com>

<http://usermanuals.us>

<http://www.somanuals.com>

<http://www.4manuals.cc>

<http://www.manual-lib.com>

<http://www.404manual.com>

<http://www.luxmanual.com>

<http://aubethermostatmanual.com>

Golf course search by state

<http://golfingnear.com>

Email search by domain

<http://emailbydomain.com>

Auto manuals search

<http://auto.somanuals.com>

TV manuals search

<http://tv.somanuals.com>