

# KENWOOD

## KAC-648

---

4-CHANNEL POWER AMPLIFIER

## INSTRUCTION MANUAL

KENWOOD CORPORATION

# Safety precautions

## ⚠ WARNING

**To prevent injury and/or fire, take the following precautions:**

- When extending the battery or ground cables, make sure to use automotive-grade cables or other cables with an area of 3 mm<sup>2</sup> (AWG12) or more to prevent cable deterioration and damage to the cable coating.
- To prevent short circuits, never put or leave any metallic objects (e.g., coins or metal tools) inside the unit.
- If the unit starts to emit smoke or strange smells, turn off the power immediately and consult your Kenwood dealer.
- Do not touch the unit during use because the surface of the unit becomes hot and may cause burns if touched.

## ⚠ CAUTION

**To prevent damage to the machine, take the following precautions:**

- Be sure the unit is connected to a 12V DC power supply with a negative ground connection.
- Do not open the top or bottom covers of the unit.
- Do not install the unit in a spot exposed to direct sunlight or excessive heat or humidity. Also avoid places with too much dust or the possibility of water splashing.
- When replacing a fuse, only use a new one with the prescribed rating. Using a fuse with the wrong rating may cause your unit to malfunction.

- To prevent short circuits when replacing a fuse, first disconnect the wiring harness.

## NOTE

- If you experience problems during installation, consult your Kenwood dealer.
- If the unit does not seem to be working right, consult your Kenwood dealer.





## Cleaning the unit

If the front panel gets dirty, turn off the power and wipe the panel with a dry silicon cloth or soft cloth.

## ⚠ CAUTION

Do not wipe the panel with a hard cloth or a cloth dampened by volatile solvents such as paint thinner and alcohol. They can scratch the surface of the panel and/or cause the indicator letters to peel off.

## Accessories

Part name	External View	Number of Items
Round terminal (Large)		1
Round terminal (Medium)		2
Round terminal (Small)		1
Terminal cover (Power terminal)		1
Self-tapping screws (ø4 × 16 mm)		4

# Protection function

**This unit is equipped with a protection function for protecting this unit and your speakers from various accidents or problems that can occur.**

**When the protection function is triggered, the Power indicator goes off and the amplifier stops operating.**

## ■ Power indicator:

When the power is turned on, the Power indicator lights.

If the Power indicator does not light when the power is turned on, the protection function may be activated. Check whether there is any indication of trouble.

## ■ The protection function activates in the following situations:

- When a speaker cable may be short-circuited.
- When a speaker output contacts ground.
- When the temperature of internal parts exceeds 120°C (248°F).
- When a ground cable of the center unit (cassette receiver, CD receiver, etc.) or this unit is not connected to a metal part serving as an electrical ground passing electricity to the battery's negative ⊖ terminal.

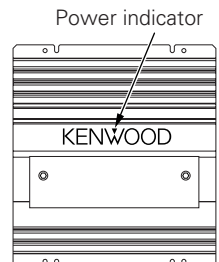

# Installation procedure

1. Remove the ignition key and disconnect the negative ⊖ terminal of the battery to prevent short circuits.
2. Set the unit according to the intended usage.
3. Connect the input and output cables of the units.
4. Connect the speaker cables.
5. Connect the power cable, power control cable and grounding cable following this order.
6. Install the unit in the car.
7. Connect the negative ⊖ terminal of the battery.

## ▲CAUTION

- Be sure to turn the power off before changing the setting of any switch.
- If the fuse blows, check cables for shorts, then replace the fuse with one of the same rating.
- Check that no unconnected cables or connectors are touching the car body. Do not remove caps from unconnected cables or connectors to prevent short circuits.
- Connect the speaker cables to appropriate speaker connectors separately. Sharing the negative cable of the speaker or grounding speaker cables to the metal body of the car can cause this unit to fail.
- After installation, check that the brake lamps, wipers, and wipers work properly.

# Installation

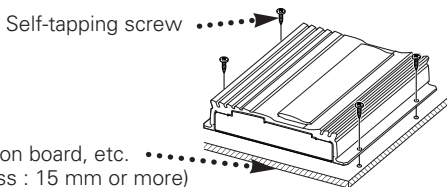

- Since the power amplifier has no parts which require operation, it can be installed at a position away from the driver's seat without any hindrances.  
As generally accepted positions for its installation, places such as inside the trunk, etc. can be considered.
- Use the extension cables. (Optional.)

Type	Length	0.5m	1m	2m	4m	5m	6m
RCA cable		CA-2SL	CA-12SL	CA-22SL	—	CA-52SL	—
RCA cable (ø7mm)		CA-3WL	CA-13WL	CA-23WL	—	CA-53WL	—
RCA cable (ø12mm)		CA-5W	CA-15W	CA-25W	CA-45W	—	CA-65W

## ▲CAUTION

- Do not install the unit under the carpet. Otherwise heat build-up occurs and the unit may be damaged.
- Install this unit in a location which allows heat to easily dissipate.  
Once installed, do not place any object on top of the unit.
- The surface temperature of the amplifier will become hot during use. Install the amplifier in a place where people, resins, and other substances that are sensitive to heat will not come into contact with it.
- When making a hole under a seat, inside the trunk, or somewhere else in the vehicle, check that there is nothing hazardous on the opposite side such as a gasoline tank, brake pipe, or wiring harness, and be careful not to cause scratches or other damage.
- Do not install near the dashboard, rear tray, or air bag safety parts.
- The installation to the vehicle should securely fasten the unit to a place in which it will not obstruct driving. If the unit comes off due to a shock and hits a person or safety part, it may cause injury or an accident.
- After installing the unit, check to make sure that electrical equipment such as the brake lamps, turn signal lamps and windshield wipers operate normally.

# Controls

This is a 4 channel amplifier including 2 stereo amplifiers in a body. One amplifier is referred to as amplifier A and the other is amplifier B. This unit is compatible with a large variety of systems by combining the switches and functions described in the following.

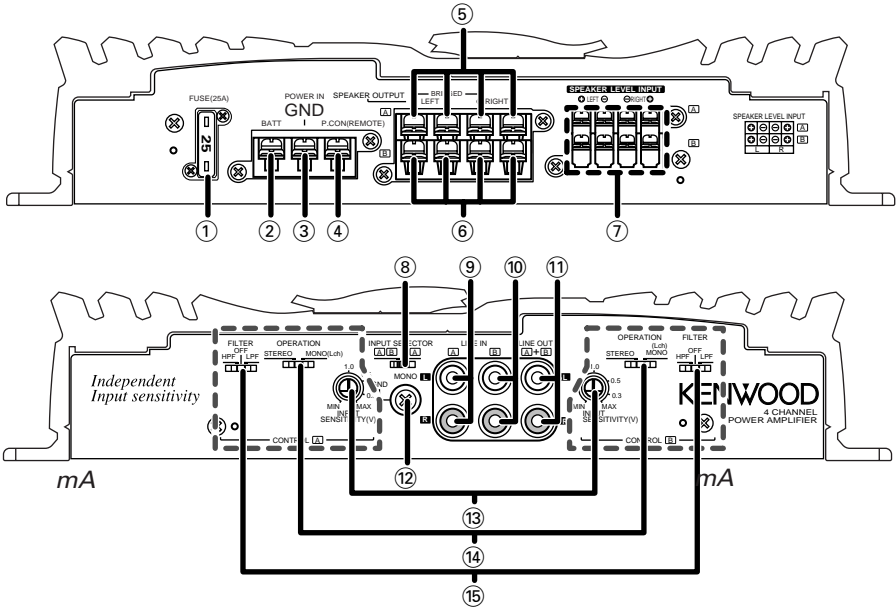

- ① **Fuse (25 A × 1)**
- ② **Battery terminal**
- ③ **Ground terminal**
- ④ **Power control (REMOTE) terminal**
- ⑤ **Amplifier A speaker output terminals**
- ⑥ **Amplifier B speaker output terminals**

## ❖ **SPEAKER OUTPUT terminals**

### • **Stereo Connections:**

When you wish to use the unit as a stereo amplifier, stereo connections are used. The speakers to be connected should have an impedance of 2Ω or greater. When multiple speakers are to be connected, ensure that the combined impedance is 2Ω or greater for each channel.

### • **Bridged Connections:**

When you wish to use the unit as a high-output monaural amplifier, bridged connections are used. (Make connections to the LEFT channel (+) and the RIGHT channel (-) SPEAKER OUTPUT terminals.) The speakers to be connected should have an impedance of 4Ω or greater.

When multiple speakers are to be connected, ensure that the combined impedance is 4Ω or greater.

### ⚠ **CAUTION**

The rated input of the speakers should be no less than the maximum output of the amplifier. Otherwise malfunction may result.

- ⑦ **Speaker level input terminals**
- ⑧ **INPUT SELECTOR switch**  
This switch selects the input method of the signals to be amplified by amplifiers A and B.



### • **A B position:**

Amplifies both of the signals input to amplifiers A and B.

### • **A position:**

Amplifies only signal input amplifier A with both amplifiers A and B.

- ⑨ **Amplifier A LINE IN terminal**
- ⑩ **Amplifier B LINE IN terminal**

11 **LINE OUT terminal**

These jacks output respectively the signals input to amplifiers A and B. They always output the stereo signals regardless of the position of the OPERATION switch.

12 **RCA cable ground lead terminal**

13 **INPUT SENSITIVITY control**

Set this control according to the pre-output level of the center unit connected with this unit, or to the maximum power output of the genuine-accessory car stereo.

The sensitivities of amplifiers A and B can be adjusted independently regardless of the position of the input selector switch.

Use the diagram on the right as a guide.

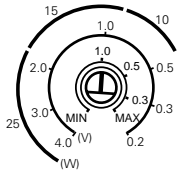

**NOTE**

For the pre-output level or the maximum power output, refer to the "Specifications" in the instruction manual of the center unit.

14 **OPERATION switch**

The amplification methods of the signals input to amplifiers A and B can be selected

independently according to the setting of this switch.

• **STEREO position:**

The amplifier can be used as a stereo amplifier.

• **MONO (Lch) position:**

Amplifies the signal input from the left side only. Set to this position and make bridged connections to use as a high-power monaural amplifier. (The input right signal is not output.)

15 **FILTER switch**

These switches allow filtering of the speaker output signals.

• **HPF(High Pass Filter) position:**

Only frequencies of 150Hz or higher are output. (Frequencies below 150Hz are cut.)

• **LPF(Low Pass Filter) position:**

Only frequencies of 80Hz or lower are output. (Frequencies above 80Hz are cut.)

The Lch and Rch will be mixed before output even if the operation switch is set to STEREO.

• **OFF position:**

The original sound without filtering is output.

## System examples

### ■ Full-range 4-channel + Subwoofer system

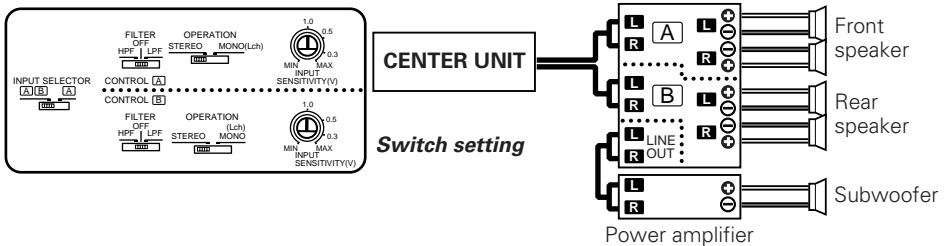

# System examples

## High-pass + Subwoofer system

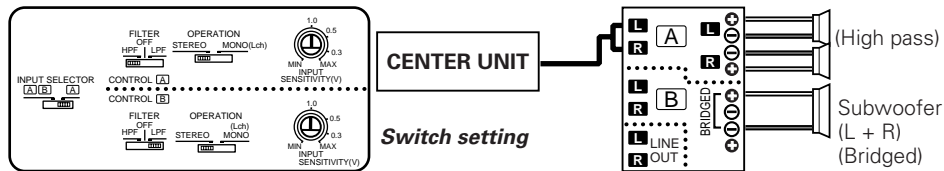

## High-power 2-channel system

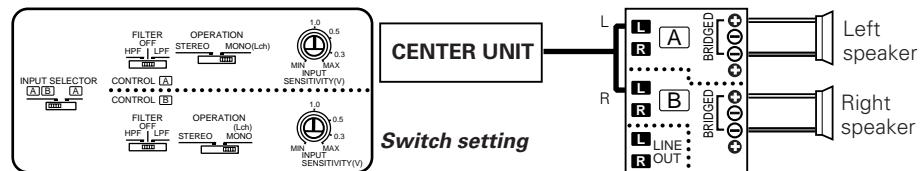

## Tri-mode

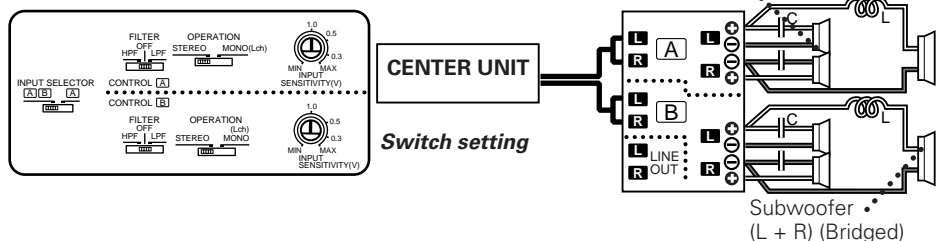

### Principle of Tri-mode

Method of frequency band division using a coil and capacitor\*\*\*in case of 6dB/oct. slope

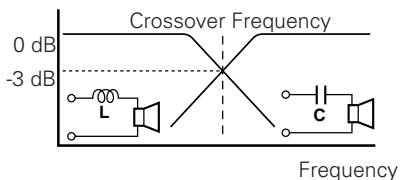

**Coil (L):** Passes low frequencies and blocks high frequencies. (Low pass)

**Capacitor (C):** Passes high frequencies and blocks low frequencies. (High pass)

$$C = \frac{159000}{f_c \times R} (\mu\text{F})$$

$$L = \frac{159 \times R}{f_c} (\text{mH})$$

$f_c$  = Cut of Frequency (Hz)  
 $R$  = Speaker Impedance ( $\Omega$ )

### Example:

When it is required to set a crossover frequency of 120 Hz using speakers with an impedance of 4 ohms.

Prepare commercially-available coil and capacitor with the closest ratings to the results calculated from the formula above. The capacitor rating should be as close as possible to 331.25 ( $\mu\text{F}$ ) and the coil rating should be as close as possible to 5.3 (mH).

### CAUTION

- If you wish to bridge-connect a speaker, the speaker impedance must be no less than 4 ohms. Connecting a speaker with an impedance lower than 4 ohms may damage the unit.
- Be sure to connect capacitors to speakers to which high frequencies will be passed. Failure to do so will result in a drop of the combined impedance with the subwoofer.
- Ensure that the withstand voltage and current ratings of the capacitors (C) and coils (L) are sufficient.

# Connection

## Power cable connection

### ⚠ WARNING

To prevent fire caused by a short in the wiring, connect a fusible link or breaker nearby the battery's positive terminal.

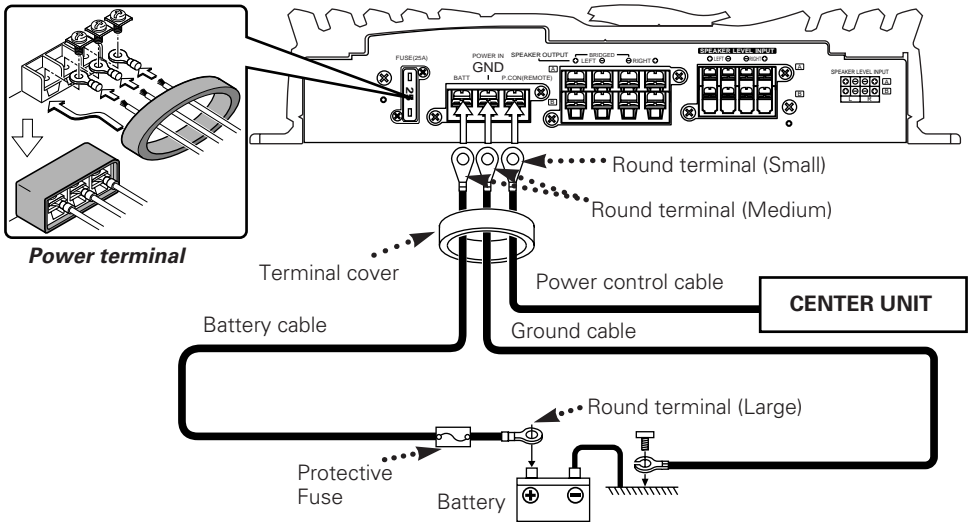

### Power terminal

Connect to their respective terminals the power control cable, power supply cable, and ground cable, all of which pass through the associated terminal cover. Once the connections are complete, place the cover on the terminal section.

### Wiring

- If a buzzing noise is heard from the speakers when the engine is running, connect a line noise filter (optional) to each of the battery cable.
- Do not allow the cord to directly contact the edge of the iron plate by using Grommets.
- Connect the ground cable to a metal part of the car chassis that acts as an electrical ground passing electricity to the battery's negative  $\ominus$  terminal. Do not turn the power on if the ground cable is not connected.
- Be sure to attach a protective fuse into the battery cable close to the battery. Use a protective fuse having a capacity that is about 10 A higher than the maximum current drawn by the amplifier.
- Use vehicle-type (fire-resistant) power supply wiring cable for the battery cable and the ground cable. The current capacity of the power supply wiring cable should be about 10 A higher than that of the protective fuse capacity (which means about 20 A higher than the maximum current drawn by the amplifier).
- When more than one power amplifier are going to be used, use a power supply wiring cable and protective fuse of greater current-handling capacity than the total maximum current drawn by each amplifier.

### Example: One Power Amplifier Is Used

Model	Maximum Current Drawn	Protective Fuse	Cross-sectional Area of Wiring Cable (AWG)
KAC-648	22 A	30 A $\times$ 1 [15 A $\times$ 2]	3 mm <sup>2</sup> (AWG 12) or greater $\times$ 1

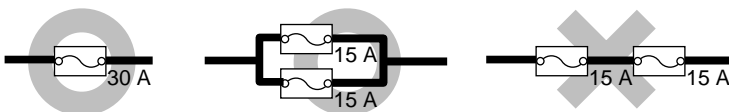

# Connection

## Speakers cable connection (Stereo Connections)

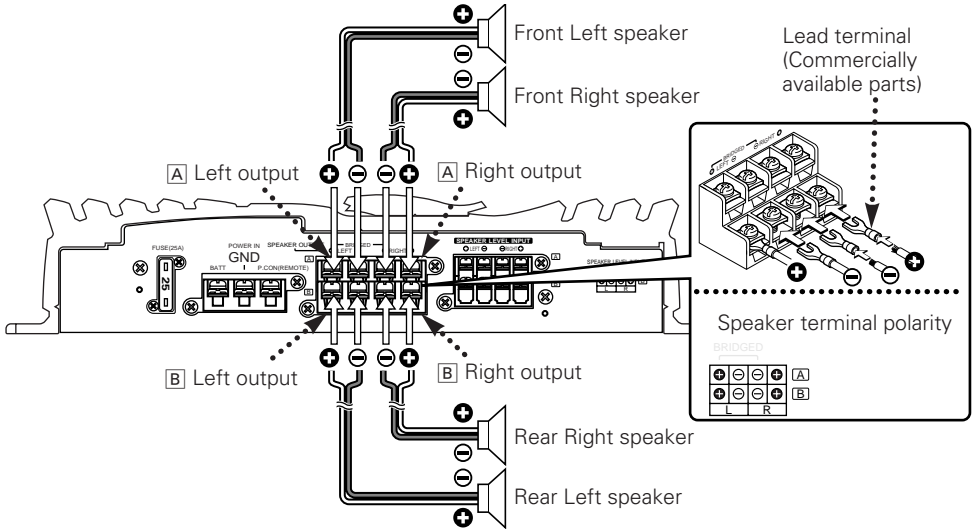

## (Bridged Connections)

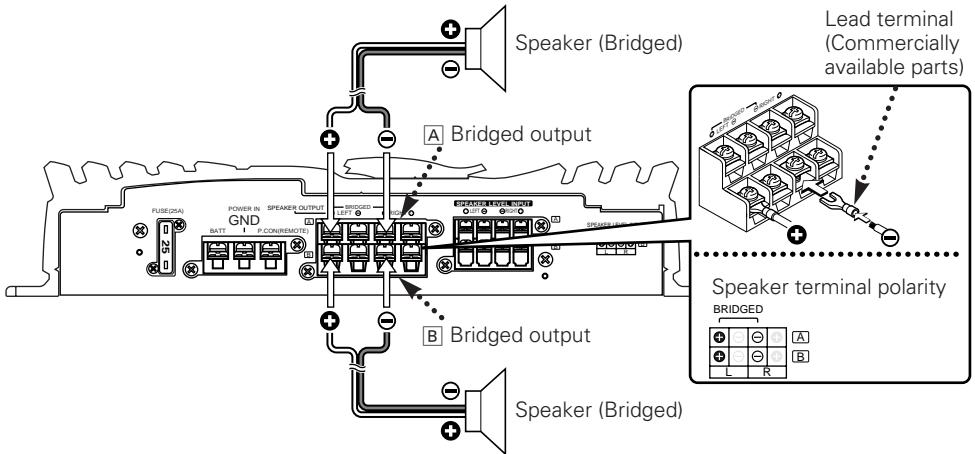

## Speaker Selection

- The rated input power of the speakers that are going to be connected should be greater than the maximum output power (in Watts) of the amplifier. Use of speakers having input power ratings that are less than the output power of the amplifier will cause smoke to be emitted as well as damage.
- The impedance of the speakers that are going to be connected should be  $2\Omega$  or greater (for stereo connections), or  $4\Omega$  or greater (for bridged connections). When more than one set of speakers are going to be used, calculate the combined impedance of the speakers and then connect suitable speakers to the amplifier.



**Examples:**

Model	Stereo Connections (4Ω)	Bridged Connections (4Ω)
KAC-648	50 W or greater	140 W or greater

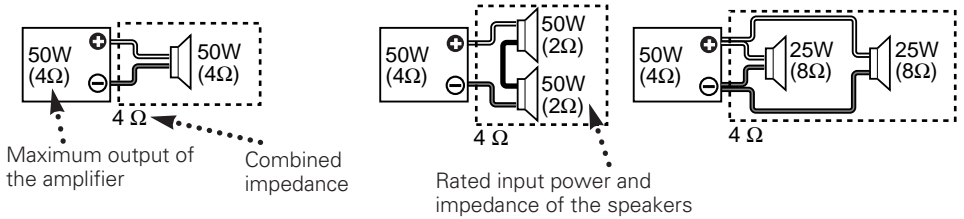

**■ RCA cable connection**

**⚠ CAUTION**

Do not connect cables and leads to both RCA cable input jacks and the speaker input terminals simultaneously, for this may cause malfunction or damage.

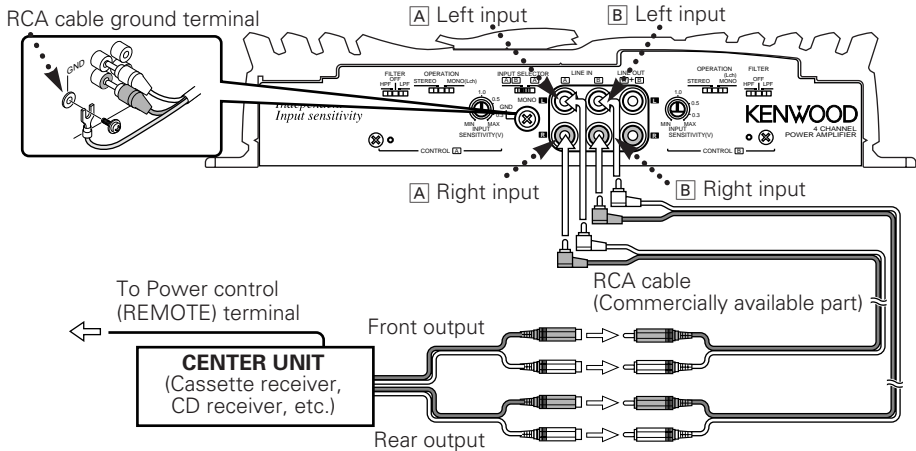

**RCA cable ground terminal**

When using an RCA cable with a ground lead attached, connect the ground lead to this terminal.

**⚠ CAUTION**

Do not use this terminal for power source grounding. This unit will be damaged if the power source grounding wire is connected to this terminal.

# Connection

## ■ Speaker level input connection

Connect the unit by inserting it in the connection between the genuine-accessory car stereo and speakers.

### ▲CAUTION

Do not connect cables and leads to both RCA cable input jacks and the speaker input terminals simultaneously, for this may cause malfunction or damage.

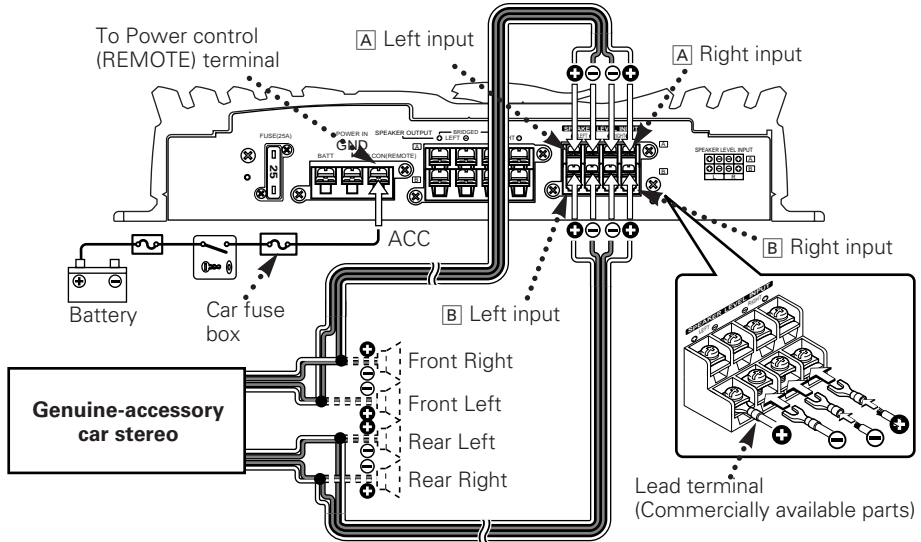

### ▲CAUTION

- The genuine-accessory car stereo shall have a maximum power output of no more than 25 W.
- Do not connect the speaker output leads from a power amplifier (Optional) to the speaker input terminals of this unit, for this may cause malfunction or damage.
- Connect the power control lead to a power supply which can be turned ON/OFF by the ignition key switch (ACC line).

With this connection, shock noise may be generated when the power of the genuine-accessory car stereo is switched ON/OFF.

# Troubleshooting Guide

---

*What might appear to be a malfunction in your unit may just be the result of slight misoperation or miswiring. Before calling service, first check the following table for possible problems.*

<b>PROBLEM</b>	<b>POSSIBLE CAUSE</b>	<b>SOLUTION</b>
<b>No sound. (No sound from one side.)</b>	<ul style="list-style-type: none"><li>• Input (or output) cables are disconnected.</li><li>• Protection circuit may be activated.</li><li>• The fuse may be blown because the volume was too high.</li></ul>	<ul style="list-style-type: none"><li>• Connect the input (or output) cables.</li><li>• Check connections by referring to "Protection function".</li><li>• Replace the fuse with a new fuse and use a lower volume.</li></ul>
<b>The output level is too small (or too large).</b>	The input sensitivity adjusting control is not set to the correct position.	Adjust the control correctly referring to "Controls".
<b>The sound quality is bad. (The sound is distorted.)</b>	<ul style="list-style-type: none"><li>• The speakers cable are connected with wrong ⊕ / ⊖ polarity.</li><li>• A speaker cable is pinched by a screw in the car body.</li><li>• The switches may be set improperly.</li></ul>	<ul style="list-style-type: none"><li>• Connect them properly checking the ⊕ / ⊖ of the terminals and cables well.</li><li>• Connect the speaker cable again so that it is not pinched by anything.</li><li>• Set switches properly by referring to "System examples".</li></ul>

---

# Specifications

---

**Specifications subject to change without notice.**

## Audio Section

Max Power Output (4 $\Omega$ )	
4 Channel Mode	50 W $\times$ 4
3 Channel Mode	50 W $\times$ 2 + 140 W $\times$ 1
2 Channel Mode	140 W $\times$ 2
Rated Power Output (4 $\Omega$ )	
4 Channel Mode	25 W $\times$ 4 (DIN45324, +B=14.4 V)
3 Channel Mode	25 W $\times$ 2 (1 kHz, 0.08 % THD) + 70 W $\times$ 1 (1 kHz, 0.8 % THD)
2 Channel Mode	70 W $\times$ 2 (1 kHz, 0.8 % THD)
Rated Power Output (2 $\Omega$ )	
4 Channel Mode	35 W $\times$ 4 (1 kHz, 0.8 % THD)
Frequency Response	10 Hz ~ 45 kHz (+0, -1 dB)
Signal to Noise Ratio	100 dB
Sensitivity (MAX)	0.2 V (rated output)
Sensitivity (MIN)	4.0 V (rated output)
Input Impedance	10 k $\Omega$
Low Pass Filter	.80 Hz (12 dB/oct.)
High Pass Filter	150 Hz (12 dB/oct.)

## General

Operating Voltage	14.4 V (11 ~ 16 V allowable)
Current Consumption	22 A (1 kHz, 10% THD)
Dimensions (W $\times$ H $\times$ D)	260 $\times$ 56.5 $\times$ 209 mm
Weight	3.0 kg

## Free Manuals Download Website

<http://myh66.com>

<http://usermanuals.us>

<http://www.somanuals.com>

<http://www.4manuals.cc>

<http://www.manual-lib.com>

<http://www.404manual.com>

<http://www.luxmanual.com>

<http://aubethermostatmanual.com>

Golf course search by state

<http://golfingnear.com>

Email search by domain

<http://emailbydomain.com>

Auto manuals search

<http://auto.somanuals.com>

TV manuals search

<http://tv.somanuals.com>