

KENWOOD

MULTI CHANNEL POWER AMPLIFIER

KM-X1

INSTRUCTION MANUAL

KENWOOD CORPORATION

B60-1089-00 (JA) (K.P) MC
93/12 11 10 9 8 7 6 5 4 3 2

Introduction

Your choice of this product indicates that you are a devotee to excellence in sound reproduction.

We appreciate your patronage and take pride in the long tradition of quality components that our company represents.

So that you can get the most out of your unit, we suggest that you take the time to read through this manual before you hook up and operate your system. This will acquaint you with operating features and system-connection considerations so that your listening pleasure will be enhanced right from the start. You will notice that in all aspects of planning, engineering, styling, operating convenience and adaptability we have sought to anticipate your needs and desires.

Keep this manual handy for future reference.

For your records

Record the serial number, found on the back of the unit, in the spaces designated on the warranty card, and in the space provided below. Refer to the model and serial numbers whenever you call upon your dealer for information or service on this product.

Model _____ Serial Number _____

Unpacking





Unpack the unit carefully.

Examine the unit for any possibility of shipping damage. If your unit is damaged or fails to operate, notify your dealer immediately. If your unit was shipped to you directly, notify the shipping company without delay. Only the consignee (the person or company receiving the unit) can file a claim against the carrier for shipping damage.

We recommend that you retain the original carton and packing materials for use should you transport or ship the unit in the future.

Contents

Caution : Read the pages marked  carefully to ensure safe operation.

Introduction	2	Speaker connection	7
 Before applying power	3	Controls and indicators	8
 Safety precautions	3	Operation	9
 IMPORTANT SAFEGUARDS	4	In case of difficulty	10
System connections	6	 SPECIFICATIONS	11
Connection of audio components	6		

Before applying power

 **Caution: Read this page carefully to ensure safe operation.**

For the U.S.A. and Canada

Important!

Units shipped to the U.S.A. and Canada are designed for operation on 120 volts AC only.

CAUTION: TO PREVENT ELECTRIC SHOCK DO NOT USE THE AC PLUG WITH AN EXTENSION CORD, RECEPTACLE OR OTHER OUTLET UNLESS THE BLADES CAN BE FULLY INSERTED TO PREVENT BLADE EXPOSURE.

For the United Kingdom

Important!

Units shipped to the U.K. are designed for operation on 240 volts AC only.

The mains plug must be removed from the wall socket prior to any internal examination.

The wires in this mains lead are coloured in accordance with the following code:

Blue Neutral
Brown Live

The wires in this mains lead must be connected to the terminals in the plug as follows:

Wire colour	Plug terminal marking
Blue	N or Black
Brown	L or Red

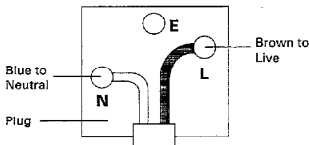

Notes:

1. If a 13-amp plug is used, this must be fitted with a 13-amp fuse.
2. If a 3-pin plug with earthing contact is used, no wire must be connected to the E terminal.

For Australia and Europe

Important!

Units shipped to Australia are designed for operation on 240 V AC only.

Units shipped to Europe are designed for operation on 230 V AC only.

For other countries

Important!

Units shipped to countries other than the above countries are equipped with an AC voltage selector switch on the rear panel. Refer to the following paragraph for the proper setting of this switch.

AC voltage selection

This unit operates on 110 - 120 or 220 - 240 volts AC. The AC voltage selector switch Type A or Type B on the rear panel is set to the voltage that prevails in the area to which the unit is shipped. Before connecting the power cord to your AC outlet, make sure that the setting position of this switch matches your line voltage. If not, it must be set to your voltage in accordance with the following direction.

AC voltage selector switch

Type A

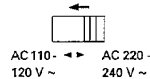

Type B

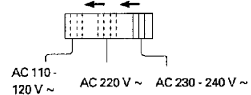





Move switch lever to match your line voltage with a small screwdriver or other pointed tool.

Notes:

Our warranty does not cover damage caused by excessive line voltage due to improper setting of the AC voltage selector switch.

Safety precautions

WARNING: TO PREVENT FIRE OR ELECTRIC SHOCK, DO NOT EXPOSE THIS APPLIANCE TO RAIN OR MOISTURE.

  	CAUTION: TO REDUCE THE RISK OF ELECTRIC SHOCK, DO NOT REMOVE COVER (OR BACK). NO USER-SERVICEABLE PARTS INSIDE. REFER SERVICING TO QUALIFIED SERVICE PERSONNEL.
	THE LIGHTNING FLASH WITH ARROWHEAD SYMBOL, WITHIN AN EQUILATERAL TRIANGLE, IS INTENDED TO ALERT THE USER TO THE PRESENCE OF UNINSULATED "DANGEROUS VOLTAGE" WITHIN THE PRODUCT'S ENCLOSURE THAT MAY BE OF SUFFICIENT MAGNITUDE TO CONSTITUTE A RISK OF ELECTRIC SHOCK TO PERSONS.
	THE EXCLAMATION POINT WITHIN AN EQUILATERAL TRIANGLE IS INTENDED TO ALERT THE USER TO THE PRESENCE OF IMPORTANT OPERATING AND MAINTENANCE (SERVICING) INSTRUCTIONS IN THE LITERATURE ACCOMPANYING THE APPLIANCE.

IMPORTANT SAFEGUARDS

 **Caution:** Read this page carefully to ensure safe operation.

Please read all of the safety and operating instructions before operating this unit. For best results, follow all warnings placed on the unit and adhere to the operating and use instructions. These safety and operating instructions should be retained for future reference.

- 1. Power sources** – The unit should be connected to a power supply only of the type described in the operating instructions or as marked on the appliance.
- 2. Power-cord protection** – Power-supply cords should be routed so that they are not likely to be walked on or pinched by items placed upon or against them, pay particular attention to cords at plugs, convenience receptacles, and the point where they exit from the unit.

Never pull or stretch the cord.



- 3. Grounding or polarization** – The precautions should be taken so that the grounding or polarization means of this unit is not defeated.

- 4. Ventilation** – The unit should be situated so that its location or position does not interfere with its proper ventilation.

To maintain good ventilation, do not put records or a table-cloth on the unit. Place the unit at least 10 cm away from the walls.

Do not use the unit on a bed, sofa, rug or similar surface that may block the ventilation openings.

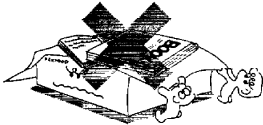

- 5. Water and moisture** – The unit should not be used near water - for example, near a bathtub, washbowl, kitchen sink, laundry tub, in a wet basement, or near a swimming pool, etc.

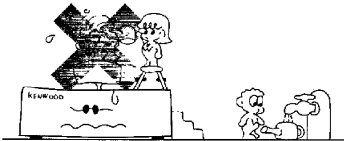

- 6. Temperature** – The unit may not function properly if used at extremely low, or freezing temperatures. The ideal ambient temperature is above +5°C (41°F).

- 7. Heat** – The unit should be situated away from heat sources such as radiators, heat registers, stoves, or other units (including amplifiers) that produce heat.

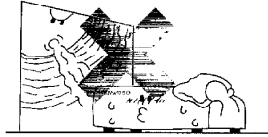

- 8. Electric shock** – Care should be taken so that objects do not fall and liquid is not spilled into the enclosure through openings. If a metal object, such as a hair pin or a needle, comes into contact with the inside of this unit, a dangerous electric shock may result. For families with children, never permit children to put anything, especially metal, inside this unit.

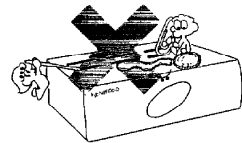

- 9. Enclosure removal** – Never remove the enclosure. If the internal parts are touched accidentally, a serious electric shock might occur.

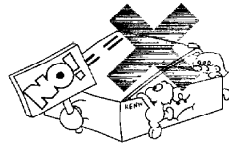

- 10. Magnetic fields** – Keep the unit away from sources of magnetic fields such as TV sets, speaker systems, radios, motorized toys or magnetized objects.

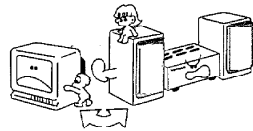

- 11. Cleaning** – Do not use volatile solvents such as alcohol, paint thinner, gasoline, or benzene, etc. to clean the cabinet. Use a clean dry cloth.

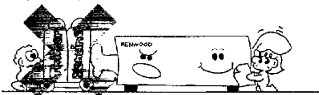

- 12. Carts and stands** – An appliance and cart combination should be moved with care. Quick stops, excessive force, and uneven surfaces may cause the appliance and cart combination to overturn.



- 13. Nonuse periods** – The power cord of the unit should be unplugged from the outlet when left unused for a long period of time.

- 14. Abnormal smell** – If an abnormal smell or smoke is detected, immediately turn the power OFF and pull out the power cord. Contact your dealer or nearest service center.

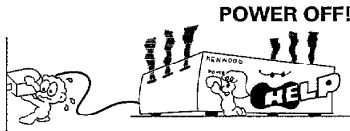

- 15. Damage requiring service** – The unit should be serviced by qualified service personnel when:

- A.** The power-supply cord or the plug has been damaged; or
- B.** Objects have fallen, or liquid has been spilled into the unit; or
- C.** The unit has been exposed to rain; or
- D.** The unit does not appear to operate normally or exhibits a marked change in performance; or
- E.** The unit has been dropped, or the enclosure damaged.

- 16. Servicing** – The user should not attempt to service the unit beyond that described in the operating instructions. All other servicing should be referred to qualified service personnel.

- 17. Outdoor antenna grounding** – If an outside antenna is connected to the receiver, be sure the antenna system is grounded so as to provide some protection against voltage surges and built up static charges. Section 810 of the National Electrical Code, ANSI/NFPA 70, provides information with respect to proper grounding of the mast and supporting structure, grounding of the lead-in wire to an antenna discharge unit, size of grounding conductors, location of antenna-discharge unit, connection to grounding electrodes, and requirements for the grounding electrode. See Figure.

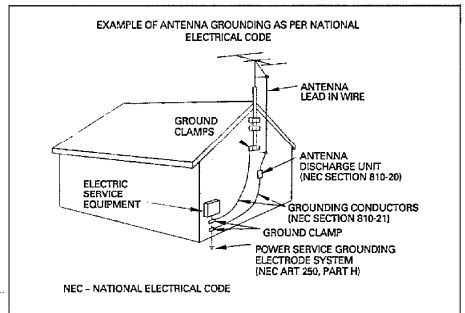

- 18. Power lines** – An outdoor antenna should be located away from power lines.

- 19. AC outlets** – Do not connect other audio equipment with a power consumption larger than that specified to the AC outlet on the rear panel. Never connect other electrical units, such as an iron or toaster, to it to prevent fire or electric shock.

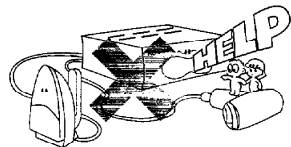

Notes:

- 1. Item 3 is not required except for grounded or polarized equipment.
- 2. Item 17 and 18 are not required except for units provided with antenna terminals.
- 3. Item 17 complies with UL in the U.S.A.

System connections

When this unit is combined with the **KENWOOD KC-X1** digital AV control amplifier/tuner, make connections as shown below. When connecting the related system components, refer also to the instruction manuals of the related components.

Do not plug in the power lead until all connections are completed.

■ Connection of audio components

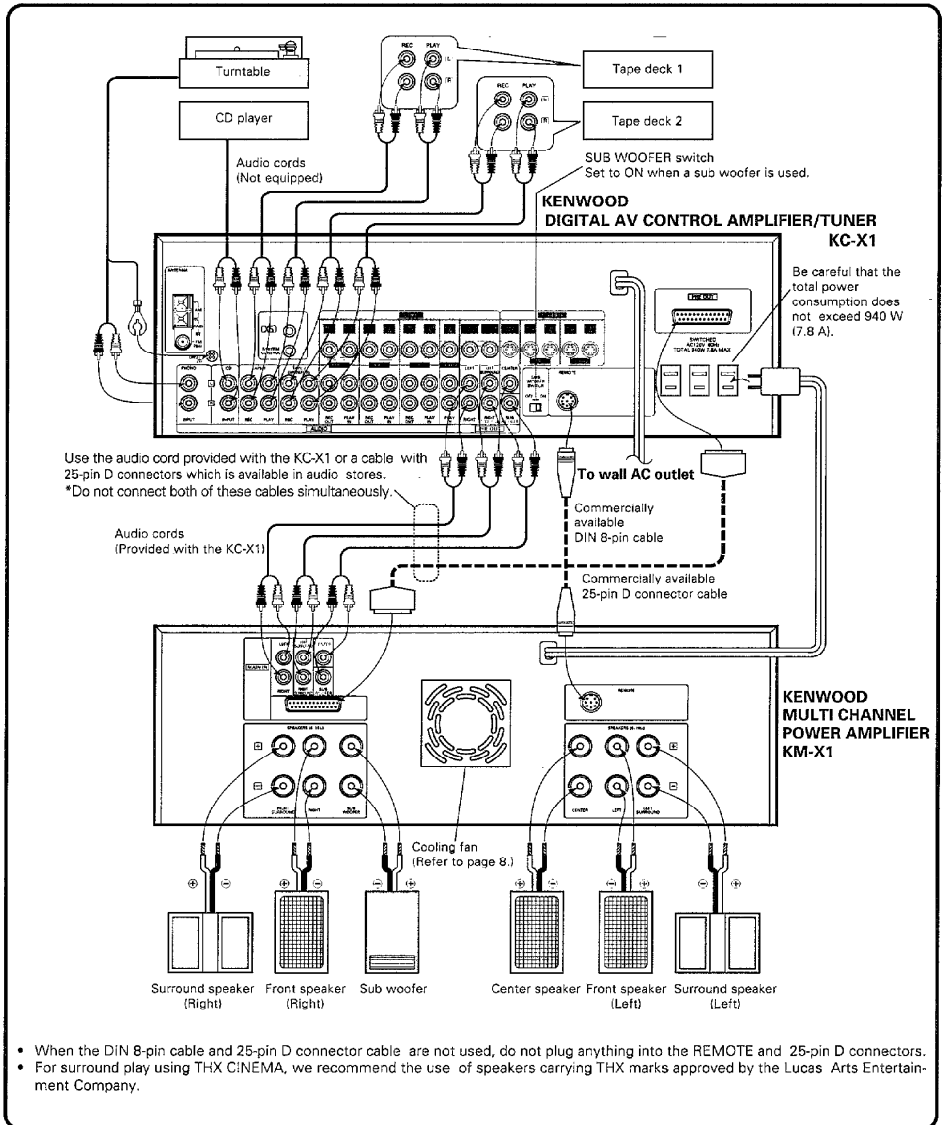

■ Speaker connection

When the speaker cords do not have any plug

① Strip the vinyl coating.

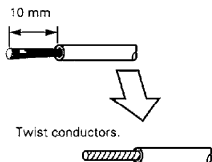

② Loosen the speaker terminal by turning the knob counterclockwise.

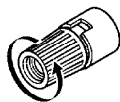

③ Insert the speaker cord conductor until the deep, and tighten the knob.

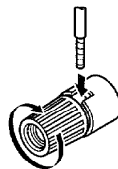

When the speaker cords have banana plugs

① Tighten the speaker terminal knob.

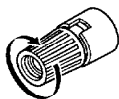

② Insert the banana plug into the terminal.

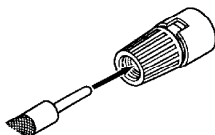

Cross-section

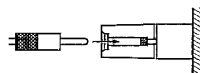

- Sound may not be produced if the speaker terminal knob is not tightened secure enough.

Notes:

1. Never short-circuit the + and - speaker cords.
2. If the left and right speakers are connected inversely or if the speaker cords are connected with reversed polarity, the sound becomes unnatural with ambiguous acoustic image positioning. Be sure to connect the speakers and speaker cords correctly.

Remote control operation

When the REMOTE connector of this unit is connected with the REMOTE connector of the KENWOOD KC-X1 Digital AV Control Amplifier/Tuner are connected using a cable equipped with DIN 8-pin connectors which is available in audio stores, the ON/OFF settings of this unit can be interlocked with the surround mode switching and sub woofer ON/OFF switching performed on the KC-X1.

Speaker impedance

Use speakers with an impedance of 6 to 16 ohms. Never connect a speaker with an impedance below 6 ohms, for this will cause malfunction of the amplifier.

Notes:

1. Connect all cords firmly. If connections are loose, there could be loss of sound or noise produced.
2. When plugging and unplugging connection cords, be sure to first remove the power cord from the AC outlet. Plugging/unplugging connection cords without removal of the power cord can cause malfunctions or damage to the unit.

Controls and indicators

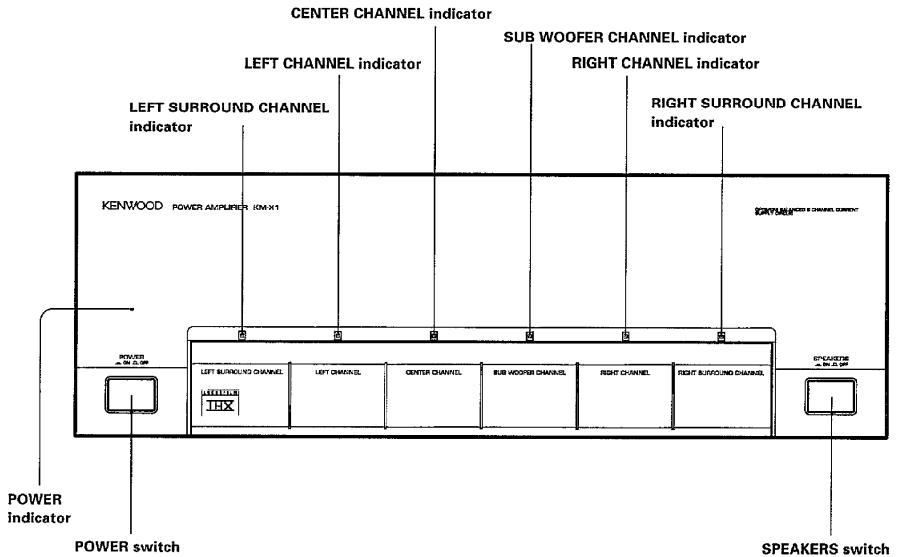

Caution on heat generation

- This unit incorporates a cooling fan on the rear to deal with the large amount of heat generation. The fan starts rotation automatically when the internal temperature of the unit rises. Install the unit taking care not to block the ventilation (heat radiation).
 - * Reserve clearances of more than 10 cm on the left and right, behind and above the unit. When the unit is installed in a rack, do not close tight with a door.
- The cooling fan of this unit is designed to absorb external air. If curtain or sheet of paper is attracted to the unit, the internal temperature may rise, and the sound may not be produced when the protection circuitry is activated due to temperature rise. Please be careful against this.

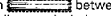
To allow heat radiation, leave a space, shown with  between this unit and the walls or rack shelves.

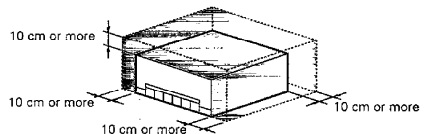

Operation

Note that the operation procedure of this unit differs slightly depending on if it is combined with the KENWOOD KC-X1 Digital AV Control Amplifier/Tuner or with an ordinary preamplifier.

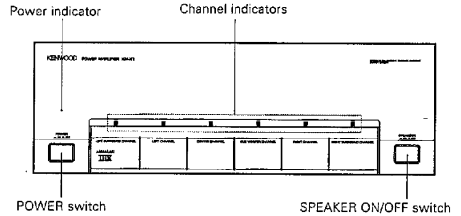

When the unit is connected to KC-X1

- 1 Set the POWER switches of this unit, the KC-X1 and related system components to ON.

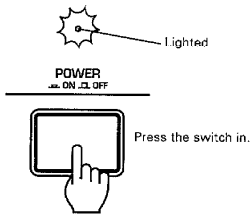

- 2 Set the SPEAKERS ON/OFF switch to ON.

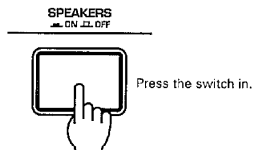

- When the REMOTE connectors of this unit and the KC-X1 are connected with a cable equipped with DIN 8-pin connectors. The channels of this unit are internally turned ON/OFF and the indicators are turned ON/OFF according to the the surround mode and sub woofer ON/OFF settings made on the KC-X1. (When BYPASS (normal stereo playback) is selected, the LEFT CHANNEL and RIGHT CHANNEL indicators on the front panel light, and the indicators of all channels light if the use of all channels is set.)

- 3 Select the source to be played.
Operate the KC-X1.

- 4 Play the source.
Surround functions such as THX CINEMA and Dolby Pro Logic are available. Enjoy desired programs by using them efficiently.

When the unit is connected with an ordinary preamplifier

- 1 Set the POWER switches of this unit, the related system components to ON.

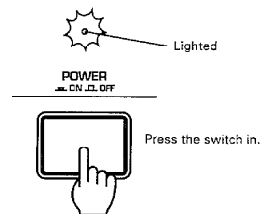

- 2 Set the SPEAKERS ON/OFF switch to ON.

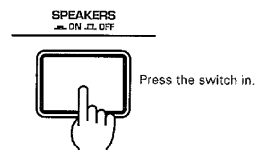

- The indicators of all channels light. (All channels are permanently ON when this unit is combined with an ordinary preamplifier.)

- 3 Select the source to be played.
Operate the preamplifier.

- 4 Play the source.

In case of difficulty

What appears to be a malfunction may not always be serious.

If your unit should not perform as expected, consult the table below to see if the problem can be corrected before seeking help from your dealer or service representative.

Symptom	Cause	Remedy
Sound cannot be produced	<ul style="list-style-type: none"> ● The speaker cords are not connected. ● The audio cords, REMOTE cable or multi cable are not connected. ● The [SPEAKERS ON/OFF] switch is set to OFF. 	<ul style="list-style-type: none"> ● Connect them properly referring to "System connections". ● Connect them properly referring to "System connections". ● Set the switch to ON.
All channel indicators are OFF (while the POWER indicator is lighted) and the sound is not reproduced.	<ul style="list-style-type: none"> ● The speaker cords are short-circuited. ● The protection circuitry is activated due to internal temperature rise. 	<ul style="list-style-type: none"> ● Turn the power OFF, remove the short-circuit, and turn the power ON again. ● Switch the power OFF and wait for the internal temperature to drop. The unit can be turned ON and re-used when the temperature drops, but the fundamental solution of the problem is not possible unless the unit installation (heat radiation) condition is corrected. Improve the unit installation referring to page 8.
Sound is not produced from one of the speakers.	<ul style="list-style-type: none"> ● One of the speaker cords is not connected. ● One of the audio cords is not connected. 	<ul style="list-style-type: none"> ● Connect it properly referring to "System connections". ● Connect it properly referring to "System connections".
Sound from the surround rear speaker is not produced or very low.	<ul style="list-style-type: none"> ● A speaker cord is not connected. 	<ul style="list-style-type: none"> ● Connect it properly referring to "System connections".
Some of the channel indicators do not light.	<ul style="list-style-type: none"> ● When the REMOTE connectors of this unit and the KC-X1 are connected using a DIN 8-pin cable, only the channels which should output sound are turned ON according to the surround and sub woofer settings. The indicators of other channels do not light in this case. 	<ul style="list-style-type: none"> ● They should light when the surround mode or the sub woofer ON/OFF setting is changed.

Note:

Do not use contract cleaners because it could cause a malfunction. Be specially careful against contact cleaners containing oil, for they may deform the plastic components.

Produced under approval of Lucas Arts Entertainment Company. Lucas Film THX Audio and HOME THX CINEMA are trademarks of Lucas Arts Entertainment Company. LUCAS FILM is a trademark of Lucas Film, Ltd.

SPECIFICATIONS

⚠ Caution: Read this page carefully to ensure safe operation.

AUDIO section

Rated power output (FTC)

STEREO MODE

130 watts per channel minimum RMS, both channels driven, at 8 Ω from 20 Hz to 20 kHz with no more than 0.03 % total harmonic distortion.

SURROUND MODE

Front

100 watts per channel minimum RMS, both channels driven, at 6 Ω from 20 Hz to 20 kHz with no more than 0.03 % total harmonic distortion

Center

100 watts per channel minimum RMS, both channels driven, at 6 Ω from 20 Hz to 20 kHz with no more than 0.03 % total harmonic distortion

Rear (Surround)

100 watts per channel minimum RMS, both channels driven, at 6 Ω from 20 Hz to 20 kHz with no more than 0.03 % total harmonic distortion

Sub woofer

100 watts per channel minimum RMS, both channels driven, at 6 Ω from 20 Hz to 20 kHz with no more than 0.03 % total harmonic distortion

Input sensitivity/impedance

MAIN IN 1 V/33 k Ω

Total harmonic distortion

STEREO MODE

..... 0.0015 % (1 kHz, 65 W, 8 Ω)

Frequency response

MAIN IN 10 Hz–100 kHz, +0 dB, –3 dB

Signal to noise ratio
(IHF A)

MAIN IN 105 dB

GENERAL

Power consumption 7 A

Dimensions W: 440 mm (17-5/16")
H: 161.5 mm (6-3/8")
D: 380 mm (14-15/16")

Weight (Net) 20 kg (44.1 lb)

Note:

KENWOOD follows a policy of continuous advancement in development. For this reason specifications may be changed without notice.

KENWOOD

Free Manuals Download Website

<http://myh66.com>

<http://usermanuals.us>

<http://www.somanuals.com>

<http://www.4manuals.cc>

<http://www.manual-lib.com>

<http://www.404manual.com>

<http://www.luxmanual.com>

<http://aubethermostatmanual.com>

Golf course search by state

<http://golfingnear.com>

Email search by domain

<http://emailbydomain.com>

Auto manuals search

<http://auto.somanuals.com>

TV manuals search

<http://tv.somanuals.com>