

2

Using your Kenwood Audio/Video System

Spectrum 850 AV

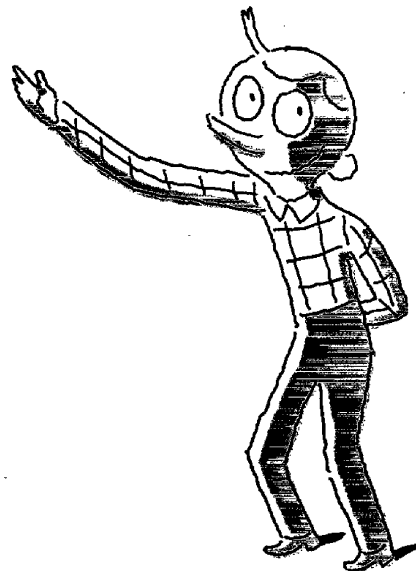

KENWOOD

Contents

| | | | |
|---|----|---|----|
| Contents | 3 | Tuning preset stations | 22 |
| Welcome | 5 | Scrolling through preset stations | 22 |
| Using the integrated amplifier | 6 | Using the CD player | 24 |
| The front panel controls and display | 6 | The front panel controls and display | 24 |
| Using the remote | 8 | Before using your CD player | 26 |
| A few tips | 8 | Displaying CD time information | 27 |
| Loading and replacing the batteries | 9 | Loading CDs | 27 |
| The basic audio functions | 10 | Changing CDs | 27 |
| Selecting the input source | 10 | During play | 27 |
| Adjusting the volume | 11 | When the player is stopped | 27 |
| Adjusting the bass and treble | 12 | Playing CDs | 28 |
| Muting the sound | 12 | From the beginning | 28 |
| Making the sound fuller at low volumes | 13 | From a specific track | 29 |
| Bypassing tone controls and surround circuitry | 13 | Playing a combination of tracks | 30 |
| Activating the speakers | 14 | Programming tracks | 30 |
| Adjusting the speaker balance | 14 | To check a program | 31 |
| Using headphones | 15 | To resume normal play | 31 |
| About the audio modes | 16 | To cancel a program and stop play | 31 |
| Dolby Pro Logic | 16 | Adding a track to a program | 31 |
| Dolby 3 Stereo | 16 | Changing a track in a program | 31 |
| Bypass | 16 | Clearing a track in a program | 31 |
| Selecting an audio mode | 17 | Clearing a whole program | 31 |
| Using the tuner | 18 | Playing CDs over (repeat play) | 32 |
| The front panel controls and display | 18 | Repeating a single CD | 32 |
| Tuning stations automatically | 20 | Repeating all loaded CDs | 32 |
| Tuning stations manually | 20 | Repeating programmed tracks | 32 |
| Storing preset stations | 21 | To stop repeat play | 32 |
| | | Playing tracks in random order (random play) | 33 |
| | | To select another track during random play | 33 |
| | | To cancel random play | 33 |
| | | Using a timer to play CDs | 33 |

| | |
|---|----|
| Using the cassette deck | 34 |
| The front panel controls and display | 34 |
| Before using your cassette deck | 36 |
| Maintaining your cassette deck | 36 |
| | |
| Listening to tapes | 37 |
| Playing a single tape | 37 |
| Fast-winding tapes | 38 |
| Playing tapes in both cassette wells (replay play) | 38 |
| Finding and playing a specific track (DPSS) | 39 |
| Repeating tracks | 39 |
| | |
| Recording tapes | 40 |
| Setting the recording level and balance | 40 |
| Recording a tape | 41 |
| Recording from a CD (with automatic recording-level set) | 42 |
| Recording from a CD (with automatic start and stop) | 43 |
| Creating custom tapes from CDs | 44 |
| Using a timer to record from the tuner | 46 |
| Recording from records | 46 |
| Copying (dubbing) a tape | 47 |
| | |
| Troubleshooting | 49 |
| Integrated amplifier | 49 |
| Tuner | 50 |
| CD player | 50 |
| Cassette deck | 51 |
| | |
| Specifications | 52 |
| Integrated amplifier (KA-996) | 52 |
| Tuner (KT-596) | 53 |
| CD player (DP-R896) | 53 |
| Cassette deck (KX-W896) | 53 |
| Speakers | 54 |

Welcome

Now that you've set up your Spectrum system, the real fun begins! Operating your system is easy, if you follow the step-by-step instructions in this manual. Spend a little time with the manual before you jump in, so you become familiar with the many capabilities of your system. Then put up your feet, sit back and enjoy the fabulous sound of your Spectrum system!

Using the integrated amplifier

The front panel controls and display

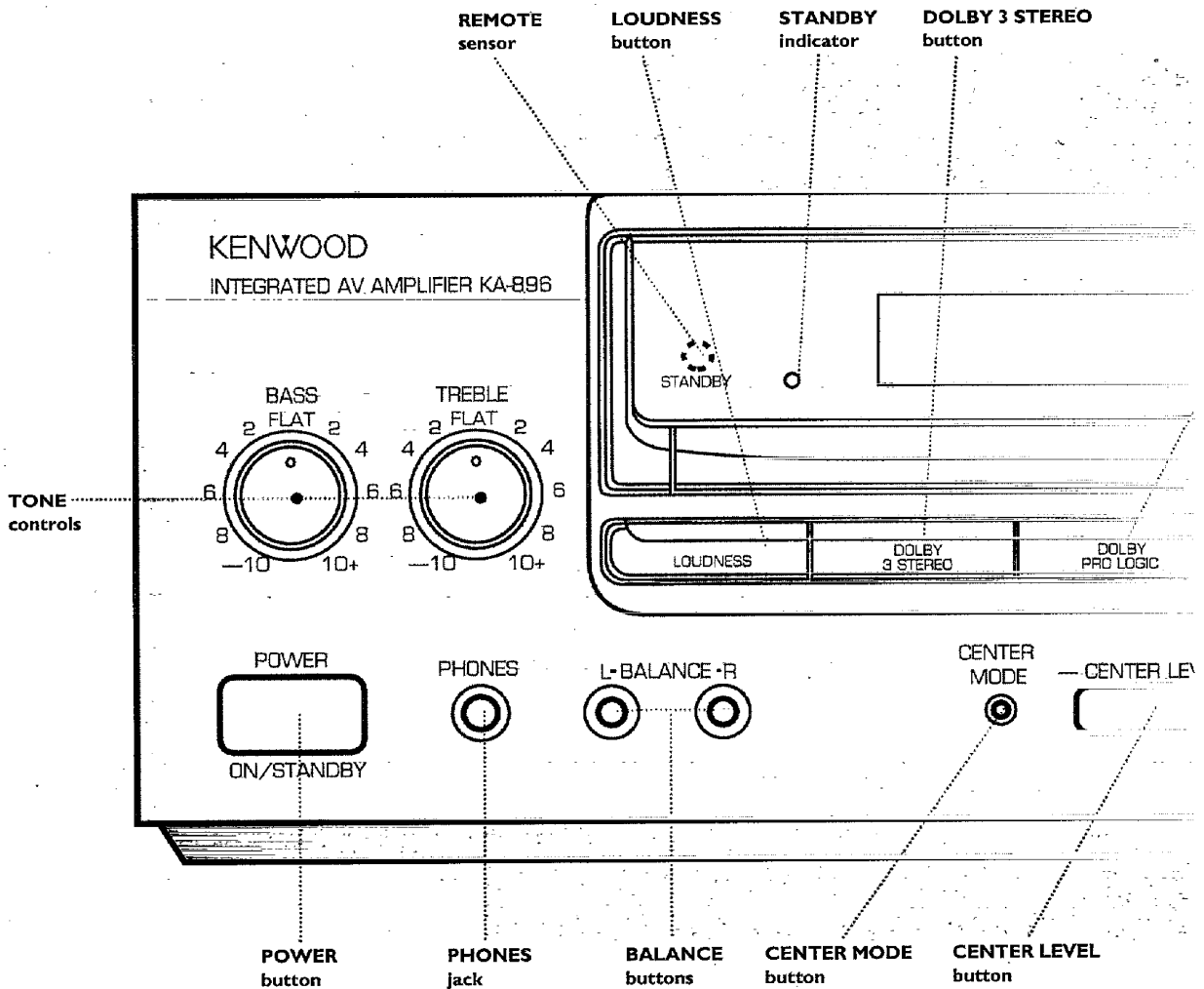

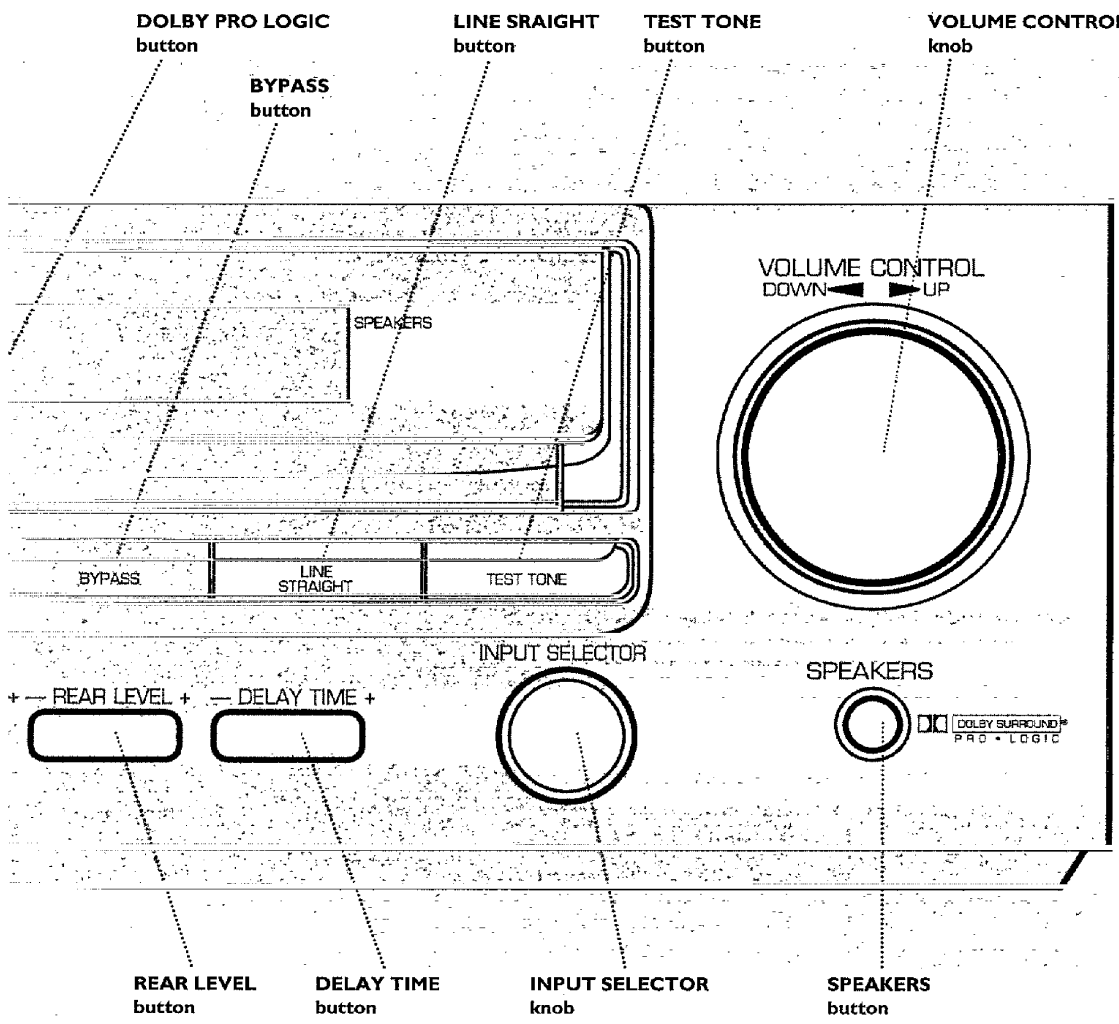
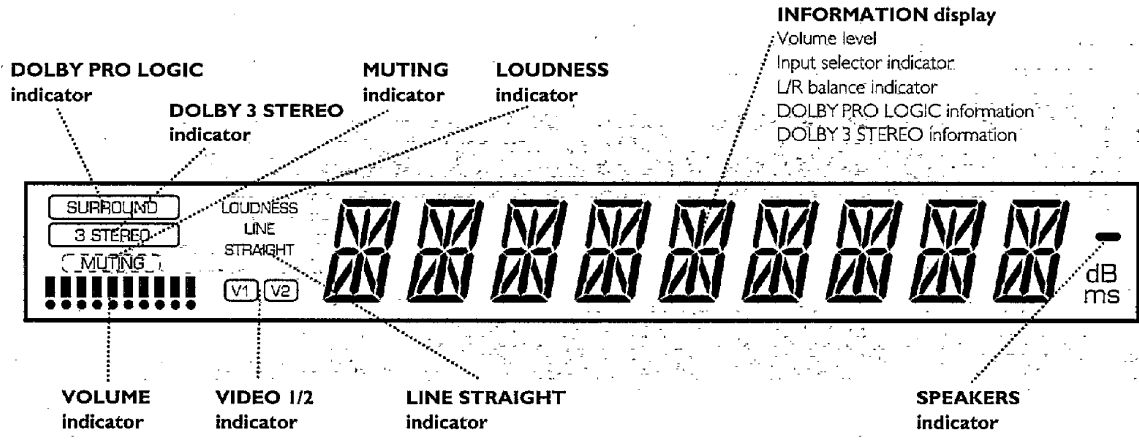

Using the remote

You can use your SPECTRUM system remote for many functions.

A few tips

- Depending on temperature, humidity, and other environmental conditions, the operating range of your remote is approximately 30' and up to 30° on either side of the integrated amplifier's remote light sensor.
- When the operating distance of your remote begins to get shorter, replace both alkaline batteries with new ones.

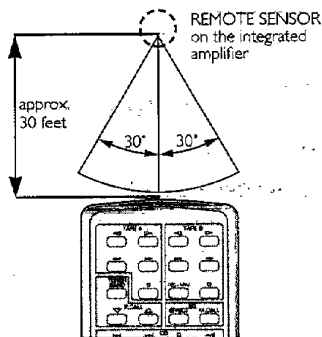

- When you press 2 buttons one after the other, press each button securely for more than 1 second each.
- The remote may malfunction if direct sunlight or high-frequency fluorescent light enters the light sensor. In this case, either move the audio system, or remove the light source.

Important:

The batteries that came with this system are test batteries and may not last as long as alkaline batteries.

TUNER buttons

- **TUNER BAND:** Press to switch between FM and AM
- **P. CALL:** Press to scroll through preset stations

CD PLAYER buttons

- Press ► to play disc, press again to pause disc
- Press ■ to stop disc
- Press ►► to skip to the next track
- Press ◀◀ to skip to the previous track
- Press DISC to change to next disc

INPUT SELECTOR button

Press to scroll through input choices

POWER button

Press to turn the system ON or OFF

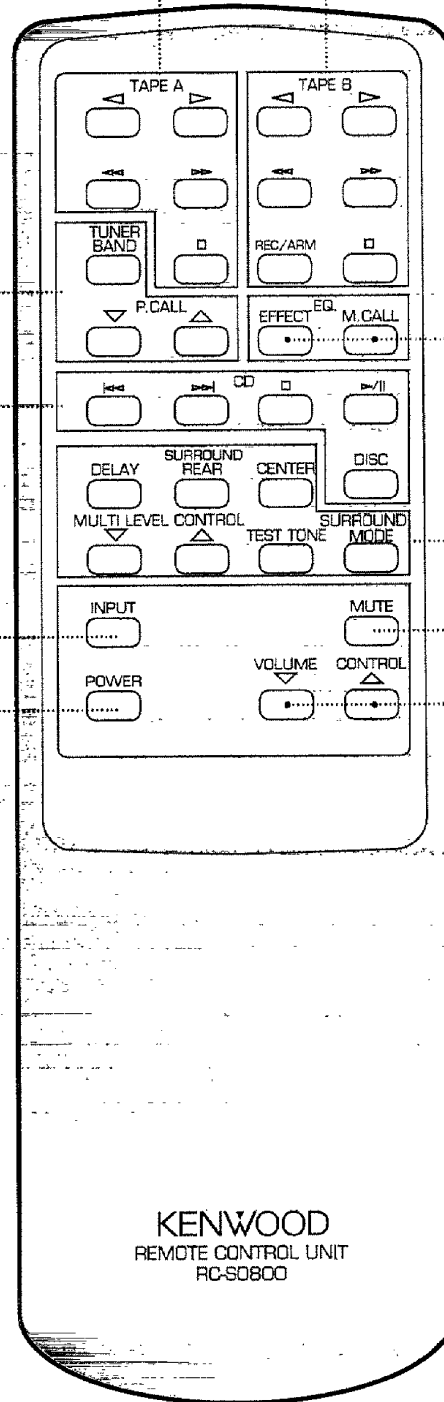

CASSETTE DECK

buttons

- Press ◀ or ▶ to play or reverse tape
- Press ◀◀ or ▶▶ to fast-forward or rewind tape
- Press ■ to stop tape
- Press REC/ARM to put the player into RECORD/PAUSE mode

EQUALIZER buttons

For use with an optional equalizer

- Press EFFECT to activate and deactivate EQ circuits
- Press M. CALL to activate EQ curves stored in memory

SURROUND SOUND

buttons

- MODE: Press to cycle through Dolby Pro Logic, Dolby 3 Stereo and Bypass
- TEST TONE: Press to turn the test noise ON and OFF
- CENTER: Press to adjust the center speaker level
- REAR: Press to adjust the rear speaker levels
- DELAY: Press to adjust the delay time
- MULTI-LEVEL CONTROL: Press to make center, rear and delay adjustments

MUTE button

Press to MUTE the sound, press again to turn ON sound

VOLUME buttons

Press ▲ or ▼ to increase or decrease volume

Loading and replacing the batteries

If the receiver doesn't respond when you press a button on the remote, you need new batteries. We recommend replacing both batteries at the same time for longer battery life.

- 1 Remove the cover by pressing down on the ridged area and sliding it off in the direction of the arrow.
- 2 Insert 2 AA-size alkaline batteries (be sure to pay attention to the (+) and (-) signs when you're inserting the batteries).
- 3 Close the cover.

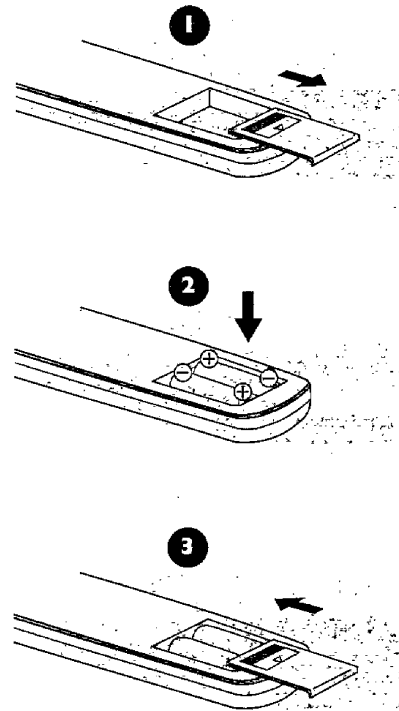

The basic audio functions

Selecting the input source

You can play audio from as many as 6 different sources, including:

- TUNER
- CD
- PHONO
- TAPE 1
- VIDEO 1
- VIDEO 2

Selecting from the front panel

Rotate the INPUT SELECTOR knob until you see the input source you want on the display.

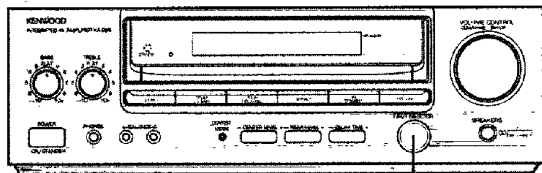

Selecting from the remote

Press the INPUT button until you see the input source you want on the display.

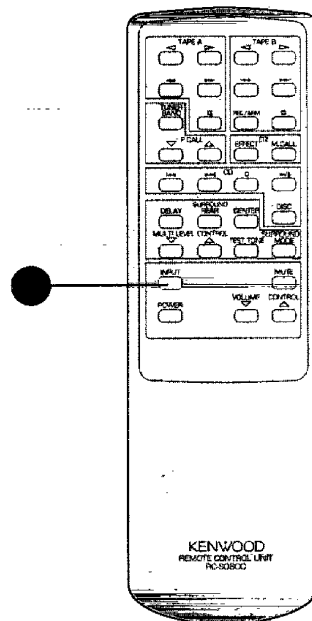

Adjusting the volume

You can increase or decrease the volume level in 1 decibel (dB) increments.

The amplifier's display shows the decibel level change.

Adjusting from the front panel

Turn the VOLUME knob to the right to increase the volume. Turn the knob to the left to decrease it.

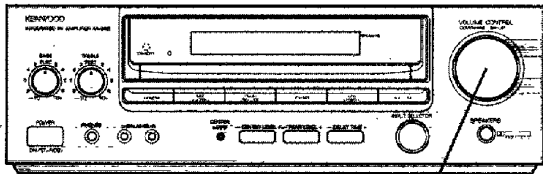

Adjusting from the remote

Press the VOLUME buttons to increase or decrease the volume level.

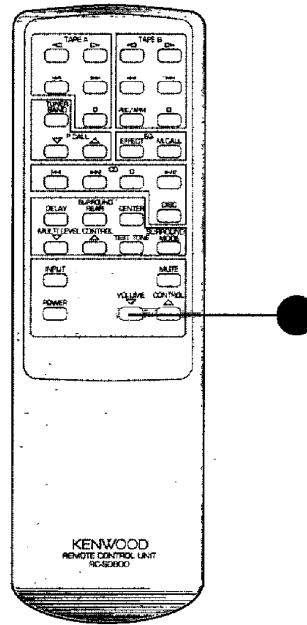

Adjusting the bass and treble

You can increase or decrease the bass or treble to personalize the sound.

Turn the BASS and TREBLE controls to the right to increase them. Turn the controls to the left to decrease them.

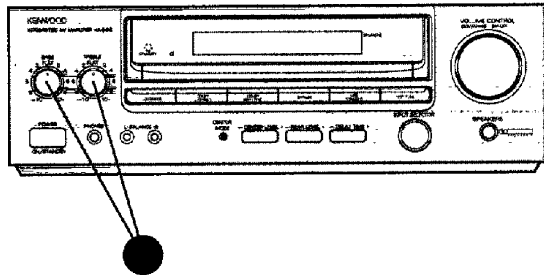

Muting the sound

You can quickly turn OFF the sound (when the phone rings, for example), and turn it ON again without stopping play.

Press the MUTE button to turn the sound OFF. Press it again to turn the sound ON.

The MUTE light on the display flashes while MUTE is ON.

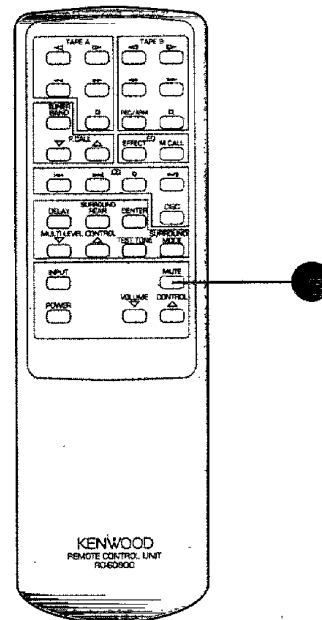

Making the sound fuller at low volumes

You can adjust the bass when you're listening at low volumes. This compensates for the fact that your hearing is less sensitive to bass at these volumes.

Press the **LOUDNESS** button to increase the bass. Press it again to restore normal tonal balance.

The **LOUDNESS** light on the display turns **ON** when **LOUDNESS** is **ON** and goes **OFF** when **LOUDNESS** is **OFF**.

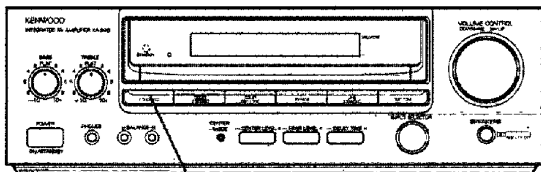

Bypassing tone controls and surround circuitry

You can bypass the tone controls and the surround sound circuitry to enjoy your music with purer sound quality.

Press the **LINE STRAIGHT** button to bypass the tone controls and surround circuitry. Press it again to cancel.

The **LINE STRAIGHT** light on the display illuminates when **LINE STRAIGHT** is **ON** and goes **OFF** when **LINE STRAIGHT** is **OFF**.

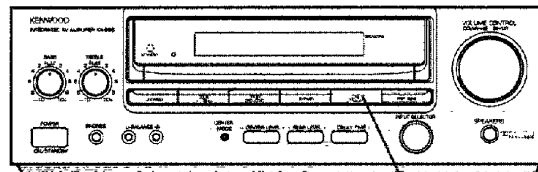

Activating the speakers

You can turn all of the speakers ON or OFF (for example, to use headphones) with the SPEAKERS button.

- 1 Press the SPEAKERS button (while they are off) to turn the speakers ON.
- 2 Press the SPEAKERS button again to turn the speakers OFF.

The SPEAKERS light on the display turns ON when the speakers are ON, and it goes OFF when the speakers are OFF.

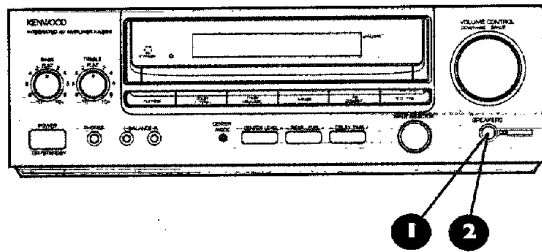

Adjusting the speaker balance

You can adjust the volume balance between the left and right speakers.

- 1 Press the L BALANCE button to decrease the right speaker volume and maintain the left.
- 2 Press the R BALANCE button to decrease the left speaker volume and maintain the right.

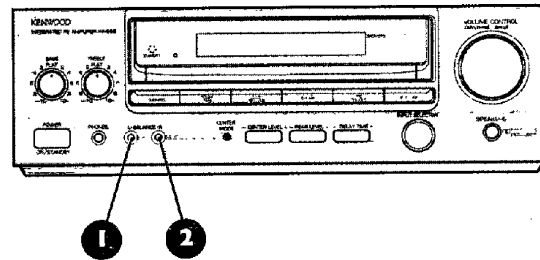

While you're adjusting the balance, the display shows the relative volume between the left and right speakers.

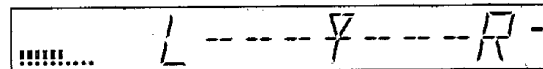

Using headphones

You can use headphones to listen to music or the soundtrack of a film or TV in private.

- 1 Turn the speakers OFF.
- 2 Insert the headphone plug into the HEADPHONE jack, and then put them on.

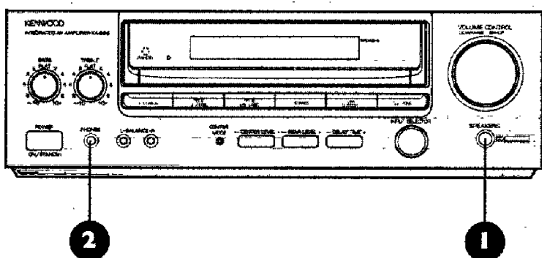

Important:

There are a few things to keep in mind when using headphones:

- Turn the volume down before switching the speakers back on.
- You can use your headphones with the speakers on, but be careful. The volume through the headphones is usually lower than the volume through speakers. When you turn up the volume for the headphones, be careful not to turn it up so loud you damage your speakers.

About the audio modes

Using one of the system's audio modes, you'll get optimum sound from your system, whether you're playing music or watching a movie.

Dolby Pro Logic

Use it for movies, music videos, stereo TV broadcasts, and audio CDs recorded in Dolby Surround, and some older films with the Dolby Stereo logo. Dolby Pro Logic is designed to recreate the surround sound from films, music videos, and stereo TV broadcasts encoded in Dolby Surround. It'll bring out the full effect of Dolby Surround-encoded audio CDs and even do a great job with standard CDs.

Dolby 3 Stereo

Use it for movies, music videos, stereo TV broadcasts, and audio CDs recorded in Dolby Surround, and some older films with the Dolby Stereo logo. Dolby 3 Stereo takes Dolby Surround-encoded movies and decodes the sound for a system without surround speakers.

Bypass

Use it for audio CDs not recorded in Dolby Surround, and tapes, records, and TV broadcasts not encoded in Dolby Surround. Bypass mode uses the left and right front speakers for standard music play. It's called 'bypass' because it bypasses the surround processing.

Selecting an audio mode

Selecting from the front panel

Select the appropriate button for DOLBY PRO LOGIC, DOLBY 3 STEREO, or BYPASS.

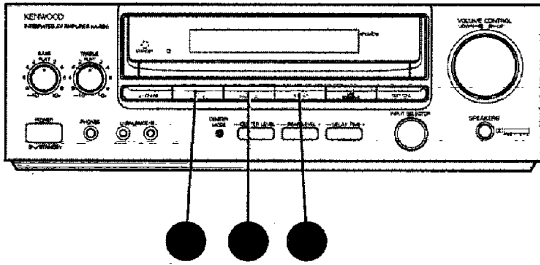

Selecting from the remote

Press the SURROUND MODE button to scroll through DOLBY PRO LOGIC, DOLBY 3 STEREO, and BYPASS.

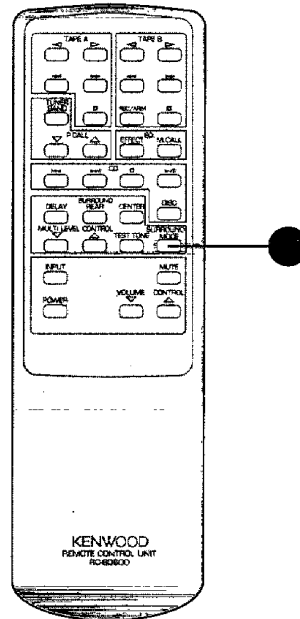

Using the tuner

The front panel controls and display

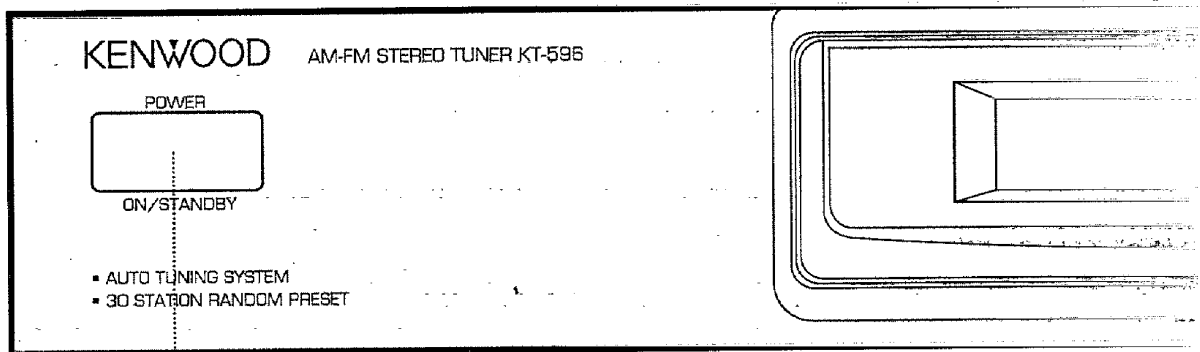

POWER button

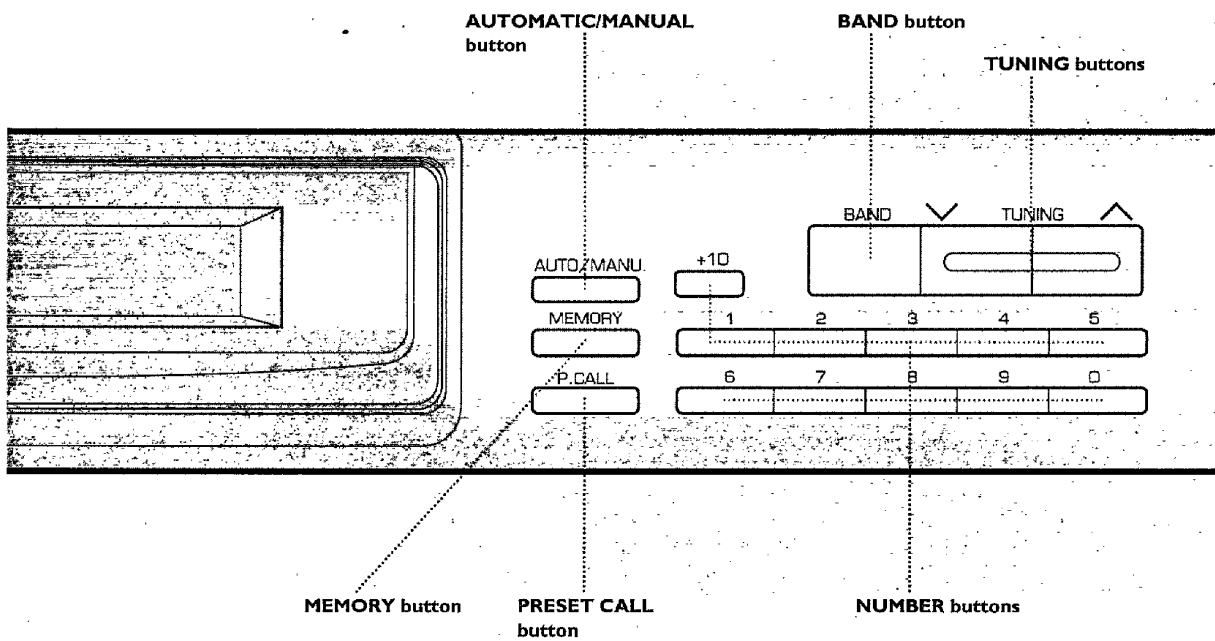
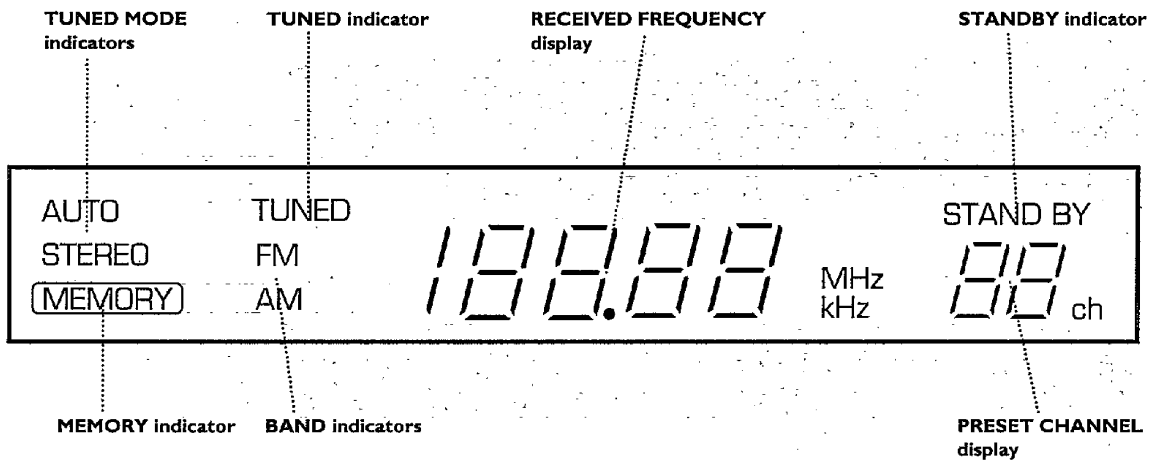

Tuning stations automatically

You can automatically find the strongest radio station signals.

- 1 Select the TUNER input.
- 2 Press the BAND button to select FM or AM.
- 3 Press the AUTO/MANU button to select AUTO. The AUTO light turns ON.
- 4 On the TUNING buttons, press ▲ to move up the broadcast band, or ▼ to move down the broadcast band.

The tuner stops automatically when it finds a strong station, and the TUNED light turns ON. If the station is broadcasting in stereo, the STEREO light turns ON.

- 5 Press ▲ or ▼ again to find the next strong signal.

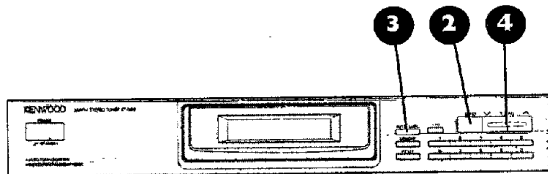

Tuning stations manually

You can search for radio stations in small steps up and down the broadcast band to tune in a weak station that automatic tuning might miss.

- 1 Select the TUNER input.
- 2 Press the BAND button to select FM or AM.
- 3 Press the AUTO/MANU button to select MANUAL. The AUTO light turns OFF.
- 4 On the TUNING buttons, press ▲ to move up the broadcast band, or ▼ to move down the broadcast band to the station you want.

The frequency changes by 0.1 MHz (FM) or 10 kHz (AM) each time you press the button, or it continually changes if you hold the button down.

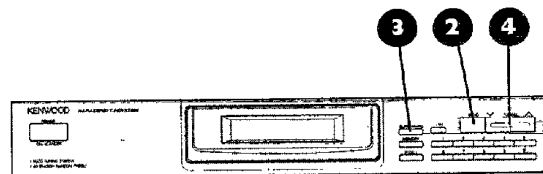

Important:

During manual tuning, the tuner receives stations only in mono.

- To receive a tuned station in stereo, press the AUTO/MANU button so the AUTO light turns ON. If the station is broadcast in stereo, you receive it in stereo.

- Weaker stations will be received with more background noise in stereo than in mono. To decrease the noise, press the AUTO/MANU button so the AUTO light goes OFF.

Storing preset stations

You can store up to 30 of your favorite radio stations in memory.

- 1 Tune in the station you want to preset.
- 2 Press the MEMORY button. The MEMORY light turns ON.
- 3 Within 5 seconds, enter the preset number using the number buttons. For example, to select preset #15, press the +10 button, then 5. To select preset #20, press the +10 button, the +10 button again, then 0.

If you've already assigned a station to a preset number, assigning a new station erases the old one.

- 4 To preset additional stations, repeat these steps.

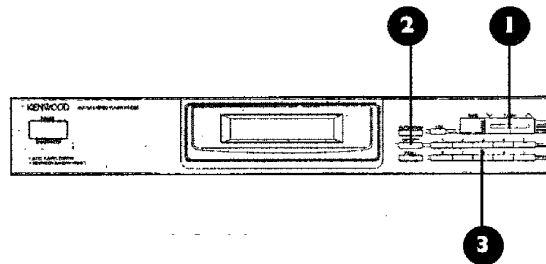

Tuning preset stations

You can quickly tune to any preset station.

Tuning from the front panel

- 1 Select the tuner input on the amplifier.
- 2 Press the number buttons assigned to the station.

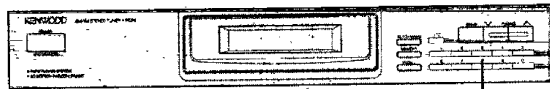

Scrolling through preset stations

You can scroll through all preset stations in sequence.

Scrolling from the front panel

- 1 Select the tuner input on the amplifier.
- 2 Press the P.CALL (Preset Call) button. Each time you press the button, the tuner advances to the next preset station number. The display shows the preset numbers.

If you hold the button down, the tuner advances through the preset stations at 1/2-second intervals. When you release the button, you hear the station tuned in at that time.

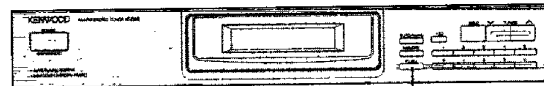

Scrolling from the remote

- 1 Use the INPUT button to select the tuner input.
- 2 Press the P. CALL buttons to scroll up or down through the preset stations. Each time you press the button, the tuner changes to the next or previous preset station number. The display shows the preset numbers. If you hold either button down, the tuner scrolls through the preset stations at 1/2-second intervals. When you release the button, you hear the station tuned in at that time.

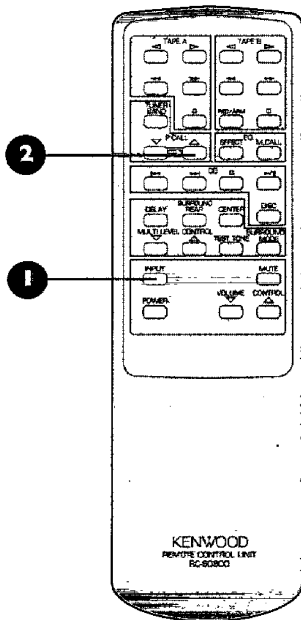

Using the CD player

The front panel controls and display

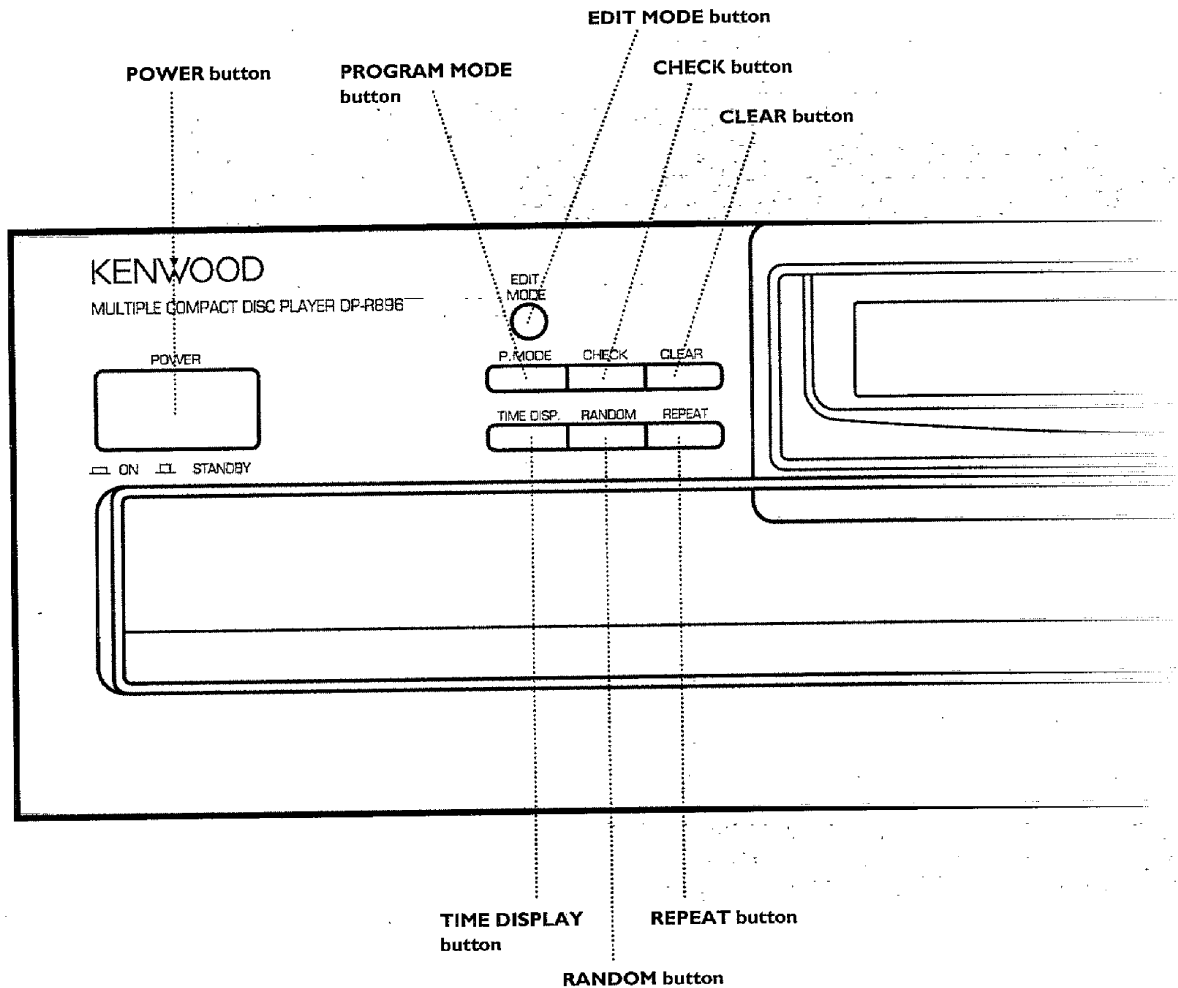

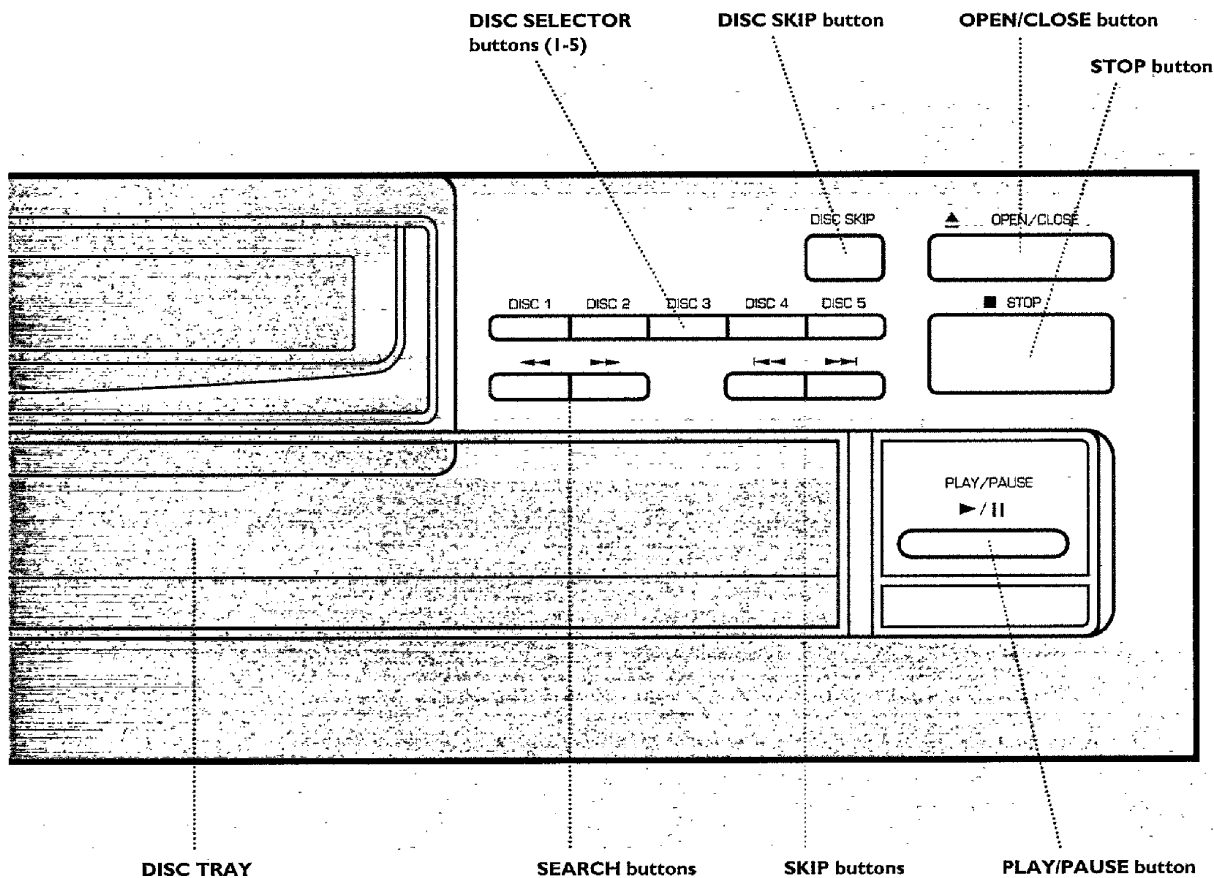
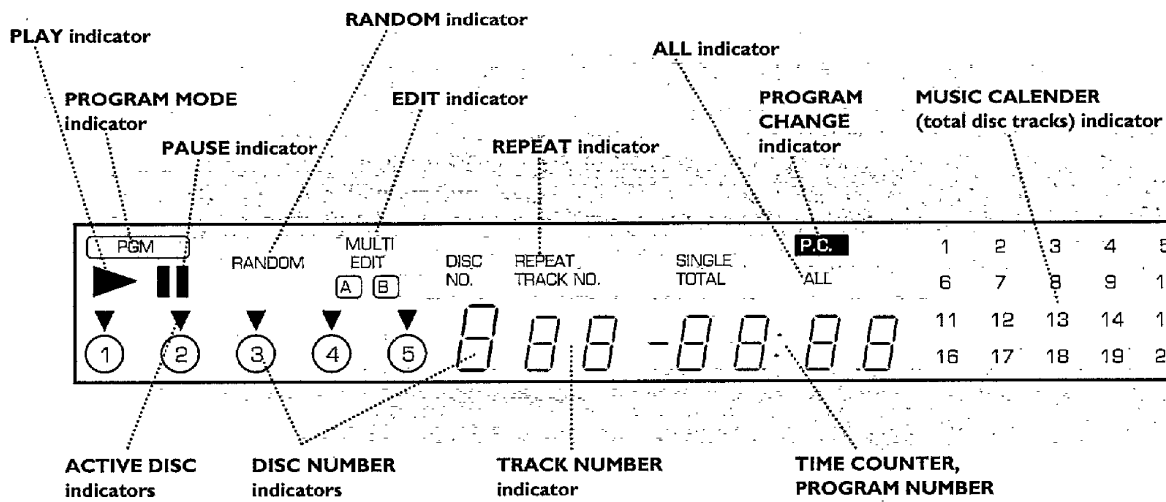

Before using the CD player

Please read the following instructions carefully to help prevent damage to your CD player and your CDs.

Compatible CDs

Your CD player plays standard 5" CDs and 3" CD singles and the audio portion of CDV discs and CD-G (CD plus graphics) discs.

Handling CDs

Hold a CD by its edges and center hole. Don't touch the playing surface or attach labels or tape to either side of the CD.

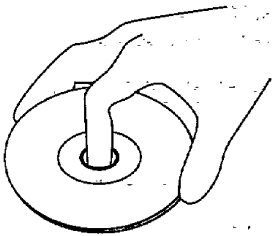

Cleaning CDs

To clean fingerprints or other dirt from a CD, gently wipe it with a soft cotton cloth moving in straight lines outward from the center.

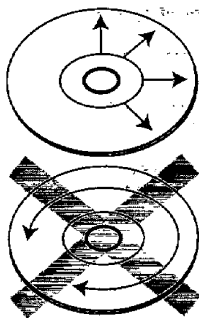

Storing CDs

To protect your CDs, store them in their cases. Don't leave them in the player for a long time.

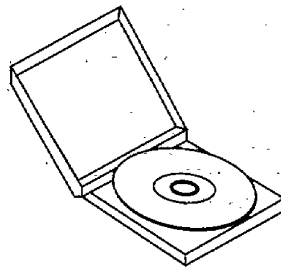

Damaged CDs

To avoid possible damage to your player, don't attempt to play cracked or warped CDs.

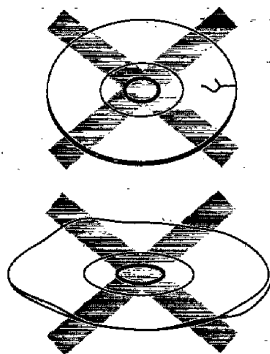

Condensation

Condensation of water vapor on the pickup lens may prevent proper operation of your CD player. To eliminate the condensation, leave the player ON for several hours. Condensation may occur when:

- You bring the player from a cool, or cold place to a warm or humid place.

- You operate a heater in the vicinity of the player.
- There's a big difference between the player's internal temperature and the temperature of the room the player is in.

Before you transport your CD player

- 1 Turn the player's power ON. Don't load any CDs.
- 2 Wait until 5 seconds after NO DISC appears on the display.
- 3 Turn the player's power OFF.

Displaying CD time information

You can view time information for the CD you're playing.

Press the TIME DISP. button to cycle between:

- TRACK TIME: Elapsed and remaining time of the current track.
- TOTAL TIME: Elapsed and remaining time of the CD.

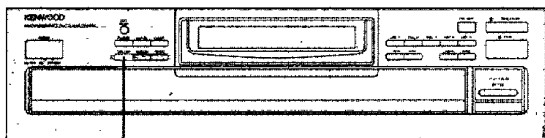

Loading CDs

- 1 Press the OPEN/CLOSE button to open the tray.
- 2 Place a CD in one of the tray's circular wells. While the tray is open, you can insert a CD in each of the 2 exposed wells.

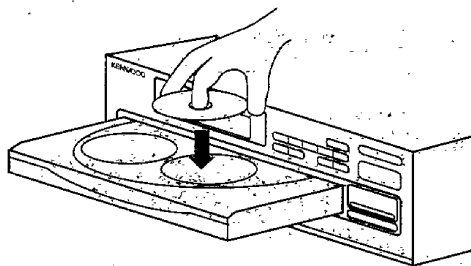

- 3 To insert more CDs, press the DISC SKIP button to rotate the tray. Insert a CD when the tray stops rotating.
- 4 When you're done, press the OPEN/CLOSE button to close the tray.

Changing CDs

During play

- 1 Press the OPEN/CLOSE button to open the tray.
- 2 Change the CDs in the exposed wells. If you want to put CD in an unexposed well, press the DISC SKIP button to rotate the tray. You can't change the CD currently playing.

When the player is stopped

- 1 Press the OPEN/CLOSE button to open the tray.
- 2 Change CDs in the exposed wells. If necessary, press the DISC SKIP button to rotate the tray.

Playing CDs

From the beginning

Playing from the front panel

- 1 Load one or more CDs.
- 2 Select the CD using the DISC SELECTOR buttons. An indicator ▼ appears on the display over the number of the selected CD. The selected CD automatically begins playing.

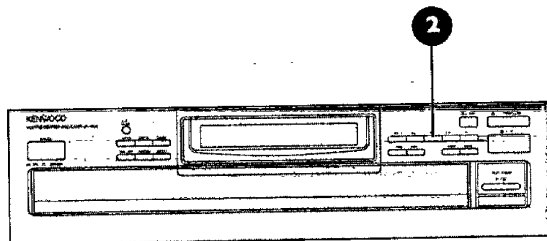

Whether you use the front panel or remote:

- If you don't select a CD when you've inserted more than 1 CD, the CDs play in order, starting with the CD in the lowest-numbered CD well.
- If you don't select a CD and you press the PLAY/PAUSE button, play begins with the CD number currently indicated on the display.

Playing from the remote

- 1 Load one or more CDs.
- 2 Press the DISC button until the indicator ▼ appears on the player's display over the number of the selected CD. The selected CD automatically begins playing.

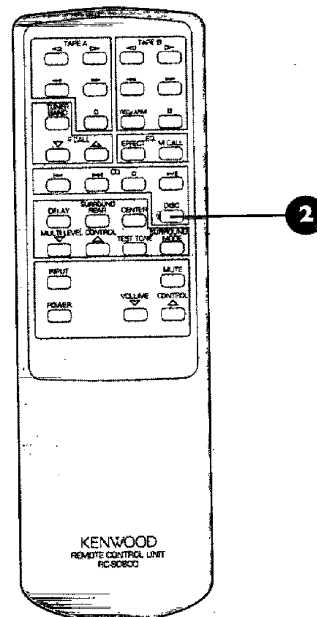

From a specific track

Playing from the front panel

- 1 Make sure that the PGM (Program Mode) light is OFF. If the PGM light is ON, press the P.MODE button.
- 2 Select the CD using the DISC SELECTOR buttons.
- 3 Select the track using the TRACK.SKIP buttons. Play begins from the selected track and continues.

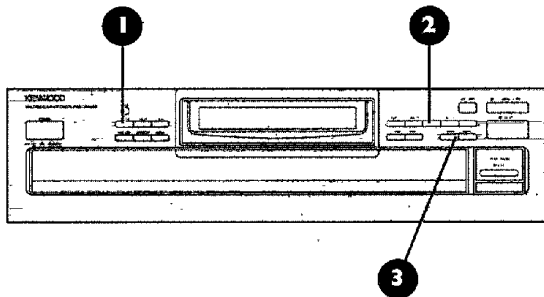

Playing from the remote

- 1 Make sure that the PGM light is OFF. If the PGM light is ON, press the P.MODE button.
- 2 Select the CD using the DISC button.
- 3 Select the track using the I◀◀ and ▶▶I buttons. Play begins from the selected track and continues.

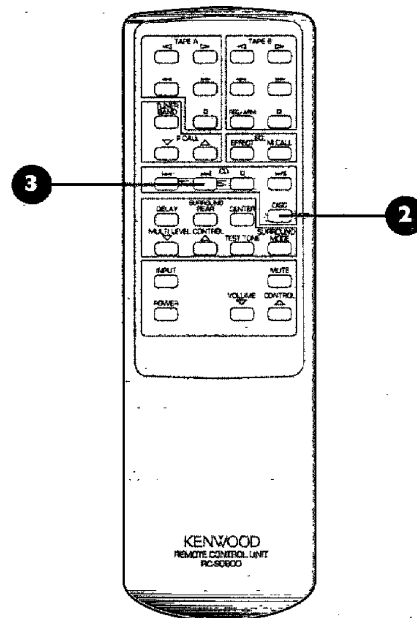

Playing a combination of tracks

You can program up to 32 tracks from any combination of CDs to play in any order.

A few hints:

- The player automatically adds a space of about 4 seconds between tracks in the PGM mode. This makes it easy to record tapes that are compatible with the track-finding function of Kenwood cassette decks. However, the PGM mode also inserts a 4-second space between 2 continuous, consecutive tracks programmed into memory, such as those on classical and live recordings.
- If you select the wrong track, press the CLEAR button, and select the correct track.
- When selecting tracks using the number buttons on the remote, you don't have to press the P.MODE button after each selection.
- Once you've programmed 32 tracks, the display indicates FULL, and you can't program any more tracks.
- If you press one of the SKIP buttons during Programmed play, the player skips the current track either forward or backward.

Programming tracks

- 1 Press the STOP button.
- 2 Press the P.MODE button. The PGM light turns ON.
- 3 Select a CD.
- 4 Select a track.
- 5 Press the P.MODE button. The PLAY light flashes, and the display shows the selected CD and track and indicates P—01.
- 6 Repeat steps 3 through 5 above to program each track.
- 7 Press the PLAY button to play.

You can program all the tracks on a CD (in order) by pressing the P.MODE button without selecting any track numbers. The CD takes up only 1 program memory slot, regardless of how many tracks are on it.

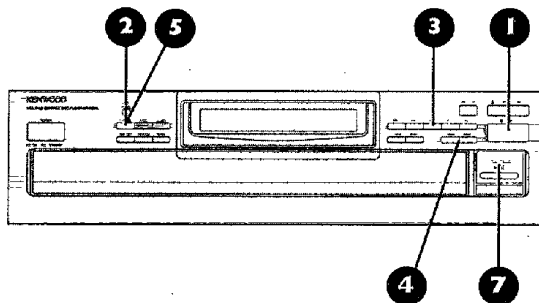

To check a program

Press the CHECK button. Each time you press the button, you see the CD and track numbers in the order you programmed them on the display.

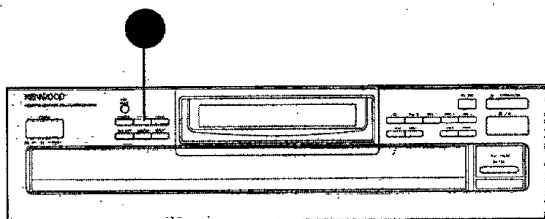

To resume normal play

Press the P.MODE button. After the current track is done, the tracks continue to play in the order on the CD.

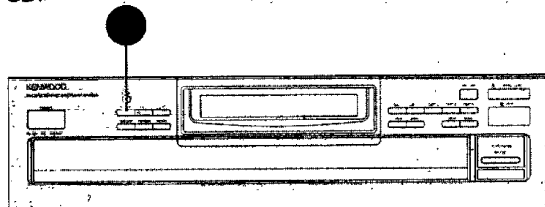

To stop programmed play

Press the STOP button.

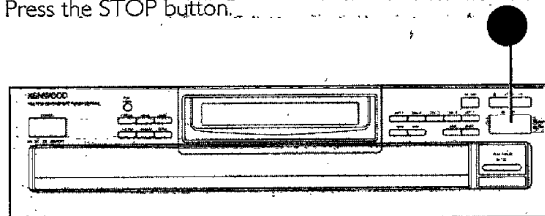

Adding a track to a program

You can add another track to the end of a program after the program has started playing.

- 1 Press the STOP button.
- 2 Select the CD and track to add.
- 3 Press the P.MODE button and then press PLAY.

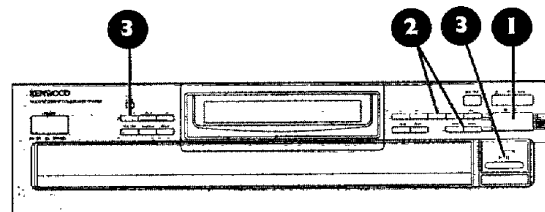

Changing a track in a program

You can change a track in a program after the program has started playing.

- 1 Press the STOP button.
- 2 Press the CHECK button until you see the P.# you want on the display. The P.C. light turns ON.
- 3 Select the new CD and track.
- 4 Press the P.MODE button, and then press PLAY.

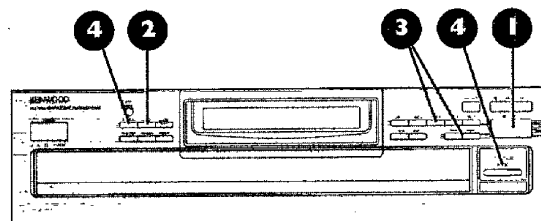

Clearing a track in a program

You can clear upcoming tracks in a program while it's playing.

Press the CLEAR button. Each time you press the button, you clear the tracks in order from the last track. You can't clear the track currently playing.

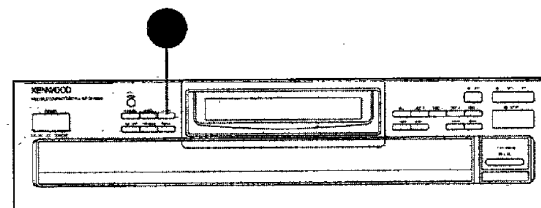

Clearing a whole program

Press either the P.MODE button or the OPEN/CLOSE button.

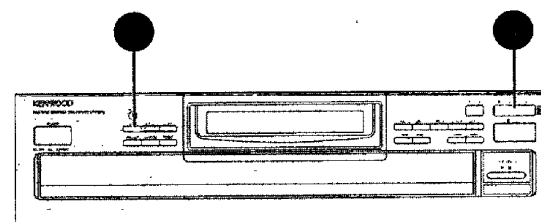

Playing CDs over (repeat play)

You can repeat a single CD, all loaded CDs, or the contents of a program.

Repeating a single CD

- 1 Press the STOP button.
- 2 Press the P.MODE button. The PGM light turns ON.
- 3 Select a CD.
- 4 Press the REPEAT button. The REPEAT light turns ON.
- 5 Press the PLAY button.

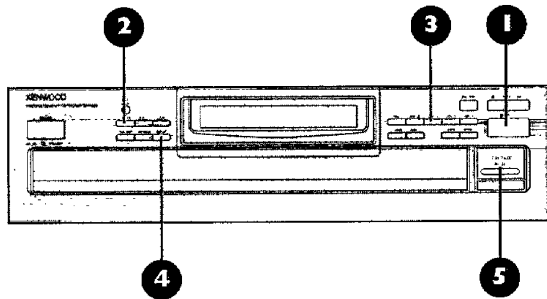

Repeating all loaded CDs

- 1 Make sure that the PGM light is OFF. If the PGM light is ON, press the P.MODE button.
- 2 Press the REPEAT button. The REPEAT light turns ON.
- 3 Press the PLAY button.

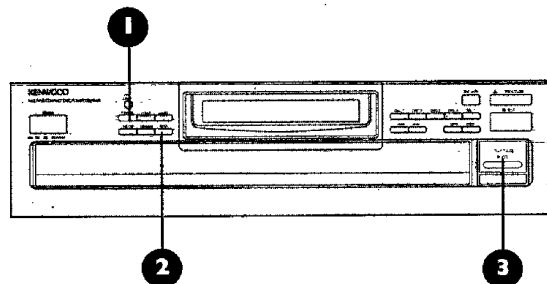

Repeating programmed tracks

You can repeat a programmed combination of tracks (see page 30, 'Programming Tracks'). If you only programmed 1 track, it plays over and over again.

- 1 Press the STOP button.
- 2 Press the REPEAT button. The REPEAT light turns ON.
- 3 Press the PLAY button.

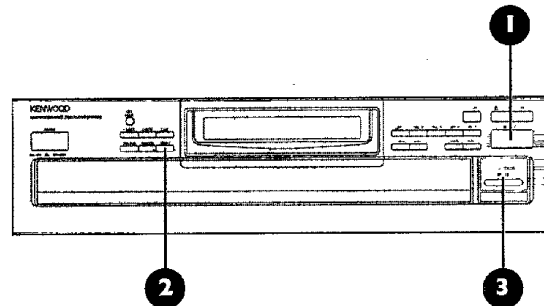

To stop repeat play

Press the REPEAT button while repeat play is ON. The REPEAT light goes OFF.

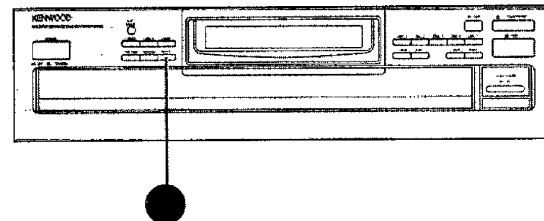

Playing tracks in random order (random play)

You can randomly play all the tracks from the CDs in the tray without repeating any tracks.

- 1 Make sure the PGM light is OFF. If the PGM light is ON, press the P.MODE button.
- 2 Press the RANDOM button. The RANDOM light turns ON, and the MUSIC CALENDAR flashes.

Random play continues until all tracks have been played.

You can continuously repeat random play by pressing the REPEAT button during random play.

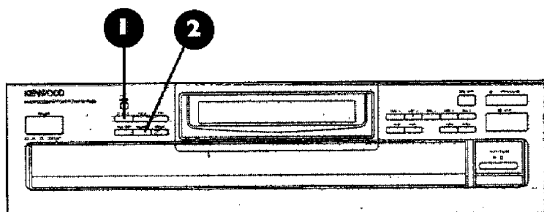

To select another track during random play

Press the Forward TRACK SKIP button.

To cancel random play

Press either the STOP, OPEN/CLOSE, or RANDOM buttons. Normal play starts from the track you're currently playing.

Using a timer to play CDs

You can use your CD player with an audio timer (you'll have to buy it on your own) to play CDs at a time you choose.

- 1 Connect the power cords of the Spectrum system to the audio timer so that the timer turns the system on. Be sure to follow the instructions included with the timer.
- 2 Turn the system ON.
- 3 Insert 1 or more CDs. If you insert more than 1 CD, play begins with the CD in the lowest-numbered CD well.
- 4 Set the volume.
- 5 Set the timer. At the set time, the system will turn on, and the CD player will begin playing.

Using the cassette deck

The front panel controls and display

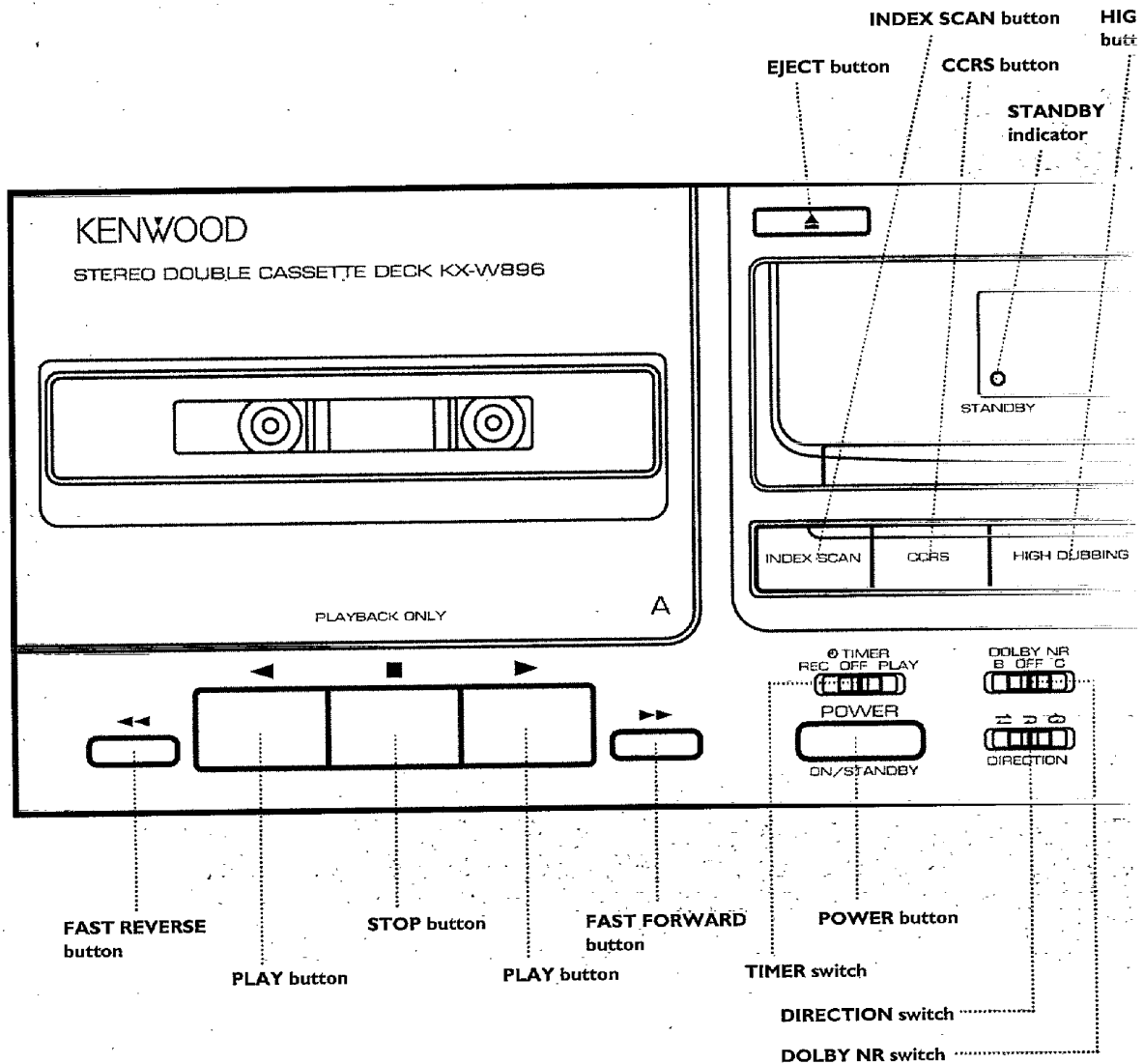

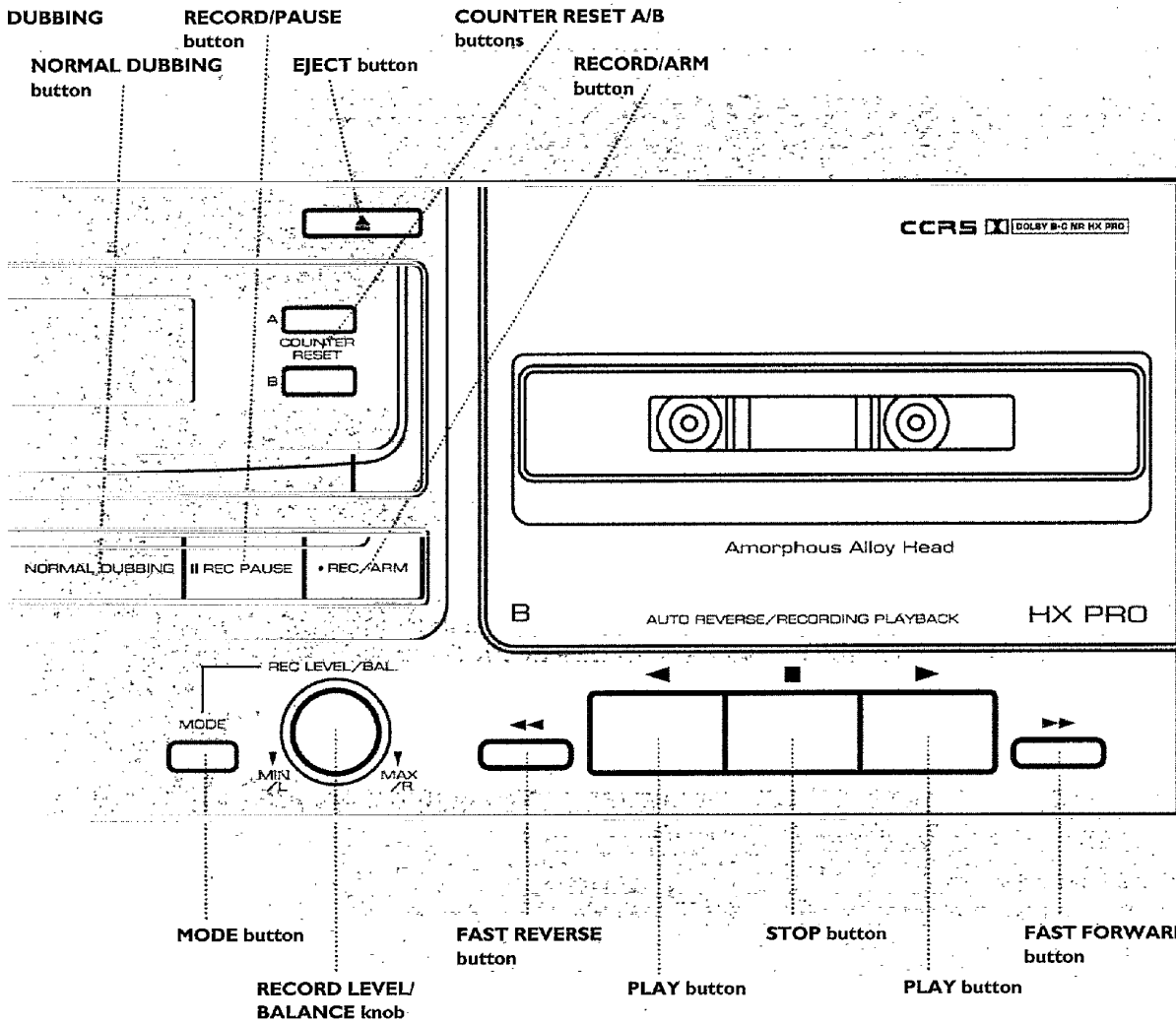
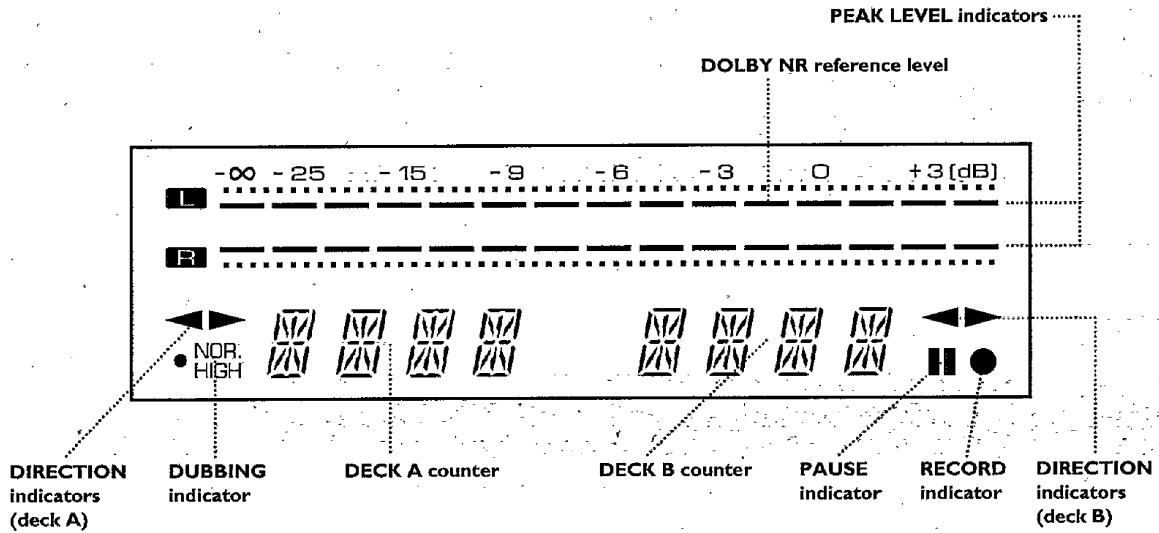

Before using the cassette deck

Please read the following instructions carefully to help prevent damage to your cassette tapes.

Preventing accidental recording on pre-recorded tape

To prevent the accidental recording of a tape, use a small screwdriver or other tool to remove the recording-activation tabs on the top edge of the cassette case.

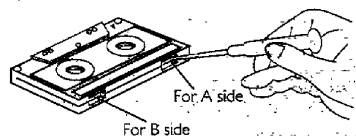

If there is slack in the tape

Insert a pencil into the tape reel hole, and wind the excess tape into the cassette case.

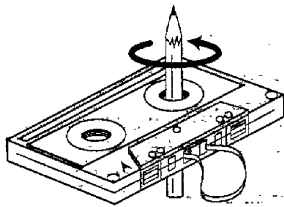

Storing cassettes

Store tapes away from direct sunlight, magnetic fields (including those produced by speakers and television sets), and heaters.

Special tapes

Using 120-minute tapes and/or endless tapes could damage the tape mechanisms. We don't recommend them.

Maintaining your cassette deck

After using the cassette deck for a long time, the heads (the parts that touch the tape) can become dirty and magnetized. This can cause poor sound, and over long periods of time will harm your cassette deck.

We recommend using both a head cleaning kit and a head demagnetizing kit. Both are available at the dealer where you purchased your system, or your local electronics store.

Listening to tapes

Playing a single tape

Before starting, be sure that the TIMER switch is OFF.

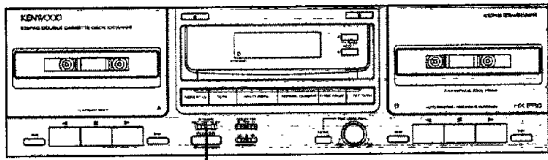

1 Insert a tape into a cassette well. The tape type (Normal or Chrome) is automatically selected.

2 Set the play mode.

 plays both sides of the tape repeatedly.

 stops after playing both sides of the tape.

 stops after playing 1 side of the tape.

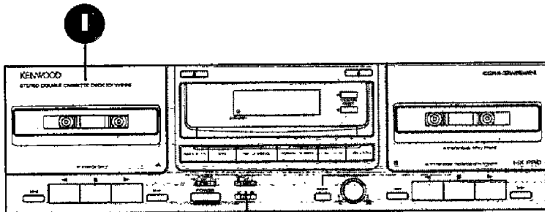

3 Set the Dolby Noise Reduction mode by moving the switch to the proper setting for the tape you're playing. For example, if you're playing a tape recorded using Dolby C, select Dolby C.

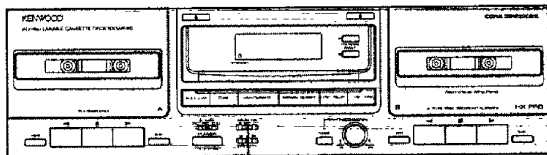

4 If you're using the remote, press the AUDIO button on the remote until the remote's display shows TAP A or TAP B (depending on which you're listening to).

5 On either the remote or the cassette deck's front panel, press the ◀ or ▶ button (depending on which side of the tape you want to listen to) to begin play.

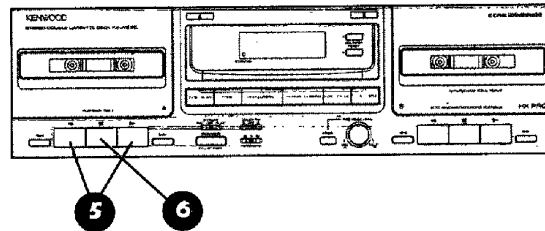

6 Press the ■ button on either the remote or the cassette deck's front panel to stop play.

About the direction indicators:

The ◀ and ▶ indicators show the direction the tape is moving. If you turn the power OFF, the tape plays in the same direction when you turn the power back ON.

Fast-winding tapes

On either the remote, or the front panel:

- 1 Press the ■ button.
- 2 Press either the ◀◀ button or the ▶▶ button.
- 3 Press the ■ button to stop fast-winding.

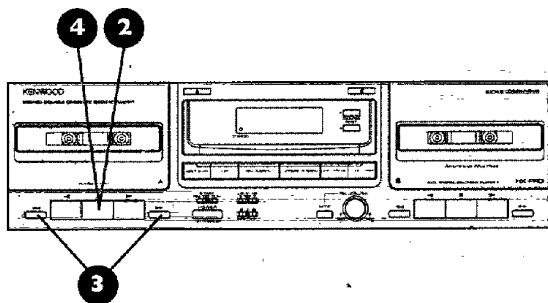
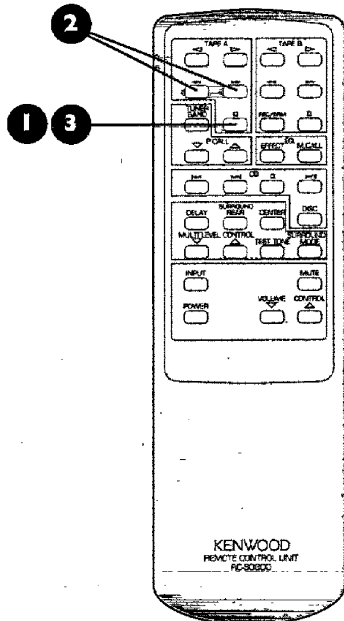

Note:

Although you can play tapes in either well, we're showing the controls for well A.

Playing tapes in both cassette wells (relay play)

You can automatically play Tape-B immediately after Tape-A is done.

- 1 Set the play conditions.

↻ plays both sides of each tape repeatedly.

→ plays one side of each tape repeatedly.

On either the remote or the front panel:

- 2 Press either the ◀ button or the ▶ button for the cassette well containing the tape you want to hear first.
- 3 To stop relay play, press the ■ button.

Finding and playing a specific track (DPSS)

You can skip ahead or back up to 16 tracks to find a specific track.

The examples show operations for the ► tape direction. For the ◀ tape direction, press the buttons opposite of those in the above instructions.

- To find the track immediately after the one currently being played, press the ►► button once.
- To find a track 4 tracks (as an example) after the one currently being played, press the ►► button 4 times.
- To play the track currently being played from the beginning, press the ◀◀ button once.
- To play a track 4 tracks (as an example) before the one currently being played, press the ◀◀ button 5 times.

Tip:

This function may not work properly under some conditions:

- If the tape contains blank spaces of less than 4 seconds between tracks.
- If the tape contains very quiet passages or silences during tracks, such as some classical music.
- If the recording level of the tape is very low.
- If people are talking on the tape.

Repeating tracks

You can repeat the track being played up to 16 times.

During play, press the ◀ or ► button (depending on which direction the tape is moving), and the track will repeat 16 times. Then normal playback will resume.

Recording tapes

You can record tapes from any source connected to your system: CDs, other tapes, records (if you've connected a record player), the tuner, and even the audio portion of videotapes or laser discs (if you have these components connected).

A few tips:

- To record tapes, use tape well B.
- You can't make recordings on metal tapes.
- Dolby Noise Reduction reduces tape hiss produced during tape play. You get the best results when you use the same mode (Dolby B or Dolby C) for both recording and play. Dolby B is the most widely used noise reduction system on pre-recorded tapes. However, Dolby C reduces tape hiss more effectively than Dolby B, so we recommend you use Dolby C on tapes recorded on this player. Be sure you mark the tapes you record either Dolby B or Dolby C so you can play them back properly.
- Dolby HX Pro is a circuit that helps to reduce distortion and improve frequency response on all recordings made by your player. Since the circuit works automatically during recording, you can hear the improvement in sound when you play the tape on any player, even one not equipped with Dolby HX Pro.

Setting the recording level and balance

Setting the proper recording level is an important part of making good tapes. If the recording level is too low, tape hiss may mask the music's softer parts. If the recording level is too high, the music may sound distorted. These instructions help you set the optimum recording level.

- 1 Put a blank tape in tape well B.

- 2 Press the MODE button to select the recording level (REC LEVEL).

The mode button cycles between REC LEVEL > REC BAL > COUNTER and then back to REC LEVEL.

- 3 Press the REC/PAUSE button.
- 4 Set the input of the integrated amplifier to the source you want to record. You can't select TAPE.
- 5 Find a loud section from the source you want to record, and play it.
- 6 Using the REC LEVEL/BAL knob, adjust the recording level so that the level indicators flash at 0 dB on the music's loudest passages. Turn the knob to the right to increase the recording level or to the left to reduce it.

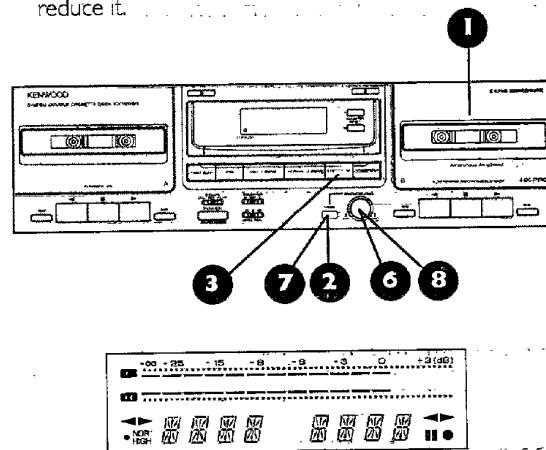



- 7 Press the MODE button so that the display reads BAL.
- 8 Using the REC LEVEL/BAL knob, adjust the recording balance so that the levels of the left and right channels are approximately the same. Turn the knob to the right to decrease the left channel or to the left to decrease the right channel.
- 9 Stop the input source.

Recording a tape

You can record tapes from any source you have connected to your system.

- 1 Put a blank tape in tape well B.
- 2 Set the recording level and recording balance (see page 40).
- 3 Select the tape direction ◀ or ▶, and immediately press the STOP (■) button.

 records on both sides of the tape.

 records on one side of the tape.

- 5 Select the Dolby Noise Reduction mode.
- 6 Use the INPUT SELECTOR knob on the integrated amplifier to select the source to record.

You can't select TAPE. See Copying (dubbing) a tape on page 47.

- 7 Press the REC PAUSE button.
- 8 Pause the source from the beginning.
- 9 Press the REC/ARM button.
- 10 Play the source.

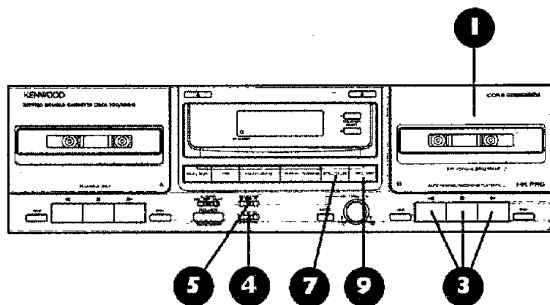

To pause recording

Press the REC PAUSE button.

The **II** indicator lights.

To stop recording

Press the ■ button, then stop the source component.

To record again after a mistake

- 1 Press the ◀◀ or ▶▶ button to rewind the tape. The recording stops, the tape rewinds to the beginning of the current track, and the cassette deck stops.
- 2 Press the REC/ARM button twice. A 4-second blank space is put on the tape, and the cassette deck enters the RECORD/PAUSE mode.

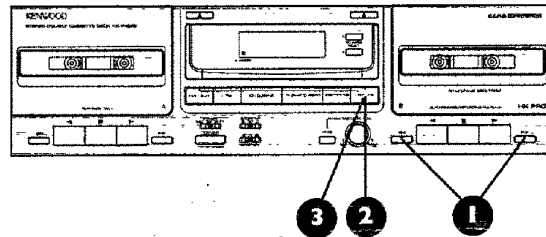

- 3 Press the REC/ARM button once.

- 4 Play the source again.

To record tapes so you can search for tracks

If you record blank space of at least 4 seconds between tracks on tapes you record, you can use the DPSS feature (see page 39) to look for a specific track.

If you're in the STOP mode, press the REC/ARM button twice.

If you're recording, press the REC/ARM button once.

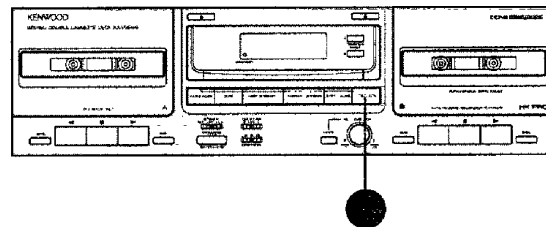

After recording a 4-second blank space, the deck enters the RECORD/PAUSE mode.

Recording from a CD (with automatic recording-level set)

You can automatically set the best recording level for recording from a CD using the system's Computer-Controlled Recording System (CCRS).

- 1 Using the CD player's DISC SELECTOR buttons, select a CD.
- 2 Insert a blank tape in tape well B.
- 3 Select the Dolby Noise Reduction mode.
- 4 Press the CCRS button. The CCRS light flashes.

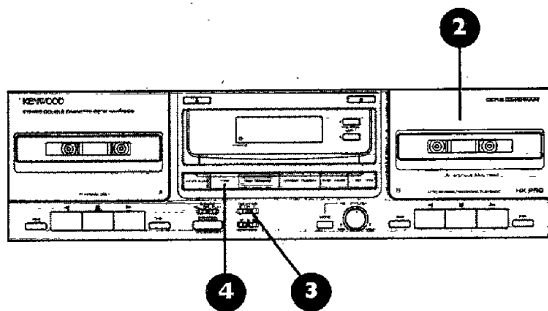

Several different parts of the CD are sampled, the CD's peak level is determined, and the best recording level for that CD is automatically set.

The CD and tape are automatically cued up at their beginnings, an 8-second blank space is recorded at the beginning of the tape, and the CD is automatically recorded.

- 5 When the system is done recording, press the CD player's OPEN/CLOSE button.

To cancel automatic recording

Press the CD player's STOP button. If the system has started recording, after you press the STOP button, press the OPEN/CLOSE button.

Here are a few important tips about automatic recording:

If you press the CCRS button while a CD is playing, the CD stops, and automatic recording begins.

- Automatic recording may not function properly if the amount of tape remaining on the cassette is small.

- You can't manually adjust the recording level and recording balance during automatic recording.

- In the rare instance when automatic recording can't set the best recording level, record the CD manually (see 'Recording a tape' on page 41).

Recording from a CD (with automatic start and stop)

You can tape automatically without cutting off the first few seconds of sound—the CD player and tape deck start and stop simultaneously. This method lets you set the recording level to your liking.

- 1 Put a blank tape in tape well B.
- 2 Set the recording level and recording balance (see page 40).
- 3 Select the tape direction ◀ or ▶, and immediately press the STOP button.
- 4 Select the recording mode:

↻ records on both sides of the tape.

→ records on one side of the tape.

- 5 Select the Dolby Noise Reduction mode.
- 6 Press the REC PAUSE button.
- 7 Press the PLAY/PAUSE button on the CD player. Recording begins when you push the button.

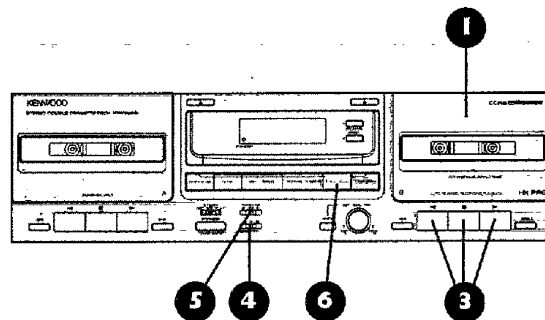

When the CD stops, the recording stops, and the player stops.

To pause the recording

Press the PLAY/PAUSE button on the CD player. You can skip to another track.

To resume recording

Press the PLAY/PAUSE button on the CD player again.

To stop recording

Press the STOP button on the CD player.

If you press the ■ button on the cassette deck, recording stops, but the CD player keeps playing.

Creating custom tapes from CDs

You can tape up to 32 tracks from one or more CDs to fit a particular tape length. The player automatically edits the order of the tracks, so no track is cut off at the end of the tape.

Taping a single CD

Your CD player automatically selects the number of tracks (in numerical order) to best fill Side-A. The player selects the tracks for Side-B the same way.

- 1 Make sure the PGM light is OFF. If the PGM light is ON, press the P.MODE button.
- 2 Press the STOP button.
- 3 Press the EDIT MODE button once. The EDIT light turns ON.
- 4 Select the CD you want to tape using the DISC SELECTOR buttons.
- 5 Press the TIME DISP. button, and enter the recording time of the tape. Each time you press the button, the time cycles from 46 > 54 > 60 > 90 and then back to 46. The time you selected flashes on the display.

You can adjust the time by pressing the DISC SKIP buttons. Each time you press the appropriate button, you increase or decrease the time by 1 minute.

- 6 Press the EDIT MODE button again. The EDIT light flashes, and the display shows the tracks selected for Side-A and then the tracks for Side-B. Finally, the PLAY light flashes, while the EDIT light remains ON.
- 7 To start recording, press the CCRS button on the cassette deck. Recording begins after about 1 minute. For an explanation of CCRS, see page 42.

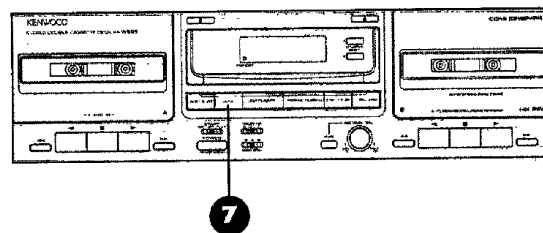
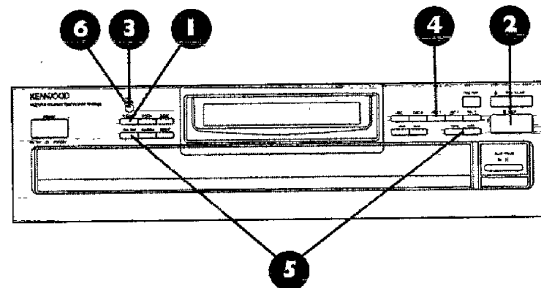

Taping tracks from multiple CDs

You can record tracks from more than one CD onto a single tape.

- 1 Make sure the PGM light is OFF. If the PGM light is ON, press the P.MODE button.
- 2 Press the STOP button.
- 3 Press the EDIT MODE button twice. The MULTI EDIT light turns ON.
- 4 Press the TIME DISP. button, and enter the recording time of the tape. Each time you press the button, the time cycles from 46 > 54 > 60 > 90 and then back to 46. The time you selected flashes on the display.

You can adjust the time by pressing the DISC SKIP buttons. Each time you press the appropriate button, you increase or decrease the time by 1 minute.

You can also enter the time by using the number buttons on the remote. In this case, you don't have to press the EDIT MODE button after entering the time.

- 5 Press the EDIT MODE button again.
- 6 Select the CD you want to tape using the DISC SELECTOR buttons.
- 7 Select the tracks to tape using the TRACK SKIP buttons.

If you make a mistake, press the CLEAR button, and select the correct track.

- 8 Press the P.MODE button after each track selection. The display shows the time remaining on Side-A.

If the time remaining on Side-A is shorter than the track you selected, that track is programmed onto Side-B. When B-FULL is displayed, both sides are full.

- 9 To tape from more than 1 CD, repeat steps 6 through 8.

- 10 To tape, press the CCRS button on the cassette deck. Recording begins after about 1 minute. For an explanation of CCRS, see page 42.

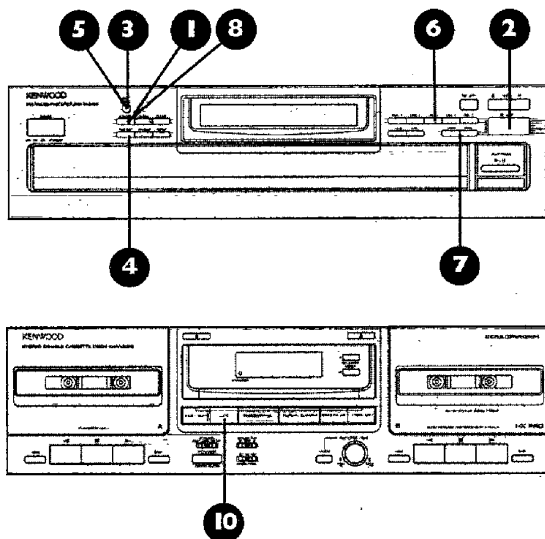

Checking the tracks you've selected

For a single CD, press the CHECK button. The track numbers of the selected tracks are automatically displayed.

For multiple CDs, press the CHECK button. Each time you press the button, you advance the display to the next track number.

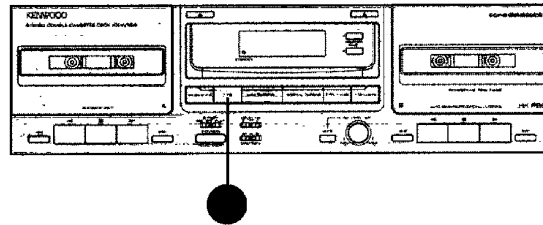
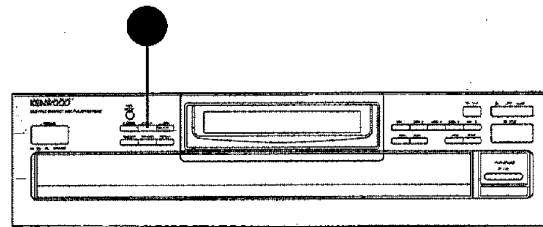

Clearing tracks from the selection

For a single CD, press the P.MODE or the OPEN/CLOSE button.

For multiple CDs, press the P.MODE button.

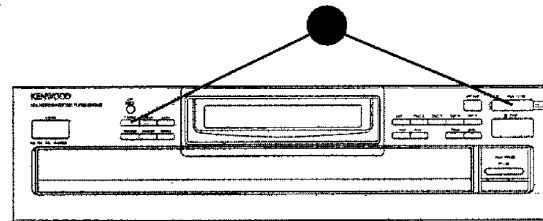

Using a timer to record from the tuner

You can set the cassette deck to record from the tuner at a preset time (to record a specific radio show, for example).

- 1 Connect the power cords of the Spectrum system to the audio timer so that the timer turns the system ON. Follow the instructions included with the timer.
- 2 Turn the system ON.
- 3 Tune in the radio station.
- 4 Insert a blank tape in tape well B.
- 5 Set the recording mode, Dolby Noise Reduction, and adjust the recording level. Make sure you're selected TUNER on the integrated amplifier.
- 6 Set the timer.
- 7 Set the TIMER switch on the cassette deck to REC.

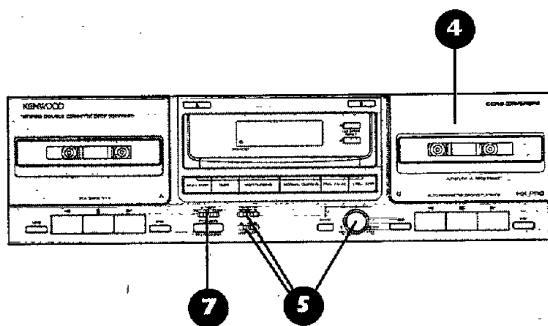

To ensure that the cassette deck's automatic shutoff works properly, set the timer to operate for a little longer than the length of the tape.

Recording from a record (with automatic start and stop)

You can make tapes from your records if you have a Kenwood turntable connected to your Spectrum system with a system control cable. The record and tape deck will start and stop simultaneously.

- 1 Put a blank tape in tape well B.
- 2 Select the tape direction ◀ or ▶.
- 3 Immediately press the STOP button.
- 4 Select the recording mode:

↻ records on both sides of the tape.

→ records on one side of the tape.

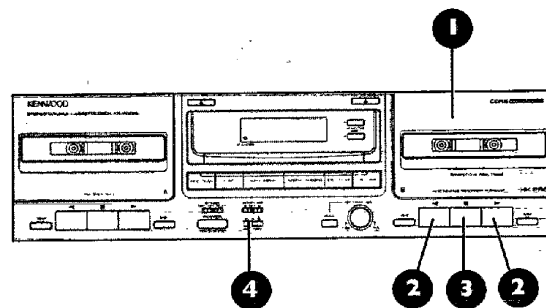

- 5 Select the Dolby Noise Reduction mode.

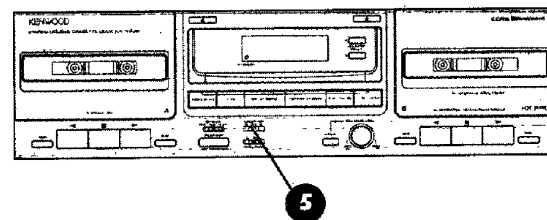

- 6 Adjust the recording level according to the instructions in 'Setting the recording level and balance' on page 40.

7 Press the REC PAUSE button.

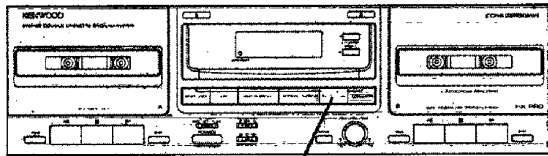

8 Press the PLAY/CUT button on the turntable to start recording.

When the turntable stops, the recording stops, and the player stops.

To stop recording

Press the PLAY/CUT button on the turntable.

If you press the ■ button on the cassette deck, the cassette deck stops, but the turntable keeps playing.

Copying (dubbing) a tape

You can automatically copy a tape in tape well A onto a tape in tape well B. You can copy at normal speed or at high speed, which takes half the time.

A few tips:

- You can't adjust recording level and balance during copying. They are set automatically.
- The new recording in tape well B will automatically have the same noise reduction as the original recording in tape well A. This means you can't add Dolby Noise Reduction during dubbing.
- If the original tape is recorded at very high volume levels, use normal-speed copying for best results.
- Noise from a nearby TV may cause interference during high-speed copying. If this happens, turn OFF the TV.

1 Insert the tape to copy into well A, and a blank tape into well B.

2 Make sure that both wells are set in the same direction, and immediately press the STOP button.

3 Select the copying (dubbing) mode:

 copies both sides of the tape.

 copies one side of the tape.

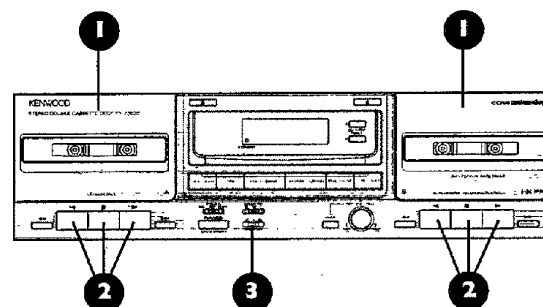

- 4 Press the NORMAL DUBBING button for normal-speed copying or the HIGH DUBBING button for high-speed copying, and the taping starts.

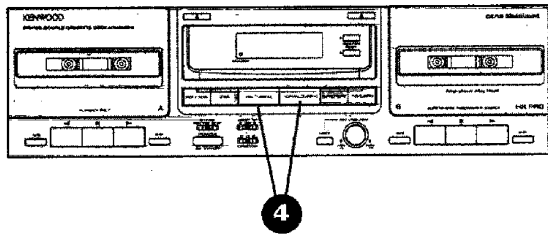

To pause dubbing

If you're in normal copying mode, press the NORMAL DUBBING button.

If you're in high-speed copy mode, press the HIGH DUBBING button.

Well B pauses after putting a 4 to 6-second blank space on the tape.

You can skip unwanted tracks on the tape in tape well A by pressing the ►► button under well A.

To resume dubbing

If you're in normal copying mode, press the NORMAL DUBBING button again.

If you're in high-speed copy mode, press the HIGH DUBBING button again.

To stop dubbing

Press the ■ button of well B.

Troubleshooting

Sometimes things just don't seem to be working right.

When this happens:

- First, look back over this manual to find the instructions for what you're trying to do. You may find the solution to your problem right there.
- If that doesn't work, look for the problem in this Troubleshooting guide.
- If you have a problem with another component, check the manual for that unit.
- If you still can't solve the problem, call the store where you purchased your system, or call a Kenwood Authorized Service Center.

Integrated Amplifier

The remote doesn't work

- Check the batteries, and replace them if needed.
- Check that the remote is close enough to the system; that the controlling angle is small enough; that there's no obstacle in between.
- Check that you've placed your CD, videotape, laser disc, or other source in the proper player.
- If you're recording a tape, wait until the recording is completed.
- Check to make sure that the audio cables and system control cables are connected properly.

No sound from the system

- Check that the volume is set at a proper level.
- Check that the mute is OFF.

- Check that the speakers are turned ON. If the speakers are ON, the SPEAKERS light is ON.
- Check that all your power cords are connected properly.
- Check that the speaker cables are connected properly.
- Check that the input cable from the source component is connected properly.
- Check that the shorting plugs have not been removed from the ADAPTER loop jacks.

No sound from one of the speakers

- Check that the balance between the left and right speakers isn't set too far to one side.
- Check that the audio and speaker cables are connected properly.

No sound from the surround speaker(s) and/or center speaker, or the sound is abnormally low

- Check that one of the surround modes is ON.
- Check that the center speaker isn't set to PHANTOM.
- Check that the speaker cables are connected properly.
- Check that the center speaker input cable is connected properly to the power amplifier center input jack.
- Check that the CENTER and SURROUND speakers are calibrated properly.

Sound only from the center speaker when Dolby Pro Logic is selected

- Check that the program is recorded in stereo (mono programs will only play through the center speaker in

the Dolby Pro. Logic mode).

The STANDBY light blinks, but there is no sound

- Check that the speaker cables aren't short-circuited—that is, the (+) and (-) wires aren't touching each other. If they are, separate the wires.

A hum when you select the PHONO input

- Check that the audio cables are plugged securely into the PHONO jacks.
- Check that the turntable is grounded on the rear panel. The ground wire should be connected to the screw labeled GND.

None of the functions operate, or the display shows wrong information

- Reset your unit's microcomputer by unplugging the power cord from the electrical outlet and plugging it back in while holding down the POWER button.

Tuner

You can't receive radio stations

- Check that the station is tuned in properly.
- Check that the TUNER input is selected.
- Check that the antenna is connected properly.

You can't receive a preset station by pressing the corresponding number buttons

- Check that the TUNER input is selected.
- Check that the preset station is a receivable frequency.
- Check that the preset memory hasn't been cleared because the power cord was unplugged a long time. If so, preset the station again.

Interference with reception

- Check for interference from electrical appliances. If so, turn them OFF.
- Check for interference from the TV set. If so, turn it OFF, or move the antenna away from the TV.

- Check for interference from automobiles. If so, install the outdoor antenna away from roads.

None of the functions operate, or the display shows wrong information

- Reset your unit's microcomputer by unplugging the power cord from the electrical outlet and plugging it back in while holding down the MEMORY button.

CD player

Power light doesn't come on

- Check that the power cord is properly plugged into the electrical outlet on the back of the power amplifier.

Player doesn't play a loaded CD

- Check that the CD is loaded right-side up.
- Check that the CD isn't cracked or dirty.
- There may be condensation on the lens. Leave the player on for at least 1 hour before using it.

No sound

- Check that the CD is loaded properly.
- Check that the CD isn't cracked or dirty.
- Check that the PLAY mode is active (the PLAY/PAUSE light should be ON).
- Check that the audio cables are connected properly.

Skipping (mis-tracking)

- Check that the CD isn't cracked or dirty.
- Make sure that the player isn't subjected to strong vibrations.

CD automatically plays when power is turned on

- Remove all CDs before turning your unit OFF. The player is designed to automatically begin playing when the power is turned ON.

Cassette deck

No sound when the **PLAY** button is pressed

- Check that the tape isn't blank.
- Check that the tape is wound properly in the cassette case. If not, replace the tape.
- Check that the audio cables are connected properly.

None of the operation buttons work

- Make sure that a tape has been inserted into the well.
- Make sure the cassette well door is completely closed.
- After closing the cassette well door or turning on the power, wait at least 3 seconds before pressing the buttons.
- Make sure that the tape isn't fully wound to the end. If it is, change the tape direction or reinsert the tape facing the other direction.
- Check that the tape is wound properly in the cassette case. If not, replace the tape.

Track-finding function doesn't work

- Make sure that the tape has 4-second blank spaces between tracks.

Automatic recording doesn't work

- Make sure that the recording-activation tabs have not been removed from the tape in tape well B.
- Make sure there is a CD in the CD player.
- Check that the CD isn't cracked or dirty.
- Check that the system control cables are properly plugged in.

The cassette well door doesn't open when the **EJECT** button is pressed

- Make sure that the player is in the STOP mode.

Recordings sound dull or distorted

- The recording level may be too high. Set the recording level according to the section 'Setting recording level and balance' on page 40.
- Make sure that Dolby Noise Reduction isn't activated

when playing tapes recorded with no Dolby Noise Reduction.

- You may need to clean the tape heads. See the section 'Before using your cassette deck' on page 36.

Pressing the **REC/ARM** button doesn't start recording

- Make sure that the recording-activation tabs have not been removed from the tape.
- Make sure that the cassette well door is completely closed.
- Make sure that the input on the amplifier is set to something other than TAPE.
- Check that the recording level isn't set to minimum.
- Check that the tape isn't fully wound to the end.

Tape noise (hiss) level is high

- Make sure that the proper Dolby Noise Reduction is selected for play.
- The tape may have been recorded at too low a recording level. If so, record it again at a higher level.
- You may need to demagnetize the tape head. See the section 'Before using your cassette deck' on page 36.

Sound is 'sour', with unstable pitch

- You may need to clean the tape heads. See the section 'Before using your cassette deck' on page 36.
- Make sure that the tape is wound properly in the cassette case.

Tape automatically plays or records when power is turned ON

- Make sure that the TIMER switch is OFF.

None of the functions operate, or the display shows wrong information

- Reset your unit's microcomputer by unplugging the power cord from the electrical outlet and plugging it back in while holding down the STOP button.

Specifications

Integrated amplifier (KA-896)

Power amp section

Power output in stereo operation:
100 watts per channel minimum
RMS, both channels driven, at 8
ohms, from 40 Hz to 20 kHz, with
no more than 0.09% total harmonic
distortion (FTC)

Power output in surround operation:
Left, center and right channels:
70 watts per channel, 1 kHz,
0.9% THD, 8 ohms

Surround channel: 20 watts + 20
watts, 1 kHz, 0.9% THD, 8 ohms

Pre amp section

Frequency response:
Line (CD, Tapé, Video): 20 Hz to
60 kHz, +0 dB, -3 dB
Phono: (RIAA): 20 Hz to 20 kHz
+0.5 dB

Signal-to-noise ratio (IHF '66):
Phono: 75 dB
CD, Tapé, Video: 95 dB

Maximum input level (Phono):
120 mV, 0.5% THD at 1 kHz

Input sensitivity/impedance:
Phono: 3.5 mV/47 k-ohms
CD, Tape, Video: 200 mV/47 k-ohms
Adaptor loop input:
200 mV/47 k-ohms

Output level/impedance:
Tape record: 200 mV/1 k-ohm
Adaptor loop out: 200 mV/1 k-ohm

Tone controls:
Bass: +10 dB at 100 Hz
Treble: +10 dB at 10 kHz
Loudness control (volume at -30 dB):
+8 dB at 100 Hz

General

Power consumption: 2.3 amps

Electrical outlet (2 switched):
400 watts max total

Dimensions:
Width: 17-5/16"
Height: 5-5/8"
Depth: 11-13/16"
Weight (net): 20.5 lbs

Tuner (KT-596)

FM tuner section

Tuning frequency range:
87.5 MHz to 108 MHz

Usable sensitivity (IHF):
13.2 dBf (1.2 mv at 75 ohms)

Total harmonic distortion (1 kHz):
Stereo: 0.7 %
Mono: 0.6 %

Signal-to-noise ratio at 65 dBf (IHF):
Stereo: 68 dB
Mono: 75 dB

Stereo separation at 1 kHz (IHF):
40 dB

Capture ratio: 2.0 dB

Selectivity (IHF +400 kHz): 50 dB

Image rejection ratio (98 MHz):
50 dB

IF rejection ratio (98 MHz): 50 dB

AM suppression ratio: 37 dB

Frequency response:
30 Hz to 15 kHz, ± 0.5 dB, -3.0 dB

Output level/impedance (1 kHz,
75 kHz deviation): 0.6 V/3.3 k-ohm

AM tuner section

Tuning frequency range:
530 to 1700 kHz

Usable sensitivity:
12 mv/(500 mV/m)

Total harmonic distortion: 0.7 %

Signal-to-noise ratio: 48 dB

Selectivity: 30 dB

Image rejection ratio: 30 dB

Output level/impedance (30% modulation, 1 mV input):
0.18 V/3.3 k-ohm

General

Power consumption: 10 watts

Electrical outlet (1 unswitched):
520 watts max.

Dimensions:
Width: 17-5/16"
Height: 2-15/16"
Depth: 9-5/8"
Weight (net): 4.8 lbs

CD player (DP-R896)

Format

System: Compact disc digital audio system

Laser: Semiconductor laser

Channel format: 2 channel

Disc rotation speed:
200 to 500 rpm (CLV)

D/A converters: Dual 1 Bit

Oversampling digital filter:
8 fs (352.8 kHz)

Performance

Frequency response:
4 Hz to 20 kHz, +1.0 dB

Signal-to-noise ratio: >96 dB

Dynamic range: >94 dB

Total harmonic distortion + noise:
<0.007 % (1 kHz)

Channel separation: >90 dB (1 kHz)

Wow and flutter: Unmeasurable

Output level/impedance:
2.0 V/3.3 k-ohms

General

Power consumption: 10 watts

Dimensions:
Width: 17-5/16"
Height: 5-1/16"
Depth: 15-7/16"
Weight (net): 11 lbs

Cassette deck (KX-W896)

Format

Track system: 4 track, 2 channel

Recording system: AC bias (105 kHz)

Heads:

Well A: Playback head x 1

Well B: Record/playback head x 1

Erase head x 1

Performance

Wow and flutter: 0.08 % (WRMS)

Fast-wind time: Approx 96 seconds
(C-60 tape)

Frequency response:

Normal tape:

30 Hz to 17 kHz, +3 dB

High-bias tape:

30 Hz to 18 kHz, +3 dB

Signal-to-noise ratio (3% 3rd
harmonic distortion, high bias tape):

Dolby NR OFF: >58 dB

Dolby B NR ON: >67 dB

Dolby C NR ON: >75 dB

Harmonic distortion (315 Hz,
250 nWb/m, high bias tape): <1%

Input sensitivity/impedance:
122.8 mV/47 k-ohms

Output level/impedance:
775 mV/1.0 k-ohms

General

Power consumption: 20 watts

Dimensions:
Width: 17-5/16"
Height: 5-3/8"
Depth: 10-9/16"
Weight (net): 9.3 lbs

Speakers

Main speakers (JL-996)

Drivers:

Woofer: 12" cone-type

Midrange: 4" cone-type

Tweeter: 2" cone-type

Power handling: 100 watts

General

Dimensions:

Width: 14-3/16"

Height: 37-3/8"

Depth: 10-9/16" (with grille)

Weight (net): 30.9 lbs

Center speaker (CRS-156 Center)

Drivers 2 x 4" full-range cone-type

Power handling: 100 watts

General

Dimensions:

Width: 17-5/16"

Height: 5-7/8"

Depth: 6-5/16"

Weight (net): 7 lbs

Surround speakers (CRS-156 Surround)

Drivers 1 x 4" full range cone-type

Power handling: 40 watts

General

Dimensions:

Width: 5-7/8"

Height: 7-7/8"

Depth: 6-5/16"

Weight (net): 3.1 lb

Because Kenwood follows a policy of continuous product improvement, these specifications may be changed without notice.

KENWOOD USA CORPORATION
PO Box 22745
Long Beach, California 90801-5745



Free Manuals Download Website

<http://myh66.com>

<http://usermanuals.us>

<http://www.somanuals.com>

<http://www.4manuals.cc>

<http://www.manual-lib.com>

<http://www.404manual.com>

<http://www.luxmanual.com>

<http://aubethermostatmanual.com>

Golf course search by state

<http://golfingnear.com>

Email search by domain

<http://emailbydomain.com>

Auto manuals search

<http://auto.somanuals.com>

TV manuals search

<http://tv.somanuals.com>