

KENWOOD

AUDIO VIDEO SURROUND RECEIVER

KRF-V7010

KRF-V6010

KRF-V5010

INSTRUCTION MANUAL

KENWOOD CORPORATION

This instruction manual is for some models.
Model availability and features (functions) may differ depending on the country and sales area.

About the supplied remote control (RC-R0507) . . .

Compared to standard remote controls, the remote control supplied with this receiver has several operation modes. These modes enable the remote control to control other audio/video components. In order to effectively use the remote control it is important to read the operating instructions and obtain a proper understanding of the remote control and how to switch its operation modes (etc.). Using the remote control without completely understanding its design and how to switch the operation modes may result in incorrect operations.

B60-3609-00 00 ©S (MA) (T, E2, Q) ID
99/12 11 10 9 8 7 6 5 4 3 2 1 98/12 11 10 9 8 7 6 5 4 3 2

Getting started

⚠ Caution : Read this page carefully to ensure safe operation.

KRF-V7010/V6010/V5010 (En/T)

2

Before applying the power

Units are designed for operation as follows.

U.K. and Europe **AC 230 V only**
Russia **AC 220 V only**

For the United Kingdom

Factory fitted moulded mains plug

1. The mains plug contains a fuse. For replacement, use only a 13-Amp ASTA-approved (BS1362) fuse.
2. The fuse cover must be refitted when replacing the fuse in the moulded plug.
3. Do not cut off the mains plug from this equipment. If the plug fitted is not suitable for the power points in your home or the cable is too short to reach a power point, then obtain an appropriate safety approved extension lead or adapter, or consult your dealer. If nonetheless the mains plug is cut off, remove the fuse and dispose of the plug immediately, to avoid a possible shock hazard by inadvertent connection to the mains supply.

IMPORTANT

The wires in the mains lead are coloured in accordance with the following code:

Blue : Neutral
Brown : Live

Do not connect those leads to the earth terminal of a three-pin plug.

REQUIREMENT BY NEDERLAND GAZETTE

Batteries are supplied with this product. When they empty, you should not throw away. Instead, hand them in as small chemical waste.

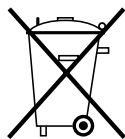

Safety precautions

WARNING :

TO PREVENT FIRE OR ELECTRIC SHOCK, DO NOT EXPOSE THIS APPLIANCE TO RAIN OR MOISTURE.



CAUTION
RISK OF ELECTRIC SHOCK
DO NOT OPEN



CAUTION: TO REDUCE THE RISK OF ELECTRIC SHOCK, DO NOT REMOVE COVER (OR BACK). NO USER-SERVICEABLE PARTS INSIDE, REFER SERVICING TO QUALIFIED SERVICE PERSONNEL.



THE LIGHTNING FLASH WITH ARROWHEAD SYMBOL, WITHIN AN EQUILATERAL TRIANGLE, IS INTENDED TO ALERT THE USER TO THE PRESENCE OF UNINSULATED "DANGEROUS VOLTAGE" WITHIN THE PRODUCT'S ENCLOSURE THAT MAY BE OF SUFFICIENT MAGNITUDE TO CONSTITUTE A RISK OF ELECTRIC SHOCK TO PERSONS.



THE EXCLAMATION POINT WITHIN AN EQUILATERAL TRIANGLE IS INTENDED TO ALERT THE USER TO THE PRESENCE OF IMPORTANT OPERATING AND MAINTENANCE (SERVICING) INSTRUCTIONS IN THE LITERATURE ACCOMPANYING THE APPLIANCE.

Unpacking

Unpack the unit carefully and make sure that all accessories are put aside so they will not be lost.

Examine the unit for any possibility of shipping damage. If your unit is damaged or fails to operate, notify your dealer immediately. If your unit was shipped to you directly, notify the shipping company without delay. Only the consignee (the person or company receiving the unit) can file a claim against the carrier for shipping damage.

We recommend that you retain the original carton and packing materials for use should you transport or ship the unit in the future.

Accessories

FM indoor antenna (1)

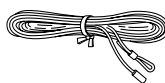

AM loop antenna (1)

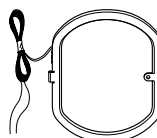

Loop antenna stand (1)

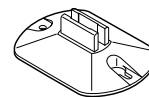

For KRF-V7010

Remote control unit (1)
RC-R0507

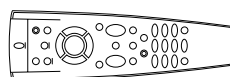

Batteries (R03/AAA) (4)

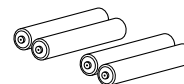

For KRF-V6010, KRF-V5010

Remote control unit (1)
RC-R0307

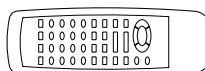

Batteries (R06/AA) (2)





Cleaning

Do not use volatile solvents such as alcohol, paint thinner, gasoline, or benzene, etc. to clean the cabinet. Use a clean dry cloth.

Do not use contact cleaners because it could cause a malfunction. Be specially careful against contact cleaners containing oil, for they may deform the plastic components.

Contents

Caution : Read the pages marked  carefully to ensure safe operation.

Preparations	Getting started	2	Preparations
	 Before applying the power	2	
	 Safety precautions	2	
	Unpacking	2	
	How to use this manual	4	
	Special features	4	
	Names and functions of parts	5	
	Setting up the system	8	
	Connecting audio components	8	
	Connecting video components	9	
	Connecting DVD 6-channel jack	9	
	Connecting the antennas	9	
	Connecting the system control	10	
Connecting the speakers	11		
Preparing the remote control (RC-R0507)	12		
Preparing the remote control (RC-R0307)	13		
Preparing for surround sound	13	Operations	
Speaker settings	13		
<hr/>			
Operations	Normal playback		14
	Preparing for playback		14
	Listening to a source component		15
	Adjusting the sound		15
	Recording		16
	Recording audio		16
	Recording video		16
	Listening to radio broadcasts		17
	Tuning (non-RDS) radio stations		17
	Using RDS (Radio Data System)		17
	Using the DISPLAY key	18	
	Presetting RDS stations (RDS AUTO MEMORY)	18	
	Presetting radio stations manually	19	
	Receiving preset stations	19	
	Receiving preset stations in order (P.CALL)	19	
	Tuning by program type (PTY search)	20	
	Reserving the desired information	20	
	Ambience effects	22	
	Surround modes	22	
	Surround play	23	
DVD 6-channel playback	23		
Convenient functions	24		
<hr/>			
Other	In case of difficulty	25	Other
	 Specifications	27	
<hr/>			
Remote Control (Separate booklet) (RC-R0507)	Quick start guide	1	Remote Control
	Getting the most from your remote control	3	
	Setup code chart	7	
	In case of difficulty	13	
	Remote operation of other components	14	

How to use this manual

The manual covers the KRF-V7010, KRF-V6010, and KRF-V5010. Items such as functions, number of jacks, and remote control details differ somewhat between these models. To confirm the functions available on the model you have purchased, refer to the table below.

Model name	Remote control	Terminal	
		Speaker out	Preout
KRF-V7010	RC-R0507	2 systems (A, B)	CENTER, SURROUND, SUBWOOFER
KRF-V6010	RC-R0307	2 systems (A, B)	CENTER, SURROUND, SUBWOOFER
KRF-V5010	RC-R0307	1 system	SUBWOOFER

This manual is divided into four sections, Preparations, Operations, Other, and Remote Control.

Preparations

Shows you how to connect your audio and video components to the receiver and prepare the surround processor.

We've tried to make setting up your system as easy as possible. However, since this receiver works with all of your audio and video components, connecting the system can be fairly complex.

Operations

Shows you how to operate the various functions available from the receiver.

Other

Shows you additional information such as "In case of difficulty" (trouble-shooting) and "Specifications."

Remote Control (Separate booklet) (RC-R0507 only)

Includes the "Quick Start Guide," which shows you how to operate other components using the remote control, as well as a detailed explanation of all remote control operations. Once you have registered your components with the proper setup codes, you'll be able to operate both this receiver and your other AV components (TV, VCR, LD player, CD player, etc.) using the remote control supplied with this receiver.

Special features

True home theater sound

This receiver incorporates a wide variety of surround modes to bring you maximum enjoyment from your video software. Select a surround mode according to your equipment or the software you are going to play and enjoy! 

Dolby Pro Logic & Dolby 3 Stereo

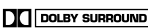
This surround system reproduces theater-like surround sound from video software marked .

The PRO LOGIC mode uses the built-in adaptive matrix circuit to steer the Left, Center, Right and Surround channel audio signals. The 3 STEREO mode will redirect the Surround signal to the front left and right speakers when only the front and center speakers are used.

New DSP surround modes

The DSP (Digital Signal Processor) used for this receiver incorporates a variety of high quality adjustable sound fields, like "LIVE" and "HALL", to add the "presence" associated with an arena, jazz club or stadium (etc.) to the original signal. It is compatible with almost any kind of program source.

DVD 6-channel input

If you own a DVD player equipped with 6-channel output, this receiver allows you to obtain the full surround sound impact of DVD source material featuring multi-channel encoding. Since the source signals are digital and each channel is input independently, the resulting ambience is far superior to what can be achieved with conventional surround sound systems.

Universal IR (InfraRed) remote control (RC-R0507 only)

In addition to the basic receiver, the remote control supplied with this receiver can also operate almost all of your remote controllable audio and video components. Just follow the simple setup procedure to register the components you have connected.

MACRO play (RC-R0507 only)

The MACRO function lets you perform a series of operations automatically, like turning ON the power of the receiver and connected components, switching the input selectors, and starting playback. (Be sure to register your components before starting the macro set up procedure.)

RDS (Radio Data System) tuner

The receiver is equipped with a RDS tuner that provides several convenient tuning functions: RDS Auto Memory, to automatically preset up to 30 RDS stations broadcasting different programs; station name display, to show you the name of the current broadcast station; and PTY search to let you tune stations by program type.

PTY (Program TYPE) search

Lets you tune stations by specifying the type of program you want to hear.

EON (Enhanced Other Networks) reservation

The EON function lets you monitor information on other stations so you can receive traffic or news programs as soon as they are broadcast, even they are broadcast on a station different from the one you are currently listening to. When the broadcast ends, the receiver returns to the original station. When listening to KENWOOD source components connected with system control cords, the input selector on the receiver automatically switches to the tuner when a program you desire is broadcast.

Names and functions of parts

KRF-V7010/V6010/V5010 (En/T)

5

Preparation

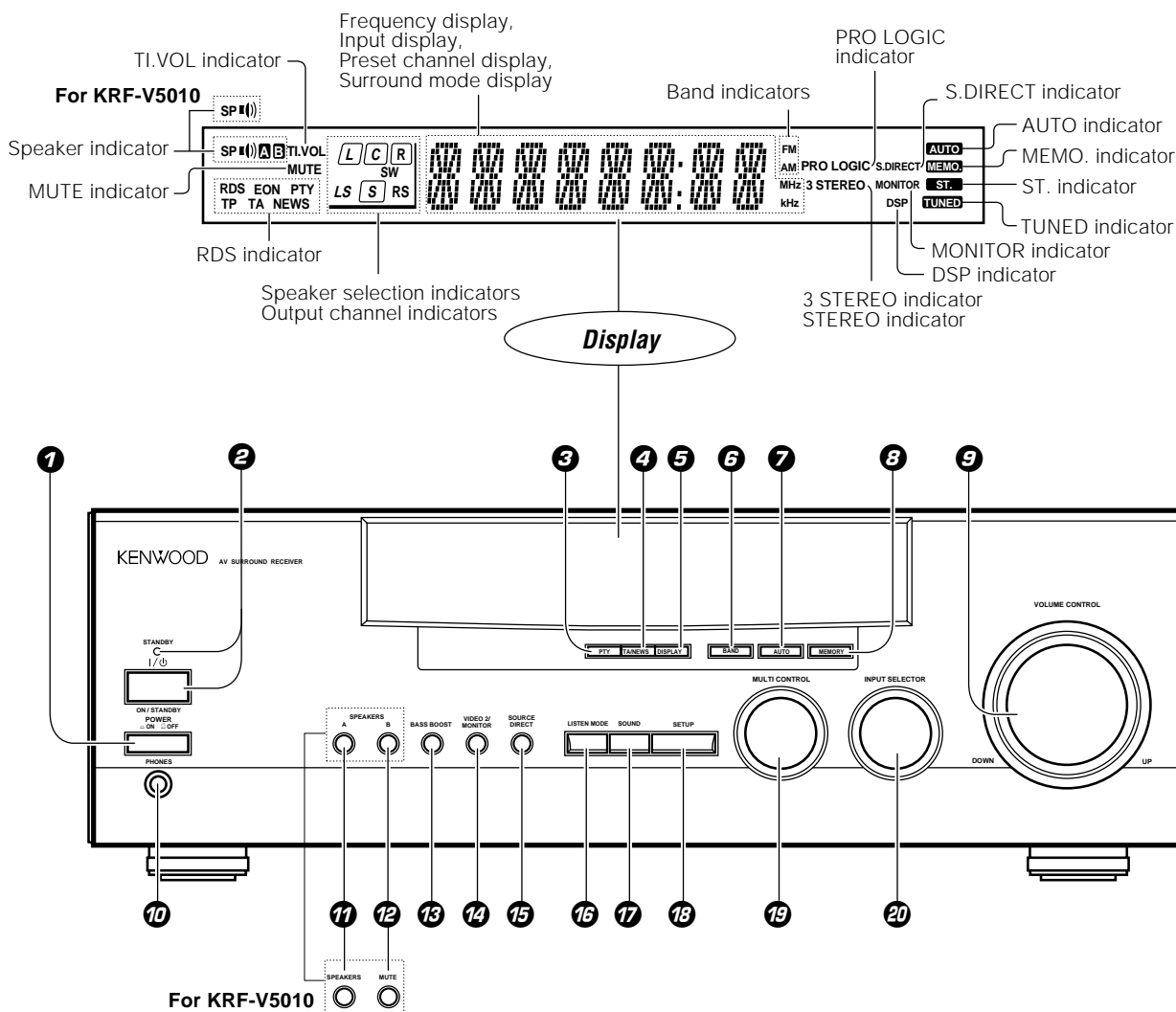

- | | | |
|--|---|---|
| <p>1 POWER key - 14
Use to turn the main power ON/OFF.</p> <p>2 ON/STANDBY (I/O) key - 14
Use to switch the power ON/STANDBY when the POWER is turned ON.
STANDBY indicator</p> <p>3 PTY key
Use to perform PTY search.</p> <p>4 TA/NEWS key - 20</p> <p>5 DISPLAY key - 18
Use to change the display indications when receiving RDS broadcasts.</p> <p>6 BAND key - 17
Use to select the broadcast band.</p> <p>7 AUTO key - 17
Use to select the auto tuning mode.</p> | <p>8 MEMORY key - 18
Use to store radio stations in the preset memory.</p> <p>9 VOLUME CONTROL knob - 15</p> <p>10 PHONES jack - 16
Use for headphone listening.</p> <p>11 SPEAKERS A key - 14
Use to turn speaker system A on and off.</p> <p>SPEAKERS key (KRF-V5010) - 14
Use to turn the speakers on and off.</p> <p>12 SPEAKERS B key - 14
Use to turn speaker system B on and off.</p> <p>MUTE key (KRF-V5010) - 16
Use to temporarily mute the sound.</p> | <p>13 BASS BOOST key - 15
Use to select the maximum adjustment setting for the low frequency range.</p> <p>14 VIDEO 2 / MONITOR key - 8, 16</p> <p>15 SOURCE DIRECT key - 16</p> <p>16 LISTEN MODE key - 23
Use to select the listening mode.</p> <p>17 SOUND key - 24
Use to adjust the sound quality and ambience effects.</p> <p>18 SETUP key - 13
Use to select the surround sound settings.</p> <p>19 MULTI CONTROL knob
Used to make a variety of settings.</p> <p>20 INPUT SELECTOR knob - 15
Use to select the input sources.</p> |
|--|---|---|

About the STANDBY indicator

This unit has a STANDBY indicator. When the STANDBY indicator is lit, the unit consumes a small amount of power to preserve the memory. This is called STANDBY mode. This mode also lets you turn the power ON using the remote control.

Remote control unit (RC-R0507)

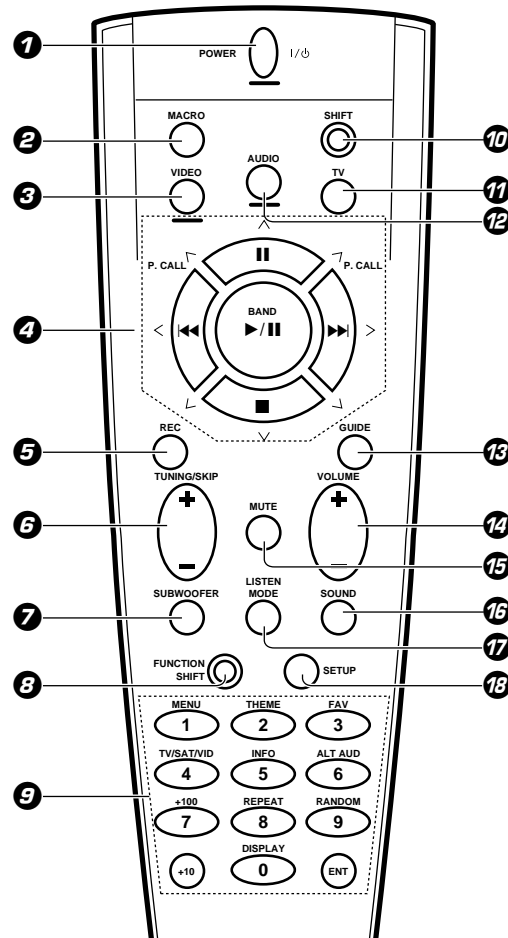

Page references such as “RC→10” indicate pages in the remote control operation manual (Separate booklet).

There are some cases in which keys (or knobs) that have the same function on the receiver and on the remote control have different names. In the instructions of this manual, if the names of corresponding keys (or knobs) on the receiver and remote control are different, the name of the remote control key is indicated in parentheses.

- 1 POWER key** RC→12
Use to turn the receiver on and off.
Use in combination with the input selector (AUDIO, VIDEO, or TV) keys and SHIFT key to turn various components on and off.
- 2 MACRO key** RC→5
Use in combination with the AUDIO, VIDEO, or TV keys to execute a series of commands automatically (MACRO PLAY).
- 3 VIDEO selector key**
Selects the video inputs and sets the remote control to operate the component registered at the respective input.
- 4 Multi control keys** RC→14
Use to operate the selected component.
- 5 REC key** RC→14
Use to operate the selected component.
- 6 TUNING/SKIP key**
Use during the setup procedure to specify various settings. Use to operate the tuner or selected component.
- 7 SUBWOOFER key** RC→24
Use in combination with the VOLUME +/- keys to adjust the volume of the subwoofer.

- 8 FUNCTION SHIFT key** RC→14
Use in combination with the numeric keys to execute alternate commands.
- 9 Numeric keys** RC→14
Provide functions identical to those of the original remote control supplied with the component you are controlling.
To access the functions printed above the keys, press within 3 seconds of pressing the FUNCTION SHIFT key. Function availability varies for each component.
- 10 SHIFT key** RC→5
Use in combination with the AUDIO and VIDEO keys to change the remote control mode without changing the input selector or in combination with the POWER key to turn on and off components programmed into the remote control.
- 11 TV selector key**
Sets the remote control to operate a TV or cable box. This key does not change the input selector on the receiver.

- 12 AUDIO selector key**
Selects the audio inputs and sets the remote control to operate the respective KENWOOD audio component.
If you connect audio components from KENWOOD and other makers to the MD/TAPE or CD jacks, you can set the remote control to operate these components by registering the appropriate setup code at the respective input.
- 13 GUIDE key** RC→15
Use to activate the OSD menu functions of registered components.
- 14 VOLUME key** RC→15
Use to adjust the receiver volume.
- 15 MUTE key** RC→16
Use to temporarily mute the sound.
- 16 SOUND key** RC→24
Use to adjust the sound quality and ambience effects.
- 17 LISTEN MODE key** RC→23
Use to select the listening mode.
- 18 SETUP key** RC→13
Use to select the surround sound settings.

Remote control unit (RC-R0307)

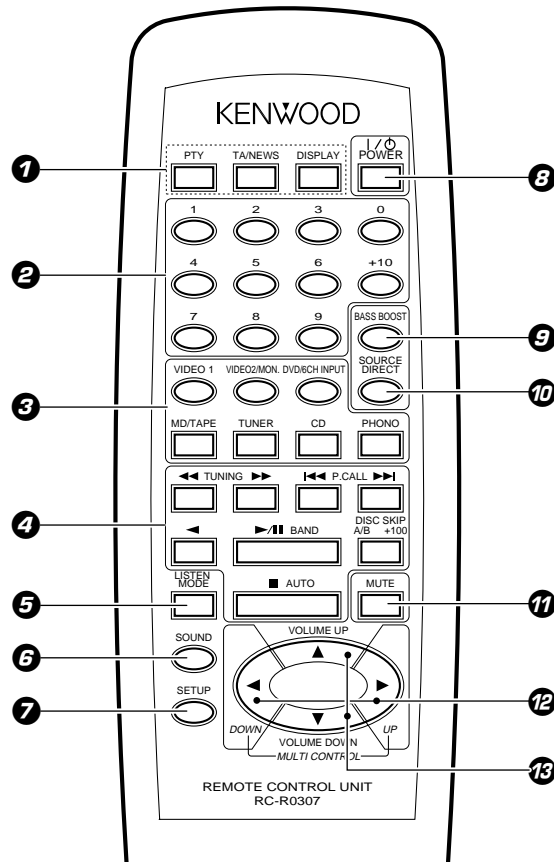

1 RDS operation key

Use to receive RDS broadcasts.

2 Numeric keys

If CD or MD is selected as the input source, these keys function as numeric keys. If tuner is selected as the input source, these keys are used to call up station presets.

3 Input selector keys

→ 16

Use to select the receiver's input source.

4 Component operation keys

Use these keys to operate other components with system control connections to the receiver.

TUNING (◀◀ ▶▶) keys

→ 17

If tuner is selected as the input source, these keys function as tuning keys.

If CD or MD is selected as the input source, these keys function as search keys.

P.CALL (◀◀ ▶▶) keys

→ 19

If tuner is selected as the input source, these keys function as P.CALL keys.

If CD or MD is selected as the input source, these keys function as skip keys.

◀ key

If tape is selected as the input source, this key functions as the play key for side B of the cassette (the side facing away from the front of the deck).

BAND (▶/||) key

→ 17

If tuner is selected as the input source, this key functions as the band selector key.

If CD is selected as the input source, this key functions as the play/pause key.

If MD is selected as the input source, this key functions as the play key.

DISC SKIP, A/B, +100 key

If CD is selected as the input source, this key functions as the multi-CD player disc skip key.

If TAPE is selected as the input source, this key is used to switch between the two decks (A and B) of a double cassette deck.

AUTO key

→ 17

If tuner is selected as the input source, this key functions as the AUTO key.

If CD or MD is selected as the input source, this key functions as the stop key.

5 LISTEN MODE key

→ 23

Use to select the listening mode.

6 SOUND key

→ 24

Use to adjust the sound quality and ambience effects.

7 SETUP key

→ 13

Use to select the surround sound settings.

8 POWER key

→ 13

Use to switch the power ON/STANDBY when the POWER is turned ON.

9 BASS BOOST key

→ 15

Use to select the maximum adjustment setting for the low frequency range.

10 SOURCE DIRECT key

→ 16

11 MUTE key

→ 16

Use to temporarily mute the sound.

12 MULTI CONTROL key

Used to make a variety of settings.

13 VOLUME CONTROL key

Setting up the system

Make connections as shown below. When connecting the related system components, be sure to also refer to the instruction manuals supplied with the components you are connecting. Do not connect the power cord to a wall outlet until all connections are completed.

Microcomputer malfunction

If operation is not possible or an erroneous display appears, even though all connections have been made properly, reset the microcomputer referring to "In case of difficulty".

Caution regarding placement

To maintain proper ventilation, be sure to leave a space around the unit (from the largest outer dimensions, including projections) equal to, or greater than shown below:

Left and right panels: 10 cm, Rear panel: 10 cm, Top panel: 50 cm

VIDEO 2/MONITOR jacks

The receiver's VIDEO 2/MONITOR jacks can be used in two different ways. Make the appropriate setting for the component connected to the jack when the receiver is turned on.

Use as a VIDEO 2 jack

You can connect a video deck or the like to these jacks and perform video playback and recording. The initial factory setting is "VIDEO 2".

Use as a MONITOR jack

You can connect a cassette deck or the like to these jacks and make use of the deck's monitoring function during recording. Alternately, you can connect a graphic equalizer to these jacks to apply compensation to the music signal.

To use the VIDEO 2/MONITOR jacks as MONITOR jacks, hold down the VIDEO 2/MONITOR key of the main unit for more two seconds so that the indication shown below appears.

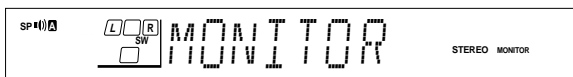
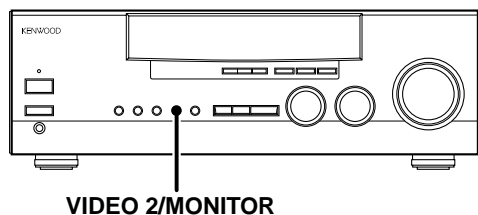

- At the same time the setting is switched to "MONITOR," the audio input source switches to tuner and the video input source switches to VIDEO 1.
- To switch the setting back to "VIDEO 2," once again hold down the VIDEO 2/MONITOR key for two seconds or more.
- If you decide to use the VIDEO 2/MONITOR jacks as MONITOR jacks, make sure to delete the "VIDEO 2 (VCR2)" input from the preset remote control (RC-R0507).

RC-6

Connecting audio components

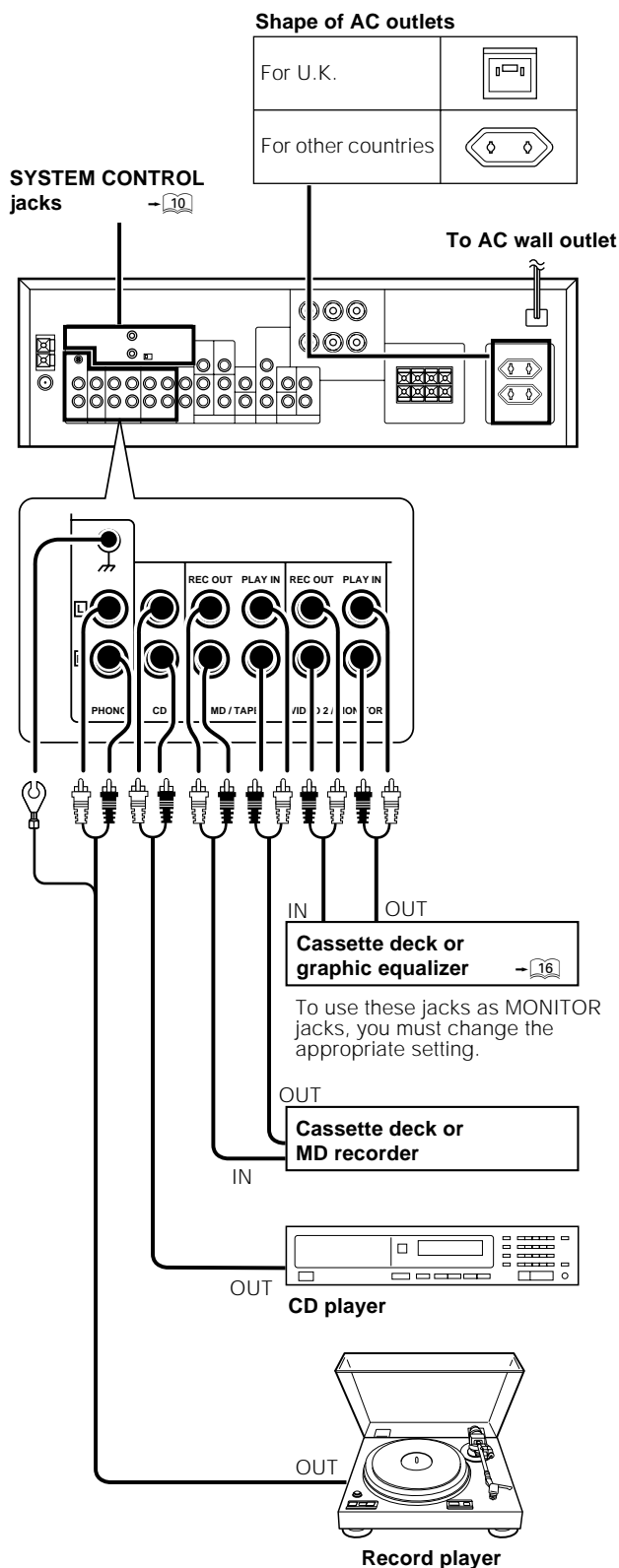

To use the receiver for video recording, connect a video deck to the VIDEO 2/MONITOR jacks.

Notes

- Connect all cords firmly. Loose connections may prevent proper sound transmission or produce noise.
- Be sure to remove the power cord from the AC outlet before plugging or unplugging any connection cords. Plugging / unplugging connection cords without disconnecting the power cord can cause malfunctions and may damage the unit.
- Do not connect power cords from components whose power consumption is larger than what is indicated on the AC outlet at the rear of this unit.

Connecting video components

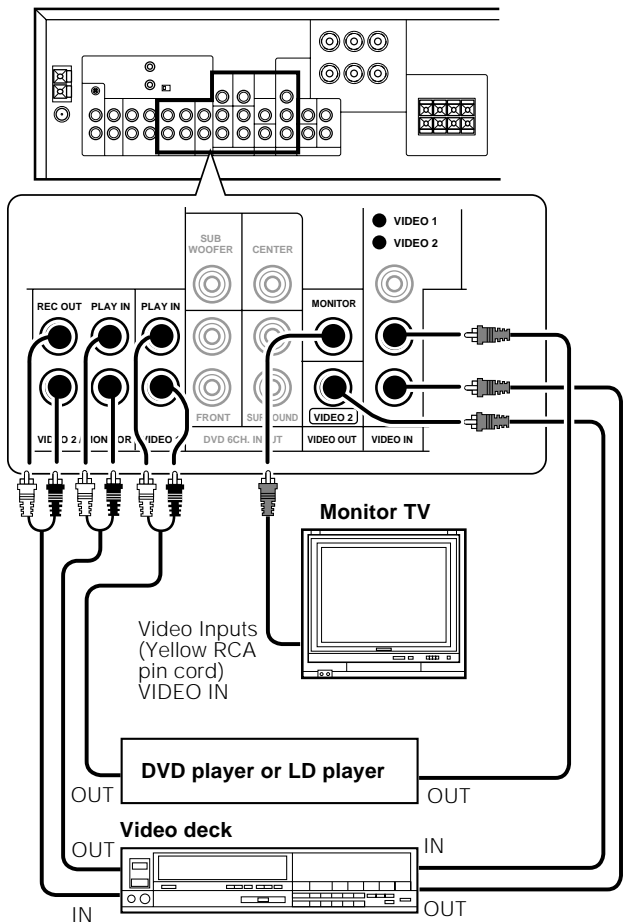

Audio inputs and outputs
(Red and white RCA pin cords)

Video inputs and outputs
(Yellow RCA pin cords)

Connecting DVD 6-channel jack

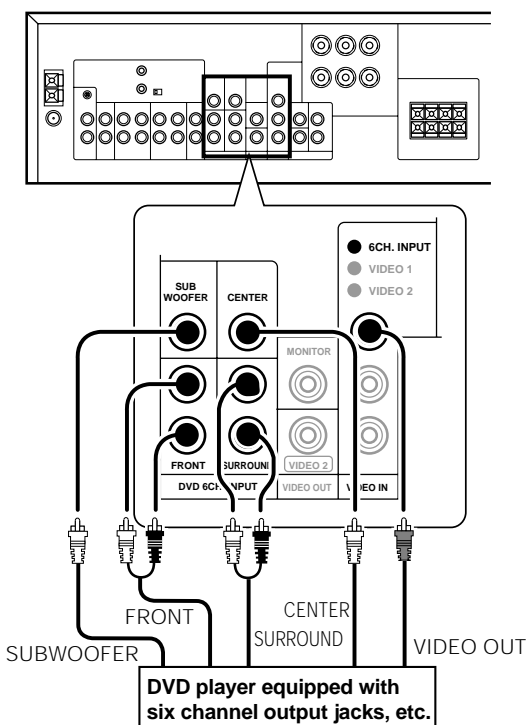

DVD player equipped with
six channel output jacks, etc.

Connecting the antennas

Antenna terminal connections

- 1 Push lever.
- 2 Insert cord.
- 3 Return lever.

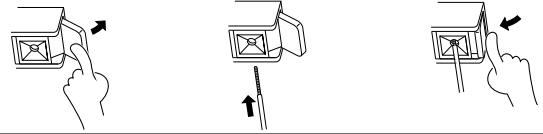

AM loop antenna

The supplied loop antenna is for use indoors. Place it as far as possible from the receiver, TV set, speaker cords and power cord, and adjust the direction for best reception.

FM indoor antenna

The supplied indoor antenna is for temporary use only. For stable signal reception we recommend using an outdoor antenna. Disconnect the indoor antenna when you connect one outdoors.

FM outdoor antenna

Lead the 75Ω coaxial cable connected to the FM outdoor antenna into the room and connect it to the FM 75Ω terminal.

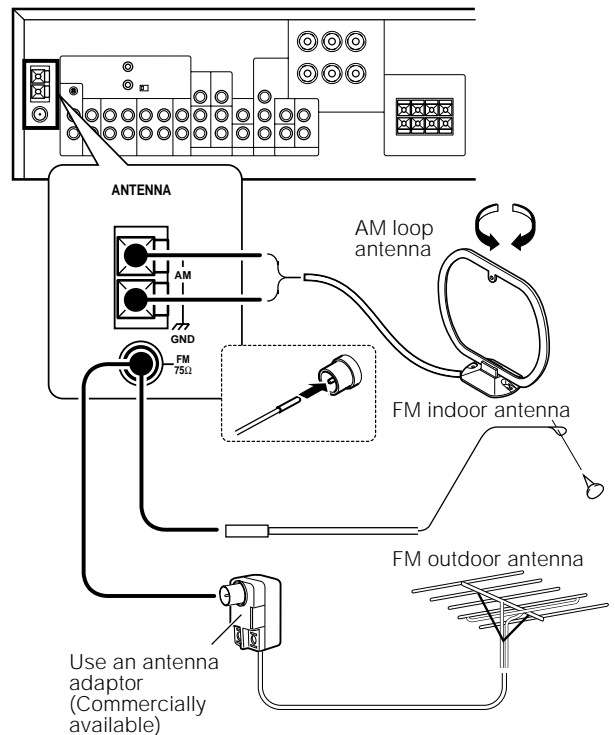

Use an antenna
adaptor
(Commercially
available)

Connecting the system control

Connecting system control cords after connecting a KENWOOD audio component system lets you take advantage of convenient system control operations.

There are two KENWOOD system control modes. Make connections according to the groups of terminal symbols shown below.

- [XS8] Mode : lets you combine [XS], [XS8], and [XR] terminals
- [SL16] Mode : for [SL16] terminals only

This unit is compatible with both [XS8] and [SL16] modes. It comes from the factory set to the [SL16] mode. To switch to the [XS8] mode, follow the instructions in "SWITCHING FROM [SL16] TO [XS8]" below.

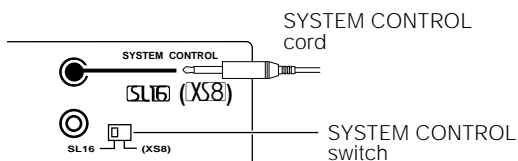

EXAMPLE: [XS8] mode connections

The underlined portion represents the setting of the system control mode.

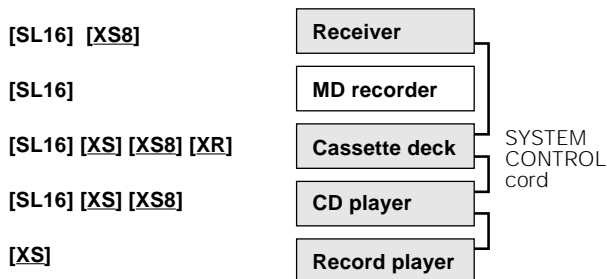

EXAMPLE: [SL16] mode connections

The underlined portion represents the setting of the system control mode.

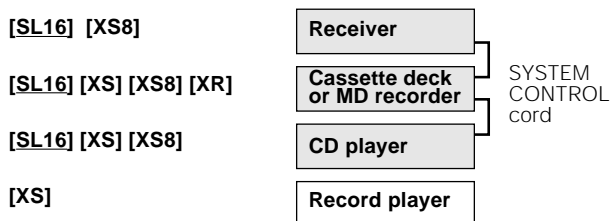

- In order to take advantage of the system control operations, the components must be connected to the correct jacks. To use a CD player it must be connected to the CD jacks. To use a cassette deck (or MD recorder) it must be connected to the MD/TAPE jacks. When using more than one CD player (etc.) only the one connected to the specified jacks may be connected for system control.
- Some CD players and cassette decks are not compatible with the [SL16] system control mode. Be sure to use the [XS8] system control mode when making system connections with equipment that is not [SL16] compatible.
- Some MD players are not system control compatible. You cannot make system control connections to this kind of equipment.

Notes

1. [SL16] equipment cannot be combined with [XR], [XS], and [XS8] equipment for system operations. If your equipment consists of this kind of combination, please do not connect any system control cords. Even without system control cords, normal operations can be carried out without effecting performance.
2. Do not connect system control cords to any components other than those specified by KENWOOD. It may cause a malfunction and damage your equipment.
3. Be sure the system control plugs are inserted all the way in to the system control terminals.

Do not connect a system control cord to a cassette deck connected to the MONITOR jacks.

SYSTEM CONTROL OPERATIONS

Remote Control

Lets you operate this unit with the system remote supplied with the receiver.

Automatic Operation (except [XR] equipment)

When you start playback from a source component, the input selector on this unit switches to that component automatically.

Synchronized Recording (except [XR] equipment)

Lets you synchronize recording with the start of playback when recording from CD, MD or analog discs.

SWITCHING FROM [SL16] TO [XS8]

You can easily change the system control mode by adjusting the position of the SYSTEM CONTROL switch on the rear panel. Do this operation after completing all connections.

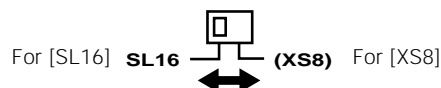

- This operation will not effect items stored in the memory.
- After switching the system control mode, turn the power off and unplug the power cord from the wall outlet, then plug it back.

Registering setup codes for KENWOOD audio components (RC-R0507 only)

- Once you finish making the system connections, be sure to register the appropriate setup code for each component. **RC-3**
- If you own remote controllable KENWOOD audio components that are not compatible with system control (or cannot be combined with your other system control components), registering the setup code enables you to control those components using the remote control supplied with this unit (without connecting system control cords). To register setup codes for your remote controllable KENWOOD audio components, see "Registering setup codes for other components". **RC-3**

Connecting the speakers

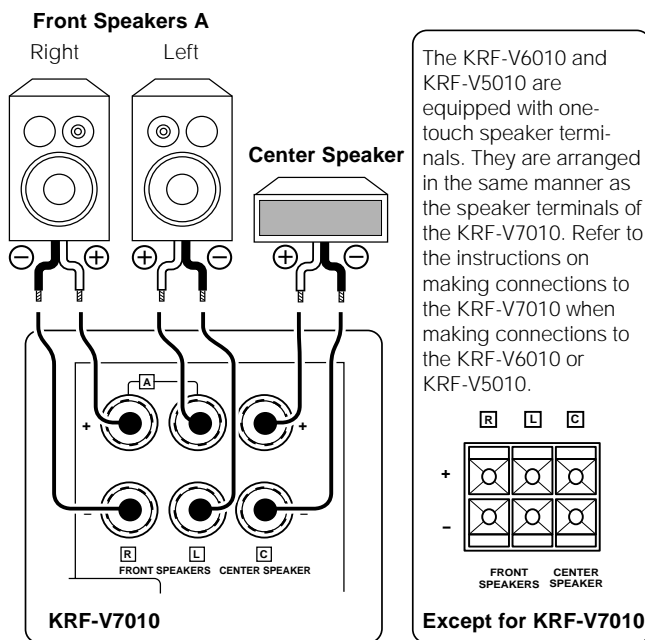
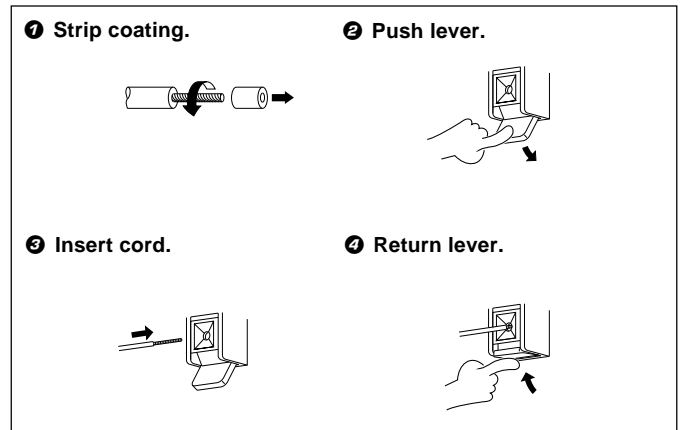
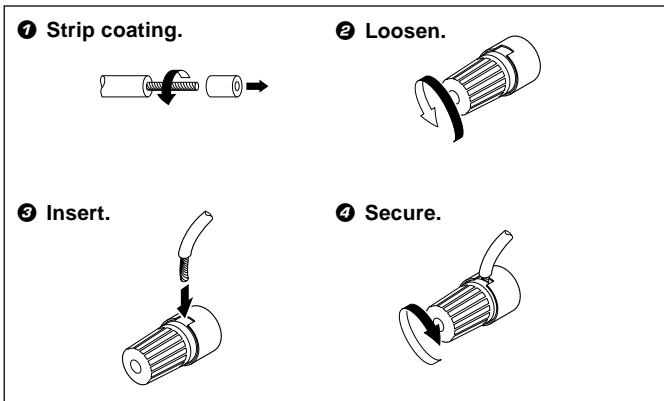

- Never short circuit the + and – speaker cords.
- If the left and right speakers are connected inversely or the speaker cords are connected with reversed polarity, the sound will be unnatural with ambiguous acoustic imaging. Be sure to connect the speakers correctly.

Speaker impedance

After confirming the speaker impedance indications printed on the rear panel of the receiver, connect speakers with matching impedance ratings. Using speakers with a rated impedance other than that indicated on the rear panel of the receiver could result in malfunctions or damage to the speakers or receiver.

PRE OUT connections

This receiver has additional preout jacks. These can be used for various purposes, but will need to be connected to an external power amplifier as shown in the example below.

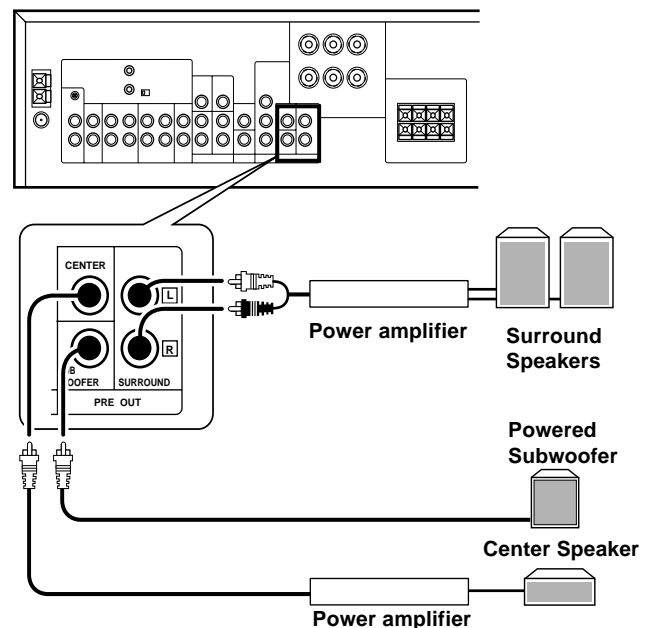
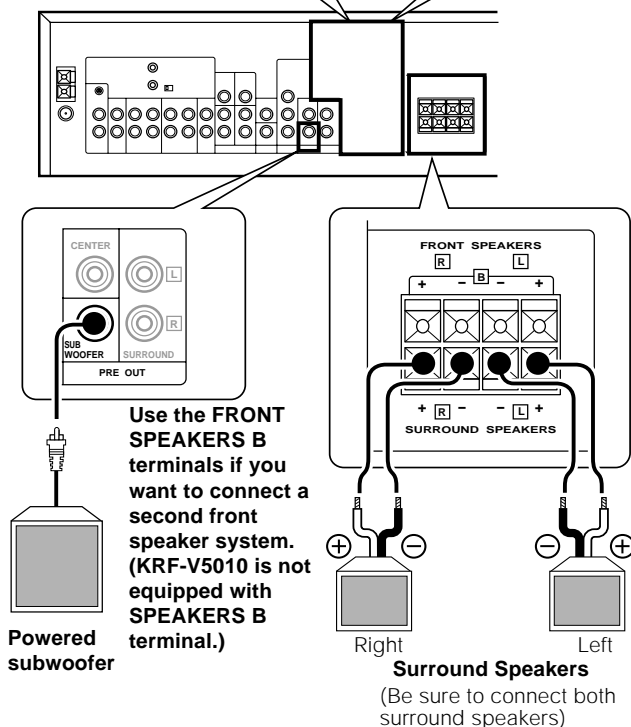

- The KRF-V5010 is equipped with a SUBWOOFER terminal only.
- Connecting a speaker cord directly to a PRE OUT jack will not produce any sound from the speaker.
- To use the PRE OUT jacks, press the **SPEAKERS A** key to the on position (the **SPEAKERS** key in the case of the KRF-V5010).

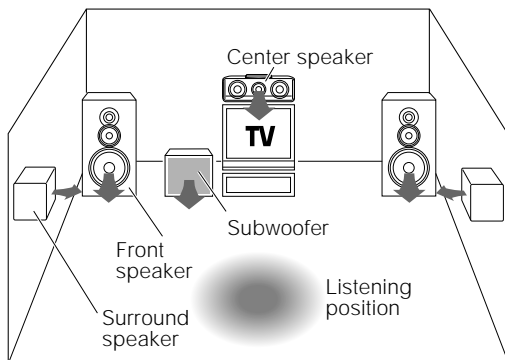
Speaker placement

Front speakers : Place to the front left and right of the listening position. Front speakers are required for all surround modes.

Center speaker : Place front and center. This speaker stabilizes the sound image and helps recreate sound motion. Be sure to connect a center speaker when using the Dolby 3 Stereo mode.

Surround speakers : Place to the direct left and right, or slightly behind, the listening position at even heights, approximately 1 meter above the ears of the listeners. These speakers recreate sound motion and atmosphere. Required for surround playback.

Subwoofer : Reproduces powerful deep bass sounds.

- Although the ideal surround system consists of all the speakers listed above, if you don't have a center speaker or a subwoofer, you can divide those signals between the available speakers in the speaker settings to obtain the best possible surround reproduction from the speakers you have available. 

Preparing the remote control (RC-R0507)**Loading the batteries**

❶ Remove the cover.

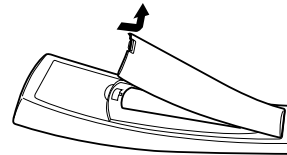

❷ Insert the batteries.

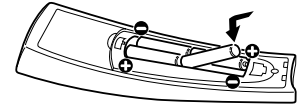

❸ Close the cover.

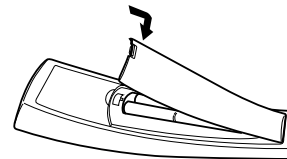

- Insert four AAA-size (LR03) batteries as indicated by the polarity markings.

Operation

When the STANDBY indicator is lit, the power turns ON when you press the POWER key on the remote control. When the power comes ON, press the key you want to operate.

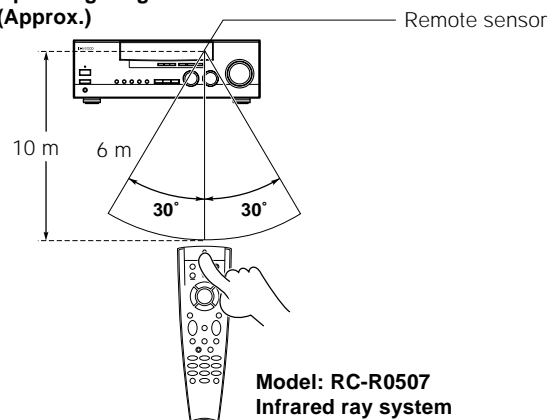
Operating range (Approx.)

- When pressing more than one remote control key successively, press the keys securely by leaving an interval of 1 second or more between keys.

Notes

1. The supplied batteries may have shorter lives than ordinary batteries due to use during operation checks.
2. Replace all four batteries with new ones when you notice a shortening of the distance from which the remote control will operate or if the remote control blinks 5 times when you press a key. The remote control is designed to retain set up codes in memory while you change batteries.
3. Placing the remote sensor in direct sunlight, or in direct light from a high frequency fluorescent lamp may cause a malfunction. In such a case, change the location of the system installation to prevent malfunction.

Preparing the remote control (RC-R0307)

Loading the batteries

1 Remove the cover.

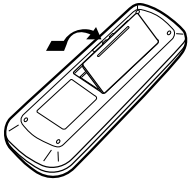

2 Insert the batteries.

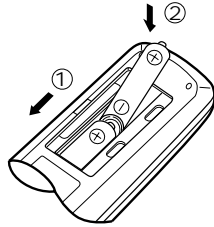

3 Close the cover.

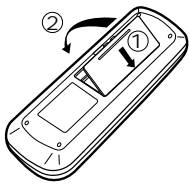

• Insert two AA-size (R6) batteries as indicated by the polarity markings.

Operation

When the STANDBY indicator is lit, the power turns ON when you press the POWER key on the remote control. When the power comes ON, press the key you want to operate.

Operating range (Approx.)

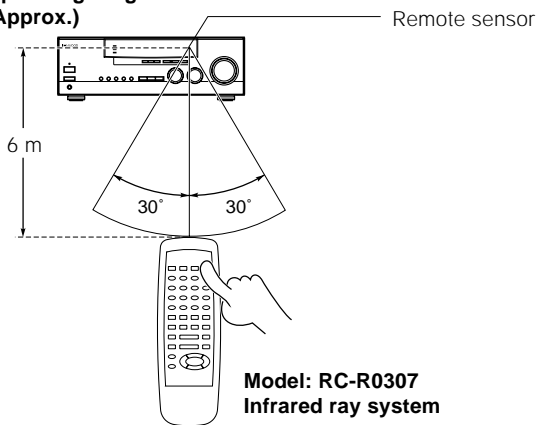

• When pressing more than one remote control key successively, press the keys securely by leaving an interval of 1 second or more between keys.

Speaker settings

To enable you to obtain optimum enjoyment from the receiver's listening modes, make sure to complete the speaker settings as described below.

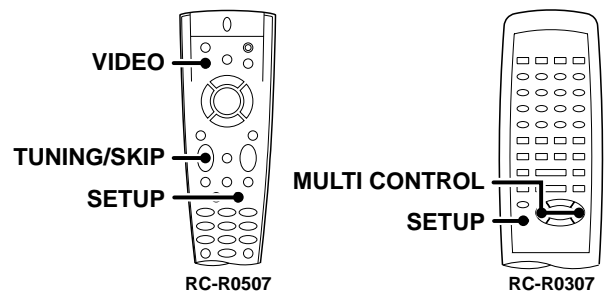
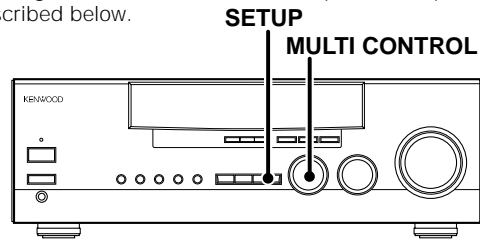

1 Turn on the receiver.



2 Select a speaker system.

1 Press the SETUP key to make the subwoofer setting indication (SUBW) appear.

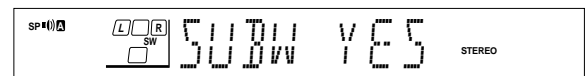

2 Use the MULTI CONTROL (TUNING/SKIP) to select the appropriate subwoofer setting.

- 1 SUBW YES: A subwoofer is connected to the receiver.
- 2 SUBW NO: No subwoofer is connected to the receiver.

3 Press the SETUP key to accept the setting.

• The center speaker setting indication (CNTR) appears.

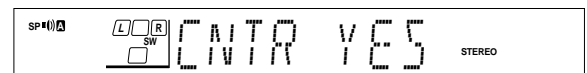

4 Use the MULTI CONTROL (TUNING/SKIP) to select the appropriate center speaker setting.

- 1 CNTR NML (normal): An average size center speaker is connected to the receiver.
- 2 CNTR LRG (large): A large center speaker is connected to the receiver.
- 3 CNTR NO: No center speaker is connected to the receiver.

5 Press the SETUP key to accept the setting.

• The surround speaker setting indication (SURR) appears.

6 Use the MULTI CONTROL (TUNING/SKIP) to select the appropriate surround speaker setting.

- 1 SURR YES: Surround speakers are connected to the receiver.
- 2 SURR NO: No surround speakers are connected to the receiver.

7 Press the SETUP key to accept the setting.

• The receiver enters the speaker volume level adjustment mode.
• In steps 3 and 4, indications appear only for the selected channels of the speakers that require adjusting.

Continued to next page

Notes

1. The supplied batteries may have shorter lives than ordinary batteries due to use during operation checks.
2. When the remote-controllable distance gets shorter than before, replace both batteries with new ones.
3. Placing the remote sensor in direct sunlight, or in direct light from a high frequency fluorescent lamp may cause a malfunction. In such a case, change the location of the system installation to prevent malfunction.

3 Adjust the volume levels for the speakers.

Sit in your normal listening position and listen to the test tone. Adjust the volume levels for the speakers until all speakers seem to be equally loud.

- 1 Use the **MULTI CONTROL (TUNING/SKIP)** to adjust the volume when the test tone is being output from the speaker channel to be adjusted.

The channel indication blinks while the test tone is being output.



The test tone issues from the speakers for 1.5 seconds at a time in the following sequence:

Lch → Cch → Rch → Sch → Lch

- If you change the volume level settings for the speakers while listening to music, the settings referred to on this page are also changed. -24
- If the speaker setting selects are changed, the speaker level settings are reset.

- 2 Press the **SETUP** key.

- The receiver enters the mode for inputting the distance to the speakers.

4 Input the distance to the speakers.

- 1 Measure the distance from the listening position to each of the speakers.

Not down the distance to each of the speakers.

Distance to front speakers: _____ feet (meters)
 Distance to surround speakers: _____ feet (meters)

- 2 Use the **MULTI CONTROL (TUNING/SKIP)** to select the distance to the front speakers.

The speaker indicator to be adjusted blinks.

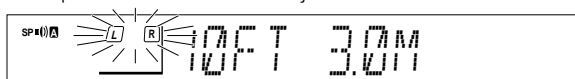

Indication in feet Indication in meters

- The allowable setting range is 1 to 30 feet (0.3 to 9.0 m), adjustable in 1 foot (0.3 m) increments.

- 3 Press the **SETUP** key.

- 4 Repeat steps 2 and 3 to input the distance for the surround speaker.

- 5 Setup is complete when the input indication reappears.

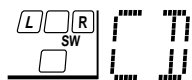

Display when all speakers have been selected.

- The speakers you selected appear on the display. Confirm that all the speakers have been correctly selected.
- If you used the remote control (RC-R0507) to perform the settings, press the **VIDEO** key at this point to turn off the remote control's own adjustment mode. In this case, the input source is not switched.

Preparing for playback

Some preparatory steps are needed before starting playback.

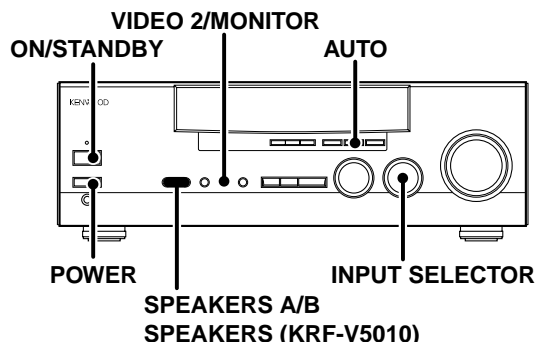

Turning on the receiver

- 1 Turn on the power to the related components.
- 2 Turn on the power to this receiver by pressing **POWER** and **ON/STANDBY** keys.

Selecting TAPE/MD

Select the source name corresponding to the component connected to the MD/TAPE jacks. The initial factory setting is "TAPE". To change the source name associated with the MD/TAPE jacks to "MD," follow the steps below:

- 1 Use the **INPUT SELECTOR** knob to select "TAPE".
- 2 Hold down the **AUTO** key for more than two seconds.
 - The source indication changes to "MD".
 - To return to the original indication, repeat the above procedure.
 - You also will need to change the name input to the remote control (RC-0507) to "MD". RC-3

Selecting the speaker system

Press the **SPEAKERS A** or **B** key to select the speaker system to be used.

- A ON** : Sound from the speakers connected to the **SPEAKERS A** terminals on the rear panel.
- B ON** : Sound from the speakers connected to the **SPEAKERS B** terminals on the rear panel.
- A+B ON** : Sound from both the speakers connected to the **SPEAKERS A** and **B** terminals on the rear panel.
- A+B OFF** : No sound from the speakers. Use this setting when listening with headphones for stereo sound in all playback modes.

- Activating a surround mode or selecting "DVD 6ch" as the input source causes speaker system A to be selected automatically.

On the **KRF-V5010**, press the **SPEAKERS** key to switch the speakers on and off.

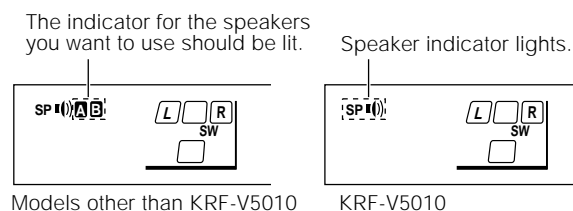

Selecting VIDEO 2/MONITOR

Depending on the component connected to the **VIDEO 2/MONITOR** jacks, select either the "VIDEO 2" setting or the "MONITOR" setting, as appropriate. -8

Listening to a source component

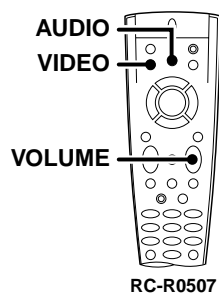
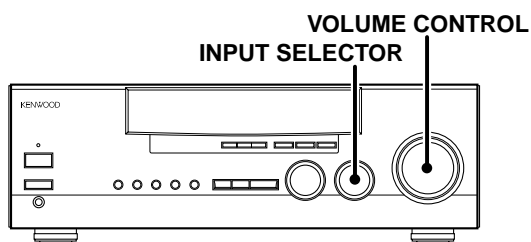

RC-R0507

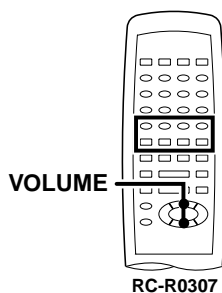

RC-R0307

- 1 Use the input selector (**INPUT SELECTOR (AUDIO, VIDEO)**) to select the source you want to listen to.

The input sources change as shown below:

Selecting a source using the **INPUT SELECTOR** knob

- 1 TUNER
- 2 "CD" ("CD"*)
- 3 "TAPE" or "MD" ("TAPE"*)
- 4 "PHONO" ("PHONO"*)
- 5 "VIDEO1" ("VCR1"*)
- 6 "VIDEO2" ("VCR2"*)
- 7 "DVD 6ch"

Selecting a source using the **AUDIO** key on the remote control (RC-R0507)

- 1 "CD" ("CD"*)
- 2 "TAPE" or "MD" ("TAPE"*)
- 3 TUNER
- 4 "PHONO" ("PHONO"*)

Selecting a source using the **VIDEO** key on the remote control (RC-R0507)

- 1 "VIDEO1" ("VCR1"*)
- 2 "VIDEO2" ("VCR2"*)
- 3 "DVD 6ch"
- 4 "<--->" (Not used by this receiver.)

- When selecting an input source by using the remote control (RC-R0307), press the desired input selector key.
- "VIDEO 2" can be selected as an input source only if the VIDEO 2/MONITOR setting is "VIDEO 2". 

* Once setup codes are registered in the remote control (RC-R0507), the input name display changes according to the name of the registered component.

Example: if you register a VCR at the VIDEO 1 jacks, "VCR" appears instead of "VIDEO 1". **RC-**  2

- When using the remote control (RC-R0507) after initial setup, any inputs that have not been registered with a setup code are deleted from the cyclic list. **RC-**  4

- The **INPUT SELECTOR** on the front panel of the receiver always cycles through all inputs.

- 2 Start playback from the selected source.

- 3 Use the **VOLUME CONTROL (VOLUME)** to adjust the volume.

Adjusting the sound

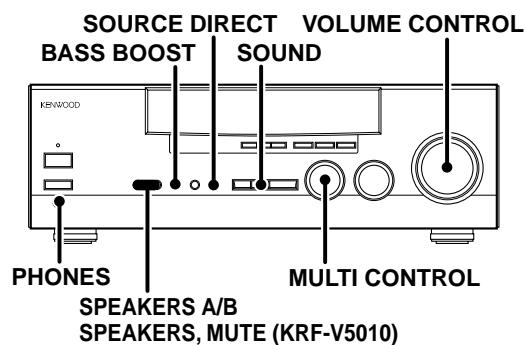
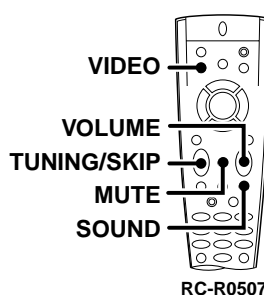
SPEAKERS A/B
SPEAKERS, MUTE (KRF-V5010)

RC-R0507

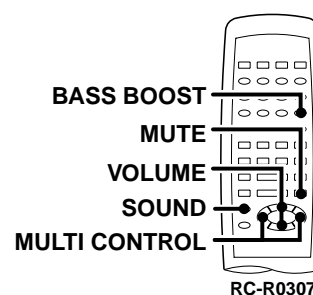

RC-R0307

Adjusting the tone

The following adjustments are possible if the receiver is in the stereo mode.

- 1 Press the **SOUND** key to select the tone mode to be adjusted.

BASS: Select this to adjust the low frequency range.
(Press the **SOUND** key once.)

TREB: Select this to adjust the high frequency range.
(Press the **SOUND** key twice.)

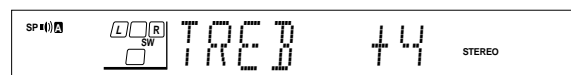

- 2 Use the **MULTI CONTROL (TUNING/SKIP)** to adjust the sound quality.

- The bass and treble levels are adjustable from -10 to +10 in 2 step increments.
- The adjustment item is displayed for approximately eight seconds.
- If you used the remote control (RC-R0507) to perform the above setting, press the **VIDEO** key at this point to turn off the remote control's own adjustment mode. In this case, the input source is not switched.

Once-touch low frequency emphasis (bass boost)

The following adjustments are possible if the receiver is in the stereo mode.

Press the **BASS BOOST** key.

- Press the key once to select the maximum (+10) low frequency emphasis setting.
- This key does not function when the receiver is in the sound quality or ambience effects mode.

Switching back to the previous setting

Press the **BASS BOOST** key again.

Muting the sound

MUTE lets you mute the sound of the speakers.

Press the MUTE key.

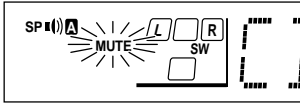

Blinks

- On the KRF-V5010, this selection can be made using the control on the receiver as well.

To cancel

Press the MUTE key again so that the "MUTE" indicator goes off.

- Muting can also be cancelled by adjusting the volume.

SOURCE DIRECT playback (analog sources only)

Use this function to pass the source material direct to the amplifier, bypassing any audio processing.

Press the SOURCE DIRECT key.

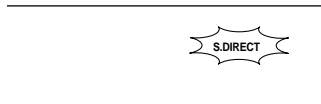

- Either press the LISTEN MODE, SOUND, and SETUP keys, or switch to another input source to cancel SOURCE DIRECT playback.

To cancel

Press again.

- If SOURCE DIRECT playback was activated when using a surround mode, cancelling it reactivates the previous surround mode.

Listening with headphones

- 1 Use the SPEAKERS A or B key (or the SPEAKERS key) to turn off the speaker indicator.

Make sure the SPEAKERS indicators are turned off.

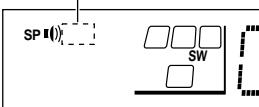

Models other than KRF-V5010

Make sure the SPEAKERS indicators are turned off.

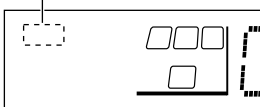

KRF-V5010

- If you turn off all of the speakers when in the surround mode, the mode is cancelled as well, resulting in stereo playback.

- 2 Connect headphones to the PHONES jack.

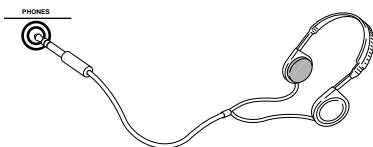

- 3 Use the VOLUME CONTROL knob (VOLUME) to adjust the volume.

To adjust the balance

Use the test tone feature.

Recording audio

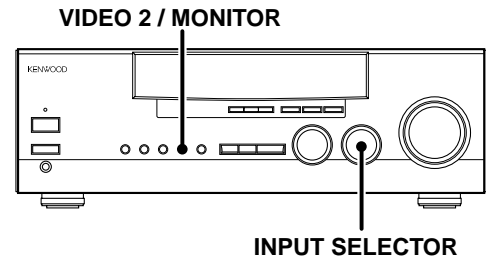

Recording a music source

When recording a music source, switch the VIDEO2/MONITOR setting to "MONITOR".

- 1 Use the input selector to select the source (other than "TAPE") you want to record.
- 2 Set the cassette deck to record.
- 3 Start playback, then start recording.

Copying tapes

When copying tapes, switch the VIDEO2/MONITOR setting to "MONITOR".

MONITOR → TAPE copying

- 1 Press the VIDEO 2/MONITOR key.



- 2 Use the input selector to select a source other than "TAPE".
- 3 Start playback on the cassette deck connected to the VIDEO2/MONITOR jacks and start recording on the cassette deck connected to the MD/TAPE jacks.

TAPE → MONITOR copying

- 1 Use the input selector to select "TAPE".
- 2 Start playback on the cassette deck connected to the MD/TAPE jacks and start recording on the cassette deck connected to the VIDEO2/MONITOR jacks.

- To copy tapes using a double cassette deck, refer to the instruction manual of the double cassette deck.

MONITOR function (analog sources only)

You can connect a cassette deck or graphic equalizer to the VIDEO2/MONITOR jacks of the receiver. If a graphic equalizer is connected, the VIDEO2/MONITOR key should be left in the on position. Alternately, if a cassette deck equipped with a 3-head system is connected to the VIDEO2/MONITOR jacks, you will be able to monitor the just-recorded signal while making recordings on the cassette deck. By switching the VIDEO2/MONITOR key on and off, you can compare the sound of the source signal and the just-recorded signal. For more information, refer to the instruction manual of the connected component.

To adjust the input level when the monitor function is turned on, use the SOUND key and the MULTI CONTROL key.

Recording video

When recording video, switch the VIDEO2/MONITOR setting to "VIDEO2".

- 1 Use the input selector to select the video source (other than "VIDEO2") you want to record.
- 2 Set the video deck connected to VIDEO2/MONITOR to record.
- 3 Start playback, then start recording.

Tuning (non-RDS) radio stations

Radio stations can be classified into RDS (Radio Data System) stations and other stations. To listen to or store RDS stations in the preset memory, see the section entitled, "Using RDS".

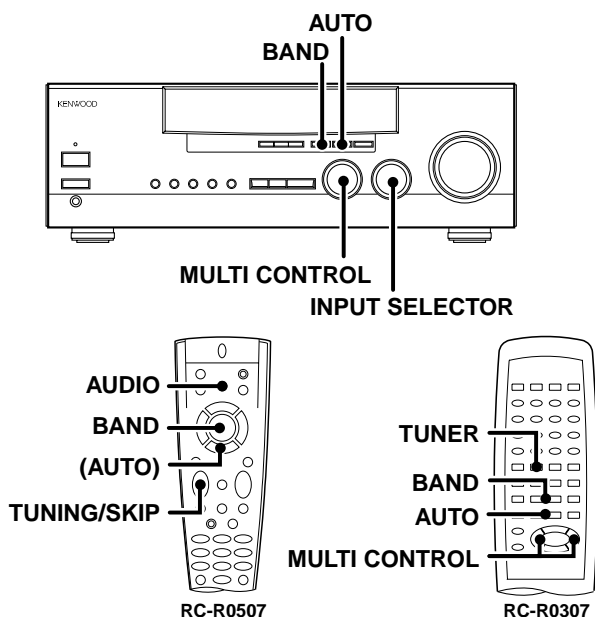

1 Use the input selector to select the tuner.

2 Use the BAND key to select the desired broadcast band.

Each press switches the band as follows:

- ① FM
- ② AM

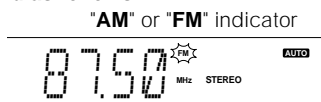

3 Use the AUTO key to select the desired tuning method.

Each press switches the tuning method as follows:

- ① AUTO lit (auto tuning)
- ② AUTO not lit (manual tuning)



- Normally, set to "AUTO" (auto tuning). If the radio waves are weak and there is a lot of interference, switch to manual tuning. (With manual tuning, stereo broadcasts will be received in monaural.)

4 Use the MULTI CONTROL (TUNING/SKIP) to select the station.

"TUNED" is displayed when a station is received

Lights when a broadcast is being received in stereo.

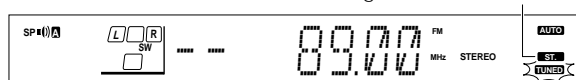

Frequency display

- Auto tuning** : The next station is tuned automatically.
- Manual tuning** : Turn the knob (press the key) to select the desired station.

- You can also use the **TUNING** key on the remote control (RC-R0307) to make the selection.

Using RDS (Radio Data System)

RDS is a system that transmits useful information (in the form of digital data) for FM broadcasts along with the broadcast signal. Tuners and receivers designed for RDS reception can extract the information from the broadcast signal for use with various functions, such as automatic display of the station name.

RDS functions:

PTY (Program Type Identification) Search

Automatically tunes to a station that is currently broadcasting the specified program type (genre). - 20

EON (Enhanced Other Network) reservation

Sets the tuner to automatically switch to stations broadcasting one of two types of programs, even though you are listening to another station. The tuner returns to the original station when the broadcast of the selected program ends. - 20

PS (Program Service Name) Display

Automatically displays the station name transmitted by the RDS station.

RDS Auto Memory function

Automatically selects and stores up to 30 RDS stations in the preset memory. If fewer than 30 RDS stations have been stored in the preset memory, regular FM stations will be stored in the remaining places. - 18

Radio text function

Displays the radio text data transmitted by some RDS stations when you press the **DISPLAY** key. There is no display if no text data was transmitted.

The "RDS" indicator lights up when an RDS broadcast (signal) is received.

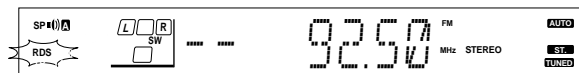

Note

Some functions and function names may differ for certain countries and areas.

Before using a function utilizing the RDS, be sure to perform the RDS Auto Memory operation by referring to the description in "Presetting RDS stations (RDS AUTO MEMORY)". - 18

Using the DISPLAY key

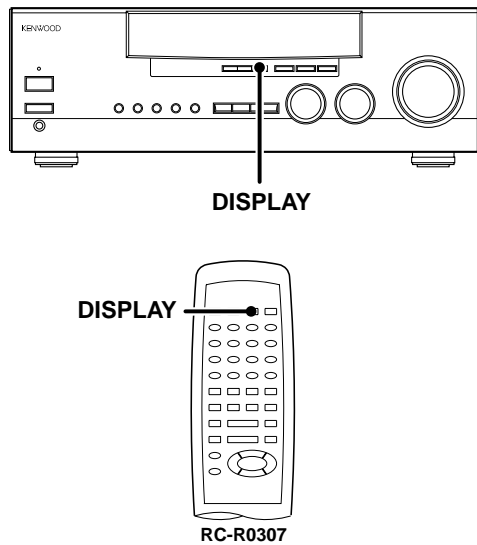

Pressing the **DISPLAY** key changes the contents of the display.

Each press switches the display mode as follows:

- ❶ **PS** (Program Service name) display
- ❷ **RT** (Radio Text) display
- ❸ **Frequency** display

❶ PS (Program Service name) display:

The station name is displayed automatically when an RDS broadcast is received. If no PS data was sent, "NO PS" is displayed.

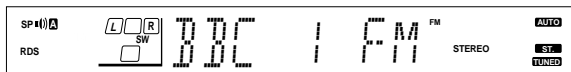

❷ RT (Radio Text) display:

Text data accompanying the RDS broadcast scrolls across the display. "NO RT" or "RT----" is displayed if the current RDS station does not provide RT data.



❸ Frequency display:

Displays the frequency of the current station.

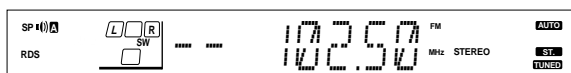

Presetting RDS stations (RDS AUTO MEMORY)

This function automatically stores up to 30 RDS stations in the preset memory. In order to use the EON and PTY functions, the RDS stations must be stored in the preset memory using the RDS AUTO MEMORY function.

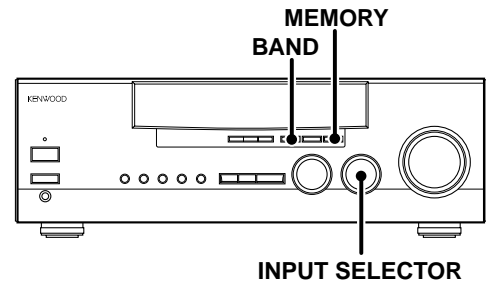

- ❶ Use the input selector to select the tuner.
- ❷ Use the **BAND** key to set the broadcast band to "FM".
- ❸ Press and hold the **MEMORY** key for more than 2 seconds.

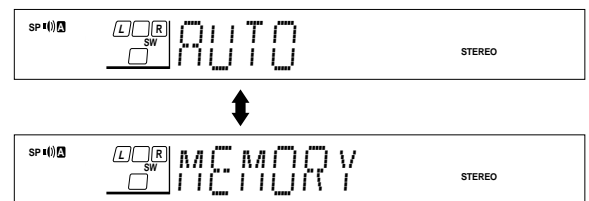

- After a few minutes, up to 30 RDS stations are preset in order from channel "01".
- Stations already stored in the preset memory may be replaced by RDS stations. (i.e., If the RDS AUTO MEMORY function finds 15 RDS stations, the stations currently preset at numbers 01-15 are replaced by the RDS stations.)

Presetting radio stations manually

The RDS auto memory function assigns preset numbers to RDS stations starting from preset number "1". Therefore, be sure to execute the RDS auto memory function before using the following operations to manually store AM stations and other FM stations, and RDS stations. "Presetting RDS stations (RDS AUTO MEMORY)". 

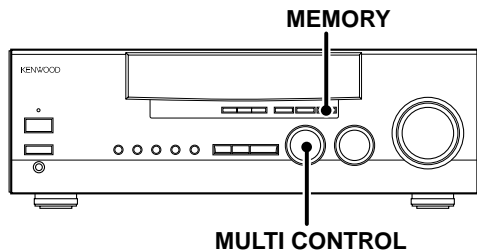

- 1** Tune to the station you want to store.
- 2** Press the **MEMORY** key while receiving the station.

Proceed to step **3** within 5 seconds.
(If more than 5 seconds elapse, press the **MEMORY** key again).

- When storing radio stations manually, it may take a few seconds before the "MEMORY" indicator appears in the display after pressing the **MEMORY** key depending on receiving conditions.

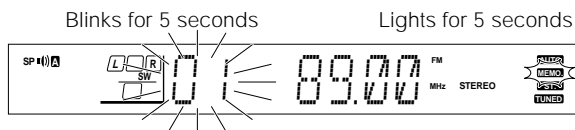

- 3** Use the **MULTI CONTROL** to select one of the station presets (1 - 30).
- 4** Press the **MEMORY** key to accept the setting.

- Repeat steps **1**, **2**, **3** and **4** to store as many stations as necessary.
- If you store a station at a previously used preset, the old station will be replaced by the new one.

Receiving preset stations

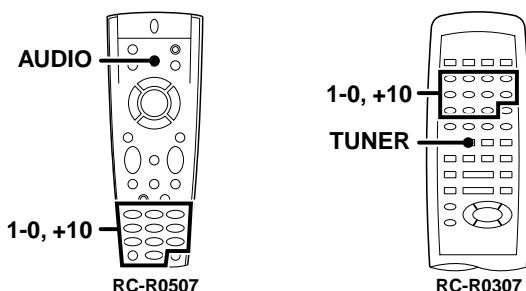

- 2** Enter the number of the preset you want to receive (up to "30").

Press the numeric keys in the following order:

For "15", press **+10**, **5**
For "20", press **+10**, **+10**, **0**

- If you make a mistake entering a two digit number, press the **+10** key several times to return to the original display and start again.

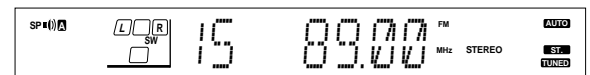

Receiving preset stations in order (P.CALL)

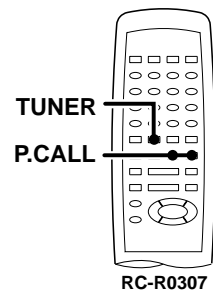
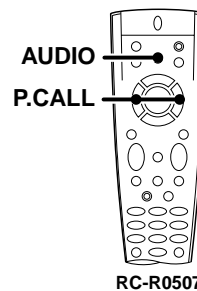

- 1** Use the remote control to select the tuner as the source.
 - The remote control switches to the tuner operating mode.
- 2** Use the **P.CALL** key to select the desired station.

- Each time you press the key, another preset station is received in order.

Pressing the **P.CALL** (\blacktriangleright) key (\blacktriangleright) does the following:
01→02→03→ 28→29→30→01→02→03→

Pressing the **P.CALL** (\blacktriangleleft) key (\blacktriangleleft) does the following:
01←02←03← 28←29←30←01←02←03←

Holding down the key, lets you skip through the presets, receiving each for 0.5 seconds a piece.

- 1** Use the remote control to select the tuner as the source.

- The remote control switches to the tuner operating mode.

Tuning by program type (PTY search)

This function lets you set the tuner to automatically search for stations which are currently broadcasting the type of program (genre) you want to listen to.

Under certain receiving conditions, it may take more than 1 minute to complete the search.

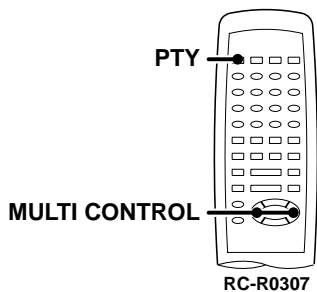
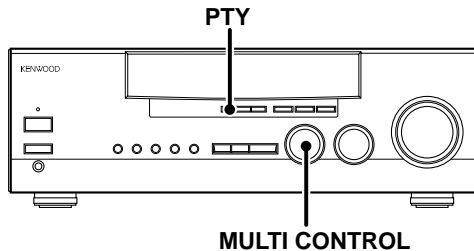

Preparations

- Execute the RDS auto memory procedure.
- Set the broadcast band to FM.
- Tune to an RDS station.

1 Press the PTY key to activate the PTY search mode.

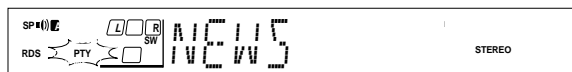

When an RDS broadcast is received, the program type is shown on the display. If no PTY data is available, or if the station is not an RDS station, "NONE" is displayed.

2 While the "PTY" indicator is lit, use the MULTI CONTROL to select the program type of your choice.

Program type table

Program Type Name	Display	Program Type Name	Display
Pop Music	POP M	Weather	WEATHER
Rock Music	ROCK M	Finance	FINANCE
*M.O.R. Music	M.O.R. M	Children's programmes	CHILDREN
Light Classic Music	LIGHT M	Social affairs	SOCIAL A
Serious Classic Music	CLASSICS	Religion	RELIGION
Other Music	OTHER M	Phone in	PHONE IN
News	NEWS	Travel	TRAVEL
Current Affairs	AFFAIRS	Leisure	LEISURE
Information	INFO	Jazz music	JAZZ
Sport	SPORT	Country Music	COUNTRY
Education	EDUCATE	National Music	NATION M
Drama	DRAMA	Oldies Music	OLDIES
Cultures	CULTURE	Folk Music	FOLK M
Science	SCIENCE	Documentary	DOCUMENT
Varied Speech	VARIED		

*M.O.R. Music (Middle of the Road Music)

"NO PROG" is displayed if this operation is attempted before performing the RDS Auto Memory operation.

3 Press the PTY key to start searching.

EXAMPLE: Searching for a Rock Music broadcast.

Display while searching

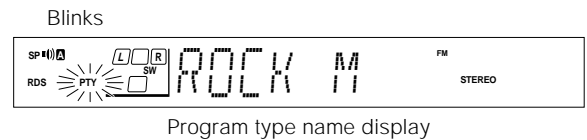

Display when a station is received.

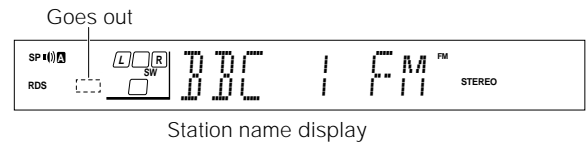

- No sound is heard while "PTY" is blinking.
- If the desired program type cannot be found, "NO PROG" is displayed, then after several seconds the display returns to the original display.

To select another program type

Repeat steps 1, 2 and 3.

Reserving the desired information

When the receiver is tuned to a RDS EON station (a station at which the EON indicator lights up), this function lets you set the receiver to automatically switch stations to receive news or traffic programs as they are broadcast. When the broadcast is over, the receiver returns to the original station automatically.

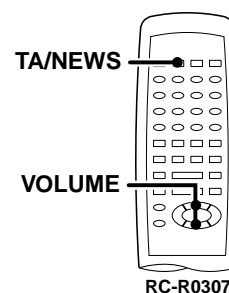
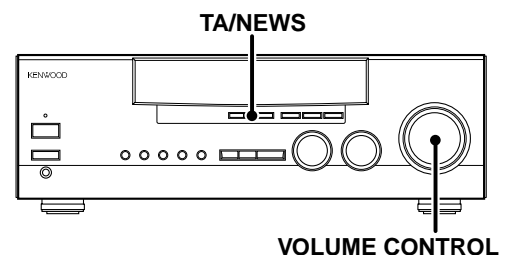

Preparation

- Set the broadcast band to FM.

1 Complete steps 1~3 of "Presetting RDS stations (RDS AUTO MEMORY)".



Skip this step if you have already completed the RDS AUTO MEMORY procedure.

- The EON function will not work if all 30 FM preset stations were stored manually using the procedure shown in "Presetting radio stations manually". Be sure to use the RDS automatic memory function.

2 Press the TA/NEWS key to select the information type of your choice.

Display When "TA" is selected

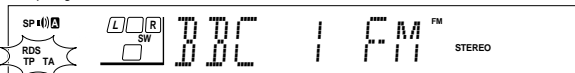

"TP" lights for stations where TP (Traffic Program) information can be received.

Each press switches the reservation mode as follows:

- 1 TA (Traffic Announcement)
- 2 NEWS (News)
- 3 TA, NEWS (Traffic Announcement and News)
- 4 off (EON off)

- If "TA" and "NEWS" can not be selected, carry out the RDS automatic memory function again.

3 Tune to a preset RDS station.

Choose an RDS preset station that displays both the "RDS" and "EON" indicators.

Display When "TA" is selected

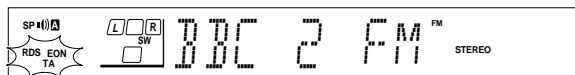

Be sure "EON" appears in the display

- If you want to reserve TA, receive a station with which the TP indicator lights.
- When "EON" does not light although an RDS station is received, that station is not transmitting EON data. Please select a different station.

4 Wait for the information you selected while listening to the current station.

The receiver will wait for the desired information to start as long as the tuner is set to a preset RDS station that displays both the "EON" and "RDS" indicators, and the power is turned ON.

When listening to the tuner:

Be sure to stay tuned to stations that display both the "EON" and "RDS" indicators.

To listen sources other than the tuner:

- Tune in a station which that displays both the "EON" and "RDS" indicators, then use the INPUT SELECTOR to switch the input to the source you desire.
- Even when the INPUT SELECTOR is set to a source other than tuner, it will automatically switch to tuner when the desired EON program starts to broadcast. During this period, the source selected in step 1 continues playing, but will not be heard.
- When reception of the desired EON program is complete, the INPUT SELECTOR returns to the previous input source.

- When the power is OFF, the EON function does not operate.
- If a reserved EON program starts to broadcast during analog recording, the INPUT SELECTOR switches to the tuner and the station broadcasting the EON program is recorded.

When waiting for information while listening to a RDS station without the EON function

If the "EON" indicator does not light in steps 3 and 4 and the desired kind of information has already been selected, the information from only the station being received will be waited for.

TP (Traffic Program) indication

When the "TP" indicator is lit, this means that the presently-received station or a station in the same network is transmitting traffic information. When "TP" is displayed for the station being received, the traffic information of this station can be received without EON reservation.

To cancel EON reservation

Turn the "TA" and "NEWS" indicators off.

Setting the volume while receiving information (TI volume)

If you preset the volume level, you can listen to the information of your choice at that volume level automatically. After the information has been received, the volume returns to the previous level.

- Hold down the TA/NEWS key for more than two seconds so that the "TI.VOL" indicator starts blinking.

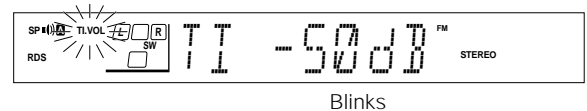

Blinks

- Use the VOLUME CONTROL knob to select the desired volume level.

Proceed to next step within five seconds.

- Press the TA/NEWS key to enter the new setting.

- The "TI.VOL" indicator stops blinking and remains lit.

Canceling TI volume

Hold down the TA/NEWS key for more than two seconds so that the "TI.VOL" indicator goes off.

This receiver is equipped with listening modes that allow you to enjoy an enhanced sonic ambience with a variety of video sources.

In order to obtain the optimum effect from the surround modes, make sure to input the proper speaker settings beforehand. → 13

Manufactured under license from Dolby Laboratories Licensing Corporation. DOLBY, the double-D symbol  and "PRO LOGIC" are trademarks of Dolby Laboratories Licensing Corporation.

Surround modes

Dolby Pro Logic

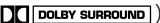
Dolby Pro Logic is a specially encoded 2 channel surround format designed to provide theater-like surround sound from Dolby Surround encoded sources (such as video and Laserdisc software marked ).

This receiver is equipped with a Dolby Pro Logic surround decoder to let you enjoy the wide variety of currently available Dolby Surround home video software.

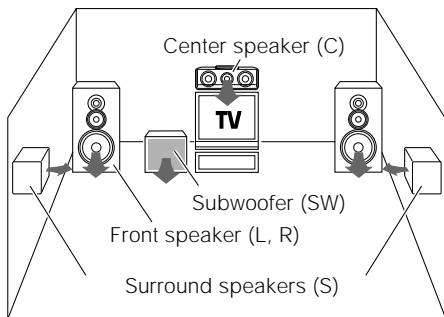

Dolby 3 Stereo

Dolby 3 Stereo is available for systems that do not have surround speakers. When in the Dolby 3 Stereo mode, the surround information is redirected to the front left and right speakers. This mode is designed for use with Dolby Surround program sources, but can also improve sound field unity for programs that are not Dolby Surround encoded. Dialog positioning and sound image definition, however, may not be as accurate when used with programs that are not Dolby Surround encoded.

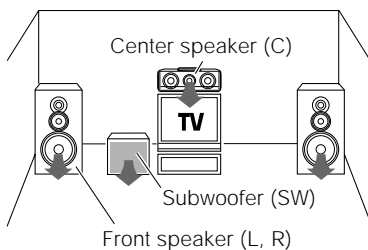

DSP mode

The DSP mode lets you add the atmosphere of a live concert or hall to almost any type of program source. These modes are particularly effective when used with stereo program sources, like CD, television, and FM radio. You might enjoy trying the LIVE or HALL mode the next time you watch a concert or sporting event!

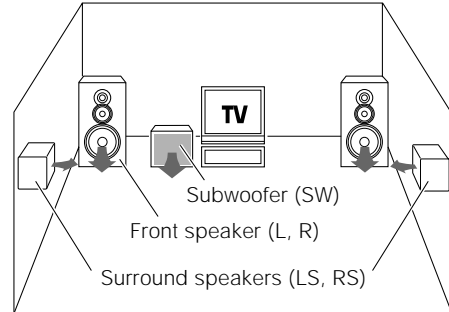

What's DSP?

DSP stands for Digital Signal Processor.

The way a sound is heard in an actual environment depends on a variety of different factors. One of the most important is reverberation (the act of decaying elements of sound echoing in various places). The DSP modes produce the feeling of presence by using the DSP to create reverberation, without spoiling the sound quality of the original signal.

DVD 6-channel mode

Using a DVD player or the like equipped with six (5.1) output channels and the receiver, you can enjoy multi-channel encoded DVD source material in all its splendor. Since the source signals are digital and each channel is input independently, the resulting sound quality, sense of spaciousness, and dynamic range are superb.

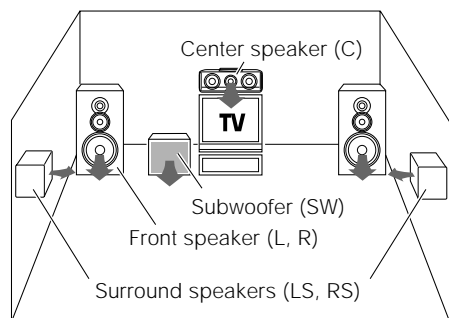

Surround Play

DOLBY PRO LOGIC and DOLBY 3 STEREO can be used when playing video, DVD, or LD software bearing the  mark. DSP modes can be used with any source.

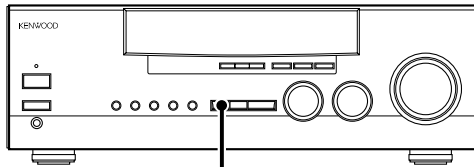

LISTEN MODE

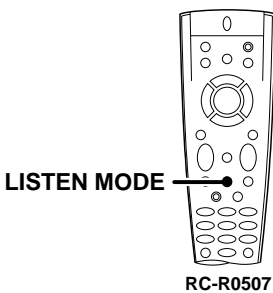

LISTEN MODE

RC-R0507

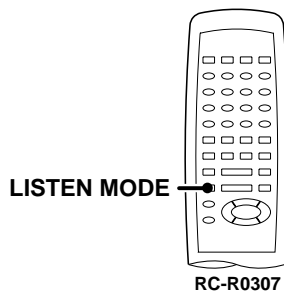

LISTEN MODE

RC-R0307

Preparations

- Turn ON related components.
- Complete "Preparing for surround sound". 
- Set the INPUT SELECTOR to the component you wish to play back with surround sound.

1 Start playing the video software.

2 Press the LISTEN MODE key to select the listening mode.

Listening mode settings are stored independently for each input.

Each press of the LISTEN MODE key switches the setting as listed below.

Note that the only listening mode settings that can be used for playback with the current speaker settings are available.

- DOLBY PRO LOGIC
- DOLBY 3 STEREO
- LIVE (DSP)
- HALL (DSP)
- STEREO

Example with the DOLBY PRO LOGIC mode selected

The channels from which sound will issue are displayed.

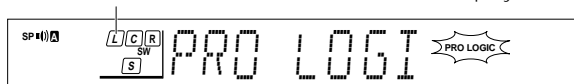

3 Adjust the volume.

DVD 6-channel playback

Using a DVD player or the like equipped with six (5.1) output channels and the receiver, you can enjoy surround sound playback.

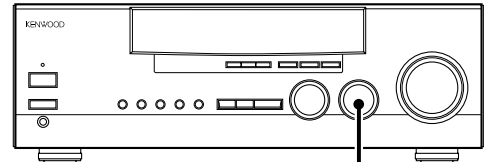

INPUT SELECTOR

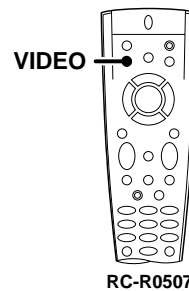

VIDEO

RC-R0507

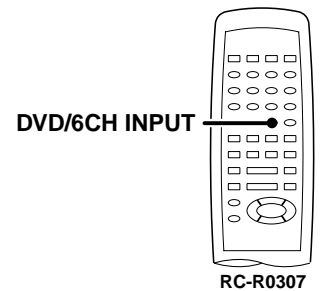

DVD/6CH INPUT

RC-R0307

Preparations

- Connect your DVD player to the DVD 6ch jacks of the receiver.
- Turn on all other components that will be used.
- Complete "Preparing for surround sound". 

1 Select "DVD 6ch" as the input source.

- If speaker system B is on when "DVD 6ch" is selected as the input source, it switches off and speaker system A turns on automatically (models other than KRF-V5010).

2 Start playback of the DVD software.

3 Adjust the volume.

- It is not possible individually to adjust the volume level or sound quality (**SETUP**, **SOUND**) of the separate channels when the receiver is in the DVD 6ch mode. Adjust the volume with the controls of the DVD player. For the powered subwoofer, you can adjust the volume of the subwoofer using the subwoofer's own volume control.
- When in the DVD 6ch mode, you can still use the volume control, mute, SPEAKERS (A) key, and dimmer functions.

Convenient functions

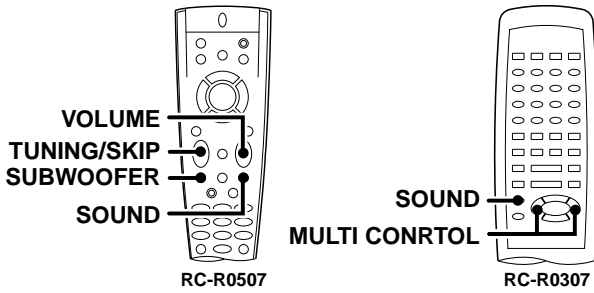
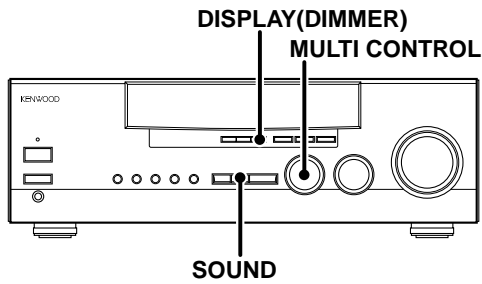

SUBWOOFER adjustment (RC-R0507 only)

It is easy to adjust the volume of the subwoofer using the remote control (RC-R0507).

- 1 Press the SUBWOOFER key so that "SW" is displayed.



- 2 Use the VOLUME key to adjust the volume.

- The adjustable range is -10 dB to +10 dB.

Display dimmer adjustment

The dimmer function lets you select the brightness of the receiver's display. You might find this useful if you darken your room to watch movies or listen to music.

Each time you hold down the DISPLAY key for more than two seconds, the display brightness changes among the three available settings. Select the brightness level you find most pleasing.

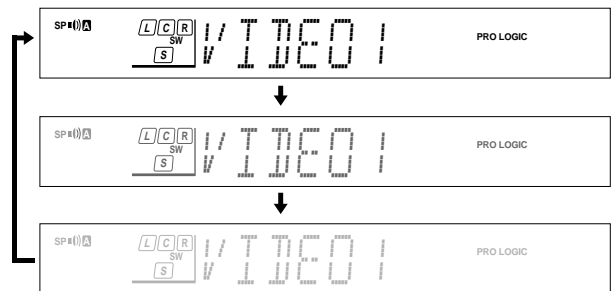

Adjusting the sound

You can make further adjustments to the sound while listening to playback in the surround mode.

- 1 Press the SOUND key to select the item you want to adjust.

Each press switches the selection as listed below.

Note that some items are not displayed in certain modes.

- BASS** (low frequency range sound quality adjustment) - 15
- TREB** (high frequency range sound quality adjustment) - 15
- Cch** (center speaker level adjustment)
- Sch** (surround speaker level adjustment)
- SW** (subwoofer level adjustment)
- INPUT** (input level adjustment)

- The adjustment item for input level is displayed only when the monitor function is activated.

- 2 Use the MULTI CONTROL (TUNING/SKIP) to adjust the setting as desired.

- The adjustment item is displayed for approximately eight seconds.
- If you use the remote control (RC-R0507) to perform the above setting, press the VIDEO key at this point to turn off the remote control's own adjustment mode. In this case, the input source is not switched.

Input level adjustment (when using the monitor function)

If the input level while using the monitor function is too high, adjust the input level as described below.

- 1 Turn on the monitor function. - 16
- 2 Press the SOUND key several times until the "INPUT" indication appears.
- 3 Use the MULTI CONTROL (TUNING/SKIP) to adjust the input level.

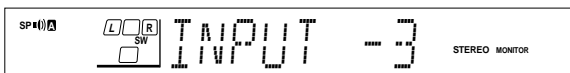

- The adjustment mode is displayed for approximately eight seconds.
- The input level may be adjusted to any one of two settings: 0 and -6. (The initial setting is 0.)

- 4 Press the SOUND key to return to the input indication.

Resetting the Microcomputer

If the microcomputer may malfunction (unit cannot be operated, or shows an erroneous display) if the power cord is unplugged while the power is ON, or due to some other external factor. If this happens, execute the following procedure to reset the microcomputer and return the unit to its normal operating condition.

With the power cord plugged in, turn the POWER key OFF. Then, while holding down the ON/STANDBY key, press POWER.

- Please note that resetting the microcomputer will clear the contents of the memory and returns the unit to the state it was in when it left the factory.

Amplifier

Symptom	Cause	Remedy
No sound from the speakers.	<ul style="list-style-type: none"> • The speaker cords are disconnected. • VOLUME is set to the minimum position. • MUTE is ON. • The SPEAKERS switches are set to OFF. 	<ul style="list-style-type: none"> • Connect them properly referring to "Connecting the speakers" → 11 • Adjust the volume to a proper level. • Turn OFF the MUTE. → 16 • Set the SPEAKERS switch(es) to ON. → 14
The standby indicator blinks and sound is not output.	<ul style="list-style-type: none"> • Speaker cords are short-circuited. 	<ul style="list-style-type: none"> • Turn the power off, eliminate the short-circuiting, then turn on the power again. → 11
Sound is not output from one of the speakers.	<ul style="list-style-type: none"> • The speaker cord is disconnected. 	<ul style="list-style-type: none"> • Connect it properly referring to "Connecting the speakers".
Sound is not output from the surround speakers and / or the center speaker, or their sound is very small.	<ul style="list-style-type: none"> • The surround speaker cords and/or the center speaker cord is disconnected. • A surround mode has not been engaged. • The surround and/or center volume controls are set to the minimum level. 	<ul style="list-style-type: none"> • Connect it properly referring to "Connecting the speakers". • Select a surround mode. • Adjust the speaker levels using the test tone. → 14
A humming noise is generated when the PHONO input selector is selected.	<ul style="list-style-type: none"> • The audio cord from the turntable is not connected to the PHONO jacks. • The turntable is not grounded. 	<ul style="list-style-type: none"> • Insert the audio cord plugs securely into the PHONO jacks. • Connect the grounding wire to the GND terminal on the rear panel.

Tuner

Symptom	Cause	Remedy
Radio stations cannot be received.	<ul style="list-style-type: none"> • No antenna is connected. • The broadcast band is not set properly. • The frequency of the desired station is not tuned. 	<ul style="list-style-type: none"> • Connect an antenna. • Set the broadcast band properly. • Tune the frequency of the desired station. → 17
Interference.	<ul style="list-style-type: none"> • Noise due to ignition noise from an automobile. • Noise due to interference from an electric appliance. • Noise due to a nearby TV set. 	<ul style="list-style-type: none"> • Install the outdoor antenna away from the road. • Turn off the power to the appliance. • Install the receiver farther away from the TV.
A station which was preset cannot be received by pressing the corresponding numeric key.	<ul style="list-style-type: none"> • The preset station belongs to a frequency that cannot be received. • The preset memory was cleared because the power cord had been unplugged for a long period of time. 	<ul style="list-style-type: none"> • Preset a station with a receivable frequency. • Preset the station again.

Remote control unit

Symptom	Cause	Remedy
Remote control operation is not possible.	<ul style="list-style-type: none"> Batteries are exhausted. The remote control unit is too far away from the main system, controlling angle is too large, or there is an obstacle between the receiver and the remote. The audio cords and system control cords are not connected properly. No software is loaded in the source component. An attempt is made to play a tape which is being recorded in the cassette deck. 	<ul style="list-style-type: none"> Replace with new batteries. → [12] → [13] Operate the remote control unit within the controllable range. Connect properly referring to "Setting up the system". → [8] Place software in the source component you want to play. Wait until recording has completed.

Memory back up function

Please note that the following items will be deleted from the unit's memory if the power cord is disconnected from the AC outlet or the main power switch is turned off for approximately 3 days.

- Power mode.
- Input selector settings.
- Volume level.
- Broadcast band.
- Frequency setting.
- Preset stations.

AUDIO section

Rated power output during STEREO operation

KRF-V7010 (DIN) 1 kHz, 0.7% at 4 Ω	100 W + 100 W
KRF-V6010 (DIN) 1 kHz, 0.7% at 4 Ω	90 W + 90 W
KRF-V5010 (DIN) 1 kHz, 0.7% at 4 Ω	50 W + 50 W

Effective power output during SURROUND operation

KRF-V7010	
FRONT(1kHz, 0.7% T.H.D. at 4 Ω one channel driven)	100 W + 100 W
CENTER (1kHz, 0.7% T.H.D. at 4 Ω one channel driven)	100 W
SURROUND(1kHz, 0.7% T.H.D. at 4 Ω one channel driven)	100 W + 100 W
KRF-V6010	
FRONT(1kHz, 0.7% T.H.D. at 4 Ω one channel driven)	80 W + 80 W
CENTER (1kHz, 0.7% T.H.D. at 4 Ω one channel driven)	80 W
SURROUND(1kHz, 0.7% T.H.D. at 4 Ω one channel driven)	80 W + 80 W
KRF-V5010	
FRONT(1kHz, 0.7% T.H.D. at 4 Ω one channel driven)	50 W + 50 W
CENTER (1kHz, 0.7% T.H.D. at 4 Ω one channel driven)	50 W
SURROUND(1kHz, 0.7% T.H.D. at 4 Ω one channel driven)	50 W + 50 W

Total harmonic distortion

KRF-V7010	0.03%(1 kHz, 50W, 4 Ω)
KRF-V6010	0.03%(1 kHz, 40W, 4 Ω)
KRF-V5010	0.03%(1 kHz, 25W, 4 Ω)

Signal to noise ratio

PHONO (MM)	75 dB (IHF'66)
	55 dB (DIN 50mW output)
CD	91 dB (IHF'66)
	56 dB (DIN 50mW output)

Input sensitivity / impedance

PHONO (MM)	2.5 mV / 27 kΩ
CD	200 mV / 47 kΩ
DVD 6CH (SUBWOOFER)	200 mV / 10 kΩ

Output level / impedance

TAPE REC	200 mV / 1 kΩ
PRE OUT (CENTER, SURROUND)	1 V / 1 kΩ
	(only KRF-V7010, KRF-V6010)
PRE OUT (SUBWOOFER)	1 V / 600 Ω

Tone control

BASS	±10 dB (at 100 Hz)
TREBLE	±10 dB (at 10 kHz)

VIDEO section

VIDEO inputs / outputs

VIDEO (composite)	1 Vp-p / 75 Ω
-------------------	---------------

FM tuner section

Tuning frequency range

U.K. and Europe	87.5 MHz ~ 108 MHz
Russia	87.5 MHz ~ 108 MHz, 65.0 MHz ~ 74.0 MHz

Usable sensitivity (DIN, 75 Ω)

MONO	1.2 μV / 13.2 dBf (40 kHz DEV., S/N 26 dB)
STEREO	35 μV / 42.1 dBf (46 kHz DEV., S/N 46 dB)

Total harmonic distortion (DIN, 1 kHz)

MONO	0.2% (65.2 dBf input)
STEREO	0.8% (65.2 dBf input)

Signal to noise ratio (DIN weighted, 1 kHz)

U.K. and Europe	
MONO	65 dB (40 kHz DEV., 65.2 dBf input)
STEREO	60 dB (46 kHz DEV., 65.2 dBf input)
Russia	
MONO	63 dB (40 kHz DEV., 65.2 dBf input)
STEREO	58 dB (46 kHz DEV., 65.2 dBf input)

Stereo separation (DIN, 1 kHz) 36 dB

Selectivity (DIN, ±300 kHz) 64 dB

Frequency response (30 Hz ~ 15kHz) +0.5 dB, -3.0 dB

AM tuner section

Tuning frequency range 531 kHz ~ 1,602 kHz

Usable sensitivity (30% mod., S/N 20 dB)

..... 16 μV / (600 μV/m)

Signal to noise ratio (30% mod., 1 mV input) 50 dB

GENERAL

Power consumption

KRF-V7010, KRF-V6010	280 W
KRF-V5010	210 W

AC outlet

SWITCHED 2 (total 150 W max.)

Dimensions W : 440 mm

H : 144 mm

KRF-V7010 D : 400 mm

KRF-V6010, KRF-V5010 D : 390 mm

Weight (Net)

KRF-V7010, KRF-V6010 8.6 kg

KRF-V5010 8.2 kg

Notes

1. KENWOOD follows a policy of continuous advancements in development. For this reason specifications may be changed without notice.
2. The full performance may not be exhibited in an extremely cold location (under a water-freezing temperature).

KENWOOD

For your records

Record the serial number, found on the back of the unit, in the spaces designated on the warranty card, and in the space provided below. Refer to the model and serial numbers whenever you call upon your dealer for information or service on this product.

Model _____ Serial Number _____

Free Manuals Download Website

<http://myh66.com>

<http://usermanuals.us>

<http://www.somanuals.com>

<http://www.4manuals.cc>

<http://www.manual-lib.com>

<http://www.404manual.com>

<http://www.luxmanual.com>

<http://aubethermostatmanual.com>

Golf course search by state

<http://golfingnear.com>

Email search by domain

<http://emailbydomain.com>

Auto manuals search

<http://auto.somanuals.com>

TV manuals search

<http://tv.somanuals.com>