

KENWOOD

AUDIO VIDEO SURROUND RECEIVER

KRF-V7070D

INSTRUCTION MANUAL

KENWOOD CORPORATION

About the supplied remote control

Compared to standard remote controls, the remote control supplied with this receiver has several operation modes. These modes enable the remote control to control other audio/video components. In order to effectively use the remote control it is important to read the operating instructions and obtain a proper understanding of the remote control and how to switch its operation modes (etc.). Using the remote control without completely understanding its design and how to switch the operation modes may result in incorrect operations.

ENGLISH

FRANÇAIS

DEUTSCH

ITALIANO

ESPAÑOL

Before applying the power

 **Caution : Read this page carefully to ensure safe operation.**

Units are designed for operation as follows.

U.S.A. and Canada AC 120 V only
Australia AC 240 V only
Europe and U.K. AC 230 V only
China and Russia AC 220 V only
Other countries AC 110-120 / 220-240 V switchable*

ENGLISH

How to use this manual

This manual is divided into four sections, Preparations, Operations, Remote Control, and Additional Information.

Preparations

Shows you how to connect your audio and video components to the receiver and prepare the surround processor.

Since this receiver works with all your audio and video components, kindly follow the instructions in this manual for the correct connections.

Operations

Shows you how to operate the various functions available on the receiver.

Remote Control

Shows you how to operate other components using the remote control, as well as a detailed explanation of all remote control operations. Once you have registered your components with the proper setup codes, you'll be able to operate both this receiver and your other AV components (TV, VCR, DVD player, CD player, etc.) using the remote control supplied with this receiver.

Additional Information

Shows you additional information such as "In case of difficulty" (troubleshooting) and "Specifications".

Safety precautions

WARNING :

TO PREVENT FIRE OR ELECTRIC SHOCK,
DO NOT EXPOSE THIS APPLIANCE TO
RAIN OR MOISTURE.



CAUTION
RISK OF ELECTRIC SHOCK
DO NOT OPEN



CAUTION: TO REDUCE THE RISK OF ELECTRIC SHOCK, DO NOT REMOVE COVER (OR BACK). NO USER-SERVICEABLE PARTS INSIDE. REFER SERVICING TO QUALIFIED SERVICE PERSONNEL.



THE LIGHTNING FLASH WITH ARROWHEAD SYMBOL, WITHIN AN EQUILATERAL TRIANGLE, IS INTENDED TO ALERT THE USER TO THE PRESENCE OF UNINSULATED "DANGEROUS VOLTAGE" WITHIN THE PRODUCT'S ENCLOSURE THAT MAY BE OF SUFFICIENT MAGNITUDE TO CONSTITUTE A RISK OF ELECTRIC SHOCK TO PERSONS.



THE EXCLAMATION POINT WITHIN AN EQUILATERAL TRIANGLE IS INTENDED TO ALERT THE USER TO THE PRESENCE OF IMPORTANT OPERATING AND MAINTENANCE (SERVICING) INSTRUCTIONS IN THE LITERATURE ACCOMPANYING THE APPLIANCE.

Maintenance of the unit



When the front panel or case becomes dirty, wipe with a soft, dry cloth. Do not use thinner, benzine, alcohol, etc. for these agents may cause discoloration.

In regard to contact cleaner

Do not use contact cleaners because it could cause a malfunction. Be specially careful not to use contact cleaners containing oil, for they may deform the plastic component.

Contents

Caution : Read the pages marked  carefully to ensure safe operation.

Preparations	 Before applying the power 2
	 Safety precautions 2
	How to use this manual 2
	Unpacking 4
	Preparing the remote control 4
	Special features 5
	Names and functions of parts 6
	Main Unit 6
	Remote control unit 7
	Setting up the system 8
	Connecting the terminals 9
	Connecting audio components 10
	Connecting video components 11
Digital connections 12	
Connecting a DVD player (6-channel input) 13	
Connecting the speakers 14	
Connecting to the AV AUX jacks 15	
Connecting the antennas 15	
Connecting the system control 16	
Preparing for surround sound 17	
Speaker settings 17	

Operations	Normal playback 20
	Preparing for playback 20
	Listening to a source component 20
	Adjusting the sound 21
	Recording 23
	Recording audio (analog sources) 23
	Recording video 23
	Recording audio (digital sources) 23
	Listening to radio broadcasts 24
	Tuning (non-RDS) radio stations 24
	Using RDS (Radio Data System) 24
	Presetting radio stations manually 25
	Receiving preset stations 25
	Receiving preset stations in order (P.CALL) ... 25
	Using the RDS DISP (Display) key 26
	Presetting RDS stations (RDS AUTO MEMORY) 26
	Tuning by Program TYpe (PTY search) 27
Ambience effects 28	
Surround modes 28	
Surround play 31	
DVD 6-channel playback 32	
Convenient functions 32	

Remote Control	Basic remote control operations for other components 35
	Registering setup codes for other components 35
	Searching for your code 35
	Checking the codes 35
	Re-assigning device keys 36
	Operating other components 36
	Setup code chart 37
	CASSETTE deck, CD player & MD recorder operations 42
	Other components' operations 43

Additional Information	In case of difficulty 45
	 Specifications 47

Unpacking

Unpack the unit carefully and make sure that all accessories are present.

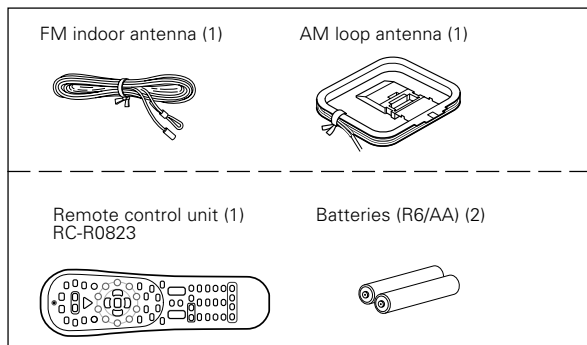

If any accessories are missing, or if the unit is damaged or fails to operate, notify your dealer immediately. If the unit was shipped to you directly, notify your shipper immediately. Kenwood recommends that you retain the original carton and packing materials in case you need to move or ship the unit in the future.

Keep this manual handy for future reference.

Preparing the remote control

Loading the batteries

1 Remove the cover.

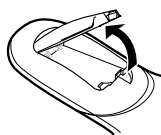

2 Insert the batteries.

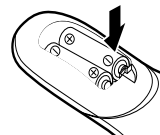

3 Close the cover.



- Insert two AA-size (R6) batteries as indicated by the polarity markings.

Operation

When the **STANDBY** indicator is lit, the power turns ON when you press the **POWER RCVR** key on the remote control. When the power comes ON, press the key you want to operate.

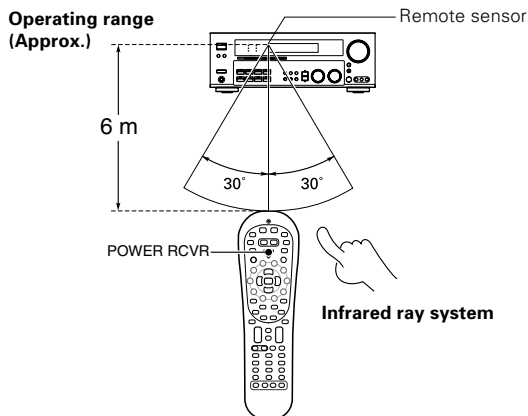

- When pressing more than one remote control key successively, press the keys securely by leaving an interval of 1 second or more between keys.

Notes

1. The supplied batteries may have shorter lives than ordinary batteries due to use during operation checks.
2. When the remote-controllable distance gets shorter than before, replace both batteries with new ones.
3. Placing the remote sensor in direct sunlight, or in direct light from a high frequency fluorescent lamp may cause a malfunction. In such a case, change the location of the system installation to prevent malfunction.

Memory back up function

Please note that the following items will be deleted from the unit's memory if the power cord is disconnected from the AC outlet for approximately 1 day.

- Power mode.
- Input selector settings.
- Picture output.
- Speaker ON/OFF.
- Volume level.
- BASS, TREBLE, INPUT level.
- TONE ON/OFF.
- LOUDNESS ON/OFF.
- Dimmer level.
- MD/TAPE settings.
- Listen mode setting.
- Speaker settings.
- SW RE-MIX ON/OFF.
- Distance setting.
- Input mode setting.
- Midnight mode setting.
- PRO LOGIC II mode setting.
- CS II mode setting.
- Broadcast band.
- Frequency setting.
- Preset stations.
- Tuning mode.
- DSP mode.
- ACTIVE EQ mode.
- SPEAKER EQ mode.

Special features

True home theater sound

This receiver incorporates a wide variety of surround modes to bring you maximum enjoyment from your video software. Select a surround mode according to your equipment or the software you are going to play and enjoy! → [28]

Dolby Digital and Dolby Digital EX

The DOLBY DIGITAL mode lets you enjoy full digital surround from software processed in the Dolby Digital format. Dolby Digital provides up to 5.1 channels of independent digital audio for better sound quality and more powerful presence than conventional Dolby Surround.

As for Dolby Digital EX, it creates six full-bandwidth output channels from the 5.1 channel sources. This is done using a matrix decoder that derives three surround channels from the two in the original recording. For best results, Dolby Digital EX should be used with movie soundtracks recorded with Dolby Digital Surround EX.

Dolby PRO LOGIC II

Dolby PRO LOGIC II, whilst totally compatible with its predecessor PRO LOGIC, provides greater advantages in surround sound. It allows the user to enjoy the conventional stereo or Dolby Surround with a convincing "5.1 like" presentation. PRO LOGIC II offers special features for controlling the overall spatial, dimensionality and frontal sound field imaging. PRO LOGIC II produces an impressive surround sound from video software marked  and three-dimensional space from music CD. When listening to music, you will be able to enjoy the experience of sheer STEREO surround sound.

DTS

DTS (Digital Theater System) is a 5.1 channel digital audio format that provides five full-spectrum channels and one low-frequency (subwoofer) channel for unprecedented clarity, optimum channel separation and a (wide) dynamic range.

In the DTS mode, the 5.1 channel digital input from a DTS CD, LD or DVD disc (carrying the "DTS" marking) can be played in Digital Surround. Important:

When a DTS disc is played on a CD, LD or DVD player, noise may be output from the analog output. It is recommended that you connect the digital output of the player to the digital input of this unit.

SRS Circle Surround II

SRS Circle Surround II™ improves on its predecessor CS-5.1™ resulting in the CS-6.1™ system, enabling you to listen to realistic, multi-channel, surround sound playback from a stereo source or conventional surround-encoded video source. You already enjoy listening to Dolby digital/DTS multi-channel sound with your multi-speakers. Now you can listen to audio CDs, MDs, Broadcast and Home Theater using your multi-speakers. You will discover a new type of sound through SRS Circle Surround II.

DSP surround modes

The DSP (Digital Signal Processor) used for this receiver incorporates a variety of high quality adjustable sound fields, like "ARENA", "JAZZ CLUB", "THEATER", "STADIUM" and "DISCO". It is compatible with almost any kind of program source.

DVD 6-channel input

If you own a DVD player equipped with 6-channel output, this receiver allows you to obtain the full surround sound impact of DVD source material featuring multi-channel encoding. Since the source signals are digital and each channel is input independently, the resulting ambience is far superior to what can be achieved with conventional surround sound systems.

ACTIVE EQ

ACTIVE EQ mode will produce a more dynamic sound quality in any condition. You can enjoy a more impressive sound effect when ACTIVE EQ is turned on during Dolby Digital and DTS playback.

SPEAKER EQ

SPEAKER EQ function is to adjust the receiver's audio output characteristics with the speakers' characteristics which differs depending on the size of the speakers. Especially for the music sound source playback, the reproduced sound becomes more natural when adjusting the output characteristics. When activating the SPEAKER EQ function, you will be able to enjoy a more natural and dynamic sound experience even with small size speakers.

Universal IR (InfraRed) remote control

In addition to the basic receiver, the remote control supplied with this receiver can also operate almost all of your remote controllable audio and video components. Just follow the simple setup procedure to register the components you have connected.

RDS (Radio Data System) tuner

The receiver is equipped with an RDS tuner that provides several convenient tuning functions: RDS Auto Memory, to automatically preset up to 40 RDS stations broadcasting different programs; station name display, to show you the name of the current broadcast station; and PTY search to let you tune stations by program type.

PTY (Program TType) search

Tune the stations by specifying the type of program you want to hear.

Names and functions of parts

Main unit

ENGLISH

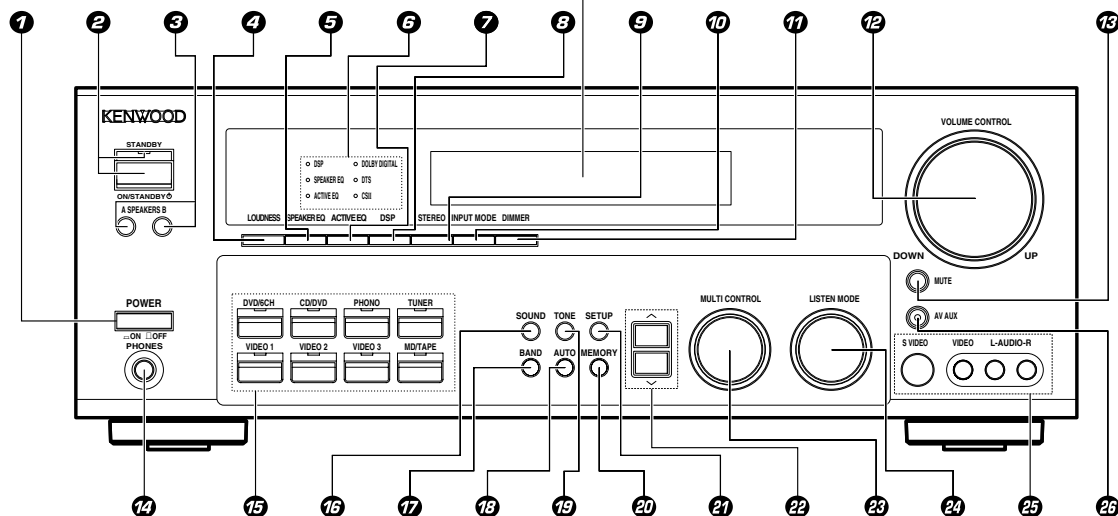
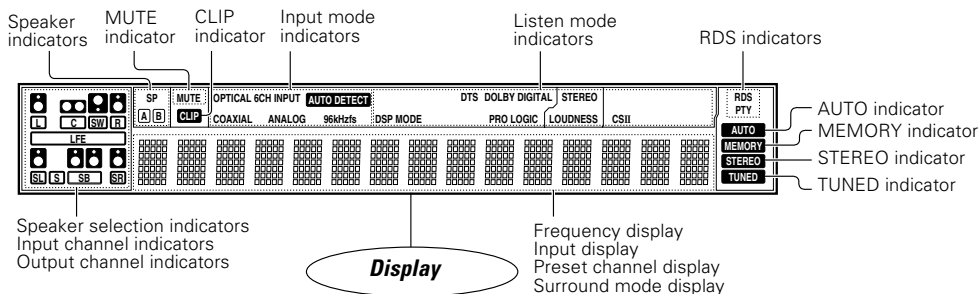

- 1 POWER ON/OFF key** - [17]
Use to turn the main power on or off.
- 2 ON/STANDBY \odot key** - [17]
Use to turn the power ON/STANDBY when the POWER is turned on.
STANDBY indicator
- 3 A SPEAKERS B keys** - [20]
Use to turn the A/B speakers on or off.
- 4 LOUDNESS key** - [21]
Use to switch the status of LOUDNESS.
- 5 SPEAKER EQ key** - [21]
Use to select SPEAKER EQ's setting.
- 6 Surround LED (lighting-emitting diode) indicators**
DSP mode LED indicator - [31]
Lights when the receiver is in the DSP mode.
SPEAKER EQ mode LED indicator - [22]
Lights when the receiver is in the SPEAKER EQ mode.
ACTIVE EQ mode LED indicator - [21]
Lights when the receiver is in the ACTIVE EQ mode.
DOLBY DIGITAL mode LED indicator - [31]
Lights when the receiver is in the Dolby Digital mode.
DTS mode LED indicator - [31]
Lights when the receiver is in the DTS mode.
- 7 CS II mode LED indicator** - [31]
Lights when the receiver is in the CIRCLE SURROUND II mode.
- 8 ACTIVE EQ key** - [21]
Use to select ACTIVE EQ's setting.
- 9 DSP key** - [31]
Use to select any of the DSP mode.
- 10 STEREO key** - [32]
Use to switch the listen mode to STEREO.
- 11 INPUT MODE key** - [8]
Use to switch between the full auto, digital and analog inputs.
- 12 DIMMER key** - [23]
Use to select the REC MODE.
Use to adjust the brightness of the display.
- 13 VOLUME CONTROL knob** - [20]
- 14 MUTE key** - [21]
Use to temporarily mute the sound.
- 15 PHONES jack** - [22]
Use for headphone listening.
- 16 Input Selector keys** - [20]
DVD/6CH, CD/DVD, PHONO, TUNER, VIDEO 1, VIDEO 2, VIDEO 3, MD/TAPE
Use to select input sources.
- 17 SOUND key** - [32]
Use to adjust the sound quality and the ambience effects.
- 18 BAND key** - [24]
Use to select the broadcast band.
- 19 AUTO key** - [24]
Use to select the auto or manual tuning mode.
- 20 TONE key** - [21]
Use to switch the status of TONE control.
- 21 MEMORY key** - [25]
Use to store radio stations in the preset memory and to start the Auto Memory.
- 22 SETUP key** - [17]
Use to select the speakers' settings etc.
- 23 \wedge/\vee keys** - [17]
Use for selection adjustments during sound, setup and preset channel functions.
- 24 MULTI CONTROL knob** - [17]
Use to control a variety of settings.
- 25 LISTEN MODE knob** - [31]
Use to select the listening mode.
- 26 AV AUX (S VIDEO, VIDEO, L-AUDIO-R) jacks** - [15]
- 27 AV AUX key** - [16]
Use to switch the input to AV AUX.

Standby mode

While the standby indicator is lit, a small amount of power is supplied to the system to back up the memory. This is called standby mode. Under the condition, the system can be turned ON by remote control unit.

Connection at POWER ON/OFF key

The power in this equipment will not be completely cut off from the AC wall outlet when the main switch is turned OFF.

Remote control unit

This remote control unit can be used not only for Kenwood products but also for other non-Kenwood products by setting the appropriate manufacturer's setup codes. - [37]

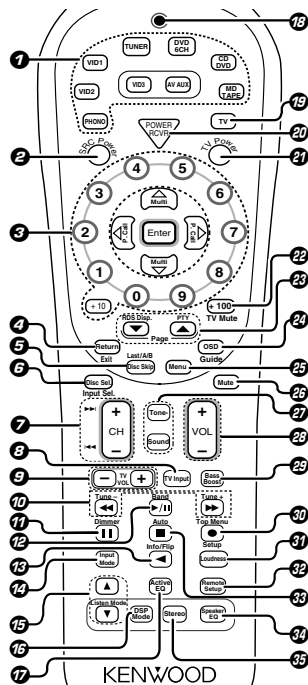

1 Source keys (MD/TAPE, CD/DVD, DVB/6CH, TUNER, VID1, VID2, VID3, AV AUX, PHONO) - [35]

When press and hold for more than 3 seconds, they are used to select the registered components.
Input Selector keys (MD/TAPE, CD/DVD, DVB/6CH, TUNER, VID1, VID2, VID3, AV AUX, PHONO) - [20]
 When press and release in less than 3 seconds, they are used to select the input sources.

2 SRC (source) Power key

Use to turn the other source components on or off.

3 Numeric keys - [25]

Provide functions identical to those of the original remote control supplied with the component you are controlling.

Multi (multi control) Δ/∇ keys - [17]

Use to control a variety of settings. Use to operate other components.

P.Call </> keys - [25]

Use for selection adjustments during sound, set up and preset channel functions.

Enter key

Use to operate other components.

4 Return key

Use to operate the DVD component.

Exit key

Use to operate other components.

5 Disc Skip key

If CD is selected as the input source, this key functions as the multi-CD player disc skip key.

Last/A/B key

If TAPE is selected as the input source, this is A and B deck of a double cassette deck.

Use to operate other components.

6 Disc Sel. key

Use to operate other components.

Input Sel. key

Use to operate other components.

7 CH +/- keys

Use to select the channels.

▶▶ / ◀◀ keys

If CD, MD and DVD is selected as the input source, these keys function as skip keys.

8 TV Input key

Use when in TV operation.

9 TV VOL +/- keys

Use to adjust the TV's volume.

10 ◀◀ / ▶▶ keys

If CD, MD or Tape is selected as the input source, this key functions as search keys.

Tune - / + keys

Use to operate the tuner mode.

11 II key

Use to operate other components.

Dimmer key

Use to adjust the brightness of the display. - [34]

12 ▶/II key

If CD is selected as the input source, this key functions as the play/pause key.

If MD or TAPE key is selected as input source, this key functions as the play key.

Band key - [24]

Use to select the broadcast band.

13 ◀ key

If Tape is selected, this key functions as reverse play key.

Info/Flip key

Use to operate other components.

14 Input Mode key - [8]

Use to switch between the full auto, digital and analog inputs.

15 Listen Mode ▲/▼ keys - [31]

Use to select the listening mode.

16 DSP Mode key - [31]

Use to select any of the DSP mode.

17 Active EQ key - [21]

Use to select ACTIVE EQ's setting.

18 LED (lighting-emitting diode) indicator

Blinks to show that signals are being transmitted.

19 TV key

Use to select the TV equipment.

20 POWER RCVR (receiver) key - [17]

Use to turn the receiver on or off.

21 TV Power key

Use to turn the TV on or off.

22 +100 key

Use to select the disc number with the multi-CD player.

TV Mute key

Use to temporarily mute the TV sound.

23 Page ▼/▲ key

Use to operate other components.

RDS Disp. key

Use to receive RDS broadcast. - [26]

PTY key

Use for PTY search. - [27]

24 OSD (on screen display) key

Use to operate the DVD component.

Guide key

Use to operate other components.

25 Menu key

Use to operate other components.

26 Mute key - [21]

Use to temporarily mute the sound.

27 Tone key - [21]

Use to switch the status of TONE control.

Sound key - [32]

Use to adjust the sound quality and the ambience effects.

28 VOL +/- keys - [20]

Use to adjust the receiver volume.

29 Bass Boost key - [21]

Use to select the maximum adjustment setting for the low frequency range.

30 ● key

If MD or Tape is selected, this key functions as record key.

If VCR is selected, this key functions as record key when it pressed twice sequentially.

Top Menu key

Use to operate the DVD component.

Setup key - [17]

Use to select the speakers' settings etc.

31 Loudness key - [21]

Use to switch the status of LOUDNESS.

32 Remote Setup key

Use to register other components.

33 ■ key

If CD, MD, or TAPE is selected as the input source, this key functions as the stop key.

Auto key - [24]

Use to select the auto or manual tuning mode.

34 Speaker EQ key - [21]

Use to select SPEAKER EQ's setting.

35 Stereo key - [32]

Use to switch the listen mode to STEREO.

If the name of a function is different on the receiver and on the remote control, the name of the remote control key in this manual is indicated in parentheses.

Setting up the system

Make connections as shown in the following pages. When connecting the related system components, be sure to refer to the instruction manuals supplied with the components you are connecting. Do not connect the power cord to a wall outlet until all connections are completed.

Notes

1. Be sure to insert all connection cords securely. If their connections are imperfect, sound may not be produced or there will be noise interference.
2. Be sure to remove the power cord from the AC outlet before plugging or unplugging any connection cords. Plugging/unplugging connection cords without disconnecting the power cord can cause malfunctions and may damage the unit.
3. Do not connect power cords from components whose power consumption is larger than what is indicated on the AC outlet at the rear of this unit.

Analog connections

Audio connections are made using RCA pin cords. These cables transfer stereo audio signal in an "analog" form. This means the audio signal corresponds to the actual audio of two channels. These cables usually have 2 plugs on each end, one red for the right channel and one white for the left channel. These cables are usually packed together with the source unit, or are available at your local electronics retailer.

Microcomputer malfunction

If operation is not possible or an erroneous display appears, even though all connections have been made properly, reset the microcomputer referring to "In case of difficulty". → 45

CAUTION

Be sure to adhere to the following, or proper ventilation will be blocked causing damage or fire hazard.

- Do not place any objects impairing heat radiation onto the top of the unit.
- Leave some space around the unit (from the largest outside dimension including projection) equal to or greater than, shown below.

Top panel : 50 cm Side panel : 10 cm Back panel : 10 cm

Input mode settings

CD/DVD, VIDEO 2 and DVD/6CH inputs each include jacks for digital audio input and analog audio input.

The initial factory settings for audio signal playback for CD/DVD, DVD/6CH and VIDEO 2.

After completing connections and turning on the receiver, follow the steps below.

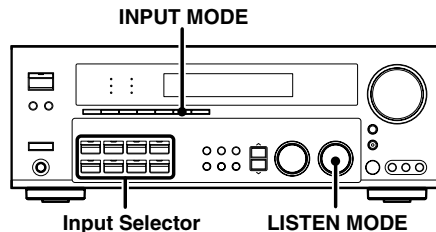

- 1 Use the Input Selector keys to select CD/DVD, VIDEO 2 or DVD/6CH.

- 2 Press the INPUT MODE key.

Each press switches the setting as follows:

In DTS play mode

- 1 FULL AUTO (digital input, analog input)
- 2 DIGITAL MANUAL (digital input)

In CD/DVD, VIDEO 2 or DVD/6CH play mode

- 1 FULL AUTO (digital input, analog input)
- 2 DIGITAL MANUAL (digital input)
- 3 6CH INPUT (DVD/6CH input)
- 4 ANALOG (analog input)

Digital input:

Select this setting to play digital signals from a DVD, CD, or LD player.

Analog input:

Select this setting to play analog signals from a cassette deck, VCR, or record player.

Auto detect:

In "FULL AUTO" mode (AUTO DETECT indicator light up), the receiver detects the digital or analog input signals automatically. Priority is given to digital signal during input mode selection. The receiver will select the input mode and listening mode automatically during playback to match the type of input signal (Dolby Digital, PCM, DTS) and the speaker setting. The OPTICAL and COAXIAL indicator on the display will light up when digital signal is detected. If the input signal is analog, the ANALOG indicator will light up.

To keep the receiver set to the currently selected listening mode, use the INPUT MODE key to select "DIGITAL MANUAL" (manual sound). However, even when this setting is selected, there may be cases in which the listening mode is selected automatically to match a Dolby Digital source signal depending on the combination of listening mode and source signal.

At DIGITAL MANUAL, if the audio reproduction stops in the middle due to change in the input signals, etc. press the LISTEN MODE knob.

If the INPUT MODE key is pressed quickly, sound may not be produced. Press the INPUT MODE key again.

Connecting the terminals

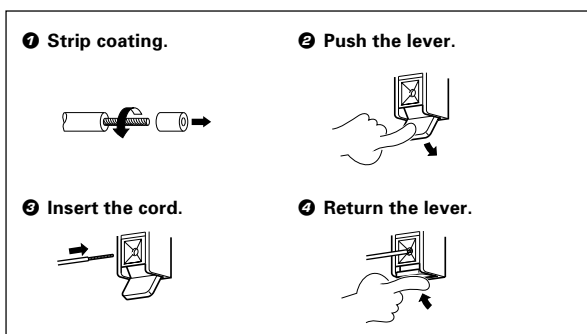
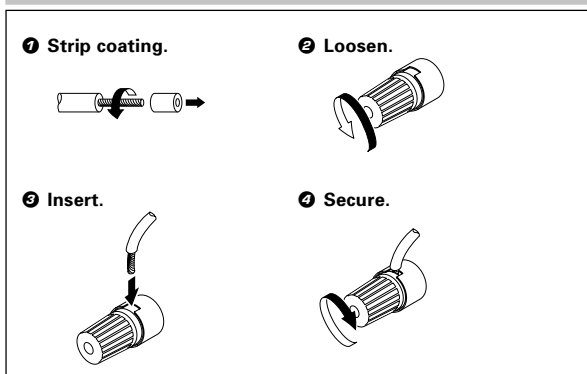

- Never short circuit the + and – speaker cords.
- If the left and right speakers are connected inversely or the speaker cords are connected with reversed polarity, the sound will be unnatural with ambiguous acoustic imaging. Be sure to connect the speakers correctly.

Speaker impedance

After confirming the speaker impedance indications printed on the rear panel of the receiver, connect speakers with matching impedance ratings. Using speakers with a rated impedance other than that indicated on the rear panel of the receiver could result in malfunctions or damage to the speakers or receiver.

Speaker placement

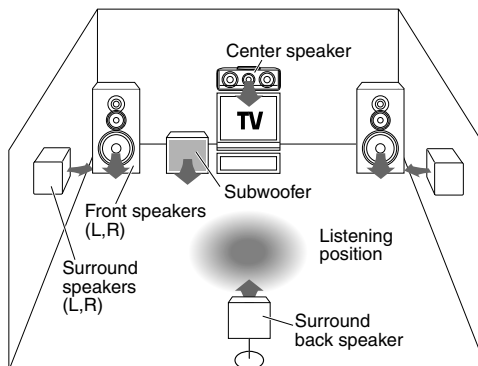

Front (left and right) speakers

Place at the front left and right of the listening position. Front speakers are required for all surround modes.

Center speaker

Place front and center. This speaker stabilizes the sound image and helps recreate sound motion. Required for surround playback.

Surround (left and right) speakers

Place at the direct left and right, or slightly behind, the listening position at even heights, approximately 1 meter above the ears of the listeners. These speakers recreate sound motion and atmosphere. Required for surround playback.

Subwoofer

Reproduces powerful deep bass sounds.

Surround back speaker

Place the speaker directly at the rear of the listening position. The optimum position depends mainly on the room condition.

- Although the ideal surround system consists of all the speakers listed above, if you don't have a center speaker or a subwoofer, you can divide those signals between the available speakers in the speaker settings steps to obtain the best possible surround reproduction from the speakers you have available. → 17

Connecting audio components

ENGLISH

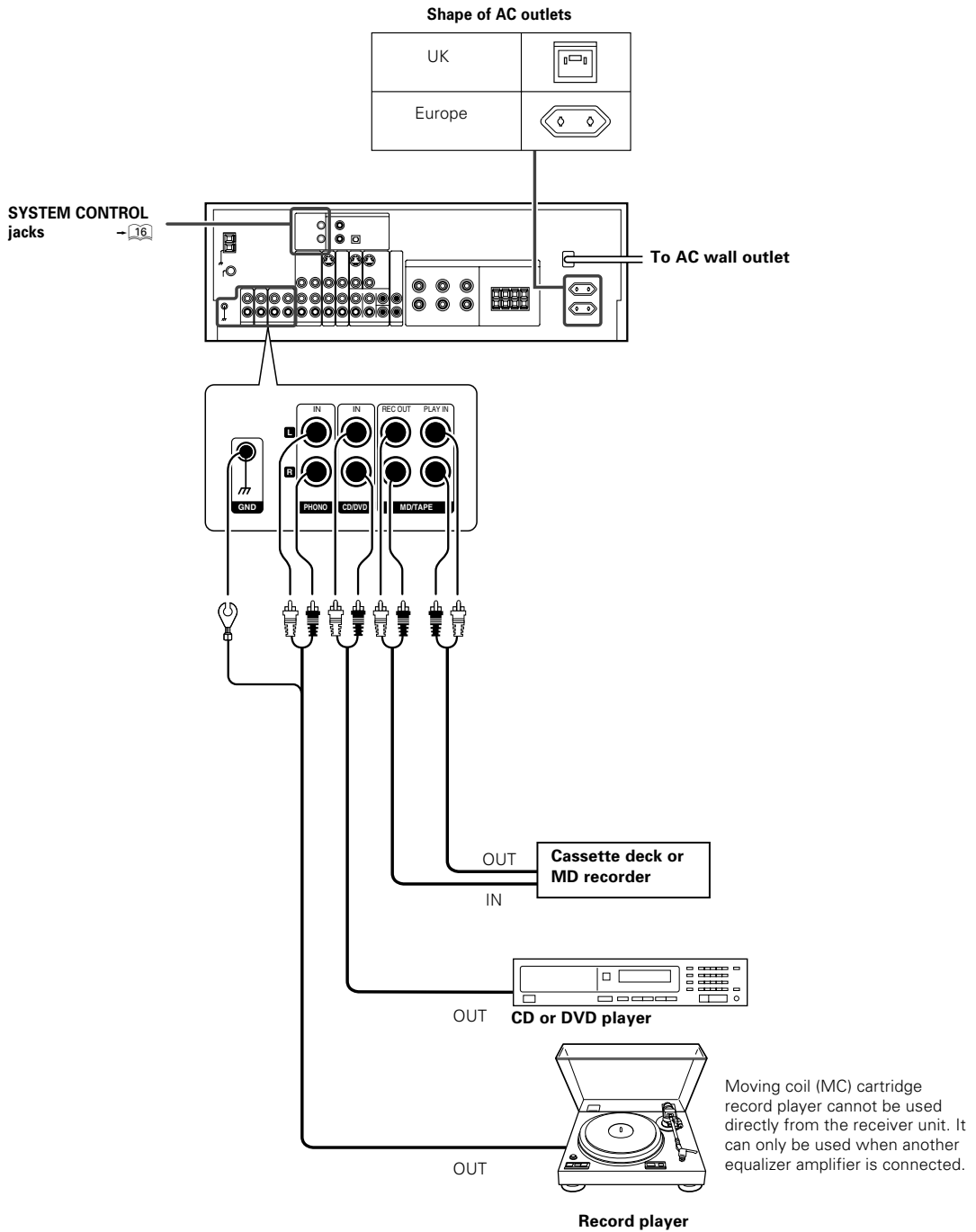

Connecting video components

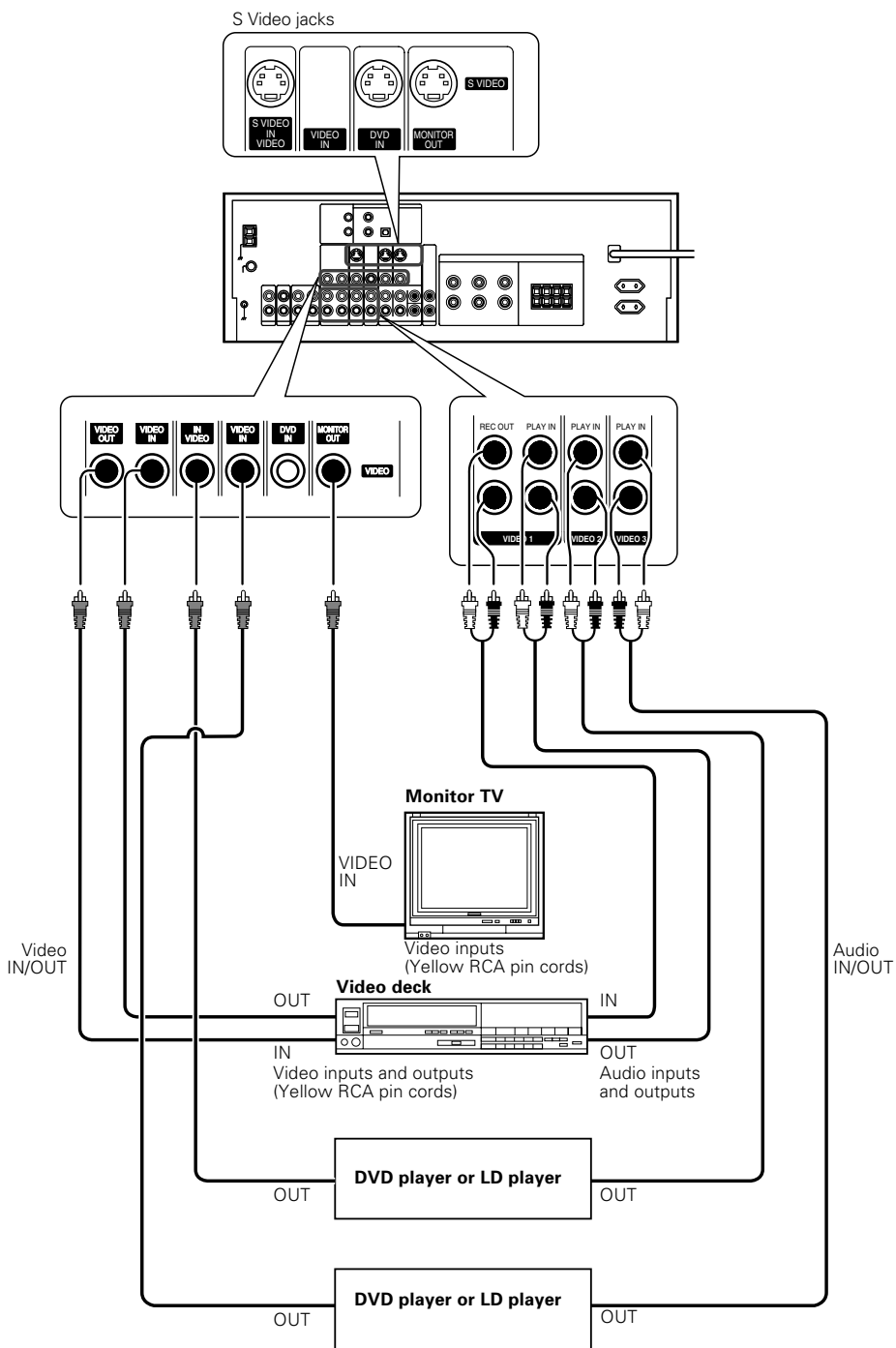

About the S VIDEO jacks

Use the S VIDEO jacks to make connections to video components with S VIDEO IN/OUT jacks.

- If you use the S VIDEO jacks to connect your video playback components, be sure to use the S VIDEO jacks when connecting your monitor and video recording components.

A video component with digital audio outputs should be connected to the VIDEO 2 jacks.

Digital connections

The digital in jacks can accept DTS, Dolby Digital, or PCM signals. Connect components capable of outputting DTS, Dolby Digital, or standard PCM (CD) format digital signals.

If you have connected any digital components to the receiver, be sure to read the "Input mode settings" section carefully.

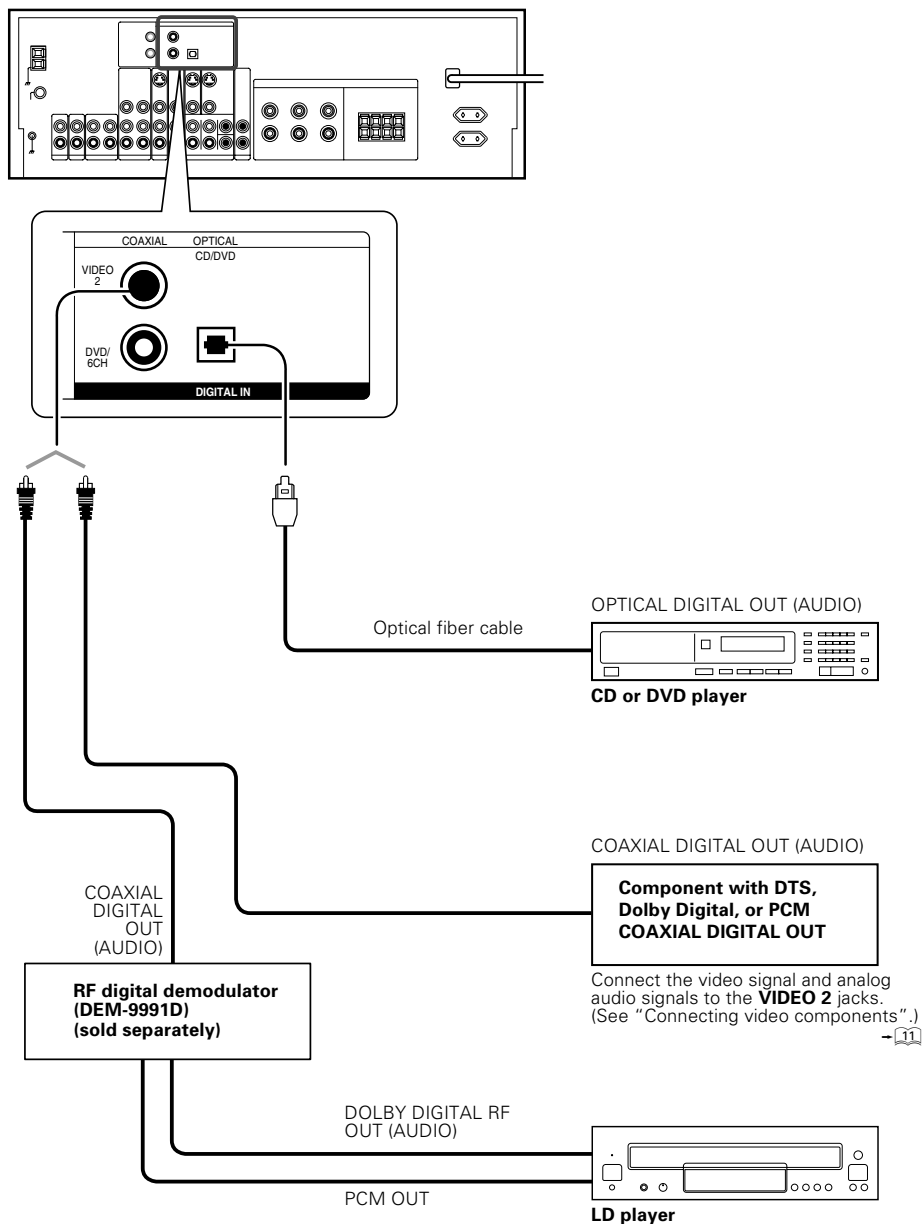

To connect an LD player with a DIGITAL RF OUT, connect the LD player to the KENWOOD RF digital demodulator (DEM-9991D). Next, connect the DIGITAL OUT jacks of the demodulator to the DIGITAL IN jacks of the receiver. Connect the video signal and analog audio signals to the VIDEO 2 jacks. (See "Connecting video components".)

Connecting a DVD player (6-channel input)

If you have connected a DVD player to the receiver with digital connection, be sure to read the "Input mode settings" section carefully.

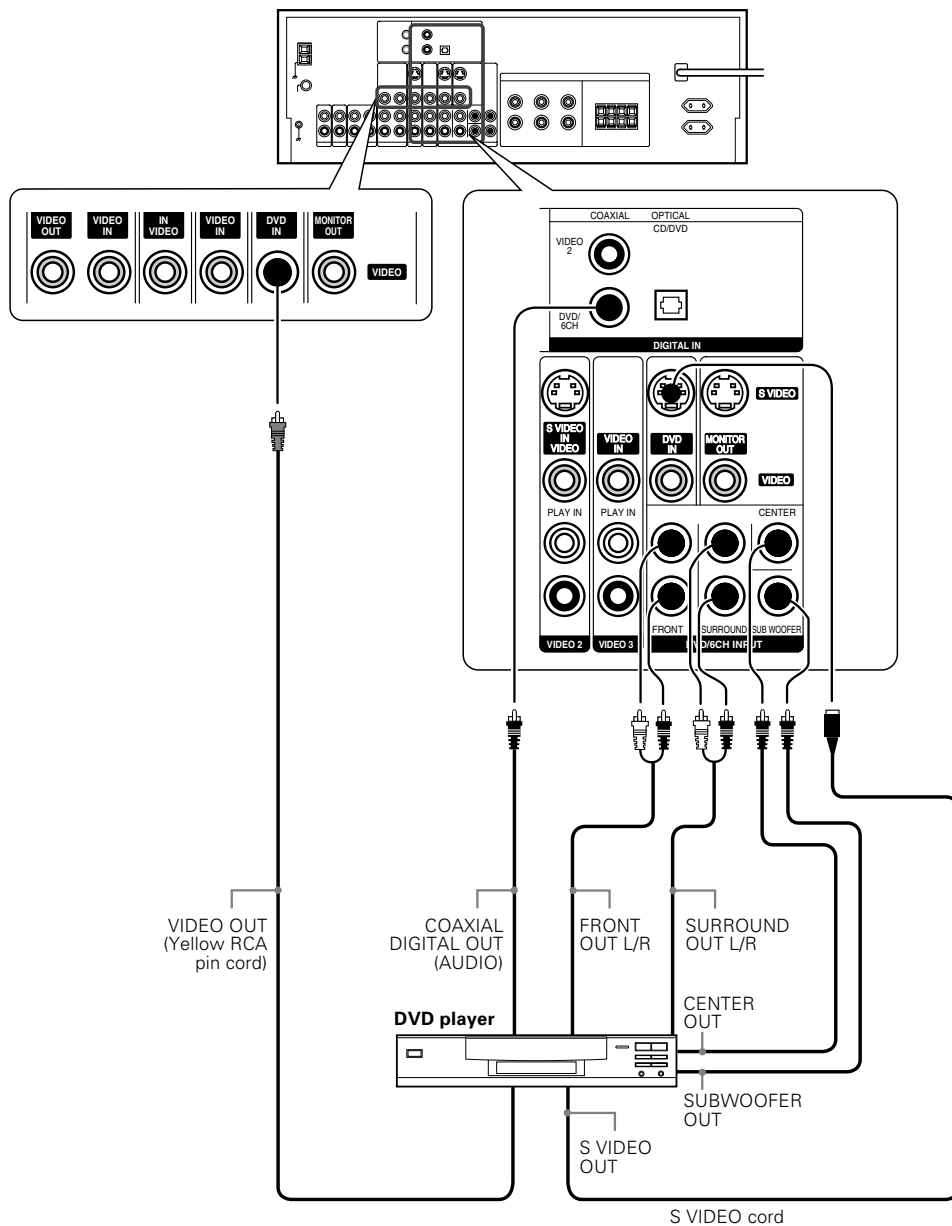

Connecting the speakers

ENGLISH

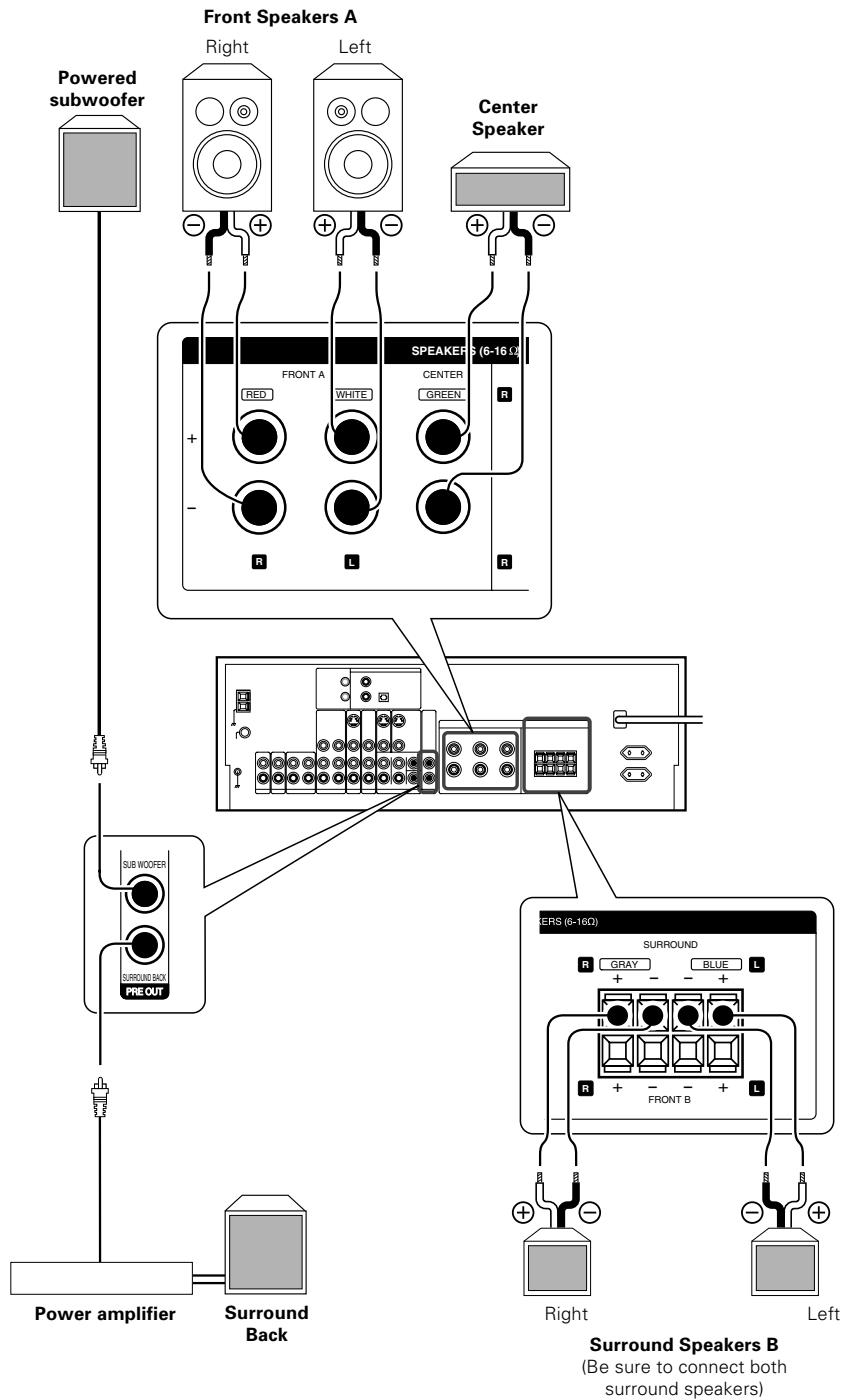

Use the **FRONT SPEAKERS B** terminals if you want to connect a second front speaker system.

Connecting to the AV AUX jacks

The **AV AUX** jacks are convenient for connection of video components such as a camcorder or a video game.

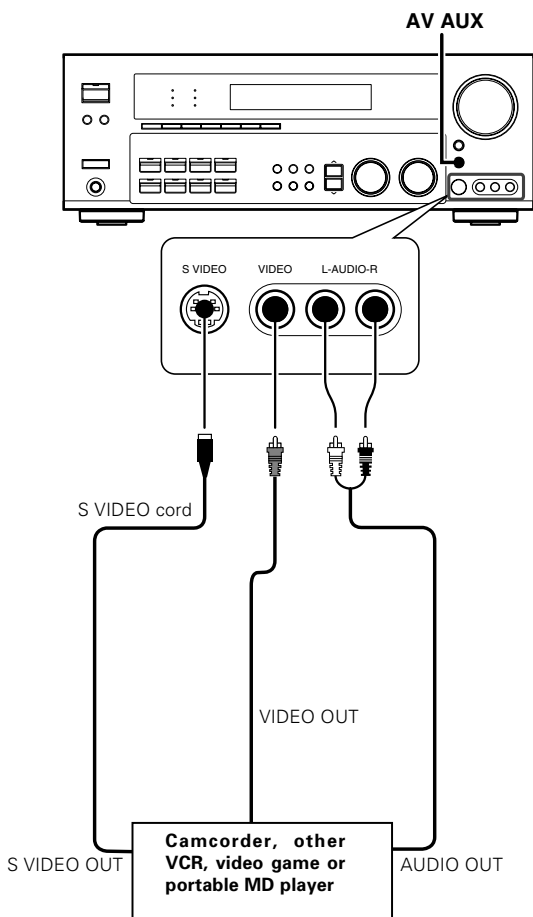

- To select the source connected to the AV AUX jacks press **AV AUX** key.
- When you connect the audio source such as the MD player, you do not need to connect the video cable.
- When you connect the unit and the component with the **S VIDEO** cord, you can get better picture quality.

Connecting the antennas

AM loop antenna

The supplied loop antenna is for use indoors. Place it as far as possible from the receiver, TV set, speaker cords and power cord, and adjust the direction for best reception.

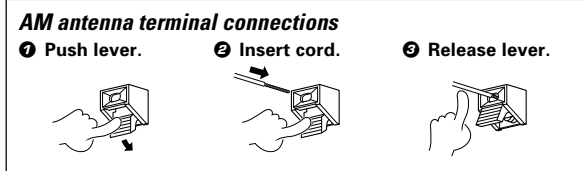

FM indoor antenna

The supplied indoor antenna is for temporary use only. For stable signal reception we recommend using an outdoor antenna. Disconnect the indoor antenna when you connect one outdoors.

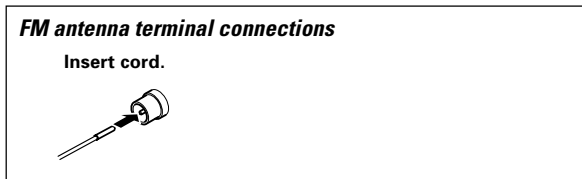

FM outdoor antenna

Lead the 75Ω coaxial cable connected to the FM outdoor antenna into the room and connect it to the FM 75Ω terminal.

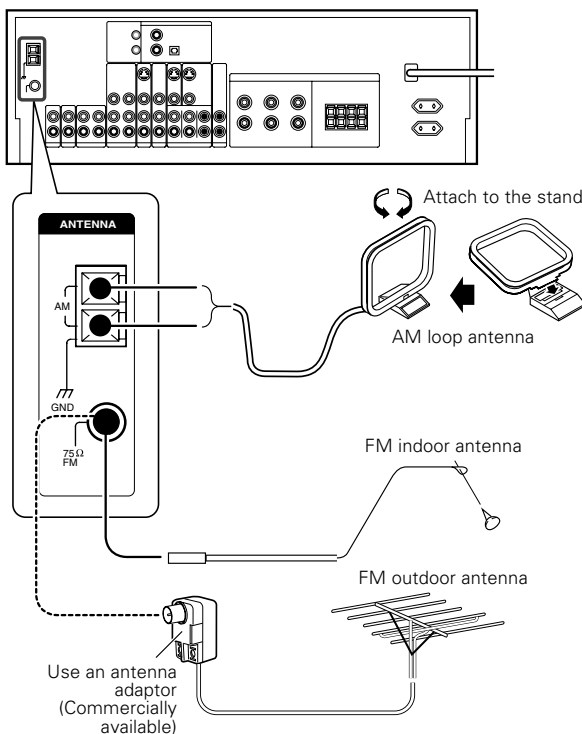

Connecting the system control

Connecting system control cords after connecting a KENWOOD audio component system lets you take advantage of convenient system control operations.

This unit is compatible only with the [SL-16] mode. The system control operation is not available if the unit is connected in the [XS8], [XS], or [XR] connection mode.

If your component has the mode select switch, set the connected components to the [SL16] mode.

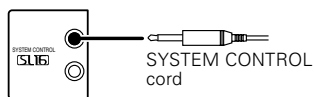

- You may connect the system control cord to either the up or down jack.

EXAMPLE: [SL16] mode connections

The underlined portion represents the setting of the system control mode.

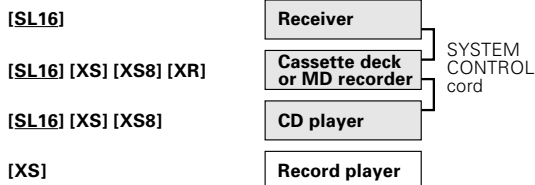

- In order to take advantage of the system control operations, the components must be connected to the correct jacks. To use a CD player it must be connected to the CD jacks. To use a cassette deck (or MD recorder) it must be connected to the MD/TAPE jacks. When using more than one CD player (etc.) only the one connected to the specified jacks may be connected for system control.
- Some CD players and cassette decks are not compatible with the [SL16] system control mode. Do not make system connections with equipment that is not [SL16] compatible.
- Some MD players are not system control compatible. You cannot make system control connections to this kind of equipment.

Notes

- [SL16] equipment cannot be combined with [XR], [XS], and [XS8] equipment for system operations. If your equipment consists of this kind of combination, please do not connect any system control cords. Even without system control cords, normal operations can be carried out without effecting performance.
- Do not connect system control cords to any components other than those specified by KENWOOD. It may cause a malfunction and damage your equipment.
- Be sure the system control plugs are inserted all the way in to the system control terminals.

SYSTEM CONTROL OPERATIONS

Remote Control

Lets you operate this unit with the system remote supplied with the receiver.

Automatic Operation

When you start playback from a source component, the input selector on this unit switches to that component automatically.

Synchronized Recording

Lets you synchronize recording with the start of playback when recording from CD, MD or analog discs.

Registering setup codes for KENWOOD audio components

If you own remote controllable KENWOOD audio components that are not compatible with system control, registering the setup code enables you to control those components using the remote control supplied with this unit (without connecting system control cords). To register setup codes for your remote controllable KENWOOD audio components, see "Registering setup codes for other components".

- 35 -

Preparing for surround sound

Speaker settings

To enable you to obtain optimum enjoyment from the receiver's listening modes, make sure to complete the speaker settings (subwoofer, front, center, and surround speakers) as described below.

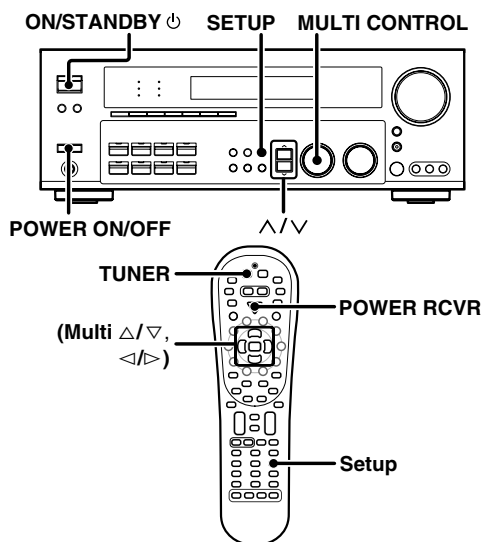

1 Turn on the power to this receiver by pressing the POWER ON/OFF and ON/STANDBY key or POWER RCVR key.

2 For the remote control, press and hold the TUNER key for more than 3 seconds to switch to receiver mode.

3 Press the SETUP key to enter the SETUP mode and press \wedge/\vee keys or \triangle/∇ keys for the following displays.

- ① SP SETUP
- ② TEST TONE
- ③ SP DISTANCE
- ④ DISP MODE
- ⑤ EXIT

The flow of the SET UP is as follows:

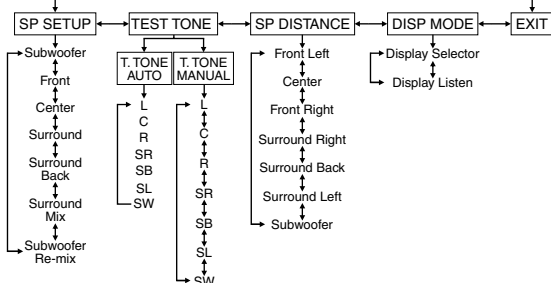

4 Select a speaker system.

① Select the SP SETUP and press the SETUP key again so that the subwoofer setting indication "SUBW ON" appears.

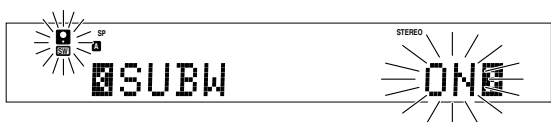

② Use the MULTI CONTROL knob or Multi (Δ/∇) keys to select the appropriate subwoofer setting.

- ① **SUBW ON** : Subwoofer setting mode to the receiver is ON.
- ② **SUBW OFF** : Subwoofer setting mode to the receiver is OFF.

- The initial setting is "SUBW ON".
- When the setting "SUBW OFF" is selected, the front speakers are automatically set to "FRNT LARGE" and the procedure skips to step ⑤.
- Before step ⑤, press the SETUP key to accept the setting.
- When subwoofer output sound is required, select "FRNT NORMAL", or select both "FRNT LARGE" and "SWRE-MIX ON".

③ Press the \wedge key or \triangleright key to accept the setting.

- The front speakers setting indication "FRNT" appears.

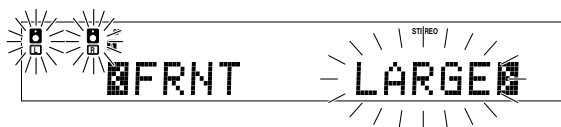

④ Use the MULTI CONTROL knob or Multi (Δ/∇) keys to select the appropriate front speakers setting.

- ① **FRNT LARGE** : Large front speakers are connected to the receiver.
- ② **FRNT NORMAL** : Average size front speakers are connected to the receiver.

- For "FRNT LARGE" selection, no sound will be heard from subwoofer speaker even when it is set to on. However, if you select "SW RE-MIX ON" when subwoofer is selected, you will be able to hear sound from the subwoofer.
- When in STEREO mode, the sound goes directly to front speaker.

⑤ Press the \wedge key or \triangleright key to accept the setting.

- The center speaker setting indication "CNTR" appears.

⑥ Use the MULTI CONTROL knob or Multi (Δ/∇) keys to select the appropriate center speaker setting.

If you selected "LARGE" as the front speakers setting,

- ① **CNTR LARGE** : A large center speaker is connected to the receiver.
- ② **CNTR NORMAL** : An average size center speaker is connected to the receiver.
- ③ **CNTR OFF** : Center speaker setting mode to the receiver is OFF.

If you selected "NORMAL" as the front speakers setting,

- ① **CNTR ON** : Center speaker setting mode to the receiver is ON.
- ② **CNTR OFF** : Center speaker setting mode to the receiver is OFF.

⑦ Press the \wedge key or \triangleright key again to accept the setting.

- The surround speaker indication "SURR" appears.

⑧ Use the MULTI CONTROL knob or Multi (Δ/∇) to select the appropriate surround speaker setting.

If you selected "LARGE" as the center speaker setting,

- ① **SURR LARGE** : Large surround speakers are connected to the receiver.
- ② **SURR NORMAL** : Average size surround speakers are connected to the receiver.
- ③ **SURR OFF** : Surround speaker setting mode to the receiver is OFF.

Continued to next page

If you selected other than "LARGE" as the center speaker setting,

- ➔ ① **SURR ON** : Surround speaker setting mode to the receiver is ON.
- ➔ ② **SURR OFF** : Surround speaker setting mode to the receiver is OFF.

• When the setting "SURR OFF" is selected, the procedure skips to step ④.

④ Press the \wedge key or \triangleright keys again to accept the setting.

• The surround speaker setting indication "SB" appears.

⑤ Use the MULTI CONTROL knob or Multi (Δ/∇) keys to select appropriate surround back speaker setting.

If you selected "LARGE" as the surround speaker setting,

- ➔ ① **SB NORMAL** : Average size surround back speaker is connected to the receiver.
- ➔ ② **SB LARGE** : Large surround back speaker is connected to the receiver.
- ➔ ③ **SB OFF** : Surround back speaker setting mode to the receiver is OFF.

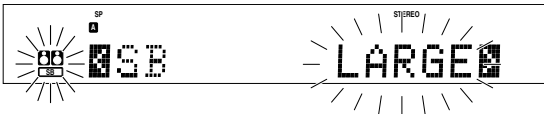

If you selected "NORMAL" as the surround speaker setting,

- ➔ ① **SB ON** : Surround back speaker setting mode to the receiver is ON.
- ➔ ② **SB OFF** : Surround back speaker setting mode to the receiver is OFF.

⑦ Press the \wedge key or \triangleright key again to accept the setting and "SURR:MIX" appears.

• Surr:mix is when the SL and SR speakers signals are mixed to produce sound from the surround back speaker which would enable the listener to enjoy sound coming from the back.

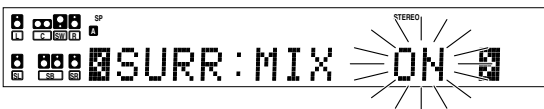

⑧ Use the MULTI CONTROL knob or Multi (Δ/∇) keys to select the following.

- ➔ ① **SURR:MIX ON** : Surround mix setting mode to the receiver is ON.
- ➔ ② **SURR:MIX OFF** : Surround mix setting mode to the receiver is OFF.

• If surround back speaker is turned off, SURR:MIX setting is not visible and the procedure skips to step ⑩.

⑩ Press the \wedge key or \triangleright key again to accept the setting.

• The subwoofer remix setting indication "SW RE-MIX" appears.

⑪ Use the MULTI CONTROL knob or Multi (Δ/∇) keys to select the appropriate subwoofer re-mix setting.

- ➔ ① **SW RE-MIX ON** : Subwoofer re-mix setting mode to the receiver is ON.
- ➔ ② **SW RE-MIX OFF** : Subwoofer re-mix setting mode to the receiver is OFF.

• If subwoofer is turned off, subwoofer re-mix setting is not visible.

⑫ Press the SETUP key again to return to the main setup displays.

- The receiver enters the speaker volume level adjustment mode.
- In steps ⑫ and ⑬, indications appear only for the selected channels of the speakers that require adjusting.

5 Adjust the speaker volume level.

From your usual listening position, adjust the volume levels. The volume levels from each speaker should be the same.

① Press the \wedge/∇ keys or $\triangleleft/\triangleright$ keys to select TEST TONE.

② Press the SETUP key for the following displays:

- ➔ ① T.TONE AUTO
- ➔ ② T.TONE MANUAL

③ The selection of AUTO/MANUAL TEST TONE is done by the MULTI CONTROL knob or Multi (Δ/∇) keys. Press the SETUP key again to begin TEST TONE.

Use the MULTI CONTROL knob or Multi (Δ/∇) keys to adjust the volume level of the test tone output from the speaker channel to be adjusted.

For AUTO selection, the first test tone is heard from the front left speaker for 2.5 seconds. The next test tone is heard from the speakers in the following sequence for 2 seconds each.

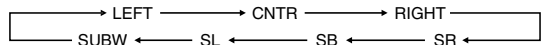

The channel indication blinks while the test tone is being output.

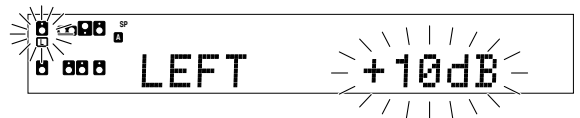

- If you change the volume level settings for the speakers while listening to music, the settings referred to on this page are also changed. → ⑬
- If the speaker setting selects are OFF, the speaker level settings are reset.

For MANUAL selection, press the \wedge/∇ keys or $\triangleleft/\triangleright$ keys each time to select the speaker channel.

④ Press the SETUP key again.

• The test tone is turned off and return to the main setup displays.

6 Input the distance to the speakers.

① Press the \wedge/∇ keys or $\triangleleft/\triangleright$ keys to select the SP DISTANCE on setup displays and press the SETUP key again.

② Measure the distance from the listening position to each of the speakers.

jot down the distance to each of the speakers.

- Distance to Front left speaker (L) : ___ feet (meters)
- Distance to Center speaker (C) : ___ feet (meters)
- Distance to Front right speaker (R) : ___ feet (meters)
- Distance to Surround right (SR) : ___ feet (meters)
- Distance to Surround back (SB) : ___ feet (meters)
- Distance to Surround left (SL) : ___ feet (meters)
- Distance to Subwoofer (SW) : ___ feet (meters)

- 6 Use the \wedge/\vee keys or \triangle/∇ keys to select the speakers and the MULTI CONTROL knob or Multi (\triangle/∇) keys to adjust the distance to the front speakers.

The speaker indicator to be adjusted blinks.

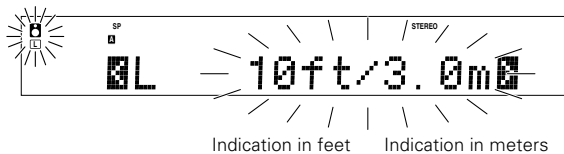

Indication in feet Indication in meters

- The allowable setting range is 1 to 30 feet (0.3 to 9.0 m), adjustable in 1 foot (0.3 m) increments.
- 7 Repeat steps 6 to input the distance for each of the speakers.
- 8 Press the SETUP key again to return to main setup displays.
 - The speakers you have selected should appear on the display. Confirm that all the speakers have been correctly selected.

7 Select the display mode.

- 1 Press the \wedge/\vee key or \triangle/∇ keys to select the DISP MODE.
- 2 Press the SETUP key for the following displays:
 - 1 DISP SELECTOR : Displays the current input selector.
 - 2 DISP LISTEN : Displays the current listen mode.
- 3 Use the MULTI CONTROL knob or Multi (\triangle/∇) keys to select the display mode.



- 4 Press the SETUP key again to accept the setting.
- 5 Use the \wedge key or \triangleright key to select EXIT.



- 6 Press the SETUP key to exit the SET UP mode.

Input level adjustment (analog sources only)

If the input level of an analog source signal is too high, the CLIP indicator will blink to indicate the source signal. Adjust the input level.



- 1 Use the Input Selector keys to select the source of which the input level you want to adjust.
 - You can store a separate input level for each input source.
- 2 Press the SOUND and \wedge/\vee keys or \triangle/∇ keys repeatedly until the "INPUT" indication appears.
- 3 Use the MULTI CONTROL knob or Multi (\triangle/∇) keys to adjust the input level.



- The adjustment mode is displayed for approximately 8 seconds.
- The input level may be adjusted to any one of three settings: 0dB, -3dB, and -6dB. (The initial setting is 0dB.)
- 4 Press the SOUND key again to return to the input indication.

Normal playback

Preparing for playback

Some preparatory steps are needed before starting playback.

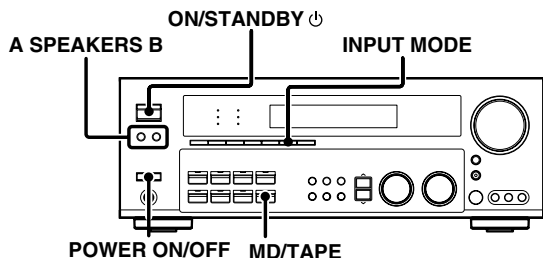

ENGLISH

Turning on the receiver

- 1 Turn on the power to the related components.
- 2 Turn on the power to this receiver by pressing the **POWER ON/OFF** and **ON/STANDBY** key.

Selecting the input mode

If you have selected a component connected to the **CD/DVD**, **VIDEO 2** or **DVD/6CH** jacks, make sure that the input mode setting is correct for the type of audio signal to be used.

Selecting MD/TAPE

Select the source name corresponding to the component connected to the MD/TAPE jacks. The initial factory setting is "TAPE". To change the source to "MD", follow the steps below:

Hold down the MD/TAPE key for more than 2 seconds.

- The source indication changes to "MD".
- To return to the original indication, repeat the above procedure.

Selecting the speaker system

Press the **A SPEAKERS B** key to select the speaker system to be used.

- A ON** : Sound from the speakers connected to the **SPEAKERS A** terminals on the rear panel.
- B ON** : Sound from the speakers connected to the **SPEAKERS B** terminals on the rear panel. No sound will be heard from the subwoofer.
- A+B ON** : Sound from both the speakers connected to the **SPEAKERS A** and **B** terminals on the rear panel.
- A+B OFF** : No sound from the speakers. Use this setting when listening with headphones for stereo sound in all playback modes. The display segments are different depending on the type of input signal.

The indicator for the speakers you want to use should be lit.

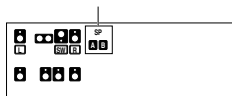

- Selecting "6CH INPUT" by pressing the **INPUT MODE** key, whereby "DVD/6CH" is the input source will cause **SPEAKERS A** to be selected automatically.

Listening to a source component

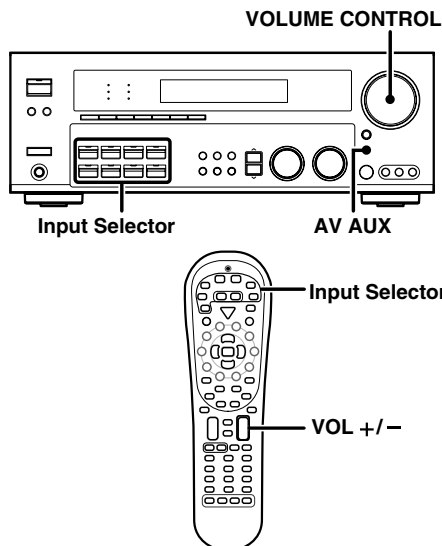

- 1 Use the **Input Selector** and **AV AUX** keys to select the source you want to listen to.

Selecting a source using each key.

- 1 "DVD/6CH"
- 2 "CD/DVD"
- 3 "PHONO"
- 4 "TUNER"
- 5 "VIDEO 1"
- 6 "VIDEO 2"
- 7 "VIDEO 3"
- 8 "MD/TAPE"
- 9 "AV AUX"

- 2 Start playback from the selected source.

- 3 Use the **VOLUME CONTROL knob** or **VOL +/- keys** to adjust the volume.

Adjusting the sound

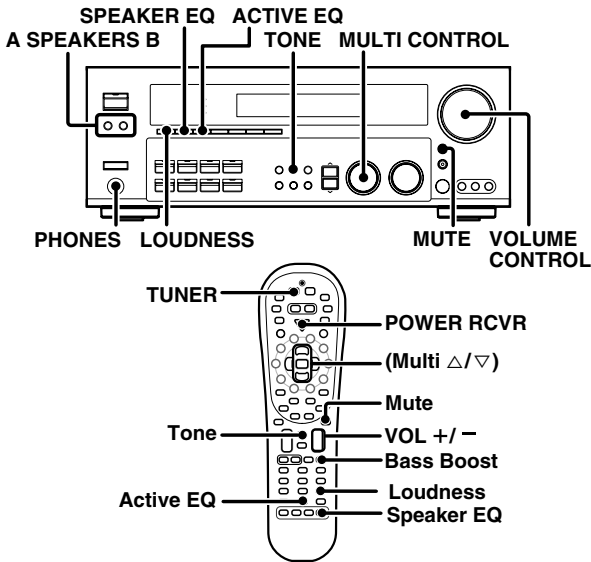

Adjusting the TONE

You can adjust the sound quality when the receiver is in the PCM stereo and analog stereo mode.

- 1 For the remote control, press and hold the TUNER key for more than 3 seconds to switch to receiver mode.
- 2 Press the TONE key to select the TONE mode.
- 3 Use the MULTI CONTROL knob or Multi (Δ/▽) keys to select TONE ON/OFF.

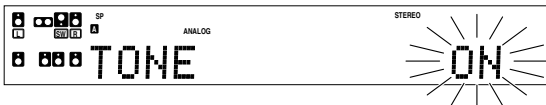

- 4 When in TONE ON selection, press the TONE key for the following displays.

BASS : Select this to adjust the low frequency range.
TREBLE: Select this to adjust the high frequency range.

- 5 Use the MULTI CONTROL knob or Multi (Δ/▽) keys to adjust the sound quality.

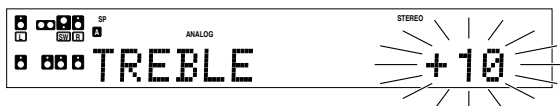

- The bass and treble levels are adjustable from -10 to +10 in 2 step increments.
- The adjustment item is displayed for approximately 8 seconds.

Once-touch low frequency emphasis (BASS BOOST) (remote control only)

You can adjust the sound quality when the receiver is in the PCM stereo and analog stereo modes.

Press the Bass Boost key.

- Press the key once to select the maximum (+10) low frequency emphasis setting.
- This key does not function when the receiver is in the sound quality or ambience effects adjustment mode.

Switching back to the previous setting

Press the Bass Boost key again.

Adjusting the LOUDNESS mode

You can adjust the Loudness function which controls the low volume settings to maintain the music's richness. The adjustment can be made when the receiver is in the PCM stereo and analog stereo mode.

Press the LOUDNESS key to turn the LOUDNESS setting ON.

To cancel

Press the LOUDNESS key again so that the "LOUDNESS" indicator goes off.

Muting the sound

The MUTE key lets you mute the sound of the speakers.

Press the MUTE key.

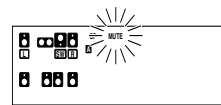

Blinks

To cancel

Press the MUTE key again so that the "MUTE" indicator goes off.

- MUTE ON can also be deactivated by turning the VOLUME CONTROL knob or pressing VOL +/- keys.

ACTIVE EQ mode

You can enjoy a more impressive sound effect when ACTIVE EQ is turned ON during Dolby Digital and DTS playback and, when in PCM and analog stereo mode.

Press the ACTIVE EQ key for the following selections;

- 1 **ACTIVE EQ MUSIC** : Effective when listening to music. (The ACTIVE EQ indicator lights up.)
- 2 **ACTIVE EQ CINEMA** : Effective when watching a movie. (The ACTIVE EQ indicator lights up.)
- 3 **ACTIVE EQ TV** : Effective when watching TV. (The ACTIVE EQ indicator lights up.)
- 4 **ACTIVE EQ OFF** : The ACTIVE EQ function is turned OFF. (The ACTIVE EQ indicator goes off.)

- "ACTIVE EQ" will scroll from right to left.
- When ACTIVE EQ and SPEAKER EQ are OFF and ACTIVE EQ (MUSIC) is turned ON, SPEAKER EQ (SMALL) will turn ON automatically.
- ACTIVE EQ function will not be available when REC MODE, AUTO TUNING or PRESET MEMORY is ON, and during 96kHz LPCM playback.

SPEAKER EQ mode

SPEAKER EQ function is to adjust the receiver's audio output characteristics with the speakers' characteristics which differs depending on the size of the speakers. Especially for the music sound source playback, the reproduced sound becomes more natural when adjusting the output characteristics. When activating the SPEAKER EQ function, you will be able to enjoy a more natural and dynamic sound experience even with small size speakers.

Press the SPEAKER EQ key to switch the following setting;

- ① **SPEAKER EQ SMALL** : To select a small size speaker.
(The SPEAKER EQ indicator lights up.)
- ② **SPEAKER EQ NORMAL** : To select an average size speaker.
(The SPEAKER EQ indicator lights up.)
- ③ **SPEAKER EQ LARGE** : To select a large size speaker.
(The SPEAKER EQ indicator lights up.)
- ④ **SPEAKER EQ OFF** : The SPEAKER EQ function is turned OFF.
(The SPEAKER EQ indicator goes off.)

- "SPEAKER EQ" will scroll from right to left.
- SPEAKER EQ cannot be turned OFF when ACTIVE EQ is turned ON.
- SPEAKER EQ function will not be available when REC MODE, AUTO TUNING or PRESET MEMORY is ON, and during 96kHz LPCM playback.

Listening with headphones

- ① **Press the A and B Speaker keys so that the speaker indicator goes off.**

Make sure the SPEAKERS indicators are turned off.



- If you turn off all of the speakers when in surround mode, the surround mode will be cancelled as well, resulting in stereo playback.

- ② **Connect headphones to the PHONES jack.**

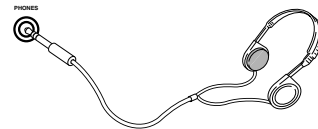

- ③ **Use the VOLUME CONTROL knob or VOL +/- keys to adjust the volume.**

Recording

Recording audio (analog sources)

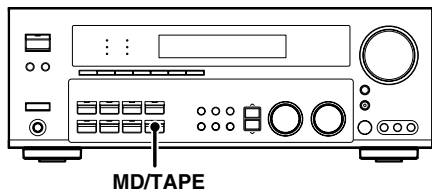

Recording a music source

- 1 Use the Input Selector keys to select the source (other than "MD/TAPE") you want to record.
- 2 Set the MD or TAPE recorder to record.
- 3 Start playback, then start recording.

Recording video

- 1 Use the Input selector keys to select the video source (other than "VIDEO 1") you want to record.
- 2 Set the video deck connected to VIDEO 1 to record.
 - Select the REC MODE to record a digital input source.
- 3 Start playback, then start recording.
 - Recording may not be normal for some video software. This is due to the copy guard condition. - [45]

Recording audio (digital sources)

Switch on the **REC MODE** to record a digital input source. Usually use the **AUTO REC MODE** to record audio input sources. When the digital mode changes during recording in the **AUTO REC MODE**, the audio input source may be interrupted momentarily.

Recording music in AUTO REC or MANUAL REC mode

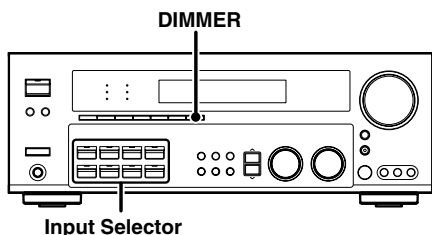

- 1 Use the Input Selector keys to select the source (CD/DVD, DVD/6CH, VIDEO 2) you want to record.
- 2 Set the MD or TAPE recorder to record.

- 3 Press and hold the **DIMMER** key for more than 2 seconds to select the **AUTO REC** or **MANUAL REC** mode.

- 1 **REC MODE off** : The digital input record mode is switched off.
- 2 **AUTO REC mode** : The digital input signals (DTS, Dolby Digital, or PCM) are identified automatically and converted into stereo signals that are ready for recording.
- 3 **MANUAL REC mode** : The input signal type at the moment this mode is selected is held throughout this mode.

For **AUTO REC** mode :

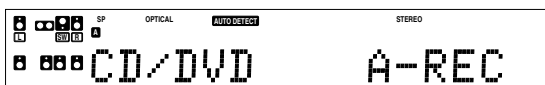

For **MANUAL REC** mode :

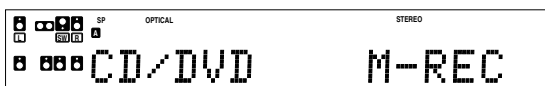

- 3 Start playback, then start recording.

- If the audio reproduction stops in the middle due to change in the input signals, etc., press the **DIMMER** key.

Listening to radio broadcasts

The receiver can store up to 40 stations in the memory and recall them by one-touch operation.

Radio stations can be classified into RDS (Radio Data System) stations and other stations. To listen to or store RDS stations in the preset memory see "Using RDS (Radio Data System)".

Tuning radio stations

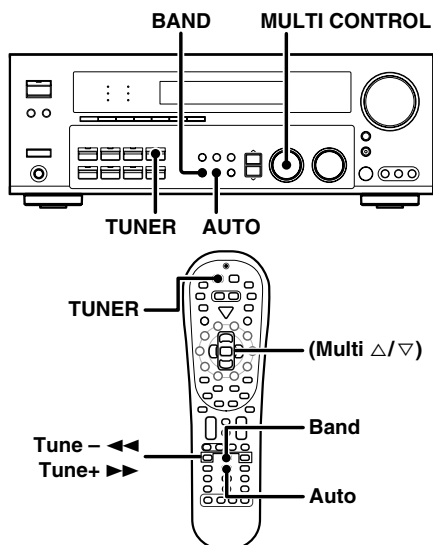

1 Use the TUNER key to select the tuner.

2 Use the BAND key to select the desired broadcast band.

Each press switches the band.



3 Use the AUTO key to select the desired tuning method.

Each press switches the tuning method to either auto or manual tuning.

"AUTO" indicator lights up in the display.

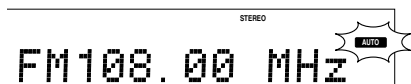

- Normally, set to "AUTO" (auto tuning). If the radio waves are weak and there is a lot of interference, switch to manual tuning. (With manual tuning, stereo broadcasts will be received in monaural.)

4 Use the MULTI CONTROL knob or Multi (Δ/▽) keys, or Tune - <</> / + >> keys to select the station.

"STEREO" lights when a broadcast is being received in stereo.

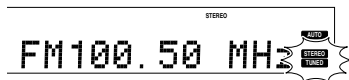

"TUNED" is displayed when a station is received.

Auto tuning : The next station is tuned automatically.

Manual tuning : Turn the knob or use the Multi (Δ/▽) keys to select the desired station.

Using RDS (Radio Data System)

RDS is a system that transmits useful information (in the form of digital data) for FM broadcasts along with the broadcast signal. Tuners and receivers designed for RDS reception can extract the information from the broadcast signal for use with various functions, such as automatic display of the station name.

RDS functions:

PTY (Program Type Identification) Search

- [27]

Automatically tunes to a station that is currently broadcasting the specified program type (genre).

PS (Program Service Name) Display

Automatically displays the station name transmitted by the RDS station.

RDS AUTO MEMORY function

- [26]

Automatically selects and stores up to 40 RDS stations in the preset memory. If fewer than 40 RDS stations have been stored in the preset memory, regular FM stations will be stored in the remaining places.

Radio Text function

Displays the radio text data transmitted by some RDS stations when you press the **RDS DISP** (display) key. There is "NO RT" if no text data is transmitted.

The "RDS" indicator lights up when an RDS broadcast (signal) is received.

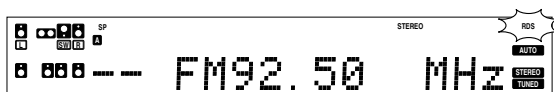

Note

Some functions and function names may differ for certain countries and areas.

Before using a function utilizing the RDS, be sure to perform the RDS Auto Memory operation by referring to the description in "Presetting RDS stations (RDS AUTO MEMORY)".

- [26]

Presetting radio stations manually

The RDS auto memory function assigns preset numbers to RDS stations starting from preset number "1". Therefore, be sure to execute the RDS auto memory function before using the following operations to manually store AM stations and other FM stations, and RDS stations. See "Presetting RDS stations (RDS AUTO MEMORY)".

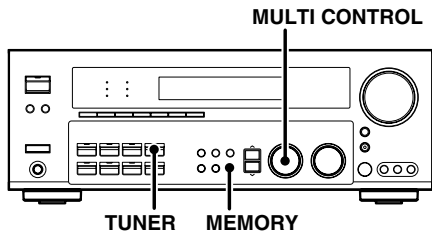

- 1** Tune to the station you want to store.
- 2** Press the **MEMORY** key while receiving the station.

Blinks for 5 seconds Lights for 5 seconds

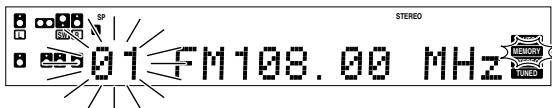

Proceed to step **3** within 5 seconds.
(If more than 5 seconds elapse, press the **MEMORY** key again).

- 3** Use the **MULTI CONTROL** knob or **Multi** (Δ/∇) keys to select one of the station presets (1 – 40).
- 4** Press the **MEMORY** key again to confirm the setting.
 - Repeat steps **1**, **2**, **3**, and **4** to store as many stations as necessary.
 - If you store a station at a previously used preset, the old station will be replaced by the new one.

Receiving preset stations

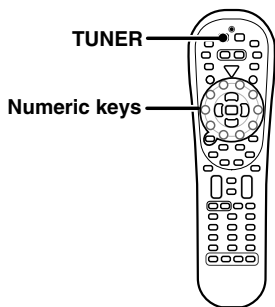

- 1** Press the **TUNER** key to select tuner as the source.

- 2** Enter the number of the preset station you want to receive (up to "40").

Press the numeric keys in the following order:

For "15", press $\boxed{+10}$, $\boxed{5}$
 For "20", press $\boxed{+10}$, $\boxed{+10}$, $\boxed{0}$

- If you make a mistake entering a two digit number, press the **+10** key repeatedly to return to the original display and start again.

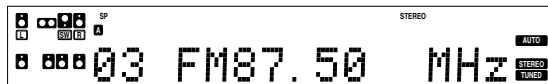

Receiving preset stations in order (P.CALL)

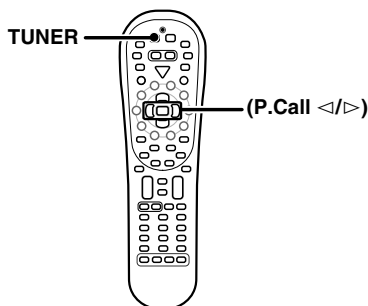

- 1** Press the **TUNER** key to select the tuner as the source.
- 2** Use the **P.Call** $\triangleleft/\triangleright$ keys to select the desired station.

- Each time you press the key, another preset station is received in order.

Pressing the **P.Call** \triangleright does the following:

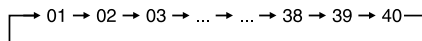

Pressing the **P.Call** \triangleleft does the following:

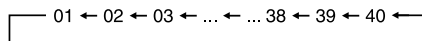

Holding down the \triangleright or \triangleleft keys, lets you skip through the presets, receiving each preset station at 0.5 second intervals.

Using the RDS DISP (Display) key

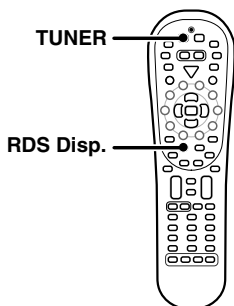

Pressing the RDS Disp. key changes the contents of the display.

Each press switches the display mode as follows :

- ① PS (Program Service name) display
- ② RT (Radio Text) display
- ③ Frequency display

① **PS (Program Service name) display :**

The station name is displayed automatically when an RDS broadcast is received. If no PS data was sent, "NO PS" is displayed.



② **RT (Radio Text) display :**

Text data accompanying the RDS broadcast scrolls across the display. "NO RT" is displayed if the current RDS station does not provide RT data.

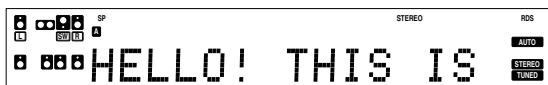

③ **Frequency display :**

Displays the frequency of the current station.

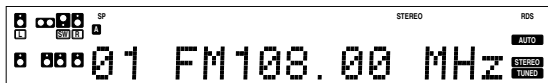

Presetting RDS stations (RDS AUTO MEMORY)

This function automatically stores up to 40 RDS stations in the preset memory. In order to use the PTY function, the RDS stations must be stored in the preset memory using the RDS AUTO MEMORY function.

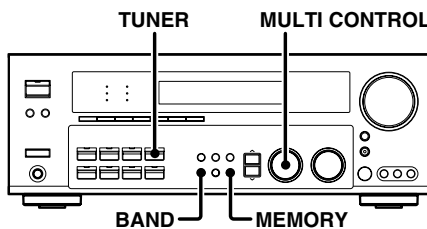

1 Press the **TUNER** key to enter tuner mode.

2 Use the **BAND** key to set the broadcast band to "FM".

3 Press the **MEMORY** key continuously for more than 3 seconds will start **AUTO MEMORY**.

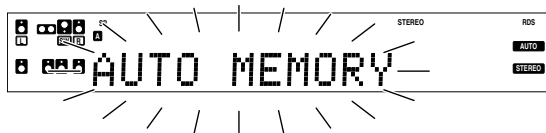

- After a few minutes, up to 40 RDS stations are preset in order from channel "01".
- Stations already stored in the preset memory may be replaced by RDS stations. (i.e., If the RDS AUTO MEMORY function detects 15 RDS stations, the stations currently preset at numbers 01~15 will be replaced by the RDS stations.)

Tuning by Program Type (PTY search)

This function lets you set the tuner to automatically search for stations which are currently broadcasting the type of program (genre) you want to listen to.

Under certain receiving conditions, it may take more than 1 minute to complete the search.

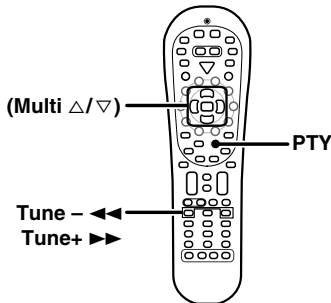

Preparations

- Execute the RDS auto memory procedure.
- Set the broadcast band to FM.
- Tune to an RDS station.

1 Press the PTY key to activate the PTY search mode.



When an RDS broadcast is received, the program type is shown on the display. If no PTY data is available, or if the station is not an RDS station, "NONE" is displayed.

2 While the "PTY" indicator is lit, use the Multi (Δ/▽) keys or Tune - ◀◀ /+ ▶▶ keys select the program type of your choice.

Program type table

Program Type Name	Display	Program Type Name	Display
Pop Music	POP M	Weather	WEATHER
Rock Music	ROCK M	Finance	FINANCE
Easy Music	EASY M	Children's Program	CHILDREN
Light Classical Music	LIGHT M	Social Affairs	SOCIAL
Serious Classical Music	CLASSICS	Religion	RELIGION
Other Music	OTHER M	Phone In	PHONE IN
News	NEWS	Travel	TRAVEL
Current Affairs	AFFAIRS	Leisure	LEISURE
Information	INFO	Jazz Music	JAZZ
Sport	SPORT	Country Music	COUNTRY
Education	EDUCATE	National Music	NATION M
Drama	DRAMA	Oldies Music	OLDIES
Culture	CULTURE	Folk Music	FOLK M
Science	SCIENCE	Documentary	DOCUMENT
Varied Speech	VARIED		

"NO PROGRAM" is displayed if this operation is attempted before performing the RDS Auto Memory operation.

3 Press the PTY key to start searching.

EXAMPLE : Searching for a Pop Music broadcast.

Display while searching.

Blinks



Program type name display

Display when a station is received.

Goes out



Station name display

- No sound is heard while "PTY" is blinking.
- If the desired program type cannot be found, "NO PROGRAM" is displayed, then after several seconds the display returns to the original display.

To select another program type.

Repeat steps 1, 2 and 3.

Ambience effects

This receiver is equipped with listening modes that allow you to enjoy an enhanced sonic ambience with a variety of video sources.

In order to obtain the optimum effect from the surround modes, make sure to input the proper speaker settings beforehand.

- 17

Surround modes

ENGLISH

The below speaker placements are for 5.1 channel surround sound system which are;

- Dolby Digital
- Dolby Pro Logic II
- DSP
- DVD 6-channel
- DTS

The below speaker placements are for 6.1 channel surround sound system which are;

- Dolby Digital EX
- SRS Circle Surround II
- Dolby Digital, Dolby Pro logic II and DSP if "SURR: MIX ON" → 18

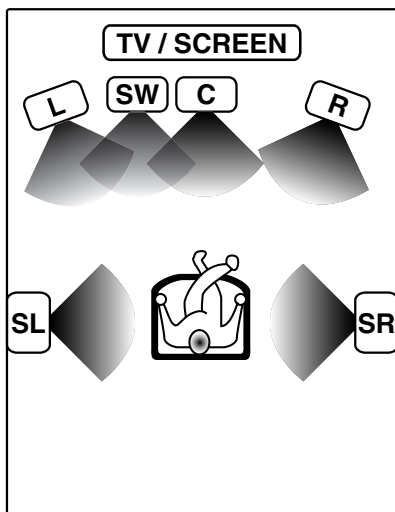

No Surround Back speaker

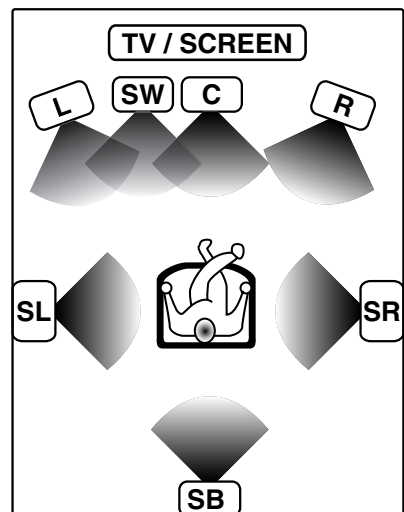

Surround Back speaker

- L** Front left speaker
- SW** Subwoofer
- C** Center speaker
- R** Front right speaker

- SL** Surround left speaker
- SR** Surround right speaker
- SB** Surround back

Manufactured under license from Dolby Laboratories. "Dolby", "Pro Logic" and the double-D symbol are trademarks of Dolby Laboratories.

Circle Surround II, SRS and (O) symbol are trademarks of SRS Labs, Inc. Circle Surround II technology is incorporated under license from SRS Labs, Inc.



"DTS" and "DTS Digital Surround" are registered trademarks of Digital Theater Systems, Inc.



Dolby Digital

The Dolby Digital surround format lets you enjoy up to 5.1 channels of digital surround sound from Dolby Digital program sources (such as Laserdisc or DVD software marked ). Compared with previous Dolby surround, Dolby Digital provides even better sound quality, greater spatial accuracy, and improved dynamic range.

Although a full set of speakers (front left, right, and center, surround left and right, and a subwoofer) is required for true 5.1 channel Dolby Digital surround sound, this receiver lets you enjoy Dolby Digital (and Dolby Surround) program sources, even if you connect only the front speakers.

Dolby Digital EX

Dolby Digital EX is an extension of Dolby Digital technology, Dolby Digital EX creates six full-bandwidth output channels from 6.1-channel sources. This is done using a matrix decoder that derives three surround channels from the two in the original recording. This is achieved by using three different surround signals, Left Surround, Right Surround, and Back Surround, each driving its own array of speakers. Think of it as adding a center channel for the rear speakers, which give more diffuse and natural surround effect, even if you wanted the ability to completely encircle the audience with sound, positioning sound effects exactly where they would be heard in real life. For best results, Dolby Digital EX should be used with movie soundtracks recorded with Dolby Digital Surround EX which contain a digital flag that will automatically activate this feature. However, for titles released prior to late 2001, this feature has to be activated manually.

Although a full set of speakers (front left, right, and center, surround left and right, surround back and a subwoofer) is required for true 6.1 channel Dolby Digital Surround EX sound, this receiver lets you enjoy Dolby Digital (and Dolby Surround) program sources, even if you connect only the front speakers.

Although only Dolby Digital soundtracks incorporate a separate low frequency channel, connecting a subwoofer will also improve deep bass performance in the other surround modes.

The indication "LFE" appears in the display when a signal is being input for this channel.

Dolby PRO LOGIC II

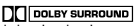
Dolby Pro Logic II was designed specifically to provide a new sense of spatiality, directionality and articulation of sounds from Dolby Surround encoded sources (such as video and Laserdisc software marked ). This is achieved with an intelligent, built-in feedback logic design, a matrix surround decoding and the decoding of stereo, full bandwidth surround outputs. The PRO LOGIC II modes programmed into this receiver are "MOVIE", "MUSIC" and "PRO LOGIC". The "MOVIE" mode of the PRO LOGIC II has preset characteristics to produce a calibrated, high-level surround sound playback while the "MUSIC" mode has user-adjustable characteristics to offer the three optional controls, like "Dimension", "Center Width" and "Panorama" modes to allow optimization of the soundfields as desired. The "Dimension" control allows the user to gradually adjust the soundfield either towards the front or towards the rear; the "Center Width" control allows various adjustment of the left-center-right speakers' balance; the "Panorama" mode extends the front stereo image to include the surround speakers for an exciting "wraparound" effect with side wall imaging.

DTS

The DTS multi-channel audio format is available on CD, LD and DVD software. DTS is a strictly digital format and cannot be decoded inside most CD, LD or DVD players. For this reason, if you attempt to listen to DTS encoded software through the analog output of your new CD, LD or DVD player, you will experience digital noise in most cases. This noise can be quite loud if the analog output is connected directly to a high power amplification system. Proper measures for playing the digital output as described below should be taken to avoid this situation. To enjoy DTS Digital Surround playback, an external 5.1 channel DTS Digital Surround decoder system or an amplifier with a built-in DTS Digital Surround decoder must be connected to the digital output (S/P DIF, AES/EBU or TosLink) of a CD, LD or DVD player. All models are incorporated with the DTS decoder.

DTS has a .1 or LFE channel.

The indication "LFE" appears in the display when a signal is being input for this channel.

DVD 6-channel mode

Using a DVD player or the like equipped with six (5.1) output channels and the receiver, you can enjoy multi-channel encoded DVD source material in all its splendor. Since the source signals are digital and each channel is input independently, the resulting sound quality, sense of spaciousness, and dynamic range are superb.

The indication "LFE" appears in the display during DVD 6-channel mode selection.

Note

LFE = Low Frequency Effects. This channel delivers separate non-directional bass signals to the subwoofer for more dynamic deep bass sound effects.

DSP mode

The DSP mode lets you add the atmosphere of a live concert or hall to almost any type of program source. These modes are particularly effective when used with stereo program sources, like CD, television, and FM radio. You might enjoy trying the ARENA, JAZZ CLUB, THEATER, STADIUM or DISCO mode the next time you watch a concert or sporting event!

What's DSP?

DSP stands for Digital Signal Processor. The way a sound is heard in an actual environment depends on a variety of different factors. One of the most important is reverberation (the act of decaying elements of sound echoing in various places). The DSP modes produce the feeling of presence by using the DSP to create reverberation, without spoiling the sound quality of the original signal.

SRS Circle Surround II

SRS Circle Surround II™ improves on its predecessor CS-5.1™ resulting in the CS-6.1™ system, enabling you to listen to realistic, multi-channel, surround sound playback from a stereo source or conventional surround-encoded video source. You already enjoy listening to Dolby Digital/DTS multi-channel sound with your multi-speakers. Now you can listen to audio CDs, MDs, Broadcast and Home Theater using your multi-speakers. You will discover a new type of sound through SRS Circle Surround II.

The CS system dramatically reduces storage space requirements for multi-channel content. It creates a listening environment that places the listener "inside" music performances, and dramatically improves both hi-fi audio and conventional surround-encoded video material. The CS decoder also includes the SRS technologies Focus™ and TruBass™. Focus electronically raises the sound stage from the speaker location to an optimal position. TruBass creates deep, rich bass in small speaker systems without the need for a subwoofer.

Surround play

The DTS compatible models can reproduce a CD, DVD, or LD carrying the DTS mark.

DOLBY DIGITAL can be used when playing DVD or LD software bearing the  mark and DOLBY DIGITAL format digital broadcasts (etc.). DOLBY PRO LOGIC can be used when playing video, DVD, or LD software bearing the  mark.

SRS Circle Surround II enables you to listen to multi channel sound from the stereo source.

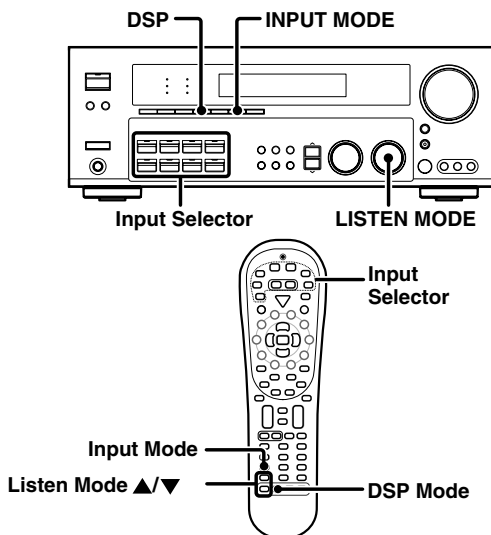

Preparations

- Turn ON related components.
- Complete "Preparing for surround sound" (speaker settings). - 17
- Use the **Input Selector** keys to select the component you wish to play back with surround sound.
- Use the **INPUT MODE** key to select the input mode (analog or digital) for the source you wish to play back. - 8
- Noise will be produced when a DTS source is played by selecting the analog input.

1 Start playing the video software.

2 Use the LISTEN MODE knob or Listen Mode ▲/▼ keys to select the listening mode.

The listening mode settings are stored separately for each input. If the input mode is set to full auto ("AUTO DETECT" lights), the receiver selects the optimal listening mode automatically based on the type of input signal and the speaker settings.

Each turn of the LISTEN MODE knob or press of the Listen Mode ▲/▼ keys switches the setting as listed below.

The listening mode settings are different depending on the type of input signal.

When the DOLBY DIGITAL or DOLBY DIGITAL EX signal is input:

(The DOLBY DIGITAL or PRO LOGIC, indicator lights up.)

- 1 **DOLBY DIGITAL** : DOLBY DIGITAL surround.
- 2 **DOLBY D EX** : DOLBY DIGITAL EX surround.
- 3 **PLII MOVIE** : PRO LOGIC II surround MOVIE mode. (The PRO LOGIC indicator lights up.)
- 4 **PLII MUSIC** : PRO LOGIC II surround MUSIC mode. (The PRO LOGIC indicator lights up.)
- 5 **PRO LOGIC** : PRO LOGIC II surround PRO LOGIC mode. (The PRO LOGIC indicator lights up.)
- 6 **STEREO** : Normal stereo playback.

When you select DOLBY DIGITAL

"DOLBY DIGITAL" will be displayed.

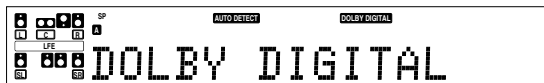

When the DTS signal is input:

(The DTS indicator lights up.)

- 1 **DTS** : (DTS indicator lights up.)
- 2 **STEREO** : Normal stereo playback.

When the analog signal or the digital signal (except for DOLBY DIGITAL or DTS signal) is input:

- 1 **PLII MOVIE** : PRO LOGIC II surround MOVIE mode. (The PRO LOGIC indicator lights up.)
- 2 **PLII MUSIC** : PRO LOGIC II surround MUSIC mode. (The PRO LOGIC indicator lights up.)
- 3 **PRO LOGIC** : PRO LOGIC II surround PRO LOGIC mode. (The PRO LOGIC indicator lights up.)
- 4 **CSII CINEMA** : CS 6.1 surround. (The CS II indicator lights up.)
- 5 **CSII MUSIC** : CS 6.1 surround. (The CS II indicator lights up.)
- 6 **CSII MONO** : CS 6.1 surround. (The CS II indicator lights up.)
- 7 **STEREO** : Normal stereo playback. (The STEREO indicator lights up.)

- Dolby Digital or DTS signal having more channels than the maximum number of playback channels available using the receiver's current settings is input, downmixing is performed to match the number of available channels.

3 DSP mode (Digital Signal Processor).

DSP can produce these effects without spoiling the sound quality of the original music or video source.

1 Pressing the DSP key or DSP Mode key will display the current DSP MODE status.

2 Each press of the key will switch to the next status as shown below:

- 1 **ARENA** : DSP surround ARENA mode.
- 2 **JAZZ CLUB** : DSP surround JAZZ CLUB mode.
- 3 **THEATER** : DSP surround THEATER mode.
- 4 **STADIUM** : DSP surround STADIUM mode.
- 5 **DISCO** : DSP surround DISCO mode.

- The DSP mode selection is displayed for approximately 3 seconds.

4 Adjust the volume.

Notes

- Depending on the type of the signal or speaker setting, some listening modes cannot be selected.
- When playback is started, the sound may be cut or interrupted before the input source is confirmed as Dolby Digital.
- To enjoy Dolby Digital surround (as well as all the other listening modes) from a single component, be sure to use a Dolby Digital compatible source component.

DVD 6-channel playback

Using a DVD player or the like equipped with six (5.1) output channels and the receiver, you can enjoy surround sound playback. Connecting a DVD player which can decode the surround signal itself is also acceptable.

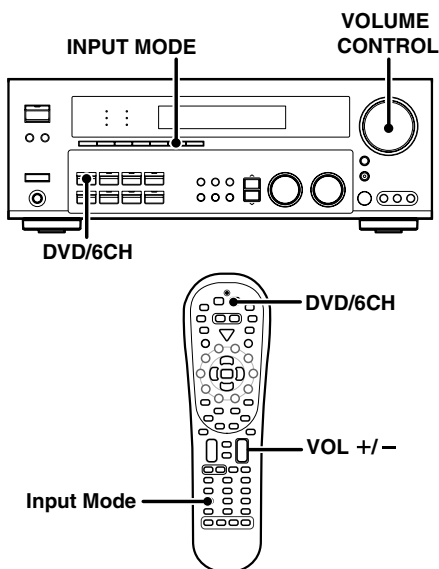

Preparations

- Connect your DVD player to the DVD/6CH jacks of the receiver.
- Turn on all other components that will be used.
- Complete "Preparing for surround sound".



1 Press "DVD/6CH" as the input source.

- If speaker system B is on when "DVD/6CH" is selected as the input source, it switches off and speaker system A turns on automatically.

2 Select "6CH INPUT" by pressing the INPUT MODE key.

3 Start playback of the DVD software.

4 Adjust the volume.

- It is not possible to adjust the volume level or sound quality (**SET UP, SOUND, LISTEN MODE, ACTIVE EQ and TONE key will not be functional**) of the channels separately when the receiver is in the 6CH INPUT mode. Adjust the volume with the controls of the DVD player.
- For the powered subwoofer, you can adjust the volume of the subwoofer using the subwoofer's own volume control.

Convenient functions

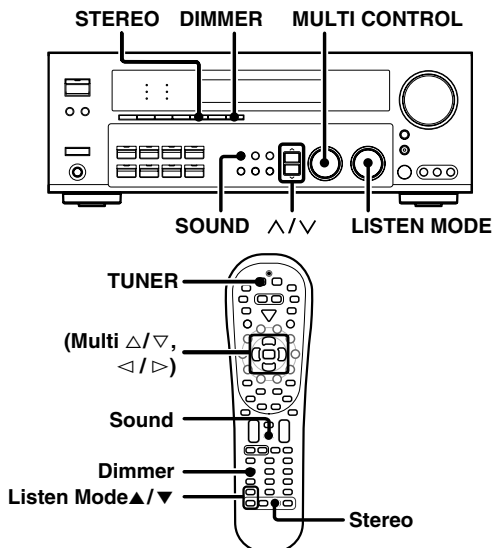

Adjusting the sound

You can make further adjustments to the sound while listening to playback in the surround mode.

- 1 For the remote control, press and hold the TUNER key for more than 3 seconds to switch to receiver mode.
- 2 Press the SOUND key and then use the \wedge/\vee keys or \triangle/∇ keys until the desired item appears in the display.

Each time you press the \wedge/\vee keys or \triangle/∇ keys, the menu changes as follows:
Note that some items are not displayed in certain modes.

- 1 CNTR (Center speaker level adjustment)*
- 2 SR (Right surround speaker level adjustment)*
- 3 SB (Surround back speaker level adjustment)*
- 4 SL (Left surround speaker level adjustment)*
- 5 SUBW (Subwoofer level adjustment)*
- 6 INPUT (Input level adjustment - analog mode only)
- 7 MIDNIGHT (Midnight mode ON/OFF - Dolby Digital mode only)
- 8 PANORAMA (Panorama mode ON/OFF)**
- 9 DIMENSION (Dimension adjustment)**
- 10 CENTER WIDTH (Center width adjustment)**
- 11 CENTER FOCUS (Center focus adjustment)***
- 12 CSII DLY (Rear speaker delay adjustment)***
- 13 CSII GAIN (Input gain adjustment)***
- 14 TruBass (TruBass adjustment)***

- * The adjustment is only temporary for the current input selection. The value will return automatically to the original setup value when the power is turned on/off or when the input selection is changed.
- ** Pro Logic II Music mode only.
- *** CS II mode only.

- 3 Use the MULTI CONTROL knob or Multi (\triangle/∇) keys to adjust the setting as desired.
 - The adjustment item is displayed for approximately 8 seconds.

Midnight mode (Dolby Digital mode only)

When watching movies at night, you might not be able to raise the volume as loud as normal. Midnight mode compresses the dynamic range of previously specified heavy sound passage of the Dolby Digital sound track (like scenes with sudden increases in volume) to minimize the difference in volume between the scenes with heavy sound passage and scenes with normal sound passage. This makes it easy to hear all of the sound track, even when listening at low volumes.

- 1 Press the **SOUND** key, then press the \wedge/\vee keys or $\triangleleft/\triangleright$ keys until "MIDNIGHT" appears on the display.
 - This can be selected only if CD/DVD, DVD/6CH or VIDEO 2 is selected as the source and the listen mode is set to "DOLBY DIGITAL."
- 2 Use the **MULTI CONTROL** knob or **Multi** (\triangle/∇) keys to select the ON or OFF setting.



- The adjustment item is displayed for approximately 8 seconds.
- Some Dolby Digital software may not be compatible with the Midnight mode.

Panorama mode (Pro Logic II Music mode only)

When listening to music, you will be able to enjoy the "wraparound" sound effect when you adjust the panorama mode.

- 1 Press the **SOUND** key, then press the \wedge/\vee keys or $\triangleleft/\triangleright$ keys until "PANORAMA" appears on the display.
- 2 Use the **MULTI CONTROL** knob or **Multi** (\triangle/∇) keys to select PANORAMA ON or OFF.

- ① PANORAMA ON : PANORAMA mode is ON.
- ② PANORAMA OFF : PANORAMA mode is OFF.

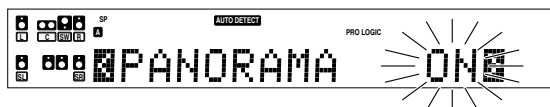

Dimension mode (Pro Logic II Music mode only)

When listening to music with certain recordings, you will also be able to achieve a suitable balance from all the speakers by adjusting the dimension mode.

- 1 Press the **SOUND** key, then press the \wedge/\vee keys or $\triangleleft/\triangleright$ keys until "DIMENSION" appears on the display.
- 2 Use the **MULTI CONTROL** knob or **Multi** (\triangle/∇) keys to adjust the soundfield towards the rear or the front.

Soundfield is adjusted towards the front.



Soundfield is in neutral position.

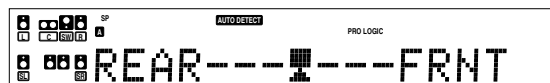

Soundfield is adjusted towards the rear.



Center Width mode (Pro Logic II Music mode only)

Center width adjustment allows you to enjoy an enhanced sound when listening to music through center image from only center speaker, or left and right speakers or various combinations adjustments.

- 1 Press the **SOUND** key, then press the \wedge/\vee keys or $\triangleleft/\triangleright$ keys until "CENTER WIDTH" appears on the display.
 - The CENTER WIDTH indication scrolls across the display.
 - When the center speaker is switched OFF, this mode will not be effective.
- 2 Use the **MULTI CONTROL** knob or **Multi** (\triangle/∇) keys to adjust the left-center-right output.

Center image will be heard from center speaker only.

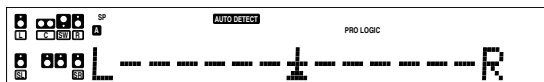

Center image will be heard from left and right speakers only.

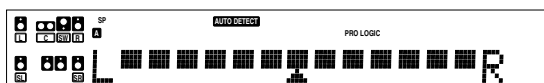

- When in other position, center image from center speaker, left and right speakers can be heard simultaneously with various combinations.

Circle Surround II mode

When you select the circle surround II mode, you will be able to enjoy the multi surround sound from the stereo source.

Use the **LISTEN MODE** knob or **Listen Mode** $\blacktriangle/\blacktriangledown$ keys for CS II selection.

Center Focus mode (CS II mode only)

Center focus elevate level adjustment allows you to enjoy an enhanced sound when you select CS II CINEMA/MUSIC/MONO. It repositions the sound image to an optimal position more natural to the listener through the center image.

- 1 Press the **SOUND** key, then press the \wedge/\vee keys or $\triangleleft/\triangleright$ keys until "CENTER FOCUS" appears on the display.

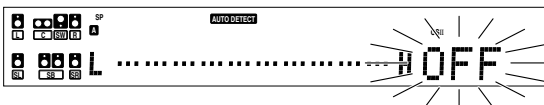

- 2 Use the **MULTI CONTROL** knob or **Multi** (\triangle/∇) keys to adjust the center elevation level.

- The adjustment range is from 0 to 10.

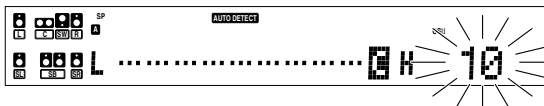

- CENTER FOCUS will not be available when the center speaker is OFF.

CS II Rear Delay adjustment mode (CS II mode only)

CS II Rear Delay adjustment provides a better sound effect from the rear speakers.

- 1 Press the **SOUND** key, then press the \wedge/\vee keys or $\triangleleft/\triangleright$ keys until "CSII DLY" appears on the display.

- 2 Use the **MULTI CONTROL** knob or **Multi** (\triangle/∇) keys to adjust the rear speaker.

- The adjustment range is from 0 ms to 25 ms.

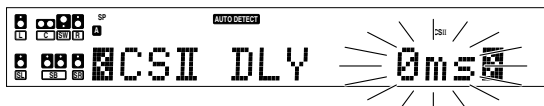

CS II Gain adjustment mode (CS II mode only)

CS II GAIN allows user to adjust the input gain for the Circle Surround II processing.

- ❶ Press the SOUND key, then press the \wedge/\vee keys or \triangle/∇ keys until "CSII GAIN" appears on the display.
- ❷ Use the MULTI CONTROL knob or Multi (\triangle/∇) keys to adjust the input gain.
 - The adjustment range is from 0 to -18.

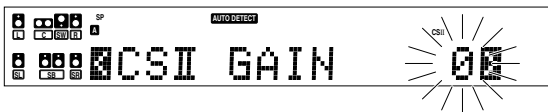

TruBass adjustment mode (CS II mode only)

TruBass adjustment provides deep, rich bass sound to various speakers.

- ❶ Press the SOUND key, then press the \wedge/\vee keys or \triangle/∇ keys until "TruBass" appears.
- ❷ Use the MULTI CONTROL knob or Multi (\triangle/∇) keys to select the following;
 - ❶ TruBass OFF
 - ❷ TruBass SW
 - ❸ TruBass LR
 - ❹ TruBass SW + LR

- After selecting ❷, ❸ or ❹, TruBass speaker size and level adjustment selection will be available.

- ❸ For TruBass speaker selection, use the MULTI CONTROL knob or Multi (\triangle/∇) keys to select any of the following display;

- ❶ TruBass LARGE
- ❷ TruBass MID
- ❸ TruBass SMALL

- ❹ Use the MULTI CONTROL knob or Multi (\triangle/∇) keys to adjust the TruBass Level.
 - The adjustment range is from 0 (Trubass OFF) to 10.

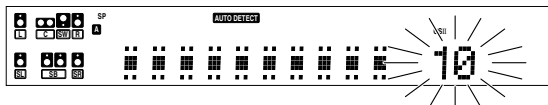

Display dimmer adjustment

The dimmer function lets you select the brightness of the receiver's display. You might find this useful if you darken your room to watch movies or listen to music.

Each time you press the DIMMER key, the display brightness changes among the three available settings. Select the brightness level you find most pleasing.

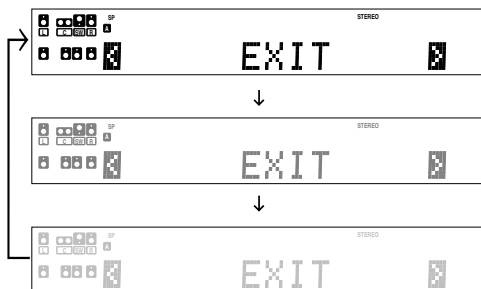

96kHz LPCM playback

The receiver is compatible with the 96kHz LPCM playback. To play a 96kHz DVD, set the listen mode to "STEREO".

- In **FULL AUTO** input mode the listen mode will automatically be STEREO.
- When in **DIGITAL MANUAL** input mode (listen mode is not STEREO), "96kHz LPCM" will appear in the display and no sound can be heard from the speakers. Press the Listen Mode or Stereo key (the listen mode changes to the STEREO mode) to output sound from the speakers.

ENGLISH

Basic remote control operations for other components

The remote control supplied with this receiver is also capable of controlling components from a variety of manufacturers once you register the appropriate setup codes into the remote control unit.

- Point the remote control at the component and press SRC Power key once. It should turn on/off but if it does not, repeat step 2 to 4
- If the component still does not work, try searching for the code.

Low battery warning

Replace all two batteries with new ones when you notice a shortening of the distance from which the remote control will operate. The remote control is designed to retain setup codes in memory while you change batteries.

5 Repeat steps 2 to 4 to register additional components until all components have been registered.

Note

Although each setup code is designed to work with a number of different models, certain codes may not work with some models. (Also, certain codes may only operate some of the functions available on a given model.)

Registering setup codes for other components

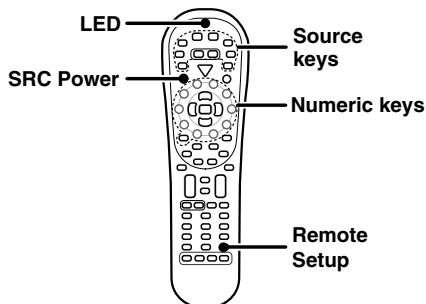

1 Find the setup code of the component to be registered.

- Refer to the setup code lists to find the setup code for the component to be registered. - 37

Example: To register a DVD made by KENWOOD, you would enter "0534".

Input	Component	Maker	Code	Key
(DVD)	DVD player	KENWOOD	0534	DVD

Source key	Other components
TUNER	Receiver (Kenwood)
DVD/6CH	DVD (other manufacturers')
CD/DVD	CD and MD (Kenwood)
MD/Tape	Cassette deck (Kenwood)
VID1 / AV AUX	VCR and PVR (other manufacturers')
VID2	Cable and DTV decoder (other manufacturers')
VID3	Satellite (other manufacturers')
PHONO	Additional key for re-assigning
TV	TV/VCR combo, TV/DVD combo, TV (other manufacturers')

2 Press the source keys (DVD/6CH, CD/DVD, VID1, VID2, VID3, TV, MD/TAPE, AV AUX, PHONO).

- PHONO key has to be re-assigned to another key before a setup code can be registered. - 36
- While in Tuner mode, setup code function will not be available.

3 Press and hold the Remote Setup key until the LED blinks twice, then release the Remote Setup key.

4 Press the numeric key to enter the four-digit code for the component to be registered.

- If performed correctly, the LED will blink twice.

Searching for your codes

If your component does not respond after trying all the codes listed for your component, or if your component is not listed at all, try searching for your code.

For example, to search for code for your TV:

1 Press the TV key once. Next, press and hold the Remote Setup key until the LED blinks twice, then release the Remote Setup key.

2 Press the numeric key to enter "9 - 9 - 1".

- The LED will blink twice.

3 Point the remote control at the TV and slowly alternate between pressing the SRC Power and TV key.

- Stop when the TV turns on/off.
- In the search mode, the remote control will send IR codes from its library to the selected device, starting with the most popular code first.

4 Press the Remote Setup key once to lock in the code.

5 To search for the codes of your other components, repeat steps 1 through 4, but substitute the appropriate key (i.e., DVD/6CH, CD/DVD, VID1, VID2, VID3, TV, MD/TAPE, AV AUX, PHONO).

- PHONO key has to be re-assigned to another key before a setup code can be programmed.

Checking the codes

If you have setup the remote control using the procedures described in "Searching for your codes", you may need to find out which four-digit code is operating your equipment:

For example, to find out which code is operating your TV:

1 Press the TV key once. Next, press and hold the Remote Setup key until the LED blinks twice, then release the Remote Setup key.

2 Press the numeric key to enter "9 - 9 - 0".

- The LED will blink twice.

3 To view the code for the first digit, press "1" once. Wait for 3 seconds, counts the number of times the LED blinks (e.g., blinks=3) and write down that number.

- If a code digit is "0", the LED will not blink.

Continued to next page

4 Repeat step **3** three more times for the remaining digits. Use "2" for the second digit, "3" for the third digit, and "4" for the fourth digit.

5 To check the codes of your other components, repeat steps **1** through **4**, but substitute the appropriate key (i.e., DVD/6CH, CD/DVD, VID1, VID2, VID3, TV, MD/TAPE, AV AUX, PHONO) for the component you are checking.

- As suggested earlier on, write down each of the four-digit code.
- PHONO key has to be re-assigned to another key before a setup code can be programmed.

Re-assigning device keys

The remote control can be setup to control second TV or VCR, or any combination of eight home entertainment components. For example, to control the operation of two different VCR using the remote control, the user need to re-assign the unused VID2 key to operate the second VCR(VID1) as follows:

1 Press and hold the Remote Setup key until the LED blinks twice, then release the Remote Setup key.

2 Press the numeric key to enter "9 - 9 - 2".

- The LED will blink twice.

3 Press VID1 key once, then press the VID2 key once.

- The user now can operate VID2 as a second VCR along with VID1.
- Refer to the table in the previous page for the combination of source keys and the other components assignment. - 39

4 To re-assign other device keys, repeat steps **1** through **3** by substituting the key sequence from the below chart for the most popular components:

To re-assign key

Sequence	Perform
TV as 2nd VID1 key	Remote Setup - 9 - 9 - 2 VID1 - TV
TV as 2nd VID2 key	Remote Setup - 9 - 9 - 2 VID2 - TV
TV as 2nd CD/DVD key	Remote Setup - 9 - 9 - 2 CD/DVD - TV
TV back to TV key	Remote Setup - 9 - 9 - 2 TV - TV
VID1 as 2nd TV key	Remote Setup - 9 - 9 - 2 TV - VID1
VID1 as 2nd VID2 key	Remote Setup - 9 - 9 - 2 VID2 - VID1
VID1 as 2nd CD/DVD key	Remote Setup - 9 - 9 - 2 CD/DVD - VID1
VID1 back to VID1 key	Remote Setup - 9 - 9 - 2 VID1 - VID1

5 To clear the re-assignment and reset the remote control to its original operation mode:

- 1** Press and hold the Remote Setup key until the LED blinks twice, then release the remote setup key.
- 2** Press the numeric key to enter "9 - 9 - 2".
- 3** Press VID2 key twice.

- When a re-assignment is done, the LED will blink twice to confirm your choice. At that time, you will need to program the remote control in order to control the new component.
- If an invalid key sequence is entered, the LED blink once and return to normal operation.
- When in Tuner mode, re-assignment is not available.

Operating other components

This operation lets you operate the registered components. KENWOOD audio components with system control turn on and off automatically with the receiver via the system control connections.

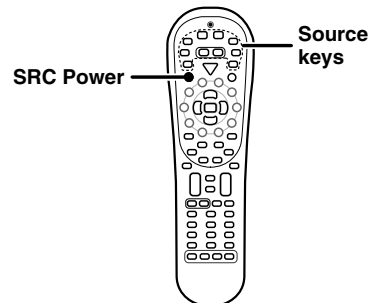

1 Use the Source keys to select the component you desire.

- Pressing the source keys also changes the input selector on the receiver.
- When you operate your registered cassette deck, CD player, DVD player, Cable, Satellite, DTV Decoder, VCR or TV, go to step **2**.
- When you operate the CD player, Cassette deck, MD player, or Tuner with system control connection, go to step **3**.

2 Press the SRC Power key.

- To return to the receiver operation mode, press the TUNER key for more than 3 seconds.

3 Press the operation keys you desire. - 42

The remote control mode remains at the selected input. If you wish to operate another component, repeat step **2** or **3**.

Note

- Be sure to point the remote control at the remote sensor on the receiver when you want to operate KENWOOD components connected by system control cords. Otherwise, point the remote control at the component you want to operate.
- To initialize the remote control, press the Remote Setup key until the LED blinks twice. Then press the numeric key to enter "9-8-1". The LED will blink twice.

Setup code chart

Satellite setup codes

Maker	Setup codes
ABsat	0832, 0123
AST	0321, 0351
Akai	0515
Alba	0455, 0421, 0515, 0613
Aldes	0288
Amstrad	0847, 0252, 0345, 0501, 0675, 0689, 1113
Ankaro	0713, 0288, 0369
Antron	0421
Arcon	0834, 1043, 1205
Armstrong	0243
Aston	0142, 1129
Astra	0108
Astro	0173, 0358, 0501, 0520, 0548
Avalon	0396
Axis	0369, 0530, 0834
BT	0668, 0710, 0515
Best	0369
Blaupunkt	0173
Boca	0243, 0829
British Sky Broadcasting	0847, 1175
CNT	0520
Cambridge	0515
Canal Digital	0853
Canal Satellite	0853
Canal+	0853
CityCom	0115, 0818, 1176
Commlink	0288
Connexions	0396
Conrad	0115, 0607
Crown	0243
Cyrus	0200
D-box	0723
DMT	1075
DNT	0200, 0396
Digenius	0299
Distratel	0084, 0885
Dynasat	0679
EIF	0417
Echostar	0312, 0853, 0871, 0713, 0167, 0396, 0453, 0454, 0511, 0610, 1086, 1169
Emanon	0421
Engel	1017
Eurostar	0679, 1025, 1026
FTE	0331, 0863
Ferguson	0711
Fidelity	0252, 0675
Finlux	0455, 0108, 0397, 0414
Force NO AS	1101
Fracarro	0871
Freecom	0421
Fuba	0396, 0369, 0414, 0417, 0421
Galaxis	0283, 0288, 0833, 0834, 0863, 1101, 1111
Galaxisat	0321
Gardiner	0818
Gold Box	0853

Maker	Setup codes
Gooding	0571
Grundig	0173, 0847, 0139, 0140, 0571, 0750, 0805, 1150
HDT	1011, 1159
Hirschmann	0173, 0396, 0397, 0398, 0495, 0501, 0573, 0882, 1085
Hitachi	0455
Houston	0668
Humax	0283, 0863, 1176
Huth	0243, 0288, 0794
Hyundai	1011, 1159
ITT	0108
InVideo	0871
Intervision	0592
JOK	0710
JVC	0515, 0571
Kathrein	0200, 0173, 0123, 0249, 0331, 0358, 0442, 0480, 0553, 0622, 0658, 1057, 1224
KeyWest	0794
Kosmos	0331
Kreiselmeier	0173
Kyostar	0421
L&S Electronic	1043
La Sat	0520, 0607
Lenco	0421
Lennox	0592
Lifesat	1122
Logix	1017
Lupus	0369
Luxor	0108, 0573
Manhattan	0455, 0520, 0592, 1017, 1083
Marantz	0200
Maspro	0495, 0750
Matsui	0571
MediaSat	0853
Mediamarkt	0243
Metronic	0713, 0084, 1215
Minerva	0571
Morgan's	0132, 0243, 0683, 0829
Multichoice	0879, 0642
Multistar	0331
Myryad	0200
Neuhaus	0501
Neusat	0692, 0834
NextWave	0732
Nikko	0713
Nokia	0455, 0751, 0723, 0873, 0108, 0397, 0573, 1023, 1127
Orbit	1022
Orbitech	0501
Pace	0847, 0455, 0887, 0720, 0497, 0241, 0791, 0795, 0867, 1175
Palladium	0571
Palsat	0501
Panasat	0879, 0615
Panasonic	0847, 1104
Panda	0455
Patriot	0515
Philips	0455, 0853, 0133, 0200, 0710, 0292, 0571, 0750, 0805, 0898, 1118

Maker	Setup codes
Phonotrend	0288, 0592
Pioneer	0853, 0329, 0352
Praxis	1123
Preisner	0132
Promax	0455
Prosat	0288
Quadral	0628
RFT	0200, 0288
Radiola	0200
Radix	0396, 0882, 1113
SAT	0321, 0351
SEG	0369, 0421, 0742, 1087
SKY	0856
SM Electronic	0713, 0157, 0240, 1200
STVI	0417
Saba	0710, 0520, 0690, 0885
Sabre	0455
Sagem	0820, 1114, 1253
Salora	0108
Samsung	1017, 1243
SatPartner	0421, 0520, 0692
Satcom	0605
Satstation	1083
Schneider	0805
Schwaiger	1111
Seemann	0396, 0530
Siemens	0173, 0683
Sky Television	1014
Skymaster	0713, 0240, 0288, 0605, 0628, 0880
Smart	0132
Sony	0847
Starland	1122
Strong	0879, 0132, 1105, 1159
Sunstar	0794
Supernova	0887
TPS	0820
Tantec	0455
TechniSat	0501, 0548, 1099, 1100, 1195
Telefunken	0421
Teleka	0243, 0613
Telesat	0605
Telesar	0114, 0157, 0501
Thomson	0455, 0853, 1012, 1046
Tonna	0668
Topfield	1206
Triad	0321, 0351
Triasat	0414, 0501
Triax	0115
Twiner	0136
Universum	0173, 0571
VTech	0351, 0690
Ventana	0200
Visiosat	1042
Vortec	0421
Wisi	0455, 0173, 0321, 0351, 0372, 0396, 0638, 0690
XSat	0123
Zehnder	0114, 0321, 0331, 0520, 0818, 1075
Zenith	0856
Zwergnase	0794

Setup code chart

TV setup codes

Maker	Setup codes
AGB	0516
ASA	0104, 0802
Acura	0009
Admiral	0163
Adyson	0217
Aiwa	0701, 0800
Akai	0208, 0516, 0602, 0708, 1537
Akito	0272
Akiba	0803
Akura	0264, 0218, 0358, 0493
Alba	0037, 0009, 0218, 0036, 0211, 0235, 0371, 0668, 0805, 0803
Allorgan	0294
Amplivision	0217
Amstrad	0037, 0009, 0177, 0371, 0412, 0433, 0516, 0800
Anitech	0009, 0803
Arcam	0216, 0217
Asuka	0218, 0802
Atlantic	0206
Audiosonic	0037, 0109
Autovox	0206, 0336
BPL	0282
BSR	0294
BTC	0218
Bang & Olufsen	0565
Barco	0380
Basic Line	0009, 0218, 0805, 0803
Baird	0800
Baur	0037, 0505, 0010, 0512, 0535, 0554
Beaumarck	0178
Beko	0370, 0486, 0714, 0715
Beon	0037
Binatone	0217
Blaupunkt	0195, 0191, 0200, 0327, 0328, 0535, 0554
Blue Sky	0218, 0668, 1037
Blue Star	0282
Bondstec	0247
Boots	0217
Brandt	0109, 0196, 0198, 0335
Britannia	0216
Bush	0355, 0037, 0009, 0218, 0036, 0211, 0272, 0282, 0294, 0371, 0374, 0519, 0668, 0698, 0805, 0803
CGE	0074, 0084, 0247, 0800
CS Electronics	0216
CTC	0247
Carrefour	0036
Cascade	0009
Cathay	0037
Centurion	0037
Cimline	0009
Clarivox	0037

Maker	Setup codes
Clatronic	0370, 0247
Condor	0370
Contec	0009, 0216, 0036
Continental Edison	0196, 0198, 0399
Crosley	0074, 0084
Crown	0037, 0009, 0370, 0418, 0805, 0803
Cybertron	0218
Daewoo	0037, 0009, 0374, 0499, 0805
Dainichi	0218
Dansai	0037, 0803
Dayton	0009
De Graaf	0208, 0548
Decca	0037, 0072, 0272, 0516, 0800
Denon	0145
Dixi	0037, 0009
Dual	0336, 0519
Dual Tec	0217
Dumont	0070, 0800
Elbe	0259
Elcotech	0803
Elin	0037, 0548
Elite	0218
Elta	0009
Erres	0037, 0012
ESC	0805
Europhon	0516
Expert	0206
Ferguson	0037, 0109, 0073, 0190, 0193, 0324, 0335, 0560
Firstline	0802, 0803, 0009, 0216, 0217, 0247, 0294, 0668
Fidelity	0216, 0193, 0800
Finlandia	0208, 0346
Finlux	0037, 0070, 0072, 0104, 0179, 0346, 0516, 0800
Fisher	0370, 0217, 0208, 0104, 0303
Flint	0455
Forgestone	0193
Formenti	0037
Frontech	0163, 0264, 0247
Fujitsu	0072, 0206, 0683
Funai	0264, 0179, 0294, 0303, 0800
GEC	0037, 0217, 0043, 0072, 0516
GPM	0218
Geloso	0009
Genexxa	0163, 0218
GoldStar	0178, 0037, 0109, 0217, 0290, 0802
Goldhand	0803
Goodmans	0037, 0217, 0036, 0072, 0179, 0235, 0371, 0374, 0499, 0634, 0802, 0800, 0805, 0803
Gorenje	0370
Graetz	0163
Granada	0037, 0217, 0208, 0045, 0072, 0339, 0516

Maker	Setup codes
Grandin	0282, 0610, 0802, 0800, 0803
Grundig	0556, 0195, 0587, 0070, 0191, 0487, 0535, 0554, 0706, 0900, 0803
HCM	0009, 0282, 0412, 0803
Hanseatic	0037, 0556, 0428, 0802
Hantarex	0516
Havermy	0093
Hinari	0037, 0009, 0218, 0036, 0179, 0803
Hisawa	0282, 0455
Hitachi	0109, 0578, 0163, 0217, 0036, 0043, 0196, 0198, 0225, 0481, 0548, 0730, 0800
HuanYu	0216, 0374
Hypson	0037, 0264, 0282, 0803
ICE	0264, 0217, 0371
ICeS	0218
IR	0074
ITS	0371
ITT	0163, 0548
ITV	0802, 0805
Imperial	0370, 0074, 0084, 0247, 0418, 0630, 0800
Indiana	0037
Ingelen	0163
Inno Hit	0072, 0516
Interfunk	0037, 0163, 0247, 0512
Intervision	0037, 0264, 0217
Isukai	0218
JMB	0901
JVC	0053, 0036, 0653, 0094, 0190, 0192, 0371, 0606, 0683
Kaisui	0217, 0009, 0218, 0216, 0282, 0803
Kapsch	0163, 0206
Karcher	0610
Kathrein	0556
Kendo	0037, 0235
Kingsley	0216
Kneissel	0259, 0435
Korpel	0037, 0803
Koyoda	0009
Lenco	0805
Leyco	0037, 0264, 0072, 0294, 0803
Liesenk & Tter	0037
Loewe	0512, 0802
Luma	0206
Luxor	0194
M Electronic	0037, 0109, 0163, 0009, 0217, 0057, 0104, 0346, 0374, 0480, 0800
MTC	0512
Magnadyne	0247, 0516
Magnafon	0516
Magnum	0648
Manesth	0264, 0217, 0235, 0803

Setup code chart

Maker	Setup codes
Marantz	0037, 0556
Mark	0037
Matsui	0037, 0009, 0217, 0036, 0208, 0011, 0035, 0072, 0177, 0211, 0235, 0272, 0294, 0355, 0371, 0487, 0516
McMichael	0043
Mediator	0037, 0012
Medion	0668
Memorex	0009, 1037, 0802, 0800
Memphis	0337, 0803
Metz	0275, 0367, 0447, 0535, 0802
Minerva	0070, 0487, 0535, 0554
Minoka	0412
Mitsubishi	0036, 0108, 0033, 0512, 0535
Mivar	0216, 0290, 0291, 0292, 0516
Multitech	0009, 0216, 0800, 0803
Murphy	0800
Myryad	0556
NEC	0170, 0704
NEI	0037, 0337
Neckermann	0037, 0556, 0505, 0191, 0554
Nesco	0179, 0803
Nikkai	0037, 0264, 0218, 0216, 0035, 0072, 0337
Nokia	0473, 0480, 0548, 0606
Nordmende	0109, 0196, 0198, 0560
Oceanic	0163, 0800
Onwa	0433
Orion	0037, 0177, 0235, 0294, 0355, 0516, 0655
Osaki	0264, 0218, 0217, 0072, 0412, 0493, 0802, 0800, 0803
Oso	0218
Osume	0072, 0157
Otto Versand	0037, 0556, 0505, 0217, 0036, 0010, 0191, 0512, 0535, 0554
Palladium	0370, 0418, 0802, 0803
Panama	0264, 0217
Panasonic	0250, 0226, 0650, 0126, 0163, 0214, 0274, 0367
Pathe Cinema	0216
Pathe Marconi	0196, 0198
Pausa	0009
Perdio	0800
Philco	0074, 0084, 0247
Philips	0037, 0556, 0012, 0043, 0193, 0374, 0554
Phonola	0037, 0012
Pioneer	0109, 0163, 0166
Prandoni Prince	0516
Profex	0009

Maker	Setup codes
Proline	0800
Protech	0037, 0009, 0264, 0217, 0247, 0337, 0418, 0668
Pye	0012
Quelle	0037, 0505, 0010, 0011, 0070, 0074, 0084, 0104, 0200, 0327, 0328, 0512, 0535, 0554
Questa	0036
R-Line	0037
RBM	0070
RFT	0428
Radiola	0037, 0012
Radiomarelli	0516
Rank Arena	0036
Revox	0037
Rex	0163, 0264, 0206, 0259
Roadstar	0009, 0264, 0218, 0418, 0802, 0805, 0803
SBR	0037, 0012, 0043, 0193
SEG	0264, 0217, 0036, 0668
SEI	0010, 0177, 0294, 0516
Saba	0109, 0163, 0196, 0198, 0335,
Sagem	0610
Saisho	0009, 0264, 0011, 0033, 0177, 0211, 0235, 0516
Salora	0163, 0194, 0548
Sambers	0516
Samsung	0037, 0556, 0009, 0370, 0264, 0217, 0587, 0290, 0618, 0644
Sandra	0216
Sansui	0655, 0706
Sanyo	0036, 0208, 0011, 0045, 0072, 0104, 0157, 0339
Schaub Lorenz	0800
Schneider	0037, 0218, 0057, 0247, 0303, 0336, 0371, 0394, 0668, 1137, 0800, 0803
Seleco	0163, 0206, 0259
Sentra	0035
Sharp	0093, 0036, 1193, 0901
Shintom	0803
Shorai	0294
Siarem	0516
Siemens	0037, 0195, 0157, 0191, 0200, 0327, 0328, 0535, 0554, 0802
Silva	0802
Silver	0036
Sinudyne	0010, 0177, 0235, 0294, 0516
Solavox	0163
Sonitron	0208
Sontec	0802, 0037

Maker	Setup codes
Sonoko	0037, 0009
Sonolar	0163, 0208
Sony	0011, 0505, 0036, 0000, 0010, 0651, 0652, 1010, 1505, 1651
Soundwave	0037, 0418
Standard	0009, 0218, 0217
Stern	0163, 0206, 0259
Sunkai	0294, 0355
Sunstar	0800
Suntronic	0800
Susumu	0218
Sysline	0037
T + A	0447
Tandy	0163, 0218, 0217, 0072
Tashiko	0217, 0036, 0043, 0800
Tatung	0037, 0217, 0072, 0516, 0800
Teac	0037, 0698, 0712, 1437
Tec	0217, 0247
Technics	0250, 0650
Technol Ace	0179
Telefunken	0109, 0625, 0074, 0084, 0101, 0335
Teletech	0009
Teleton	0217, 0036, 0206
Tensai	0218, 0294, 0800
Tenosal	0803
Texet	0218, 0216
Thomson	0109, 0625, 0196, 0198, 0399
Thorn	0037, 0505, 0035, 0072, 0074, 0084, 0104, 0190, 0192, 0193, 0499, 0512, 0535
Tomashi	0282
Toshiba	0036, 0508, 0035, 0070, 0243, 0718, 1508
Triumph	0177, 0243, 0516
Uher	0206, 0303
Ultra	0192
Universum	0037, 0370, 0264, 0074, 0104, 0346, 0492, 0802, 0535, 0800
Vestel	0037
Videosat	0247
Videotechnic	0217
Videomagic	0802
Villain	0800
Voxson	0163
Waltham	0217
Watson	0037
Wega	0036
White	0037, 0216
Westinghouse	
Yamishi	0803
Yapshe	0250
Yoko	0037, 0264, 0217
Yokan	0803
Zanussi	0206

Setup code chart

VCR setup codes

Maker	Setup codes
Asa	0081
Aiwa	0348, 0352
Akai	0041, 0106, 0315
Alba	0315, 0352
Baird	0104, 0041
Blaupunkt	0195, 0226, 0162, 0034
Brandt	0320, 0321
Brandt Electronic	0041
Bush	0352
Combitech	0352
Cyrus	0081
Daewoo	0637, 0642
De Graaf	0042
Decca	0081
Denon	0042
Dual	0041
Dumont	0081, 0104
ESC	0240
Elbe	0038
Ferguson	0320, 0041, 0321
Finlandia	0081, 0104
Finlux	0081, 0042, 0104
Firstline	0045, 0043
Fisher	0104, 0046
GEC	0081
Goodmans	0637
Graetz	0240, 0104, 0041
Granada	0081, 0104, 0046
Grundig	0081, 0195, 0226, 0347
Hinari	0240, 0352, 0004
Hitachi	0004, 0042, 0041, 0240
ITT	0106, 0240, 0104, 0041, 0046, 0384
Ingersol	0004
Interfunk	0081
JVC	0067, 0041, 0384
Kendo	0106
Kenwood	0041
Loewe	0081, 0162, 0004, 1562
Logik	0240, 0004
Luxor	0048, 0106, 0043, 0104, 0046
M Electronic	0038
Manesth	0045
Marantz	0081
Matsui	0348, 0352, 0004
Medion	0348
Memorex	0104, 0046
Metz	0195, 0162, 0347, 1562
Minerva	0195
Mitsubishi	0081, 0067, 0043
Myryad	0081
NEC	0067, 0041, 0038
Neckermann	0081
Nokia	0106, 0240, 0104, 0041, 0046
Nordmende	0320, 0041, 0321, 0384

Maker	Setup codes
Oceanic	0041
Okano	0348, 0315
Orion	0348, 0352, 0004
Otto Versand	0081
Palladium	0041
Panasonic	0162, 0226, 0836, 1562
Pathe Marconi	0041
Pentax	0042
Philco	0038
Philips	0081, 0384
Phonola	0081
Pioneer	0081, 0067
Profitronic	0240
Pye	0081
Quartz	0046
Quelle	0081
Radiola	0081
Rex	0041, 0384
Roadstar	0240
SBR	0081
SEG	0240
SEI	0081, 0004
Saba	0320, 0041, 0321, 0384
Saisho	0004
Salora	0106, 0043, 0046
Samsung	0240, 0432
Sansui	0067, 0041
Sanyo	0104, 0046
Saville	0352
Schaub Lorenz	0104, 0041
Schneider	0081
Seleco	0041
Sharp	0048
Shintom	0104
Shorai	0004
Siemens	0081, 0195, 0104
Singer	0045
Sunudyne	0081, 0004
Sonolor	0046
Sony	0032, 0033, 1032, 0034
Sunkai	0348
Tatung	0041, 0081
Technics	0162, 0226
Teleavia	0041
Telefunken	0320, 0041, 0321, 0384
Thomson	0067, 0320, 0041, 0321, 0384
Thorn	0104, 0041
Toshiba	0045, 0043, 0081, 0041, 0384
Uher	0240
Universum	0081, 0195, 0106, 0240
Yoko	0240

Cable setup codes

Maker	Setup codes
Alcatel	0896, 0897
Birmingham cable Communications	0276
British Telecom	0003, 0105
Cable & Wireless	1068
Cabletime	0448, 0665, 0377, 0271
Cryptovision	0600
Decsat	0423
Director	0476
Filmnet	0443
France Telecom	0896, 0897, 0451
Golden Channel	1110
Grundig	0529
HyperVision	0619
Jerrold	0276, 0003
MNet	0443, 0019
Mr. Zap	1112
Noos	0817
Ono	1068
PVP Stereo	0003
Visual Matrix	
Pace	1068, 1060
Philips	0619
Pioneer	0144
Sagem	0817
Scientific Atlanta	0277, 0008, 0477
Supercable	0276
Tele+1	0443
Thomson	1110
Torx	0003
Tudi	0286
United Cable	0003
Videoway	0250
Visionetics	1064
Westminster	0105, 0716
Zenith	0000

Setup code chart

DVD player setup codes

Maker	Setup codes
Afreedy	0698
Aiwa	0641
Akai	0611
Alba	0717
Amoisonic	0764
Amstrad	0713
Apex Digital	0672
Bush	0516, 0690
Cat	0786, 0789
Clatronic	0788
Cyber Home	0714, 0816
Cytron	0716
Daewoo	0770
Dansai	0770
Decca	0770
Denon	0490, 0634
DiViDo	0705
Enterprise	0591
GoldStar	0741
Goodmans	0790
GPX	0769
Greenhill	0717
Grundig	0539, 0701, 0705, 0775
H & B	0818
Harman/Kardon	0702
Himage	0518
HiMAX	0843
Hitachi	0664
Hiteker	0672
JVC	0558, 0623
Kenwood	0490, 0534, 0737
Konka	0711
LG	0741
Lasonic	0743
Lecson	0696
Lenco	0774
Limit	0768
Logic	0783
Mediencom	0746, 0773
MiCo	0723, 0751
Minato	0752
Minowa	0712
NAD	0692
Onkyo	0612, 0627, 1612
Optim	0747
Oritron	0651
Panasonic	0490
Philco	0690
Philips	0539, 0646
Pioneer	0525, 0571
REC	0689
Redstar	0748, 0763
Revoy	0699
Roadstar	0689
Rotel	0623
SM Electronic	0690, 0730
Samsung	0573, 0744
Sanyo	0670
Scheinder	0783
Scott	0718
Sherwood	0633
Skyworth	0766
Sony	0533, 1533

Maker	Setup codes
Tatung	0770, 0771
Teac	0759
Technics	0490
TerraTec	0825
Thomson	0551, 0522
Toshiba	0503
Tredex	0799
Umax	0690
Wesder	0699
Wharfedale	0686, 0696
Xwave	0709
Yamakawa	0665, 0710, 0765

DTV decoder setup codes

Maker	Setup codes
Grundig	0426
Panasonic	1120
Pioneer	1010
Princeton	0113, 0295
Samsung	1190
Sensory Science	1126
Sharp	1010

Cassette deck setup codes

Maker	Setup codes
Kenwood	0070, 0071, 0092, 0183, 0205, 0233, 0234, 0251, 0386

Receiver setup codes

Maker	Setup codes
Kenwood	1570

CD and MD player setup codes

Maker	Setup codes
Kenwood	0028, 0190, 0626, 0523, 0858, 0692, 1490, 0036, 0037, 0338, 0339, 0340, 0677, 0859, 0681, 0826, 1059

Setup codes for Kenwood components with System Control connection

Maker	Setup codes
CD	1338
MD	1339
Cassette deck	1340

CASSETTE deck, CD player & MD recorder operations

You can perform these basic operations using the keys described below when connected to KENWOOD cassette deck, CD player or MD recorder equipped with system control operations. → 16

Cassette deck operations keys

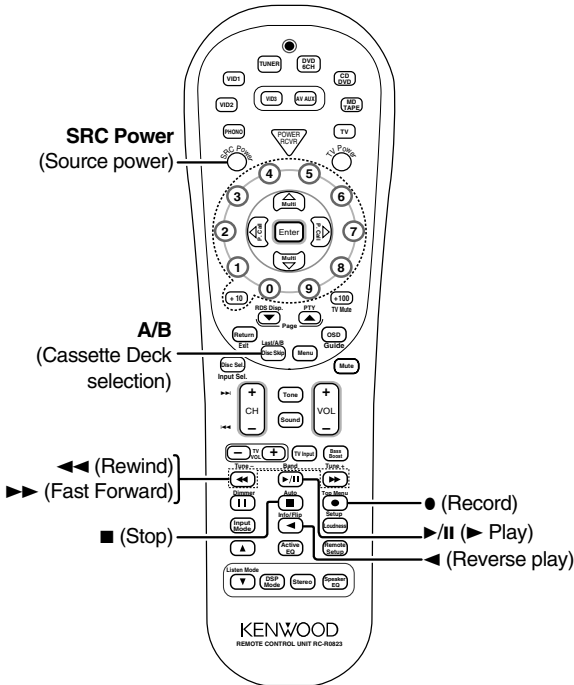

CD player operation keys

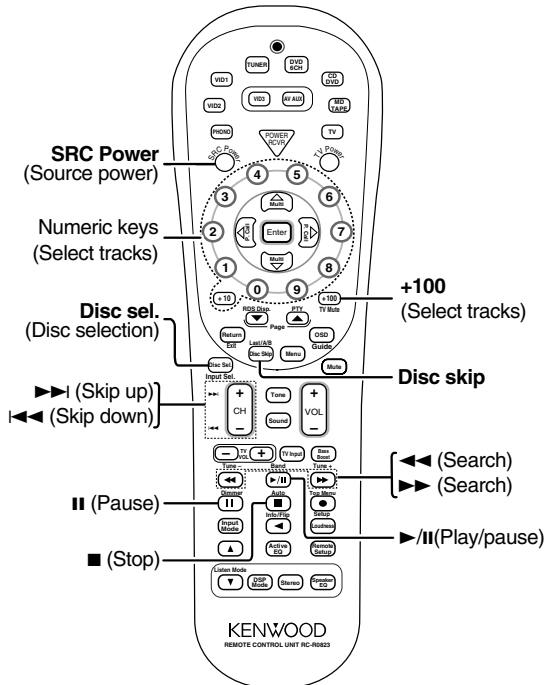

MD recorder operation keys

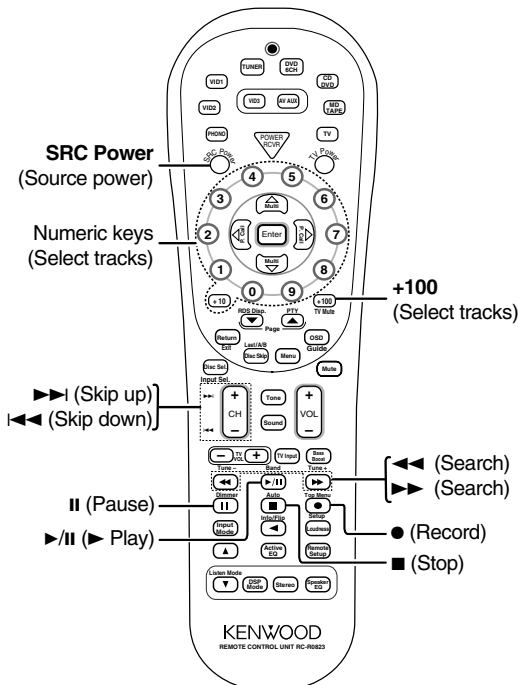

Other components' operations

Refer to the following for the type of remote control operations available for each component.

- ❶ Select the input source.
- ❷ Press the keys corresponding to the operations you desire. Refer to the following sections for details.

- When pressing keys in succession, press each key firmly and be sure to wait at least 1 second before pressing the next key.
- Numeric keys function the same as the numeric keys on the original remote.

These keys can be used to perform the basic operations of KENWOOD and other manufacturers' components which the setup code for each component had been entered beforehand. - 37

TV operation keys

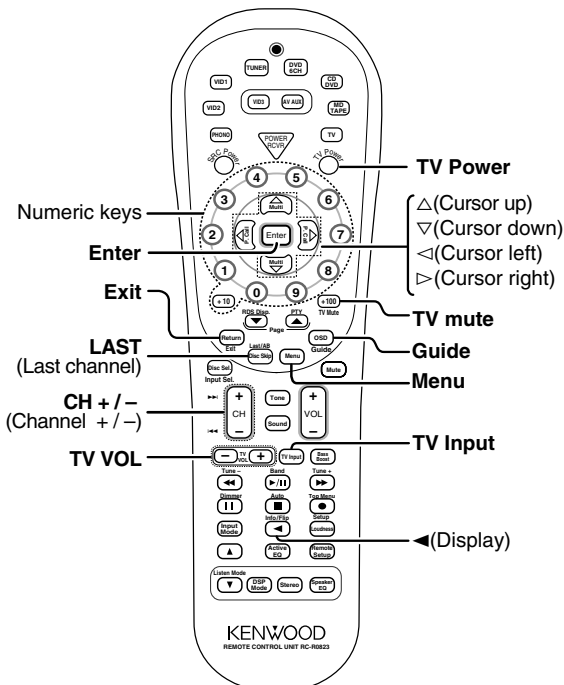

VCR operation keys

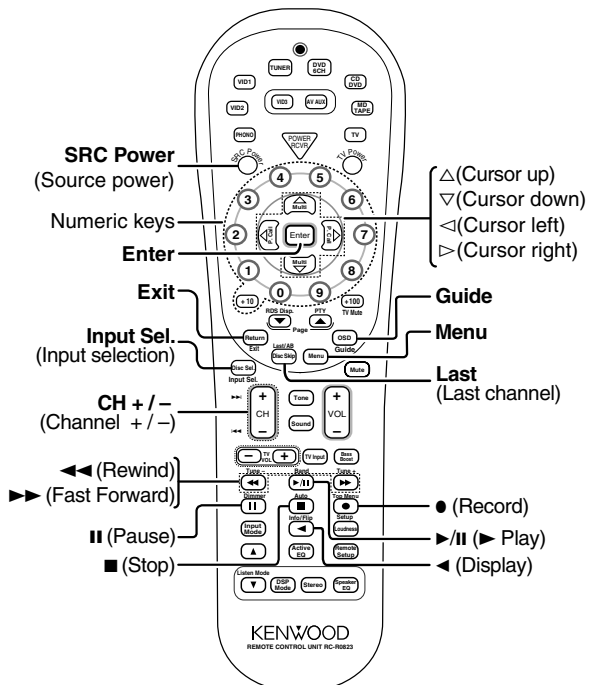

Satellite operation keys

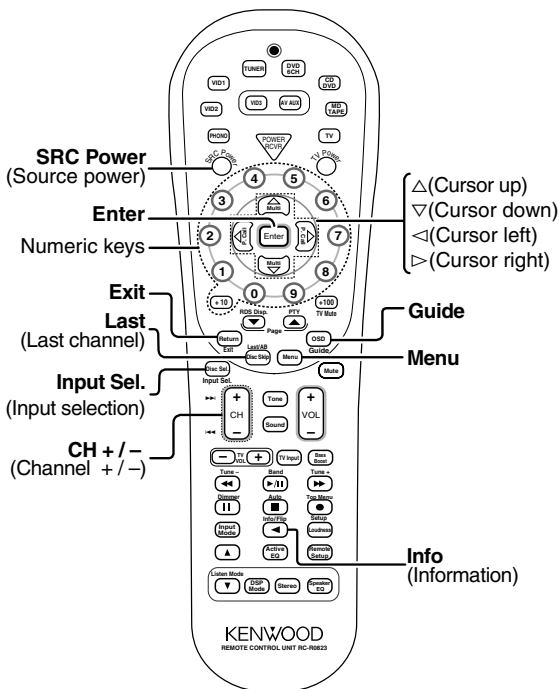

Cable operation keys

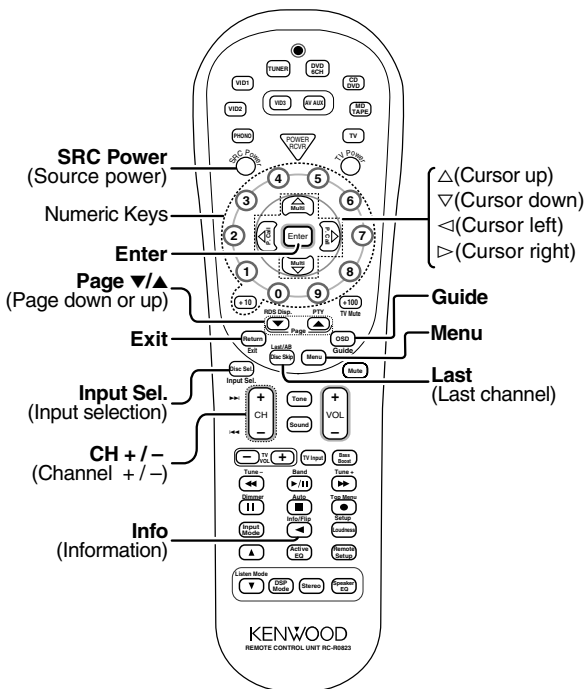

DVD player operation keys

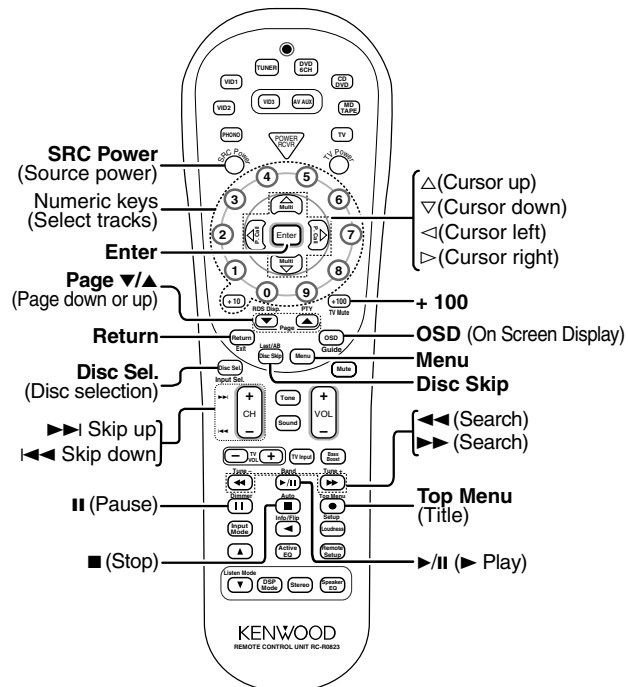

Notes
 1. Certain codes may only operate some of the function available on a given model.
 2. The above show the typical type functions available for each component. Some manufacturers use different key combinations to perform similar functions. For that reason, we have programmed extra functions on some of the unused number keys to help you control your equipment.

Resetting the Microcomputer

The microcomputer may malfunction (unit cannot be operated, or shows an erroneous display) if the power cord is unplugged while the power is ON, or due to some other external factor. If this happens, execute the following procedure to reset the microcomputer and return the unit to its normal operating condition.

With the power cord plugged in, turn the POWER ON/OFF key OFF. Then, while holding down the ON/STANDBY  key, press POWER ON/OFF.

- Please note that resetting the microcomputer will clear the contents of the memory and returns the unit to the state it was in when it left the factory.

Amplifier

Symptom	Cause	Remedy
No sound from the speakers.	<ul style="list-style-type: none"> • The speaker cords are disconnected. • VOLUME is set to the minimum position. • MUTE is ON. • The SPEAKERS switches are set to OFF. 	<ul style="list-style-type: none"> • Connect them properly referring to "Connecting the speakers" -14 • Adjust the volume to a proper level. • Turn OFF the MUTE. -21 • Set the SPEAKERS switches to ON. -20
The standby indicator blinks and sound is not output.	<ul style="list-style-type: none"> • Speaker cords are short-circuited. 	<ul style="list-style-type: none"> • Turn the power off, eliminate the short-circuiting, then turn on the power again.
Sound is not output from one of the speakers.	<ul style="list-style-type: none"> • The speaker cord is disconnected. 	<ul style="list-style-type: none"> • Connect it properly referring to "Connecting the speakers". -14
Sound is not output from the surround speakers and / or the center speaker, or their sound is very small.	<ul style="list-style-type: none"> • The surround speaker cords and/or the center speaker cord is disconnected. • A surround mode has not been engaged. • The surround and/or center volume controls are set to the minimum level. 	<ul style="list-style-type: none"> • Connect it properly referring to "Connecting the speakers". -14 • Select a surround mode. • Adjust the speaker levels using the test tone. -18
A humming noise is generated when the PHONO input selector is selected.	<ul style="list-style-type: none"> • The audio cord from the record player is not connected to the PHONO jacks. • The record player is not grounded. 	<ul style="list-style-type: none"> • Insert the audio cord plugs securely into the PHONO jacks. • Connect the grounding wire to the GND terminal on the rear panel.
When playing a Dolby Digital source signal using a DVD player, the sound is cut off soon after it starts.	<ul style="list-style-type: none"> • There are many possible causes for this problem, depending on the type of DVD player used. 	<ul style="list-style-type: none"> • Set the input mode to digital manual before starting playback of the Dolby Digital source. -6
No sound is produced during playback from a DVD player.	<ul style="list-style-type: none"> • The input mode is set to digital manual. 	<ul style="list-style-type: none"> • Press the INPUT MODE key to select to full auto mode. -8
A video source cannot be recorded normally.	<ul style="list-style-type: none"> • The software is copy-guarded. 	<ul style="list-style-type: none"> • Copy-guarded video software cannot be recorded.

Tuner

Symptom	Cause	Remedy
Radio stations cannot be received.	<ul style="list-style-type: none"> • No antenna is connected. • The broadcast band is not set properly. • The frequency of the desired station is not tuned. 	<ul style="list-style-type: none"> • Connect an antenna. -15 • Set the broadcast band properly. • Tune the frequency of the desired station. -24
Interference.	<ul style="list-style-type: none"> • Noise due to ignition noise from an automobile. • Noise due to interference from an electric appliance. • Noise due to a nearby TV set. 	<ul style="list-style-type: none"> • Install the outdoor antenna away from the road. • Turn off the power to the appliance. • Install the receiver farther away from the TV.
A station which was preset cannot be received by pressing the corresponding numeric key.	<ul style="list-style-type: none"> • The preset station belongs to a frequency that cannot be received. • The preset memory was cleared because the power cord had been unplugged for a long period of time. 	<ul style="list-style-type: none"> • Preset a station with a receivable frequency. • Preset the station again.

Remote control unit

Symptom	Cause	Remedy
Certain inputs cannot be selected using the remote control.	<ul style="list-style-type: none"> No setup codes registered for the respective input(s). 	<ul style="list-style-type: none"> Register a setup code at the respective input(s). → 37
Remote control operation is not possible.	<ul style="list-style-type: none"> The remote control is set to a different operation mode. Batteries are exhausted. The remote control unit is too far away from the main system, controlling angle is too large, or there is an obstacle between the receiver and the remote. The audio cords and system control cords are not connected properly. No tape or CD is placed in the source component. An attempt is made to play a tape which is being recorded in the cassette deck. The remote control has not been set to the operation mode for the component you wish to control. 	<ul style="list-style-type: none"> Press any of the Input Selector keys to select the appropriate operation mode. Replace with new batteries. Operate the remote control unit within the controllable range. Connect properly referring to "Setting up the system". Place the tape or CD in the source component which you want to play. Wait until recording has completed. Press any of the source keys or SRC Power key to activate the operation mode for the component you want to control before operation. → 36

AUDIO section

Rated power output during STEREO operation	
DIN/IEC (63Hz ~ 12.5 kHz, 0.09 % T.H.D. at 6 Ω)	100 W + 100 W
Effective power output during SURROUND operation	
FRONT (63Hz ~ 12.5 kHz, 0.09 % T.H.D. at 6 Ω one channel driven)	100 W + 100 W
CENTER (63Hz ~ 12.5 kHz, 0.09 % T.H.D. at 6 Ω one channel driven)	100 W
SURROUND (63Hz ~ 12.5 kHz, 0.7 % T.H.D. at 6 Ω one channel driven)	100 W + 100 W
Total harmonic distortion	0.009 % (1 kHz, 50 W, 6 Ω)
Frequency response	
(CD/DVD, TAPE, VIDEO 1, VIDEO 2, VIDEO 3, DVD/6CH)	10 Hz ~ 100 kHz, +0 dB ~ -3.0 dB
PHONO 'RIAA' response	40 Hz ~ 20 kHz, +1.5 dB ~ -3.0 dB
Maximum input level	
PHONO (MM)	45 mV, 1 % T.H.D. at 1 kHz
Signal to noise ratio (IHF'66)	
PHONO (MM)	75 dB
(CD/DVD, TAPE, VIDEO 1, VIDEO 2, VIDEO 3, DVD/6CH)	95 dB
Loudness control	
VOLUME at -30 dB level	+6 dB (100 Hz)
Input sensitivity / impedance	
PHONO (MM)	6.0 mV / 47 kΩ
(CD/DVD, TAPE, VIDEO 1, VIDEO 2, VIDEO 3, DVD/6CH)	500 mV / 47 kΩ
Output level / impedance	
TAPE REC	500 mV / 1 kΩ
PRE OUT (SURROUND BACK CHANNEL)	1 V / 1 kΩ
PRE OUT (SUBWOOFER)	1 V / 1 kΩ
Tone control	
BASS	±10 dB (at 100 Hz)
TREBLE	±10 dB (at 10 kHz)

DIGITAL AUDIO section

Sampling frequency	32 kHz, 44.1 kHz, 48 kHz, 96 kHz
Input level / impedance / wave length	
Optical	(-15 dBm ~ -24 dBm), 660 nm ±30 nm
Coaxial	0.5 Vp-p / 75 Ω

VIDEO section

VIDEO inputs / outputs	
VIDEO (composite)	1 Vp-p / 75 Ω
S VIDEO inputs / outputs	
S VIDEO (luminance signal)	1 Vp-p / 75 Ω
S VIDEO (chrominance signal)	0.286 Vp-p / 75 Ω

FM tuner section

Tuning frequency range	87.5 MHz ~ 108.0 MHz
Usable sensitivity	
MONO	1.3 μV (75 Ω) / 13.2 dBf (40 kHz dev, S/N 26 dB)
STEREO	45 μV (75 Ω) / 42.1 dBf (40 + 6 kHz dev, S/N 46 dB)
Total harmonic distortion	
MONO (1 kHz, 40 kHz dev)	0.2% (65.2 dBf input)
STEREO (1 kHz, 40 + 6 kHz dev)	0.8% (65.2 dBf input)
Signal to noise ratio (DIN weighted at 1 kHz)	
MONO	65 dB (65.2 dBf input)
STEREO	60 dB (65.2 dBf input)
Stereo separation (1 kHz)	36 dB
Selectivity (DIN ±300 kHz)	64 dB
Frequency response (30 Hz ~ 15 kHz)	+0.5 dB, -3.0 dB

AM tuner section

Tuning frequency range	531 kHz ~ 1,602 kHz
Usable sensitivity (30% mod, S/N 20 dB)	16 μV / (600 μV/m)
Signal to noise ratio (30% mod, 400 Hz)	50 dB (60 dBμV EMF input)

GENERAL

Power consumption	330 W
AC outlet	
SWITCHED	(total 90 W max.)
Dimensions	W : 440 mm (17-5/16")
	H : 159 mm (6-1/4")
	D : 392 mm (15-7/16")
Weight (Net)	9.8 kg (20.6 lb)

Notes
 1. KENWOOD follows a policy of continuous advancements in development. For this reason specifications may be changed without notice.
 2. The full performance may not be exhibited in an extremely cold location (under a water-freezing temperature).

KENWOOD

For your records

Record the serial number, found on the back of the unit, in the spaces designated on the warranty card, and in the space provided below. Refer to the model and serial numbers whenever you call upon your dealer for information or service on this product.

Model _____ Serial Number _____

Free Manuals Download Website

<http://myh66.com>

<http://usermanuals.us>

<http://www.somanuals.com>

<http://www.4manuals.cc>

<http://www.manual-lib.com>

<http://www.404manual.com>

<http://www.luxmanual.com>

<http://aubethermostatmanual.com>

Golf course search by state

<http://golfingnear.com>

Email search by domain

<http://emailbydomain.com>

Auto manuals search

<http://auto.somanuals.com>

TV manuals search

<http://tv.somanuals.com>