

KENWOOD

AUDIO - VIDEO SURROUND RECEIVER

KRF-V7771D

INSTRUCTION MANUAL

KENWOOD CORPORATION

Introduction

Connections

Setup

Operations

Other

Important: Setup the Remote Control First

To operate your audio system correctly, it is important to first program your remote control. The operation modes on your remote enable to control over the receiver and other components in your system. Read and understand the instructions for the remote, especially how to switch operation modes.

Quick Start

To enable surround-sound in the shortest amount of time, follow the steps that are highlighted by a ☆ (star).

B60-4117-00 00 © (CH) (T, E2) [KW] 9809



Introduction

KRF-V7771D (En/T)

2

Before applying power

⚠ Caution : Read this section carefully to ensure safe operation.

Units are designed for operation as follows.

U.K. and Europe AC 230 V only

Introduction

For the United Kingdom

Factory fitted moulded mains plug

1. The mains plug contains a fuse. For replacement, use only a 13-Amp ASTA-approved (BS1362) fuse.
2. The fuse cover must be refitted when replacing the fuse in the moulded plug.
3. Do not cut off the mains plug from this equipment. If the plug fitted is not suitable for the power points in your home or the cable is too short to reach a power point, then obtain an appropriate safety approved extension lead or adapter, or consult your dealer. If nonetheless the mains plug is cut off, remove the fuse and dispose of the plug immediately, to avoid a possible shock hazard by inadvertent connection to the mains supply

IMPORTANT: The wires in the mains lead are coloured in accordance with the following code:

Blue : Neutral

Brown : Live

Do not connect those leads to the earth terminal of a three-pin plug.





Batteries are supplied with this product. When they empty, you should not throw away. Instead, hand them in as small chemical waste.



Safety precautions

⚠ Caution : Read this section carefully to ensure safe operation.

WARNING : TO PREVENT FIRE OR ELECTRIC SHOCK, DO NOT EXPOSE THIS APPLIANCE TO RAIN OR MOISTURE.

	CAUTION RISK OF ELECTRIC SHOCK DO NOT OPEN		CAUTION: TO REDUCE THE RISK OF ELECTRIC SHOCK, DO NOT REMOVE COVER (OR BACK). NO USER-SERVICEABLE PARTS INSIDE. REFER SERVICING TO QUALIFIED SERVICE PERSONNEL.
	THE LIGHTNING FLASH WITH ARROWHEAD SYMBOL, WITHIN AN EQUILATERAL TRIANGLE, IS INTENDED TO ALERT THE USER TO THE PRESENCE OF UNINSULATED "DANGEROUS VOLTAGE" WITHIN THE PRODUCT'S ENCLOSURE THAT MAY BE OF SUFFICIENT MAGNITUDE TO CONSTITUTE A RISK OF ELECTRIC SHOCK TO PERSONS.		
	THE EXCLAMATION POINT WITHIN AN EQUILATERAL TRIANGLE IS INTENDED TO ALERT THE USER TO THE PRESENCE OF IMPORTANT OPERATING AND MAINTENANCE (SERVICING) INSTRUCTIONS IN THE LITERATURE ACCOMPANYING THE APPLIANCE.		

Unpacking

Unpack the unit carefully and make sure that all accessories are put aside so they will not be lost. Examine the unit for any possibility of shipping damage. If your unit is damaged or fails to operate, notify your dealer immediately. If your unit was shipped to you directly, notify the shipping company without delay. Only the consignee (the person or company receiving the unit) can file a claim against the carrier for shipping damage. We recommend that you retain the original carton and packing materials for use should you transport or ship the unit in the future.

Keep this manual handy for future reference.

Accessories

Check that the following accessories are present.

Remote control unit (1)

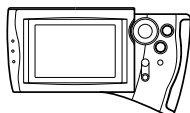

Batteries(R6/AA) (4)

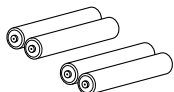

AM loop antenna (1)

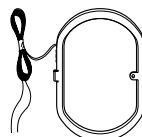

Loop antenna stand (1)

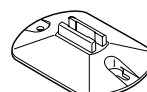

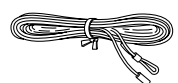

FM indoor antenna (1)



Contents

Caution : Read the pages marked  carefully to ensure safe operation.

The description headlines marked with the ☆ (star) symbols show the shortest way to perform Surround Sound playback.

Introduction	Introduction 2	
	 Before applying power 2	
	 Safety precautions 2	
	Unpacking 2	
	☆ Contents 3	
	Special features 4	
	Before using this unit 5	
	☆ How to use this manual 5	
Connections	☆ System connections 6	
	Connection of audio components 6	
	Connection of video components 7	
	Digital connections 8	
	Connecting the system control 10	
	Connecting a surround processor 11	
	Speaker connections/ PRE OUT connections 12	
	Connecting the antennas 13	
Setup	☆ Controls and indicators 14	
	☆ Setup of the remote control unit 15	
	Controls and indicators 15	
	Setting up the remote control according to your receiver 16	
	Basic operation 17	
	Navigating through the screens of remote control unit 18	
	☆ Setup for controlling AV components 19	
	Assigning the connected components to the selected inputs 19	
	Setup of components which are not listed in the Setup Codes chart (Futureset) 20	
	☆ Setup for surround play 22	
Setup for macro play (automatic operation) 24		
Setting up the remote control unit for macro play (automatic operation) 24		
Macro Execute 26		
☆ Playing music 27		
☆ Adjusting the audio 30		
Setup of Input Level 30		
Easy audio adjustment 31		
☆ Remote control of system components 32		
Broadcast reception 36		
Receiving a broadcast station 36		
Receiving a station by specifying the frequency 36		
RDS (Radio Data System) 37		
Functions of RDS 37		
RDS Disp. icon 37		
Storing RDS stations automatically in preset memory (Auto Memory) 38		
Receiving a preset RDS station 38		
Manual memory of broadcast stations 39		
Receiving a manually preset station 39		
Searching for a desired program type (PTY search) 40		
☆ Ambience effects 42		
Listen modes 42		
Available listen modes 44		
Caution for surround play 44		
Surround play 45		
6ch input play 46		
Checking the surround play status 47		
Cinema Re-EQ 47		
Applying surround effect in DSP mode 48		
Recording 49		
Convenient features 51		
☆ In case of difficulty 52		
☆ Specifications 55		

Special features

True home theater sound

Dolby Digital (AC-3)

The Dolby Digital (AC-3) mode lets you enjoy full digital surround from software processed in the Dolby Digital (AC-3) format. Dolby Digital (AC-3) provides up to 5.1 channels of independent digital audio for better sound quality and more powerful presence than conventional Dolby Surround.

MPEG

MPEG, which stands for "Moving Pictures Experts Group", is an international standard of digital video and audio compression and decompression in media. It is the most efficient encoding method for compressed multi-channel audio which provides the highest sound quality to deliver the best movie theater sound into the home.

Dolby Pro Logic & Dolby 3 Stereo

This surround system reproduces theater-like surround sound from video software marked  .

The Pro Logic mode uses the built-in adaptive matrix circuit to steer the Left, Center, Right and Surround channel audio signals. The 3 Stereo mode will redirect the surround signal to the front left and right speakers when only the front and center speakers are used.

DSP modes

The DSP (Digital Signal Processor) used for this receiver incorporates a variety of high quality adjustable sound fields, like "Arena", "Jazz Club", and "Theater", to add the "presence" associated with an arena, jazz club or theater to the original signal.

6ch input (DTS ready)

Using a DVD player with 6 channel output or the like equipped with six (5.1) output channels mainly for DTS, you can enjoy multi-channel encoded DVD source material in all its splendor. Since the decoded analog signals are input independently, the resulting sound quality, sense of spaciousness, and dynamic range are superb.

Universal IR (InfraRed) remote control unit

The remote control is a multi-function unit that operates KENWOOD AV components as well as those from other manufacturers. You simply enter a setup code into the remote. The remote control includes a dot matrix (128 x 64) LCD screen with 18 key icons, parameters and the status of the receiver. For ease of use, KENWOOD placed the frequently used key icons on the first level of the hierarchy and grouped associated icons on the same screen.

Macro Operation

The MACRO function lets you perform a series of operations automatically, like turning ON the power of the receiver and connected components, switching the input selectors, and starting playback. (Be sure to register your components before starting the macro setup procedure.) The macro setup covers the AV components from both KENWOOD and other manufacturers as well as non-audio/video units.

Futureset, automatic update feature

This function lets you update the remote control so it can operate new components which do not appear in the setup code chart.

Easy surround setup and operation with LCD

This function takes advantage of LCD to simplify the surround setup procedures so you can quickly and easily match the surround processing to your speaker system, and your listening environment.

RDS (Radio Data System)

This receiver is equipped with a RDS tuner that provides several convenient tuning functions: Auto Memory, to automatically preset up to 40 RDS stations broadcasting different programs; station name display, to show you the name of the current broadcast station; and PTY search to let you tune stations by program type.

Before using this unit

Compared to standard remote controls, the remote control supplied with this receiver has several operation modes. These modes enable the remote control to perform display operations and control other audio/video components. In order to effectively use the remote control it is important to read the operating instructions and obtain a proper understanding of the remote control and how to switch its operation modes (etc.).

Using the remote control without completely understanding its design and how to switch the operation modes may result in incorrect operations.

How to use this manual

Composition of this manual

This instruction manual is composed of the following 5 chapters.

Introduction	: Information to be read before using this unit.
Connections	: Procedures for connecting other components.
Setup	: Procedure for programming the remote control so that it can control this unit as well as the connected components.
Operations	: Procedures for remote controlling the connected components, playing music, listening to radio and surround play.
Other	: Troubleshooting information, specification data, etc.

Example of operation description

In this manual, the menu display on the remote control unit is shown on the left half of page while the right half shows the details operating procedures, supplementary description, related notes and caution.

Remote control menu (Left side)

Operating procedure step

Operating procedure text

Menu screen used in the operating procedure

Detailed operating procedure (Right side)

Detailed operating procedure related to the menu screen on the left

1 Select the mode from the "DSP Mode" menu screen.

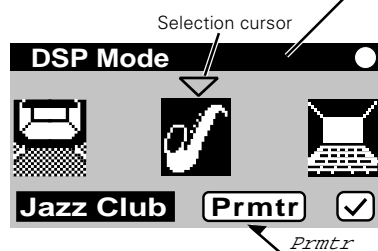

Use the joystick to move the selection cursor to the desired DSP mode and press the ENTER key.

- Arena** : the audio atmosphere in the front row of a large concert arena.
- Jazz Club** : a smaller, more intimate setting, with the listener setting close to the music.
- Theater** : the crisp acoustics of theater setting.

- To adjust the audio in the "DSP Mode", select the "Prmtr" (Parameter) icon.

☆ Shortest setup for surround play



To enable surround play in the shortest amount of time, follow the steps in the table of contents that are highlighted by a ☆ (star). The ☆ (star) symbols are also found on the bottom right or left of the pages containing the shortcut steps.

Connection of audio components

The connected components shown here are given as examples because the available models may vary depending on marketing areas.

Make connections as shown below.

When connecting the related system components, refer also to the instruction manuals of the related components.

⚠ Do not plug in the power lead until all connections are completed.

Also connect the system control cords when the KENWOOD Audio Component System is connected.

Malfunction of microcomputer

If operation is not possible or erroneous display appears even though all connections have been made properly, reset the microcomputer referring to "In case of difficulty". → 52

*1 To the CD2/TAPE2 MONITOR jacks, connect a second CD player, a second cassette deck or a graphic equalizer. Do not connect system control cord to the unit (except for graphic equalizer) connected to the CD2/TAPE2 MONITOR jacks.

Shape of AC outlet

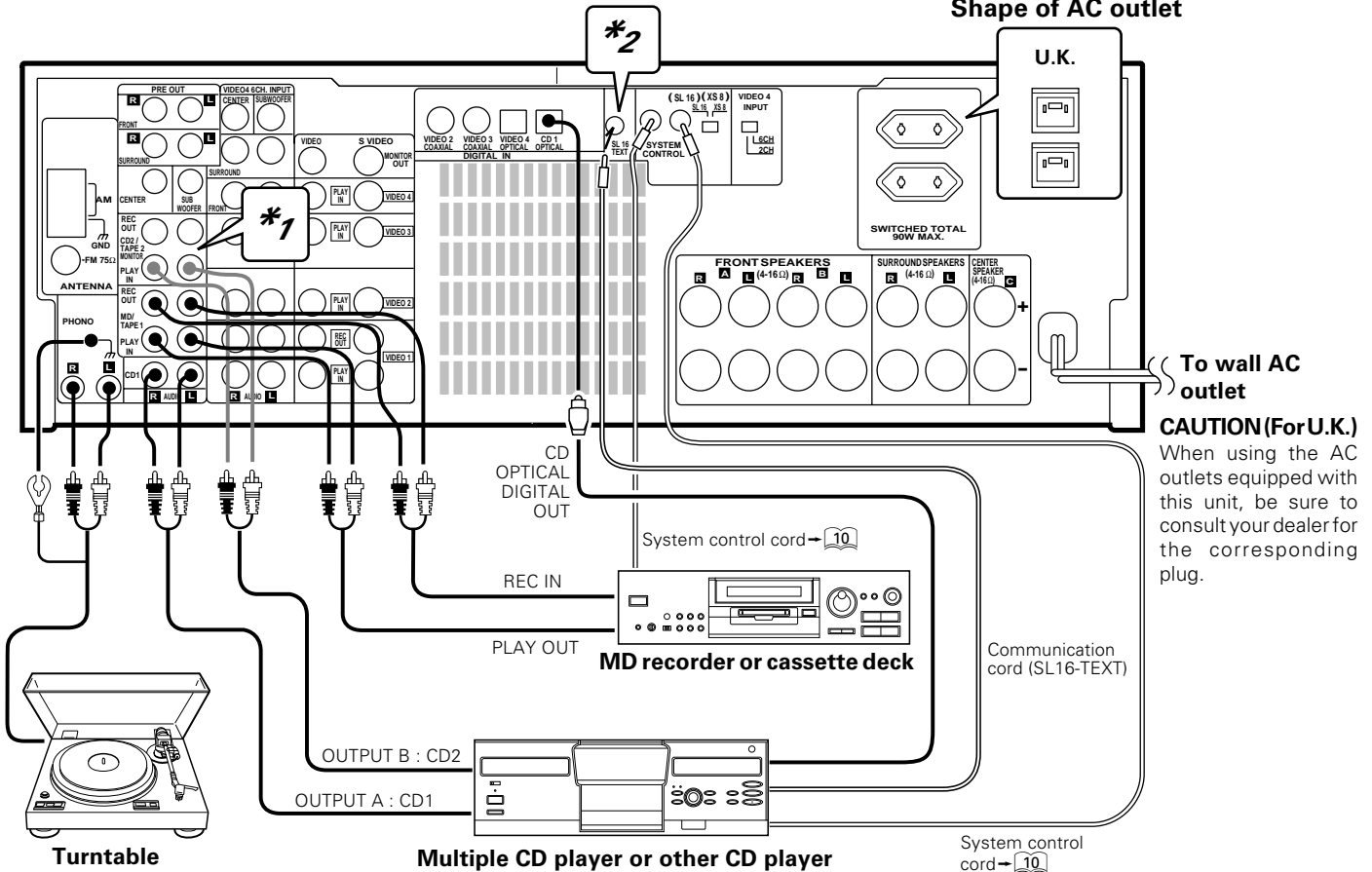

CAUTION (For U.K.)
When using the AC outlets equipped with this unit, be sure to consult your dealer for the corresponding plug.

*2 Note on the SL-16 TEXT jack (provided except for some destination areas): When using a KENWOOD CD player equipped with the SL-16 TEXT jack, connect it to this unit using the communication cord provided with the CD player. This makes it possible to display the disc and track titles on the remote control unit (provided with this unit). Do not forget to set the SL-16 / XS-8 switches of the CD player and this unit to SL-16.

Caution regarding placement

To maintain proper ventilation, be sure to leave a space around the unit (from the largest outer dimensions including projections) equal to, or greater than; Left and right panels : 10 cm, Rear panel : 10 cm, Top panel : 50 cm

Ventilation fan

The ventilation fan runs during high-power reproduction. To allow for proper ventilation, maintain a certain distance (more than about 10 cm, 4 inches) between the wall and the rear of the component.



1. Connect all cords firmly. Loose connections may prevent proper sound transmission or produce noise.
2. Be sure to remove the power cord from the AC outlet before plugging or unplugging any connection cords. Plugging / unplugging connection cords without disconnecting the power cord can cause malfunctions and may damage the unit.
3. Do not connect power cords from components whose power consumption is larger than what is indicated on the AC outlet at the rear of this unit.

Connection of video components

The connected components shown here are given as examples because the available models may vary depending on marketing areas.

Make connections as shown below.

When connecting the related system components, refer also to the instruction manuals of the related components.

⚠ Do not plug in the power lead until all connections are completed.

Also connect the system control cords when the KENWOOD Audio Component System is connected.

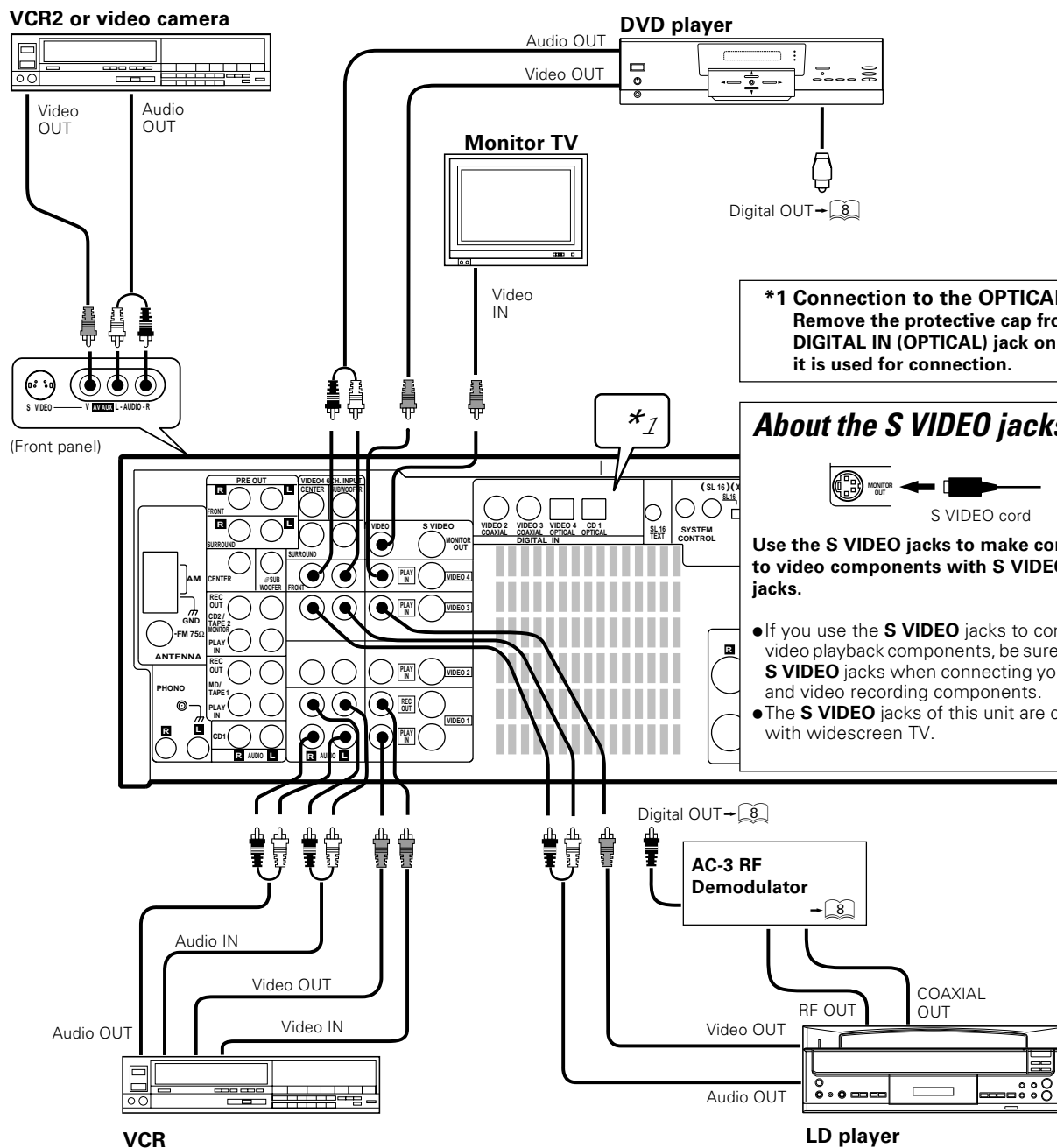

● To connect a Video CD compatible CD player and outputs its video, connect the player to one of the sets of input jacks **VIDEO1** to **VIDEO4**. In this case, do not connect the system control cord to the CD player.



Digital connections

The DIGITAL IN jacks can accept either MPEG, Dolby Digital (AC-3) or PCM (CD Format) signals (the input signal type is detected automatically).

The connected components shown here are given as examples because the available models may vary depending on marketing areas.

Make connections as shown below.

When connecting the related system components, refer also to the instruction manuals of the related components.

⚠ Do not plug in the power lead until all connections are completed.

LASER DISC RF DEMODULATOR (DEM-9991D)

Note : Only required if you wish to play Laser Discs in the Dolby Digital (AC-3) format

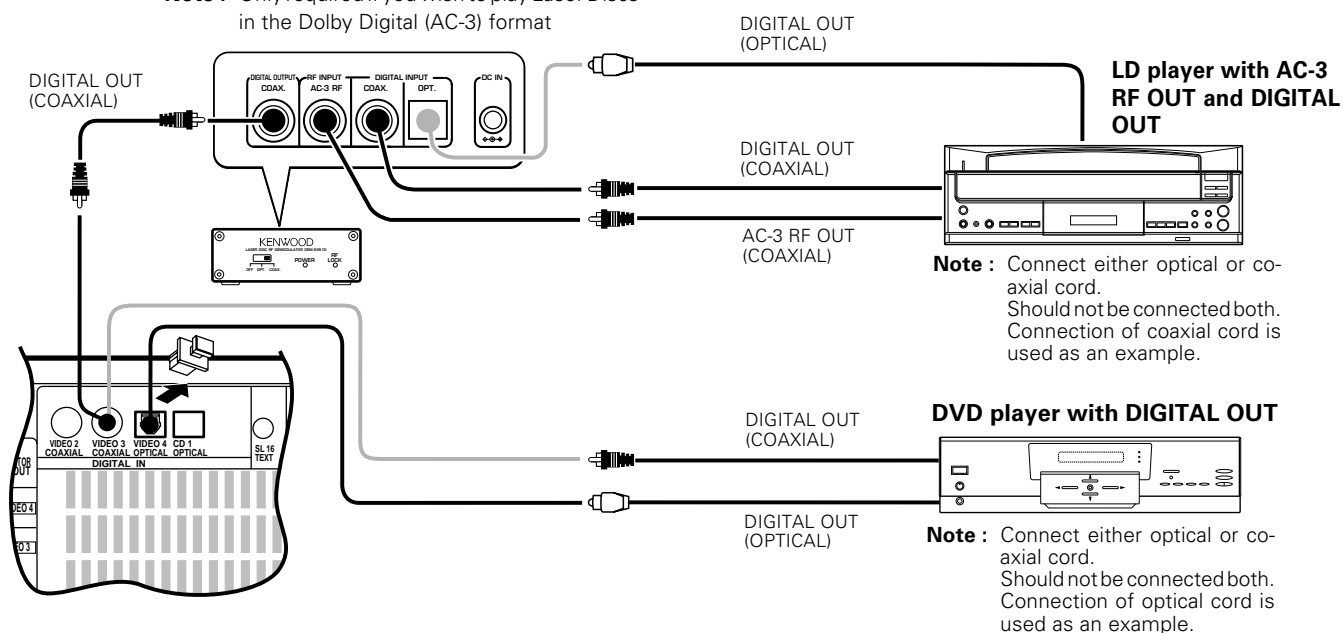

Note : Connect either optical or coaxial cord. Should not be connected both. Connection of coaxial cord is used as an example.

Note : Connect either optical or coaxial cord. Should not be connected both. Connection of optical cord is used as an example.

Notes on DIGITAL INPUT jacks and connectors

When using digital inputs, perform connection and assignment taking special care in the relations between the input jacks and connection cords.

DIGITAL INPUT jack	Usable cord connector
VIDEO2	COAXIAL connector
VIDEO3	COAXIAL connector
VIDEO4	OPTICAL connector
CD1	OPTICAL connector

Connection of an LD player

When connecting an LD player with AC-3 RF OUT, the LD player needs to be connected to the RF demodulator (DEM-9991D) first.

- 1 Connect the LD player to the KENWOOD LASER DISC RF DEMODULATOR (DEM-9991D : optional).
 - If your LD player can be connected to the receiver directly, connect it to the DIGITAL IN, VIDEO 3 COAXIAL.
- 2 Connect the demodulator to the receiver's DIGITAL IN, VIDEO 3 COAXIAL jack.
- 3 Connect the video signal and analog audio signals to the VIDEO 3 jacks. (See "Connection of video components". →)

Connection of a DVD player

Use the DIGITAL IN, VIDEO 4 OPTICAL jack for the connection of a DVD player.

- 1 Connect the DVD player's DIGITAL OUT (optical) with the receiver's DIGITAL IN, VIDEO 4 OPTICAL jack.
- 2 Connect the video signal, S Video signal and analog audio signals to the VIDEO 4 jacks. (See "Connection of video components". →)

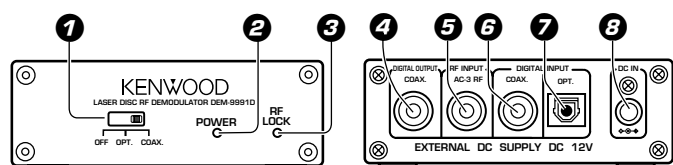
LASER DISC RF DEMODULATOR DEM-9991D (Optional)

Place the power supply away from the demodulator, receiver, and any antennas.

1 POWER switch

Use to switch the POWER OFF/ POWER ON (OPT./ COAX.). Regardless of the OPT./COAX. switch setting, the input is switched automatically to the Dolby Digital (AC-3) RF input whenever the Dolby Digital (AC-3) RF signal is input.

2 POWER indicator

Lights (red) when the power switch (1) is set to ON.

3 RF LOCK indicator

Lights when a Dolby Digital (AC-3) RF signal is input to the RF INPUT (AC-3 RF INPUT) jack (5). (This indicator is extinguished when a digital input is in use.)

4 DIGITAL OUTPUT COAX. (COAXIAL)

Connect this jack to the VIDEO4 COAXIAL (DIGITAL IN) jack on your Receiver. It outputs Dolby Digital (AC-3) coaxial digital signals when the POWER (1) is set to COAX. and a Dolby Digital (AC-3) RF signal is input to the RF INPUT (AC-3 RF INPUT) jack (5).

5 RF INPUT AC-3 RF (Dolby Digital RF)

Connect this jack to the Dolby Digital (AC-3) RF OUTPUT jack on your LD player.

6 DIGITAL INPUT COAX. (COAXIAL)

Connect this jack to the COAXIAL OUTPUT jack on your LD player.

7 DIGITAL INPUT OPT. (OPTICAL)

Connect this jack to the OPTICAL OUTPUT jack on your LD player.

- When there are simultaneous inputs through the RF INPUT (AC-3 RF) jack and DIGITAL INPUT jack, the input through RF INPUT (AC-3 RF) is given the priority.

8 DC IN 12V jack

Connect this jack to the AC adaptor supplied with your demodulator. Connect the AC adaptor to a wall outlet after completing all of the other connections.

"Dolby" and "AC-3" are trademarks of Dolby Laboratories.

Connecting the system control

Connecting system control cords lets you take advantage of convenient system control operations. There are two types of KENWOOD system control modes. Make connections according to the groups of terminal symbols shown below.

[XS8] Mode : lets you combine [XS], [XS8], and [XR] terminals
[SL16] Mode : for [SL16] terminals only

This unit is compatible with both [XS8] and [SL16] modes. It comes from the factory set to the [SL16] mode. To switch to the [XS8] mode, follow the instructions in "Switching from [SL16] to [XS8]" below.

EXAMPLE: [XS8] mode connections

The underlined portion represents the setting of the system control mode.

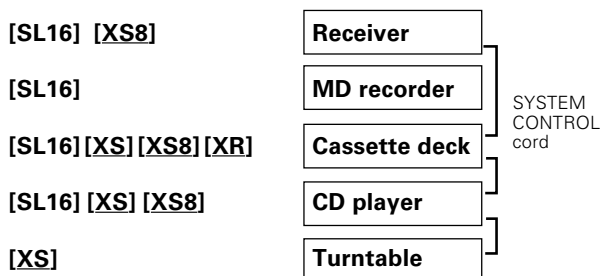

EXAMPLE: [SL16] mode connections

The underlined portion represents the setting of the system control mode.

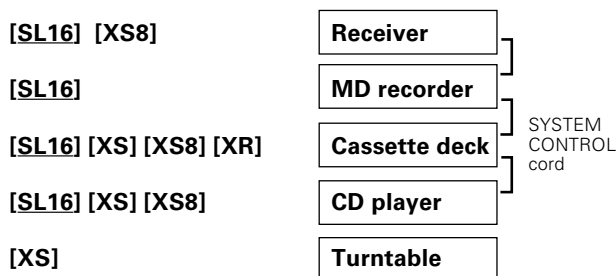

- In order to take advantage of the system control operations, the components must be connected to the correct jacks. To use a CD player it must be connected to the CD 1 jacks. To use a cassette deck (or MD recorder) it must be connected to the MD/TAPE 1 jacks. When using more than one CD player (etc.) only the one connected to the specified jacks may be connected for system control.
- Some CD players and cassette decks are not compatible with the [SL16] system control mode. Be sure to use the [XS8] system control mode when making system connections with equipment that is not [SL16] compatible.
- Some MD recorders are not system-control compatible. The system control function is not available when a MD recorder is used by connecting it through a digital input. You cannot connect the system control cord to this kind of equipment.



1. [SL16] equipment cannot be combined with [XR], [XS], and [XS8] equipment for system operations. If your equipment consists of this kind of combination, please do not connect any system control cords. Even without system control cords, normal operations can be carried out without effecting performance.
2. Do not connect system control cords to any components other than those specified by KENWOOD. It may cause a malfunction and damage your equipment.
3. Be sure the system control plugs are inserted all the way in to the system control terminals.

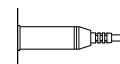

System control operations

Remote Control

Lets you operate the connected components with the system remote supplied with the receiver.

Automatic Operation (except [XR] equipment)

When you start playback from a source component, the input selector on this unit switches to that component automatically.

Synchronized Recording (except [XR] equipment)

Lets you synchronize recording with the start of playback when recording from CD, MD or analog discs.

Switching from [SL16] to [XS8]

You can easily change the system control mode by adjusting the position of the SYSTEM CONTROL switch on the rear panel. Do this operation after completing all connections.

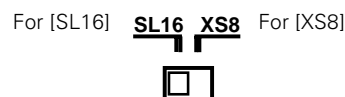

- This operation will not effect items stored in the memory.
- After switching the system control mode, turn the power off and then back on to confirm the new setting.

Registering setup codes for KENWOOD audio components

- Once you finish making the system connections, be sure to register the appropriate setup code for each component.
- If you own remote controllable KENWOOD audio components that are not compatible with system control (or cannot be combined with your other system control components), registering the setup code enables you to control those components using the remote control supplied with this unit (without connecting system control cords). To register setup codes for your remote controllable KENWOOD audio components, see "Setup for controlling AV components".

Connecting a surround processor

Make connections as shown below.

When connecting the related system components, refer also to the instruction manuals of the related components.

⚠ Do not plug in the power lead until all connections are completed.

The sound input to VIDEO 4 6CH. INPUT is paired with the video signal input to VIDEO 4.

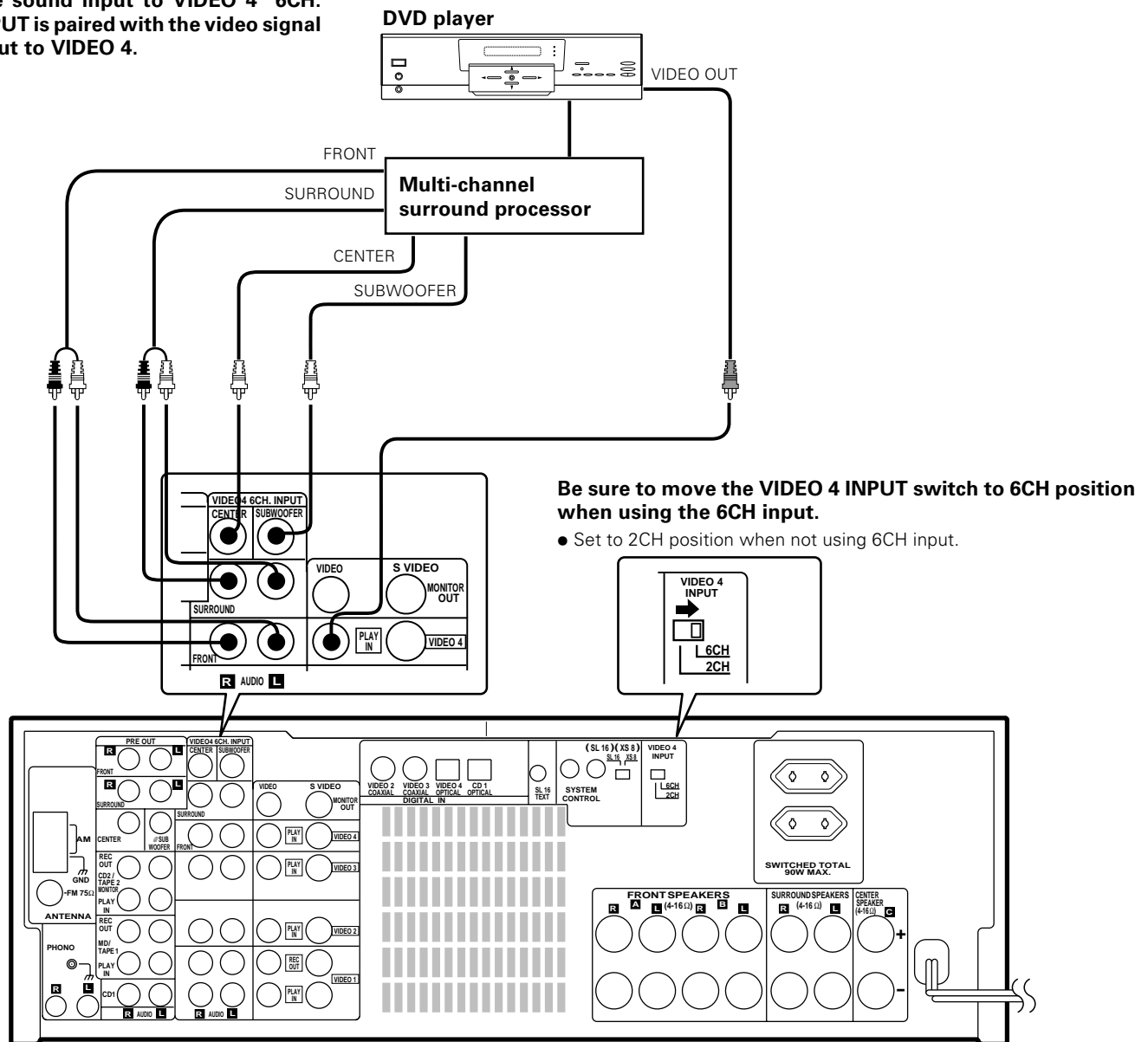

DTS disclaimer clause

DTS Digital Surround™ is a discrete 5.1 channel digital audio format available on CD, LD, and DVD software which consequently cannot be decoded and played back inside most CD, LD, or DVD players. For this reason, when DTS-encoded software is played back through the analog outputs of the CD, LD, or DVD player, excessive noise will be exhibited. To avoid possible damage to the audio system, proper precautions should be taken by the consumer if the analog outputs are connected directly to an amplification system. To enjoy DTS Digital Surround™ playback, an external 5.1 channel DTS Digital Surround™ decoder system must be connected to the digital output of the CD, LD, or DVD player.

Speaker connections/PRE OUT connections

Make connections as shown below. When connecting the related system components, refer also to the instruction manuals of the related components.

⚠ Do not plug in the power lead until all connections are completed.

1 Strip coating.



2 Loosen.



3 Insert.



4 Secure.



- Never short circuit the + and - speaker cords.
- If the left and right speakers are connected inversely or the speaker cords are connected with reversed polarity, the sound will be unnatural with ambiguous acoustic imaging. Be sure to connect the speakers correctly.

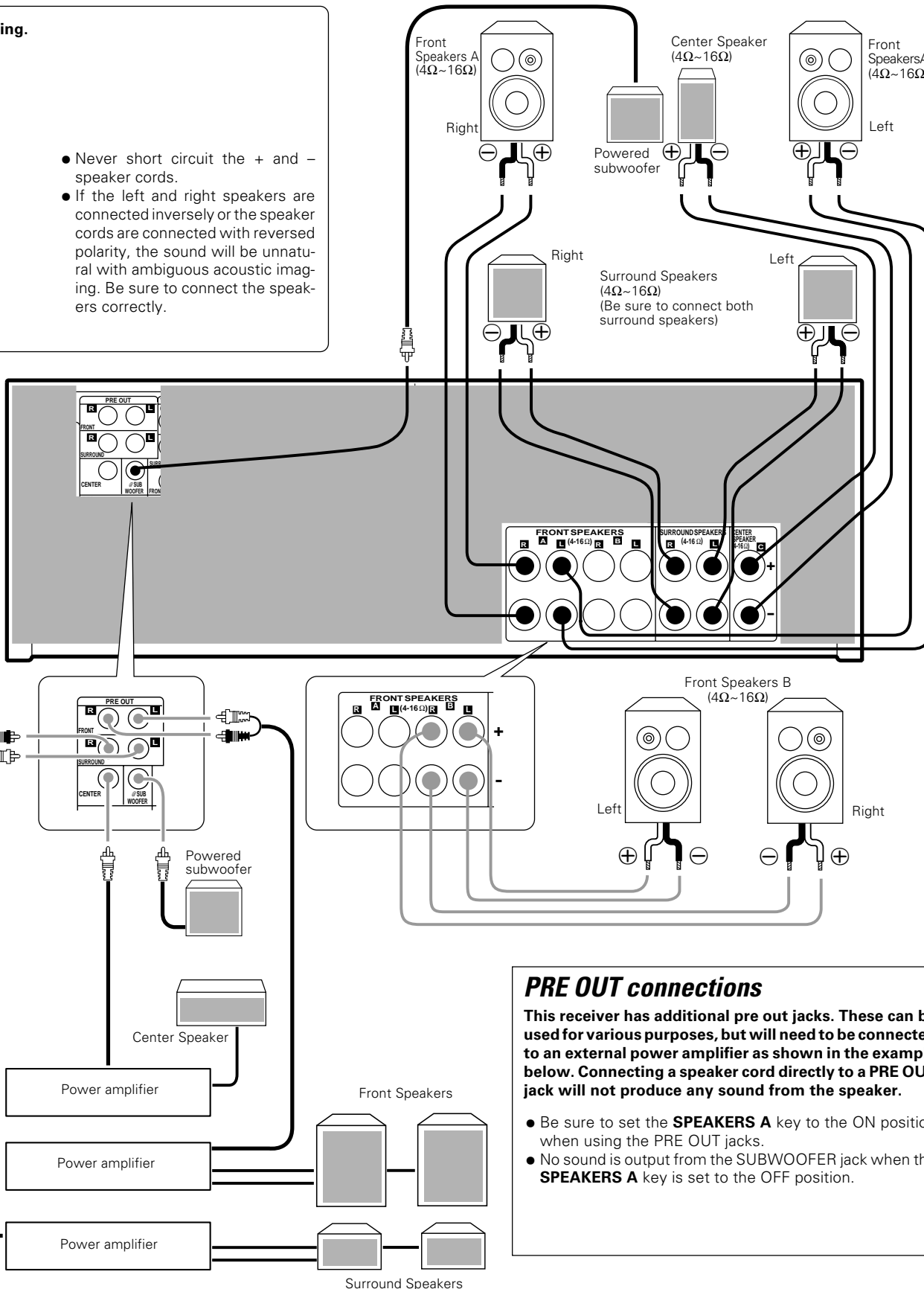

PRE OUT connections

This receiver has additional pre out jacks. These can be used for various purposes, but will need to be connected to an external power amplifier as shown in the example below. Connecting a speaker cord directly to a PRE OUT jack will not produce any sound from the speaker.

- Be sure to set the **SPEAKERS A** key to the ON position when using the PRE OUT jacks.
- No sound is output from the SUBWOOFER jack when the **SPEAKERS A** key is set to the OFF position.



Connecting the antennas

Make connections as shown below.

⚠ Do not connect the power cord to a wall outlet until all connections are completed.

Antenna terminal connections

① Push lever.

② Insert cord.

③ Return lever.

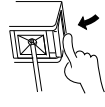

AM loop antenna

The supplied loop antenna is for indoor use. Place it as far as possible from the receiver, TV set, speaker cords and power cord, and adjust the direction for best reception.

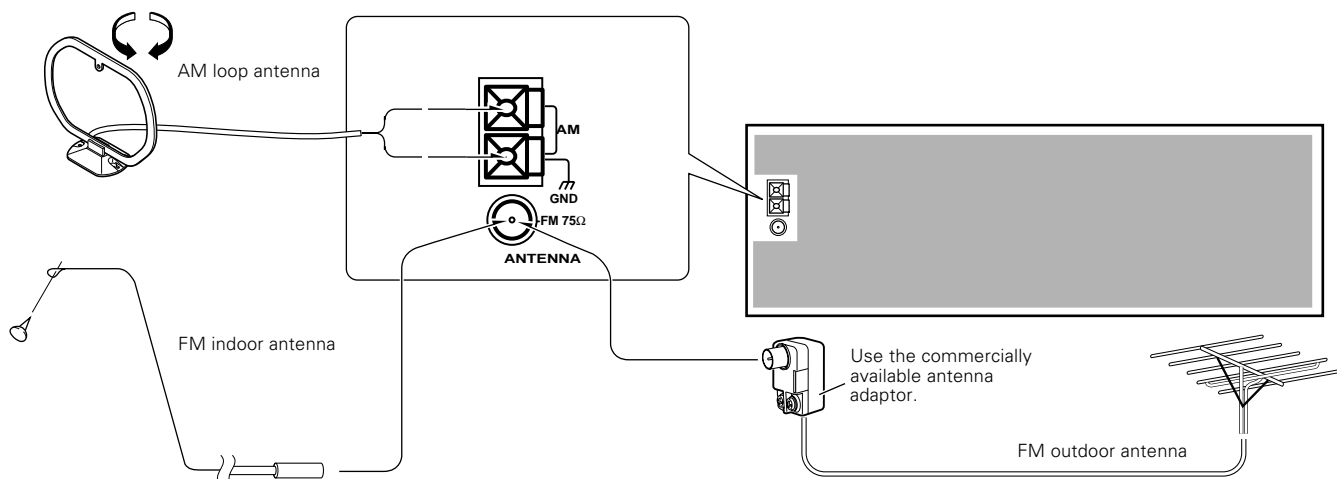

FM indoor antenna

The supplied indoor antenna is for temporary use only. For stable signal reception we recommend using an outdoor antenna. Disconnect the indoor antenna when you connect one outdoors.

FM outdoor antenna

Lead the 75Ω coaxial cable connected to the FM outdoor antenna into the room and connect it to the FM 75Ω terminal.

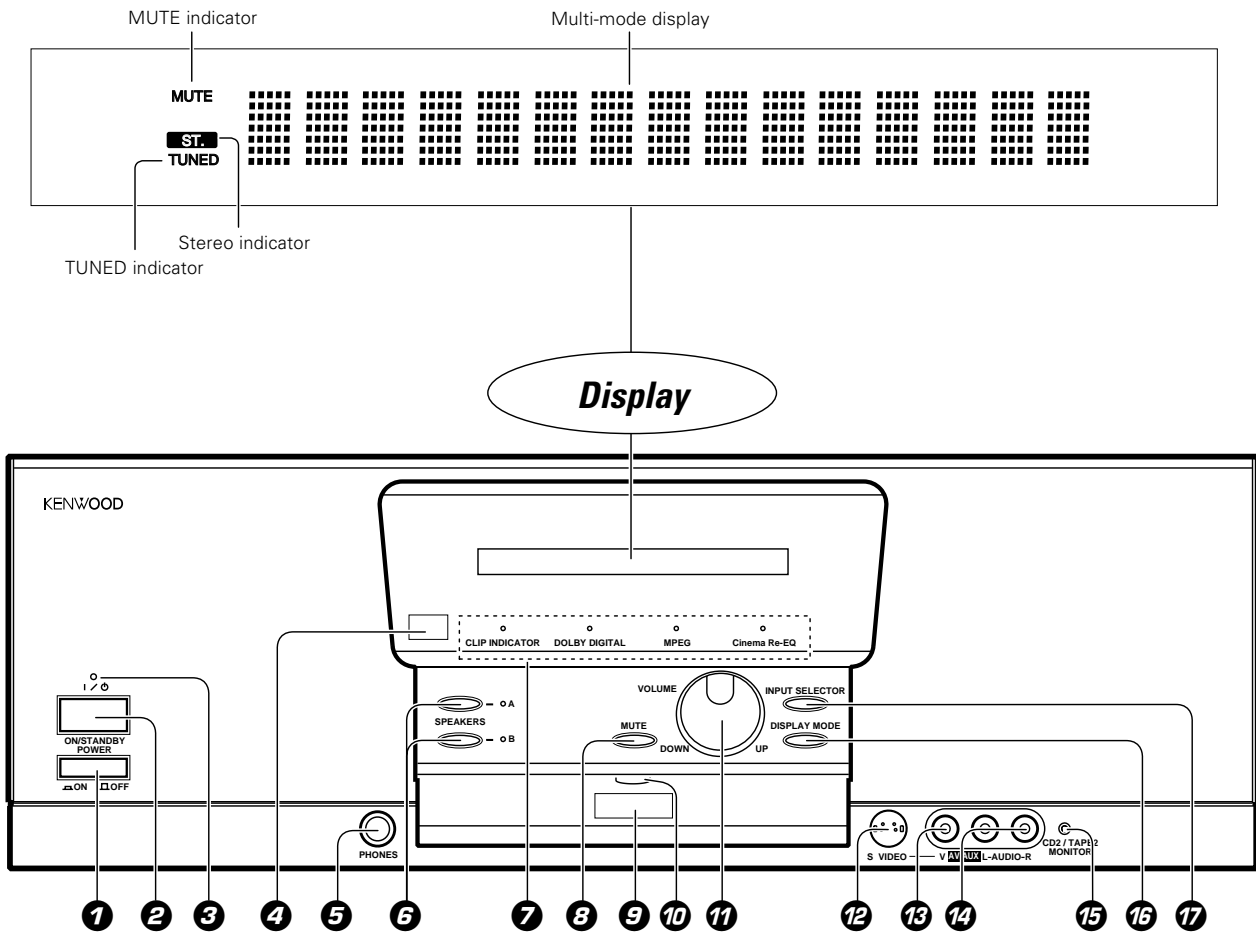

1 POWER key

Press to switch the main power ON and OFF.

2 ON/STANDBY (I / O) key

Press to switch the power mode between STANDBY and ON.

3 Standby indicator

Lights in standby mode.

4 Remote sensor

Receives signals transmitted from the remote control unit.

5 PHONES jack

Use for listening to audio through headphones.

6 SPEAKERS keys

Press each key to switch the SPEAKERS A or SPEAKERS B ON and OFF.

7 Indicators

CLIP INDICATOR :

Lights when the input is clipped during analog to digital signal conversion. → 30

DOLBY DIGITAL :

Lights when Dolby Digital is activated. → 44

MPEG :

Lights when the MPEG is activated. → 44

Cinema Re-EQ :

Lights when the Re-EQ is activated. → 47

8 MUTE key

Press to mute the audio temporarily.

9 Remote transmitter

Sends signals to the remote control unit.

10 Communication indicator

Lights when signal is input from or output to the remote control unit.

11 VOLUME control knob

Rotate to adjust the volume.

12 S VIDEO input jack (AV AUX)

Connect the S VIDEO output jack of an AV component.

13 VIDEO input jack (AV AUX)

Connect the composite video output (RCA) jack of an AV component.

14 AUDIO (L, R) input jacks (AV AUX)

Connect the audio output (RCA) jacks of an AV component.

15 CD2/TAPE2 MONITOR indicator

Lights when the CD2/Tape2 (Monitor) input is used. → 50

16 DISPLAY MODE key

Press to switch the display on the receiver. → 28

Press for more than 2 seconds to switch the recording mode. → 49

17 INPUT SELECTOR key

Press to switch the input as shown below.
 TUNER
 CD1
 MD/Tape1
 VIDEO1
 VIDEO2
 VIDEO3
 VIDEO4
 AV AUX
 PHONO

Standby mode

While the standby indicator of the unit is lit, a small amount of current is flowing into the unit's internal circuitry to back up the memory. This condition is referred to as the standby mode of the unit. While the unit is in the standby mode, it can be turned ON from the remote control unit.

Setup of the remote control unit

Controls and indicators

Note

Perform "Model Type Setup" of the remote control before using it. - 16

The following menu display appears after the batteries are loaded for the first time.

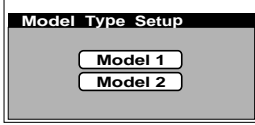
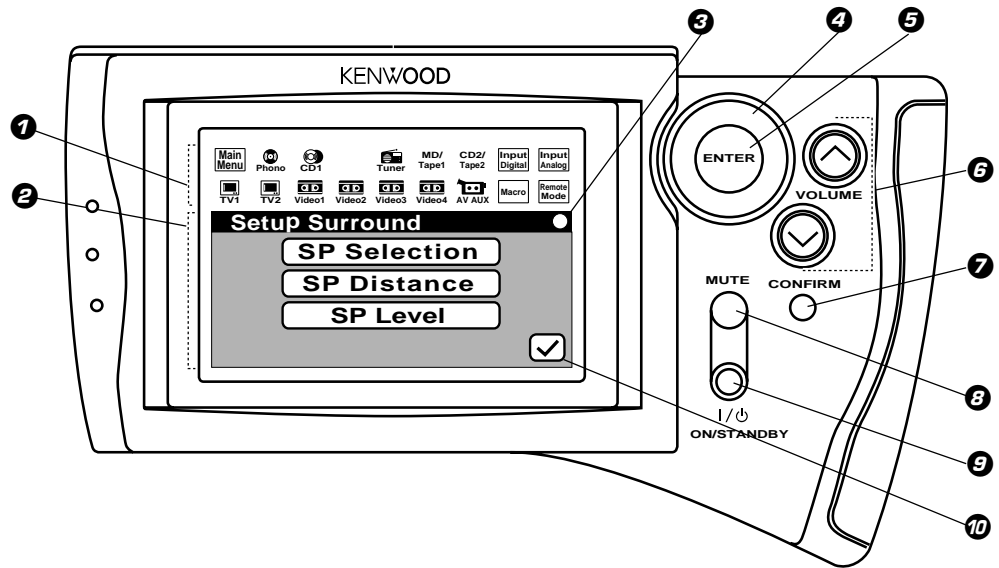
1 Segment screen

The fixed icons are displayed in this area.

- **Main Menu icon** : Select to display the Main Menu screen. - 18
- **Phono icon**
- **CD 1 icon**
- **Tuner icon**
- **MD/Tape 1 icon**
- **CD 2/Tape 2 icon**
- **Video 1 icon**
- **Video 2 icon**
- **Video 3 icon**
- **Video 4 icon**
- **AV AUX icon**

Select to switch input and control the selected input. (Phono and AV AUX : Input selection only) - 32 - 35

- **TV 1 icon**
- **TV 2 icon**

Select to control TV. - 35

- **Macro icon** : Select to control macro operation. - 26
- **Input Digital icon** : Select to play a digital input. - 29
- **Input Analog icon** : Select to play an analog input. - 29
- **Remote Mode icon** : Select to switch the remote control operation mode without changing the selected input. - 49

2 Menu screen

Control key icons and control levels are displayed in this area.

3 Communication status display

Shows the communication status. - 17

4 Joy stick

This key is used to select an icon. This key can be controlled in 4 directions. - 17

5 ENTER key

Press to enter the selection of an icon. - 17

6 VOLUME (up, down) key

Press to control the volume.

7 CONFIRM key

Press to confirm the currently selected items. - 17

8 MUTE key

Press to mute the audio temporarily.

9 I/O (ON/STANDBY) key

Press to turn the receiver and the components connected to it through system cords between ON and STANDBY modes.

10 Return (✓) icon

Select to return to the previous menu screen. - 17

Approximate operating range

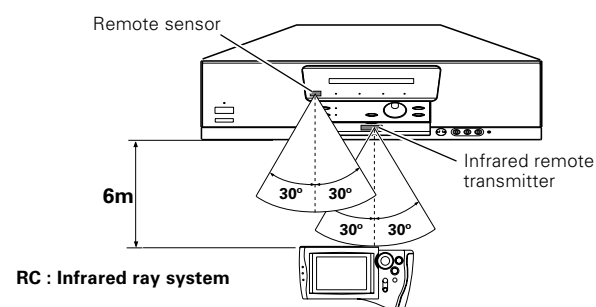

1. The supplied batteries are intended for use in operation check. Therefore, their lives may be shorter than ordinary batteries.
2. When the remote-controllable distance gets shorter than before, replace all four batteries with new ones.
3. Malfunction may occur if direct sunlight or the light of a high-frequency lighting fluorescent lamp enters the remote sensor. In such a case, change the system installation position to prevent the malfunction.
4. The remote control display may show erroneous information when the remote control unit is operated from outside the specified range.



Setting up the remote control according to your receiver

Perform the following procedure after inserting batteries for the first time or when the remote control back-up data has been lost.

Preparations

- Press the **POWER** key and **ON/STANDBY** key of the receiver to turn it ON.

Low battery alarm

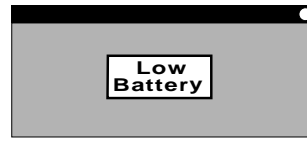

When the alarm message appears to indicate that the remaining power is low, replace all the batteries with new ones.

Model Type Setup

1 Loading batteries

① Remove the cover.

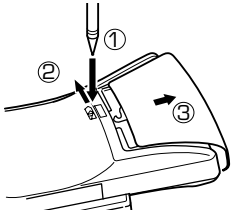

② Insert batteries.

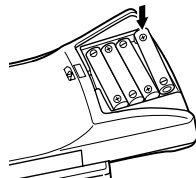

③ Close the cover.

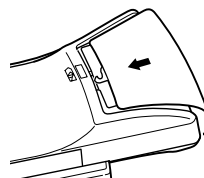

- Insert four AA-size (R6/UM-3) batteries as indicated by the polarity marking.
- To maintain the memory of the settings you made before, complete the battery replacement operation within 30 seconds.

2 Check the display.

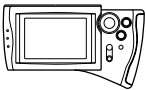

The "Model Type Setup" screen appears.

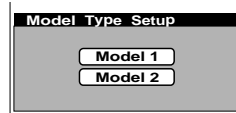

- If the remote control backup data is kept stored when the batteries are replaced, the "Model Type Setup" menu screen is not displayed. In this case, operations in ②, ③, ④ are not necessary.

3 Move the cursor to "Model 2".

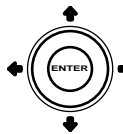
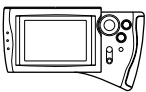

Move the cursor.

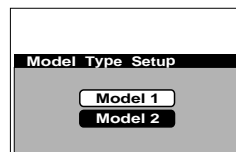

- It can be moved in 4 directions, depending on how you select the icon.

4 Enter the selection.

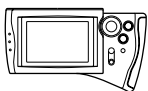

Press the ENTER key.

- After selecting an icon, always be sure to press the **ENTER** key to enter the selection.

To reset the remote control

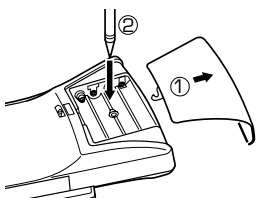

- ① Open the cover and remove batteries.
- ② Press the reset button with the tip of a thin object for a few seconds.

- This operation clears all of the previously set-up data.

Basic operation



The display's backlight will be turned off if the remote control was left for several seconds without any operation. In this case, touch any key to turn the display back on.

- When the display is off, the first press of the **ON/STANDBY** key does not turn on or off the system, but turn on the display.

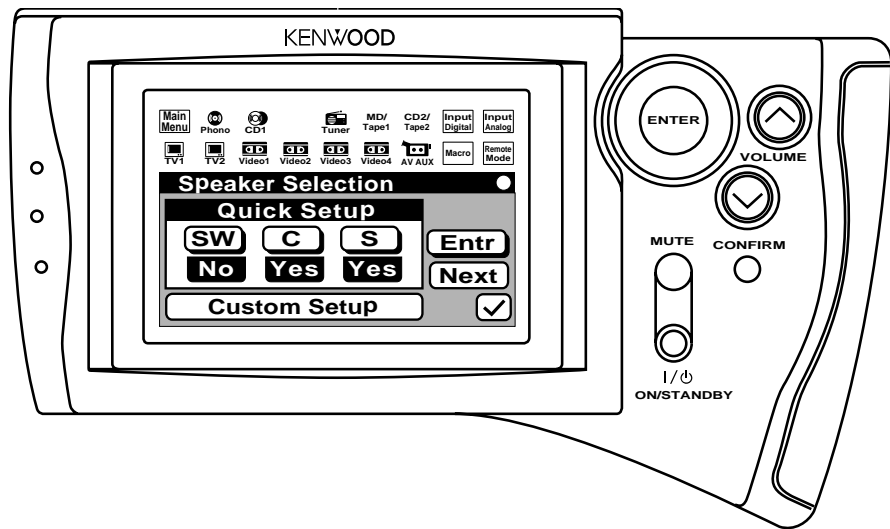

Basic use of the remote control

1 Move the cursor to the icon you want to select.

joystick

- You can move the joystick up, down, left, or right, but not diagonally.

Icons :

Shadow

Icons with shadow :
activate the functions or commands when they are selected.

Custom Setup

Icons with no shadow :
open related menu screens when they are selected.

Functions

Communication status display

Transmitting

Receiving

Transmission/reception inhibited

Confirm the current status



When you want to know the current settings, or when the display shuts off, press the CONFIRM key to show the current status on the display.

2 Enter the selected icon.

ENTER key

You will find the **Entr** icon in some menu screens. Even in this case press the ENTER key after you have selected the icon.

- This operation is omitted in other pages in order to simplify the explanations.

Return to the previous display



Return icon

Selecting the "Return(check-mark)" icon leads you to the previous menu screen.

- Select "Main Menu" icon if you want to go back to the first menu screen.

Navigating through the screens of remote control unit

The remote control unit is given with a hierarchical structure so that it can display a large number of functions. For instance, the menu screens for use in setup can be accessed from the "Main Menu" screen as shown below.

- ❶ To display the "Main Menu" screen, first select the "Main Menu" icon from the segment screen.

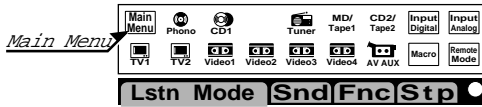

The "Main Menu" screen includes the "Lstn Mode" (Listen Mode), "Sound", "Function" and "Setup" menu screens under it. These menu screens can be displayed by moving the cursor on icons "Lsn", "Snd", "Fnc" and "Stp" respectively.

The "Main Menu" screen has the following 4 menu screens under it.

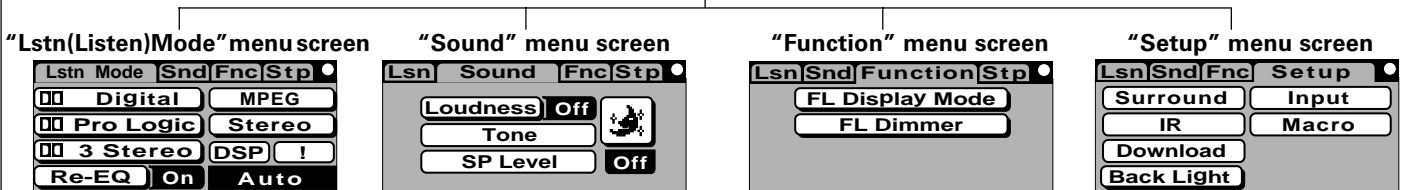

- ❷ Move the cursor to "Stp" icon in the "Main Menu" screen to display the "Setup" menu screen.

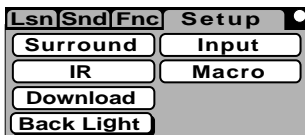

- Selecting an icon with shadow (the "Back Light" icon in this example) activates the function of the icon.
- The icons without shadow (the "Surround", "IR", "Download", "Input", and "Macro" icons in this example) have more menu screens under each icon.

- ❸ Select the "Surround" icon to display the "Setup Surround" menu.

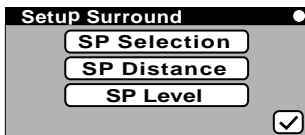

- ❹ If the "SP Selection" icon is selected...

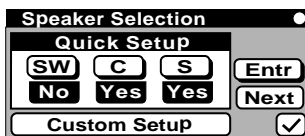

- ❺ If the "Next" icon is selected...

(If "Custom Setup" is selected)



(If "Next" is selected)

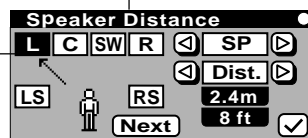

- ❻ If "Next" is selected...

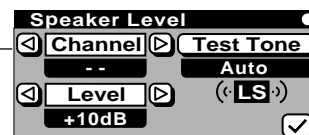

To return to the previous menu screen



Select the "✓" (checkmark) icon to return to the menu screen in the hierarchy level immediately above the current level.
Select the "Main Menu" icon to return to the "Main Menu" screen at the highest level.

Assigning the connected components to the selected inputs

General setup flow

- 1 Open the "Setup" menu and select "IR" icon.
- 2 Assign the connected components to the displayed inputs.
- 3 Assign all the connected components.



The TV icons that appear on the segment screen after the setup allow you to use the remote control to control your TV without connecting it to the receiver as an input.

1 Open the "Setup" menu and select "IR" icon.

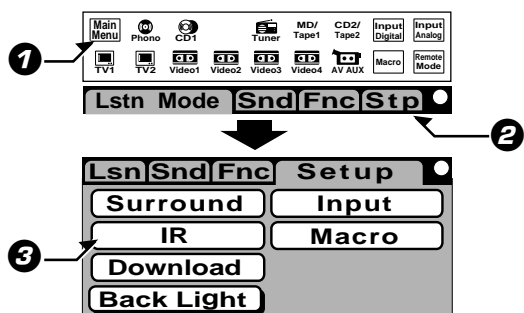

- 1 Select the "Main Menu" icon.
 - If the "Setup" menu screen shown on the left has already been appeared, step 1 can be skipped.
- 2 Select the "Stp" icon.
- 3 Select the "IR" icon.

2 Assign the connected components to the displayed inputs.

Select an input jack name, consult the Setup Codes chart (on the attached sheet) to find out the setup code of the component connected to the selected input, and enter the 4-digit setup code to assign it to the selected input.

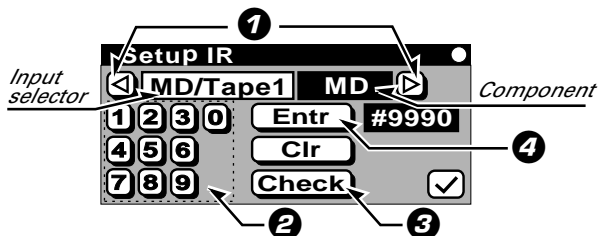

When registering setup codes for KENWOOD audio components which are connected to this unit by system control cords, use the following codes to insure proper system control operation:

- Cassette deck : 7990
- Single CD player : 8990
- Carrousel CD player : 8991
- Multiple CD player (OUTPUT A to CD 1 jacks) : 8992*1
- Multiple CD player (OUTPUT B to CD2/TAPE2 MONITOR jacks) : 8993*2
- MD recorder : 9990

*1 This code is only for OUTPUT A operations and for a multiple CD player which does not have separate outputs such as OUTPUT A and B.
 *2 This code is only for OUTPUT B operations. For a multiple CD player which does not have separate outputs such as OUTPUT A and B, use codes on the Setup Code chart.

- 1 Select the ◀ or ▶ icon to select an input.

- CD1
- MD/ Tape 1
- CD 2/Tape 2
- TV1
- TV2
- Video1
- Video2
- Video3
- Video4

The inputs are switched every time the ◀ or ▶ icon is selected.

- 2 Find out the setup code of the actually connected component from the Setup Codes chart and input the code using icons 1 to 0.
- 3 Select the "Check" icon to test the component.
 - If the proper code has been entered, the component's power will turn on. However, the components which have one of the codes shown on the left and some components from manufacturers other than KENWOOD cannot be turned on.
 - Select "Clr (Clear)" icon to cancel.
- 4 Select the "Entr (Enter)" icon to register the code.
 - Icons of the registered components appear on the segment screen.

To delete a setup code → 21

3 Assign all the connected components.

Repeat step 2 for each component connected.



Setup of components which are not listed in the Setup Codes chart (Futureset)

This service will be available until 31 March 2001.

If your connected components are not listed in the Setup Codes chart, its' setup codes can be downloaded through a telephone line.

1 Write down the brand name and model number of your component in the space provided before your call.

	Type	Brand	Model No.	Remote Model No.
	TV	KENWOOD	KV-????	RC-????
1				
2				

	Type	Brand	Model No.	Remote Model No.
3				
4				
5				

2 Call our Free-Phone Consumer Help-Line and explain which components you would like to add to your remote control.

UK (including N. Ireland) : 0800-898520

- This number is designed specifically for "Futureset Upgrade", questions about system operation should be first addressed to your place of purchase.
- The hours for customer service are:
Monday-Friday 9:00 am - 7:00 pm
Saturday 9:00 am - 3:00 pm

- After our customer service representative records the brand name and model number of your component, he/she will ask you to hold the remote to the speaker portion of your telephone as shown below.
Your remote control is KENWOOD model number: RC-R0807

Complete steps 3 and 4 before holding the remote to the speaker portion of your telephone.

3 Open the "Setup" menu and select the "Download" icon.

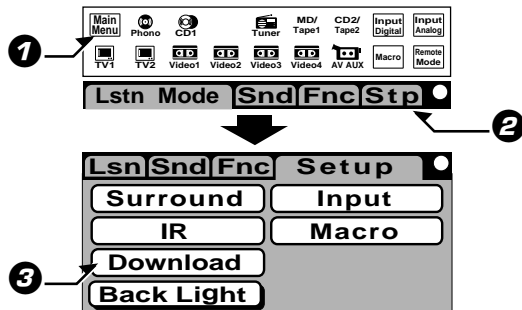

- 1 Select the "Main Menu" icon.
- 2 Select the "Stp" icon.
- 3 Select the "Download" icon.

4 Select the "Download" icon.



- "Loading" is displayed during readout of the remote control codes.
- The backlight is turned off during "Loading".
- To cancel downloading in the middle, select the **CONFIRM** key for more than 2 seconds. As "Canceled" appears, select the icon to exit the operation.

5 Receive the setup codes through the telephone.

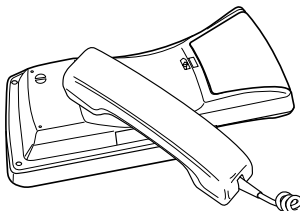

Place the receiver speaker of the telephone set on the coil section of the remote control (as shown in the illustration on the left).

- The operator supplies each setup code number. Should you ever need to change your input configuration, this number can be used. Please record for your future reference.
- After reception, the "Loading" message changes to the "Done" message, which is shown for a few seconds.

Code selection after mode download

After successful completion of the download, step 2 of the previous page, the remote control automatically enters a special set-up mode which works as described below.

1 Select the input and component names that you want to register a setup code.

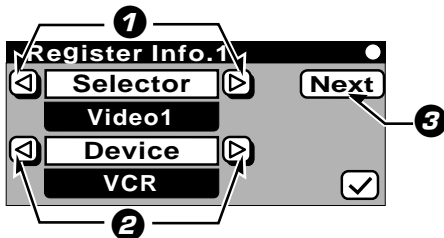

- 1 Select the input name by selecting the ◀ or ▶ icon of "Selector" (input selector).
This changes the section of "Video1" in the figure.
- 2 Select the component name by selecting the ◀ or ▶ icon of "Device" (component connected to the rear panel input jacks).
This changes the section of "VCR" in the figure.
- 3 Select the "Next" icon.
The "Register Info.2" menu screen appears.

2 Find out the numeric icon that outputs the power code of the component.

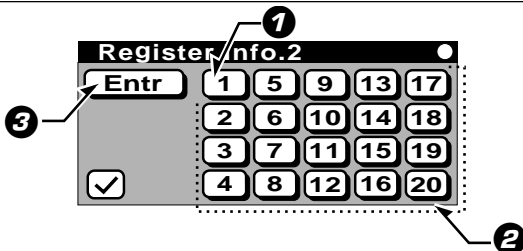

- 1 Select the 1 icon to output its power code.
After selecting a numeric icon, be sure to press the ENTER key to output its power code.
- 2 Select numeric icons in order from "1" until the component selected in step 1 is turned ON (i.e. repeat step 1 for each numeric icon).
- 3 Select the "Entr" icon after the component has turned ON.

Though the "Futureset" memory in your remote control is quite large, only 20 different devices power codes can be put on the keypad at any one time. If you require a larger download, the standard setup procedure can be used. See "Assigning the connected components to the selected inputs", your customer service representative can supply you with the downloaded setup codes numbers.

3 Set up all the downloaded codes.

Repeat the operations of step 1 and 2.

- The setup code for the last power code to be sent in step 2 is automatically registered at the location selected in step 1.

To delete a setup code

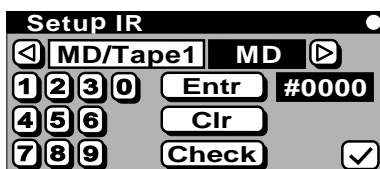

- Once the setup code is registered and you switch to a different menu screen, the code display is back to "#0000".
- When a setup code has been downloaded, the section where "#0000" displays "# - - - -".
When setup codes of more than one components have been downloaded, note that all of the codes are interrelated between each other. Therefore, if any of them is deleted, you should perform the procedure of "Setup of components which are not listed in the Setup Codes chart" from the beginning.

- 1 Open the "Setup IR" menu screen shown on the left.
Follow the step 1 of "Assigning the connected components to the selected inputs".
- 2 Select the component to be deleted.
Select the component with the ◀ or ▶ icon.
- 3 Select the 4 digit code "9999".
- 4 Select the "Entr" icon.

General setup flow

- ❶ Open the "Setup" menu screen and select the "Surround" icon.
- ❷ Select the "SP Selection" icon.
- ❸ Select the on/off conditions or sizes of the speakers.
- ❹ Set the "Speaker Distance".
- ❺ Adjust the "Speaker Level".

❶ Open the "Setup" menu and select the "Surround" icon.

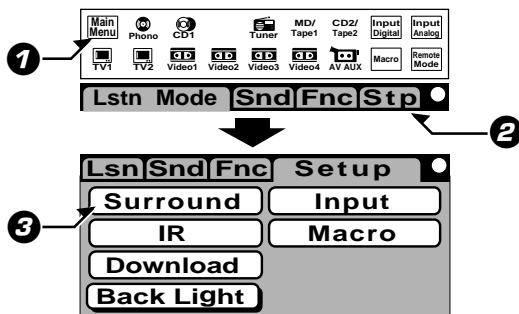

- ❶ Select the "Main Menu" icon.
- ❷ Select the "Stp" icon.
- ❸ Select the "Surround" icon.

❷ Select the "SP Selection" icon.

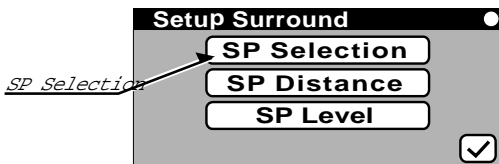

❸ Select the on/off conditions or sizes of the speakers.

If you want a simplified setup operation, select "Quick Setup".

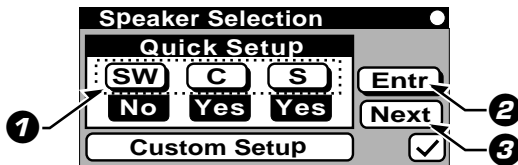

SW : Subwoofer
 C : Center speaker
 S : Surround speaker

- ❶ Set the "Yes" or "No" condition for each speaker .
 Yes : The speaker is connected.
 No : The speaker is not connected.
- ❷ Select the "Entr" icon to enter the selection.
- ❸ Select the "Next" icon to go to the next step.

Continued to the next page

3 Continued from the previous page

If you want a detailed setup operation, select "Custom Setup".

When using wideband speakers, it is recommended to set the speaker size in "SP Selection (Custom)" to "Lrg".

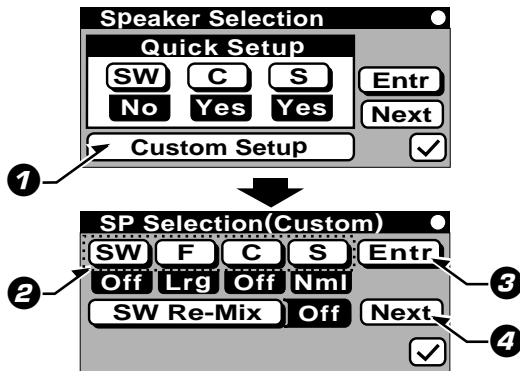

SW : Subwoofer
 F : Front speaker
 C : Center speaker
 S : Surround speaker

① Select "Custom Setup" icon in the "Speaker Selection" menu screen.

② Set the details of each speaker.

Lrg : Large-sized speaker
 Nml : Midium- or smaller-sized speaker
 On : The speaker is connected
 Off : The speaker is not connected.

③ Select the "Entr" icon to enter the selection.

List of the relationship between speaker size and on/off

F	SW	C	S
Lrg	On/Off	Off/ Nml/ Lrg	Off/ Nml/ Lrg
Nml	On	Off/ Nml	Off/ Nml

● Setting **SW Re-Mix** to On adds the low-frequency components of F, C and S to SW.

④ Select the "Next" icon to go to the next step.

4 Set the "Speaker Distance".

Delay time for each speaker is adjusted in this step.

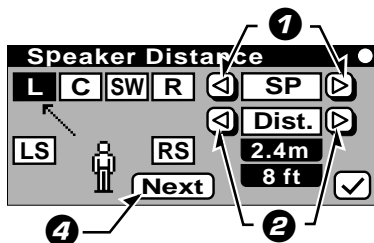

① Select the speaker (SP) with the ◀ or ▶ icon of "SP".

② Select the distance between the listening position and the speaker (Dist.) with the ◀ or ▶ icon of "Dist".

③ Set for each speaker by repeating ① and ②.

④ Select the "Next" icon to go to the next step.

5 Adjust the "Speaker Level".

By listening the test tone (noise-like sound), adjust all speakers' level to equal .

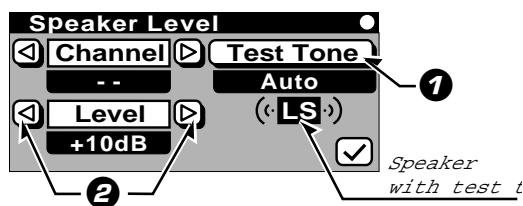

① Select the "Test Tone" icon and set to "Auto".

The icon can be switched to "Off", "Auto" and "Manual" in order.

② Adjust the speaker level with the ◀ or ▶ icon of "Level" when the test tone comes out from the one you want to adjust.

● When "Manual" is selected above, select each speaker with the ◀ or ▶ icon of "Channel" and adjust its level.

③ Adjust each speaker level.

Setup for macro play (automatic operation)

KRF-V7771D (En/T)

24

Setting up the remote control unit for macro play (automatic operation)

General setup flow

- 1 Open the "Setup" menu and select "Macro" icon.
- 2 Select the input to control.
- 3 Selection in the "Macro Edit: Custom 1" screen
- 4-6 Setting the target component in the "Edit" menu

The macro play function allows you to set the remote to control several components in succession. After completing this setup, you can perform a series of operations automatically. Enter the setup codes for the components you want to control beforehand.

1 Open the "Setup" menu and select "Macro" icon.

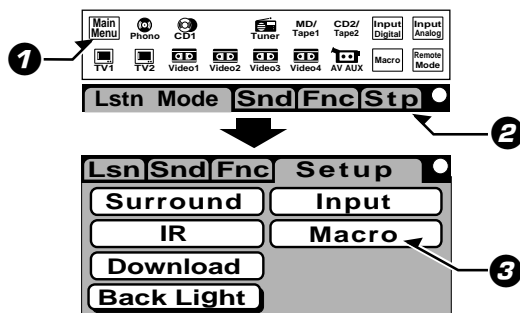

- 1 Select the "Main Menu" icon.
- 2 Select the "Stp" icon.
- 3 Select the "Macro" icon.

2 Select the input to control.

Three kinds of macros, "Custom 1", "Custom 2" and "Custom 3" can be set and registered.

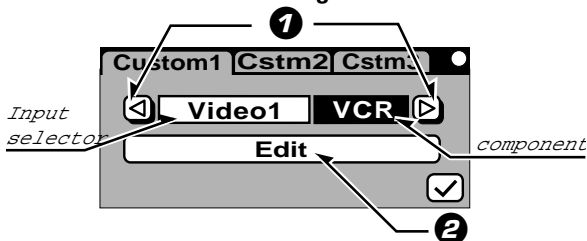

Example when the VCR is assigned to "Video1".

- 1 Select the input to be played with the ◀ or ▶ icon. Each selection of the icon switches the inputs as follows.
→ VIDEO1 ↔ VIDEO2 ↔ VIDEO3 ↔ VIDEO4 ↔ CD1
↔ MD/Tape1 ←

- 2 Select the "Edit" icon.
 - The **Edit** menu is not displayed if none of the connected components has been assigned to **Video1**.

3 Perform operation in the "Macro Edit: Custom 1" screen.

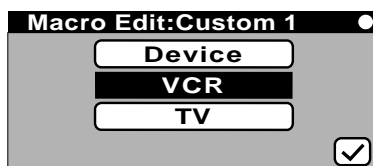

To set the timing of the component selected in step 2 above, select the icon corresponding to the component.

- **Device** : Open the menu screen to set up the connected devices (components).
- **TV** : Open the menu screen for the TV setup.

4 Operation in the "Custom 1 Edit: VCR" screen.

If the "Device" icon is selected in step 3, the menu screen below appears.

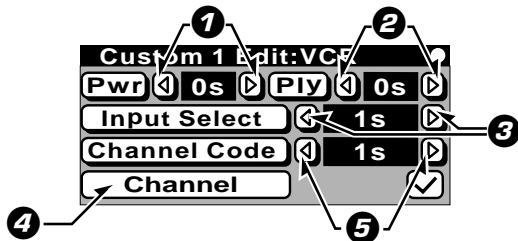

- The output timing of each code can be switched as shown below.
 → -- ↔ 0s (second) ↔ 1s ↔ 2s ↔ ↔ 15s ←
 "- ." indicates that no code is output, and "0s" indicates that the code is output at the same time as a macro execute icon is selected.
- The component name after "Edit:" is switched to "VCR", "Cable", "Satellite", "LD", "DVD", "CD", "MD" or "Tape" according to the selected input.

Check the operation after setting the time. If macro play does not occur, increase the time settings with the following procedure.

- 1 Set the "Pwr" (Power) on time.
 Select with the ◀ or ▶ icon of "Pwr".
 - Select the "Pwr" icon to test the operation.
- 2 Set the "Ply" (Play) start time.
 Select with the ◀ or ▶ icon of "Ply".
 - Select the "Ply" icon to test the operation.
- 3 Set the "Input Select" code output timing of the VCR.
 Select with the ◀ or ▶ icon of "Input Select".
 - Select the "Input Select" icon to test the operation.
- 4 Open the "10key Pad" menu screen to select a channel.
 Select "Channel" icon.
 - Set as described in step 5.
- 5 Set the "Channel Code" output timing of the VCR.
 Select with the ◀ or ▶ icon of "Channel Code".
 - Select the "Channel Code" icon to test the operation.

5 Operation in the "10key Pad (Macro)" screen.

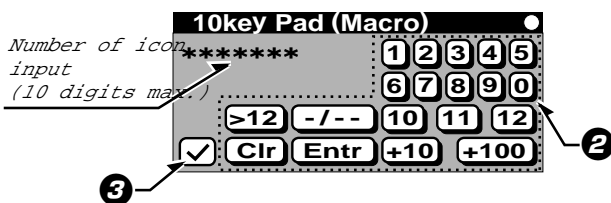

- Clr : Select to clear all the input "*"
 Entr : Select when it is required to enter a value selection.
 >12 : Select when inputting a channel value of 13 or more.
 -/-- : Select to switch between the 1-digit input or 2-digit input.

- 1 Select the "Channel" icon in step 4 to open the "10key Pad (Macro)" menu screen.
- 2 Set a channel.
 (Example)
 To set CH 11 : Select the +10, and then 1 icons.
 - The way to input channel differs depending on manufacturers. Refer also to the manual of your connected components.
- 3 Select the icon to establish the selection.
 When is selected, the screen returns to the previous menu.
 - To output a set channel code, select the "Channel Code" icon in step 4.

6 Perform selection in the "Macro Edit: Custom 1, 2 or 3" menu screen.

If the "TV" icon is selected in step 3, the menu screen below appears.

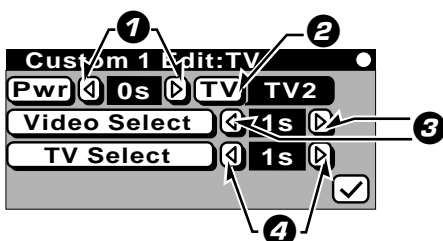

- Pwr :Setting of the TV's "Pwr" code output timing.
 TV :Selection of the controlled TV from "TV1" and "TV2".
 Video Select :Selection of the TV's "Video Select" code output timing.
 TV Select :Selection of the TV's "TV Select" code output timing.

Check the operation after setting the time. If macro play does not occur, increase the time settings with the following procedure.

- 1 Set the "Pwr" (power) ON time.
 Select with the ◀ or ▶ icon.
 - Select the "Pwr" icon to test the operation.
- 2 Select whether "TV1" or "TV2" is to be controlled.
- 3 Set the "Video Select" code output timing.
 Select with the ◀ or ▶ icon.
 - Select the "Video Select" icon to test the operation.
- 4 Set the "TV Select" code output timing.
 Select with the ◀ or ▶ icon.
 - Select the "TV Select" icon to test the operation.

Macro Execute

By setting up the items in "Setting up the remote control unit for macro play (automatic operation)", you can start automatic play using the macro function.

1 Select the "Macro" icon .

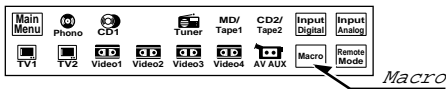

2 Execute a macro in the "Macro Execute" menu screen.

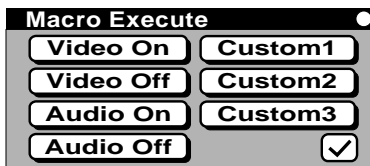

Select the icon of the component to be controlled.

Video On : Turns the video component's power ON. The receiver's power will be turned on at the same time. TV's power will be turned ON and OFF alternately everytime "Video On" icon is selected.

Video Off : Turns the video component's power OFF. The receiver's power will be turned off at the same time. TV's power stays the same although "Video Off" icon is selected.

Audio On : Select to turn on the audio components.(In the case of system connection)

Audio Off : Select to turn off the audio components.(In the case of system connection)

Custom 1 : Select to execute "Macro Custom 1".

Custom 2 : Select to execute "Macro Custom 2".

Custom 3 : Select to execute "Macro Custom 3".

- May not operate normally depending on the video signals of the connected components.

Playing music

Use the following procedure to play a CD or MD.

Preparation

- ❶ Perform the operations in "Connections" chapter.
- ❷ Perform the operations in "Setup" chapter.

Switching between digital input and analog input

Select "Input Analog" or "Input Digital" according to the input you are going to listen to.

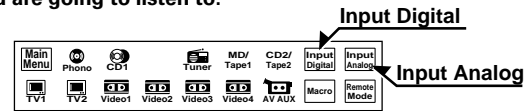

For switching, refer to the "Playback of digital input/playback of analog input". → 29

1 Press the ON/STANDBY (POWER) key to turn the unit ON.

Main unit

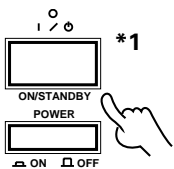

RC



- *1 : Press the **POWER** key to ON before pressing the **ON/STANDBY** key.
- Load the CD player or MD recorder with the disc to be played.

2 Select the source.

Main unit

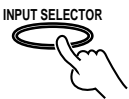

RC

Select the icon of the desired source.

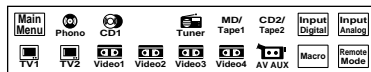

On the main unit, the input sources are switched in the following order :

- Tuner (Frequency display)
- CD1
- MD/Tape1
- VIDEO1
- VIDEO2
- VIDEO3
- VIDEO4
- AV AUX
- PHONO



Be sure to perform the setups in "Setup" chapter if you want to control the system control operations.

3 Play the selected input source.

Main unit

Operation of the source component

RC

Select the play icon



4 Adjust the volume.

Main unit

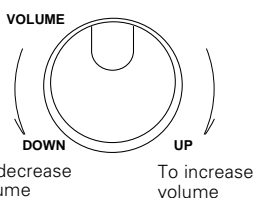

RC

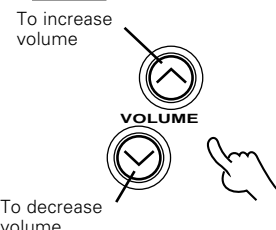

- Turning the **VOLUME** control at a high speed increase the volume change rate. (**AI VOLUME** function)
- The input source (which is indicated on the receiver) cannot be played while "CD2/Tape2 (Monitor)" is on (which is indicated by the lightning of the indicator on the receiver front panel).



Select the speakers

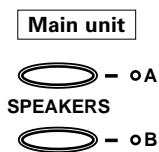

- A ON** (indicator A lights up) : Listening in **SPEAKERS A**
- B ON** (indicator B lights up) : Listening in **SPEAKERS B**
- A + B ON** (Both indicators light up) : Listening in both **SPEAKERS A and SPEAKERS B**
- A + B OFF** (Both indicators are off) : **Muting all speakers**

● If the VIDEO 4 input has been set to 6ch input, and the input is selected, the speakers A system will be on automatically. Speakers B system cannot be selected in this case.

Listening through headphones

1 Plug headphones.

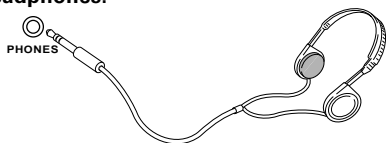

- To listen to a Dolby Digital (AC-3) or MPEG source through headphones, play it in stereo by selecting the **"Stereo"** icon in the **"Lstn Mode"** menu screen or switch the speakers off.

2 Adjust the volume.

Main unit

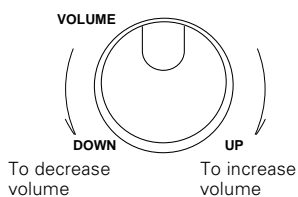

RC

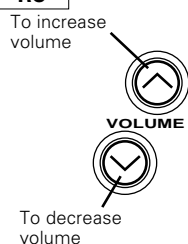

Muting audio temporarily

Main unit

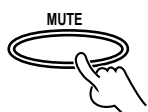

RC

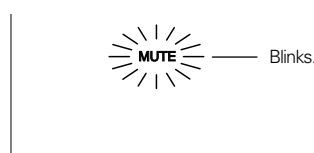

To cancel muting

Press the MUTE key again or adjust the volume.

Switching the display mode (DISPLAY MODE key)

Main unit

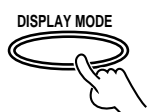

Press the DISPLAY MODE key.

Each press switches the mode as follows.

- | | | |
|---|--|---|
| <p>→ Connected component analog/digital display
(Example)
DVD DGTL
(VIDEO4 DGTL)*1
(DVD 6ch)*2</p> | <p>→ Input and connected component name display
(Example)
VIDEO4 : DVD
(VIDEO4 :)*1
(VIDEO4 : DVD)*2</p> | <p>→ Listen mode display
(Example)
DOLBY DIGITAL

(6ch INPUT)*2</p> |
|---|--|---|

*1 : when the connected component name is not assigned

*2 : when the DVD player is assigned to VIDEO 4, and the selector (VIDEO 4) is set to analog 6ch input mode.

Playback of digital input / playback of analog input

Switch the input setup of the receiver to "Input Digital" or "Input Analog" according to whether the input signal from the source component is digital or analog.

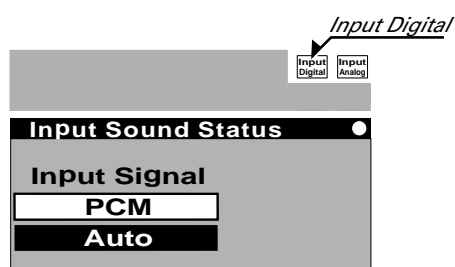

To play a digital input

Select the "Input Digital" icon.

The display is alternated every time the "Input Digital" icon is selected.

Auto ↔ Manual

- The type of the signal being played (PCM, etc.) is shown in the "Input Signal" display.
- When "Auto" is selected, the playback is switched automatically according to the input signal type from the source components. Select "Auto" for normal use.
- When "Manual" is selected, the listen mode is fixed. Select a desired listen mode.
- If the digital input is not connected to the receiver, select "Input Analog".

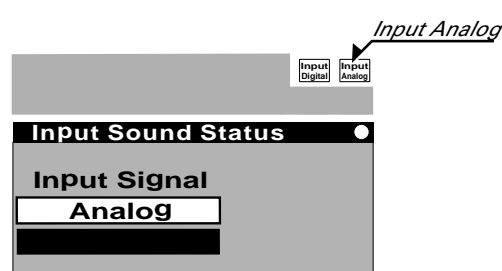

To play an analog input

Select the "Input Analog" icon.

- "Analog" is shown in the "Input Signal" display.

Setup of Input Level

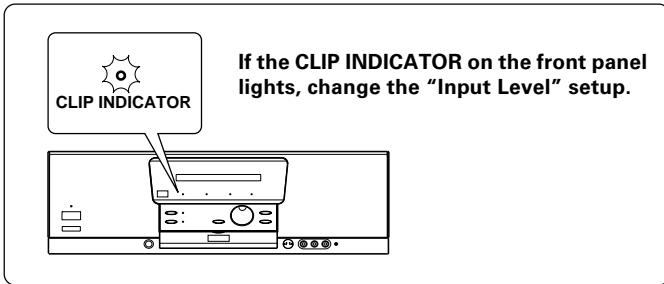

When in the 6ch input mode, adjust the input level with the source component.

1 Select the icon of the input for which you want to set the input level.

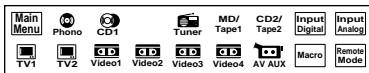

- When adjusting "CD1", "Video2", "Video3", "Video4", select the "Input Analog" icon from the segment screen for analog input, and then go to step 2.

2 Open the "Setup" menu and select "Input" icon.

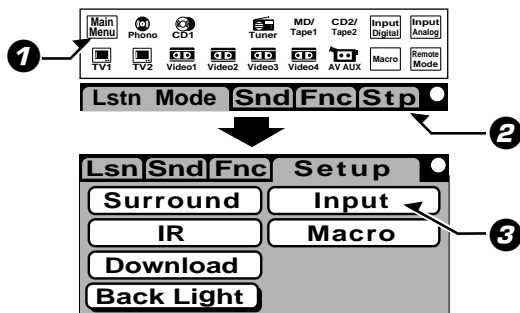

- ① Select the "Main Menu" icon.
- ② Select the "Stp" icon.
- ③ Select the "Input" icon.

3 Set the "Input Level".

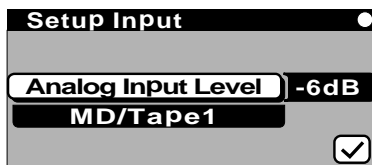

- The input level from the input selected in step 1 can be selected from "0 dB", "-3 dB" and "-6 dB". Each selection operation of the "Input Level" icon switches it. If the CLIP INDICATOR lights up, set the level of the selected input to "-3 dB" or "-6 dB".
- This setting is possible only for analog input.

Easy audio adjustment

The sound quality and the volumes of the speakers can be adjusted as required.

Use the procedure on this page to adjust the audio individually, on a per-source or per-program (movie) basis.

The effects of the loudness and tone setups are applied only to the sounds output from the "L" and "R" front speakers.

The loudness or tone control effect is maximized when "Lstn Mode" is set to "Stereo".

Therefore, when the front speakers are set to "Nml" (Normal), low-frequency components are output from the subwoofer so the loudness and tone effects are minimized.



The audio adjustment described below cannot be set out when in the 6ch input mode.

1 Open the "Sound" menu.

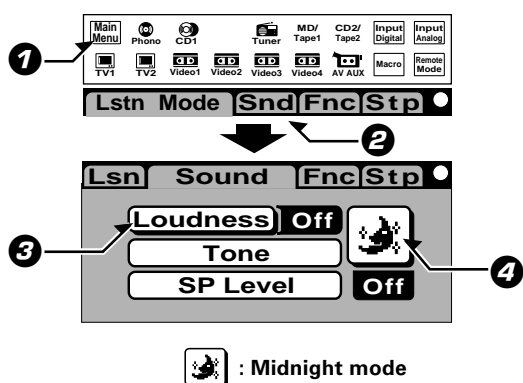

1 Select the "Main Menu" icon.

2 Select the "Snd" icon.

3 Select the Loudness On or Off.
This can be switched between and On → Off.

4 Set the midnight mode.
This setting is possible only with the Dolby Digital (AC-3) input source. 
This can be switched in order of 1 → 2 → Off.

- When adjusting the Tone, go to step 2.
- When adjusting the speaker level, go to step 3.

2 Adjust the "Tone".

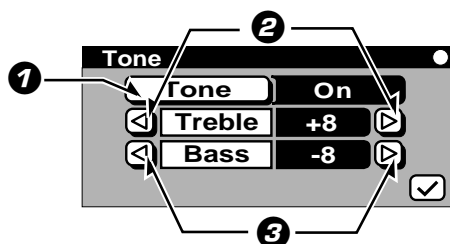

- Select the "Tone" icon in step 1.

1 Set "Tone" to "On" or "Off".

2 Adjust "Treble".

3 Adjust "Bass".

3 Adjust the "SP Level".

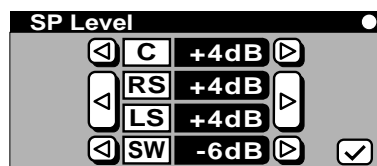

C : Center speaker
RS : Right Surround speaker
LS : Left Surround speaker
SW : Subwoofer

- Select the "SP Level" icon in step 1.
- To return to step 1 from step 2, select the icon.
- The speaker volumes adjusted here is only temporary. These settings are returned to the setups made in the "Setup" chapter when the power is switched off or another input is selected.
- The speakers which have not been set up in the "SP Selection" or "SP Selection (Custom)" menu screen under the "Setup Surround" menu are displayed as "-" in the "SP Level" menu screen.

Adjust the level of each speaker.

General operation flow

- 1 Selecting the icon of the component to be controlled from the segments



- The selected input changes according to the selection.

- 2 Performing operation in the menu screen of the selected component

The marketed models are variable depending on countries and areas. Please find the operation descriptions that are applicable to your model.

- Complete the operation in "Assigning the connected components to the selected inputs" beforehand. → 19
- Although the menu screen of each component is variable depending on the setup code, this section uses the most typical control menu screens for ease of description.
- Refer to the instruction manual of each component for details.

Remote control of a multiple CD player

CD1 remote control

- 1 Select the "CD1" icon.

- The "CD1" input is selected.

- 2 Select the icon to be controlled.

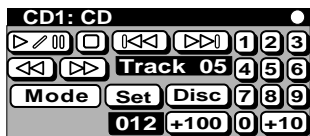

Example of menu screen :
When the system setup code is input

CD 2/Tape 2 remote control

- 1 Select the "CD2/Tape2" icon.

- The "CD2/Tape2" input is selected.

- 2 Select the icon to be controlled.



Example of menu screen :
When the system setup code is input

- When switching to other inputs, make sure to switch off the "CD 2/ TAPE 2 MONITOR" indicator with "CD 2/Tape 2" icon.

CD Text playback

- 1 Select the "CD1" icon.

- The "CD1" input is selected.

- 2 Select the "Mode" icon.



- The "CD Mode" menu appears when the "Mode" icon is selected.

- 3 Select "More" in the "CD Mode" menu screen.

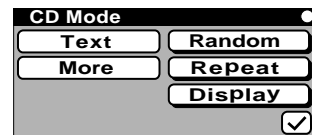

- The CD Mode (More) menu screen appears..

- 4 Operation in the "CD Mode (More)" menu screen.

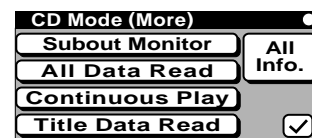

- 1 Complete "All Data Read" on the CD player before executing "Title Data Read".

- 2 Select the "Title Data Read" icon to read the disc title data. *1

- Select the "✓" (checkmark) icon to return to the screen in 5.

- 5 Select "Text" in the "CD Mode" menu screen.

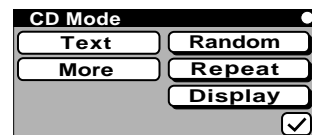

- The CD text display screen appears..

- 6 Read the CD text display screen. (Playing the CD)



D : Disc No.

T : Track No.

* : Track title read *2

- 1 Select the disc.

- 2 Select the playback icon.

- The CD can also be played by selecting one of the titles being displayed.

- *1 : Title Data Read

When the "Title Data Read" icon is selected, the indicator on the receiver main unit lights up. Do not displace the remote control unit during this. The read time is variable depending on the data quantity, but it may sometimes take as long as a few minutes.

- *2 : Track Title Read

If the track title cannot be displayed properly, select the "Track Title Read" icon.



Single CD remote control

- It is necessary to assign the CD player input previously.

1 Select the "CD1" icon.

- The "CD1" input is selected.

2 Select the icon to be controlled.

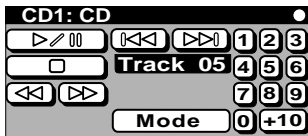

Example of menu screen :
When the system setup
code is input

3 Perform operation in the "CD Mode" menu screen.

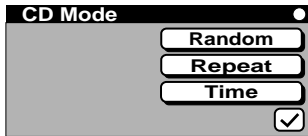

Remote control of non-KENWOOD CD player

- It is necessary to assign the CD player input previously.

1 Select the "CD1" icon.

- The "CD1" input is selected.

2 Select the icon to be controlled.

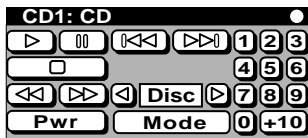

3 Select the icon to be controlled in the "CD Mode" menu screen.

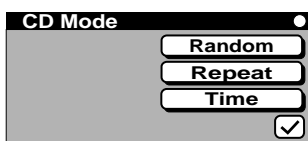

Carrousel CD remote control

- It is necessary to assign the CD player input previously.

1 Select the "CD1" icon.

- The "CD1" input is selected.

2 Select the icon to be controlled.

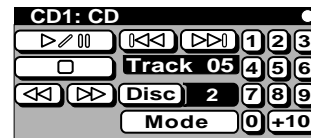

Example of menu screen :
When the system setup
code is input

3 Perform operation in the "CD Mode" menu screen.

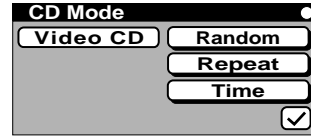

4 Perform operation in the "Video CD (CD)" menu screen.

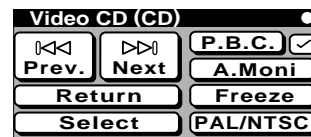

- To play a Video CD compatible CD player and outputs its video, connect its video and audio outputs to one of the sets of input jacks VIDEO1 to VIDEO4.
- When using a Video-CD player, remove the system control cord from the CD player.



Remote control of tuner

1 Select the "Tuner" icon.

- The "Tuner" input is selected.

2 Select the icon to be controlled.

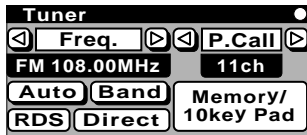

Remote control of DVD player

- It is necessary to assign the DVD player to one of the "Video" inputs previously.

1 Select the "Video1, 2, 3 or 4" icon.

- The "Video1/ 2/ 3/ 4" input is selected.

2 Select the icon to be controlled.

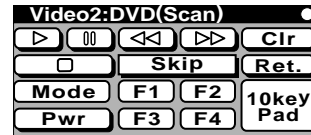

Pwr : Power
 Clr : Clear
 Ret. : Return

- The "Scan", "Skip" and "Slow" screens are available.

Remote control of MD recorder

- It is necessary to assign the MD recorder to the "MD/ Tape1" input previously.

1 Select the "MD/Tape1" icon.

- The "MD" input is selected.

2 Select the icon to be controlled.

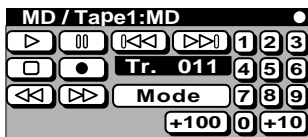

Remote control of LD player

- It is necessary to assign the LD player to one of the "Video" inputs previously.

1 Select the "Video1, 2, 3 or 4" icon.

- The "Video1/ 2/ 3/ 4" input is selected.

2 Select the icon to be controlled.

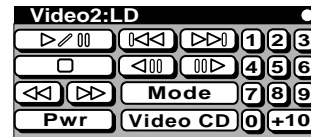

Pwr : Power

Remote control of cassette deck player

- It is necessary to assign the cassette deck player to the "MD/ Tape1" input previously.

1 Select the "MD/Tape1" icon.

- The "Tape1" input is selected.

2 Select the icon to be controlled.

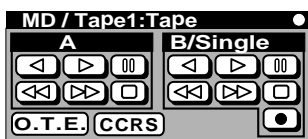

O.T.E. : One-Touch Edit

Note on KENWOOD cassette deck operation

CCRS operation from the remote control unit of your receiver is valid for some [SL 16] system control cassette deck models. For other models (including other system control type cassette decks), CCRS operation may not function correctly using the remote control unit of your receiver. In this case, use CCRS key on the cassette deck.



Remote control of satellite tuner

- It is necessary to assign the satellite tuner to one of the "Video" inputs previously.

1 Select the "Video1, 2, 3 or 4" icon.

- The "Video1/ 2/ 3/ 4" input is selected.

2 Select the icon to be controlled.

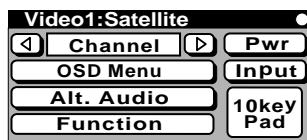

Pwr : Power
OSD : On-Screen
Display
Alt. : Alternative

Remote control of TV

- It is necessary to assign the TV to the "TV1" or "TV2" input previously.

1 Select the "TV1 or TV2" icon.

2 Select the icon to be controlled.

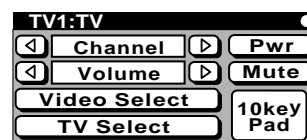

Pwr : Power

Remote control of cable TV

- It is necessary to assign the cable TV to the "TV1" or "TV2" input previously.

1 Select the "TV1 or TV2" icon.

2 Select the icon to be controlled.

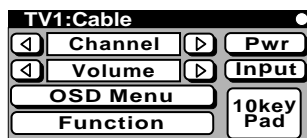

Pwr : Power
OSD : On-Screen
Display

Remote control of VCR

- It is necessary to assign the VCR to one of the "Video" inputs previously.

1 Select the "Video1, 2, 3 or 4" icon.

- The "Video1/ 2/ 3/ 4" input is selected.

2 Select the icon to be controlled.

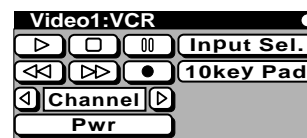

Pwr : Power

Remote control of Phono input

1 Select the "Phono" icon.

- The "PHONO" input is selected.
- The control icon is not displayed.

Remote control of AV AUX

1 Select the "AV AUX" icon.

- The "AV AUX" input is selected.
- The control icon is not displayed.

Receiving a broadcast station

For listening to RDS stations, see "Functions of RDS". → 37

Open the "Tuner" menu screen.

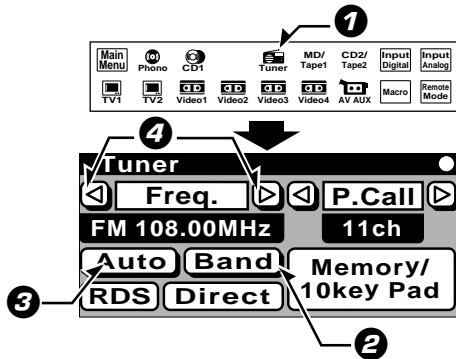

- ❶ Select the "Tuner" icon.
- ❷ Select the receiving band.
The band is alternated every time "Band" is selected.
FM ↔ AM
- ❸ Select the tuning method.
The tuning method is alternated every time "Auto" is selected.
Auto ↔ Auto
(Auto tuning) ↔ (Manual tuning)
- Usually set this switch to "Auto".
Select manual tuning when noise interferes due to weak radio wave. (The stereo broadcasting is received in monaural during manual tuning.)
- ❹ Select a station.
Select the "◀" or "▶" icon of "Freq.".
Auto tuning : The next station found is tuned automatically.
Manual tuning : Press repeatedly or hold until a station is tuned.

Receiving a station by specifying the frequency

❶ Open the "Tuner" menu and select band.

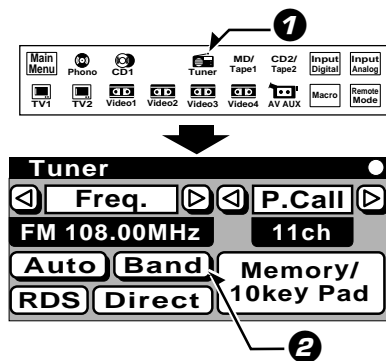

- ❶ Select the "Tuner" icon.
• The last tuned frequency is displayed.
- ❷ Select the receiving band.
The band is alternated every time "Band" is selected.
FM ↔ AM

❷ Specify the frequency.

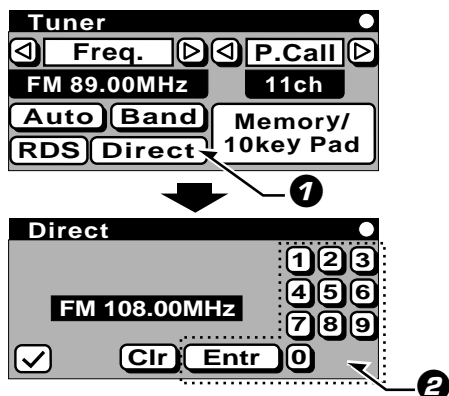

- ❶ Select the "Direct" icon.
- ❷ Input the frequency to be tuned using the numeric icons as follows.
Examples of input frequencies :
AM 810 kHz : 8 1 0 Entr
AM 1260 kHz : 1 2 6 0 Entr
FM 89.00 MHz : 8 9 0 0 Entr
FM 92.50 MHz : 9 2 5 0 Entr
- If you made a mistake, the frequency display will blink for a few seconds. In this case, try step ❷ again.

Functions of RDS

RDS is a system which transmits useful information (digital data) for FM broadcasts together with the broadcast signal. Tuners and receivers designed for RDS reception can extract the information from the broadcast signal for use with various functions such as automatic display of the station name.

Functions made possible with RDS

PTY (Program Type Identification) Search :

The tuner automatically searches for a station which is currently broadcasting a specified program type (genre).

PS (Program Service Name) Display :

When an RDS broadcast is received, the station name is automatically displayed.

RT (Radio Text) display :

Some of the RDS stations also transmit text data. When the RT display is selected with the "RDS Disp." icon, the broadcast text is scrolled on the display.

Auto Memory :

This function automatically selects the stations providing RDS and FM broadcasting and stores them in the preset memory (up to 40 stations can be preset).

* Some functions may not be provided or be given different names depending on countries or areas.



Before using a function utilizing the RDS, be sure to perform the Auto Memory operation by referring to the description in "Storing RDS stations automatically in preset memory".

→ 38

RDS Disp. icon

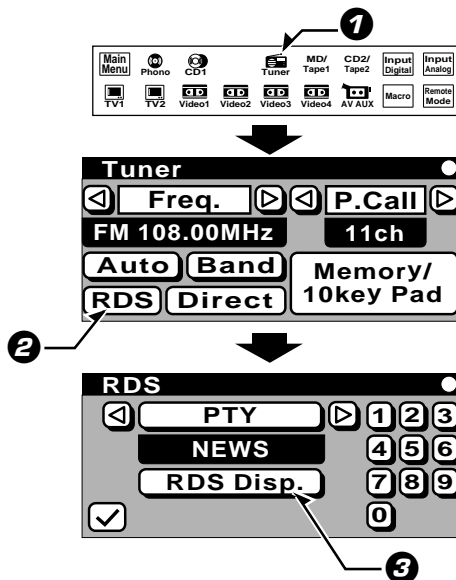

① Select the "Tuner" icon.

② Select the "RDS" icon.

③ Select the "RDS Disp. (Display)" icon.

The displayed information on the receiver is switched every time it is selected.

During FM reception :

PS (Program Service Name) Display :

When an RDS broadcast is received, the station name is automatically displayed. If no PS data was sent, "NO PS" is displayed.

RT (Radio Text) display :

Text accompanying RDS broadcast is scrolled on the display during reception. "NO RT" is displayed if the received RDS station is not accompanied with RT data.

Frequency display :

The frequency of the current station is displayed.

Listen mode display :

The current listen mode is displayed if the display mode setting is to show the listen mode.

→ 28

Storing RDS stations automatically in preset memory

(Auto Memory)

RDS stations should be stored in memory before listening to them. Use the following procedure to carry out automatic presetting. Up to 40 RDS stations can be preset.

1 Select the "Tuner" input and set the band to FM.

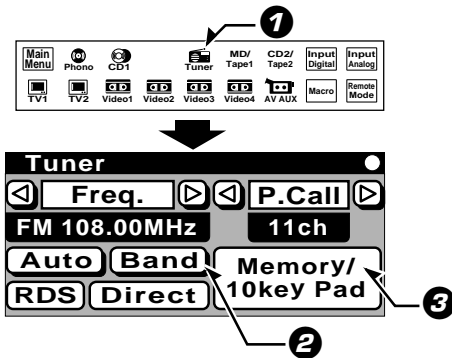

1 Select the "Tuner" icon.

- The last tuned frequency is displayed.

2 Set the receiving band to "FM".

The band is alternated every time "Band" is selected.

FM ↔ AM

Let the FM indicator on the receiver lights up.

3 Select the "Memory/10 key Pad" icon.

2 Preset stations by performing the Auto Memory operation.

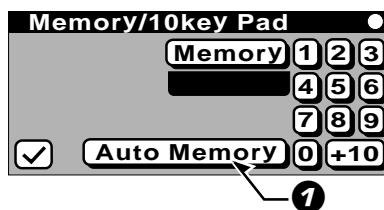

1 Select the "Auto Memory" icon.

In a few minutes, the stations with which RDS broadcast is received are stored in order beginning from preset channels "01" (up to 40 stations can be preset).

When the number of stations providing RDS broadcasting is less than 40, some of other FM stations will be preset in the vacant channels.



- During the "Auto Memory" operation, the corresponding indicator on the receiver blinks.
- If stations have already been stored in preset channels, the same number of these preset channels as the number of stations are cleared and replaced with the data of the newly preset stations.

Receiving a preset RDS station

1. Preset -Call

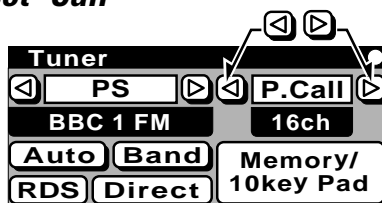

Select "◀" or "▶" icon of "P.Call" to select a preset number.

2. Specifying the preset number

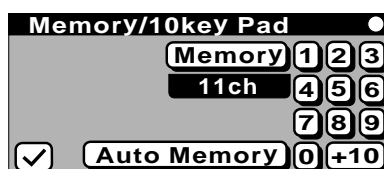

It can also be selected using numeric icons.

To specify the preset number (up to 40) of the desired station:

Select numeric icons as follows...

To receive in "15" **+10** **5**

To receive in "20" **+10** **+10** **0**

- If you made a mistake in entering the figure of 10, select the **+10** icon repeatedly until the original display is shown, then enter the correct number.

Manual memory of broadcast stations

Apart from the auto memory function, RDS stations can also be stored manually in the preset memory. Other stations than the RDS stations can also be stored in memory after the Auto Memory of RDS stations.

1 Select the "Tuner" input and select a station.

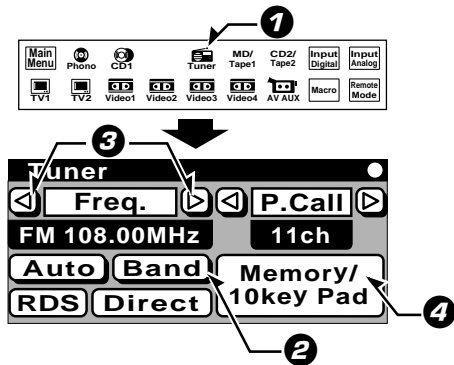

1 Select the "Tuner" icon.

- The last tuned frequency is displayed.

2 Select the receiving band. Select the "Band" icon.

3 Select a station or frequency. Select the "◀" or "▶" icon.

4 Select the "Memory/10key Pad" icon.

2 Preset the selected stations.

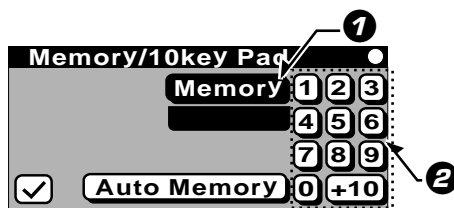

- If RDS stations are stored manually in the preset memory, the PS may not be included in the memory depending on receiving conditions.

1 Select "Memory" icon.

- The memory mode (**Memory**) and preset call mode (**Memory**) are switched alternately every time the icon is selected.

2 Select one of the preset numbers from 1 to 40.

Select numeric icons as follows...

To preset in "15" **+10** **5**

- Repeat steps 1 and 2 for each of the stations to be stored in memory.
- In the manual memory storage operation of radio stations, it may take a few seconds after the "Memory" icon is selected till the memory display starts to blink depending on the receiving condition.
- If a station is stored in a preset number which has already stored a station memory under it, the previous memory is replaced by the new memory content.

Receiving a manually preset station

1. Preset -Call

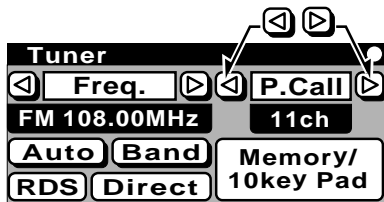

Select the "◀" or "▶" icon of "P.Call" to select a preset number.

When "P.Call▶" icons are selected

01→02→03.....38→39→40

When "◀P.Call" icons are selected

01←02←03.....38←39←40

- Every time the icon is selected, the next station in the order of the preset number is received.
If the icon is held selected ... Preset stations will be received successively for about half a second each.

2. Specifying the preset number

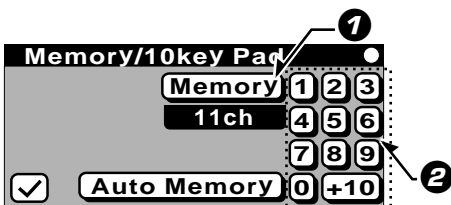

1 Select the "Memory" icon and switch to preset call mode (**Memory**).

2 Select the preset number (up to 40) of the desired preset station.

Select numeric icons as follows...

To receive in "20" **+10** **+10** **0**

- If you made a mistake in entering the figure of 10, select the **+10** icon repeatedly until the original display is shown, then enter the correct number.

Searching for a desired program type (PTY search)

By specifying the type of program (genre) you want to listen to, the tuner automatically searches for a station which is currently broadcasting a program of the specified type.

With certain receiving conditions, it may take more than 1 minute until the search completes.

1 Preset RDS stations with the Auto Memory function. → 38

- If you have already done the Auto Memory, go to step 2.

2 Select the "Tuner" input and select the "RDS" icon. → 37

- Set the receiving band to FM.

3 Perform operation in the "RDS" menu screen.

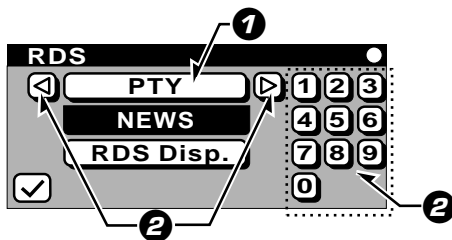

The Program Type information is displayed during reception of RDS broadcasting. (Display on the receiver)

If the PTY data is not broadcast or the tuned station is not an RDS station, "NONE" is displayed. (Display on the receiver)

- 1 Select the "PTY" icon.
- 2 Select the desired program type.

Select by referring to the Program type table on the left.

- A To select with the "◀" or "▶" icons.
- B To select with numeric icons.

- A To select a program type with the "◀" or "▶" icon.

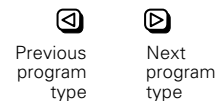

Select while "PTY" is lit.

Selecting the "◀" or "▶" icon selects the 29 program types in sequence. When the desired program type is displayed, release the icon.

- B To select a program type with numeric icons.

The numeric icons allow you to specify the desired program type from types numbered 1 to 0. To select other program type than them, use the "◀" or "▶" icon.

Program type table

(A)	(B)	Program Type Name	Display
	1	Pop Music	POP M
	2	Rock Music	ROCK M
	3	M.O.R. Music	M.O.R. M
	4	Light Classical Music	LIGHT M
	5	Serious Classical Music	CLASSICS
	6	Other Music	OTHER M
		Weather	WEATHER
		Finance	FINANCE
		Children's programmes	CHILDREN
		Social affaires	SOCIAL A
		Religion	RELIGION
		Phone in	PHONE IN
		Travel	TRAVEL
		Leisure	LEISURE
		Jazz Music	JAZZ
		Country Music	COUNTRY
		National Music	NATION M
		Oldies Music	OLDIES
		Folk Music	FOLK M
		Documentary	DUCUMENT
	7	News	NEWS
	8	Current Affairs	AFFAIRS
	9	Information	INFO
	0	Sports	SPORT
		Education	EDUCATE
		Drama	DRAMA
		Cultures	CULTURE
		Science	SCIENCE
		Varied Speech	VARIED

Correct PTY search information may not be displayed if this operation is attempted before performing the "Auto Memory" operation.

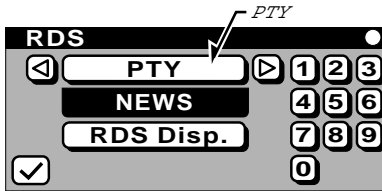
4 Start the search.**Select the "PTY" icon.****Select the icon again while it is displayed in reverse (blinking).**

- No sound is heard while "PTY" is blinking.
- During PTY search, the corresponding indicator on the receiver blinks.
- If a program of the desired type cannot be found, "NO PROGRAM" is displayed, then after several seconds the display returns to the original display. (Display on the receiver)
- When a station with the selected program type is searched, its reception starts and the type name display changes to the station name display. (Display on the receiver)

To change to a different program type

Repeat steps **1**, **2**, **3**, **4**.

To cancel

Select the "PTY" icon during PTY search.

This receiver incorporates 6 different listen modes to let you enjoy surround sound with a wide variety of program sources. The Dolby Digital (AC-3), Dolby Pro Logic and MPEG surround modes let you enjoy theater-like surround effects when you play Dolby Digital (AC-3), Dolby Surround and MPEG program sources (like videotapes, LaserDiscs and DVDs). The Dolby 3 Stereo mode creates a panoramic frontal sound field. The DSP (Digital Signal Processing) mode lets you create a variety of different sonic environments from PCM as well as analog sources. To obtain the best possible surround sound, be sure to complete "Setup for surround play" before using the surround modes.

Listen modes

Dolby Digital (AC-3)

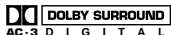
The Dolby Digital (AC-3) surround format lets you enjoy up to 5.1 channels of digital surround sound from Dolby Digital (AC-3) program sources (such as Laserdisc software marked  or ). Compared with previous Dolby surround, Dolby Digital (AC-3) provides even better sound quality, greater spatial accuracy, and improved dynamic range.

Note

Although a full set of speakers (front left and right, center, surround left and right, and a subwoofer) is required for true 5.1 channel Dolby Digital (AC-3) surround sound, this receiver lets you enjoy Dolby Digital (AC-3) (and Dolby Pro Logic) program sources, even if you connect only the front speakers.

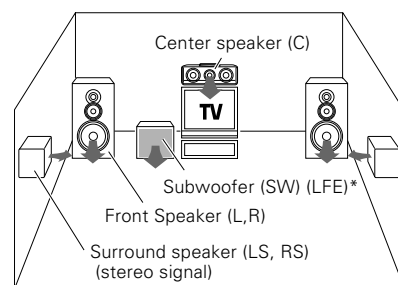

* Optional in this mode.

* LFE = Low Frequency Effects. This channel delivers separate non-directional bass signals to the subwoofer for more dynamic deep bass sound effects. Dolby Digital is the only Dolby method to have an LFE channel.

MPEG (multi-channel)

MPEG, which stands for "Moving Pictures Experts Group", is an international standard of digital video and audio compression and decompression in media. It is the most efficient encoding method for compressed multi-channel audio which provides the highest sound quality to deliver the best movie theater sound into the home.

Note

Although a full set of speakers (front left and right, center, surround left and right, and a subwoofer) is required for true MPEG 5.1 multi-channel surround sound, this receiver lets you enjoy the same surround sound, even if you connect only the front speakers.

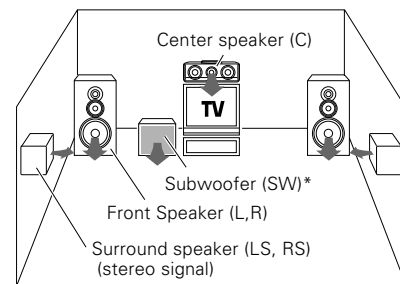

* Optional in this mode.

Dolby Pro Logic

Dolby Pro Logic is a specially encoded 2 channel surround format designed to provide theater-like surround sound from Dolby Surround encoded sources (such as video and Laserdisc software marked ). This receiver is equipped with a Dolby Pro Logic surround decoder to let you enjoy the wide variety of currently available Dolby Surround home video software.

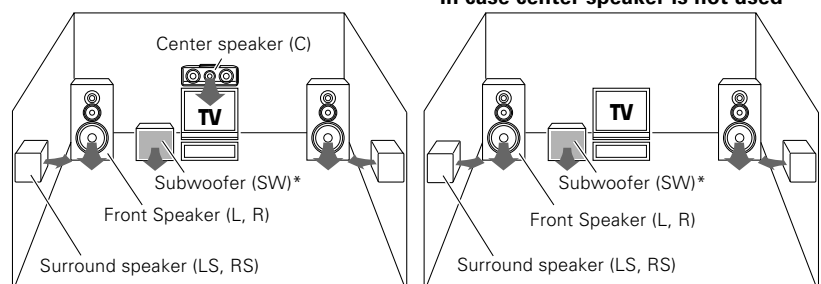

* Optional in this mode.

Dolby 3 Stereo

Dolby 3 Stereo is available for systems that do not have surround speakers. When in the Dolby 3 Stereo mode the surround information is redirected to the front left and right speakers. This mode is designed for use with Dolby Surround program sources, but can also improve sound field unity for programs that are not Dolby Surround encoded. Dialog positioning and sound image definition, however, may not be as accurate when used with programs that are not Dolby Surround encoded.

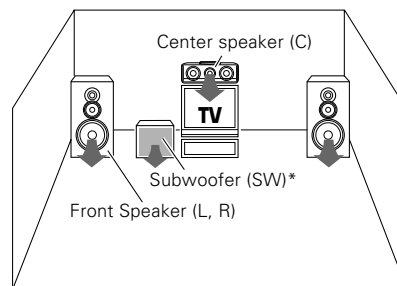

* Optional in this mode.

DSP mode

The DSP mode lets you add the atmosphere of an arena, jazz club or theater from a PCM or analog input source. * These modes are particularly effective when used with stereo program sources, like CD, television, and FM radio.

The WALL parameter lets you adjust the "brightness" of the sonic environment according to your preference.
The EFFECT level lets you adjust the "presence" of the sonic environment according to your preference.

* The DSP mode will produce a stereo-like surround effect from monaural sources, but there will be some reduction in the presence of the arena, jazz club, or theater (etc.).

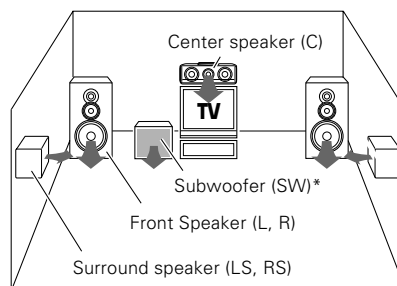

* Optional in this mode.

6-channel input mode (DTS ready)

Using a DVD player with 6 channel output or the like equipped with six (5.1) output channels mainly for DTS, you can enjoy multi-channel encoded DVD source material in all its splendor. Since the decoded analog signals are input independently, the resulting sound quality, sense of spaciousness, and dynamic range are superb.

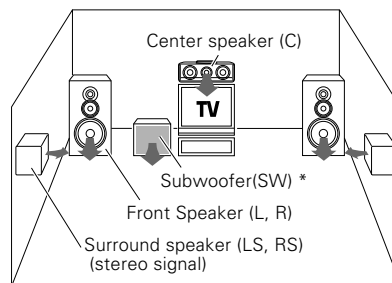

* Optional in this mode.

Manufactured under license from Dolby Laboratories. "Dolby", "Pro Logic" and the double-D symbol are trademarks of Dolby Laboratories. Confidential Unpublished Works. ©1992-1997 Dolby Laboratories. All rights reserved.

Re-equalization and the "Re-EQ" logo are trademarks of Lucasfilm Ltd. Manufactured under license of Lucasfilm Ltd. U.S. Patent Nos. 5,043,970; 5,189,703 and 5,222,059.

"DTS" and "DTS Digital Surround" are trademarks of Digital Theater Systems, Inc.



Recommended speaker installation



It is recommended that the surround speakers are installed straight to the left and right of the listening position or slightly behind, at a height of about 1 meter higher than the listener's ears. See your retailer, or installation varies by room shape, size and personal preference.

What is DSP?



DSP stands for Digital Signal Processor. The way a sound is heard in an actual environment depends on a variety of different factors. One of the most important factors is reverberation (the act of decaying elements of sound echoing in various places). The DSP modes produce the feeling of presence by using the DSP to create reverberation, without spoiling the sound quality of the original signal.



Available listen modes

The following table shows the relationship between the source signal, source component and receiver input, and the listen mode that can be selected from the "Lstn(Listen) Mode" menu.

Source Signal	Source Component	Receiver Input	Listen Modes That Can be Selected from "Lstn Mode" menu
MPEG multi-channel	DVD	Digital	MPEG / Stereo *1
Dolby Digital (AC-3)	DVD	Digital	Dolby Digital / Stereo *1
Dolby Digital (AC-3) RF	LD (DEMODULATOR)	Digital	Dolby Digital / Stereo *1
PCM / Analog	CD / LD / DVD etc.	Digital / Analog	Pro Logic / 3 Stereo / Stereo / DSP mode

*1 When the Dolby Digital (AC-3) and MPEG signal has 2 or 2.1 channels, it can be played using Pro Logic or 3 Stereo mode.

Caution for surround play

When playing a source component connected to the VIDEO 4 6CH. INPUT

- When you try to play a disc other than Dolby Digital (AC-3) or MPEG multi-channel such as DTS CD, no sound is produced or, noise may be heard. To avoid this situation, make sure that you connect the component to the receiver's VIDEO 4 6CH. INPUT jacks through a surround processor which can decode the surround signal you want to listen to. Connecting a DVD player which can decode the surround signal itself is also acceptable.



Caution when the "Lstn Mode" is set to "(digital) Manual"

(See also -29 for selecting digital auto or digital manual.)

When the "Input Digital" icon is set to "Manual", you need to pay attention of what kind of audio signal comes in and which listen mode you need to select.

Playback in MPEG mode

Input Signal	Remote control display		Panel MPEG Indicator	What happens	Solution
	Selected Lstn Mode	Status			
MPEG	MPEG	MPEG	Lights	Sound comes out	
Dolby Digital	MPEG	Dolby Digital	Blinks	No sound	See the table in "Available listen modes".
PCM	MPEG	PCM	Blinks	No sound	See the table in "Available listen modes".

Playback in Dolby Digital mode

Input Signal	Remote control display		Panel Dolby Digital Indicator	What happens	Solution
	Selected Lstn Mode	Status			
MPEG	Dolby Digital	MPEG	Blinks	No sound	See the table in "Available listen modes".
Dolby Digital	Dolby Digital	Dolby Digital	Lights	Sound comes out	
PCM	Dolby Digital	PCM	Blinks	No sound	See the table in "Available listen modes".

Playback in PCM mode

Input Signal	Remote control display		Panel Dolby Digital/MPEG indicator	What happens	Solution
	Selected Lstn Mode	Status			
MPEG	*2	MPEG	Off	No sound	See the table in "Available listen modes".
Dolby Digital	*2	Dolby Digital	Off	No sound	See the table in "Available listen modes".
PCM	*2	PCM	Off	Sound comes out	

*2 The listen mode in the table in "Available listen modes".

- The selection of the "Surround" icon may be restricted depending on the input signal.
- "(digital) Manual" is switch to "(digital) Auto" when: the system is switched to On or Off, speaker system is switched to On or Off, and the analog input is selected after "Digital Manual" playback.
- Use the "(digital) Manual" mode when playing a 2/0 (2 channel or 2.1 channel) Dolby Digital(AC-3) or MPEG input in the Pro Logic or 3 Stereo listen mode. If "(digital) Auto" is selected in this situation, some operations of source components may cancel the Pro Logic or 3 Stereo listen mode.

Surround play

1 Select the "Input Digital" icon so that "Auto" is displayed.

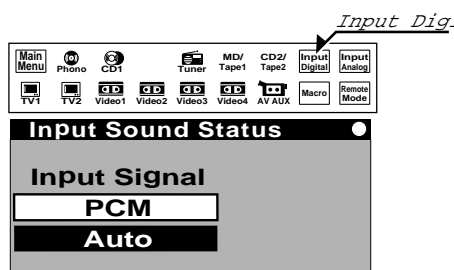

"Auto" should be displayed in normal use. If you want to set the "Lstn Mode" to "Manual", verify the surround play is still possible by referring to the table on the previous page. By setting the "Lstn Mode" to "Manual", you can always use a fixed listen mode or select the desired listen mode every time. (With "Manual", the listen mode can be selected whenever there is an input signal.)

Select the "Input Digital" icon so that "Auto" is displayed.

- When "Input Digital" is selected, the "Input Sound Status" menu screen appears.

The display is alternated every time the "Input Digital" icon is selected.

Auto ↔ Manual

- When "Auto" is displayed by selecting the "Input Digital" icon, the playback is switched automatically when the output signal from the source changes from a MPEG or Dolby Digital signal to a PCM signal.
- If the digital input is not connected to the receiver, select "Input Analog".

2 Open the "Lstn Mode" menu screen.

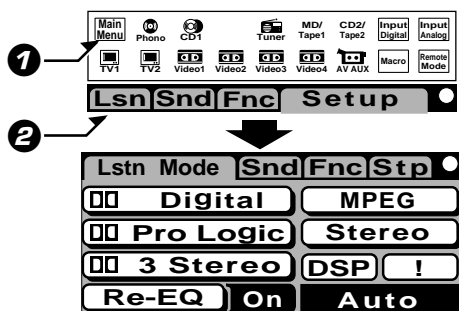

- 1 Select "Main Menu" icon.

- 2 Select "Lsn" icon.

3 Display the component control screen.

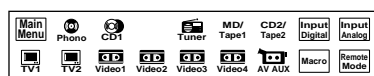

Select the icon of the component to be played.

(Example)

To play a DVD disc, make sure that the DVD player is assigned to "Video4" and select the "Video4" icon.

- Select the icon of the component which has been assigned in "Assigning the connected components to the selected inputs".

4 Play the software.

Select the play key of the component to be played.

- When playback is started, the sound may be cut or interrupted before the input source is confirmed as Dolby Digital or MPEG.



5 Adjust the volume.



- If you want to change each speaker's volume temporarily :



6 ch input play

- 1** Turn off the system.
- 2** Connect your DVD player to a multi-channel decoder (surround processor) and connect the decoder to the receiver's VIDEO 4 6CH. INPUT jacks. → 
- 3** Set the VIDEO 4 INPUT switch (placed on the rear panel) to 6CH position. → 
- 4** Turn back on the system.
- 5** Select "Video 4" as the input source.

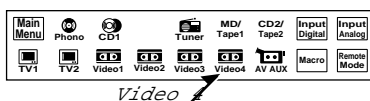

- Make sure the DVD player connected to the VIDEO 4 6CH. INPUT jacks is registered as VIDEO 4 input.

- 6** Select "Input Analog" icon.

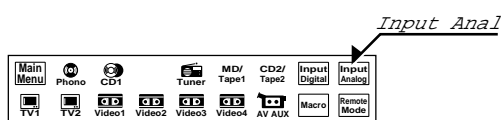

- 7** Start playback.

- 8** Adjust the volume.



- When switched to the 6ch input mode, the speakers system A will be on automatically, and the speakers system B cannot be selected.
- It is not possible individually to adjust the volume level or sound quality of the separate channels when the receiver is in the 6ch input mode. Adjust the volume with the controls of the DVD player or the surround processor. For the powered subwoofer, you can adjust the volume of the subwoofer using the subwoofer's own volume control.
- When in the 6ch input mode, you can still use the **VOLUME** control and **MUTE** key.

Checking the surround play status

The surround mode and input signal used in the current playback session can be displayed.

1 Open the "Lstn (Listen) Mode" menu screen.

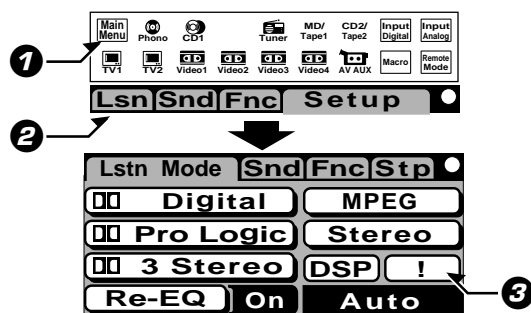

① Select the "Main Menu" icon.

② Select the "Lsn" icon.

• The surround mode in use can be shown in the "Lstn Mode" menu screen.

③ Select the "!" icon.

2 Display in the "Input Sound Status" menu screen.

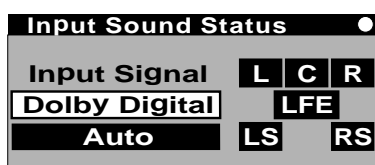

• The "Input Sound Status" menu screen shows the signal being played.

• During playback in Dolby Digital (AC-3) or MPEG mode, the input signals from the source component are shown using icons such as "L", "C" and "R".

Cinema Re-EQ

Because a film's soundtrack is meant to be heard in a large theater with dozens of speakers, movies can sound much different when played in a typical room at home. This Cinema Re-EQ brings a film's soundtrack closer to that you hear in a theater by creating a more spacious, enveloping surround-sound environment. Apply this effect when you are enjoying a movie. (Make sure your system has surround speakers.)

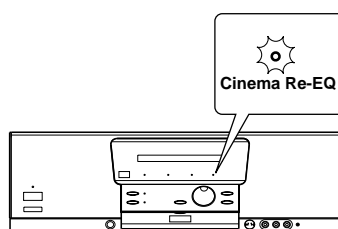
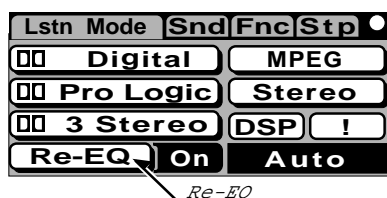

Re-EQ On : The receiver is in Re-EQ standby mode

Re-EQ On : The Re-EQ mode is activating

- When Re-EQ is set to On, the mode will be activated automatically when in an effective surround mode.

Applying surround effect in DSP mode

If the played signal is a PCM or analog, it can be played with acoustic field by using the DSP mode.

1 Play the music.

2 Open the "Lstn (Listen) Mode" menu screen.

1 Select the "Main Menu" icon.

2 Select the "Lsn" icon.

When the digital input is connected to the receiver

3 Select the "Input Digital" icon so that "Auto" is displayed.
The display is alternated every time the "Input Digital" icon is selected.
Auto ↔ Manual

4 Select the "DSP" icon.

When the analog input is connected to the receiver

3 Select the "Input Analog" icon.

- The "Input Analog" icon can be selected when the analog input is connected to the input jacks of the receiver.

4 Select the "DSP" icon.

For the condition in which playback with the acoustic field effect in the DSP mode is possible, see the description in "Available listen modes".
- 44

3 Select the mode from the "DSP Mode" menu screen.

Use the joystick to move the selection cursor to the desired DSP mode and press the ENTER key.

- Arena** : the audio atmosphere in the front row of a large concert arena.
- Jazz Club** : a smaller, more intimate setting, with the listener setting close to the music.
- Theater** : the crisp acoustics of theater setting.

- To adjust the audio in the "DSP Mode", select the "Prmtr" (Parameter) icon.

4 Adjust the DSP mode.

1 Select the "Prmtr" icon in the "DSP Mode" menu screen.

2 Select the item to be adjusted.

- Wall Type** : Switches the quality of the walls.
- Effect Level** : Switches the effect level.

1 Preparation for recording

- ❶ Select the icon of recording source component. (Switch the receiver's input to that component.)
- ❷ Set the component, which you want to record to such as MD recorder, cassette deck, or VCR, to record-pause mode.
 - ❶ Select the "Remote Mode" icon from the segment screen.
 - Selectable icons start to blink.
 - ❷ Select the desired component icon while it is blinking.
 - The operation menu screen of the selected component opens.
 - ❸ Set the component for recording and put it to record-pause mode.
- When the "Remote Mode" icon is selected, selectable icons blink for a few seconds.
By selecting a blinking icon, the selected component can be controlled without switching the input selector. (The "Remote Mode" icon can be used to put the recording component to pause mode without switching the input selector.)
When an icon that is not blinking is selected, the input selector is switched automatically.
- For the recording procedure, refer also to its instruction manual.

2 Select the REC MODE.

When the source you want to make a copy is recorded digital multi-channel, these multi-channel signals(digital) need to be converted to stereo signals(analog). You can choose to do this procedure automatically(AUTO REC MODE) or manually(MANUAL REC MODE). Choose AUTO REC MODE usually. Choose MANUAL REC MODE when you want to fix the digital signal type (Dolby Digital, MPEG or PCM). If the sound is cut or interrupted during AUTO REC MODE, try MANUAL REC MODE to reduce the symptom.

AUTO REC MODE

Press the DISPLAY MODE key for more than 2 seconds and choose AUTO REC MODE.

The recording mode is switched as repeating pressing the key in the same way.

- REC MODE OFF
- AUTO REC MODE
- MANUAL REC MODE

MANUAL REC MODE

- ❶ Play the software of the source component.
- ❷ Press the DISPLAY MODE key for more than 2 seconds and choose MANUAL REC MODE.
The recording mode is switched as repeating step ❷.
 - REC MODE OFF
 - AUTO REC MODE
 - MANUAL REC MODE
- When in MANUAL REC MODE, if no sound is heard, press the DISPLAY MODE key once.
- ❸ Stop playback of the source component.

3 Play the software from the beginning and record it.



- Do not switch to "CD2/Tape2 (Monitor)" during recording. This may cause the interruption of the recording.
- Pressing the DISPLAY MODE key may cut the recording sound.
- When making a digital recording, operations other than volume adjustment may cause the sound to clip during recording.
- The AV AUX jacks on the front panel provide a convenient way to connect a video camera (playback only).
- Some video softwares may not be able to make a copy because of copy guard protection.

Copying tape (TAPE1 → TAPE2)

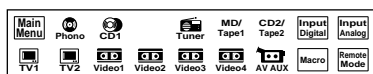

- ① Select the "MD/Tape1" input.
- ② Start playback of the cassette deck connected to the MD/TAPE1 input jacks, then start recording of that connected to the CD2/TAPE2 MONITOR input jacks.

Note on CD2/ Tape2 (Monitor)

The functions described below are available only when the analog input/output are used. If the "CD2/Tape2" icon in the segment screen is selected during playback of a digital input, the input is switched to the analog input and noise may be generated.

Using "CD2/Tape2"

The **CD2/TAPE2 MONITOR** input jacks of the receiver accept a cassette deck or graphic equalizer.

When a 3-head cassette deck is connected to the **CD2/TAPE2 MONITOR** input jacks, the recorded audio can be monitored during recording, and turning "CD2/Tape2" on and off allows you to compare the source audio and recorded audio. Refer to the instruction manuals of the connected components for their operating procedures.

The "CD2/Tape2 (Monitor)" function is not available during playback of a digital input and also playback in 6ch input mode. Selecting "CD2/Tape2 (Monitor)" during digital input playback switches the input to the analog input.

Icon in the segment screen of the remote



Display on the receiver

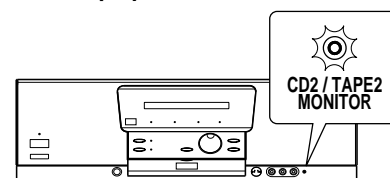

Midnight mode 1/2/Off

(Dolby Digital (AC-3) mode only)

When watching movies at night you might not be able to raise the volume as loud as normal. Midnight mode compresses the dynamic range of previously specified parts of the AC-3 sound track (like scenes with sudden increases in volume) to minimize the difference in volume between the specified and non-specified parts. This makes it easy to hear all of the sound track, even when listening at low volumes.

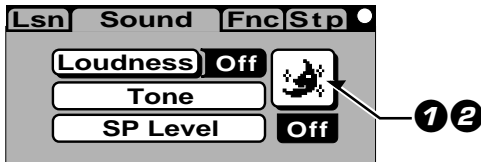

- 1 Select the midnight mark icon.
- 2 Adjust the parameter using the midnight mark icon.
→ 1 → 2 → Off →

- Some Dolby Digital (AC-3) software may not be compatible with the Midnight mode.
- Midnight mode has no effect on parts of the sound track that are not specified for compression.

FL Dimmer, FL Display

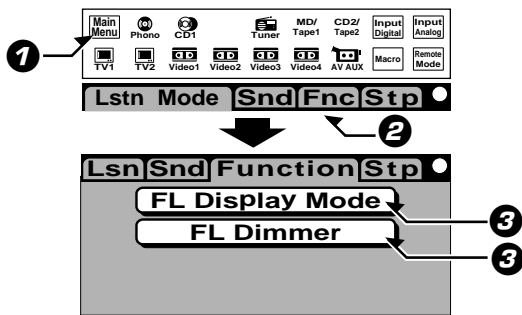

- 1 Select the "Main Menu" icon.
- 2 Select the "Fnc" icon to display the "Function" menu shown.

FL dimmer setting :

- 3 Select the "FL Dimmer" icon.
- The display tube brightness changes every time the icon is selected.

FL display mode setting :

- 3 Select the "FL Display Mode" icon.
- The display mode changes every time the icon is selected.

→ Connected component analog/digital display (Example)
 DVD DGTL
 (VIDEO4 DGTL)*1
 (DVD 6ch)*2

→ Input and connected component name display (Example)
 VIDEO4 : DVD
 (VIDEO4 :)*1
 (VIDEO4 : DVD)*2

→ Listen mode display→ (Example)
 DOLBY DIGITAL
 (6ch INPUT)*2

*1 : when the connected component name is not assigned

*2 : when the DVD player is assigned to VIDEO 4, and the selector (VIDEO 4) is set to analog 6ch input mode.

Back light

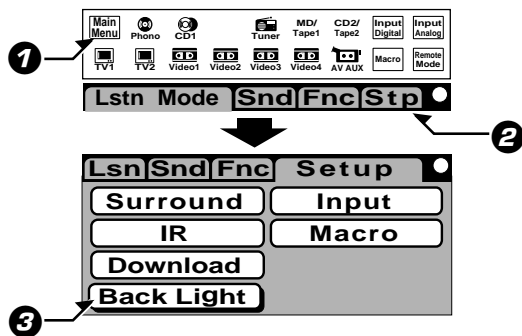

This function turns the remote control display illumination on and off.

- 1 Select the "Main Menu" icon.
- 2 Select the "Stp" icon.
- 3 Select the "Back Light" icon.

- The illumination is turned on and off alternately every time the icon is selected.
- To save the battery power, it is recommended to keep the Back Light off in normal use.

What appears to be a malfunction may not always be serious. If your unit should not perform as expected, consult the table below to see if the problem can be corrected before seeking help from your dealer or service representative.

How to reset the microcomputer

The microcomputer may malfunction (impossibility of operation, erroneous display, etc.) when the power cord is unplugged and plugged in again while the unit is in ON mode or due to other external causes. In this case, execute the procedure on the right to reset the microcomputer and return the unit to the normal condition.

- Resetting the microcomputer clears the memory you entered and returns it to the initial condition when the unit left the factory.

- ① With the power cord plugged in, turn the **POWER** key to **OFF**.
- ② While holding down the **1/⏻ (ON/STANDBY)** key, press the **POWER** key.

Amplifier

Symptom	Cause	Remedy
Sound is not output or the volume level is low.	<ul style="list-style-type: none"> ● Connection cords are unplugged from the jacks. ● MUTE is ON. (The MUTE indicator is blinking) ● The CD 2 / Tape 2 (Monitor) is set to ON. ● The selected listen mode does not match the input signal. 	<ul style="list-style-type: none"> ● Connect them properly referring to "System connections". → 6 ● Press the MUTE key to OFF. ● Set the CD 2 / Tape 2 (Monitor) to OFF. → 50 ● Select the listen mode according to the input signal or select "Auto" with "Input Digital" icon. → 44 → 45
Standby indicator blinks and sound is not output.	<ul style="list-style-type: none"> ● Speaker cords are short-circuited. 	<ul style="list-style-type: none"> ● Unplug the AC cord, remove the short-circuiting and plug the AC cord again. → 12
Sound is not output from one of the speakers.	<ul style="list-style-type: none"> ● The speaker cord is disconnected. 	<ul style="list-style-type: none"> ● Connect it properly referring to "Speaker connections/ PRE OUT connections". → 12
Sound is not output from the surround speaker and/or center speaker, or their sound is very small.	<ul style="list-style-type: none"> ● The surround speaker cords and/or center speaker cord are disconnected. ● The surround play mode has not been engaged. ● The surround and center speaker levels are set to the minimum positions. 	<ul style="list-style-type: none"> ● Connect them by referring to "Speaker connections/ PRE OUT connections". → 12 ● Set the surround mode. → 44 ● Adjust the surround and center speaker levels. → 23
A humming noise is generated when the PHONO input selector is selected.	<ul style="list-style-type: none"> ● The audio cord from the turntable is not connected to the PHONO jacks. ● The turntable is not grounded. 	<ul style="list-style-type: none"> ● Insert the audio cord plugs securely into the PHONO jacks. → 6 ● Connect the grounding wire to the grounding wire terminal on the rear panel. → 6
The sound is cut when starting playback of a Dolby Digital(AC-3) or MPEG source in a DVD player.	<ul style="list-style-type: none"> ● There are different causes for different types of DVD players. 	<ul style="list-style-type: none"> ● With certain DVD players, the initial sound may be cut or interrupted.
No sound when playing a DVD.	<ul style="list-style-type: none"> ● "Auto" is not set. 	<ul style="list-style-type: none"> ● Set "Input Digital" to "Auto". → 29
Digital playback is not possible from Dolby Digital (AC-3) or MPEG sources.	<ul style="list-style-type: none"> ● "Auto" is not set. 	<ul style="list-style-type: none"> ● Set "Input Digital" to "Auto". → 29
System control is impossible.	<ul style="list-style-type: none"> ● System control cords are connected incorrectly. ● Setup cord for system control is not registered. 	<ul style="list-style-type: none"> ● Connect them correctly by referring to "Connecting the system control". → 10 ● Register the setup cord for system control operation. → 19
Listen mode cannot be switched to other.	<ul style="list-style-type: none"> ● The listen mode is set to 6ch input mode. 	<ul style="list-style-type: none"> ● Select "Input Digital" icon or set the VIDEO 4 INPUT switch to 2CH.
Speaker level adjustment and tone adjustment cannot be carried out.	<ul style="list-style-type: none"> ● The listen mode is set to 6ch input mode. 	<ul style="list-style-type: none"> ● Select "Input Digital" icon or set the VIDEO 4 INPUT switch to 2CH.
SPEAKERS keys are invalid.	<ul style="list-style-type: none"> ● The listen mode is set to 6ch input mode. 	<ul style="list-style-type: none"> ● Select "Input Digital" icon or set the VIDEO 4 INPUT switch to 2CH.
Video softwares cannot be recorded.	<ul style="list-style-type: none"> ● Some video softwares have copy guard protection. 	<ul style="list-style-type: none"> ● Recording is impossible.

Tuner

Symptom	Cause	Remedy
Radio stations cannot be received.	<ul style="list-style-type: none"> No antenna is connected. The broadcast band is not set properly. The frequency of the desired station is not tuned. 	<ul style="list-style-type: none"> Connect an antenna. → 13 Set the broadcast band properly. → 36 Tune the frequency of the desired station.
Interference.	<ul style="list-style-type: none"> Noise due to ignition noise of an automobile. Noise due to an influence from an electric appliance. Noise due to a nearby TV set. 	<ul style="list-style-type: none"> Install the outdoor antenna away from the road. Turn off the power to the appliance. Install the system farther away from the TV set.
A station which was preset cannot be received by pressing the corresponding numeric key.	<ul style="list-style-type: none"> The preset memory was cleared because the power cord had been unplugged for a long period of time. The "Tuner" input is not selected. 	<ul style="list-style-type: none"> Preset the stations by Auto Memory again. → 38 Select the "Tuner" input.
RDS PTY search cannot be carried out.	<ul style="list-style-type: none"> Stations are not preset using Auto Memory. 	<ul style="list-style-type: none"> Preset the stations by Auto Memory again. → 38

Remote control unit

Symptom	Cause	Remedy
Remote control operation is not possible.	<ul style="list-style-type: none"> Batteries are exhausted. The remote control unit is too far away from the main system, controlling angle is too large, or there is an obstacle in between. The audio cords and system control cords are not connected properly. The source component to be operated does not contain the tape(s) or disc. 	<ul style="list-style-type: none"> Replace with new batteries. → 16 Operate the remote control unit within the controllable range. → 15 Connect properly referring to "System connection". → 6 Place the tape(s) or disc in the source component to be played.
The remote control screen is not displayed.	<ul style="list-style-type: none"> Batteries are exhausted. 	<ul style="list-style-type: none"> Replace with new batteries. → 16
The remote control display is abnormal.	<ul style="list-style-type: none"> Batteries are removed while something is displayed. 	<ul style="list-style-type: none"> Remove and replace batteries after the information display has disappeared. → 16



Do not use contact cleaning agents because they could cause a malfunction. Be specifically careful against using contact cleaning agents containing oil, since they may deform the plastic components.

Memory backup function

Please note that the following items will be deleted from this unit's memory if the power cord is disconnected from the AC outlet or the POWER switch is turned off for approximately three days.

- The input selection is cleared and the "Tuner" input is selected.
- The volume setting is cleared and the volume is set to "-66 dB".
- The receiving band setting is cleared and the "FM" band is selected.
- The frequency setting is cleared and 87.5 MHz is selected.
- The preset station memory is cleared.
- The surround setting is cleared and reset to the initial condition.

Setup Codes chart

Although each setup code is designed to work with a number of different models, certain codes may not work with some models. (Also, certain codes may only operate some of the functions available on a given model.)
With some models, be sure to keep the ENTER key pressed for a while.

Inquiries on the setup codes loaded using the Free-Phone Consumer Help Line:

If there is any inquiry related to these setup codes, please contact the following services.

UK (including N. Ireland) : 0800-898520

Specifications

KRF-V7771D (En/T)

55

⚠ **Caution** : Read this page carefully to ensure safe operation.

AUDIO section

Rated power output during STEREO operation	
(DIN) 1 kHz, 0.7% at 4 Ω	120 W + 120 W
(IEC) 63 Hz ~ 12.5 kHz, 0.7% at 4 Ω	120 W + 120 W
Effective power output during SURROUND operation	
FRONT	
(1kHz, 0.7% T.H.D. at 4 Ω one channel driven)	100 W + 100 W
CENTER	
(1kHz, 0.7% T.H.D. at 4 Ω one channel driven)	100 W
SURROUND	
(1kHz, 0.7% T.H.D. at 4 Ω one channel driven)	100 W + 100 W
Total harmonic distortion	0.004 % (1kHz, 60 W, 4 Ω)
Frequency response(IHF '66)	
CD	5 Hz ~ 80 kHz, +0.5 dB, -3 dB
Signal to noise ratio (IHF '66)	
PHONO (MM)	77 dB
CD	93 dB
Input sensitivity / impedance	
PHONO (MM)	2.5 mV / 47 kΩ
CD	200 mV / 47 kΩ
6CH INPUT	200 mV / 47 kΩ
Output level / impedance	
TAPE REC	200 mV / 220 Ω
PRE OUT (FRONT, CENTER, SURROUND, SUBWOOFER)	1 V / 500 Ω
Tone control	
BASS	±7 dB (at 100 Hz)
TREBLE	±7 dB (at 10 kHz)
LOUDNESS control	
VOLUME at -40dB level ...	+7 dB(100 Hz), +4 dB(10 kHz)

DIGITAL AUDIO section

Sampling frequency	32 kHz, 44.1 kHz, 48 kHz
Input level / impedance / wave length	
Optical	-15 dBm ~ -21 dBm, 600 nm ±30nm
Coaxial	0.5 Vp-p / 75 Ω

VIDEO section

VIDEO inputs / outputs	
VIDEO (composite)	1 Vp-p / 75 Ω
S-VIDEO (luminance signal)	1 Vp-p / 75 Ω
(chrominance signal)	0.286 Vp-p / 75 Ω

FM tuner section

Tuning frequency range	87.5 MHz ~ 108 MHz
Usable sensitivity (DIN, 75 Ω)	
MONO	1.2μV / 13.2 dBf (40 kHz DEV., S/N 26 dB)
STEREO	45μV / 44.2 dBf (46 kHz DEV., S/N 46 dB)
Total harmonic distortion (DIN, 1 kHz)	
MONO	0.2 % (65.2 dBf input)
STEREO	0.8 % (65.2 dBf input)
Signal to noise ratio (DIN weighted, 1 kHz)	
MONO	65 dB (40 kHz DEV., 65.2 dBf input)
STEREO	60 dB (46 kHz DEV., 65.2 dBf input)
Stereo separation (DIN, 1 kHz)	36 dB
Selectivity (DIN, ±300 kHz)	64 dB
Frequency response (30 Hz ~ 15kHz)	+0.5 dB, -3.0 dB

AM tuner section

Tuning frequency range	531 kHz ~ 1,602 kHz
Usable sensitivity (30% mod., S/N 20 dB)	
	16 μV / (600 μV/m)
Signal to noise ratio (30 % mod., 1 mV input)	50 dB

GENERAL

Power consumption	330 W
⚠ AC outlet	
SWITCHED	2 (total 90 W max.)
Dimensions	
W	440 mm (17-5/16")
H	162 mm (6-3/8")
D	391 mm (15-3/8")
Weight (Net)	11.4 kg (25.1lb)



1. KENWOOD follows a policy of continuous advancements in development. For this reason specifications may be changed without notice.
2. Full performance may not be exhibited in extremely cold locations (below 0 deg.C).

Other

KENWOOD

For your records

Record the serial number, found on the back of the unit, in the spaces designated on the warranty card, and in the space provided below. Refer to the model and serial numbers whenever you call upon your dealer for information or service on this product.

Model _____ Serial Number _____

Setup Codes chart
Tableau des codes de configuration
Tabelle der Einstellungscode
Setup Codes kaart
Tabella dei codici di impostazione
Gráfico de códigos de preparación

1

Noting your compontnets
Relevé des composants
Auflisten der Komponenten
Noteren van uw componenten
Annotazione dei propri componenti
Observación de sus componentes

Input Jack	Component	Manufacturer	Model #	Setup Code
Prise d'entrée	Appareil	Fabricants	Modèle #	Code de configuration
Eingangsbuchse	Komponente	Hersteller	Modell-Nr.	Einstellcode
Ingangaansluiting	Component	Merk	Model #	Instelkode
Presa di ingresso	Componente	Marca	Numero modello	Codie di impostazione
Toma de entrada	Componente	Fabricante	N.º de modelo	Código de preparación
CD 1				
MD/TAPE 1				
CD 2/TAPE 2 MONITOR				
VIDEO 1				
VIDEO 2				
VIDEO 3				
VIDEO 4				
PHONO				
TV 1				

TV
Téléviseurs
Fernseher
2 TV
Televisore
Televisor

1 * * *

ASA	1102
Acura	1024
Admiral	1102, 1178
Adyson	1232
Akai	1223, 1376
Akura	1233, 1279
Alba	1024, 1052, 1233, 1386
Allorgan	1309
Amplivison	1232
Amstrad	1024, 1386
Anitech	1024
Arcam	1231, 1232
Asuka	1233
Atlantic	1221
Audiosonic	1052, 1124
Autovox	1102, 1221
BPL	1297
BSR	1309
BTC	1233
Baird	1358
Bang & Olufsen	1102
Basic Line	1024, 1233
Baur	1025, 1052, 1364, 1376, 1527
Beko	1385
Beon	1052
Binatone	1232
Blaupunkt	1206, 1210, 1215, 1342, 1343
Blue Sky	1233
Blue Star	1297
Bondstec	1262
Boots	1232
Brandt	1124, 1350
Brionvega	1102
Britannia	1231
Bruns	1102
Bush	1024, 1052, 1233, 1297, 1309, 1364, 1386, 1389, 1534
CGE	1262
CS Electronics	1231
CTC	1262
Cascade	1024
Cathay	1052
Centurion	1052
Century	1102

Cimline	1024
Clarivox	1052
Clatronic	1262, 1385
Condor	1335, 1385
Contec	1024, 1231
Continental Edison	1414
Crosley	1102
Crown	1024, 1052, 1385, 1433
Cybertron	1233
Daewoo	1024, 1052, 1389
Dainichi	1233
Dansai	1052
Dayton	1024
De Graaf	1223, 1563
Decca	1052, 1087
Dixi	1024, 1052
Dual	1534
Dual Tec	1232
Dumont	1102
Elin	1052, 1563
Elite	1233, 1335
Elta	1024
Emerson	1102, 1376
Erres	1052
Expert	1221
Ferguson	1052, 1124, 1253, 1302, 1350, 1358
Fidelity	1231, 1376
Finlandia	1223, 1374
Finlux	1052, 1087, 1102
Firstline	1024, 1231, 1232, 1262, 1309, 1336
Fisher	1223, 1232, 1385
Flint	1470
Formenti	1052, 1102, 1335
Frontech	1178, 1262, 1279
Fujitsu	1087, 1221
Funai	1279, 1309
GEC	1052, 1087, 1232
GPM	1233
Geloso	1024
Genexxa	1178, 1233
GoldStar	1052, 1124, 1232
Goodmans	1052, 1087, 1232, 1332 1358, 1386, 1389
Gorenje	1385

Graets	1178, 1376
Granada	1052, 1087, 1223 1232, 1374
Grandin	1297
Grundig	1206, 1210
HCM	1024, 1297
Hanseatic	1052, 1335, 1376
Hinari	1024, 1052, 1233
Hisawa	1297, 1470
Hitachi	1124, 1178, 1232, 1240, 1364, 1563
Huanyu	1231, 1389
Hypson	1052, 1279, 1297
ICE	1232, 1279, 1386
ICeS	1233
ITS	1386
ITT	1178, 1376, 1563
Imperial	1262, 1385, 1433
Indiana	1052
Ingelen	1178
Inno Hit	1087
Interfunk	1052, 1178, 1262 1376, 1527
Intervision	1052, 1117, 1232, 1279
Isukai	1233
JVC	1068, 1109, 1386
Kaisui	1024, 1231, 1232 1233, 1297
Kapsch	1178, 1221
Kathrein	1571
Kendo	1052
Kenwood	1328
Kingsley	1231
Kneissel	1450
Korpel	1052
Korting	1102
Koyoda	1024
Leyco	1052, 1087, 1279, 1309
Liesenk & Tter	1052
Loewe	1090, 1102, 1304, 1527
Luma	1221
Luxor	1364, 1376
M Electronic	1024, 1052, 1124, 1178, 1232, 1302, 1389
MTC	1364, 1527
Magnadyne	1102, 1117, 1262
Magnafon	1117

TV
Téléviseurs
Fernseher
TV
Televisore
Televisor

Manesth	1232, 1279, 1335
Marantz	1052, 1571
Marelli	1102
Mark	1052
Matsui	1024, 1026, 1050, 1052, 1087, 1223, 1232, 1309, 1386
Mediator	1052
Memorex	1024
Metz	1102
Mitsubishi	1102, 1123, 1527
Mivar	1231, 1328
Multitech	1024, 1117, 1231
NEI	1052
Neckermann	1052, 1102, 1206 1364, 1571
Nikkai	1050, 1052, 1087 1231, 1233, 1279
Nobliko	1117
Nokia	1376, 1563
Nordmende	1124, 1302, 1358
Oceanic	1178, 1376
Orion	1052, 1309, 1335, 1336
Osaki	1087, 1232, 1233, 1279
Oso	1233
Osume	1087, 1172
Otake	1332
Otto Versand	1025, 1052, 1206 1232, 1335, 1358, 1364, 1527, 1571
Palladium	1385, 1433
Panama	1232, 1279
Panasonic	1141, 1178, 1241, 1265
Pathe Cinema	1231, 1253, 1335
Pausa	1024
Perdio	1335
Philco	1102, 1262
Philips	1052, 1102, 1389, 1571
Phoenix	1102
Phonola	1052, 1102
Pioneer	1124, 1178, 1302
Profex	1024, 1376
Proline	1336
Protech	1024, 1052, 1117, 1232, 1262, 1279, 1433
Quelle	1025, 1026, 1052 1215, 1342, 1343 1376, 1527
R-Line	1052
RFT	1102

Radiola	1052
Radiomarelli	1102
Rediffusion	1376
Revox	1052
Rex	1178, 1221, 1279
Roadstar	1024, 1233, 1279, 1433
SBR	1052
SEG	1232, 1279
SEI	1102, 1117, 1309
Saba	1090, 1102, 1124, 1178, 1302, 1350, 1358
Sacccs	1253
Saoshoo	1024, 1026, 1279
Salora	1178, 1364, 1374, 1376, 1563
Sambers	1117
Samsung	1024, 1052, 1105, 1232, 1279, 1385, 1571
Sandra	1231
Sanyo	1026, 1087, 1172, 1223
Schaub Lorenz	1376
Schneider	1052, 1233, 1262 1386, 1409
Sei-Sinudyne	1025
Seleco	1178, 1221
Sentra	1050
Sharp	1108
Shorai	1309
Siarem	1102, 1117
Siemens	1052, 1172, 1206, 1210, 1215, 1342, 1343
Singer	1102
Sinudyne	1102, 1117, 1309
Solavox	1178
Sonitron	1223
Sonoko	1024, 1052
Sonolor	1178, 1223
Sontec	1052
Sony	1025, 1026
Soundwave	1052, 1433
Standard	1024, 1232, 1233
Stern	1178, 1221
Sunkai	1309, 1336
Susumu	1233
Sysline	1052
Tandy	1078, 1178, 1232, 1233
Tashiko	1232, 1374
Tatung	1052, 1087, 1232
Tec	1232, 1262
Technema	1335

Technics	1265
Teleavia	1358
Telefunken	1124, 1350, 1358
Telemeister	1335
Teletch	1024
Teleton	1221, 1232, 1364
Tensai	1233, 1309, 1332, 1335
Texet	1231, 1233
Thomson	1124, 1302, 1358 1364, 1414
Thorn	1050, 1052, 1087, 1376, 1527
Thorn-Ferguson	1358
Tomashi	1297
Toshiba	1050
Uher	1221, 1335
Ultravox	1117
Universum	1052, 1279, 1385
Vestel	1052
Videosat	1262
Videotechnic	1232
Vision	1335
Voxson	1102, 1178
Waltham	1232
Watson	1052, 1335
Watt Radio	1117
Wega	1102
White Westinghouse	1052, 1231, 1335
Yoko	1052, 1232, 1279
Zanussi	1221

Satellite tuner**Récepteurs d'émission par satellite****Satelliten-Tuners****Satelliet-ontvanger****Sintonizzatore via satellite****Sintonizador de emisiones vía satélite**

2 * * *

AST	2366
Akai	2530
Alba	2377, 2436, 2470, 2530, 2628
Aldes	2303
Amstrad	2095, 2267, 2360, 2476
Ankaro	2235, 2303, 2384
Anttron	2198, 2436
Armstrong	2258
Astra	2123
Astro	2188
Avalon	2411
Axis	2384
BT	2530, 2683
Best	2384
Blaupunkt	2188
Boca	2258, 2528
Bush	2082
Cambridge	2359, 2530
Channel Master	2377
Commlink	2303
Connexions	2411
Conrad	2622
Crown	2258
Cyrus	2215
DDC	2377
DNT	2215, 2411
Echostar	2411
Emanon	2436
Ferguson	2082, 2198, 2351
Fidelity	2267
Finlux	2123, 2359, 2470
Freecom	2436
Fuba	2384, 2411, 2436
G-Sat	2198
Galaxis	2303

Gooding	2586
Grundig	2188, 2586, 2765
Hinari	2198
Hirschmann	2188, 2588
Hitachi	2470
Houston	2683
Huth	2235, 2258, 2303
ITT	2123
Intervision	2607
JVC	2530, 2586
Kathrein	2107, 2188, 2215 2457, 2519, 2673
Kreiselmeier	2188
Kyostar	2436
La Sat	2528, 2622
Lenco	2436
Lennox	2607
Lupus	2384
Luxor	2123, 2588
Manhattan	2470, 2607
Marantz	2215
Maspro	2107, 2351, 2765
Matsui	2359, 2586
Mediamarkt	2258
Minerva	2586
Morgan's	2258, 2528
Newhaus	2235
Nikko	2375, 2728
Nokia	2123, 2470, 2588
Nordmende	2377
Orbitech	2516
Oxford	2359
Pace	2082, 2198, 2351 2470, 2806
Palladium	2586
Palsat	2516

Panda	2470
Philips	2215, 2307, 2470 2586, 2765
Phonotrend	2303, 2607
Promax	2470
Prosat	2303
Quadral	2377, 2643
RFT	2215, 2235, 2303
Radiola	2215
Radix	2411
SAT	2366, 2476
SEG	2384, 2436
Saba	2351
Sabre	2470
Salora	2123
SatPartner	2436
Satec	2198
Schwaiger	2198, 2519
Seemann	2411
Siemens	2188
Skymaster	2303, 2643
Sunstar	2528
Tantec	2351, 2470
TechniSat	2277, 2516
Telefunken	2436
Teleka	2258, 2628
Thomson	2470
Tonna	2683
Triad	2366
Universum	2188, 2586
Ventana	2215
Vortec	2436
Vtech	2366
Wisi	2188, 2366, 2411, 2470

VCR
Magnétoscopes
Videorecorders
Videorecorder
Videoregistratore
Videograbadoras

4 * * *

5

ASA	4052, 4096
Aiwa	4015, 4363
Akai	4056, 4121, 4330
Akiba	4087
Alba	4035, 4087, 4224, 4293, 4330
Ambassador	4035
Amstrad	4015, 4293
Anitech	4087
Asuka	4052
Baird	4015, 4056, 4119
Basic Line	4035, 4087, 4293
Blaupunkt	4021, 4049, 4177, 4210, 4241, 4242
Brandt	4202, 4335, 4336
Brandt Electronic	4056
Bush	4087, 4224, 4293
CGE	4015
Catron	4035
Cimline	4087
Clatronic	4035
Condor	4035
Crown	4035, 4087, 4293
Daewoo	4035, 4293
Dansai	4087
De Graaf	4057, 4181
Decca	4015, 4096
Dual	4056
Dumont	4015, 4096, 4119
ESC	4255, 4293
Elcatech	4087
Ferguson	4056, 4335, 4336
Fidelity	4015
Finlandia	4096, 4119
Finlux	4015, 4057, 4096, 4119
Firstline	4052, 4058, 4060, 4087, 4224
Fisher	4061, 4119
Frontech	4035
Funai	4015
GEC	4096
General	4035
GoldHand	4087
GoldStar	4052, 4240
Goodmans	4015, 4035, 4052, 4087, 4293
Graetz	4056, 4119, 4255
Granada	4061, 4096, 4119

Grandin	4015, 4052, 4087
Grundig	4021, 4022, 4087, 4096, 4210, 4222, 4241, 4362
HCM	4087
Hanseatic	4052
Hinari	4019, 4087, 4255
Hitachi	4015, 4019, 4056, 4057, 4181, 4255
Hypson	4087
ITT	4056, 4061, 4119, 4121, 4255, 4399
ITV	4052, 4293
Imperial	4015
Ingersol	4019
Interfunk	4096
JVC	4056, 4082, 4222, 4399
Kaisui	4087
Kendo	4121, 4224
Kenwood	4056
Korpel	4087
Lenco	4293
Leyco	4087
Loewe	4019, 4021, 4052, 4096
Logik	4019, 4255
Luxor	4058, 4061, 4063 4119, 4121
M Electronic	4015
Manesth	4060, 4087
Marantz	4021, 4096
Matsui	4019, 4224, 4363
Memorex	4015, 4052, 4061, 4119
Memphis	4087
Metz	4021, 4177, 4210, 4242, 4362
Minerva	4021, 4210
Mitsubishi	4058, 4082, 4096
Multitech	4015, 4087
Murphy	4015
NEC	4056, 4082
Neckermann	4096
Nesco	4087
Nokia	4056, 4061, 4063, 4119, 4121, 4255
Nordmende	4056, 4335, 4336, 4399
Oceanic	4015, 4056
Okano	4330, 4363
Orion	4019, 4224, 4363

Osaki	4015, 4052, 4087
Otto Versand	4096
Palladium	4021, 4052, 4056, 4087
Panasonic	4177, 4241, 4242
Pathe Marconi	4056
Pentax	4057
Perdic	4015
Philips	4096, 4399
Phonola	4096
Pioneer	4082, 4096
Portland	4035
Profex	4337
Proline	4015
Pye	4096
Quartz	4061
Quelle	4096
Radiola	4096
Rex	4056, 4399
Roadstar	4052, 4087, 4255, 4293
SBR	4096
SEG	4255, 4337
SEI	4019, 4096
Saba	4056, 4222, 4335, 4336, 4399
Saisho	4019, 4224
Salora	4058, 4061, 4121
Samsung	4255, 4447
Sansui	4056, 4082
Sanyo	4061, 4119
Schaub Lorenz	4015, 4056, 4119
Schneider	4015, 4087, 4096
Seleco	4056
Sentra	4035
Sharp	4063
Shintom	4087, 4119
Shorai	4019
Siemens	4021, 4052, 4096, 4119, 4210
Silva	4052
Singer	4060
Sinudyne	4019, 4096
Solavox	4035
Sontec	4052
Sony	4047, 4048, 4049
Sunkai	4363
Sunstar	4015
Suntronic	4015
Tashiko	4015

VCR

Magnétoscopes
Videorecorders
Videorecorder
Videoregistratore
Videograbadoras

6

Tatung	4015, 4056, 4096
Tec	4035
Technics	4177, 4241
Teleavia	4056
Telefunken	4056, 4202, 4335, 4336, 4399
Tenosal	4087

Tensai	4015, 4337
Thomson	4056, 4335, 4399
Thorn	4056, 4119
Toshiba	4056, 4058, 4060, 4096, 4399
Towada	4337
Uher	4255

Universum	4015, 4021, 4052, 4096, 4121, 4210, 4255
Yamishi	4087
Yokan	4087
Yoko	4035, 4255

LD player**Lecteurs de LD****LD-Spieler****LD-speler****Lettore LD****Reproductores de LD****# 5 * * ***

Kenwood	5273
Marantz	5079, 5209
Philips	5079, 5209, 5403
Pioneer	5074

Radiola	5403
Salora	5079
Sony	5208, 5216
Telefunken	5074

DVD player**Lecteurs de DVD****DVD-Spieler****DVD-speler****Lettore DVD****Reproductores de DVD****# 6 * * ***

Kenwood	6549
Panasonic	6505
Philips	6554
Toshiba	6518

DAT deck**Platines DAT****DAT-Decks****DAT-deck****Registratori DAT****Platinas de casetes audiodigitales****# 7 * * ***

Grundig	7173
Kenwood	7231, 7267
Marantz	7173

Philips	7173
Sony	7108
Technics	7173

Cassette deck
Platines à cassette
Cassettendecks
Cassette deck
Registratore a cassette
Platinas de casetes

7 * * *

For Kenwood components connected via system control cords :	7990
Pour les composants Kenwood connectés par les cordons du système de commande :	7990
Für Kenwood-Komponenten, die über Systemsteuerkabel verbunden sind :	7990
Voor Kenwood componenten die aangesloten zijn met systeem verbindingsnoeren :	7990
Per componenti Kenwood collegati via cavi di controllo di sistema :	7990
Para componentes Kenwood conectados con los cables de control del sistema :	7990

Grundig	7044
Kenwood	7086, 7107, 7198, 7220, 7248, 7249
Marantz	7044
Memorex	7114, 7116
Onkyo	7150, 7151
Panasonic	7244

Philips	7044
Pioneer	7042, 7114, 7116
Revox	7044
Sharp	7220
Sony	7185, 7258
Technics	7244
Yamaha	7220

CD Player**Lecteurs de CD****CD-Spieler****CD-speler****Lettori CD****Reproductores de CD****# 8 * * ***

For Kenwood components connected via system control cords ;

Single CD player : 8990

Carrousel CD player : 8991

Multiple CD player (OUTPUT A to CD 1 jacks) : 8992

Multiple CD player (OUTPUT B to CD/TAPE 2 MONITOR jacks) : 8993

Depending on the type of a multiple CD player, these code may not work. Refer to " Assigning the connected components to the selected inputs " of the instruction manual.

Pour les composants Kenwood connectés par les cordons du système de commande ;

Lecteur de CD standard : 8990

Lecteur de CD à carrousel : 8991

Lecteur de CD à changeur (prises OUTPUT A à CD 1) : 8992

Lecteur de CD à changeur (prises OUTPUT B à CD2/TAPE2 MONITOR) : 8993

Selon le type de lecteur de CD à changeur, ces cordons peuvent ne pas fonctionner. Réferez-vous à " Attribution des appareils connectés aux entrées choisies " du mode d'emploi.

Für Kenwood-Komponenten, die über Systemsteuerkabel verbunden sind ;

Einzel-CD-Spieler : 8990

Karussell-CD-Spieler : 8991

Mehrfach-CD-Spieler (OUTPUT A an CD 1-Buchsen) : 8992

Mehrfach-CD-Spieler (OUTPUT B an CD 2/ TAPE 2 MONITOR-Buchsen) : 8993

Abhängig vom Typ des Mehrfach-CD-Spielers können diese Kabel unter Umständen nicht funktionieren. Sich auf den Abschnitt " Zuordnung der angeschlossenen Komponenten zu den gewählten Eingängen " der Bedienungsanleitung beziehen.

Voor Kenwood componenten die aangesloten zijn met systeem verbindingssnoeren ;

Gewone CD-speler : 8990

Carrousel CD-speler : 8991

Multi CD-speler (OUTPUT A naar CD 1 aansluiting) : 8992

Multi CD-speler (OUTPUT B naar CD 2/TAPE 2 MONITOR aansluiting) : 8993

Afhankelijk van het type Multi CD-speler is het mogelijk dat deze snoeren niet werken. Zie "Toewijzen van aangesloten componenten aan de geselecteerde ingangen " in de Gebruiksaanwijzing.

Per componenti Kenwood collegati via cavi di controllo di sistema ;

Lettores CD : 8990

Lettores CD a carosello : 8991

Lettores multi CD (presa di uscita OUTPUT A a presa CD 1) : 8992

Lettores multi CD (presa di uscita OUTPUT B a presa CD 2/TAPE 2 MONITOR) : 8993

A seconda del tipo di lettore multi CD, questi cavi possono non funzionare. Consultare la sezione "Assegnazione di componenti ai vari ingressi " del istruzioni per l'uso.

Para componentes Kenwood conectados con los cables de control del sistema ;

Reproductor de un CD : 8990

Reproductor de CD tipo carrusel : 8991

Reproductor de múltiples CDs (Tomas OUTPUT A a CD 1) : 8992

Reproductor de múltiples CDs (Tomas OUTPUT B a CD 2/TAPE 2 MONITOR) : 8993

Dependiendo del título de reproductor de múltiples CD, estos cables tal vez no sirvan. Consulte " Asignación de los componentes conectados a las entradas seleccionadas " del manual de instrucciones.

CD Player
Lecteurs de CD
CD-Spielers
CD-speler
Lettori CD
Reproductores de CD

Akai	8171
Alba	8303, 8618, 8630
Amstrad	8618
Arcam	8172
AudioTon	8172
Bush	8630
California Audio Lab	8044
Condor	8149
Cyrus	8172
Denon	8018, 8049
Fisher	8063
Grundig	8172
JVC	8087
Kenwood	8043, 8205, 8538, 8707

Linn	8172
Luxman	8604, 8793
MCS	8044
Marantz	8044, 8172
Matsui	8172, 8303
Memorex	8047
Meridian	8172
Micromega	8172
Mitsubishi	8171
NAD	8015
Naim	8172
Onkyo	8116
Panasonic	8044, 8318, 8382
Philips	8172

Pioneer	8047
Quad	8172
Quasar	8044
Radiotone	8630
Revox	8172
Rotel	8172
Schneider	8149, 8630
Sharp	8052
Sony	8015
Technics	8044, 8318
Toshiba	8496, 8707
Universum	8172
Watson	8630
Yamaha	8051, 8202

MD recorder
Enregistreur MD
MD-records
MD-recorder
Registratoro MD
Grabadora de MD

9 * * *

For Kenwood components connected via system control cords :	9990
Pour les composants Kenwood connectés par les cordons du système de commande :	9990
Für Kenwood-Komponenten, die über Systemsteuerkabel verbunden sind :	9990
Voor Kenwood componenten die aangesloten zijn met systeem verbindingssnoeren :	9990
Per componenti Kenwood collegati via cavi di controllo di sistema :	9990
Para componentes Kenwood conectados con los cables de control del sistema :	9990

Kenwood	9841
Sony	9505

Cable TV
Receptor de télévision câblée
Kabelfernseher
Kabel-TV
Televisione via cavo
Televisión por cable

0 * * *

British Telecom	0120
Decsat	0438
Jerrold	0018, 0291
PVP Stereo Visual Matrix	0018

Scientific Atlanta	0023, 0292
United Cable	0018
Westminster	0120

Non-IR codes

Codes Non-IR

"Non-IR" - Codes

"Non-IR" codes

Codici "Non-IR"

Códigos Non-IR

About Non-IR codes

If the required setup code is not found in the setup codes chart or the desired source component cannot be activated even when its setup code is input, try using the Non-IR code so that the component can be selected from the input selector of this unit.

After selecting the input with the input selector, operate the control key in use or the remote control unit.

Quelques mots sur les codes Non-IR

Si le code de configuration ne figure pas dans le tableau des codes de configuration, ou bien si l'appareil source ne peut pas être mise en service au moyen de son code de configuration, tentez d'utiliser un code Non-IR qui permette de sélectionner l'appareil au moyen du sélecteur d'entrée de cet appareil-ci. Après avoir choisi l'entrée au moyen du sélecteur d'entrée, agissez sur la touche de commande convenable ou sur le boîtier de télécommande.

Hinweise zu den "Non-IR"-Codes

Wenn der erforderliche gewünschte Setup-Code nicht in der Tabelle der Setup-Codes aufgefunden werden kann, oder wenn sich die gewünschte Signalquellen-Komponente auch mit dem korrekten Setup-Code nicht aktivieren läßt, kann versucht werden, einen Non-IR-Code zu verwenden, damit die Komponente am Eingangswahlschalter dieses Geräts gewählt werden kann.

Nachdem der Eingangsanschluß mit dem Eingangswahlschalter bestimmt wurde, die Steuertaste drücken oder die Fernbedienung betätigen.

Over "Non-IR" codes

Wanneer de benodigde setup code niet op de Setup CodeKaart staat, of wanneer de gewenste broncomponent niet geactiveerd kan worden zelfs niet wanneer zijn setup code wordt ingevoerd, probeert u dan de Non-IR code, zodat de component met de ingangskeuze-schakelaar van dit toestel kan worden geselecteerd.

Nadat u met de Ingangskeuze-schakelaar de bron van het ingangssignaal heeft gekozen, kunt u de bedieningstoetsen of de afstandsbediening gaan gebruiken.

A proposito del codici "Non-IR"

Se il codice di impostazione desiderato non viene trovato nella tabella dei codici di impostazione o se il componente desiderato non può venire attivato anche se viene scelto l'ingresso del suo segnale, provare ad usare un codice non-IR così che il componente possa venire scelto dal selettore d'ingresso dell'unità.

Scelto l'ingresso col selettore d'ingresso, usare i pulsanti di controllo dell'unità o del telecomando.

Acerca de los códigos Non-IR

Si el código de preparación necesario no se encuentra en la gráfica de códigos de preparación o el componente fuente deseado no puede activarse aunque se introduzca su código de preparación, pruebe a utilizar el códigos Non-IR para que ese componente pueda ser seleccionado con el selector de entrada de este aparato. Después de seleccionar la entrada con el selector de entrada, utilice las teclas de control o el mando a distancia.

TV	1998
Satellite tuner	2998
VCR	4998
LD player	5998
DVD player	6998
Cassette deck	7998
CD player	8998
MD recorder	9998
Cable TV	0998

Setup code to delete a setup code which is already registered on the remote control : 9999

If you disconnect a component and do not plan to replace it, you may want to delete the setup code from the remote control. Refer to the instruction manual for the operation.

Réglez un code pour effacer un code déjà enregistré sur la télécommande : 9999

Si vous déconnectez un composant et ne prévoyez pas de le remplacer, vous souhaitez peut-être effacer son code de la télécommande. Référez-vous au mode d'emploi pour savoir comment faire.

Setup-Code zum Löschen eines Setup-Codes, der bereits in der Fernbedienung registriert ist : 9999

Wenn Sie ein Komponente abklemmen und nicht vorhaben, das Gerät zu ersetzen, ist es empfehlenswert, den Setup-Code aus der Fernbedienung zu löschen. Für die erforderlichen Schritte sich auf die Bedienungsanleitung beziehen.

Setup code om een setup code die al geregistreerd is op de afstandsbediening te wissen : 9999

Wanneer u een component weghaalt en niet van plan bent deze te vervangen, is het misschien een goed idee om de setup code van dat apparaat uit de afstandsbediening te wissen. Raadpleeg de Gebruiksaanwijzing voor meer informatie over deze procedure.

Per cancellare un codice di impostazione nel telecomando, registrarne un altro : 9999

Se si scollega un componente e non si intende sostituirlo, si deve cancellare il suo codice dal telecomando. Per dettagli, consultare il istruzioni per l'uso.

El código de preparación para borrar un código de preparación que ya está registrado en el mando a distancia : 9999

Si desconecta un componente y no piensa reemplazarlo, tal vez desee borrar el código de preparación desde el mando a distancia. Consulte el manual de instrucciones para realizar esta operación.



12

Although each setup code is designed to work with a number of different models, certain codes may not work with some models. (Also, certain codes may only operate some of the functions available on a given model.) With some models, be sure to keep the ENTER key pressed for a while.



Bien que chaque code de commande doive permettre d'accéder au réglage de plusieurs modèles, il peut se trouver des codes qui sont sans effet sur un modèle donné. (Par ailleurs, selon les modèles, certains codes peuvent ne permettre que l'emploi d'un nombre limité de fonctions.) Dans le cas de certains modèles, il vous faut maintenir la pression sur la touche ENTER pendant quelques instants.



Jeder Setup-Code arbeitet in der Regel mit einer Reihe von unterschiedlichen Geräteversionen; bestimmte Codes sind jedoch mit einigen Geräteversionen nicht kompatibel (außerdem ist bei einigen Codes nicht die Steuerung aller Gerätefunktionen möglich). An einigen Modellen unbedingt die ENTER-Taste eine gewisse Zeit gedrückt halten.



Iedere kode is samengesteld voor een aantal verschillende modellen. Het is echter mogelijk dat bepaalde codes niet met bepaalde modellen werken. (Het is tevens mogelijk dat slechts bepaalde functies kunnen worden uitgevoerd.) Met sommige modellen moet u er op letten dat u de ENTER toets een tijdje ingedrukt moet houden.



Nonostante i dodici siano studiatiper funzionare ciascun con un numero di modelli differenti, alcuni potrebbero non funzionare con alcun modello ed altri potrebbero controllare solo alcune funzioni fra quelle disponibili. Per alcuni modelli, è necessario tenere il pulsante ENTER premuto per qualche tempo.



Aunque cada código de preparación ha sido diseñado para que funcione con un número de modelos diferentes, ciertos códigos de preparación tal vez no funcionen con algunos modelos. (Además, ciertos códigos tal vez activen sólo algunas de las funciones disponibles con ciertos modelos.) Con algunos modelos, asegúrese de mantener pulsada la tecla ENTER durante un rato.

Free Manuals Download Website

<http://myh66.com>

<http://usermanuals.us>

<http://www.somanuals.com>

<http://www.4manuals.cc>

<http://www.manual-lib.com>

<http://www.404manual.com>

<http://www.luxmanual.com>

<http://aubethermostatmanual.com>

Golf course search by state

<http://golfingnear.com>

Email search by domain

<http://emailbydomain.com>

Auto manuals search

<http://auto.somanuals.com>

TV manuals search

<http://tv.somanuals.com>