

KENWOOD

AUDIO VIDEO SURROUND RECEIVER

KRF-X9050D

INSTRUCTION MANUAL

KENWOOD CORPORATION

About the supplied remote control

Compared to standard remote controls, the remote control supplied with this receiver has several operation modes. These modes enable the remote control to control other audio/video components. In order to effectively use the remote control it is important to read the operating instructions and obtain a proper understanding of the remote control and how to switch its operation modes (etc.).

Using the remote control without completely understanding its design and how to switch the operation modes may result in incorrect operations.

Preparation

Operations

Remote Control

Additional Information

B60-4958-00 00 (MA) (M, Y, T, I, X) 0011

Before applying the power

Caution : Read this page carefully to ensure safe operation.

2

This unit is designed for operation as follows.

- U.S.A. and Canada AC 120 V only
- Australia AC 240 V only
- Europe and U.K. AC 230 V only
- China and Russia AC 220 V only
- *Other countries AC 110 - 120/220 - 240 V switchable

For the United Kingdom

Factory fitted moulded mains plug

1. The mains plug contains a fuse. For replacement, use only a 13-Amp ASTA-approved (BS1362) fuse.
2. The fuse cover must be refitted when replacing the fuse in the moulded plug.
3. Do not cut off the mains plug from this equipment. If the plug fitted is not suitable for the power points in your home or the cable is too short to reach a power point, then obtain an appropriate safety approved extension lead or adaptor, or consult your dealer. If nonetheless the mains plug is cut off, remove the fuse and dispose of the plug immediately, to avoid a possible shock hazard by inadvertent connection to the mains supply.

IMPORTANT: The wires in the mains lead are coloured in accordance with the following code:

- Blue : Neutral
- Brown : Live

Do not connect those leads to the earth terminal of a three-pin plug.

* AC voltage selection

The AC voltage selector switch on the rear panel is set to the voltage that prevails in the area to which the unit is shipped. Before connecting the power cord to your AC outlet, make sure that the setting position of this switch matches your line voltage. If not, it must be set to your voltage in accordance with the following direction.

AC voltage selector switch

Move switch lever to match your line voltage with a small screw-driver or other pointed tool.

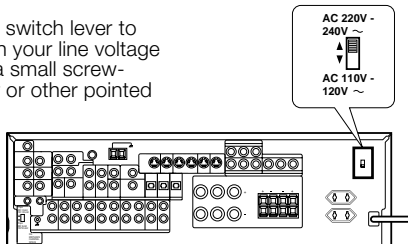

Note: Our warranty does not cover damage caused by excessive line voltage due to improper setting of the AC voltage selector switch.

Safety precautions

WARNING :

TO PREVENT FIRE OR ELECTRIC SHOCK, DO NOT EXPOSE THIS APPLIANCE TO RAIN OR MOISTURE.



CAUTION
RISK OF ELECTRIC SHOCK
DO NOT OPEN



CAUTION: TO REDUCE THE RISK OF ELECTRIC SHOCK, DO NOT REMOVE COVER (OR BACK). NO USER-SERVICEABLE PARTS INSIDE, REFER SERVICING TO QUALIFIED SERVICE PERSONNEL.



THE LIGHTNING FLASH WITH ARROWHEAD SYMBOL, WITHIN AN EQUILATERAL TRIANGLE, IS INTENDED TO ALERT THE USER TO THE PRESENCE OF UNINSULATED "DANGEROUS VOLTAGE" WITHIN THE PRODUCT'S ENCLOSURE THAT MAY BE OF SUFFICIENT MAGNITUDE TO CONSTITUTE A RISK OF ELECTRIC SHOCK TO PERSONS.



THE EXCLAMATION POINT WITHIN AN EQUILATERAL TRIANGLE IS INTENDED TO ALERT THE USER TO THE PRESENCE OF IMPORTANT OPERATING AND MAINTENANCE (SERVICING) INSTRUCTIONS IN THE LITERATURE ACCOMPANYING THE APPLIANCE.

Unpacking

Unpack the unit carefully and make sure that all accessories are put aside so they will not be lost.

Examine the unit for any possibility of shipping damage. If your unit is damaged or fails to operate, notify your dealer immediately. If your unit was shipped to you directly, notify the shipping company without delay. Only the consignee (the person or company receiving the unit) can file a claim against the carrier for shipping damage.

We recommend that you retain the original carton and packing materials for future use should you transport or ship the unit in the future.

Keep this manual handy for future reference.

Accessories

FM indoor antenna (1)

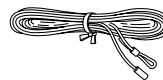

AM loop antenna (1)

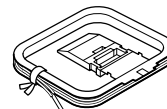

Remote control unit (1)
RC-R0714

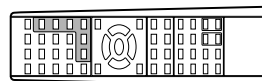

Batteries (R6/AA) (2)

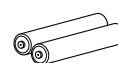

For U.K. only
Remote control unit (1)
RC-R0715

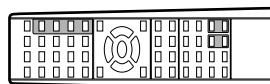

Batteries (R6/AA) (2)

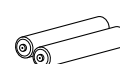

*AC plug adaptor (1)

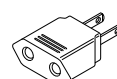

* Use to adapt the plug on the power cord to the shape of the wall outlet. (Accessory only for regions where use is necessary.)

Maintenance of the unit



When the front panel or case becomes dirty, wipe with a soft, dry cloth. Do not use thinner, benzine, alcohol, etc. for these agents may cause discoloration.

In regard to contact cleaner

Do not use contact cleaners because it could cause a malfunction. Be specially careful not to use contact cleaners containing oil, for they may deform the plastic component.

Contents

Caution : Read the pages marked  carefully to ensure safe operation.

Preparations	 Before applying the power 2	Preparations
	 Safety precautions 2	
	Unpacking 2	
	How to use this manual 4	
	Special features 4	
	Names and functions of parts 5	
	Remote control unit (RC-R0714) 6	
	Remote control unit (RC-R0715) (For U.K. only) 7	
	Setting up the system 8	
	Connecting audio components 9	
	Connecting video components 10	
	Digital connections 11	
	Connecting video components (COMPONENT VIDEO) 12	
	Connecting a DVD player (6-channel input) 13	
	Connecting the speakers 14	
Connecting the terminals 15		
Connecting to another room or area (ROOM B) 16		
PRE OUT connections 17		
Connecting to the AV AUX jacks 18		
Connecting the antennas 18		
Connecting the system control 19		
Preparing the remote control 20		
Preparing for surround sound 21		
Speaker settings 21		
Operations	Normal playback 23	Operations
	Preparing for playback 23	
	Listening to a source component 23	
	Adjusting the sound 24	
	Recording 25	
	Recording audio (analog sources) 25	
	Recording video 25	
	Recording audio (digital sources) 25	
	Listening to radio broadcasts 26	
	Tuning radio stations 26	
	Presetting radio stations manually 26	
	Receiving preset stations 26	
	Receiving preset stations in order (P.CALL) 27	
	Using RDS (Radio Data System) (For U.K. only) 27	
	Using the RDS DISP. (Display) key (For U.K. only) 27	
Presetting RDS stations (RDS AUTO MEMORY) (For U.K. only) 28		
Tuning by program type (PTY search) (For U.K. only) 28		
Ambience effects 29		
Surround modes 29		
Surround play 32		
DVD 6-channel playback 33		
Convenient functions 33		
Remote Control	Basic remote control operation for other components 35	Remote Control
	Registering setup codes for other components .. 35	
	Operating other components 35	
	Setup code chart 36	
	Remote control operation of other components 44	
Additional Information	In case of difficulty 49	Additional Information
	 Specifications 51	

How to use this manual

This manual is divided into four sections: Preparations, Operations, Remote Control, and Additional Information.

Preparations

Shows you how to connect your audio and video components to the receiver and prepare the surround processor.

We will guide you to make setting up your system as easy as possible. However, since this receiver works with all of your audio and video components, connecting the system can be fairly complex.

Operations

Shows you how to operate the various functions available from the receiver.

Remote Control

Shows you how to operate other components using the remote control, as well as a detailed explanation of all remote control operations. Once you have registered your components with the proper setup codes, you'll be able to operate both this receiver and your other AV components (TV, VCR, DVD player, LD player, CD player, etc.) using the remote control supplied with this receiver.

Additional Information

Shows you additional information such as "In case of difficulty" (troubleshooting) and "Specifications".

Special features

True home theater sound

This receiver incorporates a wide variety of surround modes to bring you maximum enjoyment from your video software. Select a surround mode according to your equipment or the software you are going to play and enjoy!

→ 29

Home THX Cinema

THX Select incorporates a complex multichannel digital audio program materials such as Dolby Digital, PRO LOGIC & DTS which enables multichannel decoding.

This system features Re-equalization (Re-EQ), Timbre Matching, Adaptive Decorrelation, Bass Peak Level Manager and Loudspeaker Position Time Synchronization, which reproduces similar cinematic effects in the home environment.

Dolby Digital

The DOLBY DIGITAL mode lets you enjoy full digital surround from software processed in the Dolby Digital format. Dolby Digital provides up to 5.1 channels of independent digital audio for better sound quality and more powerful presence than conventional Dolby Surround.

Dolby Pro Logic II

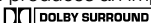
DOLBY PRO LOGIC II, whilst totally compatible with its predecessor PRO LOGIC, provides greater advantage in surround sound. It allows the users to enjoy the conventional stereo or Dolby Surround with a convincing "5.1 like" presentation. PRO LOGIC II offers special features for controlling the overall spatial, dimensionality, and frontal sound field imaging. PRO LOGIC II produces an impressive surround sound from video software marked  and three-dimensional space from music CD. When listening to music, you will be able to enjoy the experience of sheer STEREO surround sound.

Dolby 3 Stereo

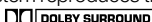
This surround system reproduces theater-like surround sound from video software marked .

The 3 STEREO mode will redirect the Surround signal to the front left and right speakers when only the front and center speakers are used.

DTS

DTS (Digital Theater System) is a 5.1 channel digital audio format that provides five full-spectrum channels and one low-frequency (subwoofer) channel for unprecedented clarity, optimum channel separation and a (wide) dynamic range.

In the DTS mode, the 5.1 channel digital input from a DTS CD, LD or DVD disc (carrying the "DTS" marking) can be played in Digital Surround.

Important:

When a DTS disc is played on a CD, LD or DVD player, noise may be output from the analog output. It is recommended that you connect the digital output of the player to the digital input of this unit.

Multi channel music (SRS Circle Surround (●)CS)

SRS Circle surround enables you to listen to multi channel sound from the stereo source. We assume you have already enjoyed listening to Dolby digital sound/DTS multi channel sound with your multi speakers. Now, this time try listening to the stereo source (ex. Audio CD) using your multi speakers. You may discover a new type of "stereo" sound through SRS Circle Surround.

DSP surround modes

The DSP (Digital Signal Processor) used for this receiver incorporates a variety of high quality adjustable sound fields, like "ARENA", "JAZZ CLUB", "THEATER", "STADIUM" and "DISCO". It is compatible with almost any kind of program source.

DVD 6-channel input

If you own a DVD player equipped with 6-channel output, this receiver allows you to obtain the full surround sound impact of DVD source material featuring multi-channel encoding. Since the source signals are digital and each channel is input independently, the resulting ambience is far superior to what can be achieved with conventional surround sound systems.

Universal IR (InfraRed) remote signal

In addition to the basic receiver, the remote control supplied with this receiver can also operate almost all of your remote controllable audio and video components. Just follow the simple setup procedure to register the components you have connected.

Memory back up function

Please note that the following items will be deleted from the unit's memory if the power cord is disconnected from the AC outlet for approximately 2 days.

- Power mode.
- Input selector settings.
- Device preset.
- Picture output.
- Speaker ON/OFF
- Volume level.
- BASS, TREBLE, INPUT level.
- Subwoofer ON/OFF.
- Dimmer level.
- Monitor ON/OFF.
- MD/TAPE settings.
- 6ch/2ch input setting.
- Listen mode setting.
- Speaker settings.
- Input mode setting.
- Midnight mode setting.
- Broadcast band.
- Frequency setting.
- Preset stations.
- Tuning mode.
- Source Direct.
- RF Band.
- THX.
- SW RE-MIX.
- Bass Peak Level.

Names and functions of parts

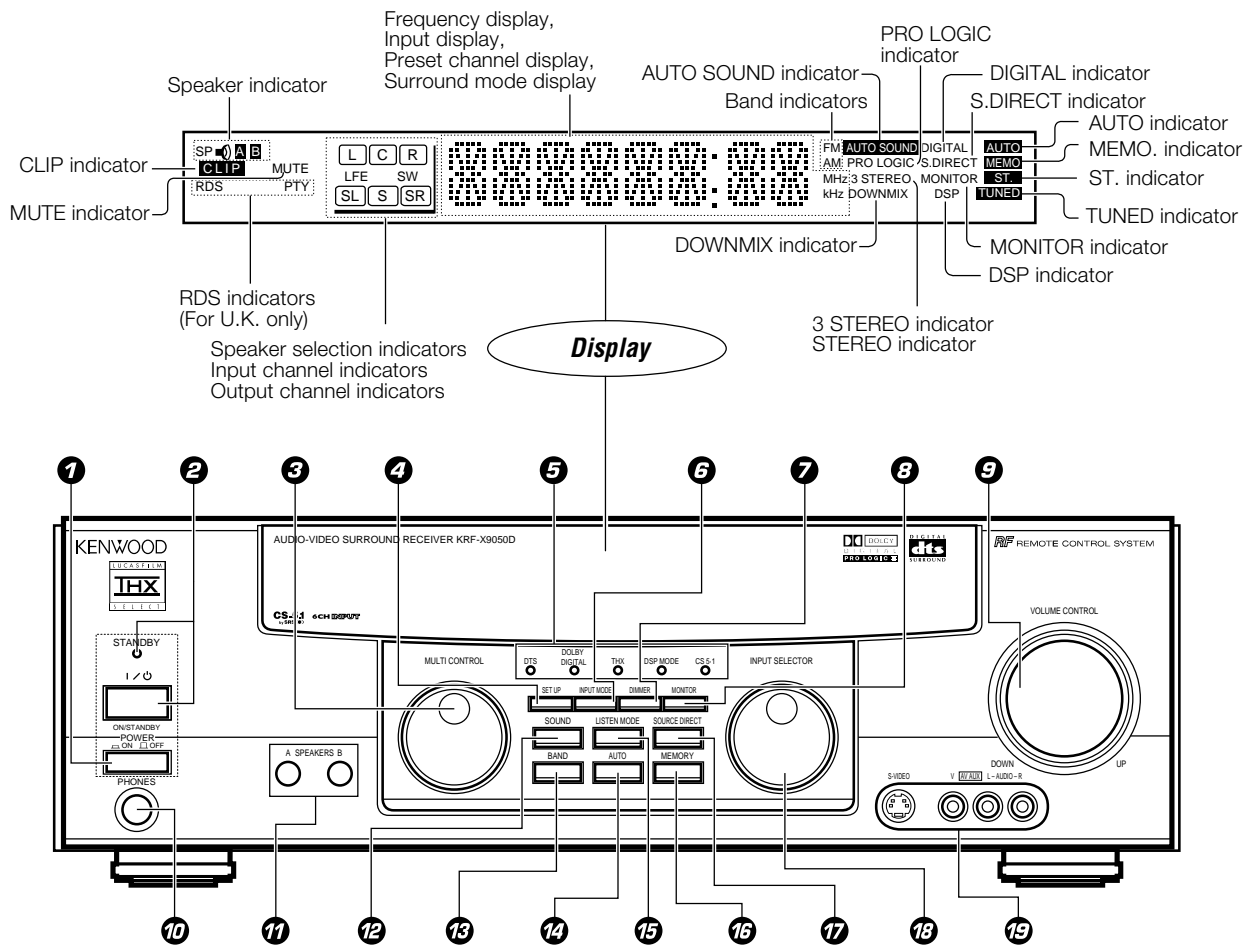

- 1 POWER key** - 21
Use to switch the main power ON/OFF
- 2 ON/STANDBY (I/ψ) key** - 21
Use to switch the power ON/STANDBY when the POWER is turned ON.
- 3 STANDBY indicator** - 21
- 4 MULTI CONTROL knob** - 21
Use to control a variety of settings.
- 5 SET UP key** - 21
Use to select the speakers' settings etc.
- 6 Surround indicators**
 - DTS indicator** - 32
Lights when the receiver is in the DTS mode.
 - DOLBY DIGITAL indicator** - 32
Lights when the receiver is in the Dolby Digital mode.
 - THX indicator** - 24
Lights when the receiver is in the THX mode.
 - DSP MODE indicator** - 32
Lights when the receiver is in the DSP mode.
 - CS 5.1 indicator** - 32
Lights when the receiver is in the CS 5.1 mode.
- 7 INPUT MODE key** - 8
Use to switch between the digital and analog inputs.
- 8 DIMMER key** - 24
Use to adjust the brightness of the display.
- 9 MONITOR key** - 25
Use to select the REC MODE.
- 10 MONITOR key** - 25
Use to monitor the source that is connected to the MONITOR jack.
- 11 VOLUME CONTROL knob** - 23
Use to adjust the volume.
- 12 SPEAKERS A/B keys** - 23
Use to turn the A/B speakers ON/OFF.
- 13 SOUND key** - 24
Use to adjust the sound quality and ambience effects.
- 14 BAND key** - 26
Use to select the broadcast band.
- 15 AUTO key** - 23
Use to change "TAPE" indication to "MD".
- 16 LISTEN MODE key** - 26
Use to select the auto tuning mode.
- 17 MEMORY key** - 32
Use to select the listening mode.
- 18 MEMORY key** - 26
Use to store radio stations in the preset memory.
- 19 SOURCE DIRECT key** - 24
Use to pass the source material direct to the amplifier.
- 20 INPUT SELECTOR knob** - 23
Use to select the input sources.
- 21 AV AUX (S VIDEO, V, AUDIO L/R) jacks** - 18

Standby mode

When standby indicator is lit, this receiver is in standby mode and consumes a small amount of current for back-up. This system can be switched on using remote control.

Remote control unit (RC-R0714)

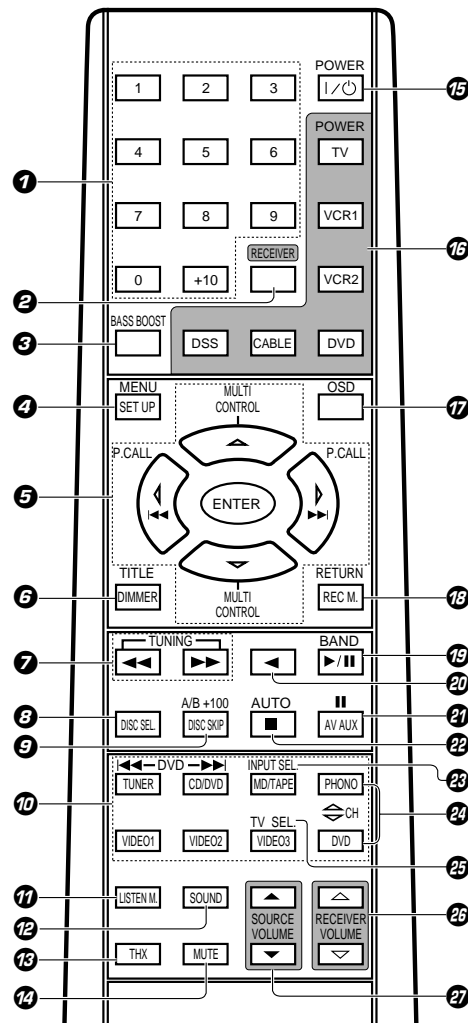

If the name of a function is different on the receiver and on the remote control, the name of the remote control key in this manual is indicated in parentheses.

- 1 Numeric keys** - [44]
Provide functions identical to those of the original remote control supplied with the component you are controlling.
- 2 RECEIVER key**
Use to return to the operation of the receiver.
- 3 BASS BOOST key** - [24]
Use to select the maximum adjustment setting for the low frequency range.
- 4 MENU key**
Use to operate other components.
SET UP key - [21]
Use to select the speakers' settings etc.
- 5 MULTI CONTROL keys** - [21]
Use to control a variety of settings.
Use to operate other components.
P.CALL \lll / \ggg keys - [27]
If tuner is selected as the input source, these keys function as P.CALL keys.
 \lll / \ggg keys
If CD or MD is selected as the input source, these keys function as skip keys.
ENTER key
Use to operate other components
- 6 TITLE key**
Use to operate other components.
DIMMER key - [34]
Use to adjust the brightness of the display.
- 7 TUNING** \lll / \ggg keys
Use to operate the tuner or selected component.
If CD, MD or TAPE is selected as the input source, these keys function as search keys.
- 8 DISC SEL. key**
Use to operate other components.
- 9 DISC SKIP key**
If CD is selected as the input source, this key functions as the multi-CD player disc skip key.
A/B key
If TAPE is selected as the input source, this is (A and B) of a double cassette deck.
+100 key
Use to select the track number with the MD recorder.
- 10 INPUT SELECTOR keys (TUNER, CD/DVD, MD/TAPE, PHONO, VIDEO1, VIDEO2, VIDEO3, DVD)**
Use to select the input sources.
DVD \lll / \ggg key
When in DVD player operations, these keys function as skip keys.
- 11 LISTEN M. key** - [32]
Use to select the listening mode.
- 12 SOUND key** - [24]
Use to adjust the sound quality and ambience effects.
- 13 THX key**
Use to switch the status of THX.
- 14 MUTE key**
Use to temporarily mute the sound.
- 15 POWER (I/O) key**
Use to turn the receiver on and off.
- 16 Source POWER key (TV, VCR1, VCR2, DVD, CABLE, DSS)** - [35]
Use to turn the other components on and off.
- 17 OSD key**
Use to operate other components.
- 18 RETURN key**
Use to operate other components.
- REC M. key**
Use to select the REC MODE.
- 19 \ggg / \lll key**
If CD is selected as the input source, this key functions as the play/pause key.
If MD or TAPE selected as the input source, this key functions as the play key.
BAND key - [26]
Use to select the broadcast band.
- 20 \lll key**
If tape is selected as the input source, this key functions as the play key for side B of the cassette (the side facing away from the front of the deck).
- 21 AV AUX key**
II key
Use to operate other components.
- 22 AUTO key** - [26]
Use to select the auto tuning mode.
■ key
If CD, MD or TAPE is selected as the input source, this key functions as the stop key.
- 23 INPUT SEL. key**
Use to operate other components.
- 24 CH Δ / ∇ key**
Use to select the channel.
- 25 TV SEL key**
Use to operate other components.
- 26 VOLUME Δ / ∇ (RECEIVER) keys** - [23]
Use to adjust the receiver volume.
- 27 VOLUME Δ / ∇ (SOURCE) keys**
Use to adjust the source volume.

Remote control unit (RC-R0715) (For U.K. only)

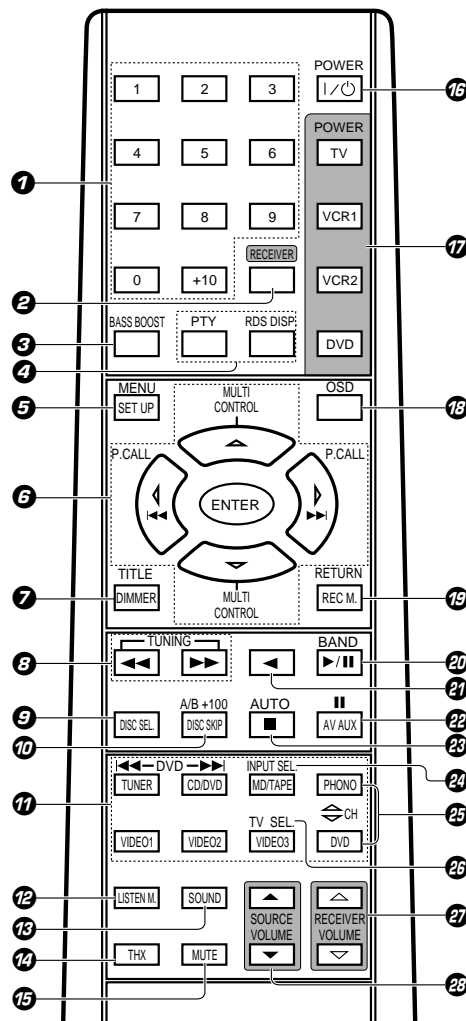

If the name of a function is different on the receiver and on the remote control, the name of the remote control key in this manual is indicated in parentheses.

- 1 Numeric keys** - [44]
Provide functions identical to those of the original remote control supplied with the component you are controlling.
- 2 RECEIVER key**
Use to return to the operation of the receiver.
- 3 BASS BOOST key** - [24]
Use to select the maximum adjustment setting for the low frequency range.
- 4 PTY key** - [28]
Use for PTY search.
- RDS DISP. key** - [27]
Use to receive RDS broadcasts.
- 5 MENU key**
Use to operate other components.
- SET UP key** - [21]
Use to select the speakers' settings etc.
- 6 MULTI CONTROL keys** - [21]
Use to control a variety of settings. Use to operate other components.
- P.CALL <◀/▶> keys** - [27]
If tuner is selected as the input source, these keys function as P.CALL keys.
- <◀/▶> keys**
If CD or MD is selected as the input source, these keys function as skip keys.
- ENTER key**
Use to operate other components
- 7 TITLE key**
Use to operate other components.
- DIMMER key** - [34]
Use to adjust the brightness of the display.
- 8 TUNING <◀/▶> keys**
Use to operate the tuner or selected component.

If CD, MD or TAPE is selected as the input source, these keys function as search keys.

- 9 DISC SEL. key**
Use to operate other components.
- 10 DISC SKIP key**
If CD is selected as the input source, this key functions as the multi-CD player disc skip key.
- A/B key**
If TAPE is selected as the input source, this is (A and B) of a double cassette deck.
- +100 key**
Use to select the track number with the MD recorder.
- 11 INPUT SELECTOR keys (TUNER, CD/DVD, MD/TAPE, PHONO, VIDEO1, VIDEO2, VIDEO3, DVD)**
Use to select the input sources.
- << DVD >> key**
When in DVD player operations, these keys function as skip keys.
- 12 LISTEN M. key** - [32]
Use to select the listening mode.
- 13 SOUND key** - [24]
Use to adjust the sound quality and ambience effects.
- 14 THX key**
Use to switch the status of THX.
- 15 MUTE key**
Use to temporarily mute the sound.
- 16 POWER (I/O) key**
Use to turn the receiver on and off.
- 17 Source POWER key (TV, VCR1, VCR2, DVD, CABLE, DSS)** - [35]
Use to turn the other components on and off.
- 18 OSD key**
Use to operate other components.

- 19 RETURN key**
Use to operate other components.
- REC M. key**
Use to select the REC MODE.
- 20 >/II key**
If CD is selected as the input source, this key functions as the play/pause key. If MD or TAPE is selected as the input source, this key functions as the play key.
- BAND key** - [26]
Use to select the broadcast band.
- 21 < key**
If tape is selected as the input source, this key functions as the play key for side B of the cassette (the side facing away from the front of the deck).
- 22 AV AUX key**
Use to operate other components.
- 23 AUTO key** - [26]
Use to select the auto tuning mode.
- key**
If CD, MD or TAPE is selected as the input source, this key functions as the stop key.
- 24 INPUT SEL. key**
Use to operate other components.
- 25 CH Δ/∇ key**
Use to select the channel.
- 26 TV SEL. key**
Use to operate other components.
- 27 VOLUME Δ/∇ (RECEIVER) keys** - [23]
Use to adjust the receiver volume.
- 28 VOLUME ▲/▼ (SOURCE) keys**
Use to adjust the source volume.

Setting up the system

8

Make connections as shown on the following pages. When connecting the related system components, be sure to also refer to the instruction manuals supplied with the components you are connecting. Do not connect the power cord to a wall outlet until all connections are completed.

DTS disclaimer clause

DTS Digital Surround™ is a discrete 5.1 channel digital audio format available on CD, LD, and DVD software which consequently cannot be decoded and played back inside most CD, LD, or DVD players. For this reason, when DTS-encoded software is played back through the analog outputs of the CD, LD, or DVD player, excessive noise will be exhibited. To avoid possible damage to the audio system, proper precautions should be taken by the consumer if the analog outputs are connected directly to an amplification system. To enjoy DTS Digital Surround™ playback, an external 5.1 channel DTS Digital Surround™ decoder system must be connected to the digital output (S/P DIF, AES/EBU, or TosLink) of the CD, LD or DVD player.

Notes

1. Be sure to insert all connection cords securely. If their connections are imperfect, the sound may not be produced or noise may interfere.
2. Be sure to remove the power cord from the AC outlet before plugging or unplugging any connection cords. Plugging/unplugging connection cords without disconnecting the power cord can cause malfunctions and may damage the unit.
3. Do not connect power cords from components which power consumption is larger than what is indicated on the AC outlet at the rear of this unit.

Analog connections

Audio connections are made using RCA pin cords. These cables transfer stereo audio signal in an "analog" form. This means the audio signal corresponds to the actual audio of two channels. These cables usually have 2 plugs on each end, one red for the right channel and one white for the left channel. These cables are usually packaged with the source unit, or are available at your local electronics retailer.

Microcomputer malfunction

If operation is not possible or an erroneous display appears, even though all connections have been made properly, reset the microcomputer referring to "In case of difficulty".

— 49

CAUTION

Be sure to adhere to the followings, or proper ventilation will be blocked causing damage or fire hazard.

- Do not place any objects impairing heat radiation onto the top of the unit.
- Leave a space around the unit (from the largest outside dimension including projection) equal or greater than, shown below.
Top panel : 50 cm Side panel : 10 cm Back panel : 10 cm

Input mode settings

CD/DVD, DVD/6ch, VIDEO2 and VIDEO3 inputs each include jacks for digital audio input and analog audio input.

You must select beforehand which type of input is to be used for each connected component.

The initial factory settings for audio signal playback (CD/DVD, DVD/6ch) and (VIDEO2, VIDEO3) are digital and analog respectively.

To use the analog audio input for playback instead (if, for example, you have connected a VCR to the VIDEO2 or VIDEO3 input), you must set the input mode for the corresponding input to the analog mode.

After completing connections and turning on the receiver, follow the steps below.

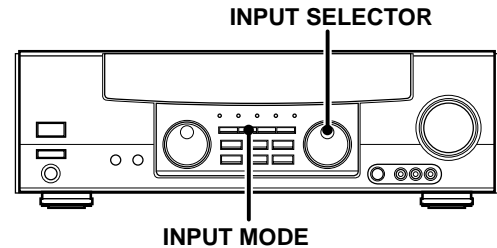

- 1 Use the **INPUT SELECTOR** knob to select CD/DVD, DVD/6ch, VIDEO2, or VIDEO3.

- 2 Press the **INPUT MODE** key.

Each press switches the setting as follows:

In DTS play mode

- 1 **D-AUTO** (digital input, auto sound)
- 2 **D-MANUAL** (digital input, manual sound)

In DVD/6ch play mode

- 1 **D-AUTO** (digital input, auto sound)
- 2 **D-MANUAL** (digital input, manual sound)
- 3 **6ch INPT** (DVD/6ch input)
- 4 **ANALOG** (analog input, manual sound)

In modes other than DTS or DVD/6ch play mode

- 1 **D-AUTO** (digital input, auto sound)
- 2 **D-MANUAL** (digital input, manual sound)
- 3 **ANALOG** (analog input, manual sound)

Digital input:

Select this setting to play digital signals from a DVD, CD, or LD player.

Analog input:

Select this setting to play analog signals from a cassette deck, VCR, or turntable.

Auto sound:

In the auto sound mode (**AUTO SOUND** indicator lights), the receiver selects the listening mode automatically during playback to match the type of input signal (Dolby Digital, PCM, DTS) and the speaker setting. The initial factory setting is auto sound on.

To keep the receiver set to the currently selected listening mode, use the **INPUT MODE** key to select "**D-MANUAL**" (manual sound). However, even when this setting is selected, there may be cases in which the listening mode is selected automatically to match a Dolby Digital source signal depending on the combination of listening mode and source signal.

If the **INPUT MODE** key is pressed quickly, sound may not be produced.

Connecting audio components

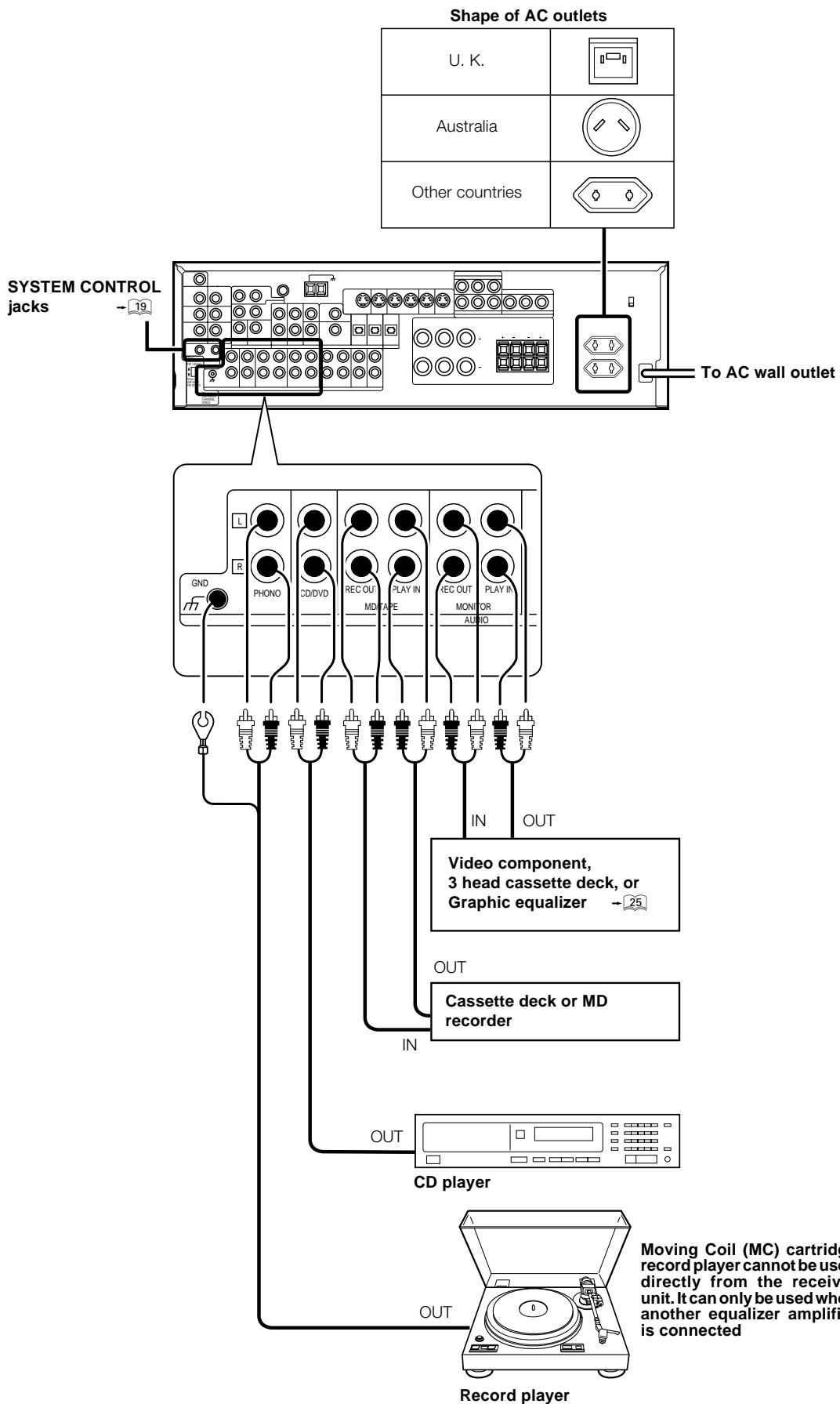

When you connect the unit and the CD or MD player with the digital connection, you can enjoy a better sound quality.

Connecting video components

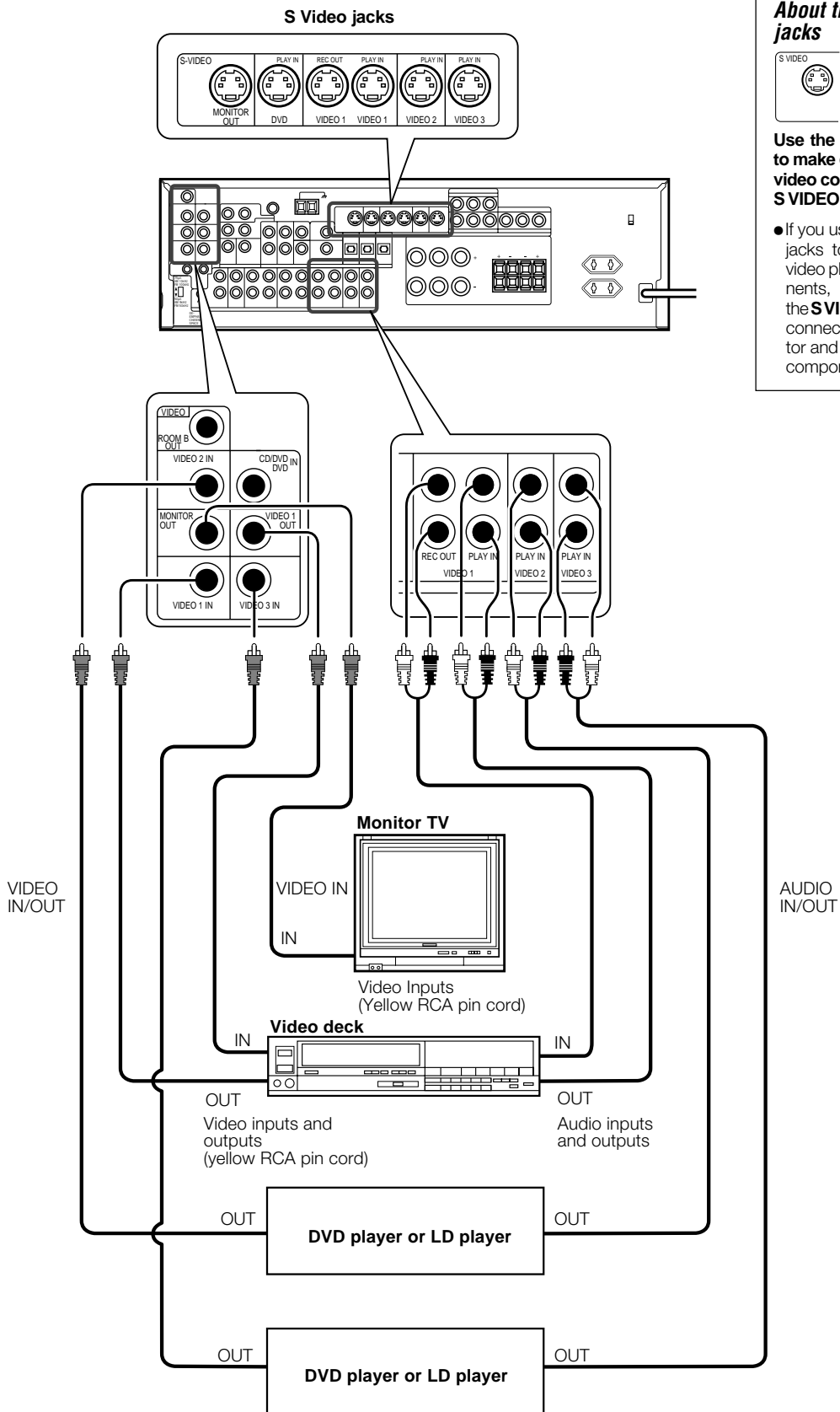

About the S VIDEO jacks

Use the S VIDEO jacks to make connections to video components with S VIDEO IN/OUT jacks.

- If you use the S VIDEO jacks to connect your video playback components, be sure to use the SVIDEO jacks when connecting your monitor and video recording components.

A video component with digital audio outputs should be connected to the VIDEO2 or VIDEO3 jacks.

Digital connections

The digital in jacks can accept DTS, Dolby Digital, or PCM signals. Connect components capable of outputting DTS, Dolby Digital, or standard PCM (CD) format digital signals. If you have connected any digital components to the receiver, be sure to read the "Input mode settings" section carefully. 

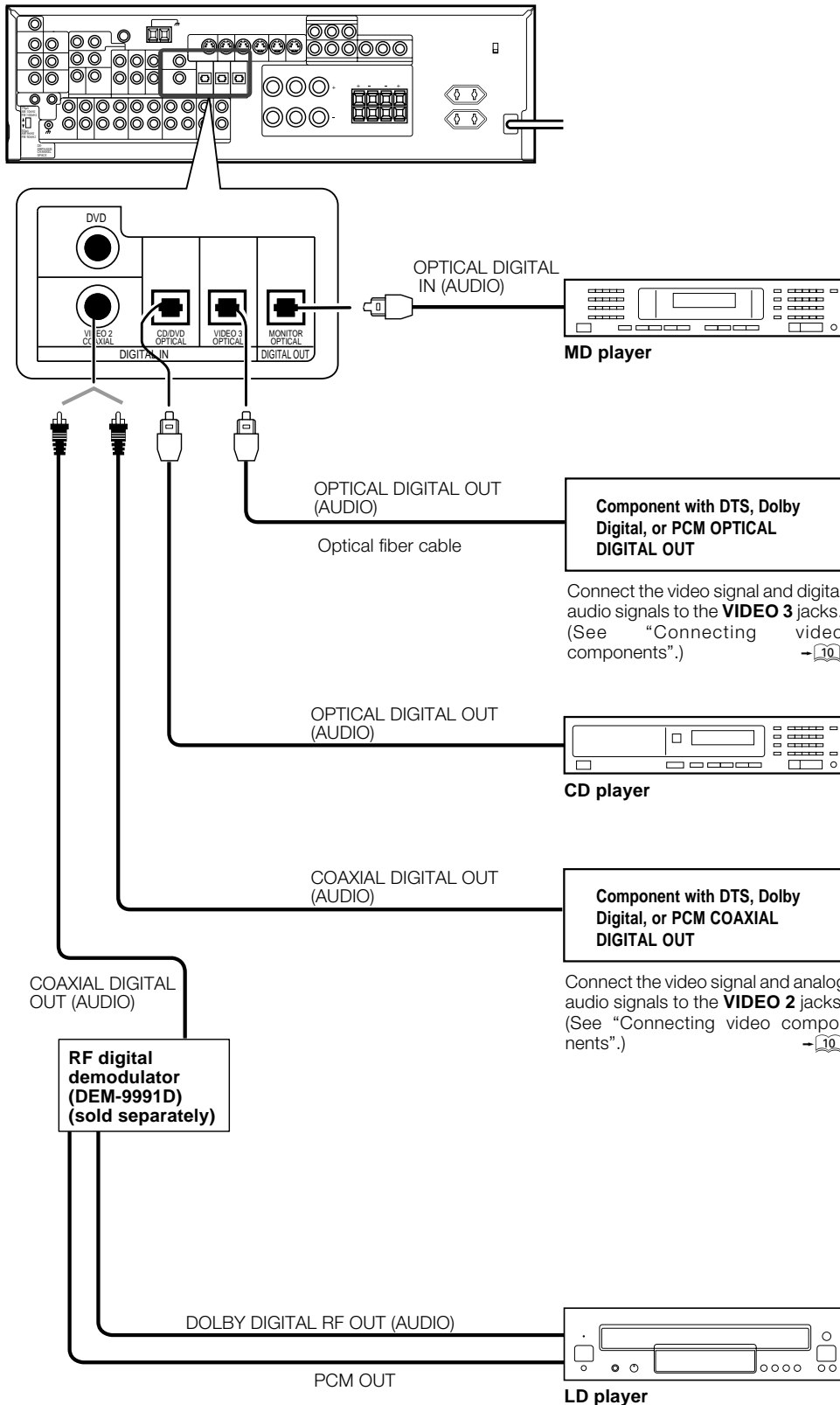

To connect an LD player with a DIGITAL RF OUT, connect the LD player to the KENWOOD RF digital demodulator (DEM-9991D). Next, connect the DIGITAL OUT jacks of the demodulator to the DIGITAL IN jacks of the receiver. Connect the video signal and analog audio signals to the VIDEO 2 or VIDEO 3 jacks. (See "Connecting video components".)

Connecting video components (COMPONENT VIDEO)

If you have connected the receiver to a video component with COMPONENT jacks, you can get a better picture quality than by connecting to the S-VIDEO jacks.

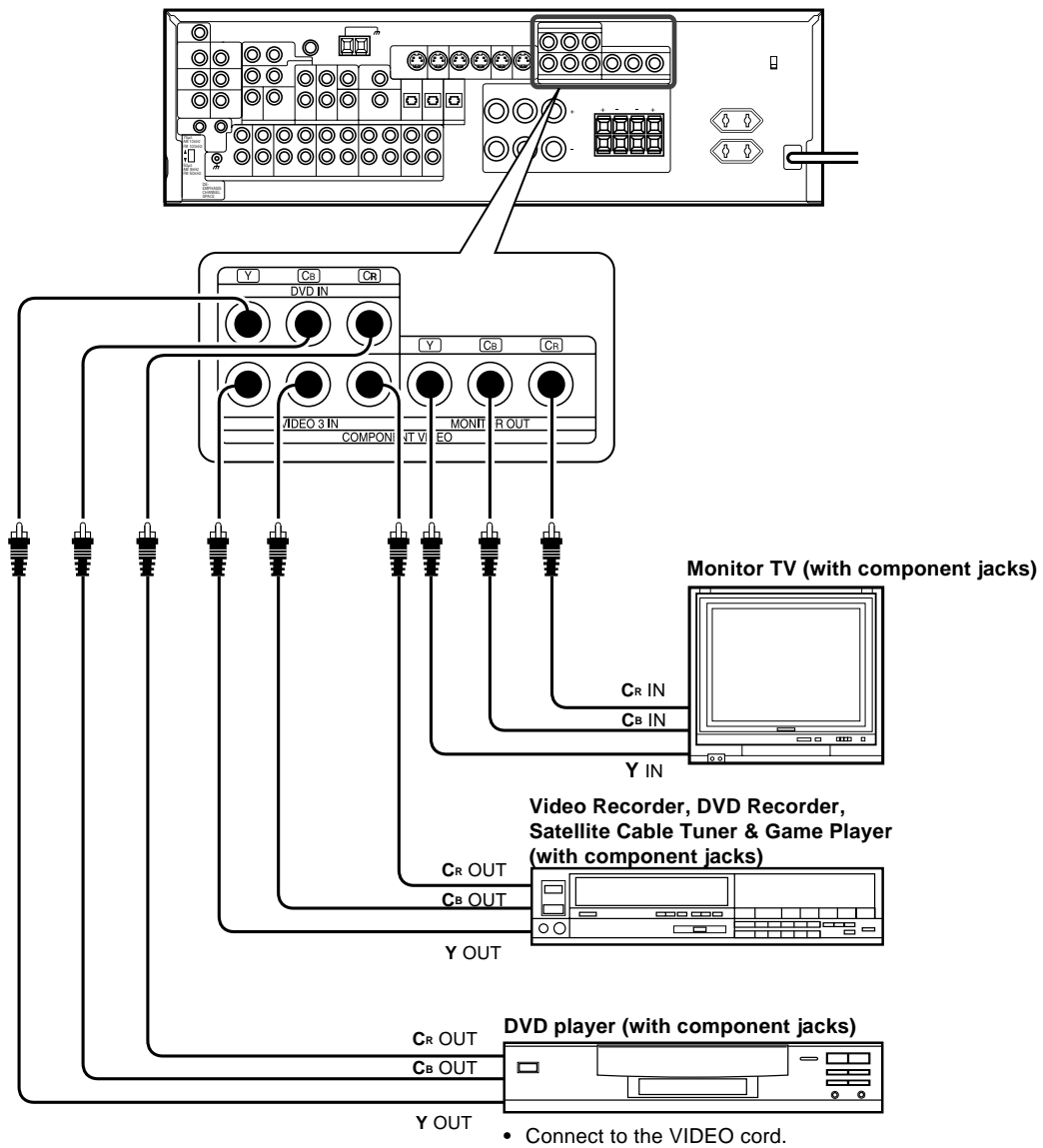

When connecting the TV to the COMPONENT jacks, be sure to connect all the other components to the COMPONENT jacks.

Connecting a DVD player (6-channel input)

If you have connected a DVD player to the receiver with digital connection, be sure to read the "Input mode settings" section carefully. 

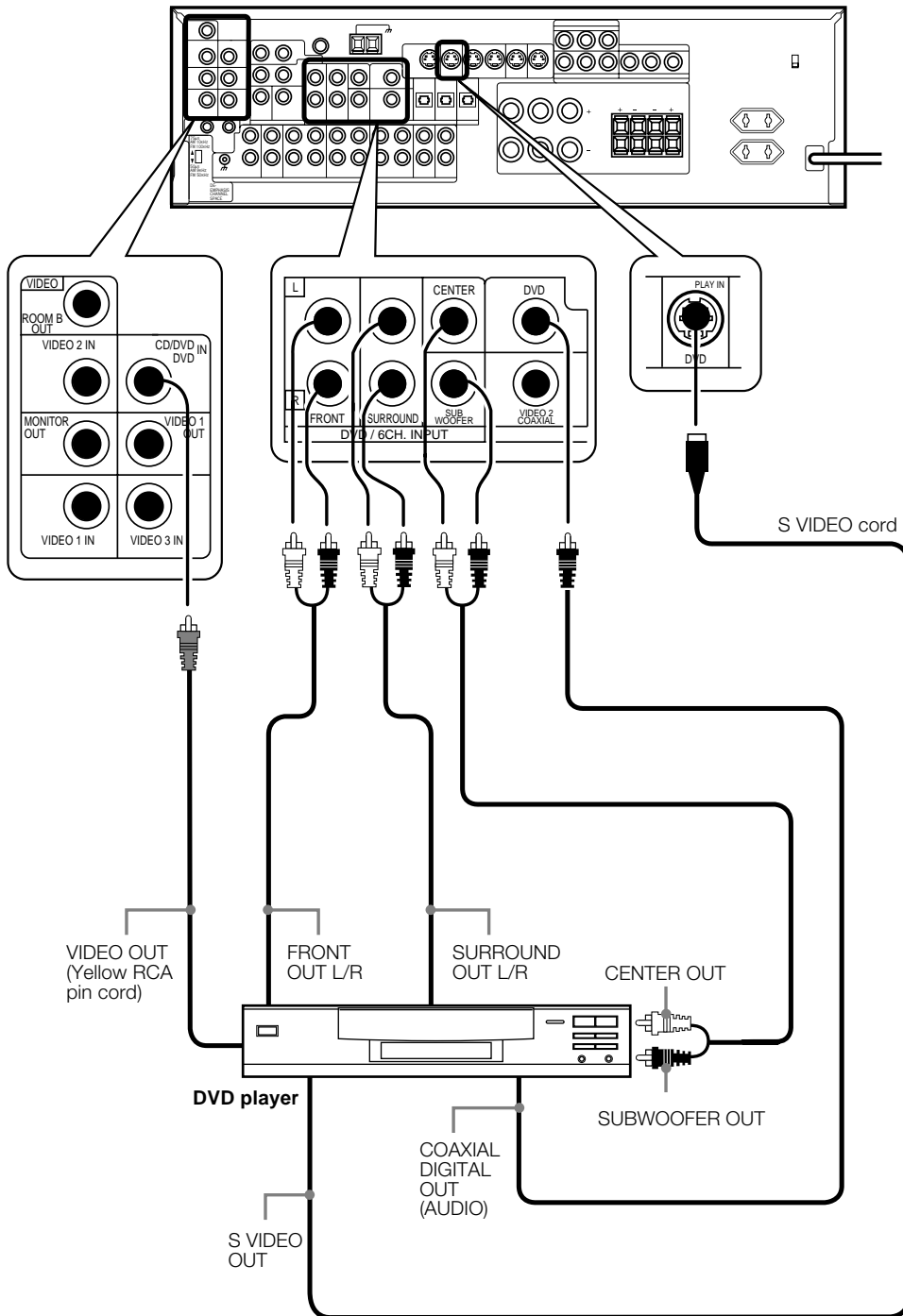

To switch the speakers off , turn SPEAKERS A and B OFF or press MUTE key on the remote control unit.

Connecting the speakers

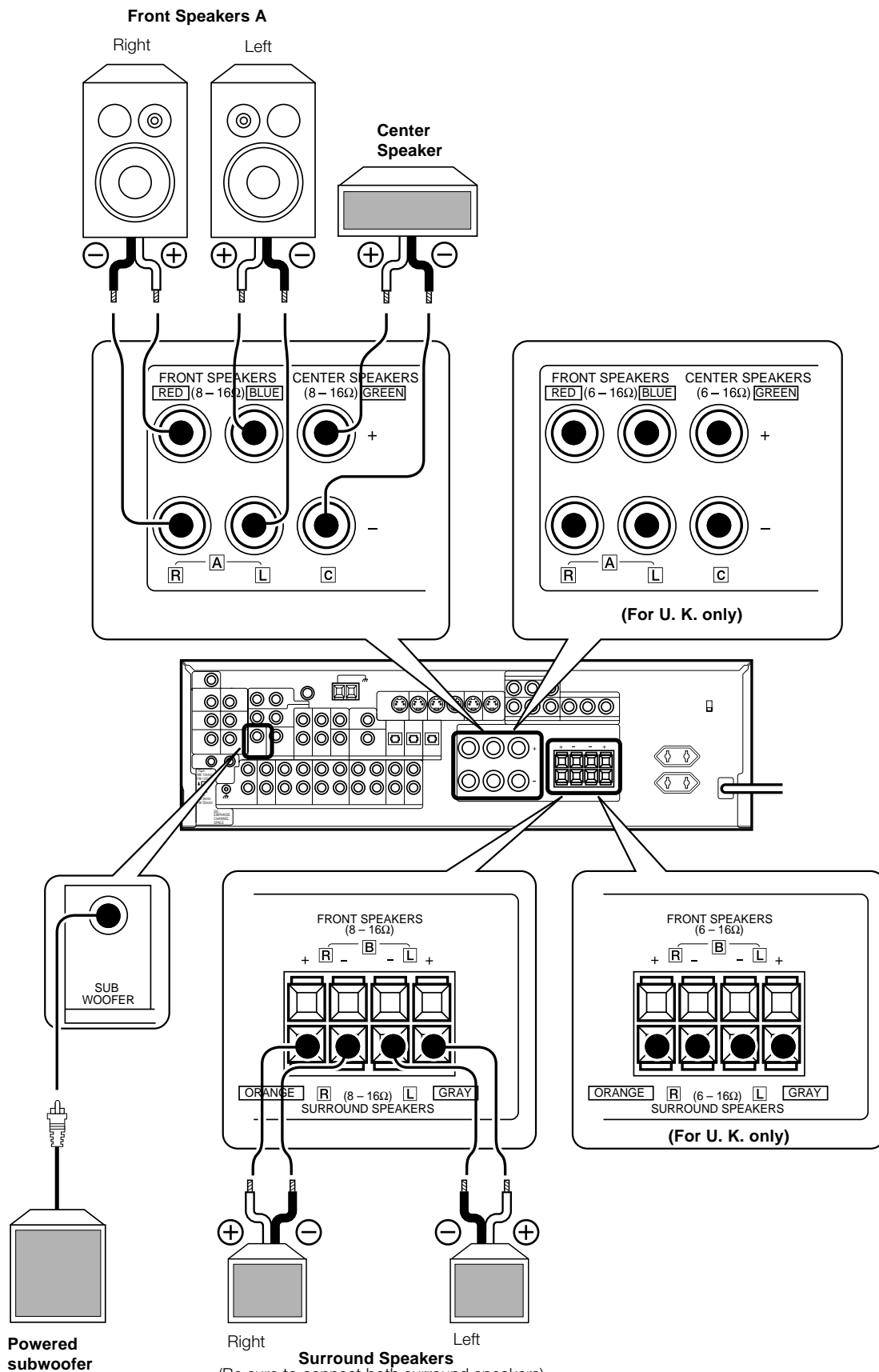

Use the FRONT SPEAKERS B terminals if you want to connect a second front speaker system.

Connecting the terminals

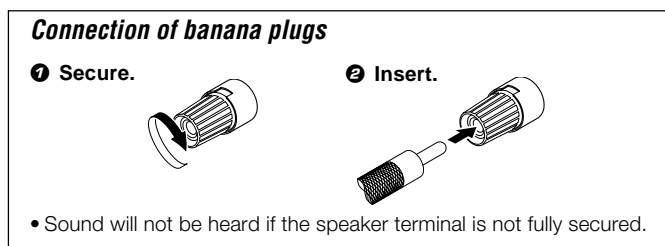
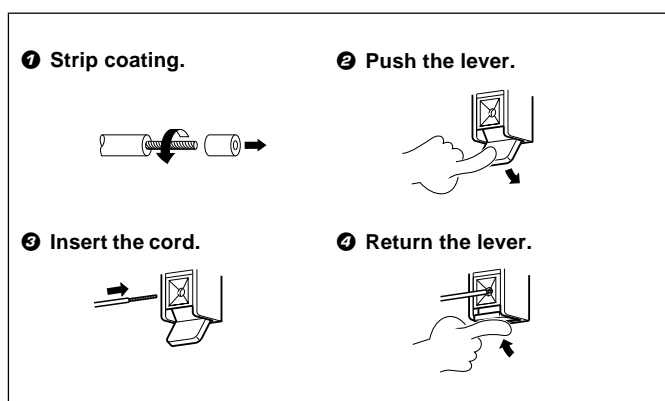
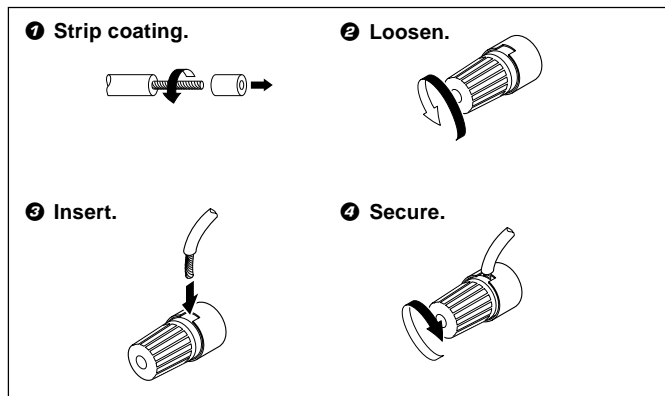

- Never short circuit the + and – speaker cords.
- If the left and right speakers are connected inversely or the speaker cords are connected with reversed polarity, the sound will be unnatural with ambiguous acoustic imaging. Be sure to connect the speakers correctly.

Speaker impedance

After confirming the speaker impedance indications printed on the rear panel of the receiver, connect speakers with matching impedance ratings. Using speakers with a rated impedance other than that indicated on the rear panel of the receiver could result in malfunctions or damage to the speakers or receiver.

Speaker placement

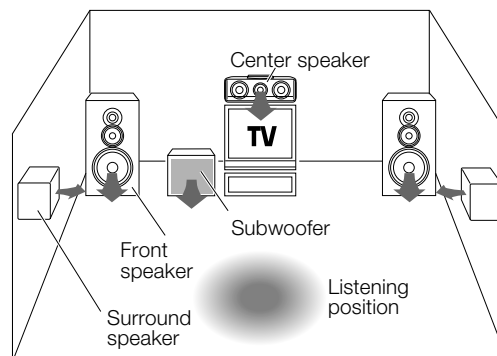

Front speakers : Place to the front left and right of the listening position. Front speakers are required for all surround modes.

Center speaker : Place front and center. This speaker stabilizes the sound image and helps recreate sound motion. Be sure to connect a center speaker when using the Dolby 3 Stereo mode.

Surround speakers : Place to the direct left and right, or slightly behind, the listening position at even heights, approximately 1 meter above the ears of the listeners. These speakers recreate sound motion and atmosphere. Required for surround playback.

Subwoofer : Reproduces powerful deep bass sounds.

- Although the ideal surround system consists of all the speakers listed above, if you don't have a center speaker or a subwoofer, you can divide those signals between the available speakers in the speaker settings steps to obtain the best possible surround reproduction from the speakers you have available.

Connecting to another room or area (ROOM B)

This connection allows you to connect your main system to a monitor TV and speaker system located in another room or area (ROOM B).

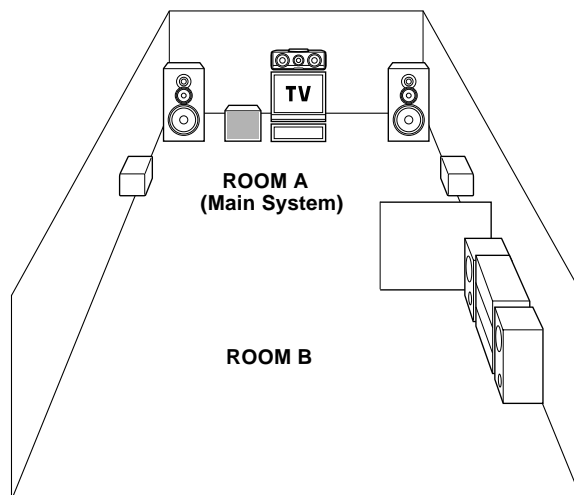
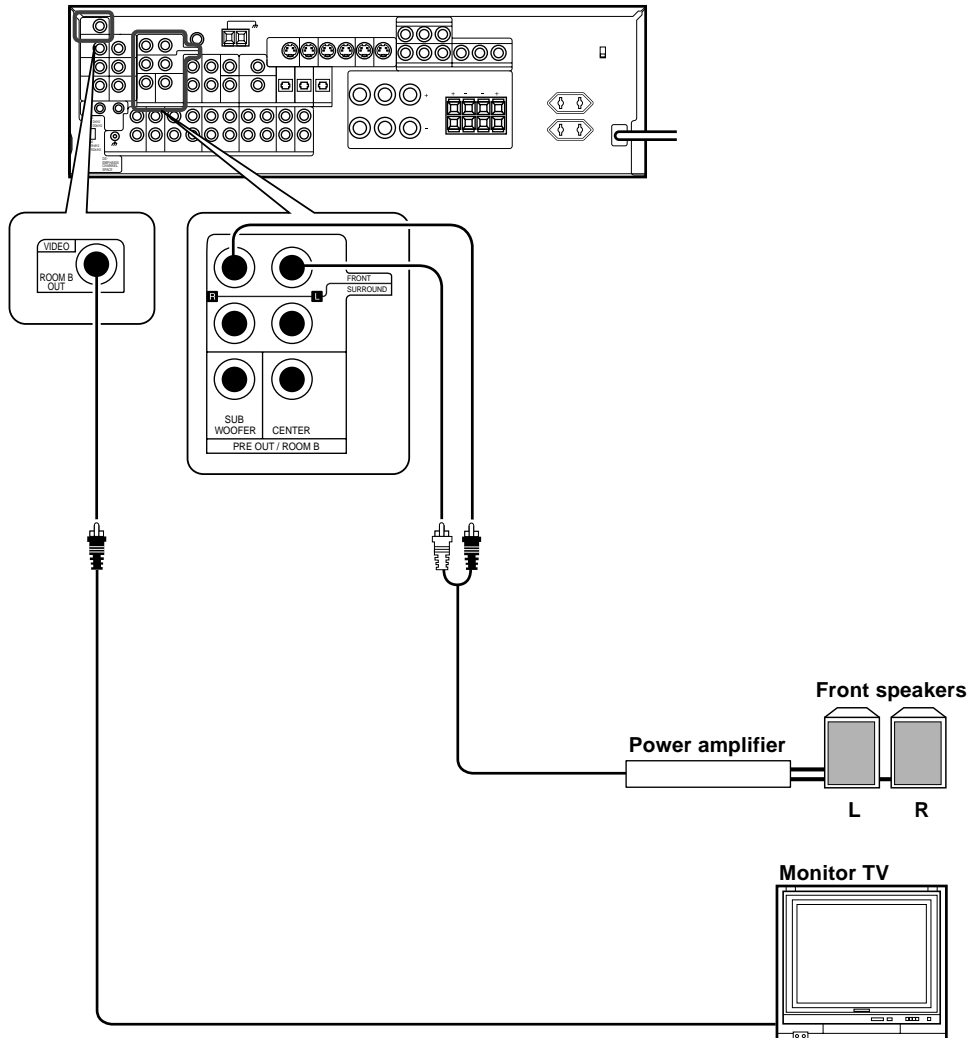

PRE OUT connections

This receiver has additional preout jacks. These can be used for various purposes, but will need to be connected to an external power amplifier as shown in the example below.

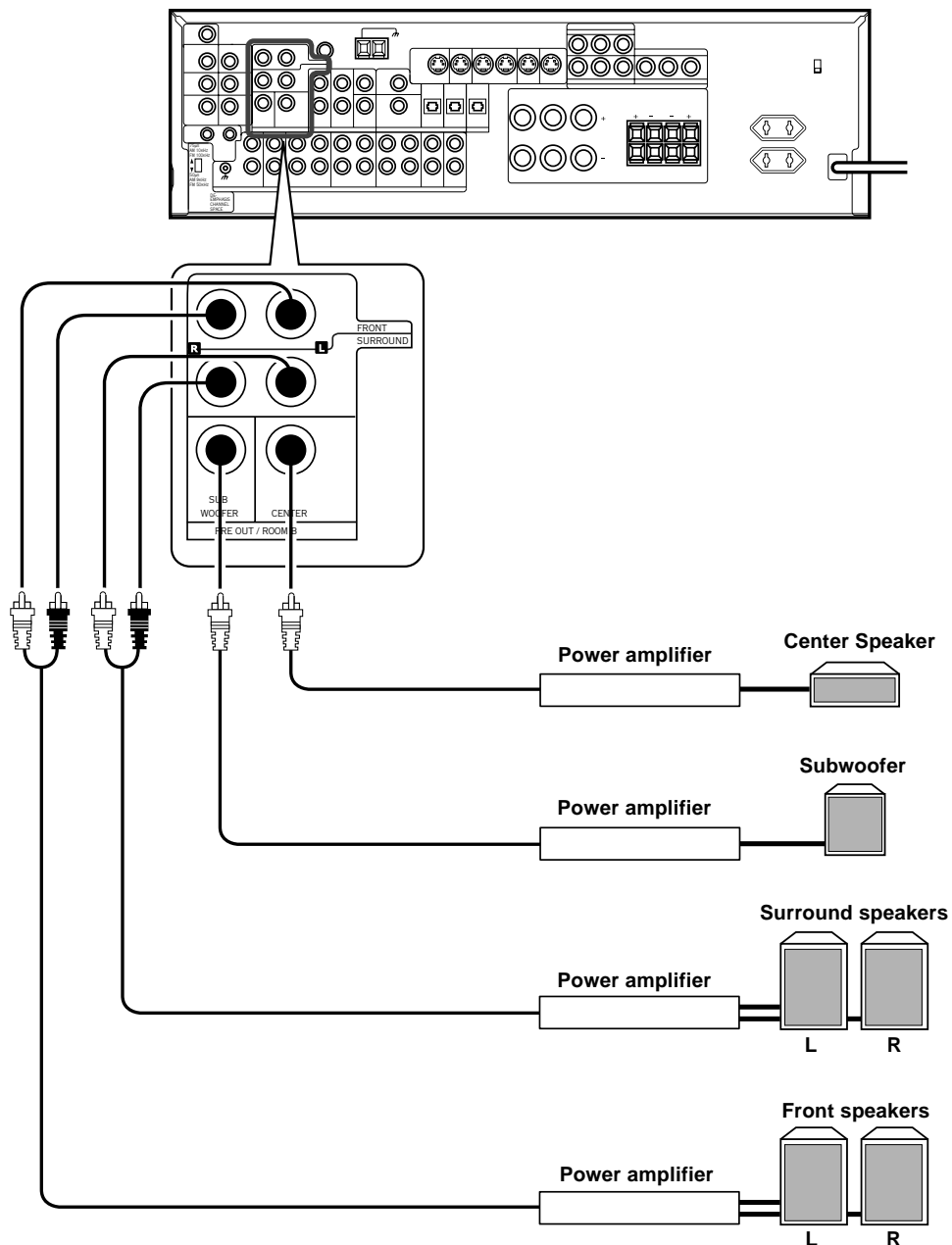

- Connecting a speaker cord directly to a **PRE OUT** jack will not produce any sound from the speaker.
- To use the **PRE OUT** jacks, press only the **SPEAKERS A** key to the ON position.
- This connection is available for listening in ROOM B.

Connecting to the AV AUX jacks

The **AV AUX** jacks are convenient for connection of video components such as a camcorder or a video game.

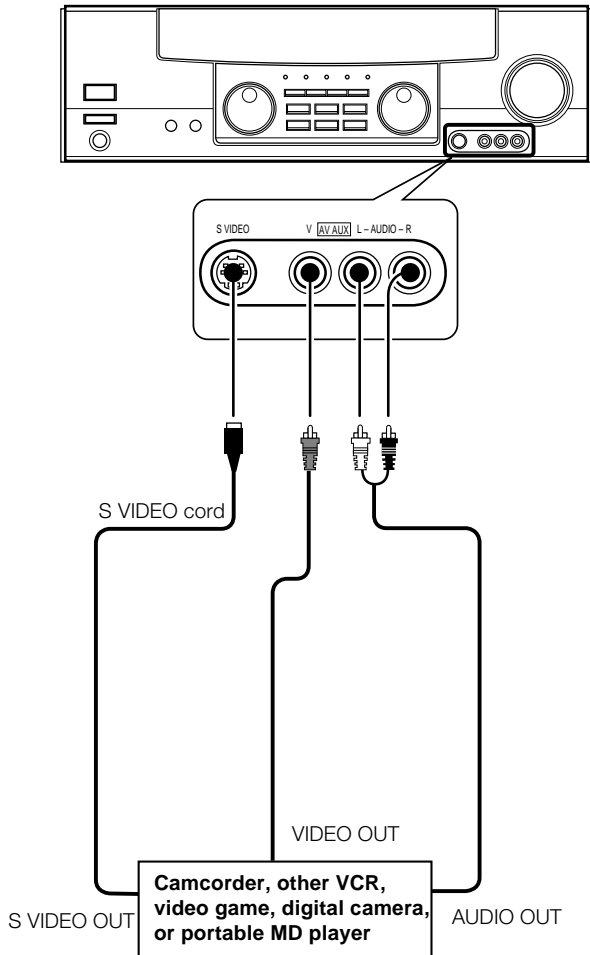

Connecting the antennas

AM loop antenna

The supplied loop antenna is for use indoors. Place it as far as possible from the receiver, TV set, speaker cords and power cord, and adjust the direction for best reception.

AM antenna terminal connections

- 1 Push lever.
- 2 Insert cord.
- 3 Release lever.

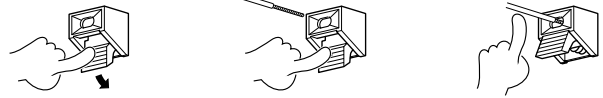

FM indoor antenna

The supplied indoor antenna is for temporary use only. For stable signal reception we recommend using an outdoor antenna. Disconnect the indoor antenna when you connect one outdoors.

FM antenna terminal connections

Insert cord.



FM outdoor antenna

Lead the 75Ω coaxial cable connected to the FM outdoor antenna into the room and connect it to the **FM 75Ω** terminal.

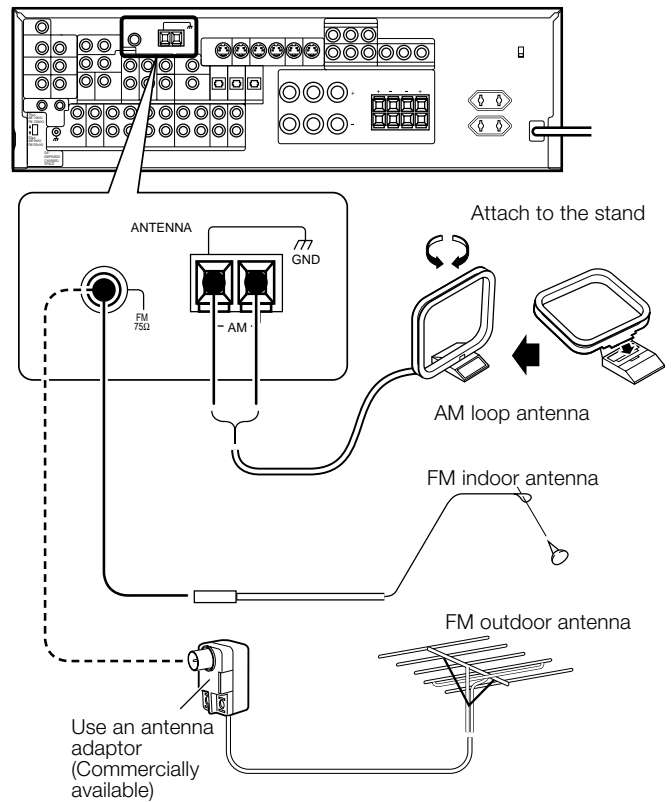

- To select the source connected to the AV AUX jacks, select AV AUX by using the INPUT SELECTOR knob. — 23
- When you connect the audio source such as the MD player, you do not need to connect the video cable.
- When you connect the unit and the component with the S VIDEO cord, you can get better picture quality.

Connecting the system control

Connecting system control cords after connecting a KENWOOD audio component system lets you take advantage of convenient system control operations.

This unit is compatible only with the [SL16] mode. The system control operation is not available if the unit is connected in the [XS8], [XS], or [XR] connection mode.

If your component has the mode select switch, set the connected components to the [SL16] mode.

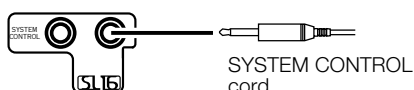

- You may connect the system control cord to either the left or right jack.

EXAMPLE: [SL16] mode connections

The underlined portion represents the setting of the system control mode.

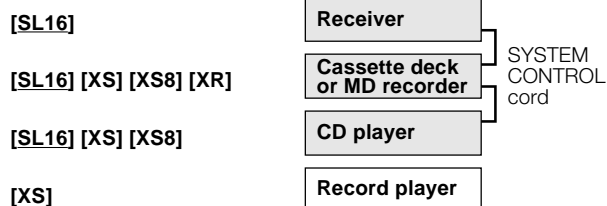

- In order to take advantage of the system control operations, the components must be connected to the correct jacks. To use a CD player it must be connected to the CD jacks. To use a cassette deck (or MD recorder) it must be connected to the MD/TAPE jacks. When using more than one CD player (etc.) only the one connected to the specified jacks may be connected for system control.
- Some CD players and cassette decks are not compatible with the [SL16] system control mode. Do not make system connections with equipment that is not [SL16] compatible.
- Some MD players are not system control compatible. You cannot make system control connections to this kind of equipment.

Notes

- [SL16] equipment cannot be combined with [XR], [XS], and [XS8] equipment for system operations. If your equipment consists of this kind of combination, please do not connect any system control cords. Even without system control cords, normal operations can be carried out without effecting performance.
- Do not connect system control cords to any components other than those specified by KENWOOD. It may cause a malfunction and damage your equipment.
- Be sure the system control plugs are inserted all the way in to the system control terminals.

Do not connect a system control cord to a cassette deck connected to the MONITOR jacks.

SYSTEM CONTROL OPERATIONS

Remote Control

Lets you operate this unit with the system remote supplied with the receiver.

Automatic Operation

When you start playback from a source component, the input selector on this unit switches to that component automatically.

Synchronized Recording

Lets you synchronize recording with the start of playback when recording from CD, MD or analog discs.

Registering setup codes for KENWOOD audio components

- If you own remote controllable KENWOOD audio components that are not compatible with system control, registering the setup code enables you to control those components using the remote control supplied with this unit (without connecting system control cords). To register setup codes for your remote controllable KENWOOD audio components, see "Registering setup codes for other components".

→ 35

Channel space switching
(Except for the USA, Canada, UK, Europe, and Australia)

The space between radio channels has been set to the one that prevails in the area to which the system is shipped. However, if the current channel space setting does not match the setting in the area where the system is to be used, for instance when you move from area 1 or area 2 shown in the following table or vice versa, proper reception of AM/FM broadcasts cannot be expected. In this case, change the channel space setting in accordance with your area by referring to the following table.

Area	CHANNEL Space Frequency
1 USA, Canada and South American countries	FM: 100 kHz AM: 10 kHz
2 Other countries	FM: 50 kHz AM: 9 kHz

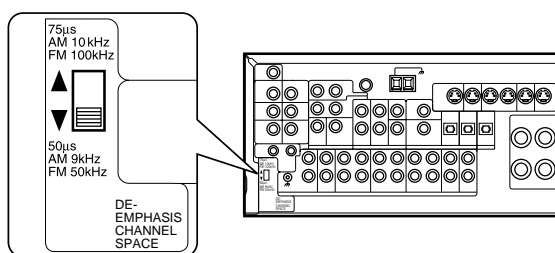

Move switch lever to match your area with a small screwdriver or other pointed tool.

Preparing the remote control

Loading the batteries

- ❶ Remove the cover.
- ❷ Insert the batteries.

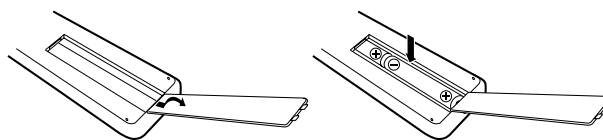

- ❸ Close the cover.

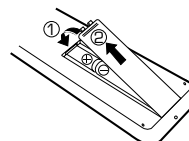

• Insert two AA-size (R6) batteries as indicated by the polarity markings.

Operation

When the **STANDBY** indicator is lit, the power turns ON when you press the **POWER** key on the remote control. When the power comes ON, press the key you want to operate.

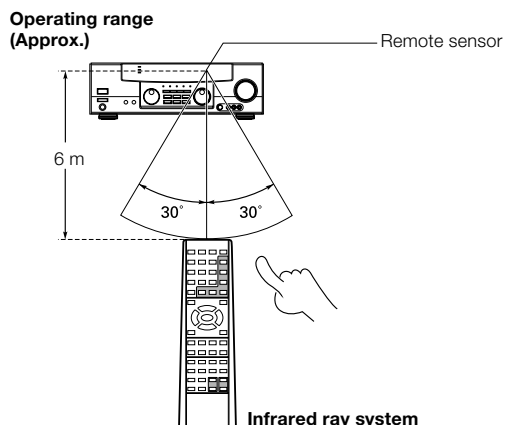

- When pressing more than one remote control key successively, press the keys securely by leaving an interval of 1 second or more between keys.

Notes

1. The supplied batteries may have shorter lives than ordinary batteries due to use during operation checks.
2. When the remote-controllable distance gets shorter than before, replace both batteries with new ones.
3. Placing the remote sensor in direct sunlight, or in direct light from a high frequency fluorescent lamp may cause a malfunction. In such a case, change the location of the system installation to prevent malfunction.

Preparing for surround sound

Speaker settings

To enable you to obtain optimum enjoyment from the receiver's listening modes, make sure to complete the speaker settings (subwoofer, front, center, and surround speakers) as described below.

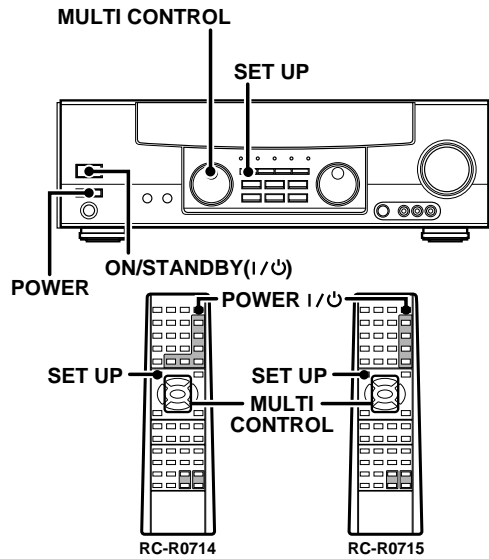

1 Turn on the power to this receiver by pressing **POWER** and **ON/STANDBY (I/O)** or **POWER (I/O)** keys.

2 Select a speaker system.

1 Press the **SET UP** key such that the subwoofer setting indication "SUBWOOFER" scrolls across the display.

"SUBWOOFER" will be scrolled from right to left



2 Use the **MULTI CONTROL** knob or keys to select the appropriate subwoofer setting.

- **1 ON** : Subwoofer setting mode to the receiver is ON.
- **2 OFF** : Subwoofer setting mode to the receiver is OFF.

- The initial setting is "SUBWOOFER ON".
- When "SUBWOOFER OFF" is selected, the front speakers are automatically set to "LRG" and the procedure skips to step **5**.
- When subwoofer output sound is required, select "FRONT NML".

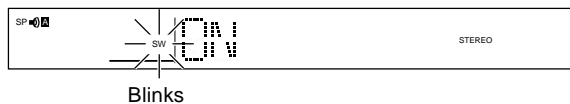

3 Press the **SET UP** key to accept the setting.

- The front speakers setting indication "FRONT" scrolls across the display.

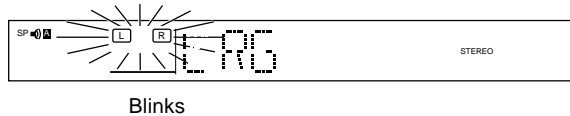

4 Use the **MULTI CONTROL** knob or keys to select the appropriate front speakers setting.

- **1 NML/THX (normal)** : Average size front speakers are connected to the receiver.
- **2 LRG (large)** : Large front speakers are connected to the receiver.

- Under certain circumstances, for "FRONT LRG" selection, no sound will be heard from the subwoofer even when it is set to ON. However, if you select SW RE-MIX ON when subwoofer is selected, you may hear sound from the subwoofer.

5 Press the **SET UP** key to accept the setting.

- The center speaker setting indication "CENTER" scrolls across the display.

6 Use the **MULTI CONTROL** knob or keys to select the appropriate center speaker setting.

If you selected "LRG" as the front speakers setting,

- **1 NML/THX (normal)** : An average size center speaker is connected to the receiver.
- **2 LRG (large)** : A large center speaker is connected to the receiver.
- **3 OFF** : Center speaker setting mode to the receiver is OFF.

If you have selected "NML" as the front speakers setting,

- **1 NML/THX** : Center speaker setting mode to the receiver is ON.
- **2 OFF** : Center speaker setting mode to the receiver is OFF.

7 Press the **SET UP** key to accept the setting.

- The surround speaker setting indication "SURROUND" scrolls across the display.

8 Use the **MULTI CONTROL** knob or keys to select the appropriate surround speaker setting,

If you have selected "LRG" as the center speaker setting,

- **1 NML/THX (normal)** : Average size surround speakers are connected to the receiver.
- **2 LRG (large)** : Large surround speakers are connected to the receiver.
- **3 OFF** : Surround speaker setting mode to the receiver is OFF.

If you have selected other than "LRG" as the center speaker setting,

- **1 NML/THX** : Surround speaker setting mode to the receiver is ON.
- **2 OFF** : Surround speaker setting mode to the receiver is OFF.

9 Press the **SET UP** key to accept the setting.

- The subwoofer remix setting indication "SW RE-MIX" scrolls across the display.

3 Select the subwoofer re-mix setting.

1 Use the **MULTI CONTROL** knob or keys to select the appropriate subwoofer re-mix setting.

- **1 ON** : Subwoofer re-mix set mode to the receiver is ON.
- **2 OFF** : Subwoofer re-mix set mode to the receiver is OFF. This is the THX preferred setting.

"SW RE-MIX" scrolls across the display

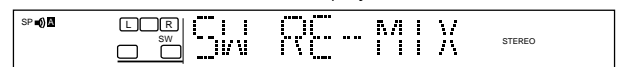

2 Press the **SET UP** key to accept the setting.

- The receiver enters the speaker volume level adjustment mode.
- In step **2**, indications appear only for the selected channels of the speakers that require adjusting.

Continued to next page

4 Adjust the speaker volume.

From your usual listening position, adjust the volume levels. The volume levels from each speaker should be the same.

- 1 Use the **MULTI CONTROL** knob or keys to adjust the volume of the test tone output from the speaker channel to be adjusted.

The channel indication blinks while the test tone is being output.



The test tone is heard from the speakers in the following sequence for 2 seconds each:

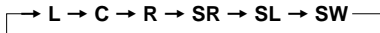

- If you change the volume level settings for the speakers while listening to music, the settings referred to on this page are also changed.
 - If the speaker setting selects are OFF, the speaker level settings are reset.
- 2 Press the **SET UP** key.
- The test tone is turned off. The receiver enters the mode for inputting the bass peak level and the current peak level will be shown.
 - To obtain accurate output levels, it is recommended to use a handheld Sound Pressure Level (SPL) meter. Readings should be taken from your actual listening position and adjust the level of each speaker to 75dB SPL (C-weighted/slow meter mode).

5 Adjust the bass peak level.

A restriction is put on the low frequency so that the bass peak level will not go higher than the acceptable level when the volume is increased. If subwoofer speaker is OFF, the limitation will affect the low frequency of the front left and right speakers.



- 1 Use the **MULTI CONTROL** knob or keys to adjust the bass peak level to -30.
- The bass peak level may be adjusted from -30dB to 0dB and OFF.
- When no subwoofer is in use, the test tone will be output from the front channel speakers.

- 2 To find the bass peak level limit, keep increasing the bass peak level by using the **MULTI CONTROL** knob or keys while test tone is being output until the clip point of the subwoofer is found.



- 3 Press the **SET UP** key.
- The receiver enters the mode for inputting the distance to the speakers.

6 Input the distance to the speakers.

- 1 Measure the distance from the listening position to each of the speakers.

Not down the distance to each of the speakers.

- Distance to front left speaker : ___ feet (meters)
- Distance to center speaker : ___ feet (meters)
- Distance to front right speaker : ___ feet (meters)
- Distance to surround right speaker : ___ feet (meters)
- Distance to surround left speaker : ___ feet (meters)
- Distance to subwoofer : ___ feet (meters)

- 2 Use the **MULTI CONTROL** knob or keys to select the distance to the front speakers.

The speaker indicator to be adjusted blinks.



Indication in feet Indication in meters

- The allowable setting range is 1 to 30 feet (0.3 to 9.0 m), adjustable in 1 foot (0.3 m) increment.

- 3 Press the **SET UP** key.

- 4 Repeat steps 2 and 3 to input the distance for each of the speakers.

- 5 Setup is complete when the input indication reappears.

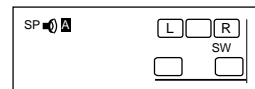

Display when all speakers have been selected.

- The speakers you have selected should appear on the display. Confirm that all the speakers have been correctly selected.

Input level adjustment (analog sources only)

If the input level of an analog source signal is too high, the CLIP indicator will blink. Adjust the input level.

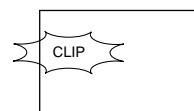

- 1 Use the **INPUT SELECTOR** knob to select the source which you want to adjust.

- You can store a separate input level for each input source. If the MONITOR function is ON, you can store an input level for when MONITOR is on independently of the input levels for the input sources.

- 2 Press the **SOUND** key repeatedly until the "INPUT" indication appears.

- 3 Use the **MULTI CONTROL** knob or keys to adjust the input level.



- The adjustment mode is displayed for approximately eight seconds.
- The input level may be adjusted to any one of three settings: 0dB, -3dB, and -6dB. (The initial setting is 0dB.)

- 4 Press the **SOUND** key again to return to the input indication.

Normal playback

Preparing for playback

Some preparatory steps are needed before starting playback.

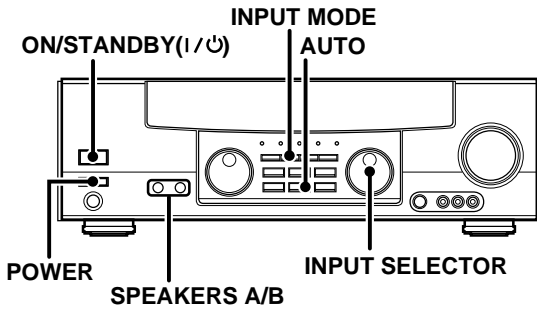

Selecting the input mode

If you have selected a component connected to the **CD/DVD**, **DVD/6ch**, **VIDEO2**, or **VIDEO3** jacks, make sure that the input mode setting is correct for the type of audio signal to be used.

Selecting MD/TAPE

Select the source name corresponding to the component connected to the MD/TAPE jacks. The initial factory setting is "TAPE". To change the source to "MD", follow the steps below:

- 1 Use the **INPUT SELECTOR** knob to select "MD/TAPE".
- 2 Hold down the **AUTO** key for more than 2 seconds.
 - The source indication changes to "MD".
 - To return to the original indication, repeat procedure 2.

Selecting the speaker system

Press the **SPEAKERS A** or **B** key to select the speaker system to be used.

- A ON** : Sound from the speakers connected to the **SPEAKERS A** terminals on the rear panel.
- B ON** : Sound from the speakers connected to the **SPEAKERS B** terminals on the rear panel. No sound will be heard from subwoofer.
- A+B ON** : Sound from both the speakers connected to the **SPEAKERS A** and **B** terminals on the rear panel.
- A+B OFF** : No sound from the speakers. Use this setting when listening with headphones for stereo sound in all playback modes.

The indicator for the speakers you want to use should be lit.

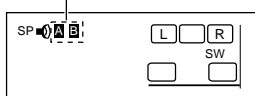

- Selecting "6ch INPT" by pressing the **INPUT MODE** key, whereby "DVD/6ch" is the input source will cause **SPEAKERS A** to be selected automatically.
- When you use the **PRE OUT** jacks, set only **SPEAKERS A** to ON mode.

Turning on the receiver

- 1 Turn on the power to the related components.
- 2 Turn on the power to this receiver by pressing **POWER** and **ON/STANDBY(I/⏻)** keys.

Listening to a source component

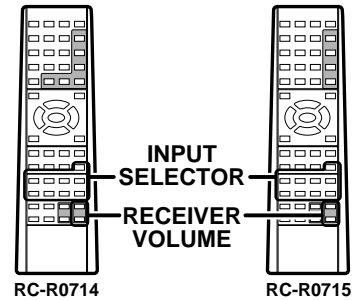
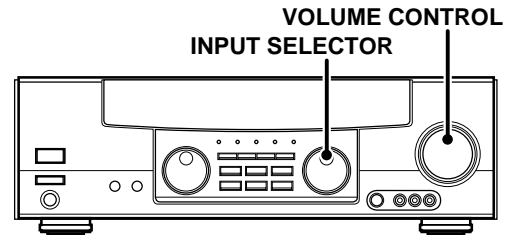

- 1 Use the **INPUT SELECTOR** knob or keys to select the source you want to listen to.

The input sources change as shown below:

Selecting a source using the **INPUT SELECTOR** knob

- 1 "PHONO"
- 2 "TUNER"
- 3 "CD/DVD"
- 4 "TAPE" or "MD"
- 5 "VIDEO1"
- 6 "VIDEO2"
- 7 "VIDEO3"
- 8 "DVD/6ch"
- 9 "AV AUX"

- 2 Start playback from the selected source.

- 3 Use the **VOLUME CONTROL** knob or **RECEIVER VOLUME** keys to adjust the volume.

Adjusting the sound

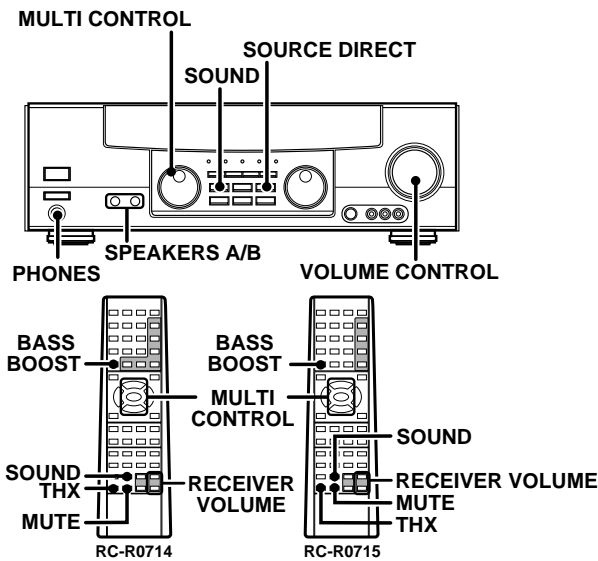

Adjusting the tone

You can adjust the sound quality when the receiver is in the PCM stereo and analog stereo mode.

- 1 Press the **SOUND** key repeatedly to select the tone mode to be adjusted.

BASS: Select this to adjust the low frequency range.
(Press the **SOUND** key once.)

TREB: Select this to adjust the high frequency range.
(Press the **SOUND** key twice.)



- 2 Use the **MULTI CONTROL** knob or keys to adjust the sound quality.

- The bass and treble levels are adjustable from -10dB to +10dB in 2 step increments.
- The adjustment item is displayed for approximately 8 seconds.
- BASS and TREB adjustment modes are not effective when THX is ON.

Once-touch low frequency emphasis (bass boost) (Remote control only)

You can adjust the sound quality when the receiver is in the PCM stereo and analog stereo modes.

- Press the key once to select the maximum (+10dB) low frequency emphasis setting.
- This key does not function when the receiver is in the sound quality or ambience effects adjustment mode.

Switching back to the previous setting

Press the **BASS BOOST** key again.

- BASS BOOST key is not effective when THX is ON.

THX mode (Remote control only)

You may use the **THX** key to switch ON or OFF the THX mode. The initial factory setting for CD/DVD and DVD/6ch selectors is THX ON.

Each press switches the mode as follows:

- ▶ 1 "THX ON"
- ▶ 2 "THX OFF"



- When THX is ON, "THX" indicator lights up.

Muting the sound

The **MUTE** key lets you mute the sound of the speakers.

Press the **MUTE** key.

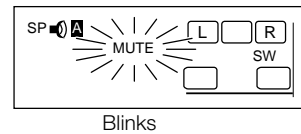

Blinks

To cancel

Press the **MUTE** key again so that the "MUTE" indicator goes off.

- MUTE ON can also be deactivated by turning the volume control knob.

SOURCE DIRECT playback (for analog sources only)

Use this function to pass the source material direct to the amplifier, bypassing any audio processing.

Press the **SOURCE DIRECT** key.

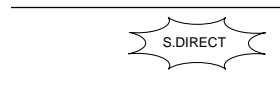

- When you press the **LISTEN MODE**, **SOUND**, or **SET UP** keys, or switch to another input source, SOURCE DIRECT playback will be canceled.

To cancel

Press the **SOURCE DIRECT** key again.

- If SOURCE DIRECT playback was activated when using a surround mode, canceling SOURCE DIRECT playback will reactivate the previous surround mode.

Listening with headphones

- 1 Press the **SPEAKERS A and B** key so that the speaker indicator goes off.

Make sure the **SPEAKERS** indicators are turned off.

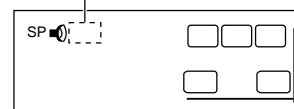

- If you turn off all of the speakers when in surround mode, the surround mode will be canceled as well, resulting in stereo playback.

- 2 Connect the headphones to the **PHONES** jack.

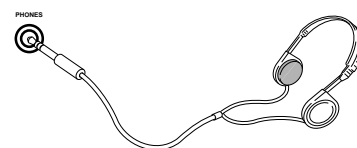

- 3 Use the **VOLUME CONTROL** knob (**RECEIVER VOLUME** keys) to adjust the volume.

Recording audio (analog sources)

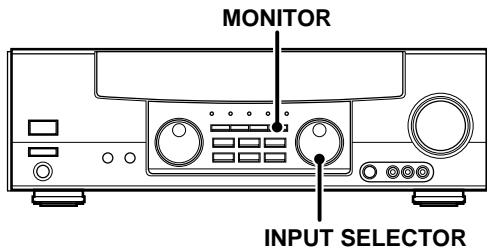

Recording a music source

- 1 Use the **INPUT SELECTOR** knob to select the source (other than "TAPE") you want to record.
- 2 Set the cassette deck or MD recorder to record.
- 3 Start playback, then start recording.

Recording tapes or MD (with MONITOR function)

MONITOR → MD/TAPE recording

- 1 Press the **MONITOR** key. 
- 2 Use the **INPUT SELECTOR** knob to select a source other than "MD/TAPE".
- 3 Start playback on the cassette deck connected to the **MONITOR** jacks and start recording on the cassette deck or MD recorder connected to the MD/TAPE jacks.

MD/TAPE → MONITOR recording

- 1 Use the **INPUT SELECTOR** knob to select "MD/TAPE".
- 2 Start playback on the cassette deck connected to the MD/TAPE jacks and start recording on the cassette deck connected to the **MONITOR** jacks.
 - To copy tapes using a double cassette deck, refer to the instruction manual of the double cassette deck.

MONITOR function (analog sources only)

You can connect a cassette deck or graphic equalizer to the **MONITOR** jacks of the receiver. If a graphic equalizer is connected, the **MONITOR** key should be left in the on position. Alternately, if a cassette deck equipped with a 3-head system is connected to the **MONITOR** jacks, you will be able to monitor the just-recorded signal while making recordings on the cassette deck. By switching the **MONITOR** key on and off, you can compare the sound of the source signal and the just-recorded signal. For more information, refer to the instruction manual of the connected component.

Recording video

- 1 Use the **INPUT SELECTOR** to select the video source (other than "VIDEO1") you want to record.
- 2 Set the video deck connected to **VIDEO 1** to record.
 - Select the REC MODE to record a digital input source.
- 3 Start playback, then start recording.
 - Recording may not be normal for some video software. This is due to the copy guard condition.

Recording audio (digital sources)

Switch on the **REC** mode to record a digital input source. Usually use the **A-REC (Auto-Record)** mode to record audio input sources. When the digital mode changes during recording in the **A-REC** mode, the audio may be interrupted momentarily.

Recording music in A-REC or M-REC mode

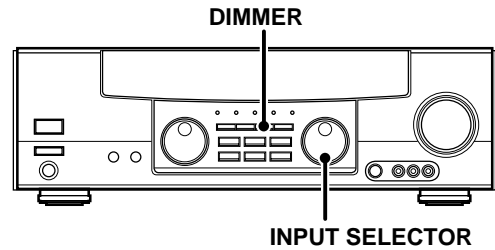

- 1 Use the **INPUT SELECTOR** knob to select the source (CD/DVD, DVD/6ch, VIDEO2, or VIDEO3) you want to record.
- 2 Set the cassette deck or MD recorder to record.
- 3 Press and hold the **DIMMER** key for more than 2 seconds to select the **A-REC** (or **M-REC**) mode.
 - The mode changes every 2 seconds as shown below.

- | | |
|--|---|
| <ol style="list-style-type: none"> 1 Rec mode off : 2 A-REC : 3 M-REC : | <p>The digital input record mode is switched off.</p> <p>The digital input signals (DTS, Dolby Digital, or PCM) are identified automatically and converted into stereo signals that are ready for recording.</p> <p>The input signal type at the moment this mode is selected is held throughout this mode.</p> |
|--|---|

For A-REC mode:

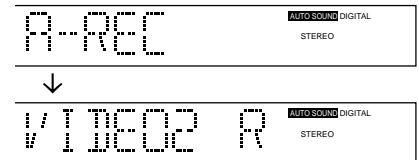

For M-REC mode:

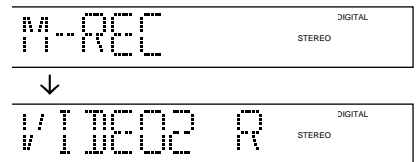

- 4 Play the source from the beginning and start recording.
 - If the audio reproduction stops in the middle due to change in the input signals, etc., press the **DIMMER** key.

Listening to radio broadcasts

The receiver can store up to 40 stations in the memory and recall them by one-touch operation. Radio stations can be classified into RDS (Radio Data System) stations and other stations. To listen to or store RDS stations in the preset memory see "Using RDS (Radio Data System)". (For U.K. only)

Tuning radio stations

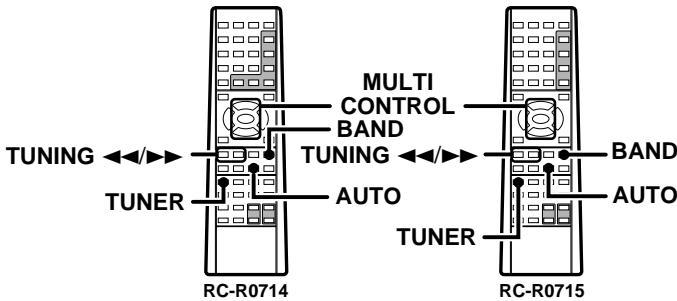
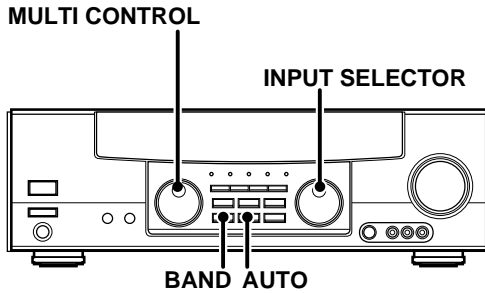

1 Use the **INPUT SELECTOR knob (TUNER key)** to select the tuner.

2 Use the **BAND key** to select the desired broadcast band.

Each press switches the band as follows:

- ① FM
- ② AM

"AM" or "FM" indicator appears in the display.

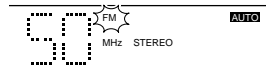

3 Use the **AUTO key** to select the desired tuning method.

Each press switches the tuning method as follows:

- ① **AUTO lit** (auto tuning)
- ② **AUTO not lit** (manual tuning)

"AUTO" indicator lights up in the display.



- Normally, set to "AUTO" (auto tuning). If the radio waves are weak and there is a lot of interference, switch to manual tuning. (With manual tuning, stereo broadcasts will be received in monaural.)

4 Use the **MULTI CONTROL knob or TUNING <</> keys** to select the station.

Frequency display "ST." lights up when a broadcast is being received in stereo.

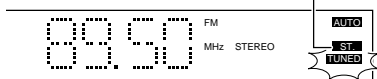

"TUNED" is displayed when a station is received.

Auto tuning : The next station is tuned automatically.

Manual tuning : Turn the knob (or press the keys) to select the desired station.

Presetting radio stations manually

The RDS auto memory function assigns preset numbers to RDS stations starting from preset number "1". Therefore, be sure to execute the RDS auto memory function before using the following operations to manually store AM stations and other FM stations, and RDS stations. See "Presetting RDS stations (RDS AUTO MEMORY)". (For U.K. only)

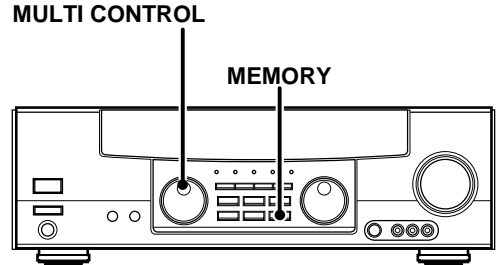

1 Tune to the station you want to store.

2 Press the **MEMORY key** while receiving the station.

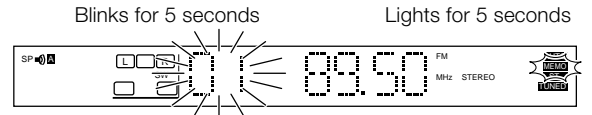

Proceed to step **3** within 5 seconds. (If more than 5 seconds elapse, press the MEMORY key again).

3 Use the **MULTI CONTROL knob or keys** to select one of the station presets (1 - 40).

4 Press the **MEMORY key** again to accept the setting.

- Repeat steps **1**, **2**, **3**, and **4** to store as many stations as necessary.
- If you store a station at a previously used preset, the old station will be replaced by the new one.

Receiving preset stations

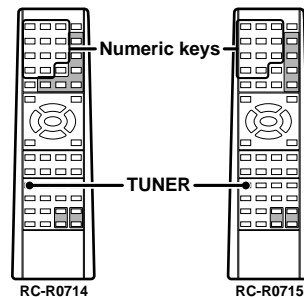

1 Use the **TUNER key** to select the tuner as the source.

2 Enter the number of the preset you want to receive (up to "40").

Press the numeric keys in the following order:

For "15", press **+10**, **5**
 For "20", press **+10**, **+10**, **0**

- If you make a mistake entering a two digit number, press the **+10** key repeatedly to return to the original display and start again.



Receiving preset stations in order (P.CALL)

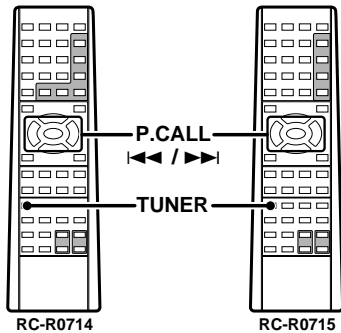

- 1 Use the **TUNER** key to select the tuner as the source.
- 2 Use the **P.CALL** \lll / \ggg keys to select the desired station.
 - Each time you press the key, another preset station is received in order.

Pressing the \ggg key does the following:

→ 01→02→03→ ... → ... 38→39→40

Pressing the \lll key does the following:

01←02←03← ... ← ... 38←39←40←

Holding down the \ggg or \lll key lets you skip through the presets, receiving each preset station at 0.5 second intervals.

(For U.K. only) Using RDS (Radio Data System)

RDS is a system that transmits useful information (in the form of digital data) for FM broadcasts along with the broadcast signal. Tuners and receivers designed for RDS reception can extract the information from the broadcast signal for use with various functions, such as automatic display of the station name.

RDS functions:

PTY (Program Type Identification) Search → 28
Automatically tunes to a station that is currently broadcasting the specified program type (genre).

PS (Program Service Name) Display
Automatically displays the station name transmitted by the RDS station.

RDS AUTO MEMORY function → 28
Automatically selects and stores up to 40 RDS stations in the preset memory. If fewer than 40 RDS stations have been stored in the preset memory, regular FM stations will be stored in the remaining places.

Radio Text function
Displays the radio text data transmitted by some RDS stations when you press the **RDS DISP.** (Display) key. There is "NO RT" if no text data is transmitted.

The "RDS" indicator lights up when an RDS broadcast (signal) is received.

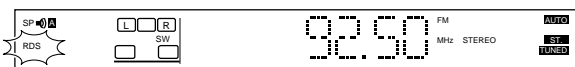

Note
Some functions and function names may differ for certain countries and areas.

Before using a function utilizing the RDS, be sure to perform the RDS Auto Memory operation by referring to the description in "Presetting RDS stations (RDS AUTO MEMORY)". → 28

(For U.K. only) Using the RDS DISP. (Display) key

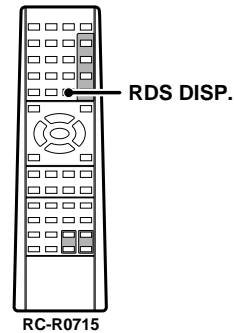

Pressing the **RDS DISP.** key changes the contents of the display.

Each press switches the display mode as follows:

- 1 **PS** (Program Service name) display
- 2 **RT** (Radio Text) display
- 3 **Frequency** display

1 PS (Program Service name) display:

The station name is displayed automatically when an RDS broadcast is received, If no PS data was sent, "NO PS" is displayed.

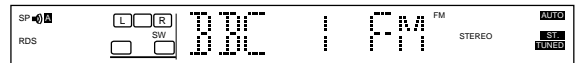

2 RT (Radio Text) display:

Text data accompanying the RDS broadcast scrolls across the display. "NO RT" or "RT----" is displayed if the current RDS station does not provide RT data.



3 Frequency display:

Displays the frequency of the current station.

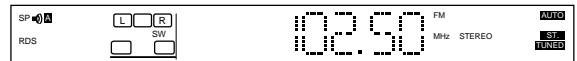

(For U.K. only)
Presetting RDS stations (RDS AUTO MEMORY)

This function automatically stores up to 40 RDS stations in the preset memory. In order to use the PTY function, the RDS stations must be stored in the preset memory using the RDS AUTO MEMORY function.

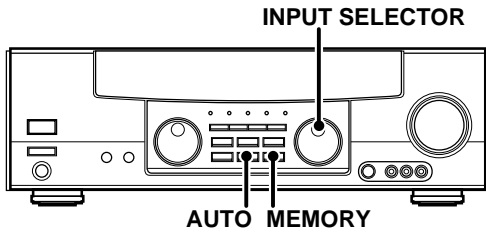

- 1** Use the **INPUT SELECTOR** knob to select the tuner.
- 2** Use the **BAND** key to set the broadcast band to "FM".
- 3** Press and hold the **MEMORY** key for more than 2 seconds.

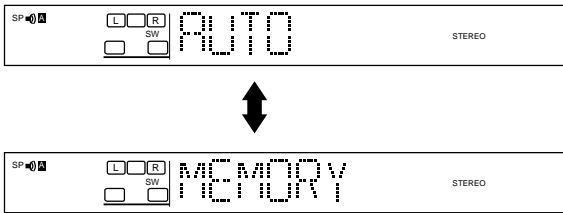

- After a few minutes, up to 40 RDS stations are preset in order from channel "01".
- Stations already stored in the preset memory may be replaced by RDS stations. (i.e., If the RDS AUTO MEMORY function detects 15 RDS stations, the stations currently preset at numbers 01 - 15 will be replaced by the RDS stations.)

(For U.K. only)
Tuning by program type (PTY search)

This function lets you set the tuner to automatically search for stations which are currently broadcasting the type of program (genre) you want to listen to.

Under certain receiving conditions, it may take more than 1 minute to complete the search.

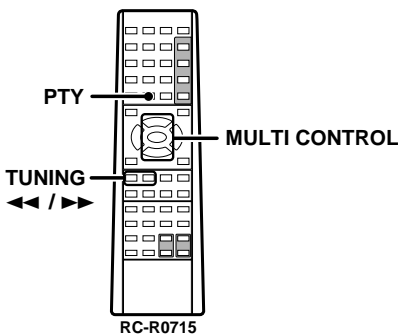

Preparations

- Execute the RDS auto memory procedure.
- Set the broadcast band to FM.
- Tune to an RDS station.

- 1** Press the **PTY** key to activate the PTY search mode.



When an RDS broadcast is received, the program type is shown on the display. If no PTY data is available, or if the station is not an RDS station, "NONE" is displayed.

- 2** While the "PTY" indicator is lit, use the **MULTI CONTROL** or **TUNING** <</> keys to select the program type of your choice.

Program type table

Program Type Name	Display	Program Type Name	Display
News	NEWS	Weather	WEATHER
Current Affairs	AFFAIRS	Finance	FINANCE
Information	INFO	Children's Program	CHILDREN
Sport	SPORT	Social Affairs	SOCIAL
Education	EDUCATE	Religion	RELIGION
Drama	DRAMA	Phone In	PHONE IN
Culture	CULTURE	Travel	TRAVEL
Science	SCIENCE	Leisure	LEISURE
Varied Speech	VARIED	Jazz Music	JAZZ
Pop Music	POP M	Country Music	COUNTRY
Rock Music	ROCK M	National Music	NATION M
Easy Music	EASY M	Oldies Music	OLDIES
Light Classical Music	LIGHT M	Folk Music	FOLK M
Serious Classical Music	CLASSICS	Documentary	DOCUMENT
Other Music	OTHER M		

"NO PROG" is displayed if this operation is attempted before performing the RDS Auto Memory operation.

- 3** Press the **PTY** key to start searching.

EXAMPLE: Searching for a Rock Music broadcast.

Display while searching.

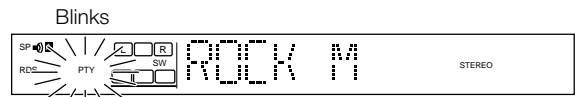

Program type name display

Display when a station is received.

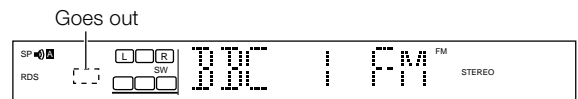

Station name display

- No sound is heard while "PTY" is blinking.
- If the desired program type cannot be found, "NO PROG" is displayed, then after several seconds the display returns to the original display.

To select another program type

Repeat steps **1**, **2** and **3**.

Ambience effects

This receiver is equipped with listening modes that allow you to enjoy an enhanced sonic ambience with a variety of video sources.

In order to obtain the optimum effect from the surround modes, make sure to input the proper speaker settings beforehand.

→ 21

Surround modes

DTS

The DTS multi-channel audio format is available on CD, LD and DVD software. DTS is a strictly digital format and can not be decoded inside most CD, LD or DVD players. For this reason, if you attempt to listen to DTS encoded software through the analog output of your new CD, LD or DVD player, you will experience digital noise in most cases. This noise can be quite loud if the analog output is connected directly to a high power amplification system. Proper measures for playing the digital output as described below should be taken to avoid this situation. To enjoy DTS Digital Surround playback, an external 5.1 channel DTS Digital Surround decoder system or an amplifier with a built-in DTS Digital Surround decoder must be connected to the digital output (S/P DIF, AES/EBU or TosLink) of a CD, LD or DVD player.

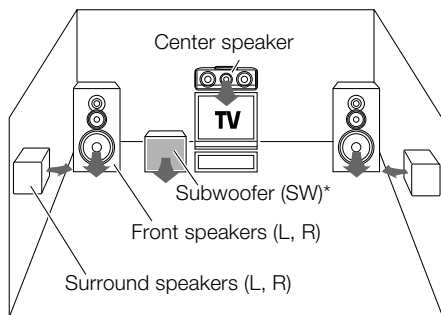

* Optional in this mode.

* LFE = Low Frequency Effects. This channel delivers separate non-directional bass signals to the subwoofer for more dynamic deep bass sound effects.
DTS has a .1 or LFE channel.
The indication "LFE" appears in the display when a signal is being input for this channel.

Manufactured under license from Digital Theater Systems, Inc. US Pat. No. 5,451,942 and other worldwide patents issues and pending.
"DTS" and "DTS Digital Surround" are trademarks of Digital Theater Systems, Inc.
©1996 Digital Theater Systems, Inc. All rights reserved.



Manufactured under license from Dolby Laboratories. "Dolby", "Pro Logic" and the double-D symbol are trademarks of Dolby Laboratories. Confidential Unpublished Works. ©1992-1999 Dolby Laboratories, Inc. All rights reserved.

Circle Surround and the  symbol are trademarks of SRS Labs, Inc. in the United States and selected foreign countries. Circle Surround technology is incorporated under license from SRS Labs, Inc.

Lucasfilm and THX are registered trademarks of Lucasfilm Ltd.

Dolby Digital

The Dolby Digital surround format lets you enjoy up to 5.1 channels of digital surround sound from Dolby Digital program sources (such as Laserdisc or DVD software marked ). Compared with previous Dolby surround, Dolby Digital provides even better sound quality, greater spatial accuracy, and improved dynamic range.

Note

Although a full set of speakers (front left, right, and center, surround left and right, and a subwoofer) is required for true 5.1 channel Dolby Digital surround sound, this receiver lets you enjoy Dolby Digital (and Dolby Surround) program sources, even if you connect only the front speakers.

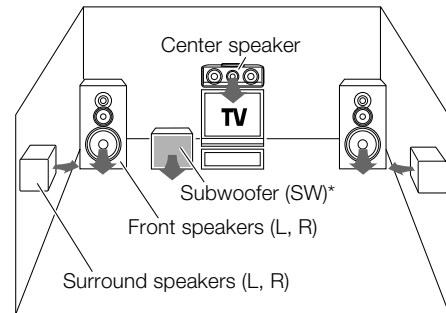

* LFE = Low Frequency Effects. This channel delivers separate non-directional bass signals to the subwoofer for more dynamic deep bass sound effects.

Although only Dolby Digital soundtracks incorporate a separate low frequency channel, connecting a subwoofer will also improve deep bass performance in the other surround modes.

The indication "LFE" appears in the display when a signal is being input for this channel.

Dolby Pro Logic II

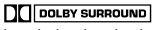
Dolby Pro Logic II was designed specifically to provide a new sense of spatiality, directionality and articulation of sounds from Dolby Surround encoded sources (such as video and Laserdisc software marked ). This is achieved with an intelligent, built-in feedback logic design, a matrix surround decoding and the decoding of stereo, full bandwidth surround outputs. The PRO LOGIC II modes programmed into this receiver are "MOVIE", "MUSIC" and "PRO LOGIC". The "MOVIE" mode of the PRO LOGIC II has preset characteristics to produce a calibrated, high-level surround sound playback while the MUSIC mode has user-adjustable characteristics to offer the three optical controls, like "Dimension", "Center Width" and "Panorama" modes to allow optimization of the soundfields as desired. The "Dimension" control allows the user to gradually adjust the soundfield either towards the front or towards the rear; the "Center Width" control allows various adjustment of the left-center-right speakers' balance; the "Panorama mode" extends the front stereo images to include the surround speakers for an exciting "wraparound" effect with side wall imaging.

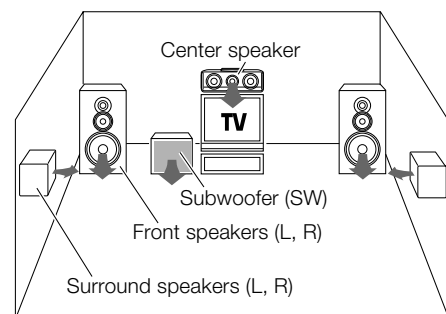

Dolby 3 Stereo

Dolby 3 Stereo is available for systems that do not have surround speakers. When in the Dolby 3 Stereo mode, the surround information is redirected to the front left and right speakers. This mode is designed for use with Dolby Surround program sources, but can also improve sound field unity for programs that are not Dolby Surround encoded. Dialog positioning and sound image definition, however, may not be as accurate when used with programs that are not Dolby Surround encoded.

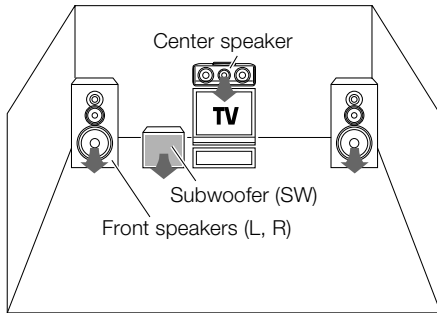
**Multi channel music (SRS Circle Surround)**

SRS Circle surround enables you to listen to multi channel sound from the stereo source. We assume you have already enjoyed listening to Dolby digital sound/DTS multi channel sound with your multi speakers. Now, this time try listening to the stereo source (ex. Audio CD) using your multi speakers. You may discover a new type of "stereo" sound through SRS Circle Surround.

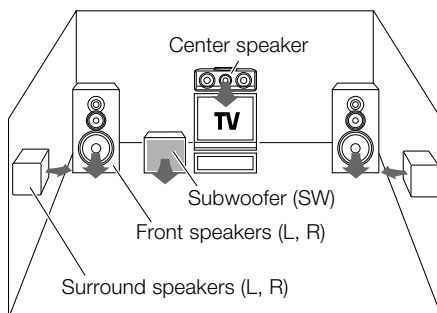
**Home THX Cinema**

THX is a creation of Lucasfilm Ltd., which practically brings the cinema sensation to your home with its superb multichannel digital audio program.

This system promises a reproduction of an enthralling home experience, which is able to encompass smaller space with fantastic audio output. In order to enjoy this function, an optimum speaker placement is required.

THX includes Re-equalization (Re-EQ), Timbre Matching, Adaptive Decorrelation, Bass Peak Level Manager and Loudspeaker Position Time Synchronisation.

Re-equalization (Re-EQ)

When listening in a typical home room, there may be some variation of echo due to air absorption and smaller space. The sound produced by flat response loudspeakers normally used in the cinema can be overly bright in the home environment. Thus, Re-equalization (Re-EQ) will adjust this condition to fit the home environment for a similar cinema effect.

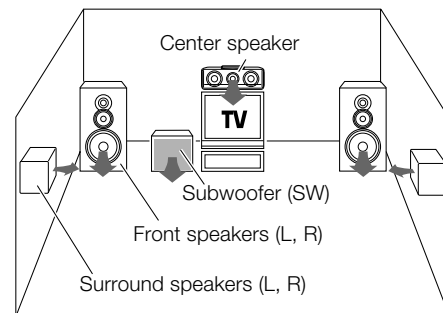
**Timbre Matching**

Due to human condition, listening to sound from various directions of speakers can be very disturbing. So, it is important to smoothen the flow of sound to suit the home cinema environment. Timbre Matching is able to smoothen the flow of sound to the listener who will be able to enjoy the cinema effect at home.

Adaptive Decorrelation

Mono sound track produced from the speaker system comes from only one direction, which does not exemplify the cinema surround sound experience. Adaptive Decorrelation is able to adjust the inaccuracy of this sound distribution.

Bass Peak Level Manager

Certain sound tracks may produced various bass peaks that could be unpleasant in a home cinema environment. Therefore, a user-adjustable Bass Peak Level Manager is used to control the bass level to suit the system's capacity.

→ 22

Loudspeaker Position Time Synchronisation

This function enables you to adjust the different speaker's distance to your listening position. It permits an accurate synchronisation, which creates the ultimate sound environment.

DSP mode

The DSP mode lets you add the atmosphere of a live concert or hall to almost any type of program source. These modes are particularly effective when used with stereo program sources, like CD, television, and FM radio. You might enjoy trying the ARENA, JAZZ CLUB, THEATER, STADIUM or DISCO mode the next time you watch a concert or sporting event!

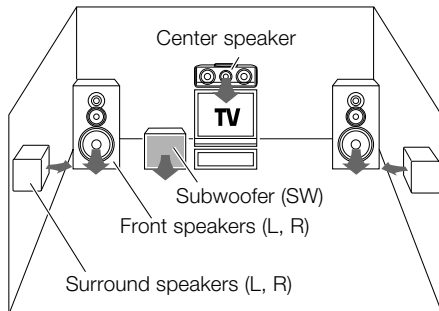
**What's DSP?**

DSP stands for Digital Signal Processor.

The way a sound is heard in an actual environment depends on a variety of different factors. One of the most important is reverberation (the act of decaying elements of sound echoing in various places).

The DSP modes produce the feeling of presence by using the DSP to create reverberation, without spoiling the sound quality of the original signal.

DVD 6-channel mode

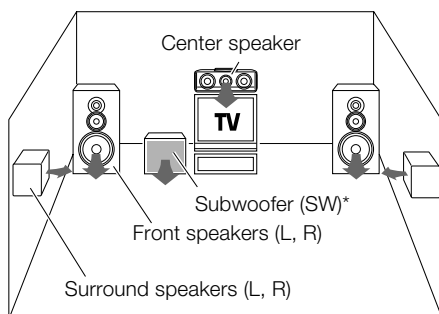

Using a DVD player or the like equipped with six (5.1) output channels and the receiver, you can enjoy multi-channel encoded DVD source material in all its splendor. Since the source signals are digital and each channel is input independently, the resulting sound quality, sense of spaciousness, and dynamic range are superb.



* LFE = Low Frequency Effects. This channel delivers separate non-directional bass signals to the subwoofer for more dynamic deep bass sound effects.

Surround Play

The DTS compatible models can reproduce a CD, DVD, or LD carrying the DTS mark.

DOLBY DIGITAL can be used when playing DVD or LD software bearing the  mark and DOLBY DIGITAL format digital broadcasts (etc.). DOLBY PRO LOGIC and DOLBY 3 STEREO can be used when playing video, DVD, or LD software bearing the  mark.

SRS Circle Surround enables you to listen to multi channel sound from the stereo source.

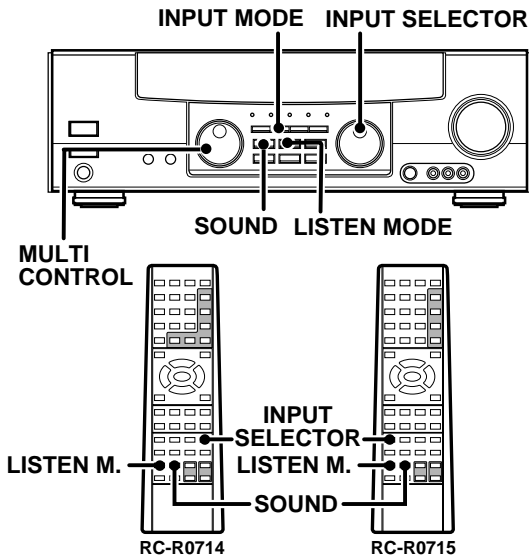

Preparations

- Turn ON related components.
- Complete "Preparing for surround sound" (speaker settings). - [21]
- Use the **INPUT SELECTOR** to select the component you wish to play back with surround sound.
- Use the **INPUT MODE** key to select the input mode (analog or digital) for the source you wish to play back. - [8]
- Noise will be produced when a DTS source is played by selecting the analog input.

1 Start playing the video software.

2 Press the LISTEN MODE (LISTEN M.) key to select the listening mode.

The listening mode settings are stored separately for each input. If the input mode is set to digital auto ("AUTO SOUND" lights), the receiver selects the optimal listening mode automatically based on the type of input signal and the speaker settings.

Each press of the LISTEN MODE (LISTEN M.) key switches the setting as listed below.

The listening mode settings are different depending on the type of input signal.

When the DOLBY DIGITAL signal is input:

(The DOLBY DIGITAL, PRO LOGIC, or 3 STEREO indicator lights up.)

- 1 **DOLBY DIGITAL:** DOLBY DIGITAL surround (The DOLBY DIGITAL indicator lights up.)
- 2 **PL II MOVIE:** PRO LOGIC II surround MOVIE mode (The PRO LOGIC indicator lights up.)
- 3 **PL II MUSIC:** PRO LOGIC II surround MUSIC mode (The PRO LOGIC indicator lights up.)
- 4 **PRO LOGIC:** PRO LOGIC II surround PRO LOGIC mode (The PRO LOGIC indicator lights up.)
- 5 **3 STEREO:** 3-STEREO mode (The 3 STEREO indicator lights up.)
- 6 **STEREO:** Normal stereo playback.

When you select DOLBY DIGITAL

"DOLBY DIGITAL" will be scrolled from right to left.



When the DTS signal is input: (The DTS indicator lights up.)

- 1 **DTS:** DTS surround
- 2 **STEREO:** Normal stereo playback

When the analog signal or the digital signal (except for DOLBY DIGITAL or DTS signal) is input:

- 1 **PL II MOVIE:** PRO LOGIC II surround MOVIE mode (The PRO LOGIC indicator lights up.)
- 2 **PL II MUSIC:** PRO LOGIC II surround MUSIC mode (The PRO LOGIC indicator lights up.)
- 3 **PRO LOGIC:** PRO LOGIC II surround PRO LOGIC mode (The PRO LOGIC indicator lights up.)
- 4 **3 STEREO:** 3-STEREO surround.
- 5 **CIRCLE SURROUND:** CS 5.1 surround (The CS 5.1 indicator lights up.)
- 6 **ARENA:** DSP Surround ARENA mode (The DSP MODE indicator lights up.)
- 7 **JAZZ CLUB:** DSP Surround JAZZ CLUB mode (The DSP MODE indicator lights up.)
- 8 **THEATER:** DSP Surround THEATER mode (The DSP MODE indicator lights up.)
- 9 **STADIUM:** DSP surround STADIUM mode (The DSP MODE indicator lights up.)
- 10 **DISCO:** DSP surround DISCO mode (The DSP MODE indicator lights up.)
- 11 **STEREO:** Normal stereo playback. Sound is produced from the two front channels only.

- If Dolby Digital or DTS signal having more channels than the maximum number of playback channels available using the receiver's current settings is input, the DOWNMIX indicator on the front panel lights up and downmixing is performed to match the number of available channels.

3 Adjust the volume.

Notes

- Depending on the type of the signal or speaker setting, some listening modes cannot be selected.
- When playback is started, the sound may be cut or interrupted before the input source is confirmed as Dolby Digital.
- To enjoy Dolby Digital surround (as well as all the other listening modes) from a single component, be sure to use a Dolby Digital compatible source component. Connect the Dolby Digital compatible source component's Dolby Digital format digital audio signal to one of the **DIGITAL INPUT** jacks on the back of the receiver. Connect the normal audio signal correctly to the respective component's **AUDIO** jacks. - [9] - [10] - [11] - [13]
- **Dialogue Normalization (Dial Norm)** is a feature of Dolby Digital. It is able to automatically maintain the overall audio output level constant. When playing source material with Dolby Digital software encoding, a brief message will appear.



This message informs you that the source material has been recorded at a different level than usual. For example, "OFFSET +4" will scroll across the display to indicate that it had been automatically adjusted to the normal output. If this message does not appear, no adjustment will be made.

DVD 6-channel playback

Using a DVD player or the like equipped with six (5.1) output channels and the receiver, you can enjoy surround sound playback. When you try to play a disc other than Dolby Digital such as DTS CD, no sound is produced or, noise may be heard. To avoid this situation, make sure that you connect the component to the receiver's DVD/6ch. INPUT jacks through a surround processor which can decode the surround signal you want to listen to. Connecting a DVD player which can decode the surround signal itself is also acceptable.

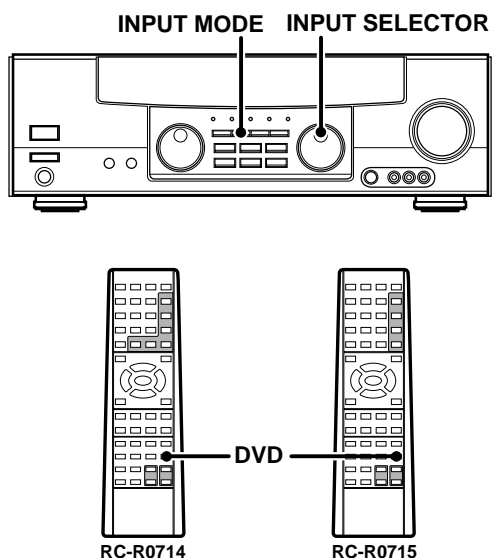

Preparations

- Connect your DVD player to the DVD/6ch jacks of the receiver.
- Turn on all other components that will be used.
- Complete "Preparing for surround sound". - [21]

1 Use the INPUT SELECTOR to select "DVD/6ch" (if it was registered beforehand) as the input source.

- If speaker system B is on when "DVD/6ch" is selected as the input source, it switches off and speaker system A turns on automatically.

2 Select "6ch INPT" by pressing the INPUT MODE key.

3 Start playback of the DVD software.

4 Adjust the volume.

- It is not possible to adjust the volume level or sound quality (SET UP, SOUND) of the channels separately when the receiver is in the DVD/6ch mode. Adjust the volume with the controls of the DVD player. For the powered subwoofer, you can adjust the volume of the subwoofer using the subwoofer's own volume control.

Convenient functions

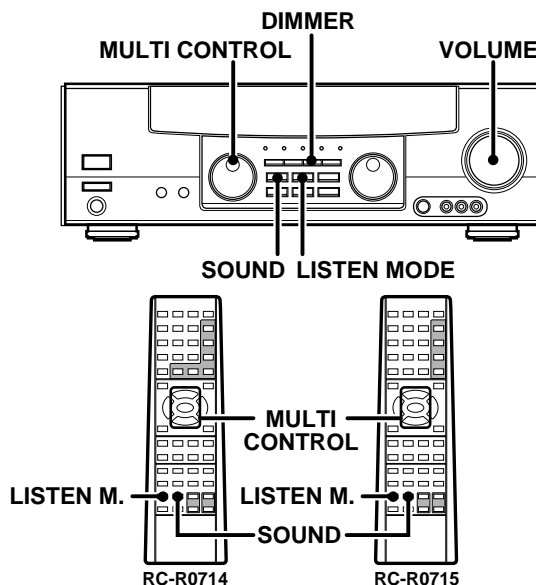

Adjusting the sound

You can make further adjustments to the sound while listening to playback in the surround mode.

- 1 Press the SOUND key until the desired item appears in the display.

Each time you press the button, the menu changes as follows:
Note that some items are not displayed in certain modes.

- 1 BASS (low frequency range sound quality adjustment - PCM and analog stereo modes only) - [24]
- 2 TREB (high frequency range sound quality adjustment - PCM and analog stereo modes only) - [24]
- 3 C (center speaker level adjustment)
- 4 SR (right surround speaker level adjustment)
- 5 SL (left surround speaker level adjustment)
- 6 SW (subwoofer level adjustment)
- 7 INPUT (input level adjustment - analog mode only) - [22]
- 8 NIGHT (midnight mode ON/OFF - Dolby Digital mode only)
- 9 CINEMA or MUSIC (Circle Surround mode only)
- 10 PANORAMA (Panorama mode ON/OFF*)
- 11 DIMENSION (Dimension adjustment*)
- 12 CENTER WIDTH (Center width adjustment*)

*Pro Logic II Music mode only

- 2 Use the MULTI CONTROL knob or keys to adjust the setting as desired.

- The adjustment item is displayed for approximately 8 seconds

Midnight mode (Dolby Digital mode only)

When watching movies at night you might not be able to raise the volume as loud as normal. Midnight mode compresses the dynamic range of previously specified parts of the Dolby Digital sound track (like scenes with sudden increases in volume) to minimize the difference in volume between the specified and non-specified parts. This makes it easy to hear all of the sound track, even when listening at low volumes.

- Press the **SOUND** key repeatedly until "NIGHT" appears in the display.
 - This can be selected only if **CD/DVD**, **DVD/6ch**, **VIDEO2** or **VIDEO3** is selected as the source and the listen mode is set to "DOLBY DIGITAL".
- Use the **MULTI CONTROL** knob or keys to select the **ON** or **OFF** setting.



- The adjustment item is displayed for approximately 8 seconds.
- Some Dolby Digital software may not be compatible with the Midnight mode.

Circle surround mode

When you enjoy multi sound from the stereo source (Circle Surround), you can select the circle surround mode.

- Press the **LISTEN MODE (LISTEN M.)** key so that "CIRCLE SURROUND" is displayed.
- Press the **SOUND** key so that "CINEMA" or "MUSIC" is displayed.
- Use the **MULTI CONTROL** knob or keys to select "CINEMA" (for movies) or "MUSIC" (for music).

Panorama mode (Pro Logic II Music mode only)

When listening to music, you will be able to enjoy the "wraparound" sound effect when you adjust the panorama mode.

- Press the **SOUND** key repeatedly until "PANORAMA" appears in the display.
 - The PANORAMA setting indication scrolls across the display.

"PANORAMA" will be scrolled from right to left.



- Use the **MULTI CONTROL** knob or keys to select PANORAMA ON or OFF.

- ① **ON** : PANORAMA mode is ON.
- ② **OFF** : PANORAMA mode is OFF.



Dimension mode (Pro Logic II Music mode only)

When listening to music with certain recordings, you will also be able to achieve a suitable balance from all the speakers by adjusting the dimension mode.

- Press the **SOUND** key repeatedly until "DIMENSION" appears in the display.
 - The DIMENSION indication scrolls across the display.
- Use the **MULTI CONTROL** knob or keys to adjust the soundfield towards the rear or the front.

Soundfield is adjusted towards the front.

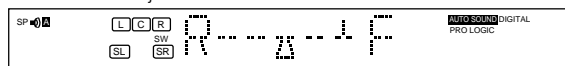

Soundfield is in neutral position.



Soundfield is adjusted towards the rear.

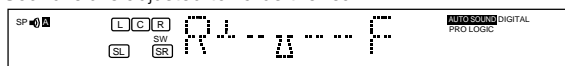

Center width mode (Pro Logic II Music mode only)

Center width adjustment allows you to enjoy an enhanced sound when listening to music through center image from only center speaker, or left and right speakers or various combinations adjustments.

- Press the **SOUND** key repeatedly until "CENTER WIDTH" appears in the display.
 - The CENTER WIDTH indication scrolls across the display.
 - When the center speaker is switched OFF, this mode will not be effective.
- Use the **MULTI CONTROL** knob or keys to adjust the left-center-right output.

Center image will be heard from center speaker only.

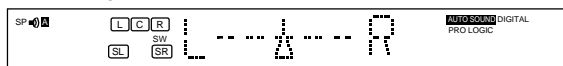

Center image will be heard from left and right speakers only.

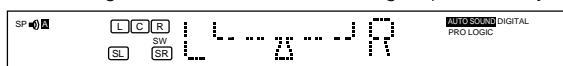

- When in other positions, center image from center speaker, left and right speakers can be heard simultaneously with various combinations.

Display dimmer adjustment

The dimmer function lets you select the brightness of the receiver's display. You might find this useful if you darken your room to watch movies or listen to music.

Each time you press the **DIMMER** key, the display brightness changes among the three available settings. Select the brightest level you find most pleasing.

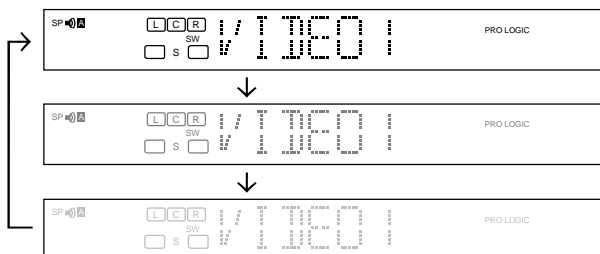

96kHz LPCM playback

The receiver is compatible with the 96kHz LPCM playback. To play a 96kHz DVD, set the listen mode to "STEREO".

- When "96kHz" appears in the display, press the **LISTEN MODE** key (the listen mode changes to the STEREO mode).

Basic remote control operations for other components

The remote control supplied with this receiver is also capable of controlling components from a variety of manufacturers once you register the appropriate setup codes into the remote control unit.

Low battery warning

Replace all two batteries with new ones when you notice a shortening of the distance from which the remote control will operate. The remote control is designed to retain setup codes in memory while you change batteries.

4 Repeat steps 2 to 3 to register additional components until all components have been registered.

Note

Although each setup code is designed to work with a number of different models, certain codes may not work with some models. (Also, certain codes may only operate some of the functions available on a given model.)

Operating other components

This operation lets you operate the registered components. KENWOOD audio components with system control turn on and off automatically with the receiver via the system control connections.

Registering setup codes for other components

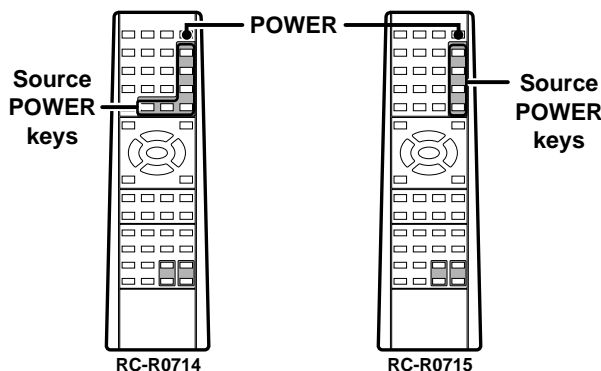
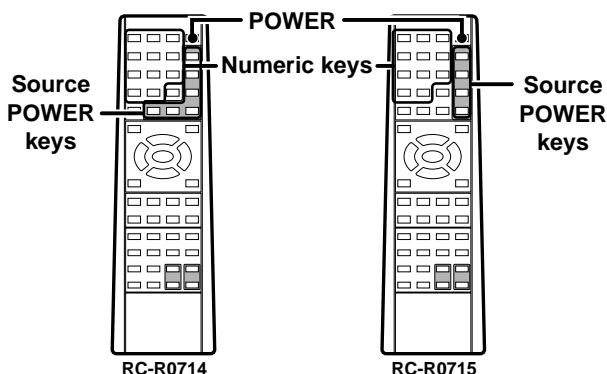

1 Find the setup code of the component to be registered.

- Refer to the setup code lists to find the setup code for the component to be registered. → 36
- Example: To register a DVD made by KENWOOD, you would enter "5115".

Input	Component	Maker	Code	Key
(DVD)	DVD player	KENWOOD	5115	DVD

1 Use the input selector keys to select the component you desire.

- Pressing the input selector keys also changes the input selector on the receiver.
- When you operate your registered TV, VCR, DVD player, Cable tuner, or DSS receiver, go to step 2.
- When you operate the CD player, Cassette deck, MD player, or Tuner with system control connection, go to step 2.

2 Press the source POWER key.

3 Press the operation keys you desire. → 44

- To return to the receiver operation mode, press the RECEIVER key.

The remote control mode returns to the receiver operation mode when you do not operate for more than 15 seconds.

Note

Be sure to point the remote control at the remote sensor on the receiver when you want to operate KENWOOD components connected by system control cords. Otherwise, point the remote control at the component you want to operate.

2 Hold down the POWER key and press the numeric keys to enter the setup code.

- Example: Press "5115" to register a DVD player made by KENWOOD.
- If you push an invalid key, the remote will exit the setup mode.

3 Press the source POWER (TV, VCR1, VCR2, DVD) key for more than 2 seconds, and check to see that the component you want to control turns on.

If the component does not react, and there is more than one setup code, enter another setup code and try again.

- If the component is already on, pressing the source POWER keys for more than 2 seconds will turn it off.

Setup code chart

36

TV Setup Codes (RC-R0714)

< Maker >	No.	No.	No.	No.	No.	No.	No.	No.	No.	No.	No.	No.	No.
AKAI	0104												
ADMIRAL	0112	0124	0126										
AIWA	0138	0142	0143										
AOC	0105												
BROKSONIC	0104	0105	0144	0180									
BELL & HOWELL	0124	0126	0178										
CRAIG	0108	0109	0110										
CURTIS MATHES	0104	0107	0110										
CENTURION	0105												
CROSLEY	0115												
CORONAD	0164												
DAEWOO	0104	0135	0196	0106									
EMERSON	0104	0108	0109	0110	0120	0133	0134	0180					
FISHER	0111												
FUNAI	0136	0137	0140	0141	0146	0147	0155						
FUJITSU	0156	0157	0160	0139									
GE	0101	0104	0112	0132									
GOLD STAR	0104	0105	0165										
HITACHI	0104	0113	0183										
INTEQ	0127	0126											
JC PENNY	0104	0112											
JVC	0114	0167	0184	0158	0159								
KTV	0110	0166	0104										
LXI	0104	0105	0107	0111	0112	0115							
MTC	0101	0103											
MGA	0104	0105											
MAGNAVOX	0104	0105	0116	0115	0129	0168							
MITSUBISHI	0104	0105	0117	0124	0172	0198							
MARANTZ	0117												
MAGNASONIC	0178												
MEMOREX	0178												
NATIONAL	0101	0102	0151	0100									
NEC	0105	0104											
ORION	0128												
PANASONIC	0101	0102	0193	0194	0100	0151							
PRISM	0101												
PROSCAN	0101	0103	0104	0121	0122	0185							
PHILCO	0104	0115											
PROSCAN	0104	0112	0118										
PIONEER	0107	0118											
PHILIPS	0115												
QUASAR	0101	0103											
RCA	0104	0112	0119	0121	0122	0130	0131	0132	0161	0162	0163	0169	0186
RADIOSHACK	0105	0110	0112	0117									
SAMSUNG	0104	0105	0123	0170									
SEARS	0104	0105	0107	0112	0115								
SYLVANIA	0104	0105	0110	0115									
SCOTT	0110												
SYMPHONIC	0110	0171											
SANYO	0110	0149	0152	0153	0154	0197							
SHARP	0120	0124	0150	0187	0195								
SIGNATURE 2000	0124	0126											
SONY	0125	0188	0192										
TOSHIBA	0107	0124	0189										
TECHNICS	0100												
VIDTECH	0104	0105	0113										
WARDS	0120	0104	0105	0120									
ZENITH	0126	0127	0144	0190									

TV Setup Codes (RC-R0715)

< Maker >	No.	No.	No.	No.	No.	No.	No.	No.	No.	No.	No.	No.	No.
AKAI	0515	0516	0548	0549	0550								
ALBA	0512	0515	0516										
AUDIOSONIC	0515	0516											
BAUR	0555												
BLAUPUNKT	0548	0549	0550										
BRANDT	0544	0545											
BUSH	0508	0509	0512	0513	0514	0515	0516	0559					
CROWN	0515	0516	0537	0538									
DAEWOO	0515	0516	0558										
DUAL	0559												
FERGUSON	0515	0516											
FINLUX	0515	0516	0535	0536	0537	0538	0539	0541	0542	0543			
FIRSTLINE	0510	0511											
FUNAI	0508	0509											
GOLDSTAR	0515	0516											
GOODMANS	0515	0516	0541	0542	0543	0558							
GRUNDIG	0548	0549	0550										
HITACHI	0529	0530	0544	0545									
ICE	0533	0534											
INNO HIT	0541	0542	0543	0557									
ITT-NOKIA	0512												
JVC	0527	0528											
KENDO	0512	0515	0516	0535	0536								
LOEWE	0519	0520	0556										
LOEWE OPTA	0555												
MARK	0515	0516											
MATSUI	0508	0509	0512	0513	0514	0515	0516	0541	0542	0543			
MITSUBISHI	0519	0520	0525	0526	0548	0549	0550						
NEI	0515	0516	0540										
NOKIA	0512												
NORMENDE	0544	0545											
OCEANIC	0546	0547											
ORION	0508	0509	0510	0511	0512	0513	0514	0515	0516				
PANASONIC	0529	0530	0551	0552	0553	0554							
PHILIPS	0515	0516	0517	0518	0521								
PHONOLA	0515	0516											
RADIOLA	0515	0516											
ROADSTAR	0533	0534											
SABA	0544	0545											
SAMSUNG	0515	0516	0521	0533	0534	0541	0542	0543	0557				
SANYO	0523	0524	0541	0542	0543								
SCHNEIDER	0515	0516											
SEG	0533	0534	0535	0536									
SELECO	0515	0516	0539										
SHARP	0523	0524	0531	0532									
SIEMENS	0515	0516	0523	0524	0548	0549	0550						
SINUDYNE	0508	0509	0512	0515	0535	0536	0539						
SONY	0522												
THOMSON	0512	0544	0545										
THORN	0515	0516	0519	0520	0522	0541	0542	0543	0558				
TOSHIBA	0510	0511											
UNIVERSUM	0515	0516	0533	0534									
VESTEL	0515	0516											
WATSON	0515	0516											
WHITE WESTING	0515	0516	0535	0536									

Cable Setup Codes (RC-R0714)

< Maker >	No.	No.	No.	No.	No.	No.	No.	No.	No.	No.	No.	No.	No.
ABC	3124												
ARCHER	3125	3132											
CABLE VIEW	3105	3132											
CITIZEN	3105	3122											
CURTIS	3112	3113											
DIAMOND	3124	3125	3132										
EAGLE	3129												
EASTERN	3134												
GCBRAND	3105	3132											
G.I./JERROLD	3111	3119	3120	3121	3123	3126	3127	3122	3124	3125			
GEMINI	3122	3143											
HITACHI	3124	3103											
HAMLIN	3140	3141	3142	3145	3112	3118							
MACOM	3103	3104	3105	3108									
MOVIETIME	3105	3132											
MEMOREX	3130												
MAGNAVOX	3133												
OAK	3102	3137	3139										
PULSAR	3105												
PHILIPS	3106	3107	3128	3129	3130	3131	3150						
PANASONIC	3109	3110	3114	3151									
PIONEER	3101	3116											
PULSAR	3132												
PUSER	3132												
REALISTIC	3132												
REMBRANT	3105	3132	3137	3138									
RCA	3115												
REGAL	3118	3112	3140	3141	3142	3145	3149						
REGENCY	3134												
SLMARK	3101	3105											
SAMSUNG	3105												
SPRUCER	3105	3110											
STARGATE	3105												
S.A	3111	3112	3132										
TOSHIBA	3104	3146											
TELEVIEW	3101	3105											
TOCOM	3135	3136	3147										
TEXSCAN	3144												
TELECATION	3148												
UNIVERSAL	3122	3132											
UNIKA	3125	3132											
VIEWSTAR	3129	3130											
VIDEOWAY	3106												
ZENITH	3117	3100											
ZENITH/ DRAKE	3100												

VCR Setup Codes (VCR1) (RC-R0714)

< Maker >	No.	No.	No.	No.	No.	No.	No.	No.	No.	No.	No.	No.	No.
ADMIRAL	1135												
AIWA	1127	1132	1181										
AKAI	1114	1115	1116	1129									
AUDIO DYNAMIC	1111	1139											
BELL & HOWELL	1105	1113											
BROKSONIC	1120	1126	1180										
CANON	1123	1125											
CCE	1143												
CITIZEN	1106												
CRAIG	1105	1106	1129										
CURTIS MATHES	1124	1127	1145										
DAEWOO	1101	1124	1143	1175									
DBX	1110	1111	1139										
DIMENSIA	1145												
EMERSON	1103	1118	1119	1120	1125	1126	1142	1143					
FISHER	1105	1107	1108	1109	1113	1165							
FUNAI	1120	1126	1127	1134									
GE	1124	1133	1145										
GOLD STAR	1106												
GO VIDEO	1137	1149	1150	1151	1163	1182							
GARDIENTE	1134	1156	1168	1170	1171								
HITACHI	1100	1123	1127	1145	1168								
INSTANT REPLAY	1123	1124											
JENSEN	1139												
JVC	1110	1111	1134	1139	1157	1158							
KENWOOD	1106	1110	1111	1139									
LG	1159												
LXI	1100	1105	1106	1107	1108	1109	1127						
MAGNAVOX	1123	1124	1131	1173									
MARANTZ	1110	1111	1139										
MARTA	1106												
MEMOREX	1109	1124											
MGA	1138	1140	1141	1142	1147	1148							
MINOLTA	1100	1145											
MITSUBISHI	1138	1140	1141	1142	1147	1148	1161	1164					
MULTITECH	1104	1127	1147										
NEC	1110	1111	1134	1139									
OLYMPIC	1123	1124											
OPTIMUS	1106	1121	1128	1135									
ORION	1120	1126											
PANASONIC	1121	1122	1123	1124									
PENNEY	1100	1105	1110	1111	1124	1139	1145						
PENTAX	1100	1111	1145										
PHILCO	1120	1123	1124	1126	1127	1131	1143						
PHILIPS	1123	1124	1131	1173									
PIONEER	1123												
PROSCAN	1100	1101	1102	1123	1124	1131	1133	1145	1146	1174			
QUASAR	1121	1122	1123	1124									
RADIO SHACK	1105	1109	1124	1127	1133	1136	1140						
RCA	1100	1101	1102	1123	1124	1131	1133	1145	1146	1171	1172	1174	1176
REALISTIC	1105	1109	1124	1127	1136	1140							
SAMSUNG	1102	1104	1133	1137									
SAMTRON	1163												
SANSUI	1120	1126	1139	1152									
SANYO	1105	1109	1113										
SCOTT	1101	1102	1104	1109	1120	1126	1138	1140	1147	1148			
SEARS	1100	1105	1106	1107	1108								
SHARP	1135	1136	1162	1167									
SHINTOM	1117												
SIGNATURE 2000	1127	1135											
SINGER	1117												
SONY	1128	1129	1130	1153	1154	1155							
SV2000	1127												
SYLVANIA	1123	1124	1127	1131	1178								
SYMPHONIC	1127	1168	1177										
TASHIRO	1106												
TATUNG	1110	1111	1139										
TEAC	1110	1111	1127	1139									
TECHNICS	1121	1122	1123	1124									
TEKNICA	1112	1124	1127										
THOMSON	1179												
TOSHIBA	1101	1146	1160	1166									
VECTOR RESEARCH	1111												
WARDS	1106	1109	1135	1136	1144								
YAMAHA	1105	1110	1111	1139									
ZENITH	1106	1144	1169	1180									

VCR Setup Codes (VCR2) (RC-R0714)

< Maker >	No.	No.	No.	No.	No.	No.	No.	No.	No.	No.	No.	No.	No.
ADMIRAL	2135												
AIWA	2127	2132	2181										
AKAI	2114	2115	2116	2129									
AUDIO DYNAMIC	2111	2139											
BELL&HOWELL	2105	2113											
BROKSONIC	2120	2126	2180										
CANON	2123	2125											
CCE	2143												
CITIZEN	2106												
CRAIG	2105	2106	2129										
CURTIS MATHES	2124	2127	2145										
DAEWOO	2101	2124	2143	2175									
DBX	2110	2111	2139										
DIMENSIA	2145												
EMERSON	2103	2118	2119	2120	2125	2126	2142	2143					
FISHER	2105	2107	2108	2109	2113	2165							
FUNAI	2120	2126	2127	2134									
GE	2124	2133	2145										
GOLDSTAR	2106												
GO VIDEO	2137	2149	2150	2151	2163	2182							
GARDIENTE	2134	2156	2168	2170	2171								
HITACHI	2100	2123	2127	2145	2168								
INSTANT REPLAY	2123	2124											
JENSEN	2139												
JVC	2110	2111	2134	2139	2157	2158							
KENWOOD	2106	2110	2111	2139									
LG	2159												
LXI	2100	2105	2106	2107	2108	2109	2127						
MAGNAVOX	2123	2124	2131	2173									
MARANTZ	2110	2111	2139										
MARTA	2106												
MEMOREX	2109	2124											
MGA	2138	2140	2141	2142	2147	2148							
MINOLTA	2100	2145											
MITSUBISHI	2138	2140	2141	2142	2147	2148	2161	2164					
MULTITECH	2104	2127	2147										
NEC	2110	2111	2134	2139									
OLYMPIC	2123	2124											
OPTIMUS	2106	2121	2128	2135									
ORION	2120	2126											
PANASONIC	2121	2122	2123	2124									
PENNEY	2100	2105	2110	2111	2124								
PENTAX	2100	2111	2145										
PHILCO	2120	2123	2124	2126	2127	2131	2143						
PHILIPS	2123	2124	2131	2173									
PIONEER	2123												
PROSCAN	2100	2101	2102	2123	2124	2131	2133	2145	2146	2174			
QUASAR	2121	2122	2123	2124									
RADIO SHACK	2105	2109	2124	2127	2133	2136	2140						
RCA	2100	2101	2102	2123	2124	2131	2133	2145	2146	2171	2172	2174	2176
REALISTIC	2105	2109	2124	2127	2136	2140							
SAMSUNG	2102	2104	2133	2137									
SAMTRON	2163												
SANSUI	2120	2126	2139	2152									
SANYO	2105	2109	2113										
SCOTT	2101	2102	2104	2109	2120	2126	2138	2140	2147	2148			
SEARS	2100	2105	2106	2107	2108								
SHARP	2135	2136	2162	2167									
SHINTOM	2117												
SIGNATURE 2000	2127	2135											
SINGER	2117												
SONY	2128	2129	2130	2153	2154	2155							
SV2000	2127												
SYLVANIA	2123	2124	2127	2131	2178								
SYMPHONIC	2127	2168	2177										
TASHIRO	2106												
TATUNG	2110	2111	2139										
TEAC	2110	2111	2127	2139									
TECHNICS	2121	2122	2123	2124									
TEKNICA	2112	2124	2127										
THOMSON	2179												
TOSHIBA	2101	2146	2160	2166									
VECTOR RESEARCH	2111												
WARDS	2106	2109	2135	2136	2144								
YAMAHA	2105	2110	2111	2139									
ZENITH	2106	2144	2169	2180									

VCR Setup Codes (VCR1) (RC-R0715) (For U. K. only)

< Maker >	No.	No.	No.	No.	No.	No.	No.	No.
AKAI	1505	1506	1515	1516	1522	1523	1526	1527
ALBA	1519	1520	1522	1523				
BAIRD	1505	1506	1507	1508				
BLAUPUNKT	1538	1541	1546	1547	1550			
BUSH	1519	1520	1524	1525				
DAEWOO	1513	1514						
FISHER	1504	1507	1508	1509	1510	1521		
FERGUSON	1548							
GOLDSTAR	1500	1501	1502	1503	1506			
GOODMANS	1500	1501	1519	1520	1542	1543	1550	
GRUNDIG	1519	1520	1541	1544	1545	1549	1550	
HCM	1519	1520						
HITACHI	1511	1512	1517	1518				
ITT	1505	1506	1507	1508	1509			
ITT-NOKIA	1505	1506	1507	1508	1509	1542	1543	
JVC	1532	1533	1534	1535				
KENDO	1505	1506	1524	1525				
LOEWE	1500	1501	1549					
LUXOR	1505	1506	1507	1508	1509	1526	1527	
MATSUI	1500	1501	1521	1524	1525			
METZ	1538							
MITSUBISHI	1526	1527	1534	1535	1549			
NEC	1502	1503	1506	1534	1535			
NOKIA	1505	1506	1507	1508	1509	1536	1542	1543
NORDMENDE	1532	1533	1534	1535				
OKANO	1522	1523						
ORION	1521	1524	1525					
PHILIPS	1536	1549	1550	1551	1552			
PANASONIC	1538	1546	1547					
PHONOLA	1549							
ROADSTAR	1500	1501	1519	1520	1542	1543		
RFT	1550							
SABA	1534	1535						
SALORA	1505	1506	1509	1526	1527			
SAMSUNG	1513	1514	1515	1516	1542	1543		
SANYO	1504	1507	1508	1509				
SCHAUB LOR	1507	1508						
SCHNEIDER	1500	1501	1519	1520	1542	1543	1549	
SEG	1519	1520	1542	1543				
SHARP	1536							
SIEMENS	1500	1501	1507	1508	1509	1549		
SONY	1539	1540	1541					
THOMSON	1534	1535						
THORN	1507	1508						
TOSHIBA	1513	1514	1526	1527	1549			
UNNERSUM	1500	1501	1505	1506	1549			

VCR Setup Codes (VCR2) (RC-R0715) (For U.K. only)

< Maker >	No.	No.	No.	No.	No.	No.	No.	No.
AKAI	2505	2506	2515	2516	2522	2523	2526	2527
ALBA	2519	2520	2522	2523				
BAIRD	2505	2506	2507	2508				
BLAUPUNKT	2538	2541	2546	2547	2550			
BUSH	2519	2520	2524	2525				
DAEWOO	2513	2514						
FISHER	2504	2507	2508	2509	2510	2521		
FERGUSON	2548							
GOLDSTAR	2500	2501	2502	2503	2506			
GOODMANS	2500	2501	2519	2520	2542	2543	2550	
GRUNDIG	2519	2520	2541	2544	2545	2549	2550	
HCM	2519	2520						
HITACHI	2511	2512	2517	2518				
ITT	2505	2506	2507	2508	2509			
ITT-NOKIA	2505	2506	2507	2508	2509	2542	2543	
JVC	2532	2533	2534	2535				
KENDO	2505	2506	2524	2525				
LOEWE	2500	2501	2549					
LUXOR	2505	2506	2507	2508	2509	2526	2527	
MATSUI	2500	2501	2521	2524	2525			
METZ	2538							
mitsubishi	2526	2527	2534	2535	2549			
NEC	2502	2503	2506	2534	2535			
NOKIA	2505	2506	2507	2508	2509	2536	2542	2543
NORDMENDE	2532	2533	2534	2535				
OKANO	2522	2523						
ORION	2521	2524	2525					
PHILIPS	2536	2549	2550	2551	2552			
PANASONIC	2538	2546	2547					
PHONOLA	2549							
ROADSTAR	2500	2501	2519	2520	2542	2543		
RFT	2550							
SABA	2534	2535						
SALORA	2505	2506	2509	2526	2527			
SAMSUNG	2513	2514	2515	2516	2542	2543		
SANYO	2504	2507	2508	2509				
SCHAUB LOR	2507	2508						
SCHNEIDER	2500	2501	2519	2520	2542	2543	2549	
SEG	2519	2520	2542	2543				
SHARP	2536							
SIEMENS	2500	2501	2507	2508	2509	2549		
SONY	2539	2540	2541					
THOMSON	2534	2535						
THORN	2507	2508						
TOSHIBA	2513	2514	2526	2527	2549			
UNNERSUM	2500	2501	2505	2506	2549			

DVD Setup Codes (RC-R0714/R0715)

< Maker >	No.	No.	No.	No.
APEX	5120			
AIWA	5123			
DENON	5100	5117		
FERGUSON	5101			
HITACHI	5111			
JVC	5109			
KENWOOD	5115	5129		
MITSUBISHI	5105			
NORDMENDE	5101			
ONKYO	5121			
ORITRON	5124			
PIONEER	5102			
PHILIPS	5103	5116		
PANASONIC	5100			
RCA	5101	5106		
RAITE	5113			
SABA	5101			
SONY	5104	5126	5127	5128
SILVANIA	5118			
SMC	5125			
SAMPO	5114			
SAMSUNG	5110			
SHARP	5108			
THOMSON	5101			
TECHNICS	5100			
TOSHIBA	5103			
KONKA	5119			
WAVE	5122			
YAMAHA	5100			
ZENITH	5107	5112		

DSS/DBS Setup Codes (RC-R0714)

< Maker >	No.	No.	No.	No.
DISH NETWORK (Echostar)	4105	4115	4116	
ECHOSTAR	4105			
EXPRESS VU	4105	4115		
G. E.	4106			
G. I.	4108			
GRADIENTE	4114			
HITACHI	4111	4112	4103	
HNS (Hughes)	4103			
MAGNAVOX	4101	4102		
PANASONIC	4104			
PHILIPS	4101	4102		
PROSCAN	4106	4109	4110	4113
PRIMESTAR	4108			
STAR CHOICE	4103	4108		
SONY	4107			
TOSHIBA	4100			
UNIDEN	4101	4102		
RCA	4106	4109	4110	4113

Remote control operation of other components

Refer to the following for the type of remote control operations available for each component.

- 1 Use the Input selector keys or source POWER keys to select the component you want to control.
- 2 Press the keys corresponding to the operations you desire. Refer to the following sections for details.

- When pressing keys in succession, press each key firmly and be sure to wait at least 1 second before pressing the next key.
- Numeric keys function the same as the numeric keys on the original remote.

Notes

1. Although each setup code is designed to work with a number of different models, certain codes may not work with some models. (Also, certain codes may only operate some of the functions available on a given model.)
2. The charts below show the typical functions available for each component. Some manufacturers use different key combinations to perform similar functions. For that reason, we have programmed extra functions on some of the unused number keys to help you control your equipment. The setup code for each component must be entered beforehand.

Cable tuner operations

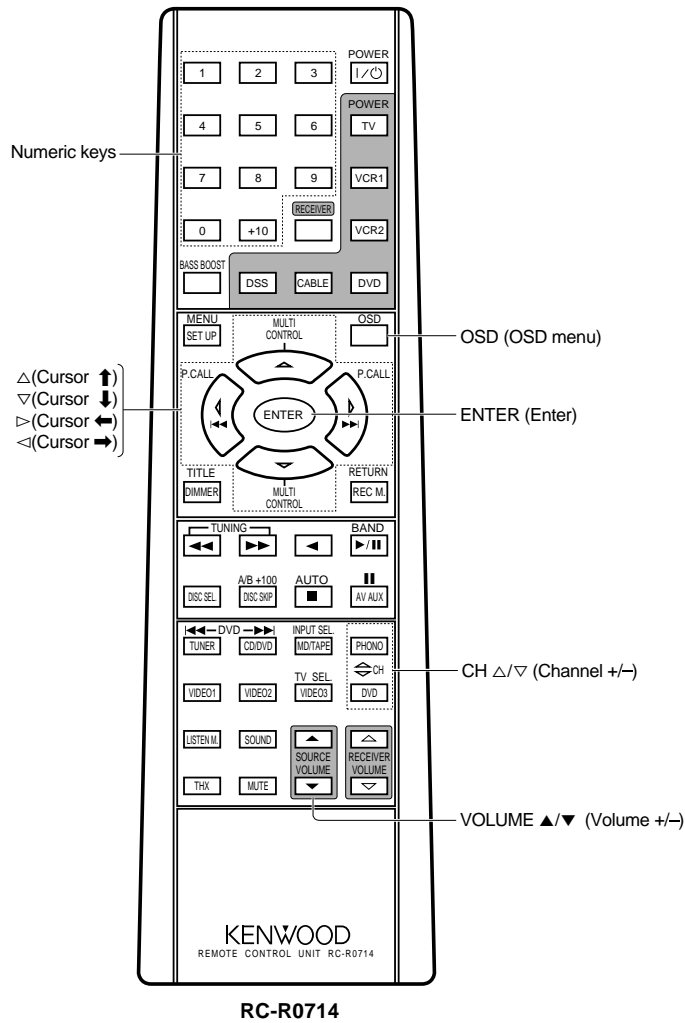

Cassette deck operations

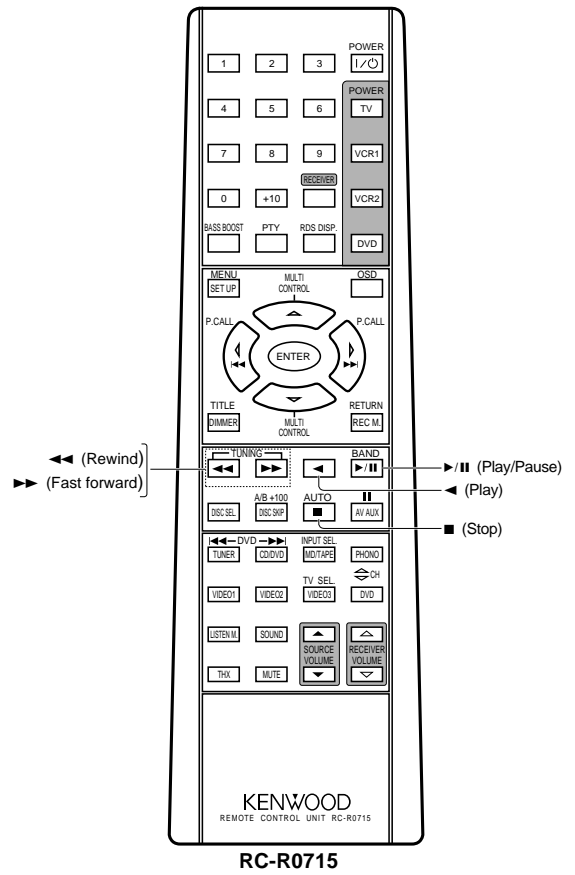
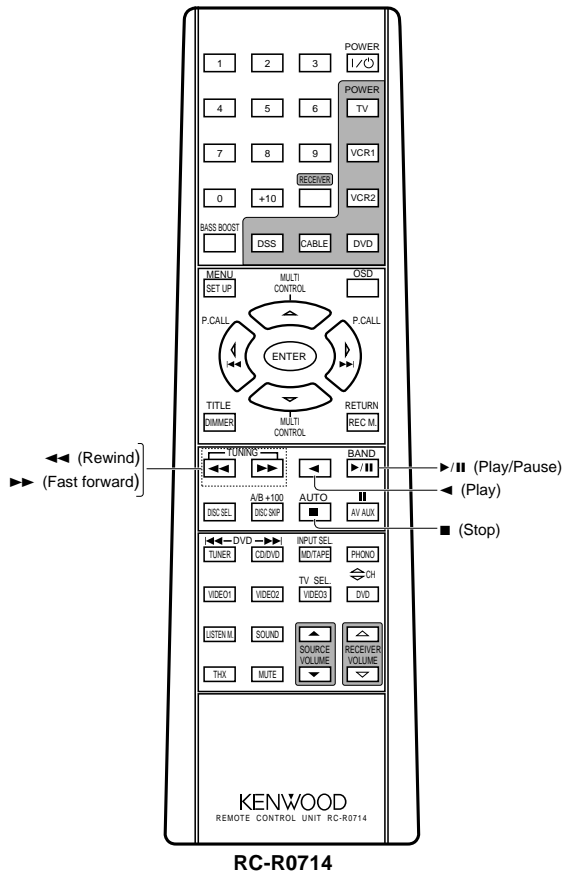

CD player operations

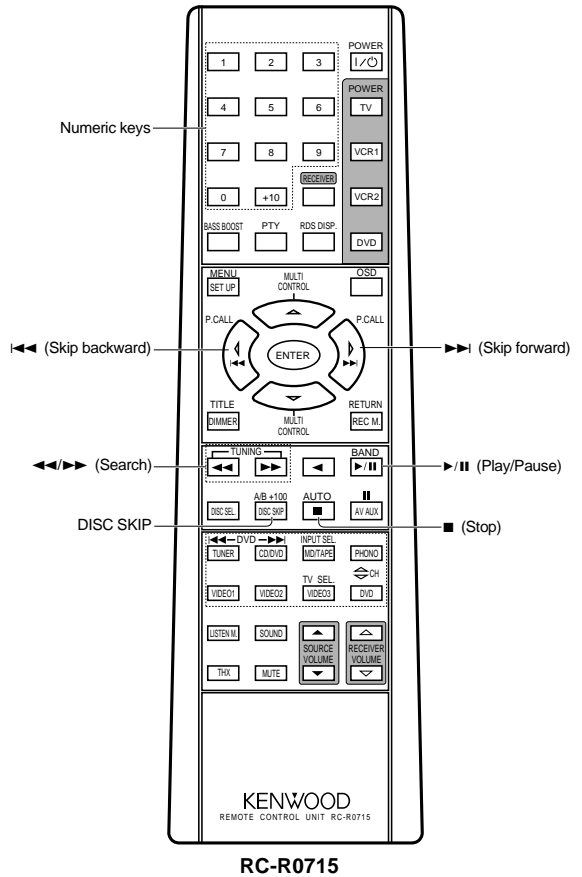
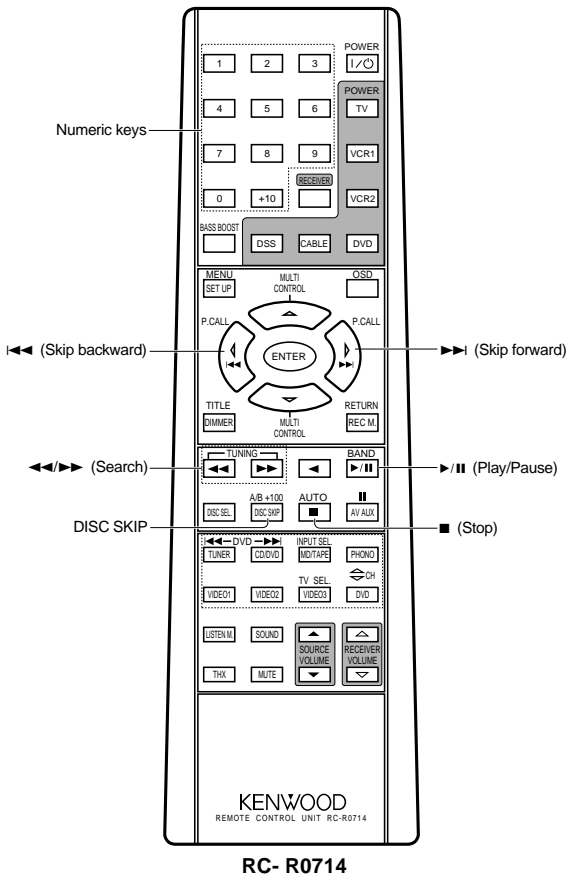

MD recorder operations

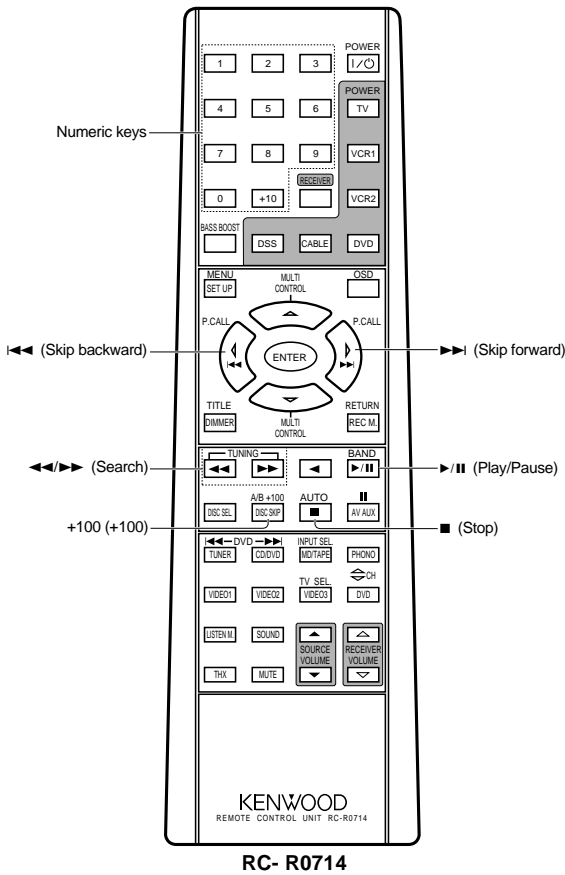

RC- R0714

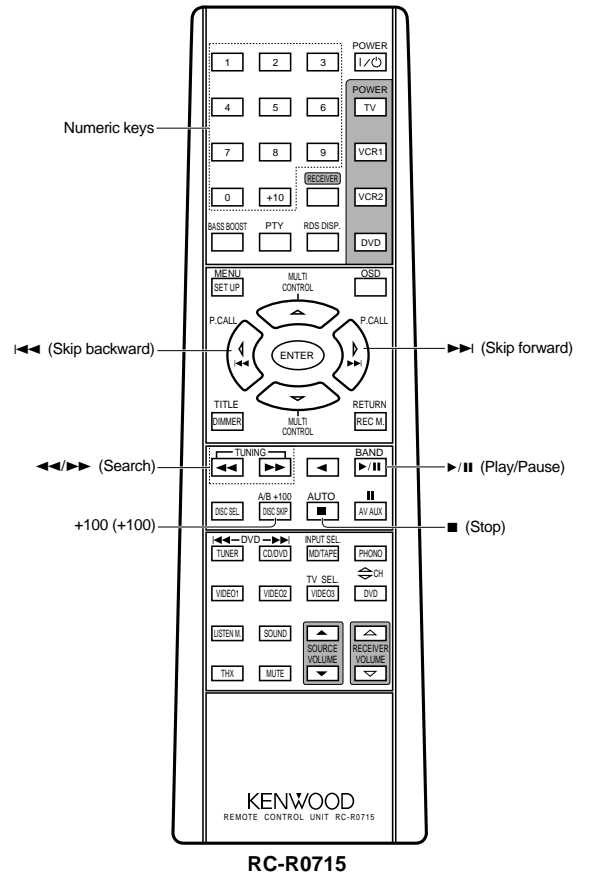

RC-R0715

TV operations

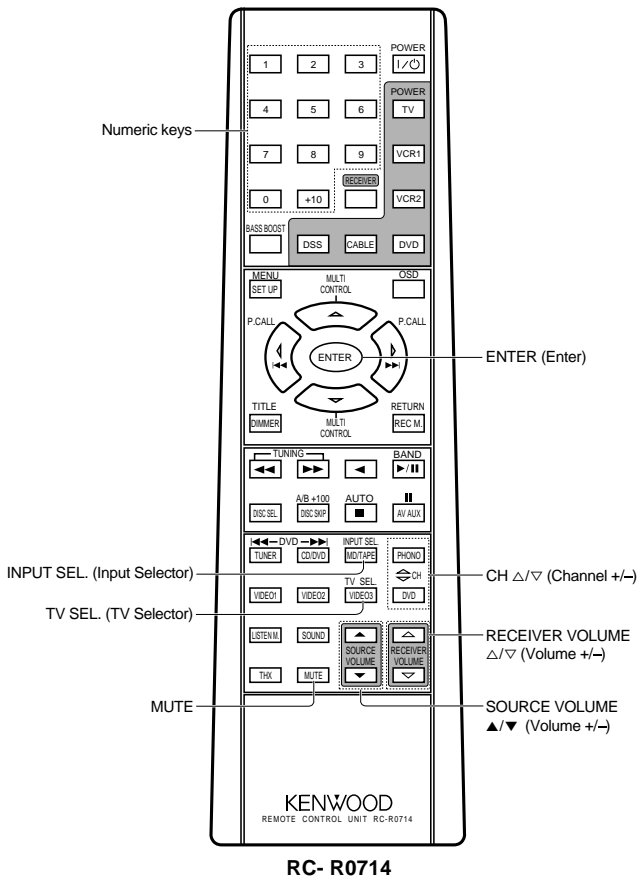

RC- R0714

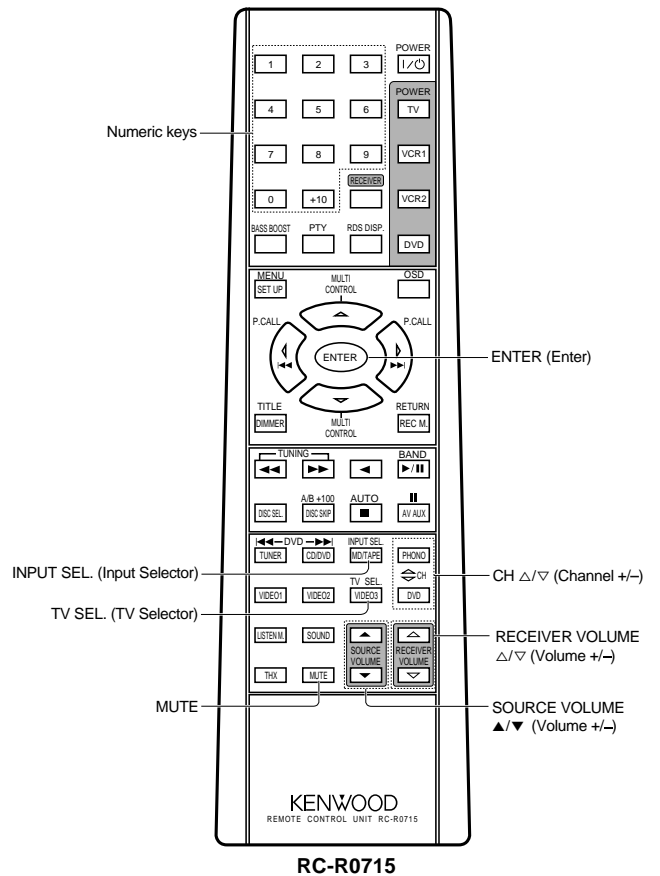

RC-R0715

VCR operations

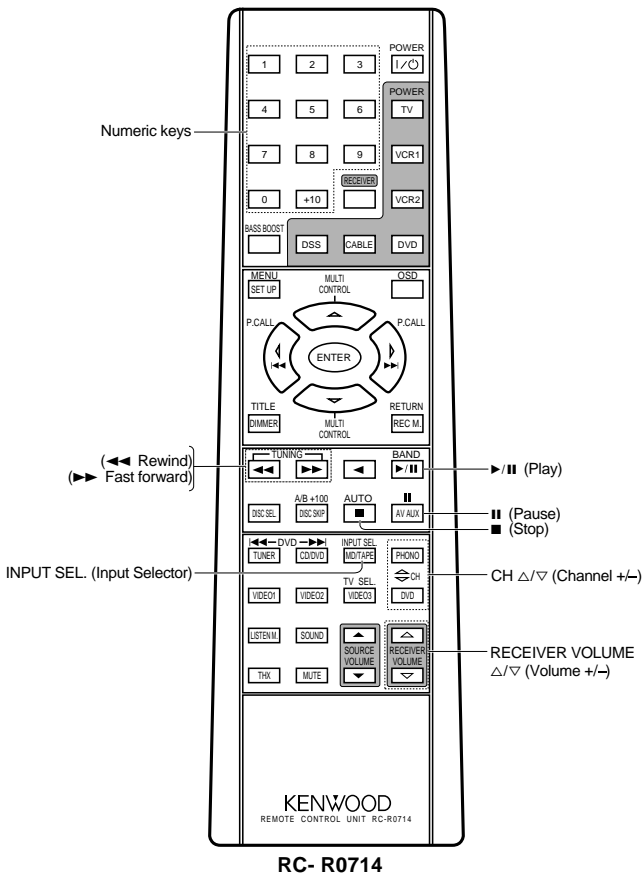

RC- R0714

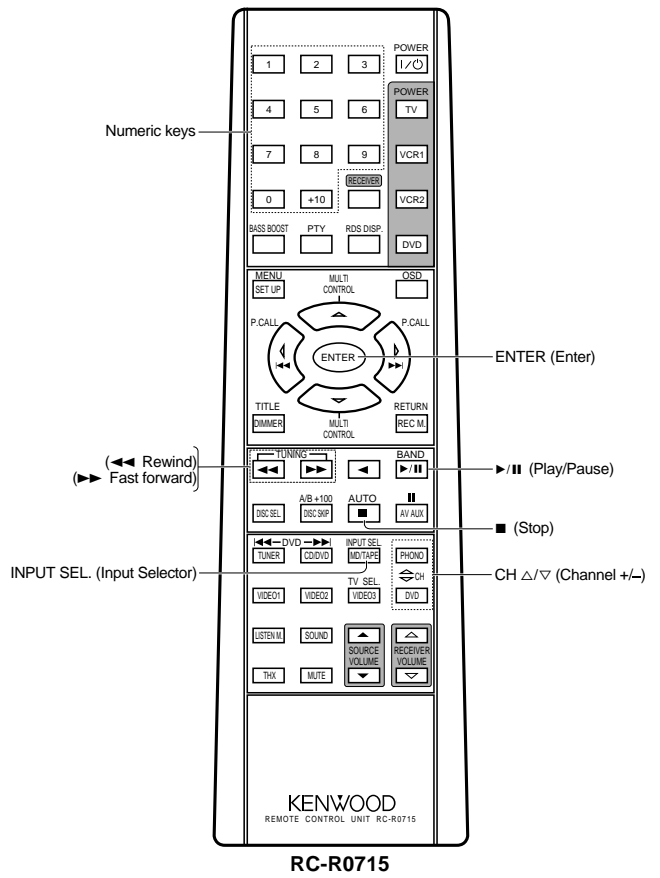

RC-R0715

LD player operations

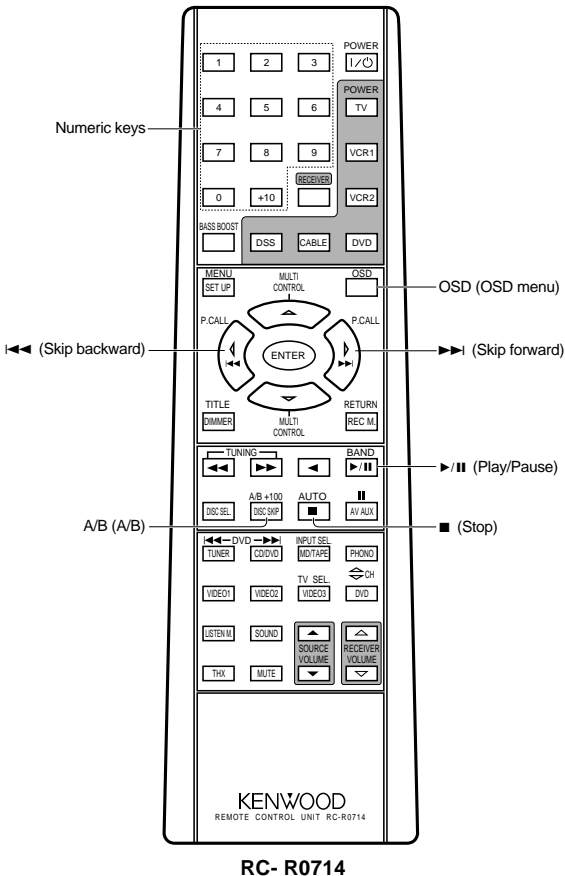

RC- R0714

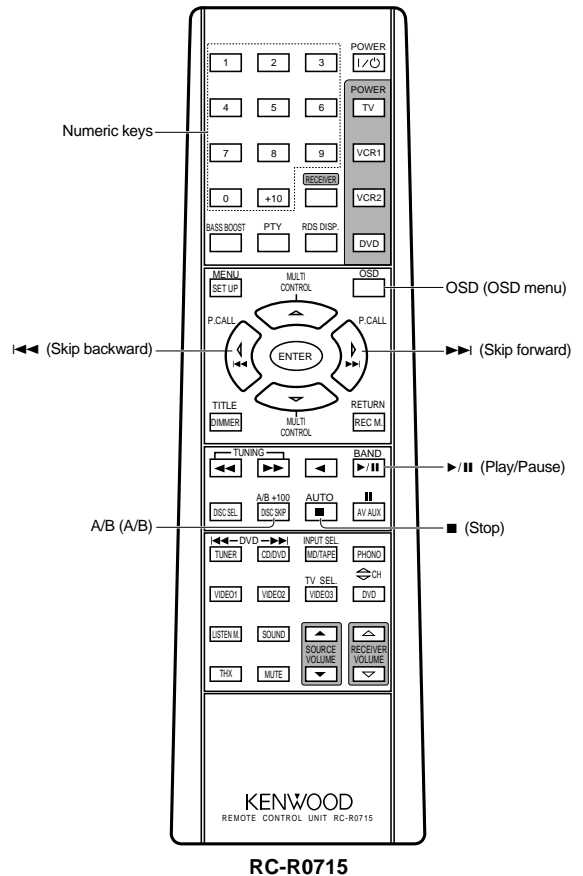

RC-R0715

DVD player operations

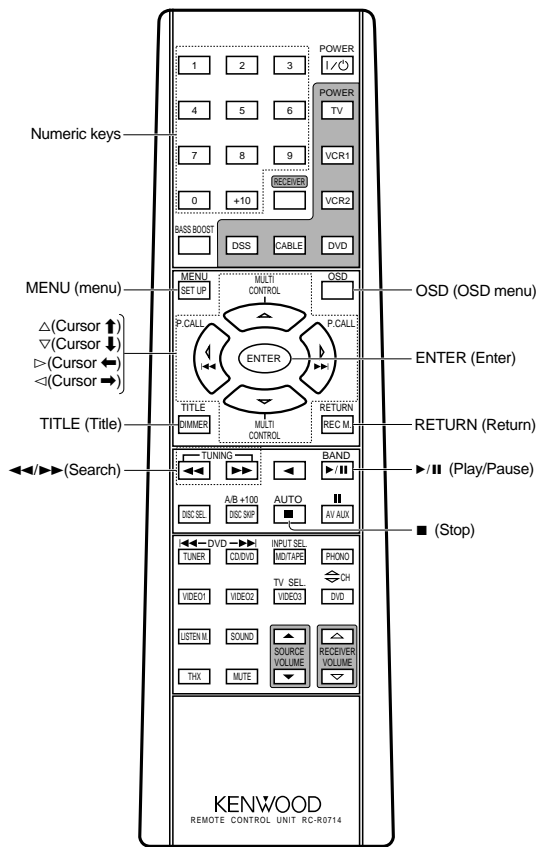

RC- R0714

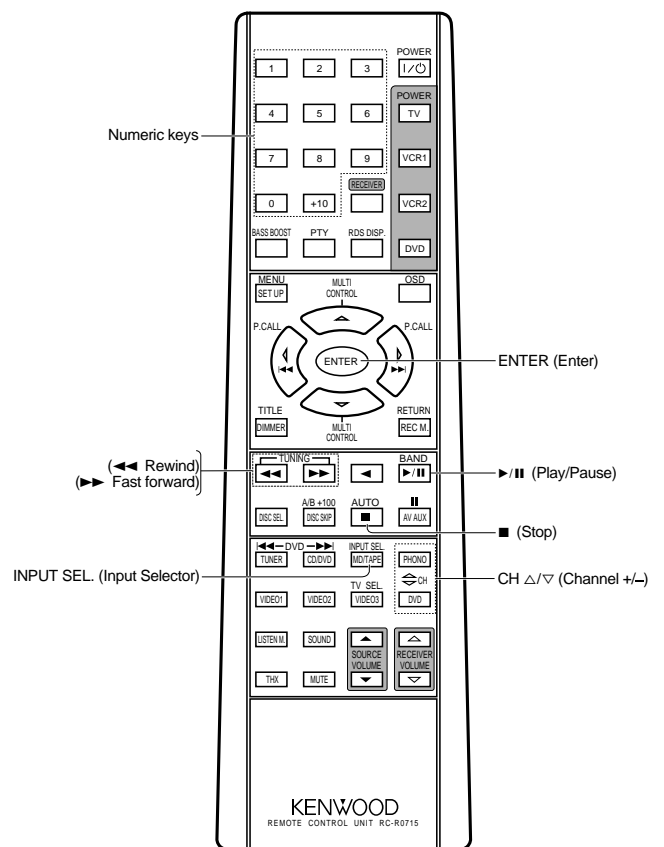

RC-R0715

DSS/DBS receiver operations

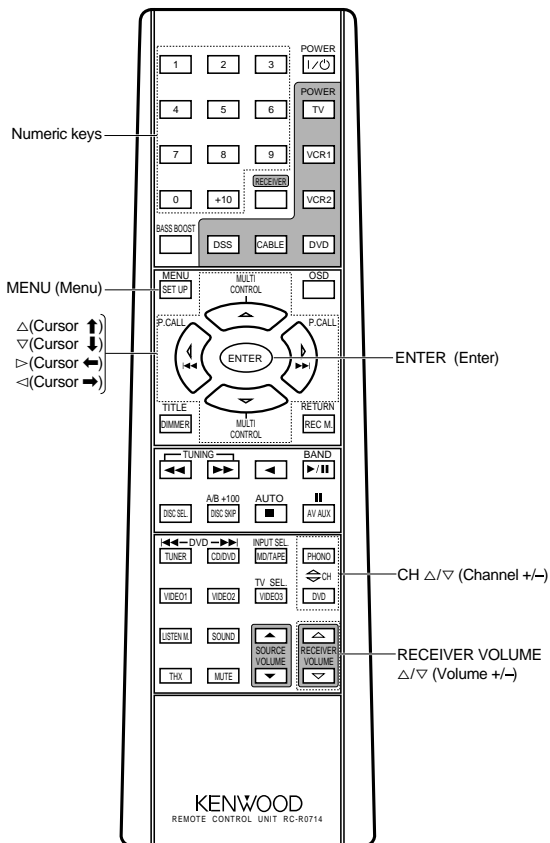

RC- R0714

Resetting the Microcomputer

The microcomputer may malfunction (unit cannot be operated, or shows an erroneous display) if the power cord is unplugged while the power is ON, or due to some other external factor. If this happens, execute the following procedure to reset the microcomputer and return the unit to its normal operating condition.

Unplug the power cord from the wall outlet, then plug it back in while holding down the STANDBY key.

- Please note that resetting the microcomputer will clear the contents of the memory and returns the unit to the state it was in when it left the factory.

Amplifier

Symptom	Cause	Remedy
No sound from the speakers.	<ul style="list-style-type: none"> • The speaker cords are disconnected. • VOLUME is set to the minimum position. • MUTE is ON. • The SPEAKERS switches are set to OFF. 	<ul style="list-style-type: none"> • Connect them properly referring to "Connecting the speakers". 14 • Adjust the volume to a proper level. • Turn OFF the MUTE. 24 • Set the SPEAKERS switch(es) to ON. 23
The standby indicator blinks and sound is not output.	<ul style="list-style-type: none"> • Speaker cords are short-circuited. 	<ul style="list-style-type: none"> • Turn the power off, eliminate the short-circuiting, then turn on the power again.
Sound is not output from one of the speakers.	<ul style="list-style-type: none"> • The speaker cord is disconnected. 	<ul style="list-style-type: none"> • Connect it properly referring to "Connecting the speakers". 14
Sound is not output from the surround speakers and / or the center speaker, or their sound is very small.	<ul style="list-style-type: none"> • The surround speaker cords and/or the center speaker cord is disconnected. • A surround mode has not been engaged. • The surround and/or center volume controls are set to the minimum level. 	<ul style="list-style-type: none"> • Connect it properly referring to "Connecting the speakers". 14 • Select a surround mode. • Adjust the speaker levels using the test tone. 22
A humming noise is generated when the PHONO input selector is selected.	<ul style="list-style-type: none"> • The audio cord from the turntable is not connected to the PHONO jacks. • The turntable is not grounded. 	<ul style="list-style-type: none"> • Insert the audio cord plugs securely into the PHONO jacks. • Connect the grounding wire to the GND terminal on the rear panel.
When playing a Dolby Digital source signal using a DVD player, the sound is cut off soon after it starts.	<ul style="list-style-type: none"> • There are many possible causes for this problem, depending on the type of DVD player used. 	<ul style="list-style-type: none"> • Set the input mode to digital manual before starting playback of the Dolby Digital source. 8
No sound is produced during playback from a DVD player.	<ul style="list-style-type: none"> • The input mode is set to digital manual. 	<ul style="list-style-type: none"> • Press the INPUT MODE key to select to digital auto mode. 8
A video source cannot be recorded normally.	<ul style="list-style-type: none"> • The software is copy-guarded. 	<ul style="list-style-type: none"> • Copy-guarded video software cannot be recorded.

Tuner

Symptom	Cause	Remedy
Radio stations cannot be received.	<ul style="list-style-type: none"> • No antenna is connected. • The broadcast band is not set properly. • The frequency of the desired station is not tuned. 	<ul style="list-style-type: none"> • Connect an antenna. 18 • Set the broadcast band properly. • Tune the frequency of the desired station. 26
Interference.	<ul style="list-style-type: none"> • Noise due to ignition noise from an automobile. • Noise due to interference from an electric appliance. • Noise due to a nearby TV set. 	<ul style="list-style-type: none"> • Install the outdoor antenna away from the road. • Turn off the power to the appliance. • Install the receiver farther away from the TV.
A station which was preset cannot be received by pressing the corresponding numeric key.	<ul style="list-style-type: none"> • The preset station belongs to a frequency that cannot be received. • The preset memory was cleared because the power cord had been unplugged for a long period of time. 	<ul style="list-style-type: none"> • Preset a station with a receivable frequency. • Preset the station again.

Remote control unit

Symptom	Cause	Remedy
Subwoofer volume cannot be adjusted.	<ul style="list-style-type: none"> Subwoofer is OFF. 	<ul style="list-style-type: none"> Turn the subwoofer ON. → 21
Remote control operation is not possible.	<ul style="list-style-type: none"> The remote control is set to a different operation mode. Batteries are exhausted. The remote control unit is too far away from the main system, controlling angle is too large, or there is an obstacle between the receiver and the remote. The audio cords and system control cords are not connected properly. No software is loaded in the source component. An attempt is made to play a tape which is being recorded in the cassette deck. The remote control has not been set to the operation mode for the component you wish to control. The microprocessor of the remote control mal-functions. 	<ul style="list-style-type: none"> Press the source keys or source POWER keys to select the appropriate operation mode. Replace with new batteries. → 20 Operate the remote control unit within the controllable range. Connect properly referring to "Setting up the system". → 8 Place software in the source component you want to play. Wait until recording has completed. Press the source select keys or source POWER keys to activate the operation mode for the component you want to control before operation → 35 Reset the microprocessor. → 49

AUDIO section

Rated power output during STEREO operation

110 watts per channel minimum RMS, both channels driven, at 8 Ω from 20 Hz to 20 kHz with no more than 0.7% total harmonic distortion. (FTC)

Effective power output during SURROUND operation

FRONT (1kHz, 10% T.H.D. at 8 Ω one channel driven)	150 W + 150 W
CENTER (1kHz, 10% T.H.D. at 8 Ω one channel driven)	150 W
SURROUND (1kHz, 10% T.H.D. at 8 Ω one channel driven)	150 W + 150 W
Total harmonic distortion	0.05% (1 kHz, 55W, 8 Ω)
Frequency response	CD 10 Hz ~ 60 kHz, +0 dB, -3.0 dB
Signal to noise ratio (IHF'66)	PHONO (MM) 75 dB
	CD 92 dB
Input sensitivity / impedance	PHONO (MM) 4 mV / 27 kΩ
	CD 300 mV / 47 kΩ
	MONITOR IN 300 mV / 47 kΩ
	DVD/6CH INPUT 300 mV / 47 kΩ
Output level / impedance	TAPE REC 300 mV / 1 kΩ
	MONITOR OUT 300 mV / 1 kΩ
	PRE OUT (FRONT, CENTER, SURROUND) 1 V / 500 Ω
	PRE OUT (SUBWOOFER) 1.8 V / 500 Ω
Tone control	BASS ±10 dB (at 70 Hz)
	TREBLE ±10 dB (at 10 kHz)

DIGITAL AUDIO section

Sampling frequency	32 kHz, 44.1 kHz, 48 kHz, 96kHz
Input level / impedance / wave length	Optical (-15 dBm ~ - 21 dBm), 660 nm ±30nm
	Coaxial 0.5 Vp-p / 75 Ω

VIDEO section

VIDEO inputs / outputs

VIDEO (composite)	1 Vp-p / 75 Ω
S VIDEO (luminance signal)	1 Vp-p / 75 Ω
(chrominance signal)	0.286 Vp-p / 75 Ω
COMPONENT VIDEO (luminance signal)	1 Vp-p / 75 Ω
(C _B /C _R -signal)	+/- 0.324 Vp-p / 75 Ω

FM tuner section

Tuning frequency range	87.5 MHz ~ 108 MHz
Usable sensitivity (MONO)	1.6 μV (75 Ω) / 15.2 dBf (75 kHz DEV., SINAD 30 dB)
50dB quieting sensitivity	STEREO 28 μV (75 Ω) / 40.2 dBf
Total harmonic distortion (1 kHz)	MONO 0.5% (65 dBf input)
	STEREO 0.7% (65 dBf input)
Signal to noise ratio (1 kHz, 75 kHz DEV.)	MONO 75 dB (65 dBf input)
	STEREO 68 dB (65 dBf input)
Stereo separation (1 kHz)	40 dB
Selectivity (±400 kHz)	50 dB
Frequency response	(30 Hz ~ 15kHz), +0.5 dB, -3.0 dB

AM tuner section

Tuning frequency range	531 kHz ~ 1,602 kHz
9 kHz step	530 kHz ~ 1,610 kHz
10 kHz step	530 kHz ~ 1,610 kHz
Usable sensitivity (30% mod., S/N 20 dB)	16 μV / (600 μV/m)
Signal to noise ratio (30% mod. 1 mV input)	50 dB

GENERAL

Power consumption	270 W
AC outlet	SWITCHED (total 90 W max.)
Dimensions	W : 440 mm
	H : 144 mm
	D : 399 mm
Weight (Net)	10.25 kg

Notes

1. KENWOOD follows a policy of continuous advancements in development. For this reason specifications may be changed without notice.
2. The full performance may not be exhibited in an extremely cold location (under a water-freezing temperature).

KENWOOD

For your records

Record the serial number, found on the back of the unit, in the spaces designated on the warranty card, and in the space provided below. Refer to the model and serial numbers whenever you call upon your dealer for information or service on this product.

Model _____ Serial Number _____

Free Manuals Download Website

<http://myh66.com>

<http://usermanuals.us>

<http://www.somanuals.com>

<http://www.4manuals.cc>

<http://www.manual-lib.com>

<http://www.404manual.com>

<http://www.luxmanual.com>

<http://aubethermostatmanual.com>

Golf course search by state

<http://golfingnear.com>

Email search by domain

<http://emailbydomain.com>

Auto manuals search

<http://auto.somanuals.com>

TV manuals search

<http://tv.somanuals.com>