

KENWOOD

AUDIO VIDEO SURROUND RECEIVER

VR-9080 KRF-X9090D

INSTRUCTION MANUAL

Kenwood Corporation

This instruction manual is for some models. Model availability and features (functions) may differ depending on the country and sales area.

About the supplied remote control

Compared to standard remote controls, the remote control supplied with this receiver has several operation modes. These modes enable the remote control to control other audio/video components. In order to effectively use the remote control, it is important to read the operating instructions and obtain a proper understanding of the remote control and how to switch its operation modes (etc.).

Using the remote control without completely understanding its design and how to switch the operation modes may result in incorrect operations.



6CH INPUT

Before applying the power

⚠ Caution : Read this page carefully to ensure safe operation.

Units are designed for operation as follows.

U.S.A. and Canada **AC 120 V only**
Australia **AC 240 V only**
Europe **AC 230 V only**
Other countries **AC 110-120 / 220-240 V switchable***

* AC voltage selection

The AC voltage selector switch on the rear panel is set to the voltage that prevails in the area to which the unit is shipped. Before connecting the power cord to your AC outlet, make sure that the setting position of this switch matches your line voltage. If not, it must be set to your voltage in accordance with the following direction.

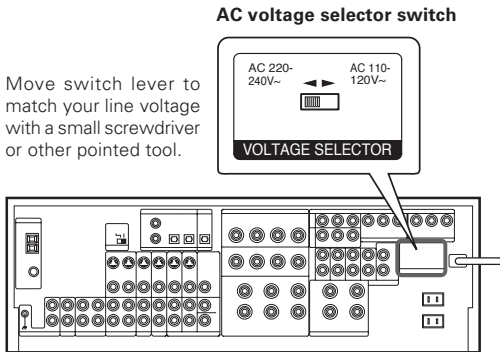

Note :
Our warranty does not cover damage caused by excessive line voltage due to improper setting of the AC voltage selector switch.

Safety precautions

WARNING :

TO PREVENT FIRE OR ELECTRIC SHOCK, DO NOT EXPOSE THIS APPLIANCE TO RAIN OR MOISTURE.



CAUTION

**RISK OF ELECTRIC SHOCK
DO NOT OPEN**



CAUTION: TO REDUCE THE RISK OF ELECTRIC SHOCK, DO NOT REMOVE COVER (OR BACK). NO USER-SERVICEABLE PARTS INSIDE. REFER SERVICING TO QUALIFIED SERVICE PERSONNEL.



THE LIGHTNING FLASH WITH ARROWHEAD SYMBOL, WITHIN AN EQUILATERAL TRIANGLE, IS INTENDED TO ALERT THE USER TO THE PRESENCE OF UNINSULATED "DANGEROUS VOLTAGE" WITHIN THE PRODUCT'S ENCLOSURE THAT MAY BE OF SUFFICIENT MAGNITUDE TO CONSTITUTE A RISK OF ELECTRIC SHOCK TO PERSONS.



THE EXCLAMATION POINT WITHIN AN EQUILATERAL TRIANGLE IS INTENDED TO ALERT THE USER TO THE PRESENCE OF IMPORTANT OPERATING AND MAINTENANCE (SERVICING) INSTRUCTIONS IN THE LITERATURE ACCOMPANYING THE APPLIANCE.

How to use this manual

This manual is divided into four sections, Preparations, Operations, Remote Control, and Additional Information.

Preparations

Shows you how to connect your audio and video components to the receiver and prepare the surround processor.

Since this receiver works with all your audio and video components, kindly follow the instructions in this manual for the correct connections.

Operations

Shows you how to operate the various functions available on the receiver.

Remote Control

Shows you how to operate other components using the remote control, as well as a detailed explanation of all remote control operations. Once you have registered your components with the proper setup codes, you'll be able to operate both this receiver and your other AV components (TV, VCR, DVD player, CD player, etc.) using the remote control supplied with this receiver.

Additional Information

Shows you additional information such as "In case of difficulty" (troubleshooting) and "Specifications".

For the U.S.A.

FCC WARNING

This equipment may generate or use radio frequency energy. Changes or modifications to this equipment may cause harmful interference unless the modifications are expressly approved in the instruction manual. The user could lose the authority to operate this equipment if an unauthorized change or modification is made.

NOTE:

This equipment has been tested and found to comply with the limits for a Class B digital device, pursuant to Part 15 of the FCC Rules. These limits are designed to provide reasonable protection against harmful interference in a residential installation. This equipment may cause harmful interference to radio communications, if it is not installed and used in accordance with the instructions. However, there is no guarantee that interference will not occur in a particular installation. If this equipment does cause harmful interference to radio or television reception, which can be determined by turning the equipment off and on, the user is encouraged to try to correct the interference by one or more of the following measures:

- Reorient or relocate the receiving antenna.
- Increase the separation between the equipment and receiver.
- Connect the equipment into an outlet on a circuit different from that to which the receiver is connected.
- Consult the dealer or an experienced radio / TV technician for help.

For the U.S.A.

Note to CATV system installer



This reminder is provided to call the CATV system installer's attention to Article 820-40 of the NEC that provides guidelines for proper grounding and, in particular, specifies that the cable ground shall be connected to the grounding system of the building, as close to the point of cable entry as practical.



As an ENERGY STAR® Partner, Kenwood Corporation has determined that this product meets the ENERGY STAR® guidelines for energy efficiency. This product can save energy. Saving energy reduces air pollution and lowers utility bills.

Contents

Caution : Read the pages marked  carefully to ensure safe operation.

 Before applying the power	2
 Safety precautions	2
How to use this manual	2
Unpacking	4
Preparing the remote control	4
Special features	5
Names and functions of parts	6
Main unit	6
Remote control unit	7

Preparations	Setting up the system	8
	Connecting the terminals	9
	Connecting a DVD player (6-channel input)	10
	Connecting audio components	11
	Connecting video components	12
	Digital connections	13
	Connecting video components (COMONENT VIDEO)	14
	Connecting the speakers	15
	PRE OUT connections	16
	Connecting to another room (ROOM B)	17
	Connecting the external IR Receiver (For VR-9080)	18
	Connecting to the AV AUX jacks	19
	Connecting the antennas	19
	Preparing for surround sound	20
	Before setting up the speakers	20
	Setting up the speakers automatically (AUTO SETUP) "Kenwood Room Acoustic Calibration"	21
	Setting up the speakers manually (MANUAL SETUP)	23
	Other settings	25

Operations	Normal playback	27
	Preparing for playback	27
	Listening to a source component	27
	Input level adjustment (analog sources only) ..	28
	Adjusting the sound	28
	Recording	30
	Recording audio (analog sources)	30
	Recording audio (digital sources)	30
	Recording video	30
	Listening to radio broadcasts	31
	Tuning radio stations	31
	Presetting radio stations manually	31
	Receiving preset stations	32
	Receiving preset stations in order (P.CALL) ...	32
	Ambience effects	33
	Surround modes	33
	Surround play	36
	Virtual modes	38
DVD 6-channel playback	38	
Adjusting the sound	39	
Convenient functions	41	
Display dimmer adjustment	41	
Sleep timer	41	

Remote Control	Basic remote control operations for other components	42
	Registering setup codes for other components	42
	Searching for your codes	42
	Checking the codes	42
	Re-assigning device keys	43
	Operating other components	43
	Storing the remote control code of the other components	44
	Setup code chart	45
	Other components' operations	49

Additional Information	In case of difficulty	53
	 Specifications	55

Maintenance of the unit



When the front panel or case becomes dirty, wipe with a soft, dry cloth. Do not use thinner, benzine, alcohol, etc. for these agents may cause discoloration.

In regard to contact cleaner

Do not use contact cleaners because it could cause a malfunction. Be specially careful not to use contact cleaners containing oil, for they may deform the plastic component.

Unpacking

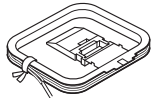
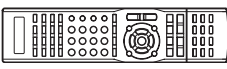
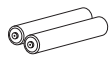
Unpack the unit carefully and make sure that all accessories are present.

FM indoor antenna (1) (For VR-9080)	AM loop antenna (1) (For KRF-X9090D)
	
Remote control unit (1) RC-R0918	Batteries (R03/AAA) (2)
	
Microphone for SETUP (1) (Cord length: approx. 5m (16 feet))	*AC plug adapter (1) (For KRF-X9090D)
	
*Use to adapt the plug on the power cord to the shape of the wall outlet. (Accessory only for regions where use is necessary.)	

If any accessories are missing, or if the unit is damaged or fails to operate, notify your dealer immediately. If the unit was shipped to you directly, notify your shipper immediately. Kenwood recommends that you retain the original carton and packing materials in case you need to move or ship the unit in the future.

Keep this manual handy for future reference.

Channel space switching (Except for the U.S.A., Canada and Australia)

The space between radio channels has been set to the one that prevails in the area to which the system is shipped. However, if the current channel space setting does not match the setting in the area where the system is to be used, for instance when you move from area 1 or area 2 shown in the following table or vice versa, proper reception of AM/FM broadcasts cannot be expected. In this case, change the channel space setting in accordance with your area by referring to the following table.

Area	CHANNEL Space Frequency
1. U.S.A., Canada and South American countries	FM: 100 kHz AM: 10 kHz
2. Other countries	FM: 50 kHz AM: 9 kHz

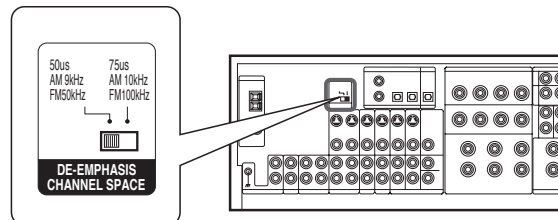

Turn the power OFF by pressing the POWER key before moving the switch level. Move the switch lever to match your area with a small screwdriver or other pointed tool, then turn the power ON again.

Preparing the remote control

Loading the batteries

1 Remove the cover.

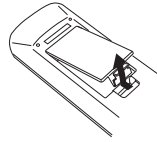

2 Insert the batteries.

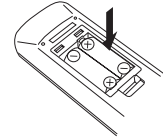

3 Close the cover.

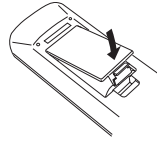

• Insert two AAA-size (R03) batteries as indicated by the polarity markings.

Operation

When the standby indicator is lit, the power turns ON when you press the **RECEIVER ON** key on the remote control. When the power comes ON, press the key you want to operate.

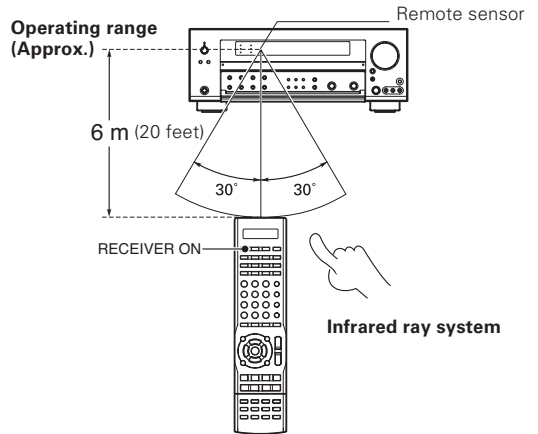

• When pressing more than one remote control key successively, press the keys securely by leaving an interval of 1 second or more between keys.

Notes

- The supplied batteries may have shorter lives than ordinary batteries due to use during operation checks.
- When the remote-controllable distance gets shorter than before, replace both batteries with new ones.
- Placing the remote sensor in direct sunlight, or in direct light from a high frequency fluorescent lamp may cause malfunction. In such a case, change the location of the system installation to prevent malfunction.

Special features

True home theater sound

— 33

This receiver incorporates a wide variety of surround modes to bring you maximum enjoyment from your video software and audio source. Select a surround mode according to your equipment or the software you are going to play and enjoy!

- THX Select2 Cinema
- THX MusicMode
- THX Games
- THX Surround EX
- Dolby Digital EX
- Dolby Pro Logic IIx
- Dolby Digital
- Dolby Virtual Speaker
- Dolby Headphone
- DTS-ES
- DTS Neo:6
- DTS 96/24
- DTS
- DSP Mode

Kenwood Room Acoustic Calibration

— 21

Without going through a complicated manual setup procedure, this function automatically measures the capacity of your speaker system, speaker layout and acoustic specifications of your listening room correctly with the provided microphone, and provides the best listening environment.

ACTIVE EQ

— 28

ACTIVE EQ mode will produce a more dynamic sound quality in any condition. You can enjoy a more impressive sound effect when ACTIVE EQ is turned on.

GAME mode function

— 27

When you connect a game machine to the **AV AUX** jacks on the front panel, the input selector of the receiver switches automatically to **"GAME"** and the optimum sound field for enjoying games is set.

This feature improves your convenience in playing video games.

Universal IR (Infrared) remote control

In addition to the basic receiver, the remote control supplied with this receiver can also operate almost all of your remote controllable audio and video components. Just follow the simple setup procedure to register the components you have connected.

Video up conversion

This receiver can convert the incoming composite video signals to S-Video signal.

If your monitor TV has S-Video jacks, it is not necessary to do the composite video connections, just use an S-Video cord to connect the receiver and your monitor TV.

Names and functions of parts

Main unit

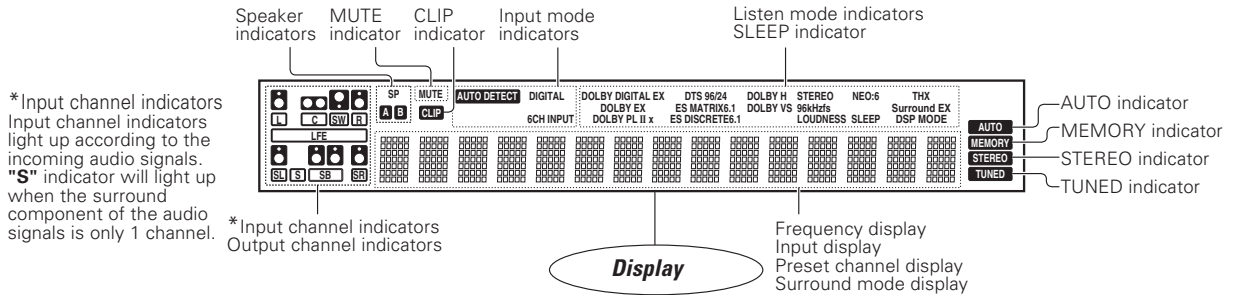

The figure is the view when the front cover is open.

- | | | |
|---|---|---|
| <p>1 POWER ON/OFF key (For KRF-X9090D) Use to turn the main power ON/OFF. [20]</p> <p>2 (POWER ON/STANDBY) key Use to turn the power ON/STANDBY. [20]</p> <p>3 SPEAKERS A/B keys Use to turn the A/B speakers on or off. [27]</p> <p>4 Surround LED (light-emitting diode) indicators</p> <p>THX indicator [36]
Lights when the THX mode has been chosen. THX mode may or may not be activated depending upon the applicable playback mode.</p> <p>96kHz fs indicator [40]
Lights when the receiver is in the 96kHz LPCM playback mode.</p> <p>ACTIVE EQ indicator [28]
Lights when the receiver is in the ACTIVE EQ mode.</p> <p>DOLBY DIGITAL indicator [36]
Lights when the receiver is in the Dolby Digital mode.</p> <p>DTS indicator [37]
Lights when the receiver is in the DTS mode.</p> <p>DSP indicator [37]
Lights when the receiver is in the DSP mode.</p> | <p>5 INPUT SELECTOR key Use to select input sources. [27]</p> <p>6 VOLUME CONTROL knob [27]</p> <p>7 SETUP MIC jack Use for SETUP MIC. [20]</p> <p>8 PHONES jack Use for headphone listening. [29]</p> <p>9 THX key Use to switch the status of THX. [36]</p> <p>DOLBY VIRTUAL key Use to select the Dolby Virtual Speaker and the Dolby Headphone setting. [38]</p> <p>STEREO key Use to switch the listen mode to STEREO. [37]</p> <p>INPUT MODE key Use to select the Input mode. [8]</p> <p>BASS BOOST key Use to select BASS BOOST setting. [29]</p> <p>DSP key Use to select any of the DSP mode. [37]</p> <p>ACTIVE EQ key Use to select ACTIVE EQ setting. [28]</p> <p>DIMMER key Use to adjust the brightness of the display. [41]</p> <p>Use to select the REC MODE. [30]</p> | <p>10 SOUND key Use to adjust the sound quality and the ambience effects. [39]</p> <p>TONE key Use to switch the status of TONE control. [29]</p> <p>BAND key Use to select the broadcast band. [31]</p> <p>AUTO/MONO key Use to select the auto or manual tuning mode. [31]</p> <p>17 SETUP key Use to select the speakers' settings etc. [20]</p> <p>MEMORY/ENTER key Use to store radio stations in the preset memory. [31]</p> <p>Use to establish a selection.</p> <p>12 ▲/▼ keys Use for selection adjustments during sound, setup and preset channel functions. [20]</p> <p>13 MULTI CONTROL knob Use to control a variety of settings. [36]</p> <p>14 LISTEN MODE knob Use to select the listening mode. [36]</p> <p>15 AV AUX/GAME key Use to switch the input to AV AUX or GAME. [19] [27]</p> <p>16 AV AUX (S VIDEO, VIDEO, L-AUDIO-R) jacks [19]</p> |
|---|---|---|

Standby mode

While the standby indicator is lit, a small amount of power is supplied to the system to back up the memory. This is called standby mode. Under the condition, the system can be turned ON by remote control unit.

CAUTION

The power in this equipment will not be completely cut off from the AC wall outlet when the main switch is turned OFF.

Remote control unit

This remote control unit can be used not only for Kenwood products but also for other non-Kenwood products by setting the appropriate manufacturer's setup codes. - 42

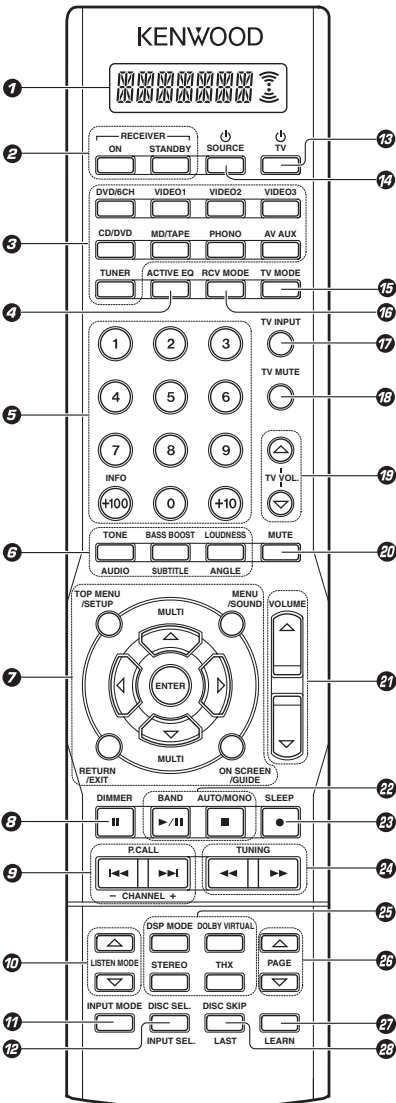

- 1 LCD (Liquid Crystal Display)** - 42
Shows the operation mode of the remote control unit.
- 2 RECEIVER ON key** - 20
Use to turn the receiver on.
RECEIVER STANDBY key
Use to turn the receiver off (standby).
- 3 Input Selector keys (DVD/6CH, VIDEO 1, VIDEO 2, VIDEO 3, CD/DVD, MD/TAPE, PHONO, AV AUX, TUNER)** - 27
Use to select the input sources.
Source keys (DVD/6CH, VIDEO 1, VIDEO 2, VIDEO 3, CD/DVD, MD/TAPE, PHONO, AV AUX, TUNER) - 42 - 44
Use to operate the registered components.
- 4 ACTIVE EQ key** - 28
Use to select ACTIVE EQ setting.
- 5 Numeric keys** - 42
Use to input numeric characters. - 32
Use to select preset radio stations. - 29
Use to operate other components.
- 6 TONE key** - 29
Use to switch the status of TONE control.
BASS BOOST key - 29
Use to select the maximum adjustment setting for the low frequency range.
LOUDNESS key - 29
Use to switch the status of LOUDNESS.
- AUDIO key**
SUBTITLE key
ANGLE key
Use to operate other components.
- 7 MULTI $\Delta/\nabla/\triangleleft/\triangleright$ keys** - 31
Use to control a variety of settings. - 31
Use to operate other components.
- 8 TOP MENU key**
MENU key
RETURN key
EXIT key
ON SCREEN key
GUIDE key
Use to operate other components.
- 9 ENTER key** - 20
Use to establish a selection. - 39
Use to operate other components.
- 10 SETUP key** - 41
Use to select the speakers' settings etc.
- 11 SOUND key** - 39
Use to adjust the sound quality and the ambience effects.
- 12 DIMMER key** - 41
Use to adjust the brightness of the display.
- 13 II key** - 41
Use to operate other components.
- 14 P.CALL $\triangleleft/\triangleright$ keys** - 32
Use for selection adjustments during sound, set up and preset channel functions.
CHANNEL -/+ keys
Use to select the channels.
- 15 LISTEN MODE Δ/∇ keys** - 36
Use to select the listening mode.
- 16 INPUT MODE key** - 8
Use to select the Input mode.
- 17 DISC SEL. key**
INPUT SEL. key
Use to operate other components.
- 18 TV key** - 27
Use to turn the TV on or off.
- 19 SOURCE key** - 27
Use to turn the other source components on or off.
- 20 TV MODE key** - 27
Use to select the TV equipment.
- 21 RCV MODE key** - 27
Use to switch the remote control unit to the receiver control mode.
- 22 TV INPUT key** - 27
Use to select TV's input.
- 23 TV MUTE key** - 27
Use to temporarily mute the TV sound.
- 24 TV VOL. Δ/∇ keys** - 27
Use to adjust the TV's volume.
- 25 MUTE key** - 29
Use to temporarily mute the sound.
- 26 VOLUME Δ/∇ keys** - 27
Use to adjust the receiver's volume.
- 27 BAND key** - 31
Use to select the broadcast band.
►/II key
Use to operate the DVD, CD, MD or VCR component.
- 28 AUTO/MONO key** - 31
Use to select the auto or manual tuning mode.
■ key
Use to operate the DVD, CD, MD or VCR component.
- 29 SLEEP key** - 41
Use to set the Sleep timer.
- 30 ● key** - 31
Use to operate the MD or VCR components.
- 31 TUNING $\triangleleft/\triangleright$ keys** - 37
Use to tune the broadcast station.
- 32 DSP MODE key** - 37
Use to select any of the DSP mode.
- 33 DOLBY VIRTUAL key** - 38
Use to select the Dolby Virtual Speaker and the Dolby Headphone setting.
- 34 STEREO key** - 37
Use to switch the listen mode to STEREO.
- 35 THX key** - 36
Use to switch the status of THX.
- 36 PAGE Δ/∇ keys** - 41
Use to operate other components.
- 37 LEARN key** - 42
Use to register other components. - 44
Use to memorize the operation of the other remote code.
- 38 DISC SKIP key** - 42
LAST key
Use to operate other components.

Setting up the system

Make connections as shown in the following pages. When connecting the related system components, be sure to refer to the instruction manuals supplied with the components you are connecting. Do not connect the power cord to a wall outlet until all connections are completed.

Notes

1. Be sure to insert all connection cords securely. If their connections are imperfect, sound may not be produced or there will be noise interference.
2. Be sure to remove the power cord from the AC outlet before plugging or unplugging any connection cords. Plugging/unplugging connection cords without disconnecting the power cord can cause malfunctions and may damage the unit.

CAUTION

Do not connect power cords from components whose power consumption is larger than what is indicated on the AC outlet at the rear of this unit.

Analog connections

Audio connections are made using RCA pin cords. These cables transfer stereo audio signal in an "analog" form. This means the audio signal corresponds to the actual audio of two channels. These cables usually have 2 plugs on each end, one red for the right channel and one white for the left channel. These cables are usually packed together with the source unit, or are available at your local electronics retailer.

Microcomputer malfunction

If operation is not possible or an erroneous display appears, even though all connections have been made properly, reset the microcomputer referring to "In case of difficulty". -[53]

Memory back up function

Please note that the following items will be deleted from the unit's memory if the power cord is disconnected from the AC outlet for approximately 1 day.

- | | |
|-----------------------------|-----------------------|
| • Power mode | • Speaker settings |
| • Input selector settings | • Input mode setting |
| • Speaker ON/OFF | • Sound mode settings |
| • Volume level | • Broadcast band |
| • BASS, TREBLE, INPUT level | • Frequency setting |
| • TONE ON/OFF | • Preset stations |
| • LOUDNESS ON/OFF | • Tuning mode |
| • Dimmer level | • ACTIVE EQ mode |
| • Listen mode setting | • GAME mode setting |

Input mode settings

CD/DVD, VIDEO 2, VIDEO 3 and DVD/6CH inputs each include jacks for digital audio input and analog audio input.

The initial factory settings for audio signal playback for CD/DVD, DVD/6CH, VIDEO 2 and VIDEO 3 are "FULL AUTO".

After completing connections and turning on the receiver, follow the steps below.

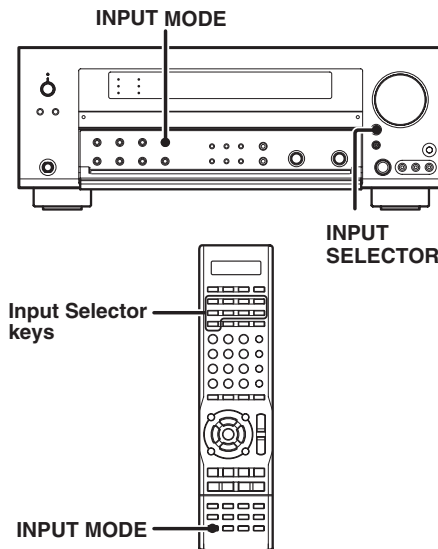

① Use the INPUT SELECTOR key or Input Selector keys to select CD/DVD, VIDEO 2, VIDEO 3 or DVD/6CH.

② Press the INPUT MODE key.

Each press switches the setting as follows:

In DTS play mode

- ① FULL AUTO (digital input, analog input)
- ② DIGITAL MANUAL (digital input)

In CD/DVD, VIDEO 2, VIDEO 3 or DVD/6CH play mode

- ① FULL AUTO (digital input, analog input)
- ② DIGITAL MANUAL (digital input)
- ③ 6CH INPUT (DVD/6CH input only)
- ④ ANALOG (analog input)

Auto detect:

In **FULL AUTO** mode ("AUTO DETECT" indicator lights up), the receiver detects the digital or analog input signals automatically. The receiver will select the input mode and listening mode automatically during playback to match the type of input signal (Dolby Digital, PCM, DTS) and the speaker setting. -[36]

The "DIGITAL" indicator lights up when a digital signal is detected. The "DIGITAL" indicator is extinguished when no digital signal is detected.

Fixed to digital input:

Select this mode if you want to keep the decoding condition (Dolby Digital, DTS, PCM, etc.) in the current listen mode.

When **DIGITAL MANUAL** mode is selected, the set listen modes may be changed automatically depending on the input signal. -[36]

Fixed to analog input:

Select this setting to play analog signals from a VCR, etc.

If the **INPUT MODE** key is pressed quickly, sound may not be produced. Press the **INPUT MODE** key again.

Connecting the terminals

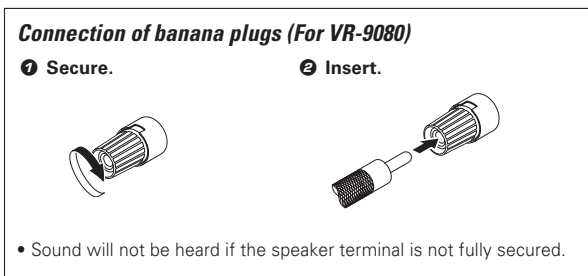
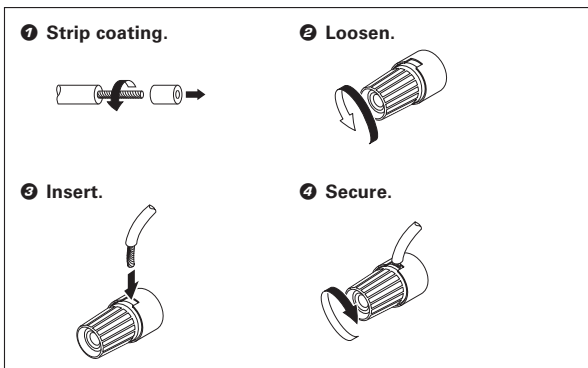

- Never short circuit the + and – speaker cords.
- If the left and right speakers are connected inversely or the speaker cords are connected with reversed polarity, the sound will be unnatural with ambiguous acoustic imaging. Be sure to connect the speakers correctly.

Speaker impedance

After confirming the speaker impedance indications printed on the rear panel of the receiver, connect speakers with matching impedance ratings. Using speakers with a rated impedance other than that indicated on the rear panel of the receiver could result in malfunctions or damage to the speakers or receiver.

Speaker placement

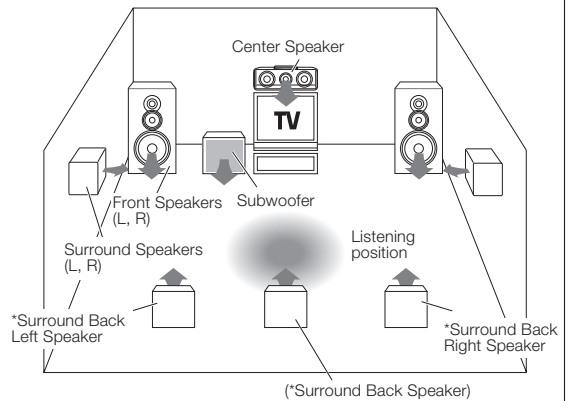

For optimum results, place the Surround Back speakers together for THX Select2 Cinema, THX MusicMode, and THX Games.

*For Surround Back speaker, you may place either two Surround Back speakers (Surround Back Left Speaker and Surround Back Right Speaker) for 7.1 channel surround sound system or one Surround Back Speaker for 6.1 channel surround sound system.

Front (Left and Right) Speakers

Place at the front left and right of the listening position. Front Speakers are required for all surround modes.

Center Speaker

Place front and center. This speaker stabilizes the sound image and helps recreate sound motion.

Surround (Left and Right) Speakers

Place at the direct left and right, or slightly behind, the listening position at even heights, approximately 1 meter above the ears of the listeners. These speakers recreate sound motion and atmosphere.

Subwoofer

Usually, place the subwoofer in the front center position in the listening room, near one of the front speakers near the center speaker. (Since the subwoofer has less directivity than other speakers, it can be placed almost in any position that can offer the best low frequency reproduction according to the room layout.)

Surround Back Speaker/s

Place the surround back speaker behind the listening position, at the same height as the left and right surround speakers.

- Although the ideal surround system consists of all the speakers listed above, if you don't have a Center speaker or a Subwoofer, you can divide those signals between the available speakers in the speaker settings steps to obtain the best possible surround reproduction from the speakers you have available.

Connecting a DVD player (6-channel input)

If you have connected a DVD player to the receiver with digital connection, be sure to read the "Input mode settings" section carefully.

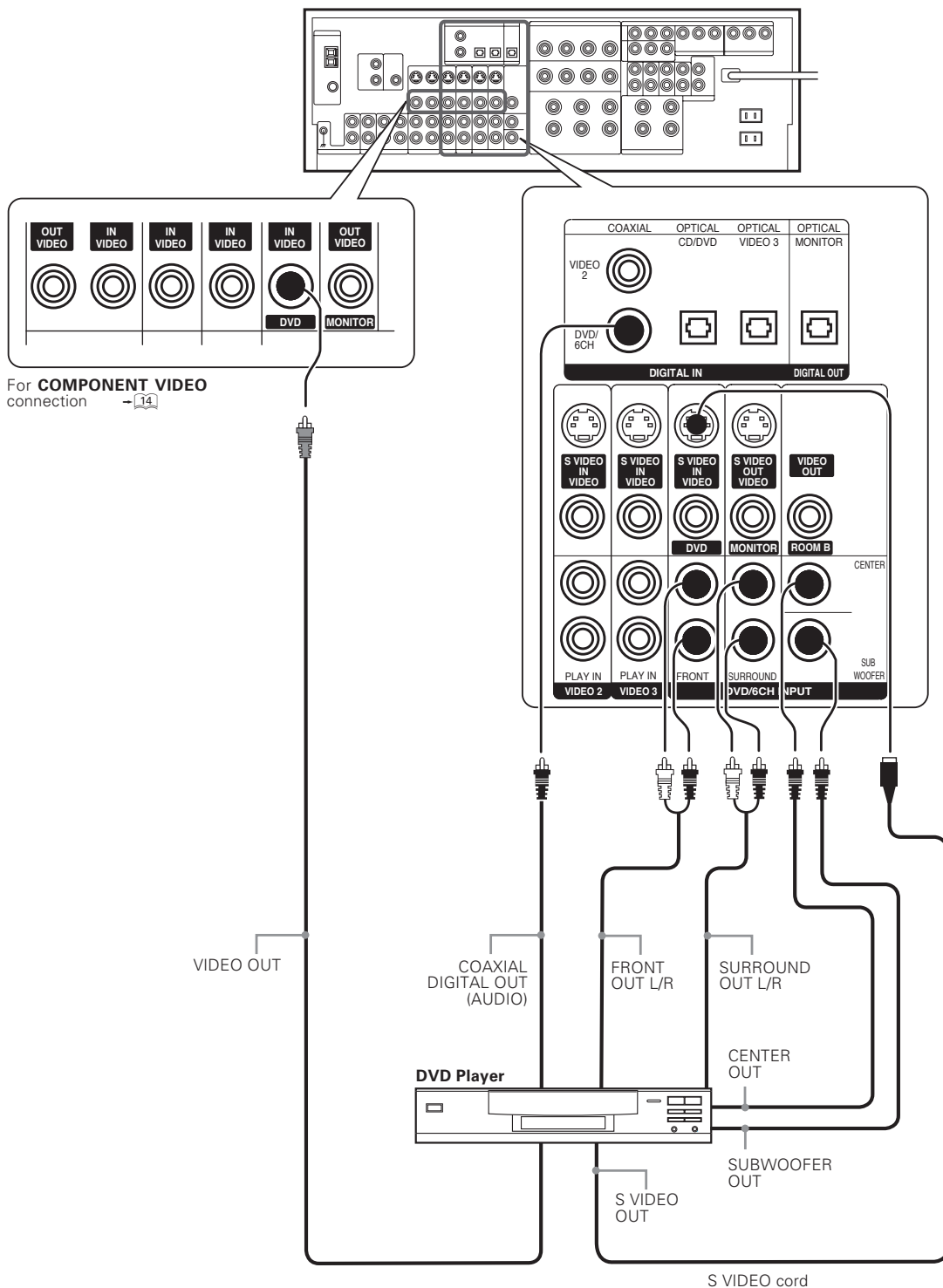

Connecting audio components

- The earth terminal with the ⚡ symbol is used for noise reduction of record player. It is not for safety earth.

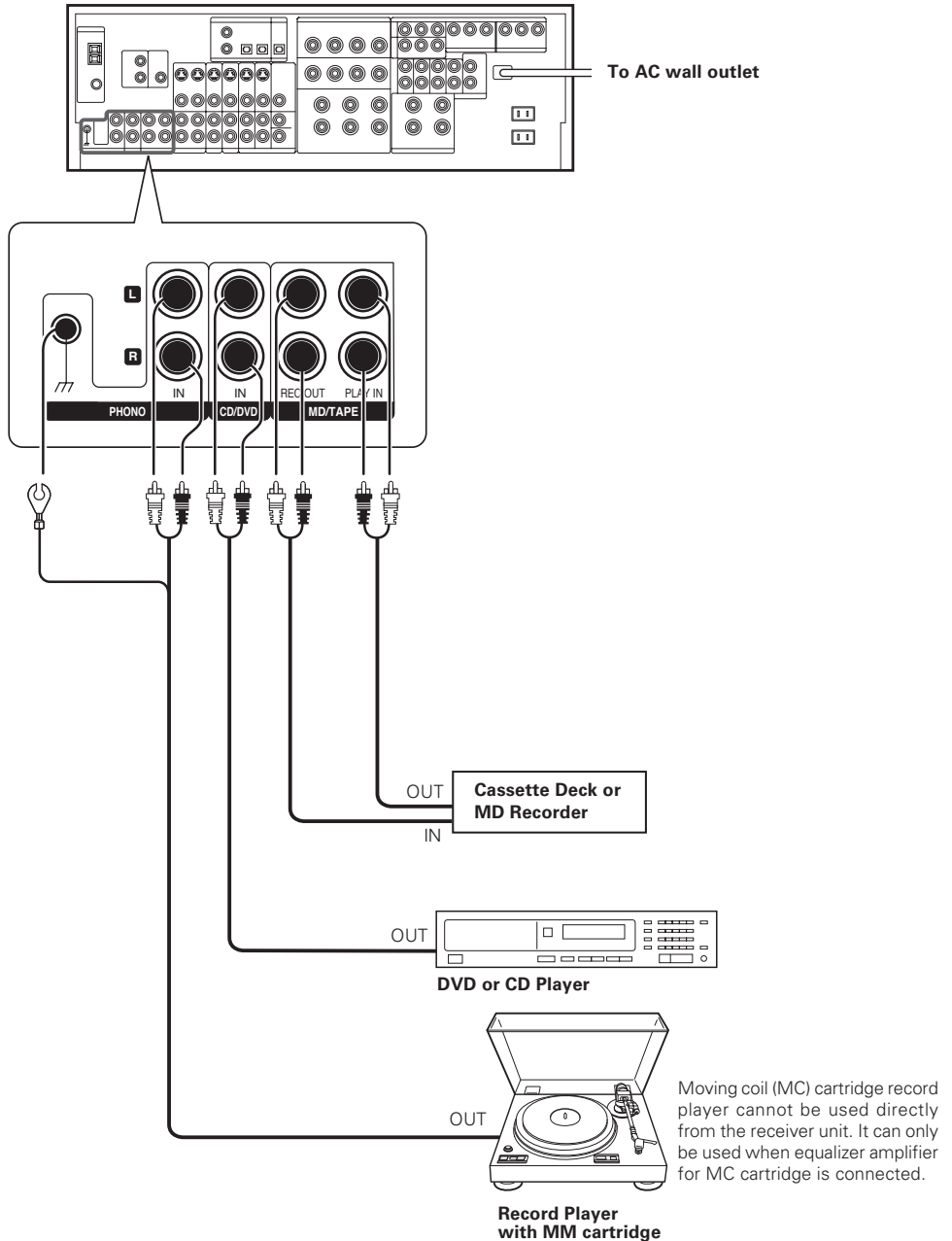

CAUTION

Be sure to adhere to the following, or proper ventilation will be blocked causing damage or fire hazard.

- Do not place any objects impairing heat radiation onto the top of the unit.
- Leave some space around the unit (from the largest outside dimension including projection) equal to or greater than, shown below.

Top panel : 50 cm (20")

Side panel : 10 cm (4")

Back panel : 10 cm (4")

Connecting video components

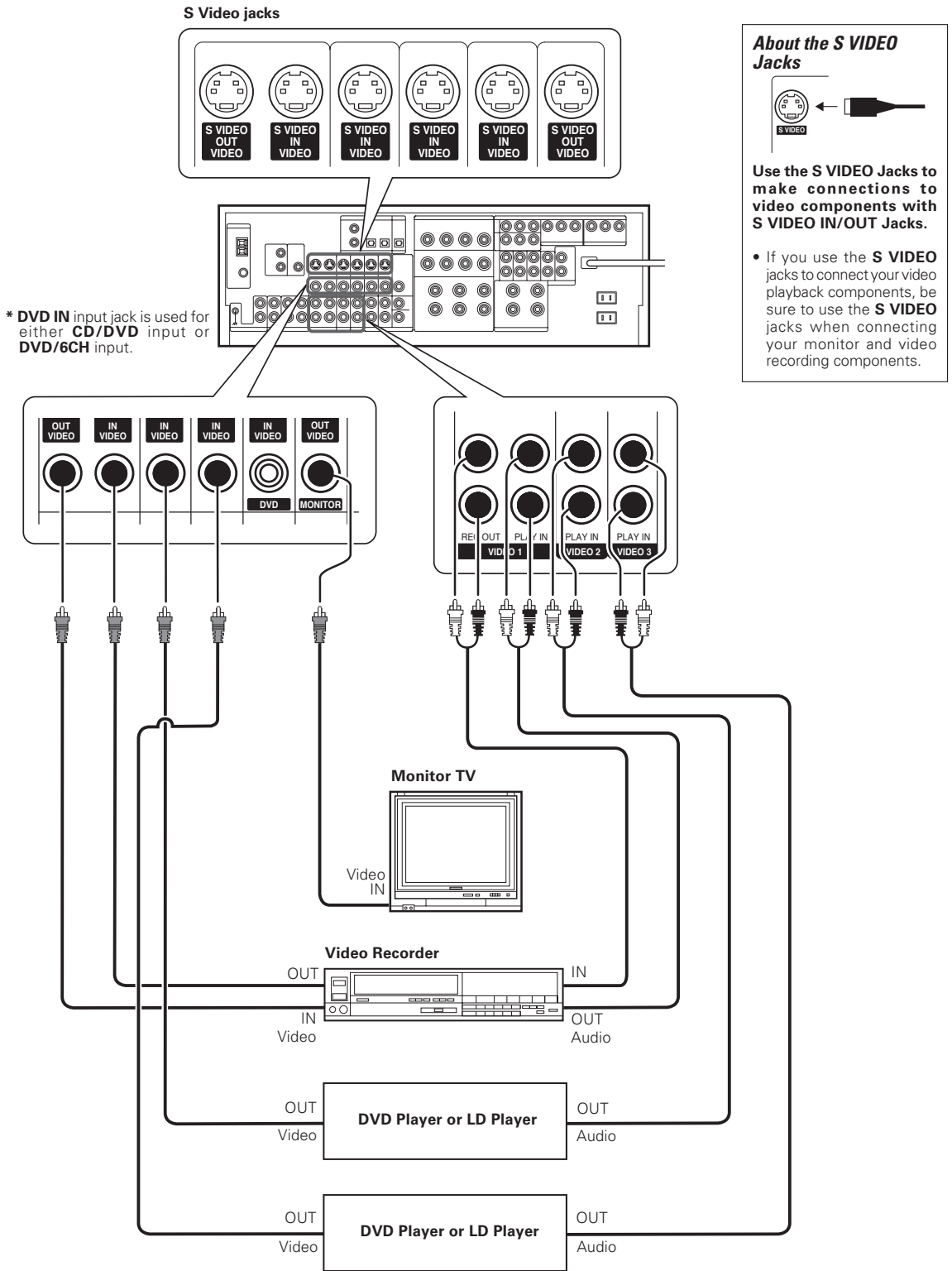

- A video component with digital audio outputs should be connected to the VIDEO 2 or VIDEO 3 jacks.
- For optimum video performance, THX recommends that video pass through (bypass) is used.

Digital connections

The digital in jacks can accept DTS, Dolby Digital, or PCM signals. Connect components capable of outputting DTS, Dolby Digital, or standard PCM (CD) format digital signals.

If you have connected any digital components to the receiver, be sure to read the "Input mode settings" section carefully.

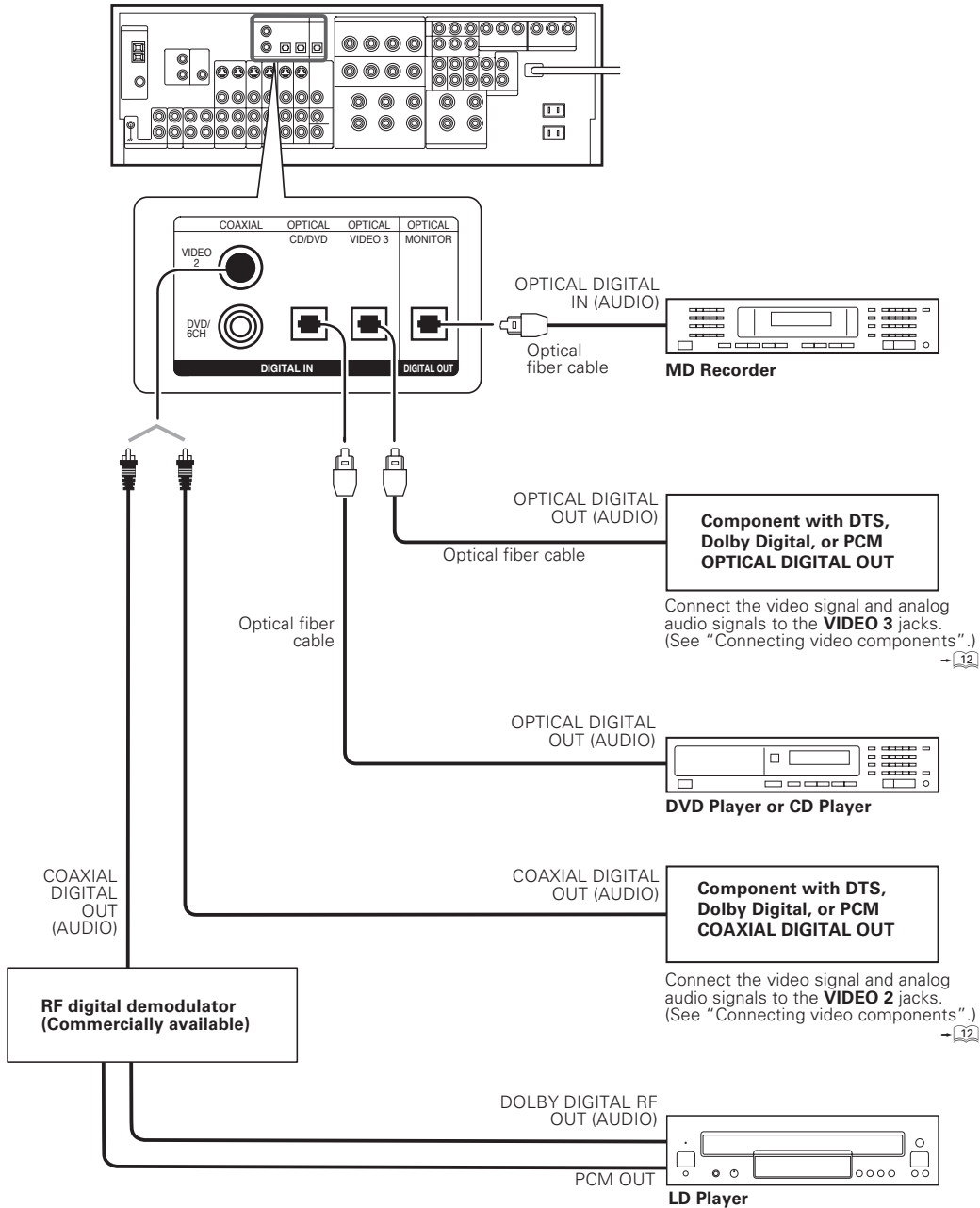

To connect an LD player with a DIGITAL RF OUT, connect the LD player to an RF digital demodulator (commercially available). Next, connect the DIGITAL OUT jack of the demodulator to the DIGITAL IN jack of the receiver. Connect the video signal and analog audio signals to the VIDEO 2 or VIDEO 3 jacks. (See "Connecting video components".)

Connecting video components (COMPONENT VIDEO)

If you have connected the receiver to a video component with COMPONENT jacks, you can get a better picture quality than by connecting to the S-VIDEO jacks.

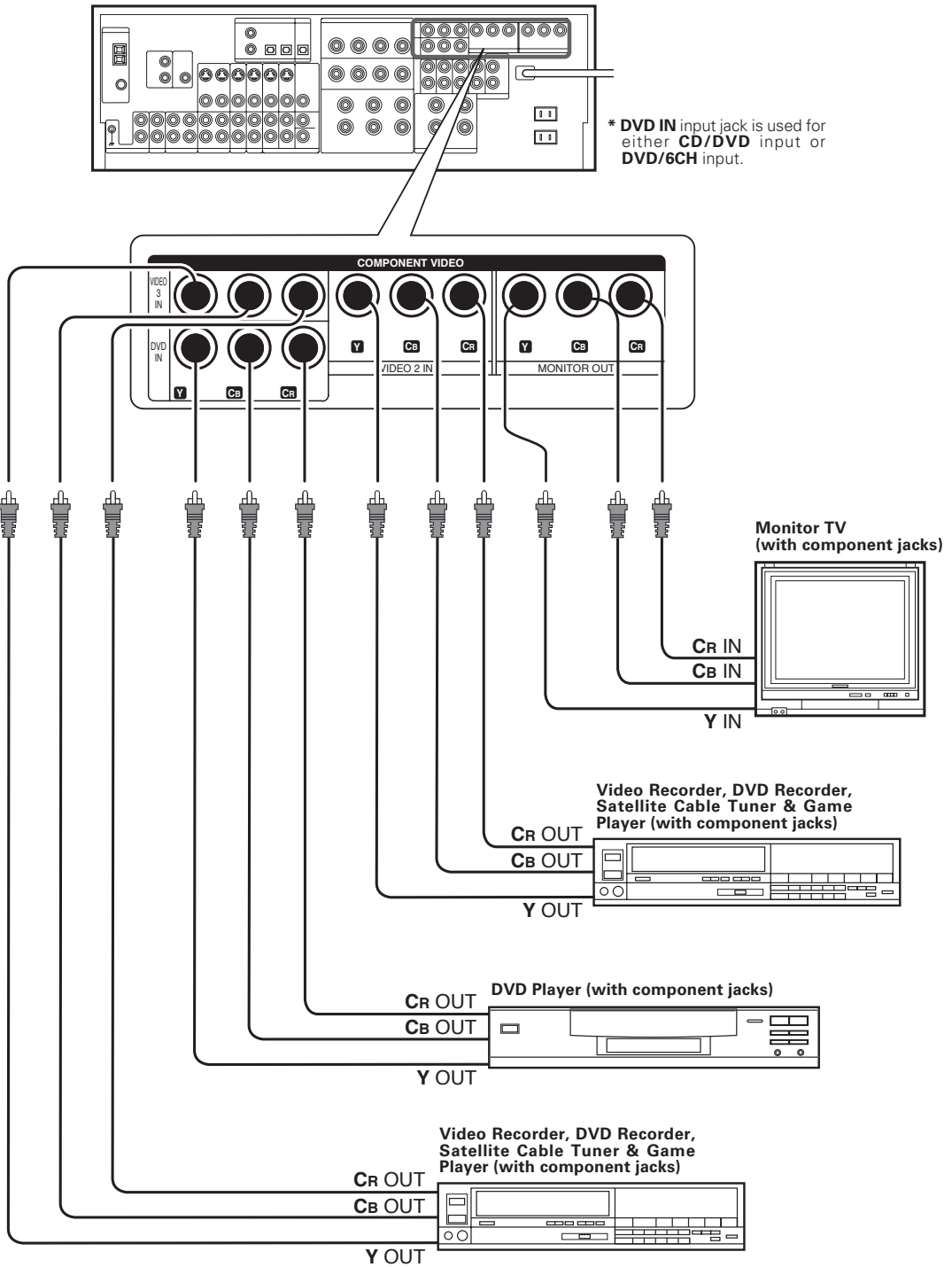

When connecting the TV to the COMPONENT jacks, be sure to connect all the other components to the COMPONENT jacks.

Connecting the speakers

Surround Back Speaker/s

When connecting a single Surround Back Speaker, connect it to SURROUND BACK L terminals and select "SB LARGEx1" or "SB NML/THXx1" at Speaker settings. - [24]

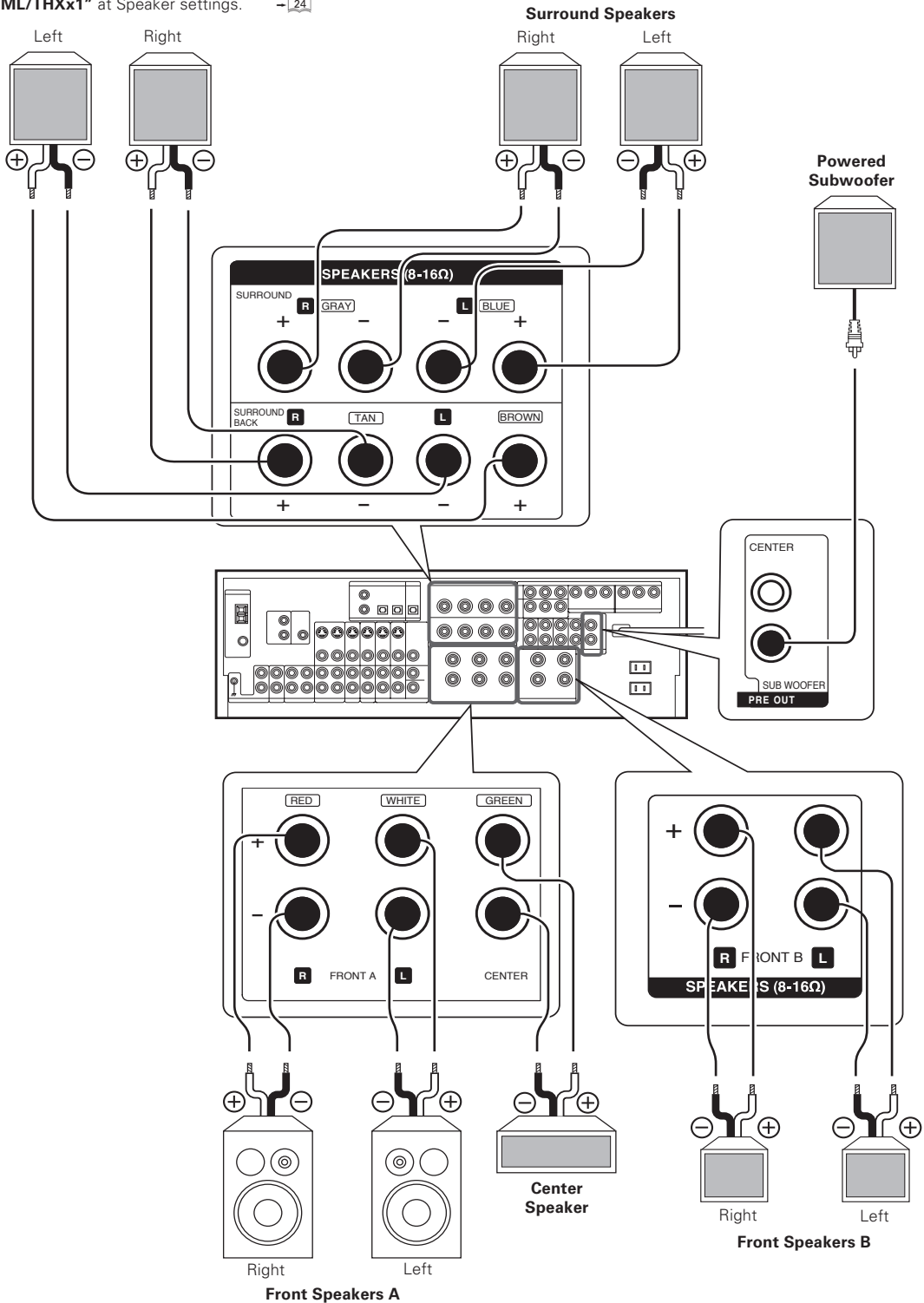

- To make sure that each speaker has been connected properly, pay attention to the test tone from each speaker. Refer to "[24] Adjust the speaker volume level."
- When you wish to connect the second pair of FRONT speakers or to connect the speakers in a different room to this unit, use the SPEAKERS FRONT B terminals for connection.

PRE OUT connections

This receiver has additional **PRE OUT** jacks. These can be used for various purposes, but will need to be connected to an external power amplifier as shown in the example below.

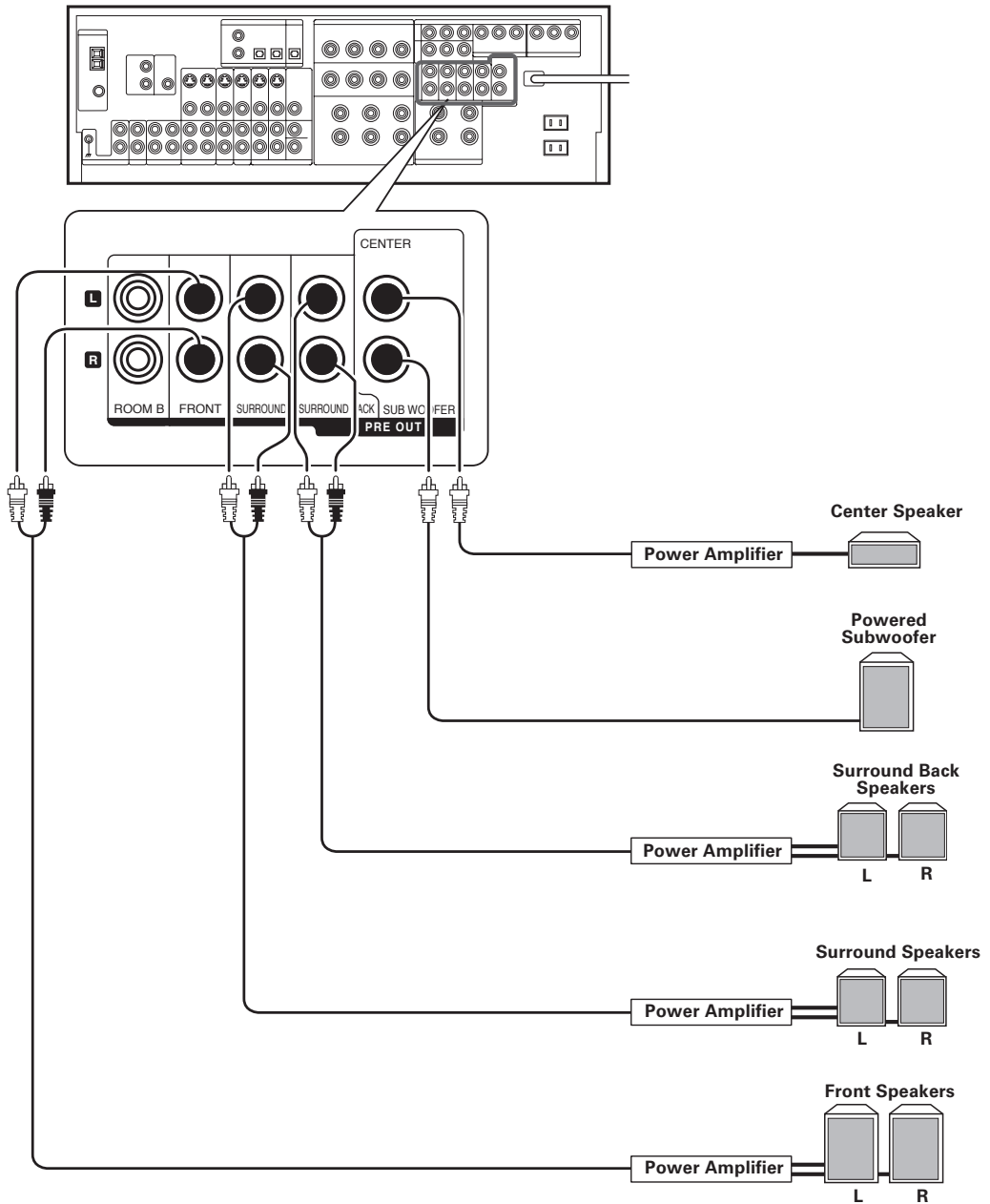

- Connecting a speaker cord directly to a **PRE OUT** jack will not produce any sound from the speaker.
- To use the **PRE OUT** jacks, press only the **SPEAKERS A** key to the ON position. - 27

Connecting to another room (ROOM B)

This connection allows you to connect your main system to a monitor TV and speaker system located in another area (ROOM B).

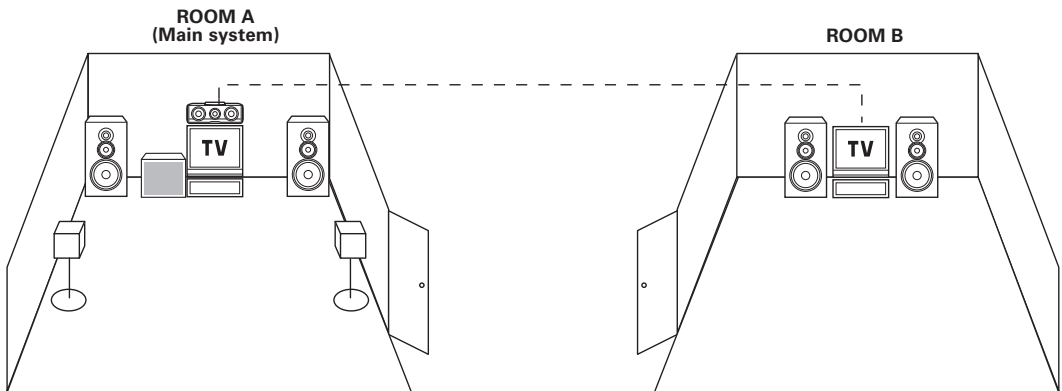
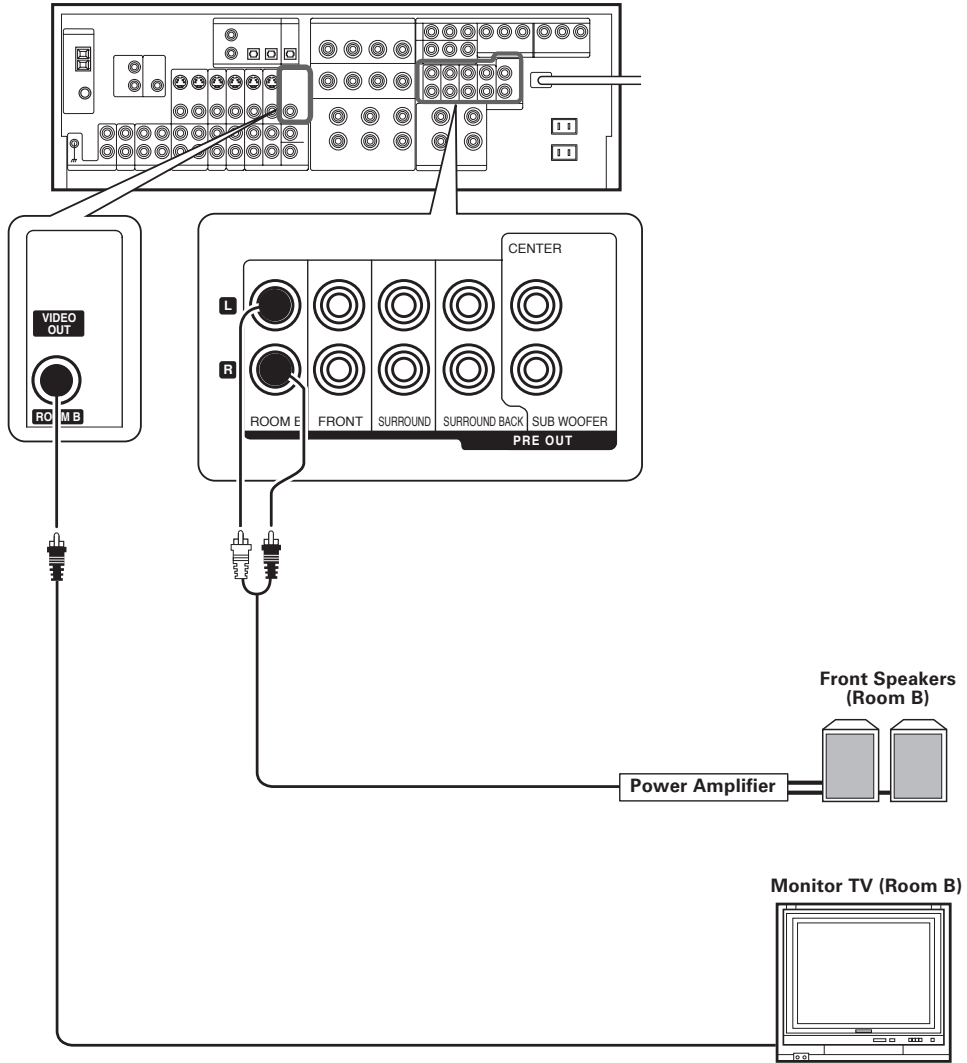

The sound from ROOM B PRE OUT jacks is the same as that of the Front Speakers. When listening in another room (ROOM B), set the LISTEN mode to STEREO. → 37

Connecting the external IR receiver (For VR-9080)

The remote control for this receiver has the IR (infrared rays) transmission function. IR repeaters enables you to control components located in cabinets or behind glass doors. You can enjoy a wider remote control signal range by placing the IR receiver away from the receiver.

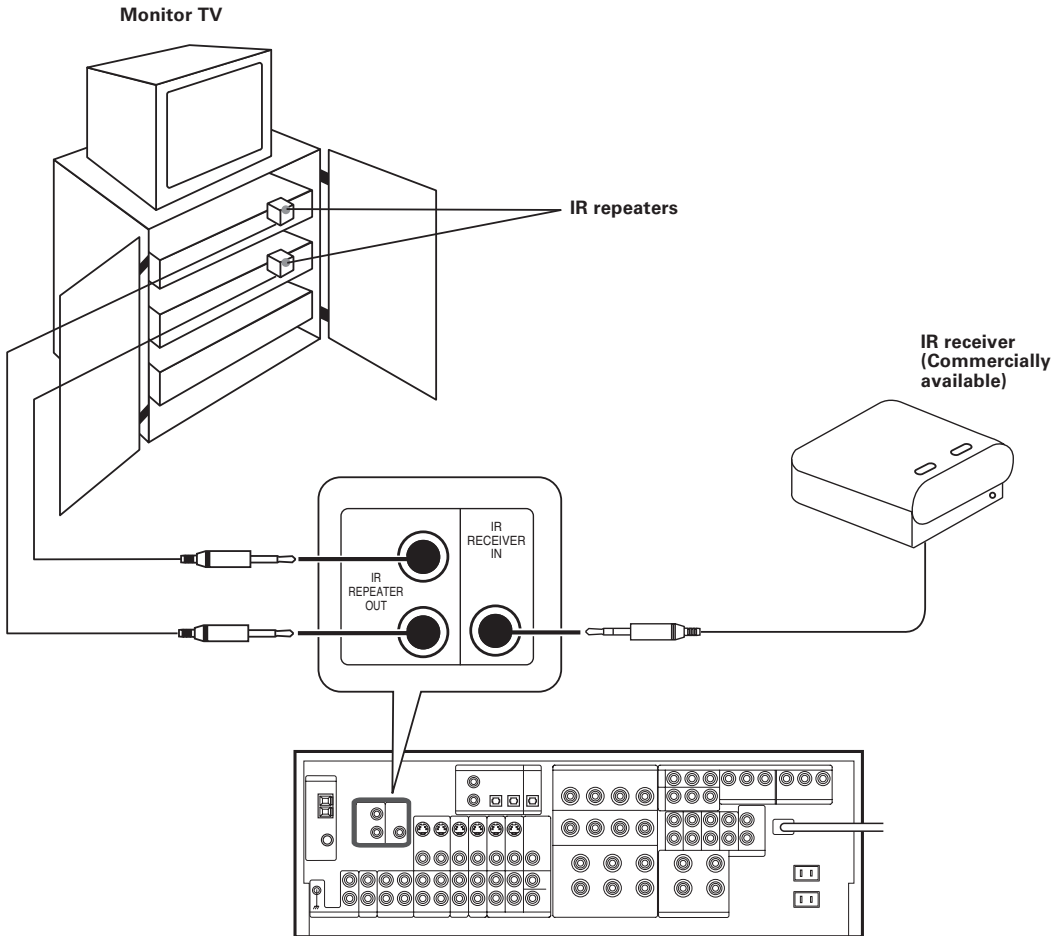

Connecting IR repeater

- 1 Connect the IR repeater to the device as described in the repeater's manual.
- 2 Connect the IR repeater cable(s) to the IR REPEATER OUT jack(s).

Notes

- IR repeaters send a signal similar to the device's own remote control. Xantech repeaters (example : models 284M or 286M) are compatible with your new audio-video receiver.

Shape of plug to be connected.

	IR RECEIVER IN	IR REPEATER OUT
	Stereo mini plug	Mono mini plug
	Sleeve	Sleeve
	Tip	Tip
	Ring	
IR IN / OUT SPECIFICATION:		
Terminal	IR RECEIVER IN	IR REPEATER OUT
To Tip	Signal	Signal
To Ring	Ground	
To Sleeve	+ 8V	Ground

Connecting to the AV AUX jacks

The **AV AUX** jacks are convenient for connection of video components such as a camcorder or a video game.

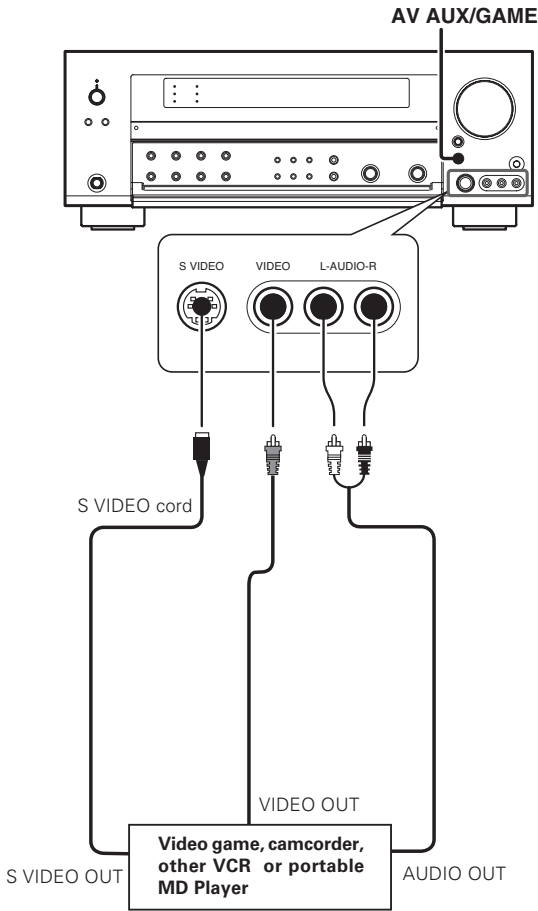

- This model has a game function which is convenient for using game equipment. It is recommended that the game equipment be connected to AV AUX jacks and the game mode be turned ON. — 27
- To select the source connected to the AV AUX jacks press AV AUX/GAME key. — 27
- When you connect the audio source such as the MD player, you do not need to connect the video cable.
- When you connect the component with the S VIDEO cord, you can enjoy better picture quality.

Connecting the antennas

The broadcast reception cannot be made unless the antennas are connected. Connect the antennas correctly as instructed below.

AM Loop Antenna

Place the supplied loop antenna as far as possible from the receiver, TV set, speaker cords and power cord, and adjust the direction for best reception.

AM Antenna Terminal connections

① Push lever.

② Insert cord.

③ Release lever.

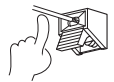
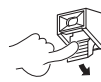

FM Indoor Antenna

The supplied indoor antenna is for temporary use only. For stable signal reception we recommend using an outdoor antenna. Disconnect the indoor antenna when you connect one outdoors.

FM Antenna Terminal connections

VR-9080

KRF-X9090D

Insert Connector.



FM Outdoor Antenna

Lead the 75Ω coaxial cable connected to the FM outdoor antenna into the room and connect it to the 75Ω FM terminal.

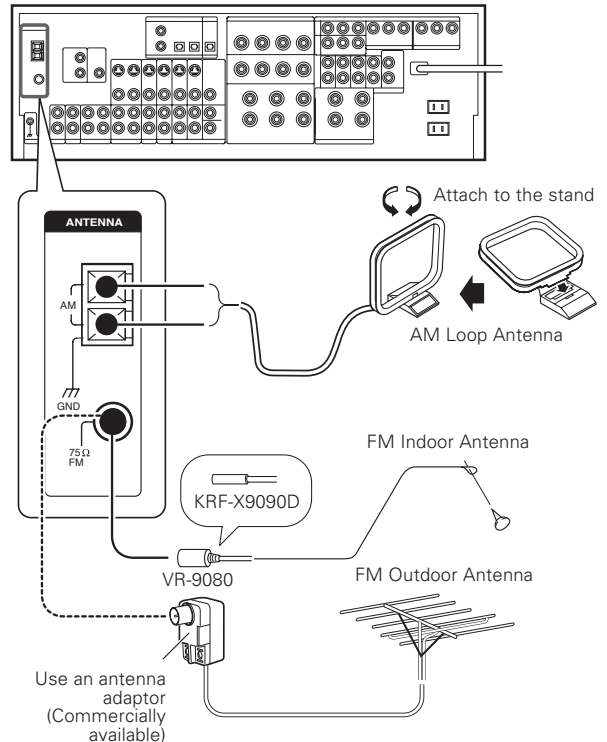

Preparing for surround sound

Before setting up the speakers

For the optimum surround playback, variety of speaker settings are necessary.

Following the procedure below, go through the settings described in further pages.

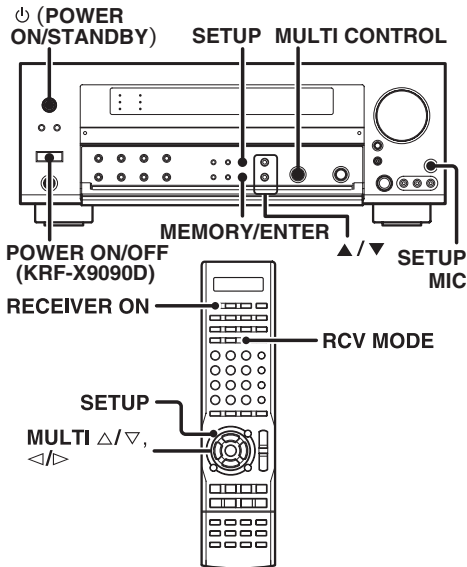

1 When performing "Setting up the speakers automatically (AUTO SETUP)", connect the provided microphone for setup to the SETUP MIC jack.

2 Turn on the power to this receiver by pressing the \downarrow (POWER ON/STANDBY) key (VR-9080) or the POWER ON/OFF key and \downarrow (POWER ON/STANDBY) key (KRF-X9090D), or the RECEIVER ON key.

3 If you want to use the remote control unit, press the RCV MODE key on the remote control unit to set it to the receiver control mode.

4 Press the SETUP key to enter the SETUP mode. Use the Δ/∇ keys or MULTI \triangle/∇ keys for the following displays.

- ① AUTO SETUP
- ② MANUAL SETUP
- ③ SW RE-MIX
- ④ CROSSOVER
- ⑤ SB SPACING
- ⑥ BASS PEAK
- ⑦ LFE LEVEL
- ⑧ AUDIO DELAY
- ⑨ DISPLAY MODE
- ⑩ SETTING LOCK
- ⑪ EXIT

The flow of the SETUP is as follows:

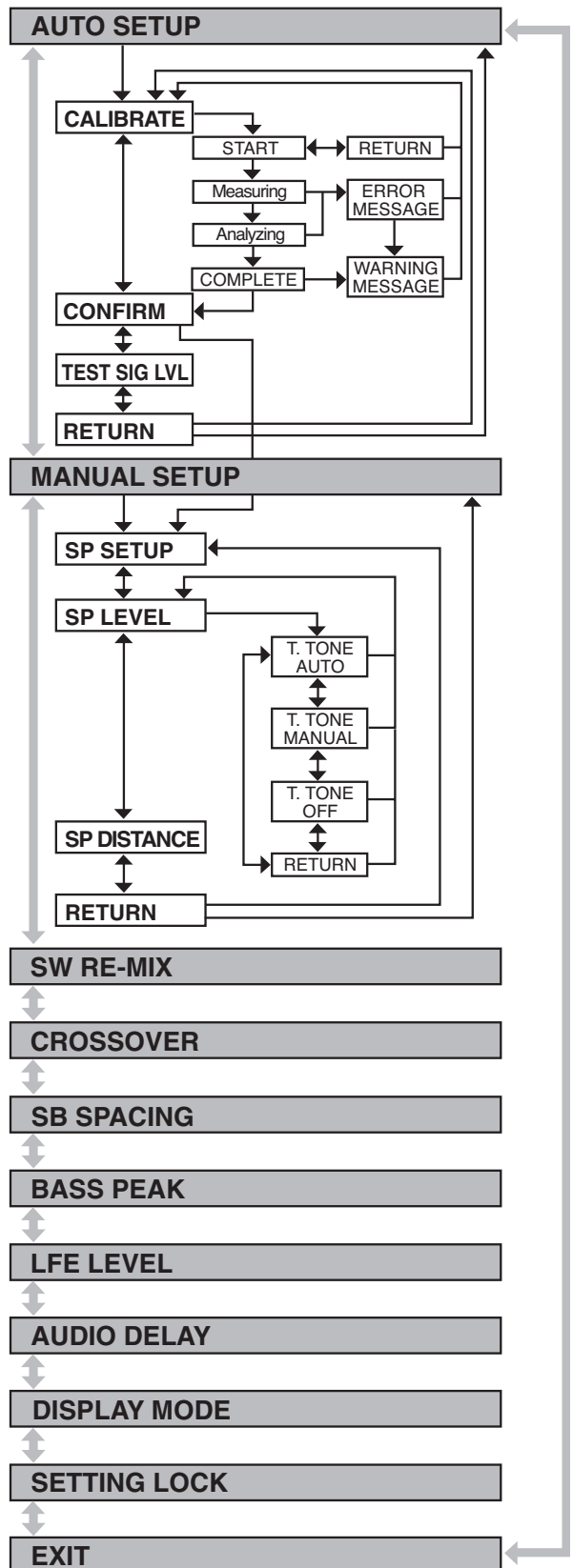

Setting up the speakers automatically (AUTO SETUP) "Kenwood Room Acoustic Calibration"



A very loud test sound is produced during the measurement. Please take into consideration that it may disturb your neighborhood, especially, when you measure it at the night time.

"Kenwood Room Acoustic Calibration" function automatically performs the following adjustments with the provided microphone by measuring sound characteristics for the best listening environment according to your room conditions and speakers layout.

- ① Speaker presence and its size
- ② Volume level differences from each speaker
- ③ Sound delay from speakers
- ④ Room sound characteristics

• Image of the measurement

Place the microphone at a height of your ears.

Do not place any obstacles between the microphone and speakers during the measurement.

The measurement may not be carried out properly because of speaking voice or other noise. Keep it down while measuring.

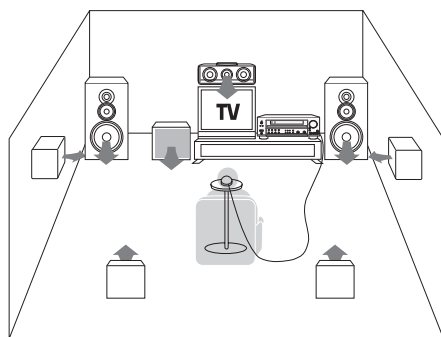

1 Perform automatic calibration.

- ① Use the **▲/▼** keys or **MULTI </>** keys to select the "AUTO SETUP" and press the **MEMORY/ENTER** key or the **ENTER** key.
- ② Use the **▲/▼** keys or **MULTI </>** keys to select the "CALIBRATE" and press the **MEMORY/ENTER** key or the **ENTER** key.
 - The display which indicates start of the measurement, "START" is displayed.
 - If you wish not to start measuring, use the **▲/▼** keys or **MULTI </>** keys to select "RETURN", and then press the **MEMORY/ENTER** key or the **ENTER** key to return to "CALIBRATE" display.
- ③ Press the **MEMORY/ENTER** key or the **ENTER** key to start measuring.
 - The display which indicates during the measurement, "Measuring..." is displayed.
 - It takes about 2 minutes to complete the measurement.
 - If the provided microphone is not connected, "E01:No MIC" is displayed and no measurement is performed.
 - After the measurement is completed, analyzing starts and "Analyzing x/4" (x changes from 1 to 4) is displayed. When the analyzing is completed, "COMPLETE" will be shown for a few seconds, and changed to "CONFIRM".
 - Do not turn off the receiver while measuring. Otherwise, the measurement contents are changed back to the factory setting.

2 Exit the AUTO SETUP mode.

When "CONFIRM" is displayed, press the **MEMORY/ENTER** key or the **ENTER** key.

- The display which indicates the confirmation of the measurement contents, "SP SETUP" is displayed. → [23]
- Use the **▲/▼** keys or **MULTI </>** keys to select "RETURN" while "CONFIRM" is displayed, and then press the **MEMORY/ENTER** key or the **ENTER** key to return to the "AUTO SETUP" display.

Notes

- Sometimes due to the electrical complexities of subwoofers and the interaction with the room, THX recommends setting the level and the distance of the subwoofer manually.
- Sometimes due to interaction with the room, you may notice irregular results when setting the level and/or distance of the main speakers. If this happens, THX recommends setting them manually.
- Please note that any THX main speakers should be set to NML/THX (80Hz).
If you set up your speakers using AUTO SETUP, please make sure manually that any THX speakers are set to NML/THX with 80Hz CROSSOVER.

Test signal level adjustment

If a message such as "Exx : No Spk XX" or "Wxx : No Spk XX" is displayed even though each speaker is connected correctly, adjust the level of the test signal.

- ① While "CONFIRM" or "CALIBRATE" is displayed, use the **▲/▼** keys or **MULTI </>** keys to select "TEST SIG LVL", and then press the **MEMORY/ENTER** key or the **ENTER** key.
- ② Use the **MULTI CONTROL** knob or **MULTI ▲/▼** keys to select a test signal level.
 - ① LEVEL LOW
 - ② LEVEL MID
 - ③ LEVEL HIGH
- ③ Press the **MEMORY/ENTER** key or the **ENTER** key to accept the setting.
- ④ Proceed to step ② of "1 Perform automatic calibration."

Cancelling the measurement

If you operate any of the keys shown below, the measurement is cancelled and the display is return to the ordinary input display.

- ① **POWER ON/STANDBY** key or **RECEIVER STANDBY** key
- ② **VOLUME CONTROL** knob or **VOLUME ▲/▼** keys
- ③ **SETUP** key
- ④ **INPUT SELECTOR** key

- If the measurement is cancelled, the measurement contents are changed back to the factory setting.

About error messages

If the receiver detects some kind of problems while in calibration, an error message is shown in the display, and the processing is stopped.

Eliminate the problem according to the message and try the calibration again. If there are more than one error messages, press the **▲/▼** keys or **MULTI </>** keys to find the next one while the message is shown on the display.

Press the **MEMORY/ENTER** key or the **ENTER** key to return to the "CALIBRATE" display.

E01 : No MIC
Microphone is not connected.
Connect the provided microphone for setup to the SETUP MIC jack.

E02 : Headphone
Headphones are being connected.
Disconnect the headphones.

E03 : No Spk FL
E04 : No Spk FR
Front Left (Right) speaker is not connected.
Connect a Front Left (Right) speaker.

E05 : No Spk SL
E06 : No Spk SR
Surround Right (Left) speaker is detected, but Surround Left (Right) speaker is not connected.
Connect a Surround Left (Right) speaker.

E07 : No SpkSBL
Surround Back Right speaker is detected, but Surround Back Left speaker is not connected.
For 7.1 channel system, connect a Surround Back Left speaker. For 6.1 channel system, reconnect the Surround Back Right speaker to SURROUND BACK L terminals.

E08 : SB w/o S
Surround Back speaker is detected, but Surround Left and Right speakers are not connected.
Connect Surround Left and Right speakers.

E09 : MIC clip
Microphone detects a large volume signal.
Do not touch or shake the microphone, and try the calibration again.

E10 : VolChange
Volume is changed while calibrating.
Do not change the volume while in calibration.

E99 : Error
Communication error occurred in the unit.
Try the calibration again. If the same message appears, consult your dealer.

About the warning messages

Even if "COMPLETE" is shown on the display for several seconds and the calibration is completed, a warning message may appear if some kind of minor problems are detected.

Eliminate the problem according to the message and try the calibration again, or understand the problem and finish up the **AUTO SETUP**.

- If there are more than one warning messages, press the ▲/▼ keys or **MULTI** </> keys to find the next one while the message is shown on the display.
- Pressing the **MEMORY/ENTER** key or the **ENTER** key changes back the display to "CALIBRATE".
- Depending on the speakers, warning messages may appear even if the speakers are connected correctly. In this case, it is not problems.

W01 : Phase F
The connection of either Front Left or Right speaker is not correct (+ - inversion).
Make sure the + and - speaker cords are connected correctly for Front Left and Right speakers.

W02 : Phase S
The connection of either Surround Left or Right speaker is not correct (+ - inversion).
Make sure the + and - speaker cords are connected correctly for Surround Left and Right speakers.

W03 : Phase SB
The connection of either Surround Back Left or Right speaker is not correct (+ - inversion).
Make sure the + and - speaker cords are connected correctly for Surround Back Left and Right speakers.

W04 : No Spk C
Center speaker is not connected.
Connect a Center speaker if you have one. If there is no Center speaker, no need to connect it.

W05 : No SW
Subwoofer is not connected.
Connect a Subwoofer if you have one. If there is no Subwoofer, no need to connect it.

W06 : No Spk S
Surround speakers are not connected.
Connect a pair of Surround speakers if you have a set. If there are no Surround speakers, no need to connect it.

W07 : No Spk SB
Surround Back speakers are not connected.
Connect a pair of Surround Back speakers if you have a set. If there are no Surround Back speakers, no need to connect it.

W08 : No SpkSBR
Surround Back Right speaker is not connected.
Connect a Surround Back Right speaker if you have one. If there is no Surround Back Right speaker, no need to connect it.

Setting up the speakers manually (MANUAL SETUP)

1 Select a speaker system.

If you have THX certified speakers, please set them to NML/THX.

1 Press the **▲/▼** keys or **MULTI </>** keys to select the "MANUAL SETUP" and press the **MEMORY/ENTER** key or the **ENTER** key.

2 Select the "SP SETUP" and press the **MEMORY/ENTER** key or the **ENTER** key again so that the subwoofer setting indication "SUBW ON" appears.

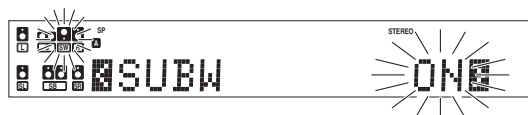

3 Use the **MULTI CONTROL** knob or **MULTI ▲/▼** keys to select the appropriate subwoofer setting.

- ① **SUBW ON** : A Subwoofer is connected to the receiver.
- ② **SUBW OFF** : A Subwoofer is not connected to the receiver.

- The initial setting is "SUBW ON".
- When Subwoofer output sound is required, select "FRNT NML/THX", or select both "FRNT LARGE" and "SW RE-MIX ON".

4 Press the **▲** key or **MULTI ▷** key to accept the setting.

- When the setting "SUBW ON" is selected, the front speakers setting indication "FRNT" appears.
- When the setting "SUBW OFF" is selected, the Front Speakers are automatically set to "FRNT LARGE" and the procedure skips to step 5.



5 Use the **MULTI CONTROL** knob or **MULTI ▲/▼** keys to select the appropriate front speakers setting.

- ① **FRNT NML/THX** : Average size Front Speakers are connected to the receiver.
- ② **FRNT LARGE** : Large size Front Speakers are connected to the receiver.

6 Press the **▲** key or **MULTI ▷** key to accept the setting.

- The Center Speaker setting indication "CNTR" appears.

7 Use the **MULTI CONTROL** knob or **MULTI ▲/▼** keys to select the appropriate Center Speaker setting.

If you selected "FRNT LARGE" as the Front Speakers setting,

- ① **CNTR NML/THX** : An average size Center Speaker is connected to the receiver.
- ② **CNTR LARGE** : A large size Center Speaker is connected to the receiver.
- ③ **CNTR OFF** : A Center Speaker is not connected to the receiver.

If you selected "FRNT NML/THX" as the Front Speakers setting,

- ① **CNTR NML/THX** : An average size Center Speaker is connected to the receiver.
- ② **CNTR OFF** : A Center Speaker is not connected to the receiver.

8 Press the **▲** key or **MULTI ▷** key again to accept the setting.

- The Surround Speaker setting indication "SURR" appears.

Continued to next page.

- ➊ Use the **MULTI CONTROL knob** or **MULTI** Δ/∇ keys to select the appropriate Surround Speaker setting.

If you selected "FRNT LARGE" as the Front Speaker setting,

- ➀ **SURR NML/THX** : Average size Surround Speakers are connected to the receiver.
- ➁ **SURR LARGE** : Large size Surround Speakers are connected to the receiver.
- ➂ **SURR OFF** : Surround Speakers are not connected to the receiver.

If you selected "FRNT NML/THX" as the Front Speaker setting,

- ➀ **SURR NML/THX** : Average size Surround speakers are connected to the receiver.
- ➁ **SURR OFF** : Surround Speakers are not connected to the receiver.

- ➋ Press the **▲** key or **MULTI** \triangleright key again to accept the setting.
- When the setting other than "SURR OFF" is selected, the Surround Back Speaker setting indication "SB" appears.
 - When the setting "SURR OFF" is selected, the procedure skips to step ➌.

- ➌ Use the **MULTI CONTROL knob** or **MULTI** Δ/∇ keys to select appropriate Surround Back Speaker setting.

If you selected "SURR LARGE" as the Surround Speaker setting,

- ➀ **SB NML/THXx1** : A single average size Surround Back Speaker is connected to the receiver.
- ➁ **SB NML/THXx2** : A pair of average size Surround Back Speakers are connected to the receiver.
- ➂ **SB LARGEx1** : A single large size Surround Back Speaker is connected to the receiver.
- ➃ **SB LARGEx2** : A pair of large size Surround Back Speakers are connected to the receiver.
- ➄ **SB OFF** : Surround Back Speakers are not connected to the receiver.



If you selected "SURR NML/THX" as the Surround Speaker setting,

- ➀ **SB NML/THXx1** : A single average size Surround Back Speaker is connected to the receiver.
- ➁ **SB NML/THXx2** : A pair of average size Surround Back Speakers are connected to the receiver.
- ➂ **SB OFF** : Surround Back Speakers are not connected to the receiver.

- ➍ Press the **MEMORY/ENTER** key or the **ENTER** key to return to the "SP SETUP" display.

2 Adjust the speaker volume level.

If you have a commercially available sound pressure meter, set the meter readout to "C" at the listening position and adjust the sound volume of each channel so that the noise level will reach 75dB. If you do not have a sound pressure meter, start the volume level from 0db and adjust so that the level from each speaker is almost the same.

- Indicators appear only for the channels of the speakers selected in step ➊.

Be aware that the **TEST TONE** is quite a loud sound (0dB).

- ➎ Press the **▲/▼** keys or **MULTI** $\triangleleft/\triangleright$ keys to select the "SP LEVEL" and press the **MEMORY/ENTER** key or the **ENTER** key.

- ➏ Press the **▲/▼** keys or **MULTI** $\triangleleft/\triangleright$ keys for the following displays:

- ➀ **T.TONE AUTO** : Adjust the volume level from each speaker by using test tone. Test tone will be output from each speaker in order.
- ➁ **T.TONE MANUAL** : Adjust the volume level from each speaker by using test tone.
- ➂ **T.TONE OFF** : Adjust the volume level from each speaker without using test tone.
- ➃ **RETURN** : Press the **MEMORY/ENTER** key or the **ENTER** key to return to the "SP LEVEL" display.

- ➐ After selecting "T.TONE AUTO" or "T.TONE MANUAL", press the **MEMORY/ENTER** key or the **ENTER** key to begin TEST TONE.

Use the **MULTI CONTROL knob** or **MULTI** Δ/∇ keys to adjust the volume level of the test tone output from the speaker channel to be adjusted.

For T.TONE AUTO selection, the test tone is heard from the speakers in the following sequence for 2 seconds each starting from the Front Left speaker.

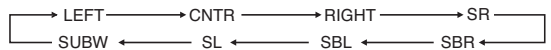

- If you have selected "SB NML/THXx1" or "SB LARGEx1", "SBR" and "SBL" are not appeared but "SB" is appeared on the Display.

The channel indication blinks while the test tone is being output.



- If the speaker setting selects are OFF, the speaker level settings are reset.

For "T.TONE MANUAL" selection, press the **▲/▼** keys or **MULTI** $\triangleleft/\triangleright$ keys each time to select the speaker channel.

If "T.TONE OFF" is selected, test tone is not output. Adjust the volume level from each speaker by listening the selected input source. - 24

- ➑ Press the **MEMORY/ENTER** key or the **ENTER** key to return to the "SP LEVEL" display.

- The test tone is turned off and return to the main setup displays.

3 Input the distance to the speakers.

- Indicators appear only for the channels of the speakers selected in step ➊.

- ➒ Press the **▲/▼** keys or **MULTI** $\triangleleft/\triangleright$ keys to select the "SP DISTANCE" and press the **MEMORY/ENTER** key or the **ENTER** key.

- ➓ Use the **▲/▼** keys or **MULTI** $\triangleleft/\triangleright$ keys to select a unit in distance and press the **MEMORY/ENTER** key or the **ENTER** key.

- ➀ **UNIT meters**
- ➁ **UNIT feet**
- ➂ **RETURN** : Press the **MEMORY/ENTER** key or the **ENTER** key to return to the "SP DISTANCE" display.

④ Measure the distance from the listening position to each of the speakers.

Jot down the distance to each of the speakers.

- Distance to Front Left Speaker (L) : ____ feet (meters)
- Distance to Center Speaker (C) : ____ feet (meters)
- Distance to Front Right Speaker (R) : ____ feet (meters)
- Distance to Surround Right (SR) : ____ feet (meters)
- Distance to Surround Back Right (SBR) : ____ feet (meters)
- Distance to Surround Back (SB) : ____ feet (meters)
- Distance to Surround Back Left (SBL) : ____ feet (meters)
- Distance to Surround Left (SL) : ____ feet (meters)
- Distance to Subwoofer (SW) : ____ feet (meters)

• If you have selected “SB NML/THXx1” or “SB LARGEx1”, “SBR” and “SBL” are not appeared but “SB” is appeared on the Display.

④ Use the ▲/▼ keys or MULTI </> keys to select the speakers and the MULTI CONTROL knob or MULTI ▲/▼ keys to adjust the distance to the Front Speakers.

The speaker indicator to be adjusted blinks.

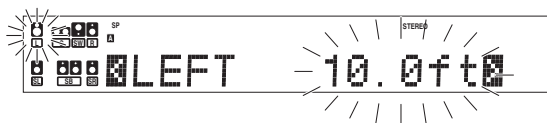

Indication in feet

• The allowable setting range is 0.1 to 30.0 feet (0.03 to 9.14 m), adjustable in 0.1 foot (about 0.03 m) increments.

⑤ Repeat steps ④ to input the distance for each of the speakers.

⑥ Press the MEMORY/ENTER key or the ENTER key to return to the “SP DISTANCE” display.

• The speakers you have selected should appear on the display. Confirm that all the speakers have been correctly selected.

④ Exit the MANUAL SETUP mode.

① Press the ▲/▼ keys or MULTI </> keys to select the “RETURN”



② Press the MEMORY/ENTER key or the ENTER key to return to the “MANUAL SETUP” display.

Other settings

1 Adjust the Subwoofer RE-MIX.

① Press the ▲/▼ keys or MULTI </> keys to select the “SW RE-MIX” and press the MEMORY/ENTER key or the ENTER key.

② Use the MULTI CONTROL knob or MULTI ▲/▼ keys to select the appropriate Subwoofer re-mix setting.

If “SW RE-MIX ON” is selected as the subwoofer re-mix setting, the low frequencies are enhanced by adding the low frequencies of other channels to the subwoofer channel depending on the speaker setup.

- ① SW RE-MIX ON : Subwoofer re-mix setting mode to the receiver is ON.
- ② SW RE-MIX OFF : Subwoofer re-mix setting mode to the receiver is OFF.

• If Subwoofer is turned off or “FRNT NML/THX” is selected at the Front Speaker setting, Subwoofer re-mix setting is not visible.

• By selecting “SW RE-MIX OFF”, the low frequencies will play through the Front Speakers only. This selection is preferred by THX.

③ Press the MEMORY/ENTER key or the ENTER key to accept the setting.

2 Select the CROSSOVER frequency.

CROSSOVER function is to adjust the receiver’s audio output characteristics with the speakers’ characteristics which differs depending on the size of the speakers. You will be able to enjoy a more natural and dynamic sound experience even with small size speakers.

① Press the ▲/▼ keys or MULTI </> keys to select the “CROSS OVER” and press the MEMORY/ENTER key or the ENTER key.

• CROSSOVER function will not be available when “LARGE” is selected for all the speakers in step ① and “SW RE-MIX OFF” is selected. - 23

② Use the MULTI CONTROL knob or MULTI ▲/▼ keys to select the CROSSOVER frequency.

- ① FREQ. : 40Hz
- ② FREQ. : 60Hz
- ③ FREQ. : 80Hz-THX
- ④ FREQ. : 100Hz
- ⑤ FREQ. : 120Hz
- ⑥ FREQ. : 150Hz

• If you have THX certified speakers, select “FREQ.:80Hz-THX”.



③ Press the MEMORY/ENTER key or the ENTER key to accept the setting.

3 Adjust the distance between left and right Surround Back speaker.

This mode is available only when “SB NML/THXx2” or “SB LARGEx2” has been selected in Surround Back Speaker setting.

① Press the ▲/▼ keys or MULTI </> keys to select “SB SPACING” and press the MEMORY/ENTER key or the ENTER key.

2 Use the MULTI CONTROL knob or MULTI Δ/∇ keys to select the distance between left and right Surround Back speaker.

- 1 TOGETHER : The distance is 1 foot (0.3m) or less.
- 2 CLOSE : The distance is between 1 foot (0.3m) and 4 feet (1.2m).
- 3 APART : The distance is 4 feet (1.2m) or more.

3 Press the MEMORY/ENTER key or the ENTER key to accept the setting.

4 Adjust the bass peak level.

A restriction is put on the low frequency so that the bass peak level will not go higher than the acceptable level when the volume is increased.

If Subwoofer is OFF, the limitation will affect the low frequency of the Front Left and Right Speakers.

1 Press the Δ/∇ keys or MULTI \langle/\rangle keys to select "BASS PEAK" and press the MEMORY/ENTER key or the ENTER key.

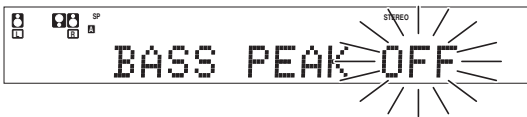

2 Use the MULTI CONTROL knob or MULTI Δ/∇ keys to adjust the bass peak level to -30(dB).

- The adjustment range is from -30(dB) to 0(dB) and OFF.

3 For optimum bass peak level, keep increasing the bass peak level by using the MULTI CONTROL knob or MULTI Δ/∇ keys while test tone is being output until clip sound is heard from the Subwoofer or Front Speaker.

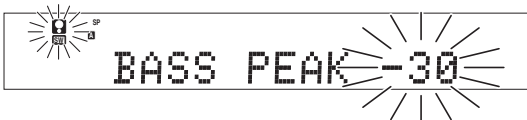

4 Press the MEMORY/ENTER key or the ENTER key to accept the setting.

5 Adjust the LFE LEVEL (Low Frequency Effects).

1 Press the Δ/∇ keys or MULTI \langle/\rangle keys to select the "LFE LEVEL" and press the MEMORY/ENTER key or the ENTER key.

2 Use the MULTI CONTROL knob or MULTI Δ/∇ keys to adjust the LFE LEVEL.



- The LFE LEVEL can be adjusted from 0dB to -10dB in 1dB decrements.

3 Press the MEMORY/ENTER key or the ENTER key to accept the setting.

6 Adjust the AUDIO DELAY.

Depending on video equipments, because of its internal processing moving image on the Monitor may seem to be delayed compared to the audio from the speakers. This can be adjusted by audio delay which delays audio to match the video picture.

1 Press the Δ/∇ keys or MULTI \langle/\rangle keys to select the "AUDIO DELAY" and press the MEMORY/ENTER key or the ENTER key.



2 Use the MULTI CONTROL knob or MULTI Δ/∇ keys to select the delay time.

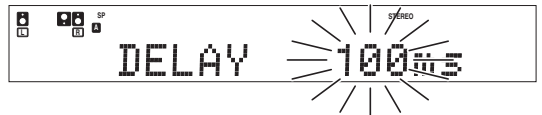

- The allowable setting range is 0 to 200 ms, adjustable in 10 ms increments.
- Delay is not applied when TUNER, MD/TAPE, PHONO or 6CH INPUT is selected as an input, or AUTO REC MODE or MANUAL REC MODE is selected.
- When in 96kHz fs signal playback, the effectable delay time is up to 100ms.

3 Press the MEMORY/ENTER key or the ENTER key to accept the setting.

7 Select the display mode.

1 Press the Δ/∇ keys or MULTI \langle/\rangle keys to select the "DISPLAY MODE" and press the MEMORY/ENTER key or the ENTER key.

2 Use the MULTI CONTROL knob or MULTI Δ/∇ keys to select the display mode.

- 1 DISP SELECTOR : Displays the current input selector.
- 2 DISP LISTEN : Displays the current listen mode or THX mode.



3 Press the MEMORY/ENTER key or the ENTER key to accept the setting.

8 Lock the settings.

In case that the keys are mistakenly pressed, the setting can be locked.

1 Press the Δ/∇ keys or MULTI \langle/\rangle keys to select the "SETTING LOCK" and press the MEMORY/ENTER key or the ENTER key.

2 Use the MULTI CONTROL knob or MULTI Δ/∇ keys to select the lock mode.

- 1 SETUP LOCKED : Lock the settings.
- 2 SETUP UNLOCKED : Unlock the settings.

3 Press the MEMORY/ENTER key or the ENTER key to accept the setting.

9 Exit the SETUP mode.

1 Press the Δ/∇ keys or MULTI \langle/\rangle keys to select the "EXIT".



2 Press the MEMORY/ENTER key or the ENTER key to return to the display mode selected in step 7.

Normal playback

Preparing for playback

Some preparatory steps are needed before starting playback.

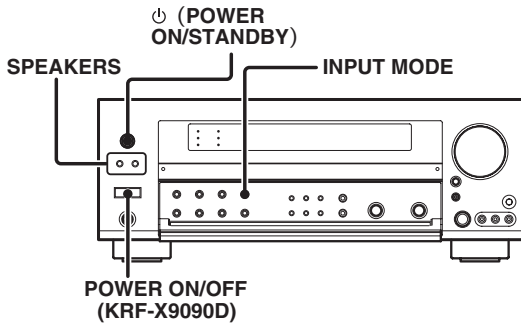

Turning on the receiver

- 1 Turn on the power to the related components.
- 2 Turn on the power to this receiver by pressing the $\text{\textcircled{P}}$ (POWER ON/STANDBY) key (VR-9080), or the POWER ON/OFF key and $\text{\textcircled{P}}$ (POWER ON/STANDBY) key (KRF-X9090D).

Selecting the input mode

If you have selected a component connected to the CD/DVD, VIDEO 2, VIDEO 3 or DVD/6CH jacks, make sure that the input mode setting is correct for the type of audio signal to be used. 

Selecting the speaker system

Press the SPEAKERS key to select the speaker system to be used.

- A ON** : Sound from the speakers connected to the SPEAKERS A terminals.
- B ON** : Sound from the speakers connected to the SPEAKERS B terminals.
- A ON, B ON** : Sound from both the speakers connected to the SPEAKERS A and B terminals.
- OFF** : No sound from the speakers.

The indicator for the speakers you want to use should be lit.

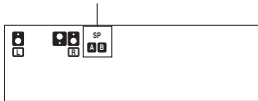

- Selecting "6CH INPUT" by pressing the INPUT MODE key, whereby "DVD/6CH" is the input source will cause SPEAKERS A to be selected automatically.
- When the SPEAKERS B is turned ON, the Listen mode will be switched to Stereo.
- Turn on SPEAKERS A if using PRE OUT terminals including Subwoofer to output sound.

Listening to a source component

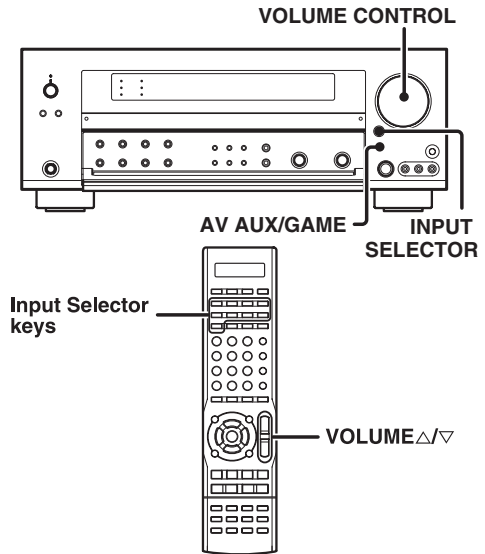

- 1 Use the INPUT SELECTOR and AV AUX/GAME keys or Input Selector keys to select the source you want to listen to.

Selecting a source using each key.

- 1 TUNER
- 2 CD/DVD
- 3 MD/TAPE
- 4 VIDEO 1
- 5 VIDEO 2
- 6 VIDEO 3
- 7 DVD/6CH
- 8 PHONO
- 9 AV AUX [GAME] (or AV AUX)

- 2 Start playback from the selected source.

- 3 Use the VOLUME CONTROL knob or VOLUME Δ/▽ keys to adjust the volume.

Set up the AV AUX jacks on the front panel

Perform the setup for convenience of playing a video game using the receiver.

- 1 Use the AV AUX/GAME key to select "AV AUX [GAME]" (or "AV AUX").
- 2 Press and hold the AV AUX/GAME key for more than 2 seconds for the following selections;
 - 1 AV AUX [GAME] : When the connected game player is turned ON, the input selector is switched automatically to "AV AUX [GAME]". In addition, the ACTIVE EQ function is switched to "ACTIVE EQ GAME", and the Listen mode is switched to the appropriate mode for games.
 - 2 AV AUX : The game mode is switched off.

- The game mode is not activated if no video signal is input to the VIDEO or S-VIDEO jack in the AV AUX jack section.

Input level adjustment (analog sources only)

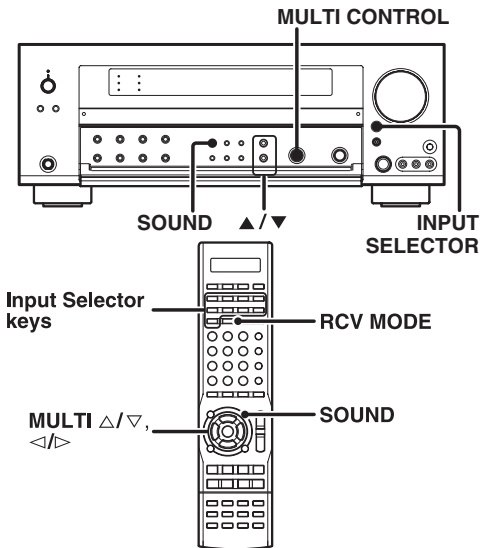

Input level adjustment (analog sources only)

If the input level of an analog source signal is too high, the **CLIP** indicator will blink. Adjust the input level.

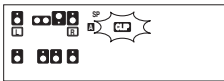

- ❶ Use the **INPUT SELECTOR** key or Input Selector keys to select the source of which the input level you want to adjust.
 - You can store a separate input level for each input source.
- ❷ For the remote control unit, press the **RCV MODE** key to switch to receiver mode.
- ❸ Press the **SOUND** key and **▲/▼** keys or **MULTI </>** keys repeatedly until the "INPUT" indication appears.
- ❹ Use the **MULTI CONTROL** knob or **MULTI ▲/▼** keys to adjust the input level.



- The adjustment mode is displayed for approximately 20 seconds.
- The input level can be adjusted to any one of three settings: 0dB, -3dB, and -6dB. (The initial setting is 0dB.)

- ❺ Press the **SOUND** key to accept the setting.

Adjusting the sound

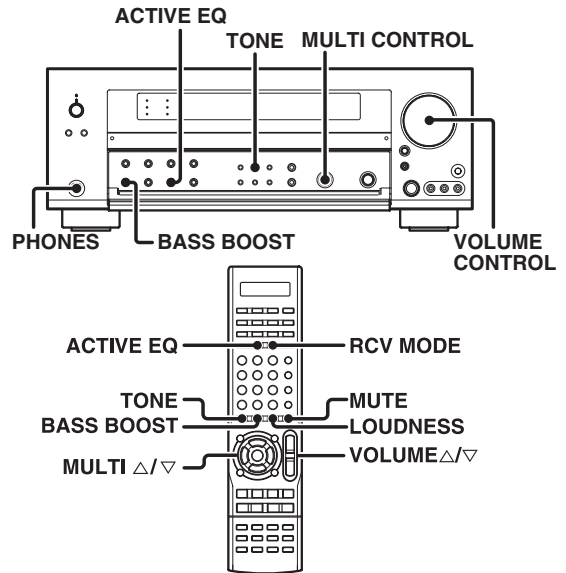

ACTIVE EQ mode

After completing "Setting up the speakers automatically (AUTO SETUP)", the most suitable equalizer curve for the frequency characteristics of your speakers and the room will be set for each ACTIVE EQ mode.

- ❶ For the remote control unit, press the **RCV MODE** key to switch to receiver mode.
 - ❷ Press the **ACTIVE EQ** key for the following selections;
 - ❶ **ACTIVE EQ OFF** : The ACTIVE EQ function is turned OFF.
 - ❷ **ACTIVE EQ FLAT*** : Frequency response from speakers are flat.
 - ❸ **ACTIVE EQ MUSIC** : Effective when listening to music.
 - ❹ **ACTIVE EQ CINEMA** : Effective when watching movie.
 - ❺ **ACTIVE EQ GAME** : Effective when playing video game.
- *It can be selected after **AUTO SETUP** is carried out.



- If **THX** key is pressed, ACTIVE EQ mode is changed to "ACTIVE EQ FLAT" automatically. After that you can change the ACTIVE EQ mode by pressing the **ACTIVE EQ** key.
- ACTIVE EQ function will not be available when in REC mode.

Normal playback

Adjusting the TONE

You can adjust the sound quality when the receiver is in the PCM stereo and analog stereo mode, and both THX and Virtual mode are off.

- 1 For the remote control unit, press the RCV MODE key to switch to receiver mode.
- 2 Press the TONE key to select the TONE mode.
- 3 Use the MULTI CONTROL knob or MULTI Δ/∇ keys to select TONE ON/OFF.



- 4 When in TONE ON selection, press the TONE key for the following displays.

BASS : Select this to adjust the low frequency range.

TREBLE : Select this to adjust the high frequency range.

- 5 Use the MULTI CONTROL knob or MULTI Δ/∇ keys to adjust the sound quality.



- The bass and treble levels are adjustable from -10 to +10 in 2 step increments.
- The adjustment item is displayed for approximately 20 seconds.
- This function is available only for speakers connected to FRONT A terminals.

Setting the LOUDNESS (remote control unit only)

You can adjust the Loudness function which controls the low volume settings to maintain the music's richness. This setting can be made when the receiver is in the PCM stereo and analog stereo mode, and both THX and Virtual mode are off.

Press the LOUDNESS key to turn the LOUDNESS setting ON.

- This function is available only for speakers connected to FRONT A terminals.

To cancel

Press the LOUDNESS key again so that the "LOUDNESS" indicator goes off.

One-touch low frequency emphasis (BASS BOOST)

This setting can be made when the receiver is in the PCM stereo and analog stereo mode, and both THX and Virtual mode are off.

Press the BASS BOOST key.

- Press the key once to select the maximum (+10) low frequency emphasis setting.
- This key does not function when the receiver is in the sound quality or ambience effects adjustment mode.
- This function is available only for speakers connected to FRONT A terminals.

Switching back to the previous setting

Press the BASS BOOST key again.

Muting the sound

The MUTE key lets you mute the sound of the speakers.

Press the MUTE key.

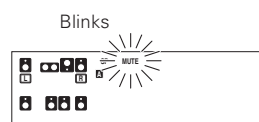

To cancel

Press the MUTE key again so that the "MUTE" indicator goes off.

- MUTE ON can also be deactivated by turning the VOLUME CONTROL knob or pressing VOLUME Δ/∇ keys.

Listening with headphones

- 1 Connect headphones to the PHONES jack.

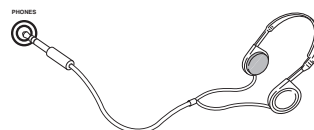

- The sounds from all speakers are cut off.

- 2 Use the VOLUME CONTROL knob or VOLUME Δ/∇ keys to adjust the volume.

Recording

Recording audio (analog sources)

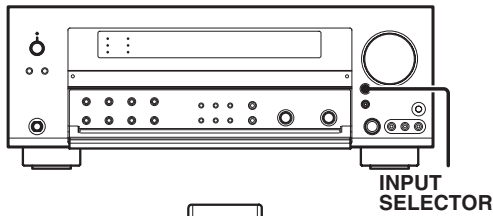

Input Selector keys



Recording a music source

- 1 Use the INPUT SELECTOR key or the Input Selector keys to select the source (other than "MD/TAPE") you want to record.
- 2 Set the MD or TAPE recorder to record.
- 3 Start playback, then start recording.

Recording audio (digital sources)

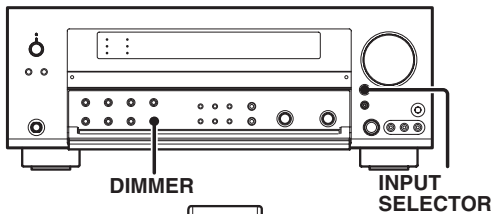

Input Selector keys



Recording music in REC MODE AUTO or MANUAL

- 1 Use the INPUT SELECTOR key or the Input Selector keys to select the source (CD/DVD, DVD/6CH, VIDEO 2, VIDEO 3) you want to record.
- 2 Set the MD or TAPE recorder to record.
- 3 Press and hold the DIMMER key for more than 2 seconds for the following selections;
 - 1 REC MODE off
 - 2 REC MODE AUTO : The digital input signals (DTS, Dolby Digital, or PCM) are identified automatically and converted into stereo signals that are ready for recording.
 - 3 REC MODE MANUAL : The digital input signals (DTS, Dolby Digital, or PCM) are identified and converted into stereo signals that are ready for recording. Once the digital signal is changed to other signal, no signal is output.

For REC MODE AUTO :

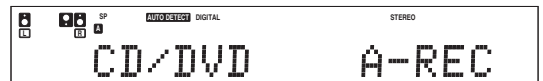

For REC MODE MANUAL :



- 4 Start playback, then start recording.
 - If the audio reproduction stops in the middle due to change in the input signals, etc., press the DIMMER key.

Recording video

- 1 Use the INPUT SELECTOR key or the Input selector keys to select the video source (other than "VIDEO 1") you want to record.
- 2 Set the video recorder connected to VIDEO 1 to record.
 - Select the REC MODE to record a digital input source.
- 3 Start playback, then start recording.
 - Recording may not be normal for some video software. This is due to the copy guard condition.

Listening to radio broadcasts

This model can store up to 40 stations in the memory and recall them by one-touch operation.

Tuning radio stations

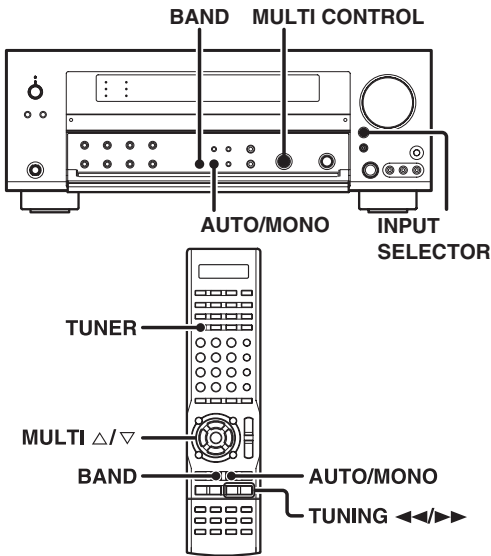

1 Use the **INPUT SELECTOR** key or the **TUNER** key to select the tuner.

2 Use the **BAND** key to select the desired broadcast band.

Each press switches the band.



3 Use the **AUTO/MONO** key to select the desired tuning method.

Each press switches the tuning method to either auto or manual tuning.

"AUTO" indicator lights up in the display.

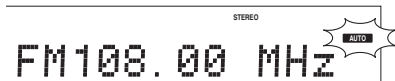

- Normally, set to "AUTO" (auto tuning). If the radio waves are weak and there is a lot of interference, switch to manual tuning. (With manual tuning, stereo broadcasts will be received in monaural.)

4 Use the **MULTI CONTROL** knob or **MULTI Δ/∇** keys, or **TUNING \leftarrow/\rightarrow** keys to select the station.

"STEREO" lights when a broadcast is being received in stereo.

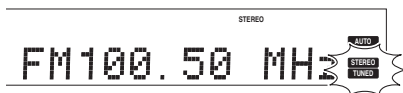

"TUNED" is displayed when a station is received.

Auto tuning : The next station is tuned automatically.

Manual tuning : Turn the knob or use the **MULTI Δ/∇** keys to select the desired station.

Presetting radio stations manually

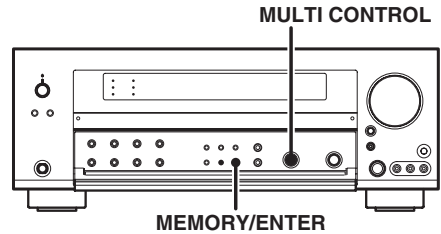

1 Tune to the station you want to store.

2 Press the **MEMORY/ENTER** key while receiving the station.

Blinks for 20 seconds

Lights for 20 seconds

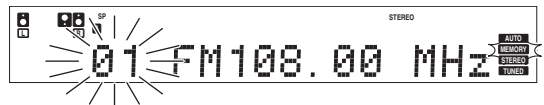

Proceed to step **3** within 20 seconds.
(If more than 20 seconds elapse, press the **MEMORY/ENTER** key again).

3 Use the **MULTI CONTROL** knob to select one of the station presets (1 – 40).

4 Press the **MEMORY/ENTER** key again to confirm the setting.

- Repeat steps **1**, **2**, **3**, and **4** to store as many stations as necessary.
- If you store a station at a previously used preset, the old station will be replaced by the new one.

Receiving preset stations

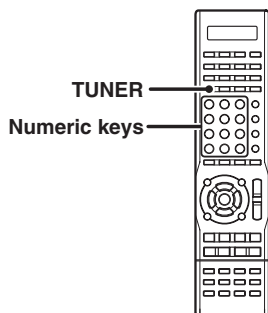

- 1** Press the **TUNER** key to select tuner as the source.
- 2** Enter the number of the preset station you want to receive (up to "40").

Press the Numeric keys in the following order:

For "15", press **+10**, **5**
 For "20", press **+10**, **+10**, **0**

- If you make a mistake entering a two digit number, press the **+10** key repeatedly to return to the original display and start again.



Receiving preset stations in order (P.CALL)

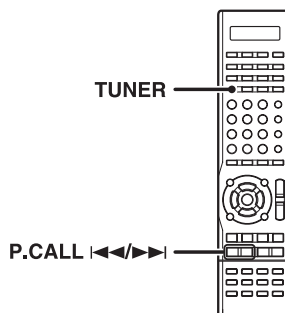

- 1** Press the **TUNER** key to select the tuner as the source.
- 2** Use the **P.CALL** **◀◀/▶▶** keys to select the desired station.

- Each time you press the key, another preset station is received in order.

Pressing the **P.CALL ▶▶** does the following:

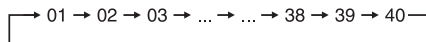

Pressing the **P.CALL ◀◀** does the following:

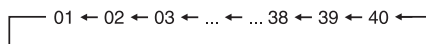

Holding down the **P.CALL ◀◀** or **▶▶** key, lets you skip through the presets, receiving each preset station at 0.5 second intervals.

Ambience effects

This receiver is equipped with listening modes that allow you to enjoy an enhanced sonic ambience with a variety of video sources.

In order to obtain the optimum effect from the surround modes, make sure to input the proper speaker settings beforehand.

→ 20

Surround modes

The below image is for 5.1 channel surround sound system which are;

- Dolby Digital
- DTS 96/24
- Dolby Pro Logic II
- DVD 6-channel
- DTS

The below image is for 6.1 channel surround sound system which are;

- Dolby Digital EX
- DTS-ES
- THX Surround EX
- Neo:6
- DSP mode

The below image is for 7.1 channel surround sound system which is;

- THX Select2 Cinema
- Dolby Pro Logic IIx

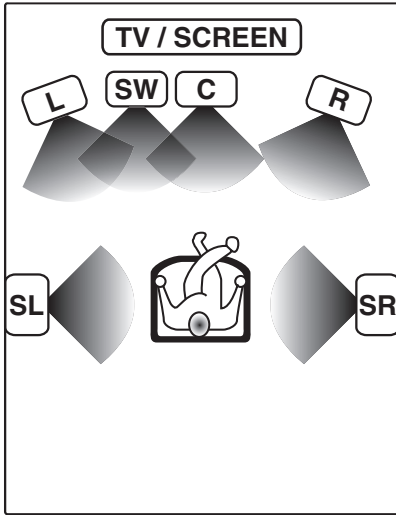

No Surround Back Speaker

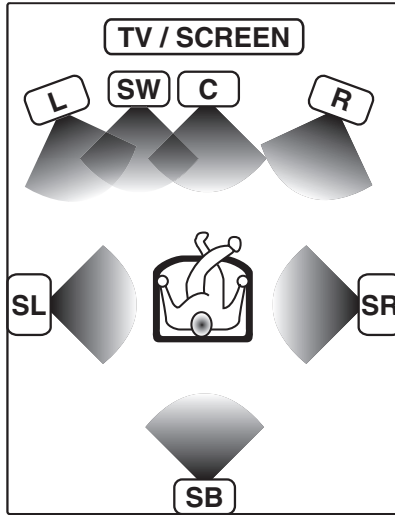

With Surround Back Speaker

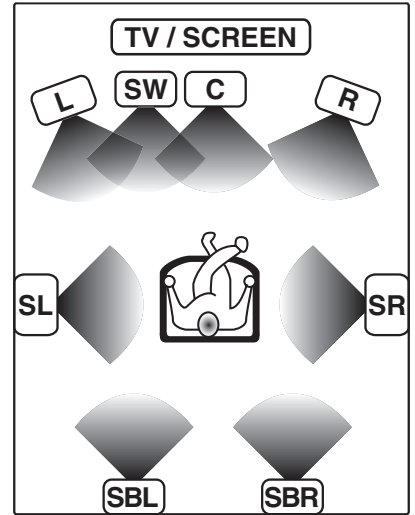

With Surround Back Left and Right Speakers

The below image is for Dolby Virtual Speaker mode.

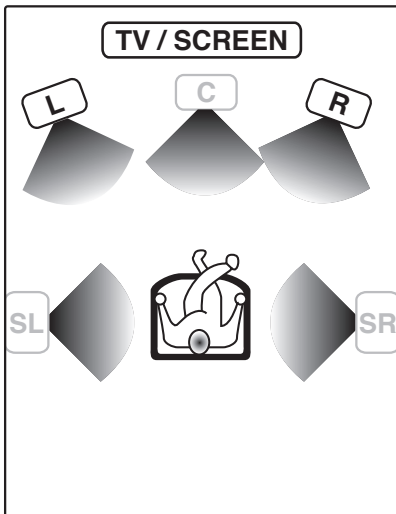

With Front Left and Right Speakers

L	Front Left Speaker
SW	Subwoofer
C	Center Speaker
R	Front Right Speaker
SL	Surround Left Speaker
SR	Surround Right Speaker
SB	Surround Back Speaker
SBL	Surround Back Left Speaker
SBR	Surround Back Right Speaker

Manufactured under license from Dolby Laboratories. "Dolby", "Pro Logic", "Surround EX" and the double-D symbol are trademarks of Dolby Laboratories.

"DTS", "DTS-ES", "Neo:6" and "DTS 96/24" are trademarks of Digital Theater Systems, Inc.



THX, Select2 and THX logo are trademarks of THX Ltd. THX may be registered in some jurisdictions. All rights reserved. Surround EX is a trademark of Dolby Laboratories. Used with permission.

Even if the speaker configuration is different from above, this receiver will let you enjoy Dolby Digital and DTS sources in a suitable condition for every speaker configuration.

Dolby Digital

The Dolby Digital surround format lets you enjoy up to 5.1 channels of digital surround sound from Dolby Digital program sources (such as Laserdisc or DVD software marked ). Compared with previous Dolby surround, Dolby Digital provides even better sound quality, greater spatial accuracy, and improved dynamic range.

Dolby Digital EX

Dolby Digital EX is an extension of Dolby Digital technology, Dolby Digital EX creates six full-bandwidth output channels from 6.1-channel sources. This is done using a matrix decoder that derives three surround channels from the two in the original recording. This is achieved by using three different surround signals, surround left, surround right, and surround back, each driving its own array of speakers. Think of it as adding a center channel for the rear speakers, which give more diffuse and natural surround effect, even if you wanted the ability to completely encircle the audience with sound, positioning sound effects exactly where they would be heard in real life. For best results, Dolby Digital EX should be used with movie soundtracks recorded with Dolby Digital Surround EX which contain a digital flag that will automatically activate this feature. However, for titles released prior to late 2001, this feature has to be activated manually.

Although Dolby Digital soundtracks incorporate a separate low frequency channel, connecting a subwoofer will also improve deep bass performance in the other surround modes. The indication "LFE" appears in the display when a signal is being input for this channel.

Dolby Pro Logic IIx and Dolby Pro Logic II

Dolby Pro Logic II was designed specifically to provide a new sense of spatiality, directionality and articulation of sounds from Dolby Surround encoded sources (such as video and Laserdisc software marked ). This is achieved with an intelligent, built-in feedback logic design, a matrix surround decoding and the decoding of stereo, full bandwidth surround outputs.

Dolby Pro Logic IIx enhanced Dolby Pro Logic II's features. It creates 6.1 channel and 7.1 channel surround sound from stereo or 5.1 channel signals. This feature provides you an astonishing ambience effect which makes you feel you are surrounded by natural sound. Especially 7.1 channel surround sound can produce real back sound from Surround Back speakers.

The Pro Logic IIx modes programmed into this model are "Movie", "Music" and "Game". The Pro Logic II modes programmed into this model are "Movie", "Music", "Game" and "Pro Logic". The "Movie" mode has preset characteristics to produce a calibrated, high-level surround sound playback while the "Music" mode has user-adjustable characteristics to offer the three optional controls, like "Dimension", "Center Width" and "Panorama" modes to allow optimization of the soundfields as desired. The "Dimension" control allows the user to gradually adjust the soundfield either towards the front or towards the rear; the "Center Width" control allows various adjustment of the left-center-right speakers' balance; the "Panorama" mode extends the front stereo image to include the surround speakers for an exciting "wraparound" effect with side wall imaging. The "Game" mode provides surrounded and exciting sound when you enjoy game or TV. Especially in Pro Logic IIx "Game" mode, base sound not only from Front and Center but also from Surround channel is added to Subwoofer. This provides ever more dynamic surround effects.

DSP mode

The DSP mode lets you add the atmosphere of a live concert or hall to almost any type of program source. The way a sound is heard in an actual environment depends on a variety of different factors. One of the most important is reverberation (the act of decaying elements of sound echoing in various places).

The DSP modes produce the feeling of presence by using the DSP to create reverberation, without spoiling the sound quality of the original signal. These modes are particularly effective when used with stereo program sources, like CD, television, and FM radio. You might enjoy trying the Arena, Jazz Club, Theater, Stadium or Disco mode the next time you watch a concert or sporting event!

Dolby Virtual Speaker

The Dolby Virtual Speaker features a virtual surround sound field. This implements an effect as if there are multiple speakers in the listening room.

Dolby Headphone

When headphones are used in music listening, the audio of the left (or right) channel reaches only the left (or right) ear so the listener cannot feel the presence of acoustic images on the front.

The Dolby Headphone simulates a virtual room and include its acoustic characteristics in the left and right headphone signals. As a result, the listener can hear the same components as in speaker listening through the left and right ears and therefore feel as if the sound source is located on the front of the listener.

Because of the same processing in "Pro Logic II Movie mode with Dolby Headphone" and "Pro Logic II Game mode with Dolby Headphone", their respective effectiveness is the same.

DTS

The DTS multi-channel audio format is available on CD, LD and DVD software. DTS is a strictly digital format and cannot be decoded inside most CD, LD or DVD players. For this reason, if you attempt to listen to DTS encoded software through the analog output of your new CD, LD or DVD player, you will experience digital noise in most cases. This noise can be quite loud if the analog output is connected directly to a high power amplification system. Proper measures for playing the digital output as described below should be taken to avoid this situation. To enjoy DTS Digital Surround playback, an external 5.1 channel DTS Digital Surround decoder system or an amplifier with a built-in DTS Digital Surround decoder must be connected to the digital output (S/P DIF, AES/EBU or TosLink) of a CD, LD or DVD player. All models are incorporated with the DTS decoder.

DTS-ES

DTS-ES (Digital Theater System-Extended Surround) presents 6.1 channels surround system with additional Surround Back channel which evolved from the conventional 5.1 channels surround system. DTS-ES format that was recorded in DVD, CD or LD comprises of two modes. DTS-ES Discrete 6.1 produces the discrete surround back which is completely independent and DTS-ES Matrix 6.1 produces the surround back which synthesised within the left and right surround channels using matrix technology. DTS-ES has perfect compatibility with the conventional 5.1 channels surround system. 6.1 channels surround with an additional surround back presents a more natural presence and surround effects by increasing the impression of the sound image from back. Programs which are recorded using DTS-ES technology consist of information flags which will be able to control the Discrete and Matrix mode. Thus, it can automatically select the best matched mode.

Neo:6

Neo:6 is a new technology which was developed by DTS. It can produce high grade 6 channels surround with an astonishing fidelity from 2 channels content. Neo:6 has 2 modes, "Cinema" mode is for movie playback and "Music" mode is for music playback.

DTS 96/24

DTS 96/24 made it possible to achieve a wide frequency range of over 40 kHz by increasing the sampling frequency to 96 or 88.2 kHz. Moreover, DTS 96/24's ability of 24 bit resolution offers the same frequency band and dynamic range as 96 kHz/24 bit PCM.

DTS 96/24 is, as with conventional DTS Surround, compatible with multi-channels. Therefore, sources recorded using DTS 96/24 technologies can be played in high sampling frequency, multichannel audio with ordinary DVDs and CDs.

DTS has a ".1" or "LFE" channel.

The indication "LFE" appears in the display when a signal is being input for this channel.

Note

LFE = Low Frequency Effects. This channel delivers separate non-directional bass signals to the subwoofer for more dynamic deep bass sound effects.

THX

THX is an exclusive set of standards and technologies established by the world-renowned film production company, Lucasfilm Ltd. THX grew from George Lucas' personal desire to make your experience of the film soundtrack, in both movie theatres and in your home theatre, as faithful as possible to what the director intended.

Movie soundtracks are mixed in special movie theatres called dubbing stages and are designed to be played back in movie theatres with similar equipment and conditions. This same soundtrack is then transferred directly onto Laserdisc, VHS tape, DVD, etc., and is not changed for playback in a small home theatre environment.

THX engineers developed patented technologies to accurately translate the sound from the movie theatre environment into the home, correcting the tonal and spatial errors that occur. On this product, when the THX indicator is on, THX features are automatically added in Cinema modes (e.g. THX Cinema, THX Surround EX):

Re-equalization (Re-EQ)

The tonal balance of a film soundtrack will be excessively bright and harsh when played back over audio equipment in the home because film soundtracks were designed to be played back in large movie theatres using very different professional equipment. Re-Equalization restores the correct tonal balance for watching a movie soundtrack in a small home environment.

Timbre Matching

The human ear changes our perception of a sound depending on the direction from which the sound is coming. In a movie theatre, there is an array of surround speakers so that the surround information is all around you. In a home theatre, you use only two speakers located to the side of your head. The Timbre Matching feature filters the information going to the surround speakers so that they more closely match the tonal characteristics of the sound coming from the front speakers. This ensures seamless panning between the front and surround speakers.

Adaptive Decorrelation

In a movie theatre, a large number of surround speakers help create an enveloping surround sound experience, but in a home theatre there are usually only two speakers. This can make the surround speakers sound like headphones that lack spaciousness and envelopment. The surround sounds will also collapse into the closest speaker as you move away from the middle seating position. Adaptive Decorrelation slightly changes one surround channel's time and phase relationship with respect to the other surround channel. This expands the listening position and creates - with only two speakers - the same spacious surround experience as in a movie theatre.

THX Select 2

Before any home theatre component can be THX Select 2 certified, it must incorporate all the features above and also pass a rigorous series of quality and performance tests. Only then can a product feature the THX Select 2 logo, which is your guarantee that the Home Theatre products you purchase will give you superb performance for many years to come. THX Select 2 requirements cover every aspect of the product including pre-amplifier performance and operation, and hundreds of other parameters in both the digital and analog domain.

DVD 6-channel mode

Using a DVD player or the like equipped with six (5.1) output channels and the receiver, you can enjoy multi-channel encoded DVD source material in all its splendor. Since the source signals are digital and each channel is input independently, the resulting sound quality, sense of spaciousness, and dynamic range are superb.

ASA (Advanced Speaker Array)

ASA is a proprietary THX technology which processes the sound fed to 2 side and 2 back surround speakers to provide the optimal surround sound experience. When you set up your home theater system using all eight speaker outputs (Left, Center, Right, Surround Right, Surround Back Right, Surround Back Left, Surround Left and Subwoofer) placing the two Surround Back speakers close together facing the front of the room as shown in the diagram will provide the largest sweet spot. If for practical reasons you have to place the Surround Back speakers apart, you will need to go THX Audio Set-up screen and choose the setting that most closely corresponds to the speaker spacing, which will re-optimize the surround sound-field. ASA is used in three new modes; THX Select 2 Cinema, THX MusicMode and THX Games Mode.

THX Select 2 Cinema mode.

THX Select 2 Cinema mode plays 5.1 movies using all 8 speakers giving you the best possible movie watching experience. In this mode, ASA processing blends the side surround speakers and back surround speakers providing the optimal mix of ambient and directional surround sounds.

DTS-ES (Matrix and 6.1 Discrete) and Dolby Digital Surround EX encoded soundtracks will be automatically detected in Select 2 Cinema mode if the appropriate flag has been encoded.

Some Dolby Digital Surround EX soundtracks are missing the digital flag that allows automatic switching. If you know that the movie that you are watching is encoded in Surround EX, you can manually select the THX Surround EX playback mode, otherwise THX Select 2 Cinema mode will apply ASA processing to provide optimum replay.

THX MusicMode.

For the replay of multi-channel music the THX MusicMode should be selected. In this mode THX ASA processing is applied to the surround channels of all 5.1 encoded music sources such as DTS, Dolby Digital and DVD-Audio to provide a wide stable rear soundstage.

THX Games Mode.

For the replay of stereo and multi-channel game audio the THX Games Mode should be selected. In this mode THX ASA processing is applied to the surround channels of all 5.1 and 2.0 encoded game sources such as analog, PCM, DTS and Dolby Digital. This accurately places all game audio surround information, providing a full 360 degree playback environment. THX Games Mode is unique as it gives you a smooth transition of audio in all points of the surround field.

THX Surround EX

THX Surround EX-Dolby Digital Surround EX is a joint development of Dolby Laboratories and the THX division of Lucasfilm Ltd.

In a movie theatre, film soundtracks that have been encoded with Dolby Digital Surround EX technology are able to reproduce an extra channel which has been added during the mixing of the program. This channel, called Surround Back, places sounds behind the listener in addition to the currently available front left, front center, front right, surround right, surround left and subwoofer channels. This additional channel provides the opportunity for more detailed imaging behind the listener and brings more depth, spacious ambience and sound localization than ever before.



Movies that were created using the Dolby Digital Surround EX technology, when released into the home consumer market may exhibit a Dolby Digital Surround EX logo on the packaging. A list of movies created using this technology can be found on the Dolby web site at <http://www.dolby.com>.

Only receiver and controller product bearing the THX Surround EX logo, when in the THX Surround EX mode, faithfully reproduce this new technology in the home.

This product may also engage the "THX Surround EX" mode during the playback of 5.1 channel material that is not Dolby Digital Surround EX encoded. In such case the information delivered to the Surround Back channel will be program dependent and may or may not be very pleasing depending on the particular soundtrack and the taste of the individual listener.

Surround play

DTS can be used when playing CD, DVD or LD software carrying the DTS mark.

Dolby Digital can be used when playing DVD or LD software bearing the  mark and Dolby Digital format digital broadcasts (etc.). Dolby Pro Logic can be used when playing video, DVD, or LD software bearing the  mark.

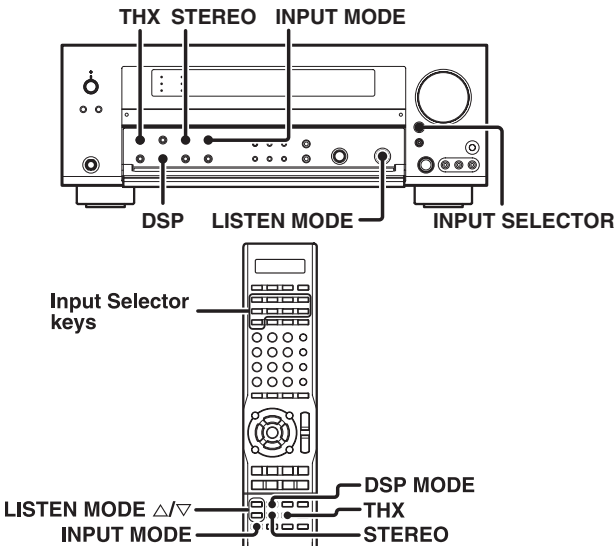

Preparations

- Turn ON related components.
- Complete "Preparing for surround sound". - [20]
- Use the **INPUT SELECTOR** key or **Input Selector** keys to select the component you wish to play back with surround sound.
- Use the **INPUT MODE** key to select the input mode (analog or digital) for the source you wish to play back. - [8]

Note

- Noise may be produced when a DTS source is played by selecting the analog input.

1 Start playing the video software.

2 Selecting the THX mode.

This mode creates a home theater environment which is able to reproduce a cinema surround sound system featuring improved special representation and acoustic imaging of surround channels by translating THX technology.

Press the THX key to switch the following setting :

- ① **THX OFF** : THX mode is turned OFF.
- ② **THX Select2 Cin** : Effective when watching movie.
- ③ **THX MusicMode** : Effective when listening to music.
- ④ **THX Games** : Effective when playing video game.
- ⑤ **THX Cinema** : Effective when watching movie.

- THX functions when the display segment is turned ON.
- The THX setting differs depending on the input selector.

3 Use the LISTEN MODE knob or LISTEN MODE Δ/∇ keys to select the listening mode.

The listening mode settings are stored separately for each input. If the input mode is set to full auto ("AUTO DETECT" lights), the receiver selects the optimal listening mode automatically based on the type of input signal and the speaker settings.

Each turn of the LISTEN MODE knob or press of the LISTEN MODE Δ/∇ keys switches the setting as listed below.









The listening mode settings are different depending on the type of input signal.

Dolby Digital Surround EX compliant disc :

Dolby Digital Surround EX compliant disc contains identification signals. When you choose **FULL AUTO** during "Input mode settings" (- [8]), this amplifier detects the identification signals and selects an optimum LISTEN mode automatically.

Sometimes we find some discs which are Dolby Digital Surround EX compliant discs but do not contain the identification signals. In this case, select one of the LISTEN modes which are for 6.1 or 7.1 channel surround mode.

When the Dolby Digital or Dolby Digital EX signal is input :

- ①  **D+THX Cinema** : Dolby Digital+THX Cinema*1
- ②  **D+THX Surround EX** : Dolby Digital+THX Surround EX*1
- ③  **D+PLIIx Movie+THX Cinema** : Dolby Digital+Pro Logic Iix Movie mode+THX Cinema*1
- ④ **PLIIx Movie+THX Cinema** : Pro Logic Iix Movie mode +THX Cinema*1
- ⑤ **Pro Logic+THX Cinema** : Pro Logic+THX Cinema*1
- ⑥ **Stereo+THX Cinema** : Stereo+THX Cinema*1
- ⑦  **D+THX Games** : Dolby Digital+THX Games*2
- ⑧ **2.0 THX Games** : Dolby Digital(2 channel signals) +2.0 THX Games*2
- ⑨  **D+THX MusicMode** : Dolby Digital+THX Music Mode.*3
- ⑩  **D+THX Select2 Cinema** : Dolby Digital+THX Select2 Cinema*4
- ⑪ **Dolby Digital** : Dolby Digital*5
- ⑫ **Dolby D EX** : Dolby Digital EX*5
- ⑬  **D+PLIIx Movie** : Dolby Digital+Pro Logic Iix Movie mode*5
- ⑭  **D+PLIIx Music** : Dolby Digital+Pro Logic Iix Music mode.*5
- ⑮ **PLIIx Movie** : Dolby Pro Logic Iix Movie mode*5
- ⑯ **PLIIx Music** : Dolby Pro Logic Iix Music mode*5
- ⑰ **PLIIx Game** : Dolby Pro Logic Iix Game mode*5
- ⑱ **PLII Movie** : Dolby Pro Logic II Movie mode*5
- ⑲ **PLII Music** : Dolby Pro Logic II Music mode*5
- ⑳ **PLII Game** : Dolby Pro Logic II Game mode*5
- ㉑ **Pro Logic** : Dolby Pro Logic*5
- ㉒ **Stereo** : stereo*5

When you select Dolby Digital "Dolby Digital" will be displayed.

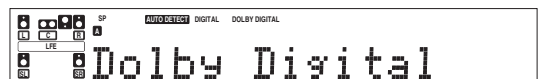

When the DTS or DTS-ES (matrix or discrete) signal is input :

- ① **DTS+Neo:6+THX Cinema** : DTS+Neo:6 Cinema+THX Cinema*1
- ② **DTS-ES Matrix 6.1+THX Cinema** : DTS-ES Matrix 6.1+THX Cinema*1
- ③ **DTS-ES Discrete 6.1+THX Cinema** : DTS-ES Discrete 6.1+THX Cinema*1
- ④ **DTS+THX Cinema** : DTS+THX Cinema*1
- ⑤ **DTS 96/24+THX Cinema** : DTS 96/24+THX Cinema*1
- ⑥ **Stereo+THX Cinema** : Stereo+THX Cinema*1
- ⑦ **Neo:6 Cinema+THX Cinema** : Neo:6 Cinema +THX Cinema*1
- ⑧ **DTS+THX Games** : DTS+THX Games*2
- ⑨ **2.0 THX Games** : DTS(2 channel signals)+2.0 THX Games*2
- ⑩ **DTS 96/24+THX Games** : DTS 96/24+THX Games*2
- ⑪ **DTS+THX MusicMode** : DTS+THX MusicMode*3
- ⑫ **DTS 96/24+THX MusicMode** : DTS 96/24 +THX MusicMode*3
- ⑬ **DTS+THX Select2 Cinema** : DTS+THX Select2 Cinema*4
- ⑭ **DTS 96/24+THX Select2 Cinema** : DTS 96/24+THX Select2 Cinema*4
- ⑮ **DTS-ES Mtrcx 6.1** : DTS-ES Matrix 6.1*5
- ⑯ **DTS-ES Dscrt 6.1** : DTS-ES Discrete 6.1*5
- ⑰ **DTS** : DTS*5
- ⑱ **DTS+Neo:6 Cin** : DTS+Neo:6 Cinema*5
- ⑲ **Neo:6 Cinema** : Neo:6 Cinema*5
- ⑳ **Neo:6 Music** : Neo:6 Music*5
- ㉑ **DTS 96/24** : DTS 96/24*5
- ㉒ **Stereo** : Stereo*5

When the analog signal or the digital signal (except for Dolby Digital or DTS signal) is input :

- ① **PLII Movie+THX Cinema** : Dolby Pro Logic II Movie mode +THX Cinema*1
- ② **Pro Logic+THX Cinema** : Dolby Pro Logic+THX Cinema*1
- ③ **Neo:6 Cinema+THX Cinema** : Neo:6 Cinema+THX Cinema*1
- ④ **Stereo+THX Cinema** : Stereo+THX Cinema*1
- ⑤ **2.0 THX Games** : 2.0 THX Games*2
- ⑥ **PLIIx Movie** : Dolby Pro Logic IIx Movie mode*5
- ⑦ **PLIIx Music** : Dolby Pro Logic IIx Music mode*5
- ⑧ **PLIIx Game** : Dolby Pro Logic IIx Game mode*5
- ⑨ **PLII Movie** : Dolby Pro Logic II Movie mode*5
- ⑩ **PLII Music** : Dolby Pro Logic II Music mode*5
- ⑪ **PLII Game** : Dolby Pro Logic II Game mode*5
- ⑫ **Pro Logic** : Dolby Pro Logic*5
- ⑬ **Neo:6 Cinema** : Neo:6 Cinema*5
- ⑭ **Neo:6 Music** : Neo:6 Music*5
- ⑮ **Stereo** : Stereo*5

- *1 THX Cinema mode only.
- *2 THX Games mode only.
- *3 THX MusicMode only.
- *4 THX Select2 Cin only.
- *5 THX OFF only.

- Dolby Digital or DTS signal having more channels than the maximum number of playback channels available using the receiver's current settings is input, downmixing is performed to match the number of available channels.

4 Adjust the volume.

DSP mode

This mode can be selected when digital signals other than Dolby Digital or DTS, or analog signal come in.
This mode can be selected when THX mode is off.

① **Pressing the DSP key or DSP MODE key will display the current DSP MODE status.**

② **Each press of the key will switch to the next status as shown below:**

- ① **Arena** : Arena mode.
- ② **Jazz Club** : Jazz Club mode.
- ③ **Theater** : Theater mode.
- ④ **Stadium** : Stadium mode.
- ⑤ **Disco** : Disco mode.

- The DSP mode selection is displayed for approximately 3 seconds.

Switching the LISTEN mode to Stereo temporarily

Pressing the **STEREO** key changes the currently selected LISTEN mode into Stereo. It will be changed back to the original LISTEN mode by pressing the **STEREO** key again.

- If the power is turned off and turned back on, or the input selector is switched to another and switched back, the LISTEN mode will be back to the original one.

Notes

- Depending on the type of the signal or speaker setting, some listening modes cannot be selected.
- When playback is started, the sound may be cut or interrupted before the input source is confirmed as Dolby Digital or DTS.
- To enjoy Dolby Digital surround (as well as all the other listening modes) from a single component, be sure to use a Dolby Digital compatible source component.
- Dialogue Normalization (Dial Norm) is a feature of Dolby Digital. It is able to automatically maintain the overall audio output level constant.



When playing some Dolby Digital sources, you may see in the display a message "DIALNORM OFFSET xxdB". This is because some soundtracks may be recorded either louder or quieter than normal. The xx number shows by how much.

For example, if the message says "DIALNORM OFFSET +4dB" you know that this particular recording was encoded 4dB louder than normal. If you wish, you can turn down the volume control by 4dB to keep the playback level consistent.

Virtual modes

The following modes allow you to enjoy astonishing ambience effect even when you use only two speakers or listen through headphones.

- In the Dolby Virtual Speaker and Dolby Headphone modes, the desired listen mode may be unable to be selected depending on the reproduced signals. → 36

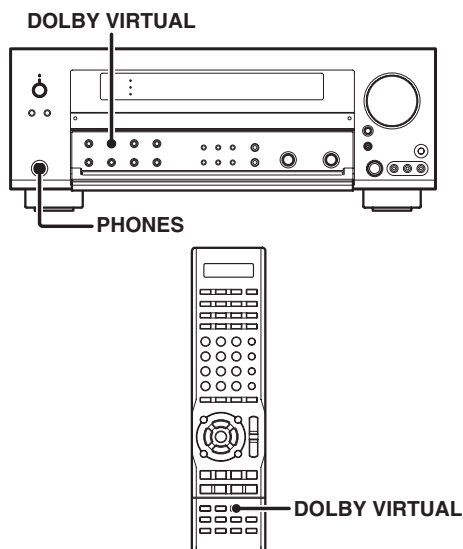

How to set the Dolby Virtual Speaker mode (when not using headphones):

Press the **DOLBY VIRTUAL** key for the following selections:

- ① **DOLBY VS WIDE** : The virtual surround effect can be given added expansion and spatial feeling. (DOLBY VS indicator lights up)
- ② **DOLBY VS REF** : Standard setting.* (DOLBY VS indicator lights up)
- ③ **DOLBY VS OFF** : Cancel (DOLBY VS indicator goes off)

* This mode can be selected only when the surround speaker setting is OFF.

How to set the Dolby Headphone mode (when using headphones):

Press the **DOLBY VIRTUAL** key for the following selections:

- ① **DOLBY H DH 1** : Monitor room in a studio with small amount of reverberations. (DOLBY H indicator lights up)
- ② **DOLBY H DH 2** : General listening with optimum amount of reverberations. (DOLBY H indicator lights up)
- ③ **DOLBY H DH 3** : Wide space such as a movie theater. (DOLBY H indicator lights up)
- ④ **DOLBY H OFF** : Cancel (DOLBY H indicator goes off)

- The Dolby Virtual Speaker mode will be available when the **SPEAKERS A** is ON and **SPEAKERS B** is OFF.
- Dolby Virtual Speaker is effective for sampling frequencies of 32kHz, 44.1kHz and 48kHz. Dolby Headphone is effective for sampling frequencies of 44.1kHz and 48kHz.

DVD 6-channel playback

Using a DVD player or the like equipped with six (5.1) output channels and the receiver, you can enjoy surround sound playback.

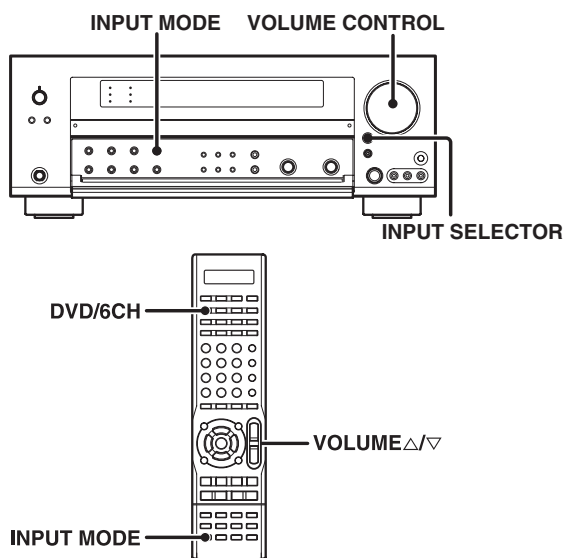

Preparations

- Connect your DVD player to the DVD/6CH jacks of the receiver. → 10
- Turn on all other components that will be used.
- Complete "Preparing for surround sound". → 20

1 Use the **INPUT SELECTOR** key or **DVD/6CH** key to select "DVD/6CH" as the input source.

2 Select "6CH INPUT" by pressing the **INPUT MODE** key.

- If speaker system B is on when "6CH INPUT" is selected as the input mode, it switches off and speaker system A turns on automatically.
- The indication "6CH INPUT" appears in the display during DVD 6-channel mode selection.

3 Start playback of the DVD software.

4 Adjust the volume.

Notes

- It is not possible to adjust the sound quality (**SETUP, SOUND, LISTEN MODE, ACTIVE EQ, THX, STEREO, DSP MODE, LOUDNESS and TONE** key will not be functional) of the channels separately when the receiver is in the 6CH INPUT mode. Adjust the volume with the controls of the DVD player. For the powered subwoofer, you can adjust the volume of the subwoofer using the subwoofer's own volume control.

Adjusting the sound

You can make further adjustments to the sound while listening to playback in the surround mode.

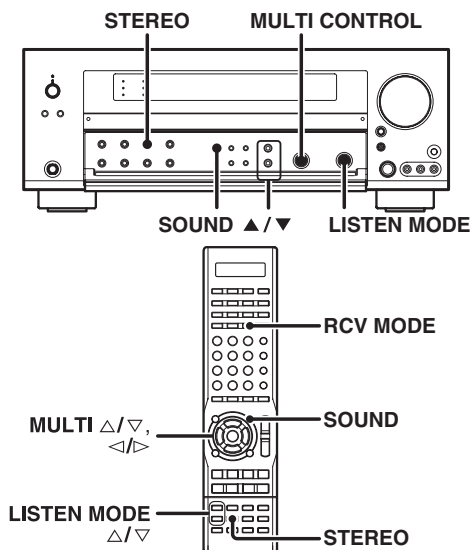

➊ For the remote control unit, press the RCV MODE key to switch to receiver mode.

➋ Press the SOUND key and then use the ▲/▼ keys or MULTI </> keys until the desired item appears in the display.

Each time you press the ▲/▼ keys or MULTI </> keys, the menu changes as follows:

Note that some items are not displayed depending on speaker settings and listening modes.

- ➀ CNTR (Center speaker level adjustment)*
- ➁ SR (Surround Right speaker level adjustment)*
- ➂ SB (Surround Back speaker level adjustment)*
- ➃ SBR (Surround Back Right speaker level adjustment)*
- ➄ SBL (Surround Back Left speaker level adjustment)*
- ➅ SL (Surround Left speaker level adjustment)*
- ➆ SUBW (Subwoofer level adjustment)*
- ➇ INPUT (Input level adjustment - analog mode only) → 28
- ➈ MIDNIGHT (Midnight mode ON/OFF - Dolby Digital and DTS mode only)
- ➉ PANORAMA (Panorama mode ON/OFF)**
- ➊ DIMENSION (Dimension adjustment)**
- ➋ CENTER WIDTH (Center width adjustment)**
- ➌ CENTER IMAGE (Center image adjustment - Neo:6 Music mode only)
- ➍ DUAL MONO (Dual Mono selection - Dolby Digital mode only)

* The adjustment is only temporary for the current input selection. The value will return automatically to the original setup value when the power is turned on/off.

** Pro Logic IIx Music and Pro Logic II Music mode only.

• If you have selected "SB NML/THXx1" or "SB LARGEx1", "SBR" and "SBL" are not appeared but "SB" is appeared on the Display.

➌ Use the MULTI CONTROL knob or MULTI ▲/▼ keys to adjust the setting as desired.

• The adjustment item is displayed for approximately 20 seconds.

➍ Press the SOUND key again to return to the input indication.

Midnight mode (Dolby Digital and DTS mode only)

When watching movies at night, you might not be able to raise the volume as loud as normal. Midnight mode compresses the dynamic range of previously specified heavy sound passage of the Dolby Digital and DTS sound track (like scenes with sudden increases in volume) to minimize the difference in volume between the scenes with heavy sound passage and scenes with normal sound passage. This makes it easy to hear all of the sound track, even when listening at low volumes.

➊ Press the SOUND key, then press the ▲/▼ keys or MULTI </> keys until "MIDNIGHT" appears on the display.

• This can be selected only if CD/DVD, DVD/6CH, VIDEO 2 or VIDEO 3 is selected as the source and the input signal is set to "Dolby Digital" or "DTS".

➋ Use the MULTI CONTROL knob or MULTI ▲/▼ keys to select the ON or OFF setting.



• The adjustment item is displayed for approximately 20 seconds.
• Some Dolby Digital or DTS software may not be compatible with the Midnight mode.

➌ Press the SOUND key again to return to the input indication.

Panorama mode (Pro Logic IIx Music mode and Pro Logic II Music mode only)

When listening to music, you will be able to enjoy the "wrap-around" sound effect when you adjust the panorama mode.

➊ Press the SOUND key, then press the ▲/▼ keys or MULTI </> keys until "PANORAMA" appears on the display.

➋ Use the MULTI CONTROL knob or MULTI ▲/▼ keys to select PANORAMA ON or OFF.

- ➀ PANORAMA ON : PANORAMA mode is ON.
- ➁ PANORAMA OFF : PANORAMA mode is OFF.

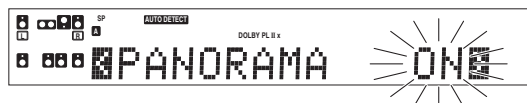

➌ Press the SOUND key again to return to the input indication.

Dimension mode (Pro Logic IIx Music mode and Pro Logic II Music mode only)

When listening to music with certain recordings, you will also be able to achieve a suitable balance from all the speakers by adjusting the dimension mode.

- 1 Press the **SOUND** key, then press the **▲/▼** keys or **MULTI** **</>** keys until "DIMENSION" appears on the display.
- 2 Use the **MULTI CONTROL** knob or **MULTI** **△/▽** keys to adjust the soundfield towards the rear or the front.

Soundfield is adjusted towards the front.

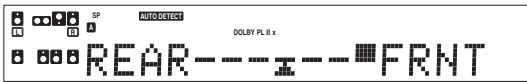

Soundfield is adjusted towards the rear.

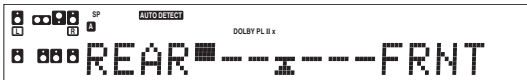

- 3 Press the **SOUND** key again to return to the input indication.

Center Width mode (Pro Logic IIx Music mode and Pro Logic II Music mode only)

Center width adjustment allows you to enjoy an enhanced sound when listening to music through center image from only center speaker, or left and right speakers or various combinations adjustments.

- 1 Press the **SOUND** key, then press the **▲/▼** keys or **MULTI** **</>** keys until "CENTER WIDTH" appears on the display.
 - The CENTER WIDTH indication scrolls across the display.
 - When the center speaker is switched OFF, this mode will not be effective.
- 2 Use the **MULTI CONTROL** knob or **MULTI** **△/▽** keys to adjust the left-center-right output.

Center image will be heard from center speaker only.

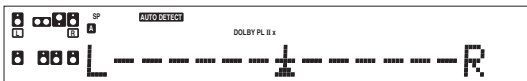

Center image will be heard from left and right speakers only.

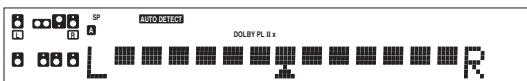

- When in other position, center image from center speaker, left and right speakers can be heard simultaneously with various combinations.

- 3 Press the **SOUND** key again to return to the input indication.

Center Image mode (Neo:6 Music mode only)

In the CENTER IMAGE setting mode of the Neo:6 Music listen mode, it is possible to enhance the center channel audio by adjusting the center signal component.

- 1 Press the **SOUND** key, then press the **▲/▼** keys or **MULTI** **</>** keys until "CENTER IMAGE" appears on the display.



- When the center speaker is switched OFF, this mode will not be effective.

- 2 Use the **MULTI CONTROL** knob or **MULTI** **△/▽** keys to adjust the left-center-right output.

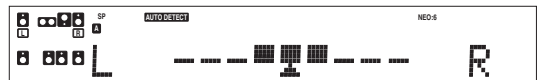

- Adjust the center component level.

- 3 Press the **SOUND** key again to return to the input indication.

Dual Mono mode (Dolby Digital mode only)

When the Dolby Digital source have Multiplex sound, you can select Main / Sub sound for Audio output.

- 1 Press the **SOUND** key, then press the **▲/▼** keys or **MULTI** **</>** keys until "DUAL MONO" appears on the display.

- This can be selected only if CD/DVD, DVD/6CH, VIDEO 2 or VIDEO 3 is selected as the source and the LISTEN mode is set to "Dolby Digital".

- 2 Use the **MULTI CONTROL** knob or **MULTI** **△/▽** keys for the following selection.

- 1 **Main** : Multiplex Main channel output.
- 2 **Sub** : Multiplex Sub channel output.
- 3 **Main + Sub** : Multiplex Main + Sub channel output.
- 4 **Stereo** : Main channel from the left speaker. / Sub channel from the right speaker.

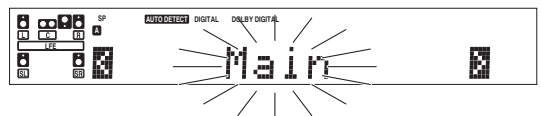

- The adjustment item is displayed for approximately 20 seconds.

- 3 Press the **SOUND** key again to return to the input indication.

96kHz LPCM playback

The receiver is compatible with the 96kHz LPCM playback. To play a 96kHz DVD, set the listen mode other than DSP mode. (96kHz fs indicator lights up)

- When the listen mode is set to DSP mode, the listen mode will automatically be Stereo.

Convenient functions

Display dimmer adjustment

The dimmer function lets you select the brightness of the receiver's display. You might find this useful if you darken your room to watch movies or listen to music.

For the remote control unit, press the RCV MODE key to switch to receiver mode.

Each time you press the DIMMER key, the display brightness changes among the three available settings.

Select the brightness level you find most pleasing.

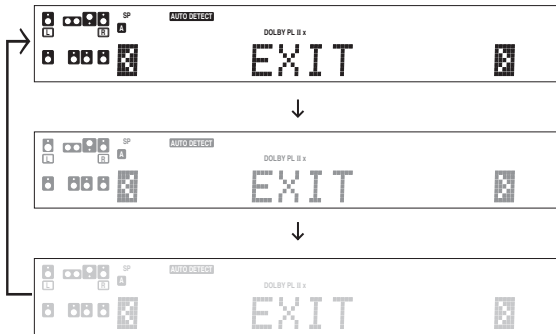

Sleep timer

The sleep timer function turns the receiver OFF (to the standby mode) automatically when the set timer period has elapsed. The sleep timer period can be set in 10-minute steps up to 90 minutes.

For the remote control unit, press the RCV MODE key to switch to receiver mode.

Press the SLEEP key repeatedly until the desired period before turning the receiver OFF (standby mode) is displayed.

- Each press increments the sleep timer period by 10 minutes.
10 → 20 → 3070 → 80 → 90 → Cancel → 10 → 20 → ...

The "SLEEP" indicator lights up



- Pressing the SLEEP key after the sleep timer has started allows you to check the remaining time period.
- To cancel the sleep timer, turn the receiver OFF (standby mode) or press the SLEEP key repeatedly until the Sleep timer indicator disappears.

Basic remote control operations for other components

The remote control supplied with this receiver is also capable of controlling components from a variety of manufacturers once you register the appropriate setup codes into the remote control unit.

Low battery warning

Replace all two batteries with new ones when you notice a shortening of the distance from which the remote control will operate. The remote control is designed to retain setup codes in memory while you change batteries.

Registering setup codes for other components

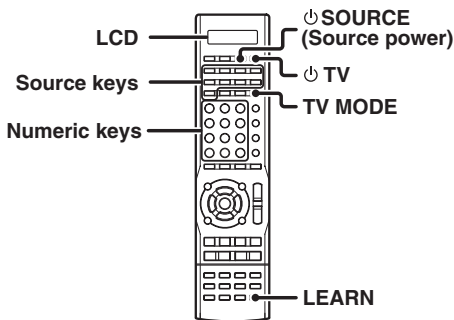

1 Find the setup code of the component to be registered.

- Refer to the setup code lists to find the setup code for the component to be registered. - 45

2 Press the Source keys (DVD/6CH, VIDEO 1, VIDEO 2, VIDEO 3, CD/DVD, MD/TAPE, PHONO, AV AUX, TV MODE).

The following table shows the type of components that can be registered in each Source key.

Source key	Other components	LCD display
TUNER	Fixed to receiver operation mode.	RCV
DVD/6CH	DVD	DVD
CD/DVD	CD and MD (Kenwood)	CD
MD/TAPE	CD and MD (Kenwood)	CD
VIDEO 1 , AV AUX	VCR and PVR	VCR
VIDEO 2	Cable and DTV decoder	CABLE
VIDEO 3	DSS	DSS
PHONO	Additional key for re-assigning	PHONO
TV MODE	TV/VCR combo, TV/DVD combo, TV	TV

- PHONO key has to re-assigned to another key before a setup code can be registered. - 43
- While in Tuner mode, setup code function will not be available.

3 Press and hold the LEARN key until the blinks twice, then release the LEARN key.

4 Press the Numeric keys to enter the four-digit code for the component to be registered.

- If performed correctly, will blink twice.
- Point the remote control at the component and press SOURCE (Source power) key once. It should turn on/off but if it does not, repeat step 2 to 4.
- If the component still does not work, try searching for the code.

5 Repeat steps 2 to 4 to register additional components until all components have been registered.

Note

Although each setup code is designed to work with a number of different models, certain codes may not work with some models. (Also, certain codes may only operate some of the functions available on a given model.)

Searching for your codes

If your component does not respond after trying all the codes listed for your component, or if your component is not listed at all, try searching for your code.

For example, to search for code for your TV:

1 Press the TV MODE key once. Next, press and hold the LEARN key until blinks twice, then release the LEARN key.

2 Press the Numeric key to enter **9** , **9** , **1** .

- will blink twice.

3 Point the remote control at the TV and slowly alternate between pressing the TV and TV MODE key.

- Stop when the TV turns on/off.
- In the search mode, the remote control will send IR codes from its library to the selected device, starting with the most popular code first.

4 Press the LEARN key once to lock in the code.

5 To search for the codes of your other components, repeat steps 1 through 4, but substitute the appropriate key (i.e., DVD/6CH, VIDEO 1, VIDEO 2, VIDEO 3, CD/DVD, MD/TAPE, PHONO, AV AUX, TV MODE, SOURCE).

- PHONO key has to be re-assigned to another key before a setup code can be programmed.

Checking the codes

If you have setup the remote control using the procedures described in "Searching for your codes", you may need to find out which four-digit code is operating your equipment:

For example, to find out which code is operating your TV:

1 Press the TV MODE key once. Next, press and hold the LEARN key until blinks twice, then release the LEARN key.

2 Press the Numeric key to enter **9** , **9** , **0** .

- will blink twice.

3 To view the code for the first digit, press "1" once. Wait for 3 seconds, counts the number of times blinks (e.g., blinks=3) and write down that number.

- If a code digit is "0", the will not blink.

4 Repeat step 3 three more times for the remaining digits. Use "2" for the second digit, "3" for the third digit, and "4" for the fourth digit.

5 To check the codes of your other components, repeat steps 1 through 4, but substitute the appropriate key (i.e., DVD/6CH, VIDEO 1, VIDEO 2, VIDEO 3, CD/DVD, MD/TAPE, PHONO, AV AUX, TV MODE) for the component you are checking.

- As suggested earlier on, write down each of the four-digit code.
- PHONO key has to be re-assigned to another key before a setup code can be programmed.

Re-assigning device keys

The remote control can be setup to control second TV or VCR, or any combination of eight home entertainment components.

For example, to control the operation of two different VCR using the remote control, the user need to re-assign the unused **VIDEO 2** key to operate the second VCR (VIDEO 1) as follows:

1 Press and hold the LEARN key until  blinks twice, then release the LEARN key.

2 Press the Numeric key to enter  ,  , .

-  will blink twice.

3 Press VIDEO 1 key once, then press the VIDEO 2 key once.

- The user now can operate VIDEO 2 as a second VCR along with VIDEO 1.
- Refer to the table in the previous page for the combination of source keys and the other components assignment. - [42]

4 To re-assign other device keys, repeat steps 1 through 3 by substituting the key sequence from the below chart for the most popular components:

To re-assign key



Sequence	Perform
TV MODE as 2nd VIDEO 1 key LEARN	9 9 2 VIDEO 1 TV MODE
TV MODE as 2nd VIDEO 2 key LEARN	9 9 2 VIDEO 2 TV MODE
TV MODE as 2nd CD/DVD key LEARN	9 9 2 CD/DVD TV MODE
TV MODE back to TV MODE key LEARN	9 9 2 TV MODE TV MODE
VIDEO 1 as 2nd TV MODE key LEARN	9 9 2 TV MODE VIDEO 1
VIDEO 1 as 2nd VIDEO 2 key LEARN	9 9 2 VIDEO 2 VIDEO 1
VIDEO 1 as 2nd CD/DVD key LEARN	9 9 2 CD/DVD VIDEO 1
VIDEO 1 back to VIDEO 1 key LEARN	9 9 2 VIDEO 1 VIDEO 1

5 To clear the re-assignment and reset the remote control to its original operation mode:

1 Press and hold the LEARN key until  blinks twice, then release the LEARN key.

2 Press the Numeric key to enter  ,  , .

3 Press VIDEO 2 key twice.

- When a re-assignment is done,  will blink twice to confirm your choice. At that time, you will need to program the remote control in order to control the new component.
- If an invalid key sequence is entered,  blink once and return to normal operation.
- When in Tuner mode, re-assignment is not available.

Operating other components

This operation lets you operate the registered components.

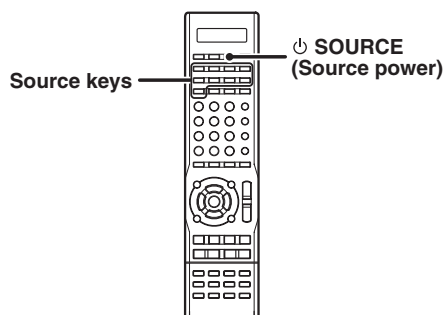

1 Use the Source keys to select the component you desire.

- Pressing the source keys also changes the input selector on the receiver.





2 Press the  SOURCE key.

- To return to the receiver operation mode, press the **RCV MODE** key.

3 Press the operation keys you desire. - [49]

- The remote control mode remains at the selected input. If you wish to operate another component, repeat step 2 or 3.

Resetting the Remote Control

- To initialize the remote control, press the **LEARN** key until the  blinks twice. Then press the Numeric key to enter  ,  ,  . The  will blink twice.

Storing the remote control code of the other components

The remote control unit can store the remote control code of the other components and you can operate the other components from the remote control unit. The remote control code is stored on the key or memory of the remote control unit.

Storing on the key

You can store the remote control code to the key as shown below:

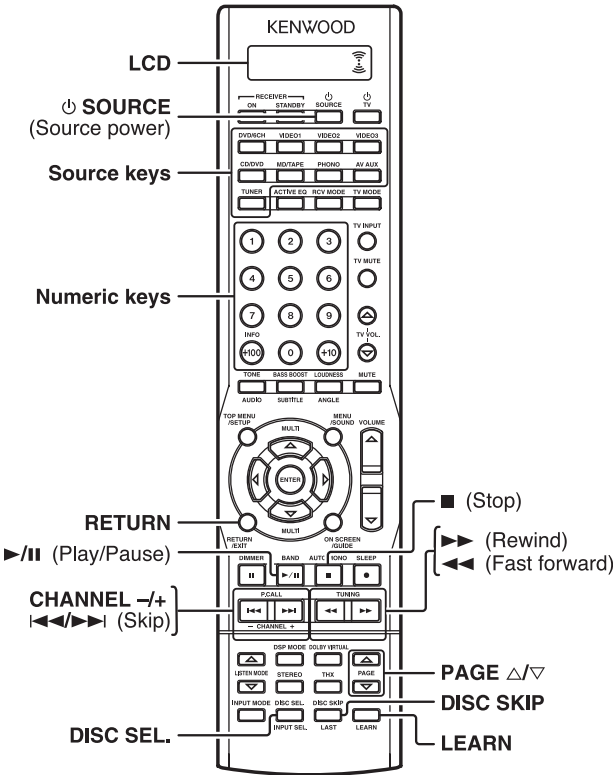

1 Point the infrared ray system part of another remote control unit to the remote sensor of the remote control unit.

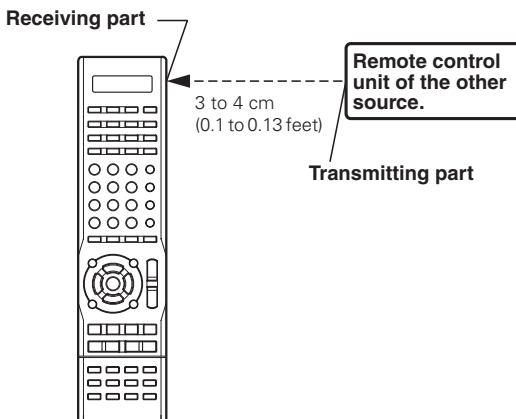

2 Press and hold the LEARN key for 3 seconds until blinks twice, then release the LEARN key.

3 Press the Numeric key to enter **9**, **7**, **5**.

4 Press any of the Source keys (DVD/6CH, VIDEO 1, VIDEO 2, VIDEO 3, CD/DVD, PHONO, AV AUX, MD/TAPE, TV MODE) to select the input of the desired remote control unit.

- While in Tuner mode, learning code function is not available.

5 Press the desired key of the remote control unit.

- "LEARN" and appear on the display.

6 From the remote control unit of the other source, press the key that you want to store.

- The remote control code is sent to the remote control unit.
- "OK" appears when finished.
- If the code cannot be stored after a few attempts, "ERROR" will appear. Repeat from step 2 onwards.

7 The remote control code is stored on the key of this remote control unit.

8 Repeat step 4 to 6 to store additional components until all the desired components are stored.

9 To exit the learning mode, press and hold the LEARN key for 3 seconds until blinks twice.

10 To clear the stored remote control code of the other sources:

1 Press and hold the LEARN key for 3 seconds until blinks twice, then release the LEARN key.

2 Press the Numeric key to enter **9**, **7**, **6**.

3 Press the Source key, then press the stored key twice until blinks twice.

- blinks twice to indicate that the stored remote control code is deleted.

Setup code chart

DVD player

Maker	Setup codes
Allegro	0869
Apex Digital	0672, 0717, 1004, 0794, 1061, 1056, 0797, 1020, 0796
Blaupunkt	0717
Blue Parade	0571
Broksonic	0695
CineVision	0869
Coby	1086
CyberHome	0816
Daewoo	0784, 0869, 0833, 1172
Denon	0490
DVD2000	0521
Emerson	0591, 0675
Enterprise	0591
Fisher	0670
Funai	0675
Gateway	1158
GE	0522, 0717
Go Video	0744, 0869, 1730, 0715, 0833, 1158, 0783, 1099
Greenhill	0717
Hitachi	0573, 0664
Hiteker	0672
Initial	0717
InterAct	0697
JVC	0558, 0623, 0867
Kenwood	0490, 0534, 0737, 0682
KLH	0717, 1020
Koss	0651
Lasonic	0798
LG	0591, 0869
Lite-On	1058, 1158
Mad Catz	1108
Magnavox	0503, 0539, 0675
Marantz	0539
Memorex	0695
Microsoft	0522
Mintek	0717
Mitsubishi	1521, 0521
Nesa	0717
Onkyo	0503
Oritron	0651
Panasonic	0490, 1762
Pelican Accessories	0731
Philips	0503, 0539, 0646, 0885, 0675
Pioneer	0525, 0571
Polaroid	1061, 1086
Polk Audio	0539
Proscan	0522
Qwestar	0651
RCA	0522, 0571, 0717, 0822
Rio	0869
Rotel	0623
Saitek	0731
Sampo	0752
Samsung	0490, 0573, 0820
Sansui	0695
Sanyo	0873, 0695, 0670
Sharp	0630, 0752
Shinsonic	0533

DVD player (continued)

Maker	Setup codes
Sonic Blue	0869, 1099
Sony	0533, 0864, 0772, 1033
Sylvania	0675
Symphonic	0675
Technics	0490
Theta Digital	0571
Thrustmaster	0498
Toshiba	0503, 1154, 0695
Urban Concepts	0503
Xbox	0522
Yamaha	0490, 0539, 0545
Zenith	0503, 0591, 1135, 0869

TV

Maker	Setup codes
Admiral	0093, 0463
Advent	0761, 1933
Aiko	0092
Akai	0812, 0702, 0030, 0672
Albatron	0843, 0700
America Action	0180
Anam	0180
AOC	0030
Apex Digital	0748, 0765, 1943
Audiovox	0451, 0180, 0092, 0623
Bell & Howell	0154
BenQ	1032
Bradford	0180
Broksonic	0236, 0463, 1935
Candle	0030
Carnivale	0030
Carver	0054
Celebrity	0000
Celera	0765
Changhong	0765
Citizen	0060, 0030, 0092
Clarion	0180
Commercial Solutions	1447, 0047
Contec	0180
Craig	0180
Crosley	0054
Crown	0180
Curtis Mathes	0047, 0054, 0154, 0451, 0093, 0060, 0702, 0030, 0145, 0166
CXC	0180
Daewoo	0451, 1661, 0623, 0672, 0092, 0661
Dell	1080
Denon	0145
Dumont	0017
Durabrand	0463, 0180, 0178, 0171, 1034
Electroband	0000
Emerson	0154, 0236, 0463, 0180, 0178, 0171, 0623, 1963
Envision	0030
ESA	0812, 0171
Fisher	0154
Fujitsu	0683, 0853
Funai	0180, 0171
Futuretech	0180
Gateway	1756, 1755
GE	1447, 0047, 0051, 0451, 0178
Gibraltar	0017, 0030
GoldStar	0030, 0178
Grunpy	0180
Haier	1034
Hallmark	0178
Harman/Kardon	0054
Harvard	0180
Havermly	0093
Helios	0865
Hello Kitty	0451
Hisense	0748
Hitachi	1145, 0145
Infinity	0054

Setup code chart

TV (continued)

Maker	Setup codes
Inteq	0017
JBL	0054
JCB	0000
Jensen	0761, 1933
JVC	0053, 1923, 1253, 0731
KEC	0180
Kenwood	0030
KLH	0765
KTV	0180, 0030
LG	0178, 0700, 1934, 0856
LXI	0047, 0054, 0154, 0156, 0178
Magnavox	1454, 0054, 0030, 0706
Marantz	0054, 0030, 0704
Matsushita	0250
Maxent	1755
Megapower	0700
Megatron	0178, 0145
Memorex	0154, 0463, 0150, 0178
MGA	0150, 0030, 0178
Midland	0047, 0017, 0051
Mitsubishi	0093, 1250, 0150, 0178
Monivision	0843, 0700
Motorola	0093
MTC	0060, 0030
Multitech	0180
NAD	0156, 0178
NEC	0030, 1704
Nikko	0030, 0178, 0092
Norcent	0748, 0824
NTC	0092
Onwa	0180
Optimus	0154, 0250, 0166
Optoma	0887
Optonica	0093
Orion	0236, 0463
Panasonic	0250, 0051, 1946, 1941, 1947
Penney	0047, 0156, 0051, 0060, 0030, 0178
Philco	0054, 0030
Philips	1454, 0054, 0690, 1961
Pilot	0030
Pioneer	0166, 0679
Portland	0092
Prima	0761, 1933
Princeton	0700
Prism	0051
Proscan	1447, 0047
Proton	0178
Pulsar	0017
Quasar	0250, 0051
RadioShack	0047, 0154, 0180, 0030, 0178
RCA	1447, 0047, 0679, 1948, 0090, 1547, 1953
Realistic	0154, 0180, 0030, 0178
Runco	0017, 0030
Sampo	0030, 1755
Samsung	0060, 0812, 0702, 0030, 0178, 1959, 1060
Sansui	0463, 1935
Sanyo	0154

TV (continued)

Maker	Setup codes
Scotch	0178
Scott	0236, 0180, 0178
Sears	0047, 0054, 0154, 0156, 0178, 0171
Sharp	0093
Sheng Chia	0093
Sony	0000, 1925
Soundesign	0180, 0178
Squareview	0171
SSS	0180
Starlite	0180
Studio Experience	0843
Supreme	0000
SVA	0748, 0865, 0872
Sylvania	0054, 0030, 0171, 1963
Symphonic	0180, 0171
Tandy	0093
Tatung	1756
Technics	0250, 0051
Techwood	0051
Teknika	0054, 0180, 0150, 0060, 0092
Telefunken	0702
TMK	0178
TNCi	0017
Toshiba	0154, 1256, 0156, 0060, 1356, 1936, 1935, 1704, 1945
TVS	0463
V Inc.	1756, 0885
Vector Research	0030
Victor	0053
Vidikron	0054
Vidtech	0178
Viewsonic	1755, 0885
Wards	0054, 0030, 0178
Waycon	0156
Westinghouse	0889
White Westinghouse	0463, 0623
Yamaha	0030
Zenith	0017, 0463, 0178, 0092

HDTV [TV]

Maker	Setup codes
Mitsubishi	0150
Panasonic	0250
Pioneer	0679
RCA	1447
Samsung	0812, 0702
Toshiba	1256

TV/VCR Combination [TV]

Maker	Setup codes
America Action	0180
Audiovox	0180
Emerson	0236
JVC	1923
LG	1934
Samsung	1959
Sony	1925
Toshiba	1936

TV/DVD Combination [TV]

Maker	Setup codes
Advent	1933
Apex Digital	1943
Broksonic	1935
Emerson	1963
Jensen	1933
Panasonic	1941
Philips	1961
Prima	1933
RCA	1948
Sansui	1935
Sylvania	0171, 1963
Toshiba	1935

Setup code chart

DSS

Maker	Setup codes
AlphaStar	0772
Chaparral	0216
Crossdigital	1109
DirecTV	0392, 0566, 0639, 1639, 1142, 0247, 0749, 1749, 0724, 0819, 1856, 1076, 1109, 0099, 1108, 1414, 1640, 1442
Dish Network System	1005, 0775, 1775
Dishpro	1005, 0775, 1775
Echostar	1005, 0775, 1775
Expressvu	0775, 1775
GE	0566
General Instrument	0869
GOI	0775, 1775
Hisense	1535
Hitachi	0819, 1250
HTS	0775, 1775
Hughes Network Systems	1142, 0749, 1749, 1442
I-Lo	1535
JVC	0775, 1775
LG	1414
Magnavox	0724, 0722
Memorex	0724
Mitsubishi	0749
Motorola	0869
Next Level	0869
Panasonic	0247, 0701
Paysat	0724
Philips	1142, 0749, 1749, 0724, 1076, 0722, 0099, 1442, 0856
Proscan	0392, 0566
Proton	1535
RadioShack	0869
RCA	0392, 0566, 0855, 0143
Samsung	1276, 1109, 1108
Sony	0639, 1639, 1640
Star Choice	0869
Tivo	1142, 1442
Toshiba	0749, 1749, 0790, 1285
UltimateTV	1640
Uniden	0724, 0722
US Digital	1535
USDTV	1535
Voom	0869
Zenith	1856, 0856

Cable Converter [CABLE]

Maker	Setup codes
ABC	0003, 0008
Americast	0899
Bell South	0899
Clearmaster	0883
ClearMax	0883
Coolmax	0883
Director	0476
General Instrument	0476, 0276, 0003
GoldStar	0144
Hamlin	0009, 0273
Jerrold	0476, 0276, 0003
Memorex	0000
Motorola	0476, 0276, 1376
Multitech	0883
Pace	1877, 0237
Panasonic	0000, 0107
Paragon	0000
Philips	0317, 1305
Pioneer	1877, 0877, 0144, 0533
Pulsar	0000
Quasar	0000
RadioShack	0883
Regal	0279, 0273
Runco	0000
Samsung	0144
Scientific Atlanta	1877, 0877, 0477, 0008
Sony	1006
Starcom	0003
Supercable	0276
Supermax	0883
Torx	0003
Toshiba	0000
Tristar	0883
V2	0883
Viewmaster	0883
Vision	0883
Vortex View	0883
Zenith	0000, 0525, 0899

VCR

Maker	Setup codes
ABS	1972
Admiral	0048, 0209
Adventura	0000
Aiwa	0037, 0000
Alienware	1972
American High	0035
Asha	0240
Audiovox	0037
Beaumarck	0240
Bell & Howell	0104
Broksonic	0184, 0121, 0209
Calix	0037
Canon	0035
Carver	0081
Citizen	0037
Craig	0037, 0047, 0240
Curtis Mathes	0060, 0035, 0162
Cybernex	0240
CyberPower	1972
Daewoo	0045
Dell	1972
Denon	0042
DirecTV	0739
Durabrand	0039
Dynatech	0000
Electrohome	0037
Electroponic	0037
Emerex	0032
Emerson	0037, 0184, 0000, 0121, 0043, 0209
Fisher	0047, 0104
Fuji	0035, 0033
Funai	0000
Garrard	0000
Gateway	1972
GE	0060, 0035, 0240
GoldStar	0037
Gradiente	0000
Harley Davidson	0000
Harman/Kardon	0081
Hewlett Packard	1972
HI-Q	0047
Hitachi	0000, 0042
Howard Computers	1972
HP	1972
Hughes Network Systems	0042, 0739
iBUYPOWER	1972
JVC	0067
KEC	0037
Kenwood	0067
Kodak	0035, 0037
Lloyd's	0000
LXI	0037
Magnavox	0035, 0039, 0081, 0000
Magnin	0240
Marantz	0035, 0081
Marta	0037
Matsushita	0035, 0162
Media Center PC	1972
MEI	0035

Setup code chart

VCR (continued)

Maker	Setup codes
Memorex	0035, 0162, 0037, 0048, 0039, 0047, 0240, 0000, 0104, 0209
MGA	0240, 0043
MGN Technology	0240
Microsoft	1972
Mind	1972
Minolta	0042
Mitsubishi	0067, 0043
Motorola	0035, 0048
MTC	0240, 0000
Multitech	0000
NEC	0104, 0067
Nikko	0037
Noblex	0240
Northgate	1972
Olympus	0035
Optimus	1062, 0162, 0037, 0048, 0104
Orion	0184, 0209
Panasonic	1062, 0035, 0162, 0616, 0225
Penney	0035, 0037, 0240, 0042
Pentax	0042
Philco	0035
Philips	0035, 0081, 0739, 0618
Pilot	0037
Pioneer	0067
Polk Audio	0081
Profitronic	0240
Proscan	0060
Pulsar	0039
Quasar	0035, 0162
RadioShack	0000
Radix	0037
Randex	0037
RCA	0060, 0240, 0042
Realistic	0035, 0037, 0048, 0047, 0000, 0104
ReplayTV	0616
Runco	0039
Samsung	0240, 0045
Sanky	0048, 0039
Sansui	0000, 0067, 0209
Sanyo	0047, 0240, 0104
Scott	0184, 0045, 0121, 0043
Sears	0035, 0037, 0047, 0000, 0042, 0104
Sharp	0048
Shogun	0240
Sonic Blue	0616
Sony	0035, 0032, 0033, 0000, 1972, 0636
STS	0042
Sylvania	0035, 0081, 0000, 0043
Symphonic	0000
Systemax	1972
Tagar Systems	1972
Teac	0000
Technics	0035, 0162
Teknika	0035, 0037, 0000
Thomas	0000

VCR (continued)

Maker	Setup codes
Tivo	0618, 1503, 0739, 0636
TMK	0240
Toshiba	0045, 0043, 1503, 1972
Totevision	0037, 0240
Touch	1972
Unitech	0240
Vector	0045
Video Concepts	0045
Videomagic	0037
Videosonic	0240
Viewsonic	1972
Villain	0000
Wards	0060, 0035, 0048, 0047, 0081, 0240, 0000, 0042
White Westinghouse	0209
XR-1000	0035, 0000
Zenith	0039, 0033, 0000, 0209
ZT Group	1972

Video Accessories [CABLE]

Maker	Setup codes
Macro Image Technology	1383
Motorola	1363
MyHD	1383
Panasonic	1120
Pioneer	1010
Samsung	1490
Sensory Science	1126
Sharp	1010
Viewsonic	1329

PVR [VCR]

Maker	Setup codes
ABS	1972
Alienware	1972
CyberPower	1972
Dell	1972
Gateway	1972
Hewlett Packard	1972
Howard Computers	1972
HP	1972
iBUYPOWER	1972
Media Center PC	1972
Microsoft	1972
Mind	1972
Northgate	1972
Panasonic	0616
Philips	0618, 0739
ReplayTV	0616
Sonic Blue	0616
Sony	1972, 0636
Systemax	1972
Tagar Systems	1972
Tivo	0739, 0636, 0618
Toshiba	1972
Touch	1972
Viewsonic	1972
ZT Group	1972

CD player

Maker	Setup codes
Kenwood	1338, 1339, 0681, 0826, 0028, 0037, 0340, 0859, 0339, 0677, 0858, 0190, 0523, 1490
Optimus	0037
Sharp	0037

MD recorder [CD]

Maker	Setup codes
Kenwood	1339, 0681, 0826

Audio Amp/Tuner [SIRIUS]

Maker	Setup codes
Kenwood	2000
(Sirius Satellite Radio)	

Other components' operations

Refer to the following for the type of remote control operations available for each component.

- ❶ Select the input source.
- ❷ Press the keys corresponding to the operations you desire. Refer to the following sections for details.

- When pressing keys in succession, press each key firmly and be sure to wait at least 1 second before pressing the next key.
- Numeric keys function the same as the numeric keys on the original remote.
- The key descriptions in this section are for representative components.

These keys can be used to perform the basic operations of Kenwood and other manufacturers' components which the setup code for each component had been entered beforehand. - 45

DVD player operations keys

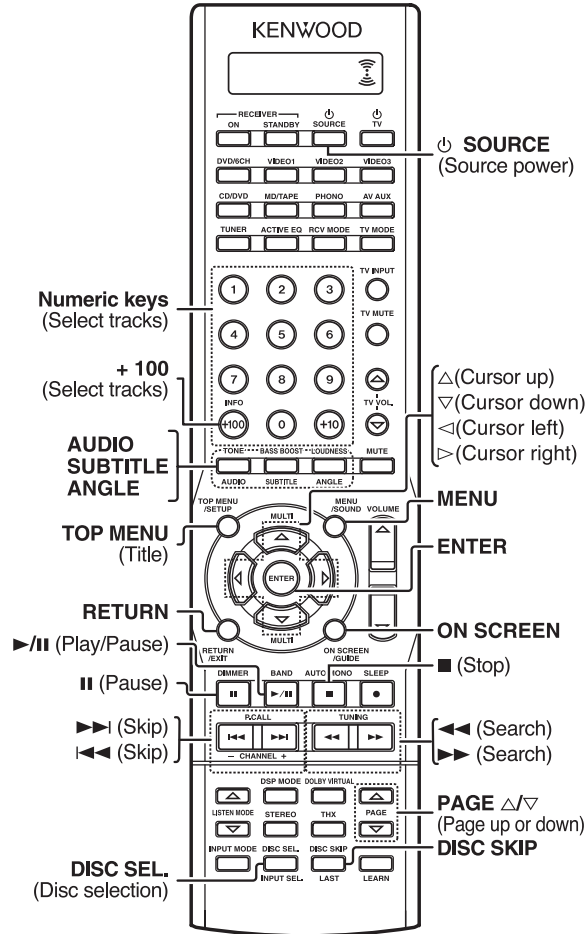

TV operation keys (including TVs incorporating VCR)

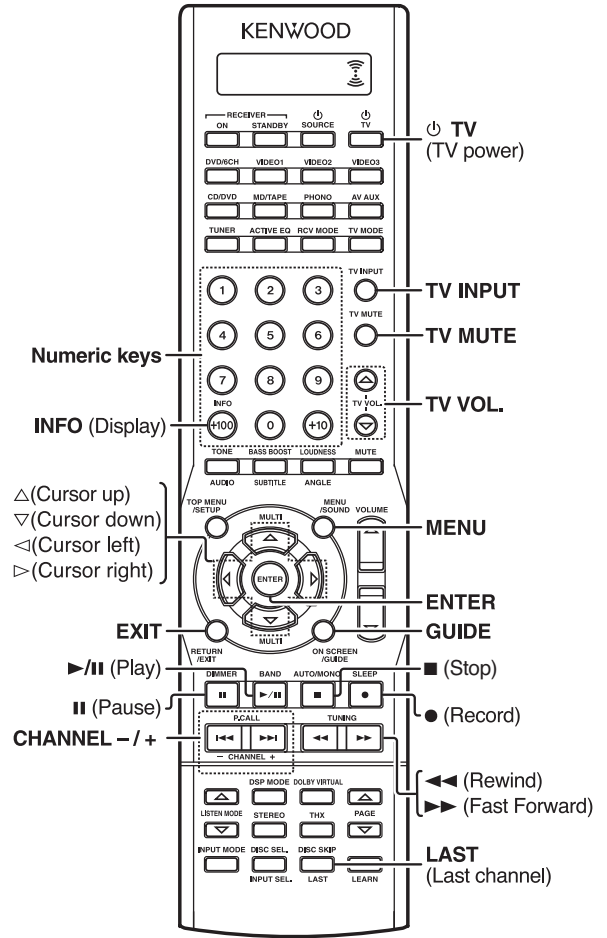

Basic remote control operations for other components

Refer to the following for the type of remote control operations available for each component.

DSS operation keys

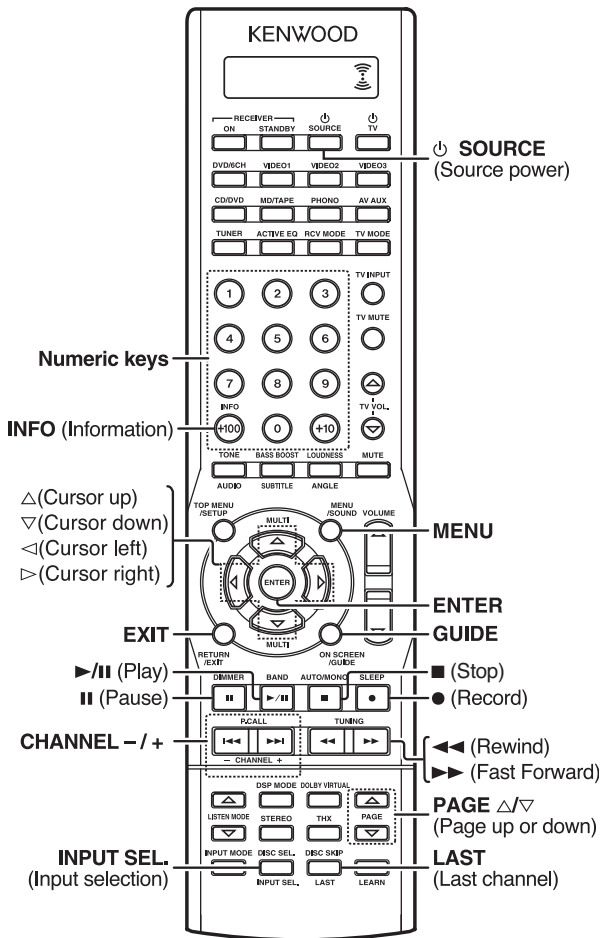

Cable converter operation keys

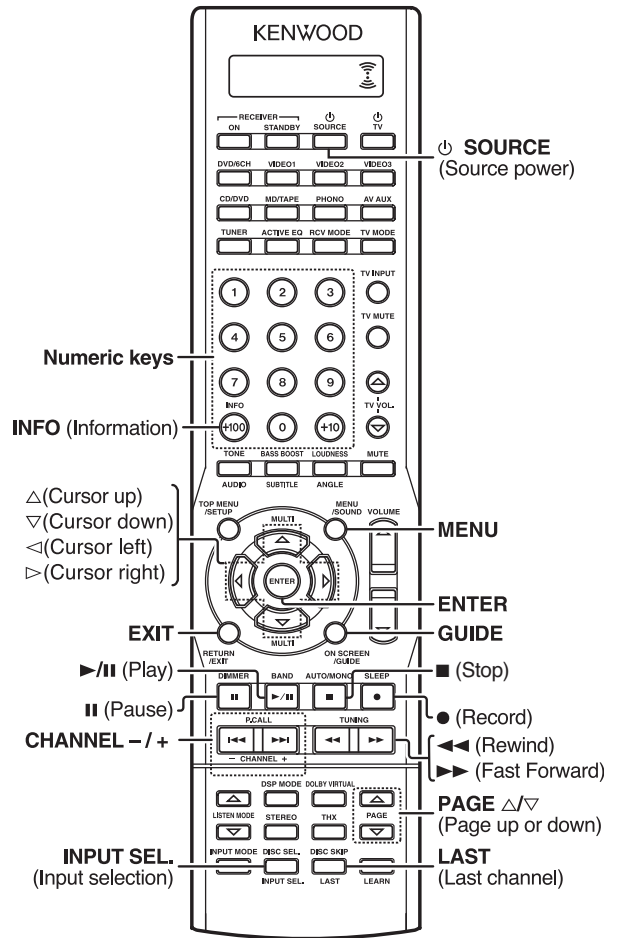

Basic remote control operations for other components

Refer to the following for the type of remote control operations available for each component.

VCR operation keys

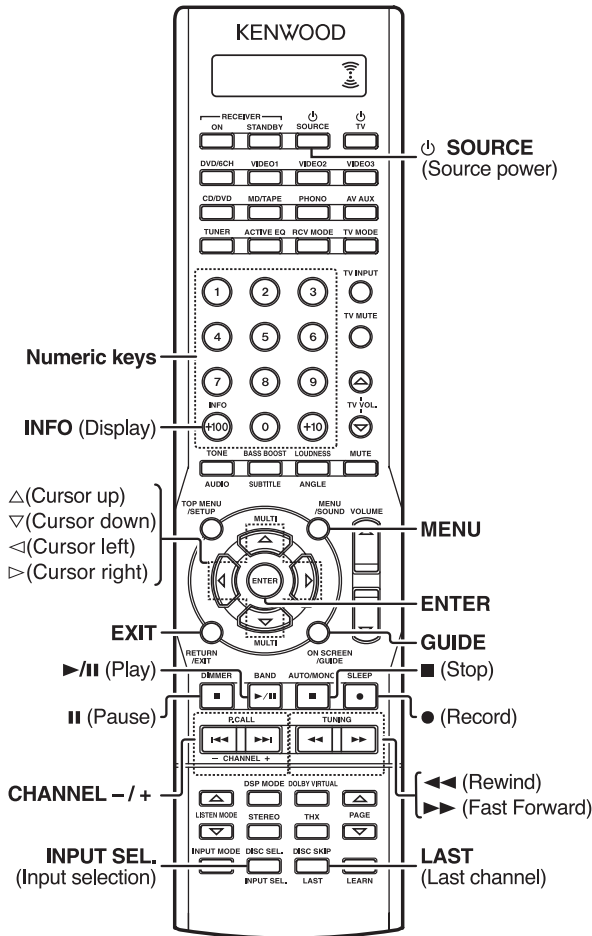

CD player operation keys

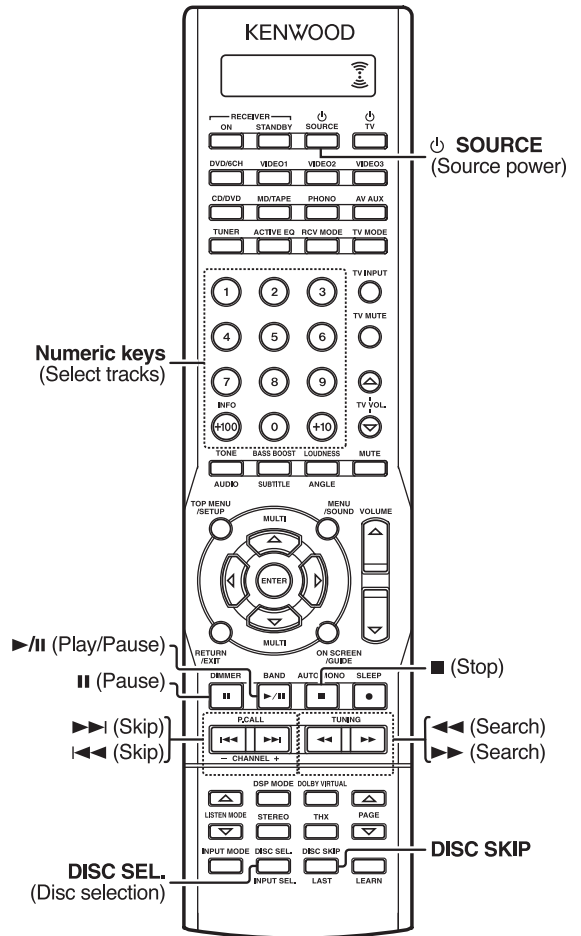

Basic remote control operations for other components

Refer to the following for the type of remote control operations available for each component.

MD recorder operation keys (made by KENWOOD)

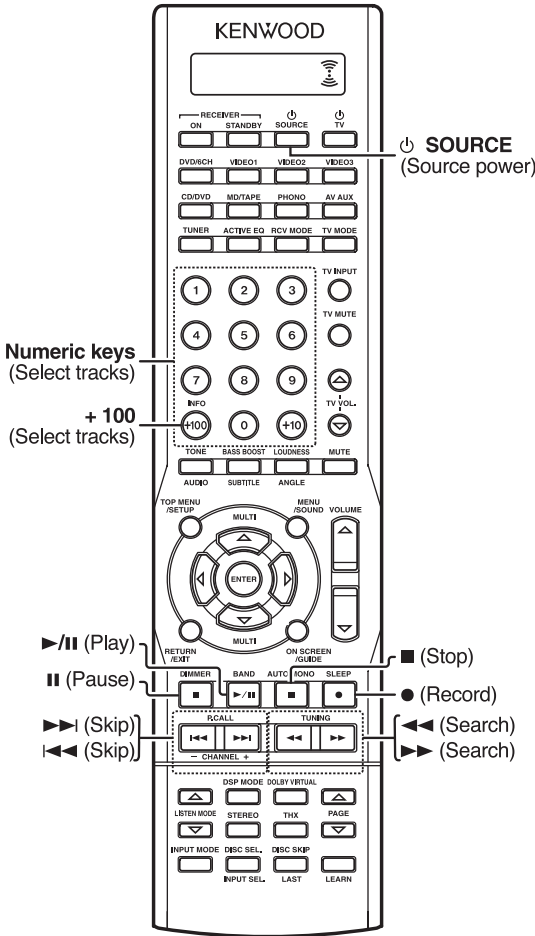

Sirius operation keys (made by KENWOOD)

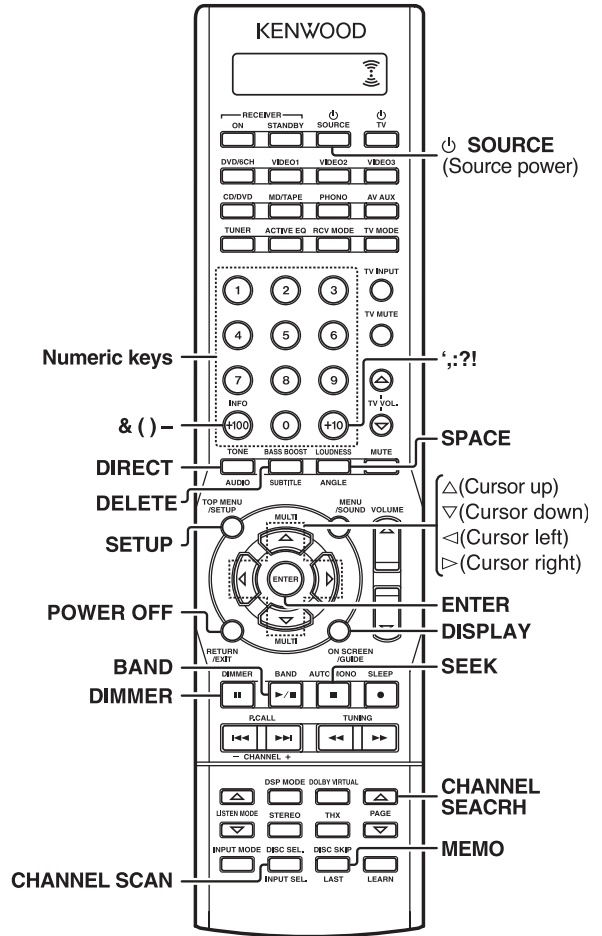

Notes

1. Certain codes may only operate some of the function available on a given model.
2. The above show the typical type functions available for each component. Some manufacturers use different key combinations to perform similar functions. For that reason, we have programmed extra functions on some of the unused number keys to help you control your equipment.

Resetting the Microcomputer

The microcomputer may malfunction (unit cannot be operated, or shows an erroneous display) if the power cord is unplugged while the power is ON, or due to some other external factor. If this happens, execute the following procedure to reset the microcomputer and return the unit to its normal operating condition.

- Please note that resetting the microcomputer will clear the contents of the memory and returns the unit to the state it was in when it left the factory.

For the U.S.A. and Canada

Unplug the power cord from the wall outlet, then plug it back in while holding down the **⏻ (POWER ON/STANDBY)** key.

For other countries

With the power cord plugged in, turn the **POWER ON/OFF** key OFF. Then, while holding down the **⏻ (POWER ON/STANDBY)** key, press **POWER ON/OFF** key.

Amplifier

Symptom	Cause	Remedy
No sound from the speakers.	<ul style="list-style-type: none"> • The speaker cords are disconnected. • VOLUME is set to the minimum position. • MUTE is ON. • The SPEAKERS switches are set to OFF. • Headphones are connected to the PHONES jack. 	<ul style="list-style-type: none"> • Connect them properly referring to "Connecting the speakers" - [15] • Adjust the volume to a proper level. - [27] • Turn OFF the MUTE. - [29] • Set the SPEAKERS switches to ON. - [27] • Unplug the headphones plug. - [29]
The STANDBY indicator blinks and sound is not output.	<ul style="list-style-type: none"> • Speaker cords are short-circuited. 	<ul style="list-style-type: none"> • Turn the power off, eliminate the short-circuiting, then turn on the power again.
Sound is not output from one of the speakers.	<ul style="list-style-type: none"> • The speaker cord is disconnected. • The speaker is not set up correctly. 	<ul style="list-style-type: none"> • Connect it properly referring to "Connecting the speakers". - [15] • Set it up properly referring to "Preparing for surround sound". - [20]
Sound is not output from the surround speakers and / or the center speaker, or their sound is very small.	<ul style="list-style-type: none"> • The surround speaker cords and/or the center speaker cord is disconnected. • The speaker is not set up correctly. • A surround mode has not been engaged. • The surround and/or center volume controls are set to the minimum level. 	<ul style="list-style-type: none"> • Connect it properly referring to "Connecting the speakers". - [15] • Set it up properly referring to "Preparing for surround sound". - [20] • Select a surround mode. • Adjust the speaker levels using the test tone. - [24]
A humming noise is generated when the PHONO input selector is selected.	<ul style="list-style-type: none"> • The audio cord from the record player is not connected to the PHONO jacks. • The record player is not grounded. 	<ul style="list-style-type: none"> • Insert the audio cord plugs securely into the PHONO jacks. • Connect the grounding wire to the GND terminal on the rear panel.
When playing a Dolby Digital source signal using a DVD player, the sound is cut off soon after it starts.	<ul style="list-style-type: none"> • There are many possible causes for this problem, depending on the type of DVD player used. 	<ul style="list-style-type: none"> • Set the input mode to digital manual before starting playback of the Dolby Digital source. - [8]
No sound is produced during playback from a DVD player.	<ul style="list-style-type: none"> • The input mode is set to digital manual. 	<ul style="list-style-type: none"> • Press the INPUT MODE key to select to full auto mode. - [8]
A video source cannot be recorded normally.	<ul style="list-style-type: none"> • The software is copy-guarded. 	<ul style="list-style-type: none"> • Copy-guarded video software cannot be recorded.
Display such as Exx : XXX appears.	<ul style="list-style-type: none"> • Problems are detected while in AUTO SETUP calibration. 	<ul style="list-style-type: none"> • Refer to "About error messages" and "About warning messages". - [21]

Tuner

Symptom	Cause	Remedy
Radio stations cannot be received.	<ul style="list-style-type: none"> No antenna is connected. The broadcast band is not set properly. The frequency of the desired station is not tuned. 	<ul style="list-style-type: none"> Connect an antenna. → [39] Set the broadcast band properly. Tune the frequency of the desired station. → [31]
Interference.	<ul style="list-style-type: none"> Noise due to ignition noise from an automobile. Noise due to interference from an electric appliance. Noise due to a nearby TV set. 	<ul style="list-style-type: none"> Install the outdoor antenna away from the road. Turn off the power to the appliance. Install the receiver farther away from the TV.
A station which was preset cannot be received by pressing the corresponding numeric key.	<ul style="list-style-type: none"> The preset station belongs to a frequency that cannot be received. The preset memory was cleared because the power cord had been unplugged for a long period of time. 	<ul style="list-style-type: none"> Preset a station with a receivable frequency. Preset the station again.

Remote control unit

Symptom	Cause	Remedy
Certain inputs cannot be selected using the remote control.	<ul style="list-style-type: none"> No setup codes registered for the respective input(s). 	<ul style="list-style-type: none"> Register a setup code at the respective input(s). → [42]
Remote control operation is not possible.	<ul style="list-style-type: none"> The remote control unit is set to a different operation mode. Batteries are exhausted. The remote control unit is too far away from the main system, controlling angle is too large, or there is an obstacle between the receiver and the remote. No disc or tape is placed in the source component. An attempt is made to play a tape which is being recorded in the cassette deck. The remote control has not been set to the operation mode for the component you wish to control. 	<ul style="list-style-type: none"> Press the RCV MODE key to select the appropriate operation mode. Replace with new batteries. Operate the remote control unit within the controllable range. Place the disc or tape in the source component which you want to play. Wait until recording has completed. Press any of the Source keys or ϕ SOURCE key to activate the operation mode for the component you want to control before operation. → [42]

Specifications

 **Caution** : Read this page carefully to ensure safe operation.

AUDIO section

For VR-9080

Rated power output during STEREO operation

100 watts per channel minimum RMS, both channels driven, at 8 Ω from 20 Hz to 20 kHz with no more than 0.09% total harmonic distortion. (FTC)

Effective power output during SURROUND operation

FRONT (20 ~ 20 kHz, 0.09 % T.H.D., at 8 Ω one channel driven) 100 W + 100 W
CENTER (20 ~ 20 kHz, 0.09 % T.H.D., at 8 Ω one channel driven) 100 W + 100 W
SURROUND (20 ~ 20 kHz, 0.7 % T.H.D., at 8 Ω one channel driven) 100 W + 100 W
SURROUND BACK (20 ~ 20 kHz, 0.7 % T.H.D., at 8 Ω one channel driven) 100 W + 100 W

For KRF-X9090D

Rated power output during STEREO operation

100 watts per channel minimum RMS, both channels driven, at 8 Ω from 20 Hz to 20 kHz with no more than 0.09% total harmonic distortion. (FTC)

IEC (20 Hz ~ 20 kHz, 0.09% T.H.D., at 8 Ω) 100 W + 100 W
DIN (1 kHz at 8 Ω) 120 W + 120 W

Effective power output during STEREO operation

(1 kHz, 10% T.H.D., at 8 Ω) 130 W + 130 W

Effective power output during SURROUND operation

FRONT
(20 Hz ~ 20 kHz, 0.09 % T.H.D., at 8 Ω one channel driven) 100 W + 100 W
(1 kHz, 0.7 % T.H.D., at 8 Ω one channel driven) .. 120 W + 120 W
(1 kHz, 10 % T.H.D., at 8 Ω one channel driven) ... 130 W + 130 W
CENTER
(20 Hz ~ 20 kHz, 0.09 % T.H.D., at 8 Ω one channel driven) 100 W + 100 W
(1 kHz, 0.7 % T.H.D., at 8 Ω one channel driven) 120 W + 120 W
(1 kHz, 10 % T.H.D., at 8 Ω one channel driven) 130 W + 130 W
SURROUND
(20 Hz ~ 20 kHz, 0.7 % T.H.D., at 8 Ω one channel driven) 100 W + 100 W
(1 kHz, 0.7 % T.H.D., at 8 Ω one channel driven) .. 120 W + 120 W
(1 kHz, 10 % T.H.D., at 8 Ω one channel driven) ... 130 W + 130 W
SURROUND BACK
(20 Hz ~ 20 kHz, 0.7 % T.H.D., at 8 Ω one channel driven) 100 W + 100 W
(1 kHz, 0.7 % T.H.D., at 8 Ω one channel driven) .. 120 W + 120 W
(1 kHz, 10 % T.H.D., at 8 Ω one channel driven) ... 130 W + 130 W

common

Total harmonic distortion 0.009 % (1 kHz, 50 W, 8 Ω)
Frequency response

CD/DVD 10 Hz ~ 100 kHz, +0 dB ~ -3.0 dB

PHONO 'RIAA' response 40 Hz ~ 20 kHz, +1.5 dB ~ -3.0 dB

Maximum input level

PHONO (MM) 40 mV, 1 % T.H.D., at 1 kHz

Signal to noise ratio (IHF'66)

PHONO (MM) 75 dB

CD/DVD 95 dB

Input sensitivity / impedance

PHONO (MM) 4 mV / 47 kΩ

CD/DVD, MD/TAPE, AV AUX, VIDEO 1, VIDEO 2, VIDEO 3, DVD/6CH 300 mV / 47 kΩ

Output level / impedance

REC OUT (MD/TAPE) 300 mV / 1 kΩ

PRE OUT (FRONT) 1 V / 500 Ω

PRE OUT (CENTER) 1 V / 500 Ω

PRE OUT (SURROUND) 1 V / 500 Ω

PRE OUT (SURROUND BACK) 1 V / 500 Ω

PRE OUT (SUBWOOFER) 1 V / 500 Ω

Tone control

BASS ±10 dB (at 100 Hz)

TREBLE ±10 dB (at 10 kHz)

Loudness control

VOLUME at -30 dB level +6 dB (100 Hz)

DIGITAL AUDIO section

Sampling frequency 32 kHz, 44.1 kHz, 48 kHz, 96 kHz

Input level / impedance / wave length

Optical -15 dBm ~ -24 dBm, 660 nm ±30 nm

Coaxial 0.5 Vp-p / 75 Ω

Output level / impedance / wave length

Optical -21 dBm ~ -15 dBm, 660 nm ±30 nm

VIDEO section

VIDEO inputs / outputs

VIDEO (composite) 1 Vp-p / 75 Ω

S VIDEO inputs / outputs

S VIDEO (luminance signal) 1 Vp-p / 75 Ω

S VIDEO (chrominance signal) 0.286 Vp-p / 75 Ω

COMPONENT VIDEO inputs / outputs

COMPONENT VIDEO (luminance signal) 1 Vp-p / 75 Ω

COMPONENT VIDEO (CB/CR-signal)

VR-9080 0.64 Vp-p / 75 Ω

KRF-X9090D 0.7 Vp-p / 75 Ω

FM tuner section

Tuning frequency range 87.5 MHz ~ 108.0 MHz

Usable sensitivity (MONO)

VR-9080 1.3 μV (75 Ω) / 13.2 dBf (75 kHz dev, SINAD 30 dB)

KRF-X9090D 1.6 μV (75 Ω) / 15.2 dBf (75 kHz dev, SINAD 30 dB)

50 dB quieting sensitivity

STEREO 28 μV (75 Ω) / 40.2 dBf (75 kHz dev)

Total harmonic distortion

MONO (1 kHz, 75 kHz dev) 0.5% (65 dBf input)

STEREO (1 kHz, 67.5 + 67.5 kHz dev) 0.7% (65 dBf input)

Signal to noise ratio

MONO (1 kHz, 75 kHz dev) 75 dB (65 dBf input)

STEREO (1 kHz, 67.5 + 67.5 kHz dev) 68 dB (65 dBf input)

Stereo separation (1 kHz) 40 dB

Selectivity (±400 kHz) VR-9080 70 dB

KRF-X9090D 50 dB

Frequency response (30 Hz ~ 15 kHz) +0.5 dB, -3.0 dB

AM tuner section

Tuning frequency range

10 kHz step (VR-9080) 530 kHz ~ 1,700 kHz

10 kHz step (KRF-X9090D) 530 kHz ~ 1,610 kHz

9 kHz step (KRF-X9090D) 531 kHz ~ 1,602 kHz

Usable sensitivity (30% mod, S/N 20 dB) 16 μV / (600 μV/m)

Signal to noise ratio (30% mod, 400 Hz)

..... 50 dB (60 dBμV EMF input)

GENERAL

Power consumption VR-9080 3.4 A

KRF-X9090D 300 W

Standby Power consumption less than 2.0 W

AC outlet (SWITCHED)

VR-9080 total 150 W, 1.25 A max.

KRF-X9090D total 90 W max.

Dimensions W : 440 mm (17-5/16")

H : 166 mm (6-9/16")

D : 396 mm (15-9/16")

Weight (Net) 12.1 kg (26.7 lb)

Notes

1. KENWOOD follows a policy of continuous advancements in development. For this reason specifications may be changed without notice.
 2. The full performance may not be exhibited in an extremely cold location (under a water-freezing temperature).
-

KENWOOD

For your records

Record the serial number, found on the back of the unit, in the spaces designated on the warranty card, and in the space provided below. Refer to the model and serial numbers whenever you call upon your dealer for information or service on this product.

Model _____ Serial Number _____

Free Manuals Download Website

<http://myh66.com>

<http://usermanuals.us>

<http://www.somanuals.com>

<http://www.4manuals.cc>

<http://www.manual-lib.com>

<http://www.404manual.com>

<http://www.luxmanual.com>

<http://aubethermostatmanual.com>

Golf course search by state

<http://golfingnear.com>

Email search by domain

<http://emailbydomain.com>

Auto manuals search

<http://auto.somanuals.com>

TV manuals search

<http://tv.somanuals.com>