

# KENWOOD

# INSTRUCTION MANUAL

144/440 MHz FM DUAL BANDER  
**TM-V708A**



KENWOOD CORPORATION

© B62-1834-00 (K)  
09 08 07 06 05 04 03 02 01 00

Download from [www.Somanuals.com](http://www.Somanuals.com). All Manuals Search And Download.

## THANK YOU!

We are grateful you decided to purchase this **KENWOOD** FM transceiver. **KENWOOD** always provides Amateur Radio products which surprise and excite serious hobbyists. This transceiver is no exception.

## FEATURES

This transceiver has the following main features:

- Enhanced Programmable Memory (PM) channels store virtually entire current operating environments for your quick recall.
- Contains a total of 200 memory channels to program frequencies and other various data. Allows each memory channel to be named using up to 8 alphanumeric and special ASCII characters.
- “Visual Scan” graphically and simultaneously shows the conditions of up to 181 frequency channels.
- Continuous Tone Coded Squelch System (CTCSS) or Digital Code Squelch (DCS) rejects unwanted calls from other stations.
- The front panel can be mounted in a convenient location, separate from the main unit.
- Equipped with an easy-to-read large LCD with alphanumeric display capability.

## Control Head Replacement

This model has a separate remote control head. We suggest you remove the control head from your automobile when unattended. Removing the control head from the vehicle will reduce the risk of equipment theft.

We also suggest that you check with your home or car insurance for additional coverage. The American Radio Relay League (ARRL) also has an insurance plan to cover such incidents.

In the event theft or damage should occur, there are no replacement control head units available from Kenwood.

## NOTICES TO THE USER

One or more of the following statements may be applicable:

### FCC WARNING

This equipment generates or uses radio frequency energy. Changes or modifications to this equipment may cause harmful interference unless the modifications are expressly approved in the instruction manual. The user could lose the authority to operate this equipment if an unauthorized change or modification is made.

### INFORMATION TO THE DIGITAL DEVICE USER REQUIRED BY THE FCC

This equipment has been tested and found to comply with the limits for a Class B digital device, pursuant to Part 15 of the FCC Rules. These limits are designed to provide reasonable protection against harmful interference in a residential installation.

This equipment generates, uses and can generate radio frequency energy and, if not installed and used in accordance with the instructions, may cause harmful interference to radio communications. However, there is no guarantee that the interference will not occur in a particular installation. If this equipment does cause harmful interference to radio or television reception, which can be determined by turning the equipment off and on, the user is encouraged to try to correct the interference by one or more of the following measures:

- Reorient or relocate the receiving antenna.
- Increase the separation between the equipment and receiver.
- Connect the equipment to an outlet on a circuit different from that to which the receiver is connected.
- Consult the dealer for technical assistance.

When condensation occurs inside the transceiver:

Condensation may occur inside the transceiver in such cases where the room is warmed using a heater on cold days or where the transceiver is quickly moved from a cold room to a warm room. When condensation occurs, the microcomputer and/or the transmit/receive circuits may become unstable, resulting in transceiver malfunction. If this happens, turn the transceiver power OFF and wait for a while. When the condensed droplets disappear, the transceiver will function normally.

## PRECAUTIONS

Please observe the following precautions to prevent fire, personal injury, and transceiver damage:

- When operating mobile, do not attempt to configure your transceiver while driving; it is too dangerous.
- Be aware of local laws pertaining to the use of headphones/headsets while driving on public roads. If in doubt, do not wear headphones while mobilizing.
- Do not transmit with high output power for an extended duration; the transceiver may overheat.
- Do not modify the transceiver unless instructed by this manual or by **KENWOOD** documentation.
- Do not expose the transceiver to long periods of direct sunlight, nor place it close to heating appliances.
- Do not place the transceiver in excessively dusty, humid, or wet areas, nor on unstable surfaces.
- If an abnormal odor or smoke is detected coming from the transceiver, turn the power OFF immediately. Contact a **KENWOOD** service station or your dealer.
- The transceiver is designed for a 13.8 V power source. Never use a 24 V battery to power the transceiver.

# CONTENTS

SUPPLIED ACCESSORIES .....	1	<b>CHAPTER 4 OPERATING BASICS</b>	
CONVENTIONS FOLLOWED IN THIS MANUAL .....	1	SWITCHING THE POWER ON/OFF .....	19
<b>CHAPTER 1 PREPARATION</b>		ADJUSTING THE VOLUME .....	19
MOBILE INSTALLATION .....	2	SELECTING A BAND .....	19
Main Unit Installation .....	2	SELECTING A FREQUENCY .....	20
Front Panel Installation .....	3	ADJUSTING THE SQUELCH .....	20
FIXED STATION INSTALLATION .....	4	TRANSMITTING .....	21
MODULAR PLUG CABLE CONNECTION .....	4	Selecting Output Power .....	21
DC POWER CABLE CONNECTION .....	5	<b>CHAPTER 5 MENU SETUP</b>	
Mobile Operation .....	5	MENU ACCESS .....	22
Fixed Station Operation .....	6	MENU CONFIGURATION .....	23
Replacing Fuses .....	7	<b>CHAPTER 6 OPERATING THROUGH REPEATERS</b>	
ANTENNA CONNECTION .....	7	PROGRAMMING OFFSET .....	27
ACCESSORY CONNECTIONS .....	8	Selecting Offset Direction .....	27
External Speakers .....	8	Selecting Offset Frequency .....	27
Microphone .....	8	Activating Tone Function .....	28
<b>CHAPTER 2 YOUR FIRST QSO</b>		Selecting a Tone Frequency .....	28
<b>CHAPTER 3 GETTING ACQUAINTED</b>		AUTOMATIC REPEATER OFFSET .....	29
FRONT PANEL .....	10	TRANSMITTING A 1750 Hz TONE .....	30
MAIN UNIT – FRONT .....	12	REVERSE FUNCTION .....	31
MAIN UNIT – REAR .....	12	AUTOMATIC SIMPLEX CHECK (ASC) .....	31
MICROPHONE .....	13	TONE FREQUENCY ID .....	32
INDICATORS .....	14	<b>CHAPTER 7 MEMORY CHANNELS</b>	
BASIC TRANSCEIVER MODES .....	15	SIMPLEX & REPEATER OR ODD-SPLIT	
KEY FUNCTION DISPLAY .....	16	MEMORY CHANNEL? .....	33
BAND A & B .....	17	STORING SIMPLEX FREQUENCIES OR	
TX BAND AND CONTROL BAND .....	17	STANDARD REPEATER FREQUENCIES .....	34
MIC KEYPAD DIRECT ENTRY (MC-58DM ONLY) .....	18		

STORING ODD-SPLIT REPEATER FREQUENCIES .....	34	PROGRAM SCAN .....	50	<b>1</b>
RECALLING A MEMORY CHANNEL .....	35	Setting Scan Limits .....	50	<b>2</b>
CLEARING A MEMORY CHANNEL .....	35	Using Program Scan .....	51	<b>3</b>
NAMING A MEMORY CHANNEL .....	36	MHz SCAN .....	51	<b>4</b>
CALL CHANNEL .....	37	CALL/VFO SCAN .....	52	<b>5</b>
Recalling the Call Channel .....	37	CALL/MEMORY SCAN .....	52	<b>6</b>
Reprogramming the Call Channel .....	37	<b>CHAPTER 10 CONTINUOUS TONE CODED SQUELCH SYSTEM (CTCSS)</b>		<b>7</b>
MEMORY-TO-VFO TRANSFER .....	38	USING CTCSS .....	53	<b>8</b>
CHANNEL DISPLAY .....	38	CTCSS FREQUENCY ID .....	54	<b>9</b>
PARTIAL OR FULL RESET? .....	39	<b>CHAPTER 11 DIGITAL CODE SQUELCH (DCS)</b>		<b>10</b>
<b>CHAPTER 8 PROGRAMMABLE MEMORY (PM)</b>		USING DCS .....	55	<b>11</b>
PROGRAMMABLE INFORMATION .....	40	DCS CODE ID .....	56	<b>12</b>
APPLICATION EXAMPLES .....	41	<b>CHAPTER 12 DUAL TONE MULTI-FREQUENCY (DTMF) FUNCTIONS (WITH MC-58DM ONLY)</b>		<b>13</b>
STORING IN PM CHANNELS .....	42	MANUAL DIALING .....	57	<b>14</b>
RECALLING A PM CHANNEL .....	42	DTMF Monitor .....	57	<b>15</b>
AUTO PM CHANNEL STORE .....	43	AUTOMATIC DIALER .....	58	<b>16</b>
PM CHANNEL RESET .....	43	Storing a DTMF Number in Memory .....	58	<b>17</b>
<b>CHAPTER 9 SCAN</b>		Transmitting a Stored DTMF Number .....	59	<b>18</b>
VISUAL SCAN .....	45	Selecting TX Speed .....	59	<b>19</b>
Selecting the Number of Channels .....	45	Selecting Pause Duration .....	59	<b>20</b>
Using Visual Scan .....	46	<b>CHAPTER 13 PROGRAMMABLE FUNCTION (PF) KEYS</b>		<b>21</b>
SELECTING SCAN RESUME METHOD .....	47	<b>CHAPTER 14 AUXILIARY FUNCTIONS</b>		<b>22</b>
VFO SCAN .....	48	DIRECT FREQUENCY ENTRY (WITH MC-58DM ONLY) .....	61	
MEMORY SCAN .....	48	CHANGING FREQUENCY STEP SIZE .....	62	
Locking Out a Memory Channel .....	49	PROGRAMMABLE VFO .....	62	
GROUP SCAN .....	49			

DISPLAY DIMMER .....	63
AUTO DIMMER CHANGE .....	63
DISPLAY CONTRAST ADJUST .....	63
POSITIVE/ NEGATIVE REVERSAL .....	63
BLANKING A BAND DISPLAY .....	64
AUTOMATIC BAND CHANGE (ABC) .....	64
TRANSCEIVER LOCK .....	65
ALL-CONTROL LOCK .....	65
S-METER SQUELCH .....	65
Squelch Hang Time .....	66
CHANGING BEEP VOLUME .....	66
KEY BEEP ON/ OFF .....	66
SWITCHING FM/AM MODE .....	66
ADVANCED INTERCEPT POINT (AIP) .....	67
TIME-OUT TIMER (TOT) .....	67
AUTOMATIC POWER OFF (APO) .....	67
POWER-ON MESSAGE .....	68
DISPLAY DEMONSTRATION .....	68
CHANGING SPEAKER CONFIGURATIONS .....	69
SPEAKER MUTE .....	69

#### **CHAPTER 15** PACKET OPERATION

CONNECTING WITH A TNC AND PERSONAL COMPUTER .....	71
SELECTING A DATA TRANSFER RATE .....	72

#### **CHAPTER 16** MICROPHONE CONTROL (WITH MC-58DM ONLY)

#### **CHAPTER 17** WIRELESS REMOTE CONTROL

PREPARATION .....	74
CONTROL OPERATION .....	75

#### **CHAPTER 18** REPEATER FUNCTION

#### **CHAPTER 19** VS-3 VOICE SYNTHESIZER (OPTIONAL)

#### **CHAPTER 20** OPTIONAL ACCESSORIES

#### **CHAPTER 21** INSTALLING OPTIONS

INSTALLING THE VS-3 VOICE SYNTHESIZER UNIT .....	79
INSTALLING THE PG-4X EXTENSION CABLE KIT .....	79

#### **CHAPTER 22** MAINTENANCE

GENERAL INFORMATION .....	81
SERVICE .....	81
SERVICE NOTE .....	81
CLEANING .....	81
TROUBLESHOOTING .....	82

#### **SPECIFICATIONS**

#### **INDEX**

## SUPPLIED ACCESSORIES

Accessory	Part Number	Quantity
MC-58DM microphone	T91-0636-XX	1
DC power cable	E30-2111-XX	1
Transceiver fuse (15 A)	F51-0017-XX	1
Front panel mounting bracket (one pair)	J29-0663-XX J29-0664-XX	1 1
Microphone hanger	J19-1526-XX	1
Main-unit mounting bracket	J29-0628-XX	1
Screw set for main unit	N99-0382-XX	1
Screw set for front panel	N99-2014-XX	1
Modular plug cable	E30-3391-XX	1
Cushion	J02-0488-XX	4
Warranty card	—	1
Instruction manual	B62-1834-XX	1

## CONVENTIONS FOLLOWED IN THIS MANUAL

The writing conventions described below have been followed to simplify instructions and avoid unnecessary repetition.

Instruction	Action
Press <b>[KEY]</b> .	Press and release <b>KEY</b> .
Press <b>[KEY] (1s)</b> .	Press and hold <b>KEY</b> for 1 second or longer.
Press <b>[KEY1], [KEY2]</b> .	Press <b>KEY1</b> momentarily, release <b>KEY1</b> , then press <b>KEY2</b> .
Press <b>[KEY1]+[KEY2]</b> .	Press and hold <b>KEY1</b> , then press <b>KEY2</b> while continuing to hold <b>KEY1</b> .
Press <b>[KEY]+ POWER ON</b> .	With the transceiver power OFF, press and hold <b>KEY</b> , then turn the transceiver power ON by pressing <b>[PWR]</b> while continuing to hold <b>KEY</b> .

# PREPARATION

## 1 MOBILE INSTALLATION

This transceiver allows you to install the front panel and main unit in separate locations. Select safe, convenient locations inside your vehicle that minimize danger to your passengers and yourself while the vehicle is in motion. Consider installing the units at appropriate positions so that knees or legs will not strike them during sudden braking of your vehicle. Try to pick well-ventilated locations that are shielded from direct sunlight.

**Note:** Unlike the previous **KENWOOD** mobile transceivers, this transceiver does not allow the front panel and main unit to be joined.

### ■ Main Unit Installation

- 1 Install the mounting bracket in the vehicle using the 4 supplied self-tapping screws and flat washers.
  - The bracket must be installed so that the 3 screw holes on the edge of each bracket side are facing the rear.

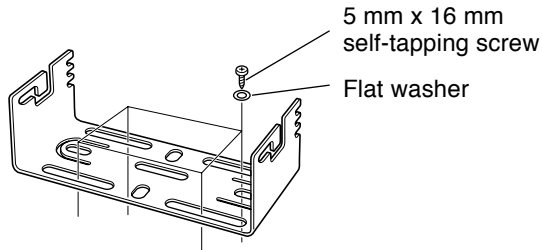

- 2 Position the transceiver, then insert and tighten the 4 supplied hexagon SEMS screws and flat washers.
  - Double check that all hardware is tightened to prevent vehicle vibration from loosening the bracket or transceiver.

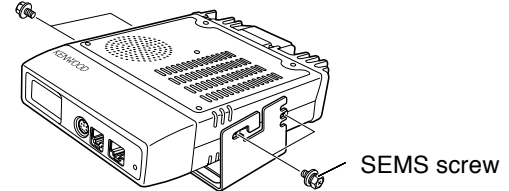

- Determine the desired angle of the main unit, using the 3 screw holes on the rear edge of each bracket side.

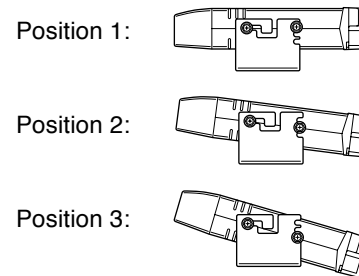



## ■ Front Panel Installation

- 1 Assemble the mounting brackets using the 2 supplied hexagon SEMS screws and flat washers.

- Do not completely tighten the screws in this step.

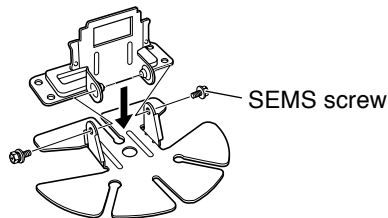

- 2 Peel off the paper backing from the rear of the bracket.

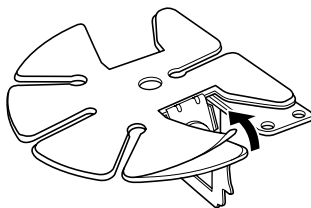

- 3 Position the bracket in the vehicle, then install it securely using the 3 supplied self-tapping screws and flat washers.

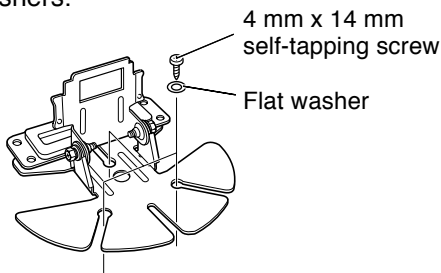

- 4 Position the grooves on the front panel over the bracket tabs.

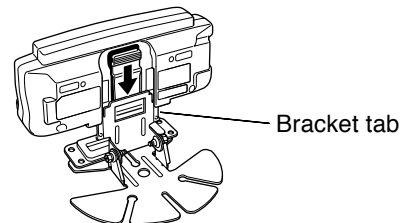

- 5 Slide the front panel down until its locking tab clicks.

- The tab on the front panel must be completely locked by the bracket; otherwise vehicle vibration may cause the front panel to fall off the bracket.

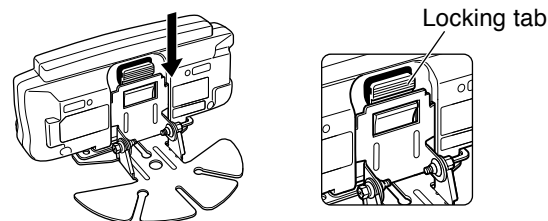

- 6 Determine the desired angle of the front panel, then completely tighten the 2 SEMS screws on the bracket.

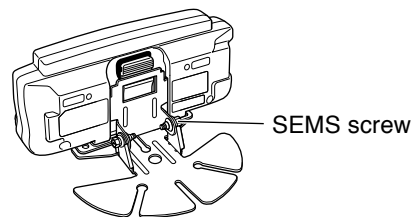

1

## FIXED STATION INSTALLATION

- 1 When placing the main unit on a surface such as a desk top, use the supplied cushions to prevent the surface from being scratched. Attach the 4 cushions to the base of the main unit as illustrated below.

**Note:** Attach the cushions to the flat surface on the main unit; otherwise the installation will be unstable and the cushions may come off easily.

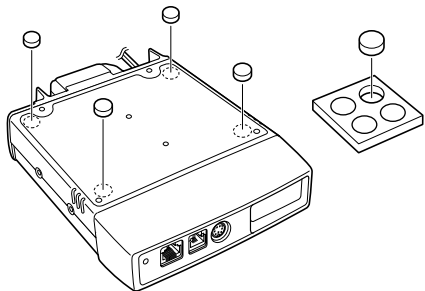

## MODULAR PLUG CABLE CONNECTION

Use the supplied modular plug cable to connect the front panel to the main unit. Connect the 4-pin plug to the front panel and the 6-pin plug to the main unit.

**Note:** The 6-pin plug is wider than the 4-pin plug.

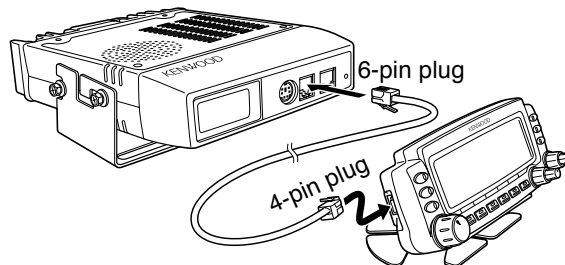

# DC POWER CABLE CONNECTION

## ■ Mobile Operation

The vehicle battery must have a nominal rating of 12 V. Never connect the transceiver to a 24 V battery. Be sure to use a 12 V vehicle battery that has sufficient current capacity. If the current to the transceiver is insufficient, the display may darken during transmission, or the transmit output power may drop excessively.

- 1 Route the supplied DC power cable directly to the vehicle's battery terminals using the shortest path from the transceiver.
  - When using a noise filter, install it with an insulator to prevent it from touching metal on the vehicle.
  - We recommend that you do not use the cigarette lighter socket since some cigarette lighter sockets introduce an unacceptable voltage drop.
  - When routing the power cable through a hole in the vehicle chassis or body, for example in the firewall at the front of the passenger compartment, use a rubber grommet to protect the cable from abrasion. Dismantle the fuse holder to pass the cable through the firewall.

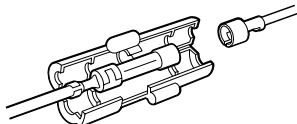

- The entire length of the cable must be dressed to isolate it from heat, moisture, and the engine secondary (high voltage) ignition system/ cables.

- 2 After the cable is in place, wind heat-resistant tape around the fuse holder to protect it from moisture, then tie down the full run of cable.
- 3 To prevent the risk of short circuits, disconnect other wiring from the negative (-) battery terminal before connecting the transceiver.
- 4 Confirm the correct polarity of the connections, then attach the power cable to the battery terminals; red connects to the positive (+) terminal and black connects to the negative (-) terminal.
  - Use the full length of the cable without cutting off excess, even if the cable is longer than required. In particular, never remove the fuse holders from the cable.

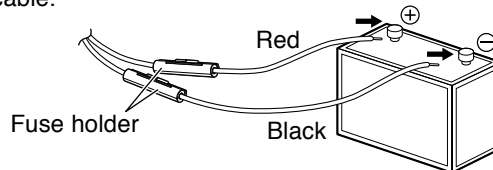

- 5 Reconnect any wiring removed from the negative terminal.
- 6 Connect the DC power cable to the transceiver's power supply connector.
  - Press the connectors firmly together until the locking tab clicks.

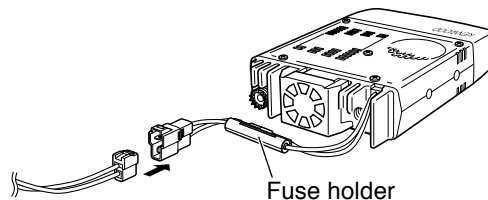

## ■ Fixed Station Operation

In order to use this transceiver for fixed station operation, you will need a separate 13.8 V DC power supply (purchased separately). We recommend using a power supply with a current capacity of 12 A.

### Note:

- ◆ To get the most out of your transceiver, we recommend using the optional PS-33 (20.5 A, 25% duty cycle) power supply.
- ◆ Before connecting the DC power supply to the transceiver, be sure to switch the transceiver and the DC power supply OFF.
- ◆ Do not plug the DC power supply into an AC outlet until you make all connections.

- 1 Connect the DC power cable to the regulated DC power supply and check that the polarities are correct (Red: positive, Black: negative).
  - Do not directly connect the transceiver to an AC outlet. Use the supplied DC power cable to connect the transceiver to a regulated power supply.
  - Do not substitute the cable with smaller gauge wires.

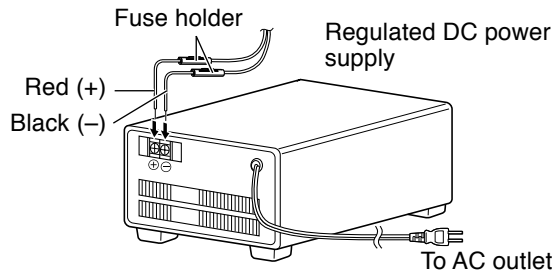

- 2 Connect the DC power cable to the transceiver's power supply connector.
  - Press the connectors firmly together until the locking tab clicks.

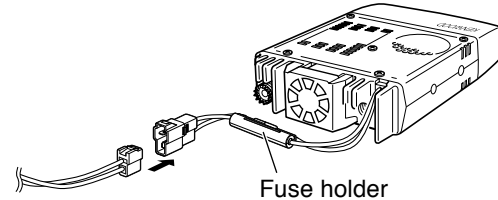

## ■ Replacing Fuses

If a fuse blows, determine the cause, then correct the problem. After the problem is resolved, replace the fuse. If newly installed fuses continue to blow, disconnect the power cable and contact your authorized **KENWOOD** dealer or an authorized **KENWOOD** service center for assistance.

Fuse Location	Fuse Current Rating
Transceiver	15 A
Supplied Accessory DC Power Cable	20 A



Only use fuses of the specified type and rating; otherwise the transceiver could be damaged.

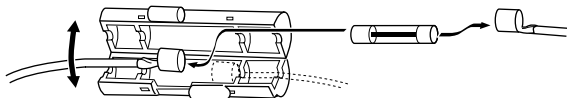

**Note:** If you use the transceiver for a long period when the vehicle battery is not fully charged or when the engine is OFF, the battery may become discharged and will not have sufficient reserves to start the vehicle. Avoid using the transceiver under these conditions.

## ANTENNA CONNECTION

Before operating, you must first install an efficient, well-tuned antenna. Successful transceiver operation will depend largely on the type of antenna and its correct installation. The transceiver can give excellent results if the antenna system and its installation are given careful attention.

Use a 50  $\Omega$  impedance antenna to match the transceiver input impedance. Also use a low-loss coaxial feed line that has a characteristic impedance of 50  $\Omega$ . Coupling the antenna to the transceiver via feed lines having an impedance other than 50  $\Omega$  reduces the efficiency of the antenna system, and can cause interference to nearby broadcast television receivers, radio receivers, and other electronic equipment.



- ◆ Transmitting without first connecting an antenna or other matched load may damage the transceiver. Always connect an antenna to the transceiver before transmitting.
- ◆ All fixed stations should be equipped with a lightning arrester to reduce the risk of fire, electric shock, and transceiver damage.

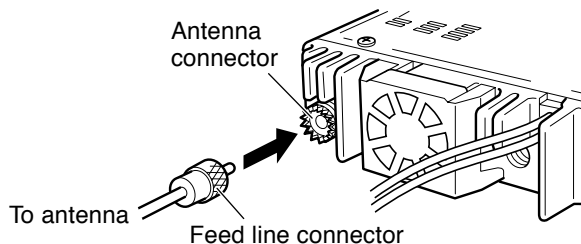

## ACCESSORY CONNECTIONS

### 1 ■ External Speakers

If you plan to use external speakers, choose speakers with an impedance of  $8\ \Omega$ . The external speaker jacks accept a 3.5 mm (1/8") mono (2-conductor) plug. For best performance, we recommend using the optional SP-50B speaker.

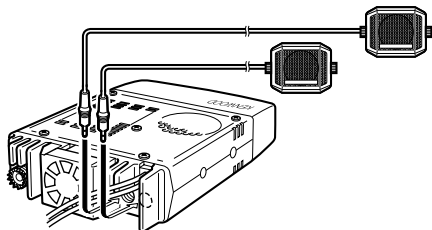

### ■ Microphone

To communicate in the voice modes, connect a 600  $\Omega$  microphone equipped with an 8-pin modular plug into the modular socket on the front of the main unit. Press firmly on the plug until the locking tab clicks.

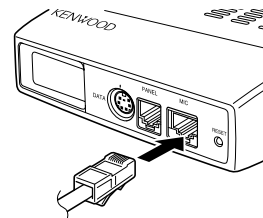

Attach a microphone hanger to an appropriate position using the screws included in the screw set.

Microphone hanger

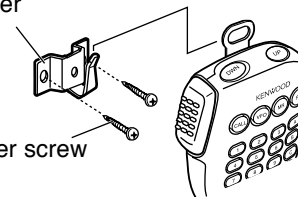

Microphone hanger screw  
(3 mm x 10 mm)

# YOUR FIRST QSO

If you tend to discard instruction manuals along with the packaging material...please don't. The 7 steps given here will get you on the air in your first QSO right away. So, you can enjoy the exhilaration that comes with opening a brand new transceiver.

After trying the rig for a while, settle back in your most comfortable operating chair with this manual and your favorite drink for an hour or two. The time spent will be worthwhile.

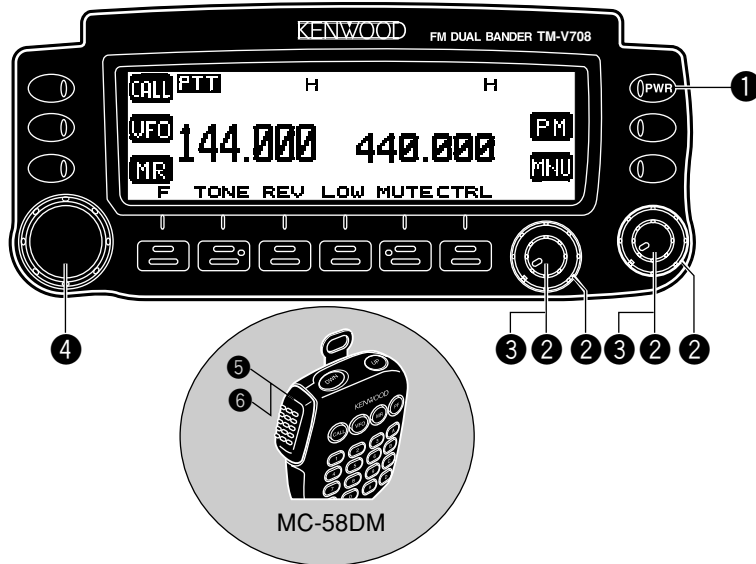

**1** Switch the DC power supply ON, then press the **PWR** switch.

**2**

**2** Turn the **VOL** and **SQL** controls to approximately the 9 o'clock position.

**3** Press [**BAND SEL**] to select the VHF or UHF band.

**4** Turn the **Tuning** control to select a frequency.

**5** Press and hold Mic [**PTT**], then speak in your normal tone of voice.

**6** Release Mic [**PTT**] to receive.

**7** Repeat steps **5** and **6** to continue communication.

# GETTING ACQUAINTED

## FRONT PANEL

**3** **Note:** This section describes only the main functions of the front panel controls and keys. For the functions not described here, you will find explanations in the appropriate sections of the manual.

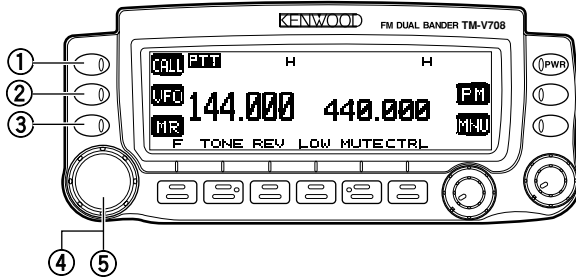

### ① CALL key

Recalls the Call channel {page 37}. Also starts or stops Call/VFO Scan {page 52} when in VFO mode, or Call/Memory Scan {page 52} when in Memory Recall mode.

### ② VFO key

Selects the VFO mode. In this mode you can change the operating frequency using the **Tuning** control or Mic **[UP]/ [DWN]**. Also provides:

- VFO Scan start to scan the entire VFO range {page 48}.
- Program Scan start to scan a programmed range of frequencies {page 50}.

### ③ MR key

Selects the Memory Recall mode {page 35}. In this mode you can change memory channels using the **Tuning** control or Mic **[UP]/ [DWN]**. Also starts Memory Scan {page 48}.

### ④ Tuning control

When turned, selects:

- Operating frequencies when in VFO mode {page 20}.
- Memory channels when in Memory Recall mode {page 35}.
- Menu Nos. when in Menu mode {page 22}.

This control is used for various other selections.

When an up arrow (↑) and down arrow (↓) are visible as key labels, the **Tuning** control functions the same as the up and down arrow keys.

### ⑤ MHz key

When pressed, selects the MHz mode. In this mode you can change the operating frequency in 1 MHz steps or 10 MHz steps {page 20} using the **Tuning** control or Mic **[UP]/ [DWN]**. Also starts MHz Scan {page 51}.



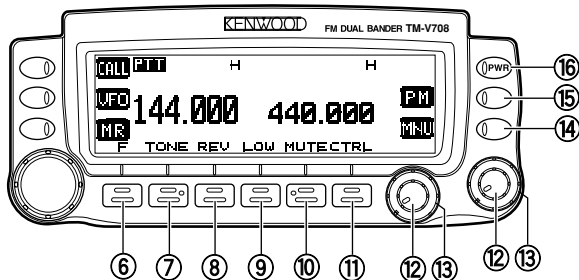

### ⑥ F (Function) key

Allows you to select the secondary functions that are available using multifunction keys.

### ⑦ TONE key

Activates the Tone {page 28}, CTCSS {page 53}, or DCS function {page 55}.

### ⑧ REV key

Switches the transmit frequency and receive frequency when operating with an offset {page 27} or an odd-split memory channel {page 34}.

### ⑨ LOW key

Selects High, Medium, or Low transmit output power {page 21}.

### ⑩ MUTE key

Mutes the speaker allocated to the control band {page 69}.

### ⑪ CTRL key

Selects the band that you can control using the front panel buttons or the microphone keys {page 17}.

### ⑫ VOL controls/ BAND SEL keys

When turned, adjusts the level of receive audio from the speaker {page 19}. Turn the left control (band A) or the right control (band B) depending on which band you want to operate.

When pressed, these keys select the desired TX band. Press the left key (band A) or the right key (band B) depending on which band you want to select.

For band A and B, see page 17.

### ⑬ SQL control

When turned, adjusts the squelch level {page 20}. This allows you to mute the speaker when no signals are present.

### ⑭ MNU key

Selects the Menu mode {page 22}.

### ⑮ PM key

Selects the Programmable Memory (PM) mode {page 42}.

### ⑯ PWR switch

Switches the transceiver ON or OFF {page 19}.

## MAIN UNIT — FRONT

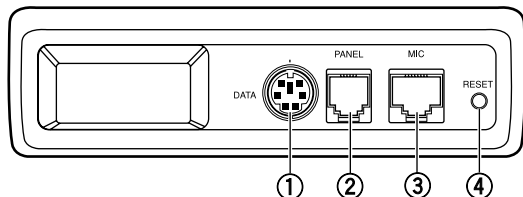

3

**Note:** Turn the transceiver power OFF before connecting or removing cables.

### ① DATA connector

Accepts a 6-pin mini DIN plug for connecting to an external TNC {page 71}.

### ② PANEL connector

Insert the 6-pin plug of the supplied modular plug cable for connecting the front panel {page 4}.

### ③ MIC connector

Insert the modular plug on the microphone cable until the locking tab clicks {page 8}.

### ④ RESET button

Press for 1 second or longer to perform Full Reset {page 39}. No confirmation message appears. Use this switch when the microcomputer and/or the memory chip malfunction due to ambient factors.

## MAIN UNIT — REAR

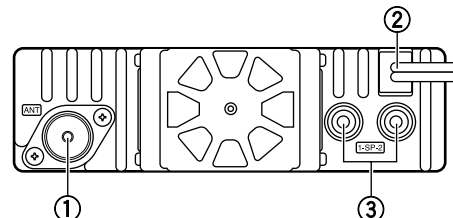

### ① Antenna connector

Connect an external antenna {page 7}. When making test transmissions, connect a dummy load in place of the antenna. The antenna system or load should have an impedance of 50  $\Omega$ . The TM-V708 accepts a male PL-259 connector. This transceiver has only one antenna connector because of a built-in duplexer.

### ② Power Input 13.8 V DC cable

Connect a 13.8 V DC power source. Use the supplied DC power cable {pages 5 and 6}.

### ③ Speaker jacks

If you wish, connect an optional external speaker for clearer audio. These jacks accept a 3.5 mm (1/8") mono (2-conductor) plug. See page 8.

# MICROPHONE

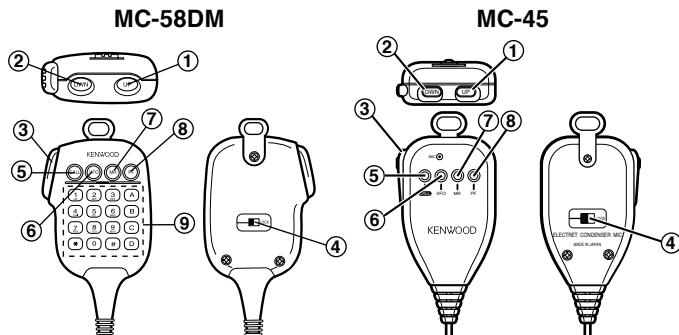

## ① UP key

Raises the operating frequency, memory channel number, menu number, etc. Holding this key down causes the action to be repeated. Also, switches between values for functions with multiple choices.

## ② DWN key

Lowers the operating frequency, memory channel number, menu number, etc. Holding this key down causes the action to be repeated. Also, switches between values for functions with multiple choices.

## ③ PTT (Push-to-Talk) switch

Press and hold to transmit, then release to receive.

## ④ LOCK switch

Locks all microphone keys except [PTT] and (if equipped) the DTMF keypad.

## ⑤ CALL key

Identical to the front panel **CALL** key. This key can be reprogrammed if desired {page 60}.

## ⑥ VFO key

Identical to the front panel **VFO** key. This key can be reprogrammed if desired {page 60}.

## ⑦ MR key

Identical to the front panel **MR** key. This key can be reprogrammed if desired {page 60}.

## ⑧ PF key

Depending on which function you select in Menu 1–8–1 (PF1), the function of this key varies. Refer to “PROGRAMMABLE FUNCTION (PF) KEYS” {page 60}.

## ⑨ DTMF keypad

The 16-key keypad is used for DTMF functions {page 57}, or to directly enter an operating frequency {page 61}, memory channel number {page 35}, tone frequency {page 28}, or CTCSS frequency {page 54}. The keypad is also available to program a memory channel name {pages 36 and 58}, Power-on message {page 68}, or other character strings.

## INDICATORS

On the display you will see various indicators that show what you have selected.

3

Indicator	What You Selected	What You Press to Cancel	Ref. Page
<b>T</b>	Tone function	[TONE], [TONE], [TONE]	28
<b>CT</b>	CTCSS	[TONE], [TONE]	53
<b>DCS</b>	DCS	[TONE]	55
<b>+</b>	Plus offset direction	[F], [SHIFT], [F], [SHIFT]	27
<b>-</b>	Minus offset direction	[F], [SHIFT]	27
<b>R</b>	Reverse	[REV]	31
<b>T</b>	Automatic Simplex Check	[REV]	31
<b>H</b>	High transmit power	Default	21
<b>M</b>	Medium transmit power	[LOW], [LOW] to select the default	21
<b>L</b>	Low transmit power	[LOW] to select the default	21
<b>*</b>	Locked-out memory channel	Use Menu 1–4–3.	49
<b>A.B.C.</b>	Auto Band Change	[F], [A.B.C.]	64

Indicator	What You Selected	What You Press to Cancel	Ref. Page
<b>LOCK</b>	Transceiver Lock	[F], [MHz]	65
<b>ALL LOCK</b>	All-control Lock	[MHz]+ POWER ON, then [F], [MHz]	65
<b>MUTE</b>	Speaker Mute	[MUTE]	69

When you receive a signal:



- “BUSY” appears when the squelch {page 20} is open.
- The S-meter shows the strength of received signals.

## BASIC TRANSCEIVER MODES

This section introduces you to the basic modes you can select.

### VFO mode

Press **[VFO]** to select. You can change the operating frequency using the **Tuning** control or Mic **[UP]/ [DWN]**.

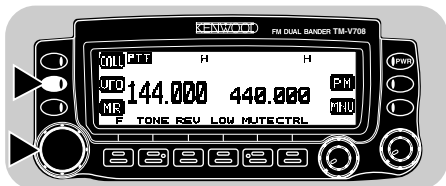

### Memory Recall mode

Press **[MR]** to select. You can change memory channels using the **Tuning** control or Mic **[UP]/ [DWN]**, where you stored frequencies and related data. Refer to “MEMORY CHANNELS” {page 33}.

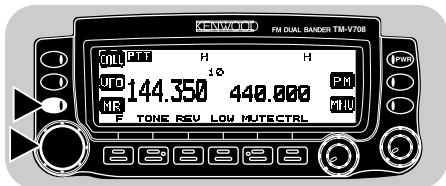

## Programmable Memory (PM) mode

Press **[PM]** to select. You can select the transceiver environment that you stored in PM channels, by pressing **[1]** to **[5]**. Refer to “PROGRAMMABLE MEMORY (PM)” {page 40}.

3

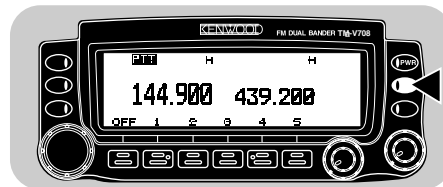

### Menu mode

Press **[MNU]** to select. You can change Menu Nos. using the **Tuning** control or **[↑]/ [↓]**. Refer to “MENU SETUP” {page 22}.

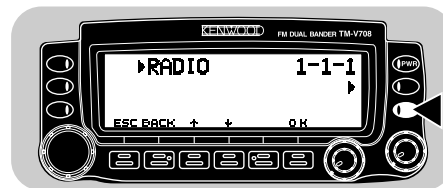

## KEY FUNCTION DISPLAY

The functions of the 6 keys below the display can be identified through the labels shown on the bottom of the display. After pressing [F], pressing [F] ([OFF]) again restores the basic state.

3

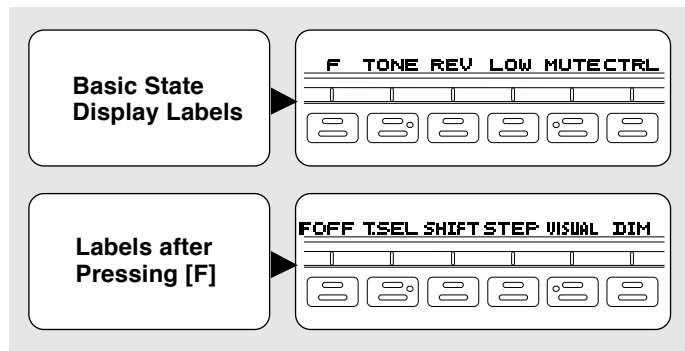

**Note:** When selecting Programmable Memory (PM) mode (page 15), you will see different labels.

The labels of the 5 buttons beside the display are shown on the left and right sides of the display. These labels will change depending on the current mode.

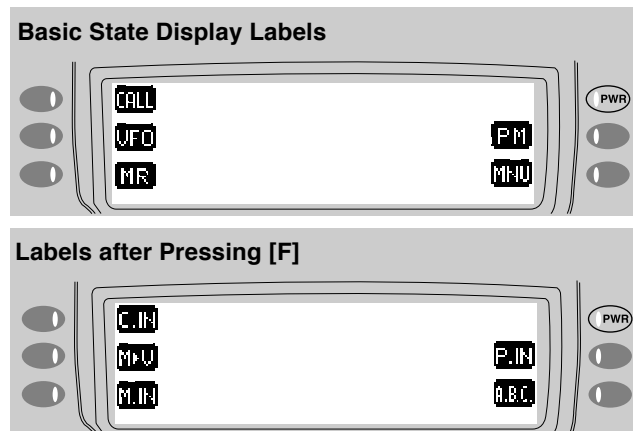

## BAND A & B

In this manual, the band recalled at the left on the display is referred to as band A, and the band at the right is called band B. In band A you can recall a 144 MHz band (default) or a 440 MHz sub-band. In band B you can recall a 440 MHz band (default) or a 144 MHz sub-band. You can also recall a 118 MHz, 220 MHz, or 300 MHz sub-band in band A, and a 300 MHz or 1.2 GHz in band B. This transceiver is capable of simultaneously receiving on bands A and B.

Press the left or right **[BAND SEL]** to select band A or B. To recall the sub-band, press **[F]**, then the same **[BAND SEL]**. The following diagram shows how the bands are switched on a TM-V708A.

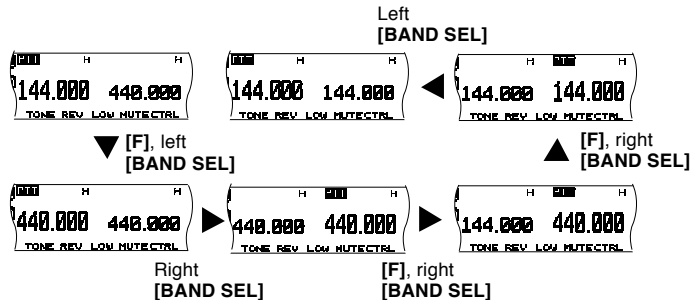

### Note:

- ◆ You cannot recall a sub-band in Memory Recall mode. First press **[VFO]** to select VFO mode.
- ◆ You cannot recall the UHF sub-band in band A and the VHF sub-band in band B at the same time.
- ◆ The 118 MHz, 220 MHz, 300 MHz, or 1.2 GHz band cannot be used for transmitting.
- ◆ For the range of each band, see "SPECIFICATIONS" (page 83).

## TX BAND AND CONTROL BAND

One thing that may confuse you on this transceiver is the idea of the TX band and Control band. To avoid confusion, please note the differences between the TX band and the Control band, below.

3

### TX Band

Press the left **[BAND SEL]** (band A) or the right **[BAND SEL]** (band B) to select. On the display, "PTT" shows which band (A or B) is currently selected as the transmit (TX) band. You can use the TX band to transmit signals or to control the transceiver.

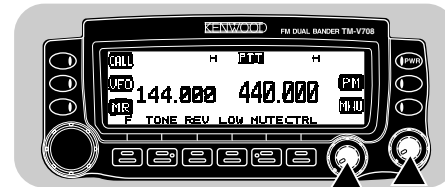

### Control Band

Press **[CTRL]** to select. On the display, "Ctrl" shows which band (A or B) is currently selected as the Control band. Use this function when you want to control the band which is not currently set as the TX band. After selecting the Control band, you cannot control the TX band.

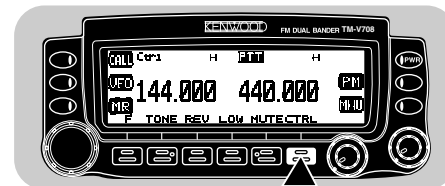

## MIC KEYPAD DIRECT ENTRY (MC-58DM ONLY)

The keypad on the MC-58DM allows you to make various entries depending on which mode the transceiver is in.

- In VFO or Memory Recall mode, use the Mic keypad to select a frequency {page 61} or memory channel number {page 35}. In Tone or CTCSS frequency Select mode, use the keypad to select a Tone frequency {page 28} or CTCSS frequency {page 54}. First press the Mic PF key programmed as the ENTER key {page 60}.

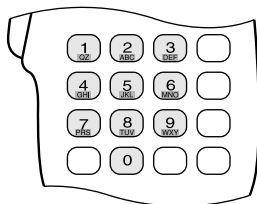

To manually send a DTMF number, press and hold Mic **[PTT]**, then press the DTMF keys on the Mic keypad {page 57} in sequence.

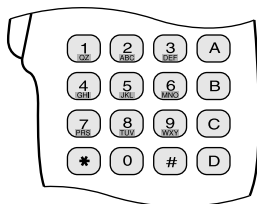

You can also use the Mic keypad to program a memory channel name {pages 36 and 58}, Power-on message {page 68}, or other character strings. Each press of a Mic key switches entry of characters as below. You can always use Mic **[A]** as **[➡]**, **[B]** as **[⬅]**, **[C]** as **[DEL]**, and **[D]** as **[OK]**.

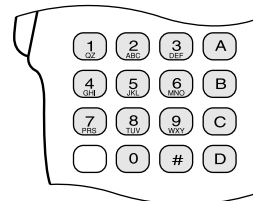

1	q	z	1	Q	Z			6	m	n	o	6	M	N	O	
2	a	b	c	2	A	B	C	7	p	r	s	7	P	R	S	
3	d	e	f	3	D	E	F	8	t	u	v	8	T	U	V	
4	g	h	i	4	G	H	I	9	w	x	y	9	W	X	Y	
5	j	k	l	5	J	K	L	0	Space	0						
#	?	!	'	.	,	-	/	&	#	%	(	)	<	>	;	:
	"	@														



# OPERATING BASICS

## SWITCHING THE POWER ON/OFF

- 1 Switch the DC power supply ON.
  - If operating mobile, skip this step.
- 2 Press the **PWR** switch to switch the transceiver ON.



- 3 To switch the transceiver OFF, press the **PWR** switch again.
- 4 If operating as a fixed station, switch the DC power supply OFF.
  - You may skip step 3. After switching the transceiver ON, you can switch it OFF or ON using only the power switch of the DC power supply.

## ADJUSTING THE VOLUME

Turn the **VOL** control clockwise to increase the audio level and counterclockwise to decrease the audio level.

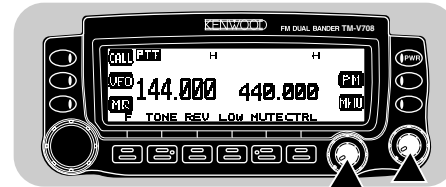

- If background noise is inaudible because of the Squelch function, press the Mic PF key assigned the Monitor function {page 60}, then adjust the **VOL** control. Press the PF key again to cancel the Monitor function.

## SELECTING A BAND

Press the left **[BAND SEL]** to select band A, or the right **[BAND SEL]** to select band B.

- “PTT” moves to the selected band.

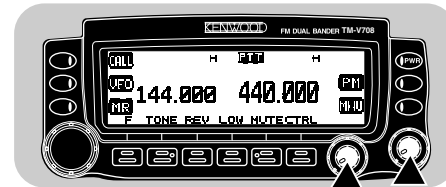

- For band A and B, see page 17.

4

## SELECTING A FREQUENCY

- 1 Press **[VFO]** to select VFO mode.

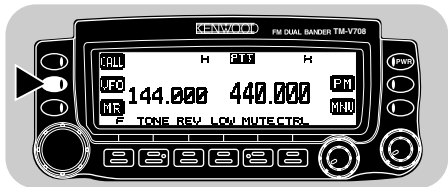

- 2 To increase the frequency, turn the **Tuning** control clockwise or press Mic **[UP]**. To decrease the frequency, turn the **Tuning** control counterclockwise or press Mic **[DWN]**.

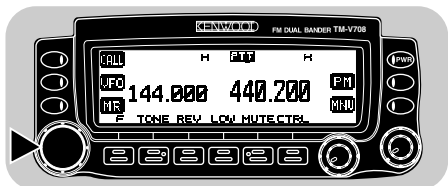

- Pressing and holding Mic **[UP]**/ **[DWN]** causes the frequency to step repeatedly.
- To change frequencies in steps of 1 MHz, press **[MHz]** (**Tuning** control) first. Pressing **[MHz]** again cancels this function.
- To change frequencies in steps of 10 MHz, press **[F]+[MHz]** first. Pressing **[F]** cancels the 10 MHz function; pressing **[MHz]** starts the 1 MHz function.

When using a MC-58DM, you can also use its keypad to select frequencies. See "DIRECT FREQUENCY ENTRY (WITH MC-58DM ONLY)" {page 61}.

## ADJUSTING THE SQUELCH

The purpose of the Squelch is to mute the speaker when no signals are present. With the squelch level correctly set, you will hear sound only when actually receiving signals. The higher the squelch level selected, the stronger the signals must be to receive. The appropriate squelch level depends on ambient RF noise conditions.

Turn the **SQL** control when no signals are present, and select the squelch level at which the background noise is just eliminated.

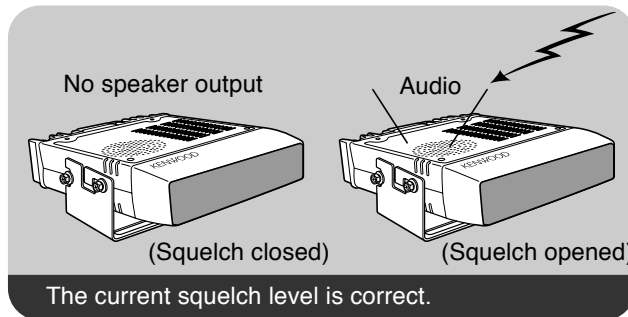
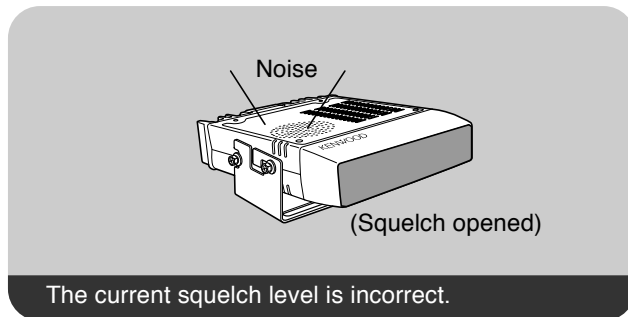

## TRANSMITTING

1 To transmit, press and hold Mic [PTT] and speak into the microphone in your normal tone of voice.

- “ON AIR” and the RF power meter appear.

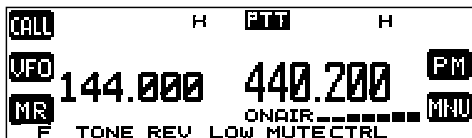

- Speaking too close to the microphone, or too loudly, may increase distortion and reduce intelligibility of your signals at the receiving station.
- The RF power meter shows the relative transmit output power.

2 When you finish speaking, release Mic [PTT].

---

**Time-out Timer:** Holding down Mic [PTT] for more than 10 minutes causes the transceiver to generate a beep and stop transmitting. Release, then press Mic [PTT] to resume transmitting. You can change the timer to 3 or 5 minutes {page 67}.

---

## ■ Selecting Output Power

It's wise to select lower transmit power if communication is still reliable. This lowers the risk of interfering with others on the band. When operating using battery power, you will enjoy more operating time before a charge is necessary.

Press [LOW] to select high (“H”), medium (“M”), or low (“L”) power. The default is high.

- You can program a different output power for band A and B.

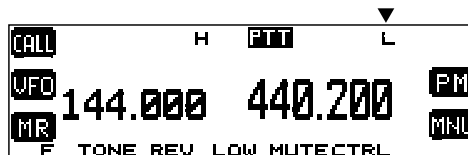

CAUTION

- ◆ Do not transmit at high output power for an extended period of time. The transceiver could overheat and malfunction.
- ◆ Continuous transmission causes the heat sink to overheat. Never touch the heat sink when it may be hot.

---

**Note:** When the transceiver overheats because of ambient high temperature or continuous transmission, the protective circuit may function to lower the transmit output power.

---

4

# MENU SETUP

The Menu system on this transceiver consists of 3 levels, as illustrated below.

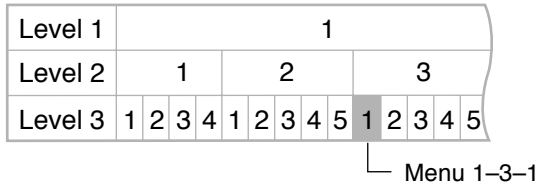

5

## MENU ACCESS

- 1 Press **[MNU]** to enter Menu mode.
  - The current level 2 number blinks.
- 2 Press **[↑]/[↓]** to select your desired level 2 number.
- 3 Press **[OK]**.
  - The current level 3 number blinks.



- 4 Press **[↑]/[↓]** to select your desired level 3 number.
  - To move back to level 2, press **[BACK]**.
  - To exit Menu mode, press **[ESC]**.
- 5 Press **[OK]**.



- 6 Press **[↑]/[↓]** to select a parameter.
  - The procedure in this step varies depending on which menu item you selected. Refer to the appropriate sections in this manual.
- 7 Press **[OK]** to complete the setting.
- 8 Press **[MNU]** to exit Menu mode.

---

**Note:** Menu system level 1 is always set at "1". This number cannot be changed.

---

# MENU CONFIGURATION

Level 1		Level 2		Level 3		Selections	Default	Ref. page
1	RADIO	1	DISPLAY	1	Power-on Message	See reference page.	HELLO !!	68
				2	Contrast	Level 1 (min.) ~ 16 (max.)	Level 8	63
				3	Reverse mode	Positive/ Negative	Positive	63
				4	Auto Dimmer Change	ON/ OFF	OFF	63
		2	AUDIO	1	Beep volume	Level 1 (min.) ~ 7 (max.)/ OFF	Level 5	66
				2	Key Beep	ON/ OFF	ON	66
				3	Speaker configuration	Mode 1/ 2	Mode 1	69
				4	Voice Synthesizer <sup>1</sup>	English/ Japanese/ OFF	OFF	77
				5	Voice volume <sup>1</sup>	Level 1 (min.) ~ 7 (max.)	Level 5	77
		3	TX/RX	1	Programmable VFO	See reference page.	—	62
				2	S-meter Squelch	ON/ OFF	OFF	65
				3	Squelch hang time	125 / 250 / 500 msec/ OFF	OFF	66
				4	FM/ AM mode	FM/ AM	See reference page.	66
				5	Advanced Intercept Point	ON/ OFF	OFF	67

5

<sup>1</sup> Only with an optional VS-3 unit installed.

Level 1		Level 2		Level 3		Selections	Default	Ref. page
1	RADIO	4	MEMORY	1	Auto PM Channel Store	ON/ OFF	ON	43
				2	Channel Display	ON/ OFF	OFF	38
				3	Memory Channel Lockout	ON/ OFF	OFF	49
				4	Memory channel name	See reference page.	—	36
		5	DTMF	1	Number Store	See reference page.	—	58
				2	TX speed	Fast/ Slow	Fast	59
				3	Pause	100/ 250/ 500/ 750/ 1000/ 1500/ 2000 msec	500 msec	59
		7	REPEATER	1	Offset frequency	0.00 ~ 29.95 MHz in steps of 50 kHz	See reference page.	27
				2	Automatic Repeater Offset	ON/ OFF	ON	29
				3	Call Button Function	Call/ 1750 Hz TX	Call	30
				4	TX Hold	ON/ OFF	OFF	30
				5	Repeater Hold	ON/ OFF	OFF	76
				6	Repeater Function	Locked-band/ Cross-Band/ OFF	OFF	76
		8	MIC	1	Mic PF Key	See reference page.	A/B	60
				2	Mic MR Key	See reference page.	MR	60
				3	Mic VFO Key	See reference page.	VFO	60
				4	Mic CALL Key	See reference page.	CALL	60
				5	Microphone Control	ON/ OFF	OFF	73
				6	DTMF Monitor	ON/ OFF	OFF	57

Level 1		Level 2		Level 3		Selections	Default	Ref. page
1	RADIO	9	AUX	1	Scan Resume	Time-Operated/ Carrier-Operated/ Seek	Time-Operated	47
				2	Number of Channels for Visual Scan	31/ 61/ 91/ 181	61	45
				3	Automatic Power Off (APO)	ON/ OFF	OFF	67
				4	Time-out Timer (TOT)	3/ 5/ 10 minutes	10 minutes	67
				6	Data port	1200/ 9600 bps	1200 bps	72
				7	Reset	See reference page.	—	39
		A	REMOTE CON	1	Secret code	See reference page.	000	74
				2	Acknowledgement	ON/ OFF	OFF	75
				3	Remote Control	ON/ OFF	OFF	75

# OPERATING THROUGH REPEATERS

Repeaters, which are often installed and maintained by radio clubs, are usually located on mountain tops or other elevated locations. Generally they operate at higher ERP (Effective Radiated Power) than a typical station. This combination of elevation and high ERP allows communications over much greater distances than communications without using repeaters.

**6** Most repeaters use a receive and transmit frequency pair with a standard or non-standard offset (odd-split). In addition, some repeaters must receive a tone from the transceiver to allow it to access. For details, consult your local repeater reference.

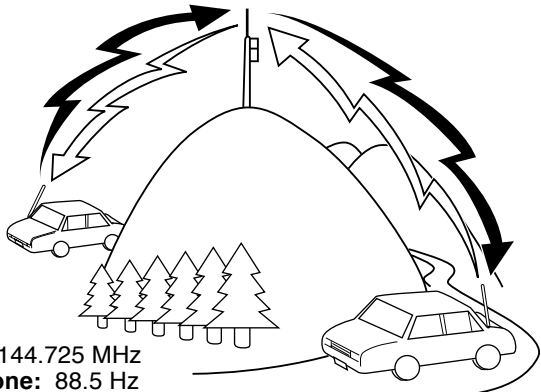

**TX:** 144.725 MHz  
**TX tone:** 88.5 Hz  
**RX:** 145.325 MHz

**TX:** 144.725 MHz  
**TX tone:** 88.5 Hz  
**RX:** 145.325 MHz

## Offset Programming Flow

- 1 Select a band.
- 2 Select a receive frequency.
- 3 Select an offset direction.
- 4 Select an offset frequency.  
(Only when programming odd-split repeater frequencies.)
- 5 Activate the Tone function (if necessary).
- 6 Select a tone frequency (if necessary).

If you store the above data in a memory channel, you need not reprogram every time. See "MEMORY CHANNELS" {page 33}.



## PROGRAMMING OFFSET

First select band A or B by pressing the left or right **[BAND SEL]**. To recall the sub-band next, press **[F]**, then the same **[BAND SEL]**.

### ■ Selecting Offset Direction

Select whether the transmission frequency will be higher (+) or lower (–) than the reception frequency.

Press **[F]**, **[SHIFT]** to switch the offset direction.

- “+” or “–” appears, indicating which offset direction is selected.



If the offset transmission frequency falls outside the allowable range, transmission is inhibited. Use one of the following methods to bring the transmission frequency within the band limits:

- Move the reception frequency further inside the band.
- Change the offset direction.

---

**Note:** While using an odd-split memory channel or while transmitting, you cannot change the offset direction.

---

### ■ Selecting Offset Frequency

To access a repeater which requires an odd-split frequency pair, change the offset frequency from the default which is used by most repeaters. The default offset frequency on the VHF band is 600 kHz; the default on the UHF band is 5 MHz.

- 1 Press **[MNU]** to enter Menu mode.
- 2 Press **[↑]/[↓]** to select “REPEATER (1–7–)”, then press **[OK]**.
- 3 Press **[↑]/[↓]** to select “OFFSET FREQUENCY (1–7–1)”, then press **[OK]**.



- 4 Press **[↑]/[↓]** to select the appropriate offset frequency.
  - The selectable range is from 0.00 MHz to 29.95 MHz in steps of 50 kHz.
- 5 Press **[OK]** to complete the setting.
- 6 Press **[MNU]** to exit Menu mode.

6

## ■ Activating Tone Function

Press [TONE] to activate the Tone function.

- “T” appears when the Tone function is ON.



- Each press of [TONE] changes the selection as Tone → CTCSS → DCS → No selection.

### Note:

- ◆ You cannot use Tone with the CTCSS and DCS functions.
- ◆ You need to activate the Tone function only when selecting one of the 38 standard frequencies. The selection you make here will not affect transmission of a 1750 Hz tone.

## ■ Selecting a Tone Frequency

**Note:** The procedures for transmitting a 1750 Hz tone are described on page 30.

1 Press [TONE] to activate the Tone function.

- “T” appears when the Tone function is ON.

2 Press [F], [T.SEL].

- The current tone frequency appears and blinks. The default is 88.5 Hz.

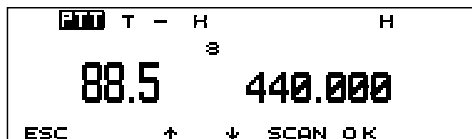

3 Press [↑]/[↓] to select the appropriate tone frequency.

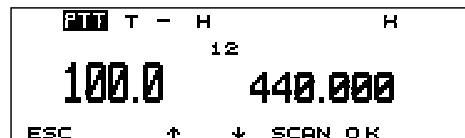

4 Press [OK] to complete the setting.

No.	Freq. (Hz)	No.	Freq. (Hz)	No.	Freq. (Hz)	No.	Freq. (Hz)
01	67.0	11	97.4	21	136.5	31	192.8
02	71.9	12	100.0	22	141.3	32	203.5
03	74.4	13	103.5	23	146.2	33	210.7
04	77.0	14	107.2	24	151.4	34	218.1
05	79.7	15	110.9	25	156.7	35	225.7
06	82.5	16	114.8	26	162.2	36	233.6
07	85.4	17	118.8	27	167.9	37	241.8
08	88.5	18	123.0	28	173.8	38	250.3
09	91.5	19	127.3	29	179.9		
10	94.8	20	131.8	30	186.2		

When using a MC-58DM, you can also use its keypad to select a tone frequency. First program one of the Mic PF keys as the ENTER key {page 60}. In step 2 (above), press [ENTER], then enter 01 to 38 to select the frequencies listed in the above table. To select 79.7 Hz, for example, press [ENTER], [0], [5].

## AUTOMATIC REPEATER OFFSET

This function automatically selects an offset direction, according to the frequency that you select on the VHF band. The transceiver is programmed for offset direction as shown below. To obtain an up-to-date band plan for repeater offset direction, contact your national Amateur Radio association.

This complies with the standard ARRL band plan.

144.0    145.5    146.4    147.0    147.6  
145.1    146.0    146.6    147.4    148.0 MHz

S	-	S	+	S	-	+	S	-
---	---	---	---	---	---	---	---	---

S: Simplex

---

**Note:** Automatic Repeater Offset does not function when Reverse is ON. However, pressing **[REV]** after Automatic Repeater Offset has selected an offset (split) status, exchanges the receive and transmit frequencies.

---

- 1 Press **[MNU]** to enter Menu mode.
- 2 Press **[↑]/[↓]** to select “REPEATER (1-7-2)”, then press **[OK]**.
- 3 Press **[↑]/[↓]** to select “AUTO OFFSET (1-7-2)”, then press **[OK]**.



- 4 Press **[↑]/[↓]** to switch the function ON (default) or OFF.
- 5 Press **[OK]** to complete the setting.
- 6 Press **[MNU]** to exit Menu mode.

6

## TRANSMITTING A 1750 Hz TONE

Most repeaters in Europe require a transceiver to transmit a 1750 Hz tone. It is possible to program **[CALL]** on the front panel as a key for transmitting a 1750 Hz tone.

- 1 Press **[MNU]** to enter Menu mode.
- 2 Press **[↑]/[↓]** to select “REPEATER (1-7-–)”, then press **[OK]**.
- 3 Press **[↑]/[↓]** to select “1750 KEY (1-7-3)”, then press **[OK]**.



- 4 Press **[↑]/[↓]** to select “1750”.
- 5 Press **[OK]** to complete the setting.
- 6 Press **[MNU]** to exit Menu mode.
  - “1750” appears in place of “CALL” as the key label.

### Note:

- ◆ You can also program a Mic PF key as the 1750 Hz Tone function {page 60}.
- ◆ The transceiver continuously transmits a 1750 Hz tone until you release Mic **[CALL]** or **[CALL]**.

Some repeaters in Europe must receive continuous signals for a certain period of time, following a 1750 Hz tone. This transceiver is also capable of remaining in the transmit mode for 2 seconds after transmitting a 1750 Hz tone.

- 1 Press **[MNU]** to enter Menu mode.
- 2 Press **[↑]/[↓]** to select “REPEATER (1-7-–)”, then press **[OK]**.
- 3 Press **[↑]/[↓]** to select “TX HOLD (1-7-4)”, then press **[OK]**.



- 4 Press **[↑]/[↓]** to switch the function ON (or OFF).
- 5 Press **[OK]** to complete the setting.
- 6 Press **[MNU]** to exit Menu mode.

---

**Note:** While remaining in the transmit mode, the transceiver does not continuously transmit a 1750 Hz tone.

---

## REVERSE FUNCTION

The reverse function exchanges a separate receive and transmit frequency. So, while using a repeater, you can manually check the strength of a signal that you receive directly from the other station. If the station's signal is strong, both stations should move to a simplex frequency to free up the repeater.

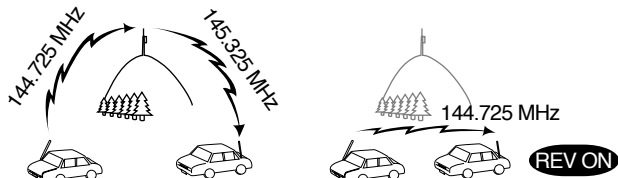

TX: 144.725 MHz TX: 144.725 MHz TX: 144.725 MHz TX: 145.325 MHz  
RX: 145.325 MHz RX: 145.325 MHz RX: 145.325 MHz RX: 144.725 MHz

Press **[REV]** to switch the Reverse function ON (or OFF).

- “R” appears when this function is ON.



### Note:

- ◆ If pressing **[REV]** places the transmission frequency outside the allowable range, then pressing Mic **[PTT]** causes an error beep to sound; transmission is inhibited.
- ◆ If pressing **[REV]** places the reception frequency outside the allowable range, an error beep sounds and no reversal occurs.
- ◆ You cannot switch Reverse ON or OFF while transmitting.

## AUTOMATIC SIMPLEX CHECK (ASC)

While using a repeater, ASC periodically monitors the strength of a signal that you receive directly from the other station. If the station's signal is strong enough to allow direct contact without a repeater, the ASC indicator on the display begins blinking.

Press **[REV]** (1 s) to switch the function ON.

- The ASC indicator appears when this function is ON.



- While direct contact is possible, the ASC indicator blinks.
- To end this function, press **[REV]**.

### Note:

- ◆ Pressing Mic **[PTT]** causes the ASC indicator to quit blinking.
- ◆ ASC does not function if your transmit and receive frequencies are the same (simplex operation).
- ◆ ASC does not function while scanning.
- ◆ Activating ASC while using Reverse switches Reverse OFF.
- ◆ If you recall a memory channel or the Call channel that contains Reverse ON status, ASC is switched OFF.
- ◆ ASC causes receive audio to be momentarily intermitted every 3 seconds.

## TONE FREQUENCY ID

This function scans through all tone frequencies to identify the incoming tone frequency on a received signal. You may use this function to find which tone frequency is required by your local repeater.

- 1 Press **[TONE]** to switch the Tone function ON.
  - “T” appears when the Tone function is ON.
- 2 Press **[F]**, **[T.SEL]**.
  - The current tone frequency appears and blinks.
- 3 Press **[SCAN]** to activate the Tone Frequency ID.
  - “T SCAN” appears and blinks.

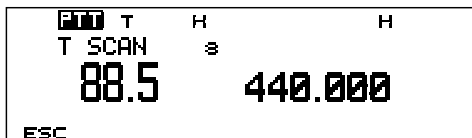

- Scan starts when signals are received.
- To reverse the scan direction, turn the **Tuning** control clockwise (upward scan) or counterclockwise (downward scan). You can also press Mic **[UP]/ [DWN]**.
- To end this function, press **[ESC]**.
- When the tone frequency is identified, the identified frequency appears and blinks.

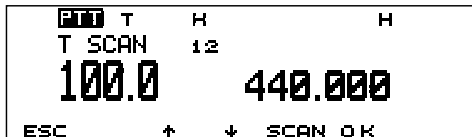

- 4 Press **[OK]** to program the identified frequency in place of the currently set tone frequency.
  - The Tone function will remain ON. You can press **[TONE]** to switch the Tone function OFF.
  - Press **[ESC]** if you do not want to program the identified frequency.
  - Press **[SCAN]** while the identified frequency is blinking, to resume scanning.

# MEMORY CHANNELS

In memory channels, you can store frequencies and related data that you often use. Then you need not reprogram that data every time. You can quickly recall a programmed channel by simple operation. A total of 200 memory channels are available for bands A and B.

## SIMPLEX & REPEATER OR ODD-SPLIT MEMORY CHANNEL?

You can use each memory channel as a simplex & repeater channel or as an odd-split channel. Store only one frequency to use as a simplex & repeater channel or two separate frequencies to use as an odd-split channel. Select either application for each channel depending on the operations you have in mind.

Simplex & repeater channel allows:

- Simplex frequency operation
- Repeater operation with a standard offset (If an offset direction is stored)

Odd-split channel allows:

- Repeater operation with a non-standard offset

---

**Note:**

- ◆ Not only can you store data in memory channels, you can also overwrite existing data with new data.
  - ◆ If you have recalled a memory channel on the non-control band (A or B), you cannot select the same channel on the control band to program data.
- 

The data listed below can be stored in each memory channel:

Parameter	Simplex & Repeater	Odd-split
Receive frequency	Yes	Yes
Transmit frequency		Yes
Tone frequency	Yes	Yes
Tone ON	Yes	Yes
CTCSS frequency	Yes	Yes
CTCSS ON	Yes	Yes
DCS code	Yes	Yes
DCS ON	Yes	Yes
Offset direction	Yes	N/A
Offset frequency	Yes	N/A
Reverse ON	Yes	N/A
Frequency step size	Yes	Yes
Memory channel lockout	Yes	Yes
Memory channel name	Yes	Yes
FM/ AM mode selection	Yes	Yes



Yes: Can be stored in memory.

N/A: Cannot be stored in memory.

## STORING SIMPLEX FREQUENCIES OR STANDARD REPEATER FREQUENCIES

- 1 Select the desired band.
- 2 Press [VFO].
- 3 Select the desired frequency.
- 4 To store a standard repeater frequency, select the following data:
  - Offset direction {page 27}
  - Tone ON, if necessary {page 28}
  - Tone frequency, if necessary {page 28}

To store a simplex frequency, you may select other related data (CTCSS ON, CTCSS frequency, etc.).

- 5 Press [F].
  - A memory channel number appears and blinks.
  - “” indicates the current channel is empty while “” indicates the channel contains data.



- 6 Turn the **Tuning** control, or press Mic [UP]/ [DWN], to select your desired memory channel.
- 7 Press [M.IN].

## STORING ODD-SPLIT REPEATER FREQUENCIES

Some repeaters use a receive and transmit frequency pair with a non-standard offset. If you store two separate frequencies in a memory channel, you can operate on those repeaters without programming an offset frequency and direction.

- 1 Select the desired receive frequency and related data using steps 1 to 4 given for simplex or standard repeater frequencies.
- 2 Press [F].
- 3 Turn the **Tuning** control, or press Mic [UP]/ [DWN], to select the desired memory channel.
- 4 Press [M.IN] (1 s).
  - “±” appears.

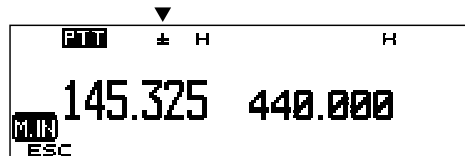

- 5 Select your desired transmit frequency.
- 6 Press [M.IN].

---

### Note:

- ◆ When you recall an odd-split memory channel, “±” appears on the display. To confirm the transmit frequency, press [REV].
  - ◆ Transmit Offset status and Reverse status are not stored in an odd-split memory channel.
-



## RECALLING A MEMORY CHANNEL

- 1 Select band A or B.
- 2 Press **[MR]** to enter Memory Recall mode.
  - The memory channel last used is recalled.

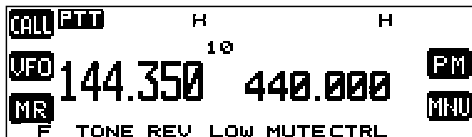

- 3 Turn the **Tuning** control, or press Mic **[UP]/ [DWN]**, to select your desired memory channel.
  - You cannot recall an empty memory channel.
  - To restore VFO mode, press **[VFO]**.

When using a MC-58DM, you can also use its keypad to recall a desired memory channel. First program one of the Mic PF keys as the ENTER key {page 60}. In Memory Recall mode press **[ENTER]**, then enter the channel number. To recall channel 3, for example, press **[ENTER]**, **[0]**, **[0]**, **[3]**.

---

### Note:

- ◆ When you recall an odd-split memory channel, “±” appears on the display. Press **[REV]** to display the transmit frequency.
  - ◆ After recalling a memory channel, you may program data such as Tone or CTCSS. These settings, however, are cleared once you select another channel or the VFO mode. To permanently store the data, overwrite the channel contents {page 34}.
- 

## CLEARING A MEMORY CHANNEL

Use the following procedure to clear an individual memory channel. Full Reset {page 39} is a quick way to clear all memory channels.

- 1 Recall your desired memory channel.
- 2 Switch the transceiver power OFF.
- 3 Press **[MHz]** (**Tuning control**)+ **POWER ON**.
  - A confirmation message appears.

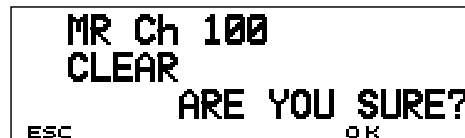

- To exit without clearing the memory channel, press **[ESC]**.

- 4 Press **[OK]**.

---

### Note:

- ◆ If you have recalled a memory channel on the non-control band (A or B), you cannot select the same channel on the control band to clear.
  - ◆ When in Channel Display mode, you cannot clear any memory channel.
-

## NAMING A MEMORY CHANNEL

You can name memory channels using up to 8 alphanumeric characters. When you recall a named memory channel, its name appears above the frequency. Names can be call signs, repeater names, cities, names of people, etc.

- 1 Recall your desired memory channel.
- 2 Press **[MNU]** to enter Menu mode.
- 3 Press **[↑]/[↓]** to select “MEMORY (1–4–)”, then press **[OK]**.
- 4 Press **[↑]/[↓]** to select “MEMORY NAME (1–4–4)”, then press **[OK]**.
  - The display for entering a memory name appears and the first digit blinks.



- 5 Turn the **Tuning** control to select the first digit.
  - You can enter alphanumeric characters and special ASCII characters.
- 6 Press **[→]**.
  - The cursor moves to the next digit.

- 7 Repeat steps 5 and 6 to enter up to 8 digits.

<b>CHAR</b>	Switches a blank character to a numerical character or a non-special ASCII character		
<b>A/S</b>	Switches between small and capital letters	<b>BACK</b>	Cancels Memory Name Entry
<b>DEL</b>	Deletes the digit or the character	<b>+</b>	Moves the cursor backward
<b>INS</b>	Inserts the digit or character selected	<b>CLR</b> (MEM AND SEQ)	Clears all stored channels

- 8 Press **[OK]** to complete the setting.
- 9 Press **[MNU]** to exit Menu mode.

The keypad on the MC-58DM can also be used to enter alphanumeric characters in step 5. Refer to page 18.

### Note:

- ◆ You can also name the Program Scan {page 50} and DTMF {page 58} channels, but you cannot name the Call channel {page 37}.
- ◆ You can assign names only to memory channels in which you have stored frequencies and related data.
- ◆ The stored names can be overwritten by repeating steps 1 to 9.
- ◆ The stored names also are erased by clearing memory channels.

## CALL CHANNEL

The Call channel can always be selected quickly no matter what mode the transceiver is in. For instance, you may use the Call channel as an emergency channel within your group. In this case, the Call/VFO scan {page 52} will be useful.

The default frequency stored in the Call channel is 144.000 MHz for the VHF band and 440.000 MHz for the UHF band. The Call channel can be reprogrammed either as a simplex & repeater or odd-split channel.

---

**Note:** Unlike channels 1 to 200 the Call channel cannot be cleared.

---

### ■ Recalling the Call Channel

- 1 Select your desired band.
- 2 Press **[CALL]** to recall the Call channel.
  - “CALL” appears.

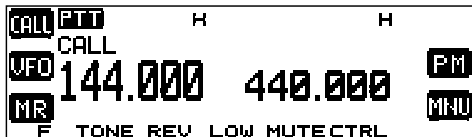

- To restore the previous mode, press **[CALL]** again.

### ■ Reprogramming the Call Channel

- 1 Select your desired band.
- 2 Press **[VFO]**.
- 3 Select the desired frequency and related data (Tone, CTCSS, etc.).
  - When you program the Call channel as an odd-split channel, select a receive frequency.
- 4 Press **[F]**, **[C.IN]**.
  - The selected frequency and related data are stored in the Call channel.
  - The previous mode is restored.
  - When programming as an odd-split channel, press **[F]**, **[C.IN]** (**1 s**) instead; “±” appears.

To also store a transmit frequency, proceed to the next step:

- 5 Select the desired transmit frequency.
- 6 Press **[C.IN]**.
  - The transmit frequency is stored in the Call channel and the previous mode is restored.

---

**Note:**

- ◆ Transmit Offset status and Reverse status are not stored in an odd-split Call channel.
  - ◆ To store data other than frequencies, select the data in step 3, not step 5.
- 

7

## MEMORY-TO-VFO TRANSFER

You may sometimes want to search for other stations or a clear frequency near the frequency stored in a memory channel or the Call channel. In this case first transfer the contents of a memory channel or the Call channel to the VFO.

- 1 Recall your desired memory channel or the Call channel.
- 2 Press **[F]**, **[M▶V]**.
  - The entire contents of the memory channel or the Call channel are copied to the VFO.

---

### Note:

- ◆ A transmit frequency from an odd-split memory channel or odd-split Call channel is not transferred to the VFO. To transfer a transmit frequency, press **[REV]**, then press **[F]**, **[M▶V]**.
  - ◆ Lockout status and memory names are not copied from a memory channel to the VFO.
  - ◆ If you recall the Call channel in step 1, simply turning the **Tuning Control** or pressing Mic **[UP]/ [DWN]** also transfers the contents to the VFO. The frequency, however, is changed by one step.
- 

## CHANNEL DISPLAY

When in this mode, the transceiver displays only memory channel numbers (and memory names if stored) instead of frequencies.

- 1 Press **[MNU]** to enter Menu mode.
- 2 Press **[↑]/ [↓]** to select “MEMORY (1–4–)”, then press **[OK]**.
- 3 Press **[↑]/ [↓]** to select “CHANNEL DISPLAY (1–4–2)”, then press **[OK]**.



- 4 Press **[↑]/ [↓]** to switch this function ON (or OFF).
- 5 Press **[OK]** to complete the setting.
- 6 Press **[MNU]** to exit Menu mode.

---

**Note:** You cannot switch this function ON unless you can recall any channel on both bands A and B.

---

When in Channel Display mode, you cannot use the following functions:

Sub-band Select	VFO Select	VFO Scan
Memory Store	PM Store	PM Recall
Memory-to-VFO Transfer	Partial/ Full/ PM Reset	Frequency Step Size Change
1/ 10 MHz Step Change	All-control Lock	

## PARTIAL OR FULL RESET?

If your transceiver seems to be malfunctioning, initializing the transceiver may resolve the problem. Use Full Reset to initialize all settings that you have customized. Partial (VFO) Reset does not initialize the following settings:

Memory channels	Memory channel names
Memory channel lockout	Call channels
Program scan channels	PM channels
DTMF memory channels	DTMF memory channel names

Some of the VFO factory defaults are listed below:

Parameter	Band A	Band B
VFO frequency	144.000 MHz	440.000 MHz
Frequency step	5 kHz	25 kHz
Tone frequency	88.5 Hz	88.5 Hz

- 1 Press **[MNU]** to enter Menu mode.
- 2 Press **[↑]/[↓]** to select “AUX (1–9–)”, then press **[OK]**.
- 3 Press **[↑]/[↓]** to select “RESET (1–9–7)”, then press **[OK]**.



- 4 Press **[↑]/[↓]** to select Partial (VFO) Reset, PM Reset {page 43}, or Full Reset, then press **[OK]**.
  - A confirmation message appears.
  - Press **[ESC]** to quit resetting.
- 5 Press **[OK]**.

After switching the power OFF, you may press **[VFO]+ POWER ON** for Partial Reset, or **[MR]+ POWER ON** for Full Reset. This allows you to skip steps 1 to 4.

You can also use the RESET button to perform Full Reset. See page 12.

---

**Note:** When in All-control Lock or Channel Display mode, you cannot perform Partial Reset or Full Reset.

---

# PROGRAMMABLE MEMORY (PM)

Programmable Memory (PM) stores virtually all settings currently set on the transceiver. This transceiver provides 5 PM channels to store 5 sets of transceiver configurations. Later you can quickly recall one of these, depending on the operations you have in mind or the operating environment.

## PROGRAMMABLE INFORMATION

**8** The following settings can be separately stored for band A and B:

VFO frequency	VFO mode
Memory Recall mode	Call Channel mode
Offset direction	Offset frequency
Reverse ON	Automatic Simplex Check
Tone ON	Tone frequency
CTCSS ON	CTCSS frequency
DCS ON	DCS code
Upper frequency limit (for Programmable VFO)	Lower frequency limit (for Programmable VFO)
Frequency step size	FM/ AM mode

The following settings are shared by both band A and B:

TX band	Control band
Transmit output power	Auto Band Change
Display Dimmer	Many of the menu selections <sup>1</sup>

<sup>1</sup> The menu items listed below will not be stored:

- 1-4-1, Auto PM Channel Store
- 1-4-3, Memory Channel Lockout
- 1-4-4, Memory channel name
- 1-5-1, DTMF Number Store
- 1-7-6, Repeater function
- 1-9-7, Reset

## APPLICATION EXAMPLES

Following are examples of how you might use Programmable Memory. These examples may not represent applications useful to you, but you will understand the flexibility of this function.

### Situation 1

You share your transceiver with other members in your family or club. However, each individual has personal preferences for how they like to set various functions. You have to keep changing many settings each time you use the transceiver.

### Solution

Because 5 PM channels are available, up to 5 persons can separately program the transceiver and store their customized environment. Then each person can quickly change to their favorite settings, simply by recalling a PM channel. It is too much trouble to change back the settings after somebody else has reconfigured them. This application can avoid having a feature-rich transceiver but never using many useful features.

### Situation 2

While operating mobile on the way to work every morning, you prefer a silent transceiver that does not interrupt the morning calm. In addition, you feel that a bright display is a waste of power in sunlight. At night, when driving home, you realize the Beep function truly serves a purpose and you feel it is nice to see a bright display after dark.

### Solution

In 2 PM channels, store the same operating data such as frequency, offset, tone, etc., and store different settings for the Display Dimmer and Beep functions. Then you can quickly recall the best settings for day and night operation.

### Situation 3

You cannot figure out how to exit the current mode.

### Solution

Simply recall PM channel 1, which contains an exact copy of the transceiver default environment. You will not lose the contents of any memory channels.

## STORING IN PM CHANNELS

- 1 Confirm that the following conditions have been satisfied:
  - The transceiver is in reception mode.
  - Scan is not being used.
  - Microphone Control is OFF.
- 2 Configure the transceiver with your desired settings.
  - For the items that can be stored, see page 40.
- 3 Press **[F]**, **[P.IN]**.
  - The PM channel numbers 1 to 5 appear and blink at the bottom of the display.

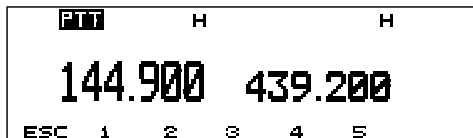

- 4 Press **[1]** to **[5]** corresponding to your desired PM channel.
  - The settings listed in page 40 are stored in the PM channel.

## RECALLING A PM CHANNEL

- 1 Press **[PM]**.
  - The PM channel numbers 1 to 5 appear at the bottom of the display.

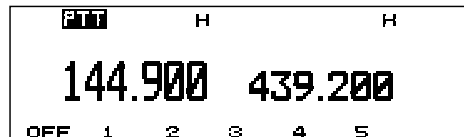

- 2 Press **[1]** to **[5]** corresponding to your desired PM channel.
  - The contents of the selected channel are recalled.
  - The current PM channel number appears at the upper right corner. "▶" before "PM" indicates that Auto PM Store mode {page 43} has been selected.
  - To exit PM Recall mode, press **[PM]**, **[OFF]**.

---

**Note:** You cannot recall a PM channel while transmitting.

---



## AUTO PM CHANNEL STORE

After you recall a PM channel, this function automatically overwrites the current PM channel with the present operating environment when:

- You recall another PM channel.
- You press **[OFF]**.
- You switch the transceiver OFF.

The factory default of this function is ON.

- 1 Press **[MNU]** to enter Menu mode.
- 2 Press **[↑]/[↓]** to select “MEMORY (1–4–)”, then press **[OK]**.
- 3 Press **[↑]/[↓]** to select “AUTO PM STORE (1–4–1)”, then press **[OK]**.

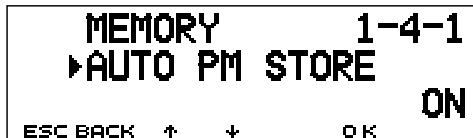

- 4 Press **[↑]/[↓]** to switch this function ON (default) or OFF.
- 5 Press **[OK]** to complete the setting.
- 6 Press **[MNU]** to exit Menu mode.

## PM CHANNEL RESET

To reprogram the PM channels from the beginning, reset all the PM channels to the factory defaults.

- 1 Press **[PM]+ POWER ON**.

- A confirmation message appears.



- Press **[ESC]** to exit without resetting.

- 2 Press **[OK]**.

You can also use Menu 1–9–7 (RESET) to reset the PM channels. See page 39.

# SCAN

Scan is a useful feature for hands-off monitoring of your favorite frequencies. Becoming comfortable with all types of Scan will increase your operating efficiency.

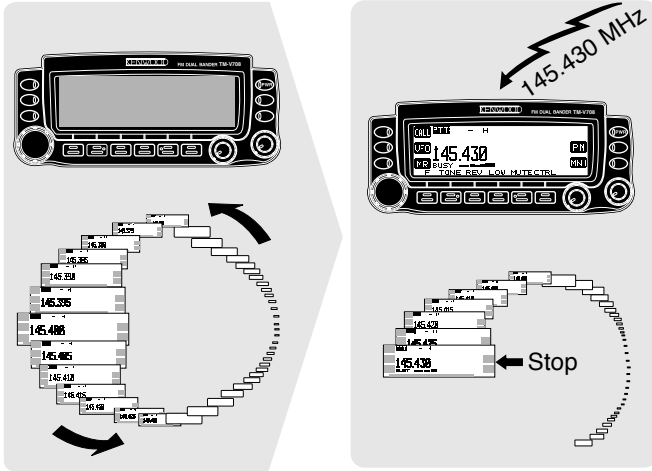

9

This transceiver provides the following scan types, plus Visual Scan {page 45}. Visual Scan graphically and simultaneously shows how frequencies in a specific range are busy.

Scan Type	Scan Range
VFO Scan	All frequencies tunable on the band
Memory Scan	Frequencies stored in the memory channels
Group Scan	Frequencies stored in the memory channels which belong to the specified group
Program Scan	All frequencies in the range selected on the band
MHz Scan	All frequencies within a 1 MHz range
Call/VFO Scan	Call channel plus the current VFO frequency
Call/Memory Scan	Call channel plus the selected memory channel

### Note:

- ◆ Adjust the squelch level before using Scan. Selecting a squelch level too low could cause Scan to stop immediately.
- ◆ While using CTCSS or DCS, Scan stops for any signal received; however, you will hear audio only when the signal contains the same CTCSS tone or DCS code that you selected.
- ◆ When using S-meter Squelch, Scan stops when the received signal strength matches or exceeds the S-meter setting. Scan resumes 2 seconds after the signal level drops below the S-meter setting.
- ◆ Pressing and holding Mic [PTT] causes Scan to temporarily stop if it is functioning on a non TX band.
- ◆ Starting Scan switches OFF the Automatic Simplex Check.

## VISUAL SCAN

While you are receiving, Visual Scan allows you to monitor frequencies near the current operating frequency. Visual Scan graphically and simultaneously shows how all frequencies in the selected range are busy. You will see up to 21 segments, for each channel, that represent 7 S-meter levels (3 segments per level).

Determine the scan range by selecting the center frequency and the number of channels. The default number of channels is 61.

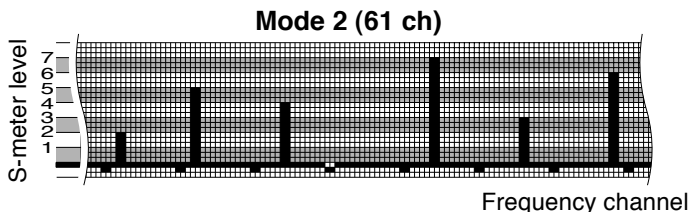
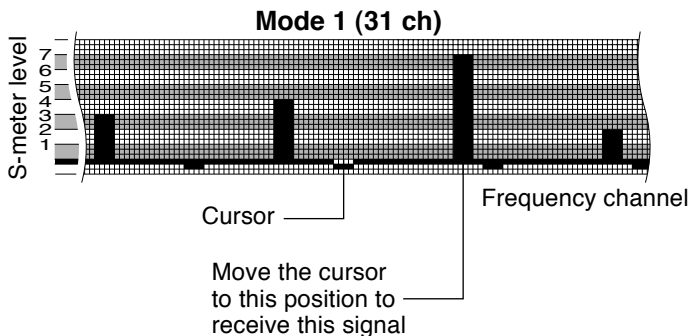

## ■ Selecting the Number of Channels

- 1 Press **[MNU]** to enter Menu mode.
- 2 Press **[↑]/[↓]** to select “AUX (1–9–)”, then press **[OK]**.
- 3 Press **[↑]/[↓]** to select “VISUAL SCAN (1–9–2)”, then press **[OK]**.



- 4 Press **[↑]/[↓]** to select 31, 61 (default), 91, or 181 channels.
- 5 Press **[OK]** to complete the setting.
- 6 Press **[MNU]** to exit Menu mode.

## ■ Using Visual Scan

- 1 Select your desired band.
- 2 Turn the **Tuning** control, or press Mic **[UP]/[DWN]**, to select the operating frequency.
  - This frequency will be used as the center frequency.
- 3 Press **[F]**, **[VISUAL]** to start Visual Scan.

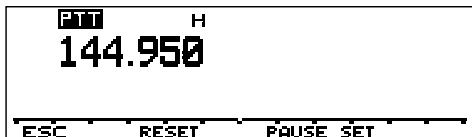

9

- To halt Scan, press **[PAUSE]**. “PAUSE” appears and blinks. Press **[PAUSE]** again to resume.
- 4 To change the operating frequency, turn the **Tuning** control or press Mic **[UP]/[DWN]**.
    - The displayed frequency changes and the cursor moves.
    - Press **[SET]** to use the changed operating frequency as the center frequency.
    - Press **[RESET]** to restore the previous operating frequency.
  - 5 To exit Visual Scan, press **[ESC]**.

---

### Note:

- ◆ If you start Visual Scan in Memory Recall mode, the memory channel frequencies will be scanned.
  - ◆ If you start Visual Scan after recalling the Call channel, the Call channel frequency will be used as the center frequency.
  - ◆ If the frequency range specified for Program Scan or Program VFO is narrower than the range specified for Visual Scan, the range for Program Scan or VFO will be used for Visual Scan.
  - ◆ Visual Scan stops while transmitting.
  - ◆ Starting Visual Scan switches Automatic Band Change OFF.
  - ◆ If you start Visual Scan in one of the following conditions, you cannot receive in the current operating frequency. To use this frequency, press **[PAUSE]** to halt Scan.
    - Memory Recall or Call Channel mode
    - A frequency in the 118, 220, or 1200 MHz band was selected in VFO mode.
  - ◆ Depending on the transceiver conditions, Visual Scan and the conventional S-meter may indicate different signal strength levels.
-

## SELECTING SCAN RESUME METHOD

The transceiver stops scanning at a frequency (or memory channel) on which a signal is detected. It then continues scanning according to which resume mode you select. You can choose one of the following modes. The default is Time-Operated mode.

- **Time-Operated mode**

The transceiver remains on a busy frequency (or memory channel) for approximately 5 seconds, then continues to scan even if the signal is still present.

- **Carrier-Operated mode**

The transceiver remains on a busy frequency (or memory channel) until the signal drops out. There is a 2 second delay between signal drop-out and scan resumption.

- **Seek mode**

The transceiver remains on a busy frequency (or memory channel) even after the signal drops out and does not automatically resume scanning.

---

**Note:** To temporarily stop scanning and monitor weak signals, press the Mic PF key assigned the Monitor function (page 60). Press the PF key again to resume scanning.

---

- 1 Press **[MNU]** to enter Menu mode.
- 2 Press **[↑]/[↓]** to select “AUX (1–9–)”, then press **[OK]**.
- 3 Press **[↑]/[↓]** to select “SCAN RESUME (1–9–1)”, then press **[OK]**.

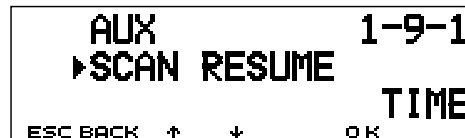

- 4 Press **[↑]/[↓]** to select Time-Operated (default), Carrier-Operated, or Seek.
- 5 Press **[OK]** to complete the setting.
- 6 Press **[MNU]** to exit Menu mode.

## VFO SCAN

VFO Scan monitors all frequencies tunable on the band, using the current frequency step size.

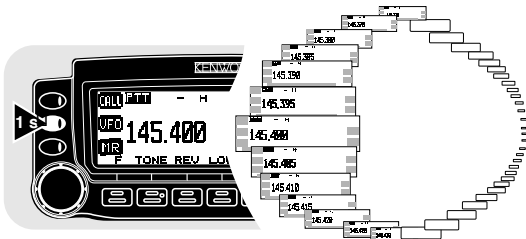

- 1 Select the desired band.
- 2 Press **[VFO]** (1 s).
  - Scan starts at the frequency currently displayed.
  - The 1 MHz decimal blinks while scanning is in progress.
  - To reverse the scan direction, turn the **Tuning** control clockwise (upward scan) or counterclockwise (downward scan). You can also press Mic **[UP]/ [DWN]**.
- 3 To exit VFO Scan, press **[VFO]** again.

## MEMORY SCAN

Use Memory Scan to monitor all memory channels programmed with frequency data.

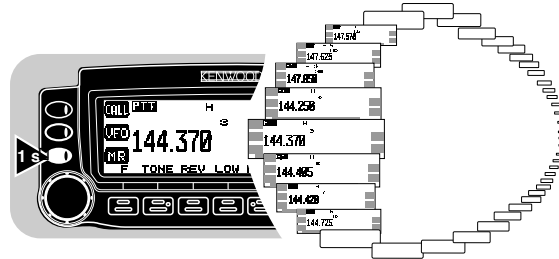

- 1 Select band A or B.
- 2 Press **[MR]** (1 s).
  - Scan starts with the channel last recalled.
  - The 1 MHz decimal blinks while scanning is in progress.
  - To reverse the scan direction, turn the **Tuning** control clockwise (upward scan) or counterclockwise (downward scan). You can also press Mic **[UP]/ [DWN]**.
- 3 To exit Memory Scan, press **[MR]** again.

---

### Note:

- ◆ At least 2 memory channels must contain data and must not be locked out in order for Scan to function.
  - ◆ The L0 to L9 and U0 to U9 memory channels are not scanned.
  - ◆ You can also start Memory Scan when in Channel Display mode. While Scan is being interrupted, the channel number blinks.
-

## ■ Locking Out a Memory Channel

Select the memory channels you prefer not to monitor while scanning.

- 1 Recall your desired memory channel.
- 2 Press **[MNU]** to enter Menu mode.
- 3 Press **[↑]/ [↓]** to select “MEMORY (1–4–)”, then press **[OK]**.
- 4 Press **[↑]/ [↓]** to select “LOCKOUT (1–4–3)”, then press **[OK]**.

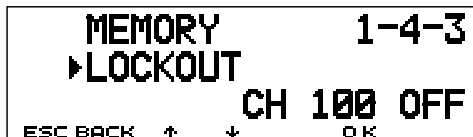

- 5 Press **[↑]/ [↓]** to switch Lockout ON (or OFF).
- 6 Press **[OK]** to complete the setting.
- 7 Press **[MNU]** to exit Menu mode.
  - A star appears beside a channel when it has been locked out.

---

**Note:** The L0 to L9 and U0 to U9 memory channels cannot be locked out.

---

## GROUP SCAN

For Group Scan, the 200 memory channels are divided into 10 groups, with each group containing 20 channels. Group Scan monitors only the 20 channels which belong to the specified group. The channels are grouped as follows:

1 ~ 20	101 ~ 120
21 ~ 40	121 ~ 140
41 ~ 60	141 ~ 160
61 ~ 80	161 ~ 180
81 ~ 100	181 ~ 200

- 1 Recall one of the memory channels in your desired group.
- 2 Press **[MHz]** (**Tuning control**) (1 s).
  - Scan starts with the channel last recalled.
  - The 1 MHz decimal blinks while scanning is in progress.
  - To reverse the scan direction, turn the **Tuning control** clockwise (upward scan) or counterclockwise (downward scan). You can also press Mic **[UP]/ [DWN]**.
- 3 To exit Group Scan, press **[MHz]** again.

---

**Note:**

- ◆ At least 2 memory channels in the specified group must contain data and must not be locked out in order for Scan to function.
  - ◆ You can also start Group Scan when in Channel Display mode. While Scan is being interrupted, the channel number blinks.
-

## PROGRAM SCAN

Program Scan is identical to VFO Scan except that you select the frequency range of the scan.

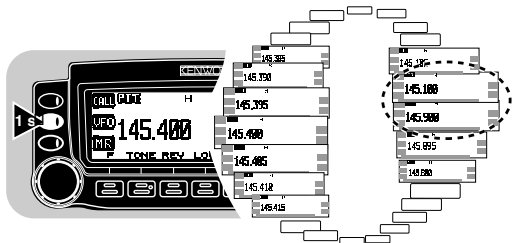

9

### ■ Setting Scan Limits

You can store up to 10 scan ranges in memory channels L0/U0 to L9/U9.

- 1 Select your desired band.
- 2 Press **[VFO]**.
- 3 Select your desired frequency for the lower limit.
- 4 Press **[F]**.
  - A memory channel number appears and blinks.
- 5 Turn the **Tuning** control, or press Mic **[UP]/[DWN]**, to select a channel (L0 ~ L9).



- 6 Press **[M.IN]**.
  - The lower limit is stored in the channel.
- 7 Select your desired frequency for the upper limit.
- 8 Press **[F]**.
- 9 Turn the **Tuning** control, or press Mic **[UP]/[DWN]**, to select a matching channel (U0 ~ U9).
  - For example, if you have selected L3 for the lower limit in step 5, select U3 for the upper limit.



- 10 Press **[M.IN]**.
  - The upper limit is stored in the channel.

To confirm the stored scan limits, press **[MR]**, then select the L and U channels.

#### Note:

- ◆ The lower limit must have a lower frequency than the upper limit.
- ◆ The lower and upper frequency step sizes must be the same.
- ◆ The lower and upper frequency limits must be selected on the same band.



## ■ Using Program Scan

- 1 Select the appropriate band.
- 2 Press **[VFO]** .
- 3 Select a frequency within the programmed scan limits, including the frequency limits.
- 4 Press **[VFO] (1 s)**.
  - Scan starts at the frequency currently displayed.
  - The 1 MHz decimal blinks while scanning is in progress.
  - To reverse the scan direction, turn the **Tuning** control clockwise (upward scan) or counterclockwise (downward scan). You can also press Mic **[UP]/ [DWN]**.
- 5 To exit Program Scan, press **[VFO]** again.

---

### Note:

- ◆ If the step size of the current VFO frequency differs from that of the programmed frequencies, VFO scan starts instead of Program Scan.
  - ◆ If the step size differs between the lower limit and the upper limit, VFO scan starts instead of Program Scan.
  - ◆ If the current VFO frequency is within more than one programmed scan range, the range stored in the smallest channel number is used.
- 

## MHz SCAN

MHz Scan monitors a 1 MHz segment of the band, using the current frequency step size. The current 1 MHz digit determines the limits of the scan. For example, if the current frequency is 145.400 MHz, then the scan range would be from 145.000 MHz to 145.995 MHz. The exact upper limit depends on the current frequency step size.

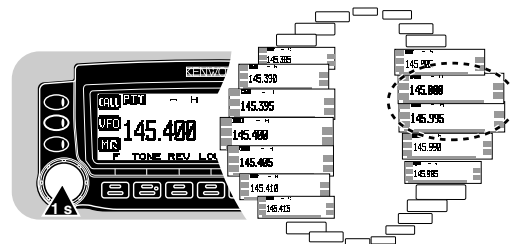

- 1 Select your desired band.
- 2 Press **[VFO]** to select VFO mode.
- 3 Select a frequency within your desired 1 MHz segment.
- 4 Press **[MHz] (Tuning control) (1 s)**.
  - Scan starts at the frequency currently displayed.
  - The 1 MHz decimal blinks while scanning is in progress.
  - To reverse the scan direction, turn the **Tuning** control clockwise (upward scan) or counterclockwise (downward scan). You can also press Mic **[UP]/ [DWN]**.
- 5 To exit MHz Scan, press **[MHz]** again.

## CALL/VFO SCAN

Use Call/VFO Scan to monitor both the Call channel and the current VFO frequency on the selected band.

- 1 Select your desired band.
- 2 Press **[VFO]**.
- 3 Select your desired frequency.
- 4 Press **[CALL] (1 s)** to start Call/VFO Scan.
  - The 1 MHz decimal blinks while scanning is in progress.
- 5 To exit Call/VFO Scan, press **[CALL]** again.

9

## CALL/MEMORY SCAN

Use Call/Memory Scan to monitor both the Call channel and your desired memory channel.

- 1 Recall your desired memory channel.
- 2 Press **[CALL] (1 s)** to start Call/Memory Scan.
  - The 1 MHz decimal blinks while scanning is in progress.
  - The Call channel on the same band as of the selected memory channel is used for Scan.
- 3 To exit Call/Memory Scan, press **[CALL]** again.

---

**Note:** The selected memory channel is scanned even if it has been locked out.

---

# CONTINUOUS TONE CODED SQUELCH SYSTEM (CTCSS)

You may sometimes want to hear calls only from specific persons. The Continuous Tone Coded Squelch System (CTCSS) allows you to ignore (not hear) unwanted calls from other persons who are using the same frequency. First select the same CTCSS tone as selected by the other persons in your group. A CTCSS tone is subaudible and is selectable from among 38 standard tone frequencies.

**Note:** CTCSS does not cause your conversation to be private. It only relieves you from listening to unwanted conversations.

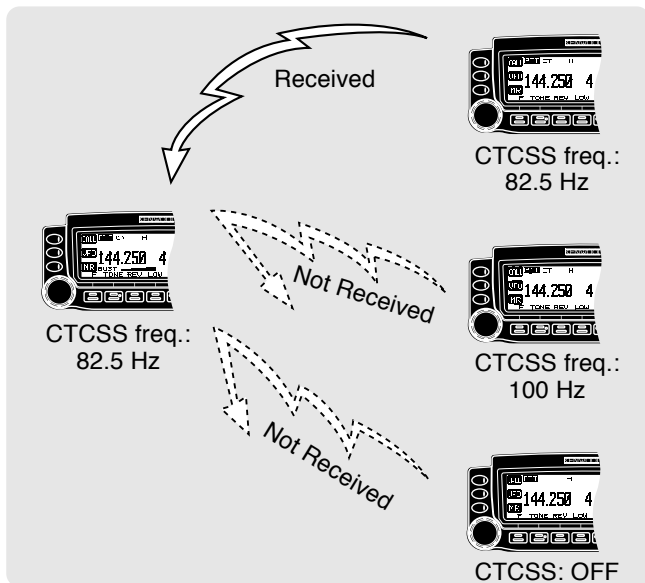

## USING CTCSS

- 1 Press the left or right [**BAND SEL**] to select band A or B.
  - If necessary, press [**F**], then the same [**BAND SEL**] to recall the sub-band.
- 2 Press [**TONE**] to activate the CTCSS function.
  - “CT” appears when the CTCSS function is ON.
  - Each press of [**TONE**] changes the selection as Tone → CTCSS → DCS → No selection.
- 3 Press [**F**], [**T.SEL**].
  - The current CTCSS frequency appears and blinks.

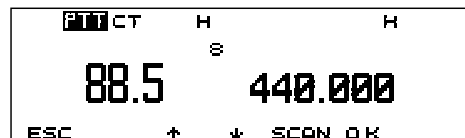

- 4 Press [**↑**]/ [**↓**] to select a CTCSS frequency.
  - The selectable frequencies are the same as for the tone frequency. Refer to the table in “Selecting a Tone Frequency” {page 28}.
- 5 Press [**OK**] to complete the setting.

You will hear calls only when the selected tone is received. To answer the call, press and hold Mic [**PTT**], then speak into the microphone.

Skip steps 3 to 5 if you have already programmed an appropriate CTCSS frequency.

10

When using a MC-58DM, you can also use its keypad to select a CTCSS frequency. First program one of the Mic PF keys as the ENTER key {page 59}. In step 3 (above), press [ENTER], then enter 01 to 38 to select the frequencies listed in the table on page 28. To select 79.7 Hz, for example, press [ENTER], [0], [5].

---

**Note:**

- ◆ You can select a separate tone frequency for the CTCSS and Tone functions.
  - ◆ You cannot use CTCSS with the Tone and DCS functions.
  - ◆ If you select a high tone frequency, receiving audio or noise that contains the same frequency portions may cause CTCSS to function incorrectly. To prevent noise from causing this problem, select an appropriate noise squelch level {page 20}.
- 

## 10 CTCSS FREQUENCY ID

This function scans through all CTCSS frequencies to identify the incoming CTCSS frequency on a received signal. You may find this useful when you cannot recall the CTCSS frequency that the other persons in your group are using.

- 1 Press [TONE] to switch the CTCSS function ON.
  - “CTCSS” appears when the CTCSS function is ON.
- 2 Press [F], [T.SEL].
  - The current CTCSS frequency appears and blinks.

- 3 Press [SCAN] to activate the CTCSS Frequency ID.

- “CT SCAN” appears and blinks.

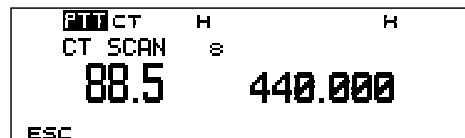

- Scan starts when signals are received.
- To reverse the scan direction, turn the **Tuning** control clockwise (upward scan) or counterclockwise (downward scan). You can also press Mic [UP]/ [DWN].
- To end this function, press [ESC].
- When the CTCSS frequency is identified, the identified frequency appears and blinks.

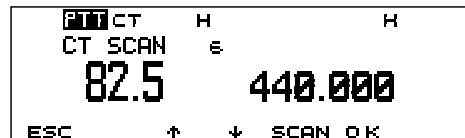

- 4 Press [OK] to program the identified frequency in place of the currently set CTCSS frequency.

- The CTCSS function will remain ON. You can press [TONE] to switch the CTCSS function OFF.
- Press [ESC] if you do not want to program the identified frequency.
- Press [SCAN] while the identified frequency is blinking, to resume scanning.

---

**Note:** Received signals are audible while scanning is in progress.

---

# DIGITAL CODE SQUELCH (DCS)

Digital Code Squelch (DCS) is another application which allows you to ignore (not hear) unwanted calls. It functions the same way as CTCSS. The only differences are the encode/ decode method and the number of selectable codes. For DCS, you can select from 104 different codes as listed in the table below.

023	065	132	205	255	331	413	465	612	731
025	071	134	212	261	332	423	466	624	732
026	072	143	223	263	343	431	503	627	734
031	073	145	225	265	346	432	506	631	743
032	074	152	226	266	351	445	516	632	754
036	114	155	243	271	356	446	523	654	
043	115	156	244	274	364	452	526	662	
047	116	162	245	306	365	454	532	664	
051	122	165	246	311	371	455	546	703	
053	125	172	251	315	411	462	565	712	
054	131	174	252	325	412	464	606	723	

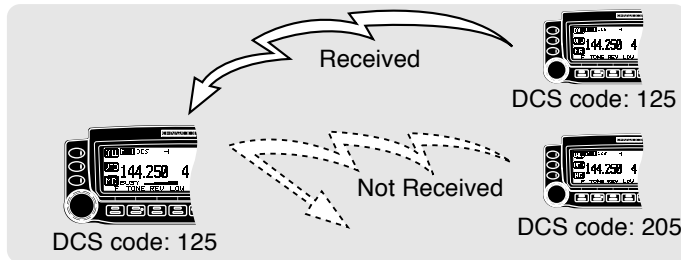

## USING DCS

- Press the left or right **[BAND SEL]** to select band A or B.
  - If necessary, press **[F]**, then the same **[BAND SEL]** to recall the sub-band.
- Press **[TONE]** to activate the DCS function.
  - “DCS” appears when the DCS function is ON.
  - Each press of **[TONE]** changes the selection as Tone → CTCSS → DCS → No selection.
- Press **[F]**, **[T.SEL]**.
  - The current DCS code appears and blinks.



- Press **[↑]**/**[↓]** to select a DCS code, then press **[OK]**.

You will hear calls only when the selected code is received. To answer the call, press and hold Mic **[PTT]**, then speak into the microphone.

**Note:** You cannot use DCS with the Tone and CTCSS functions.

11

## DCS CODE ID

This function scans through all DCS codes to identify the incoming DCS code on a received signal. You may find this useful when you cannot recall the DCS code that the other persons in your group are using.

- 1 Press **[TONE]** to switch the DCS function ON.
  - “DCS” appears when the DCS function is ON.
- 2 Press **[F]**, **[T.SEL]**.
  - The current DCS code appears and blinks.
- 3 Press **[SCAN]** to activate the DCS Code ID.
  - “DCS SCAN” appears and blinks.

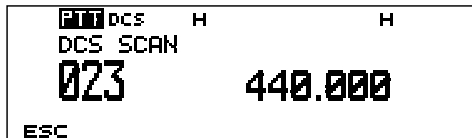

- Scan starts when signals are received.
- To reverse the scan direction, turn the **Tuning** control clockwise (upward scan) or counterclockwise (downward scan). You can also press Mic **[UP]/ [DWN]**.
- To end this function, press **[ESC]**.
- When the DCS code is identified, the identified code appears and blinks.

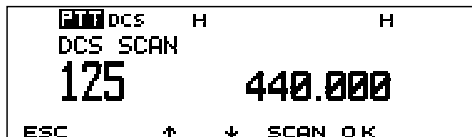

- 4 Press **[OK]** to program the identified code in place of the currently set code.
  - The DCS function will remain ON. You can press **[TONE]** to switch the DCS function OFF.
  - Press **[ESC]** if you do not want to program the identified code.
  - Press **[SCAN]** while the identified code is blinking, to resume scanning.

---

**Note:** Received signals are audible while scanning is in progress.

---

# DUAL TONE MULTI-FREQUENCY (DTMF) FUNCTIONS (WITH MC-58DM ONLY)

The keys on the Mic keypad function as DTMF keys; the 12 keys found on a push-button telephone plus 4 additional keys (A, B, C, D). This transceiver provides 10 dedicated memory channels. You can store a DTMF number (16 digits max) with a memory name (8 digits max) in each of the channels to recall later for a quick call.

Some repeaters in the U.S.A. offer a service called Autopatch. You can access the public telephone network via such a repeater by sending DTMF tones. For further information, consult your local repeater reference.

## MANUAL DIALING

Manual dialing requires only two steps to send DTMF tones.

- 1 Press and hold Mic [PTT].
- 2 Press the keys in sequence on the Mic keypad to send DTMF tones.
  - The corresponding DTMF tones are transmitted.

Freq. (Hz)	1209	1336	1477	1633
697	1	2	3	A
770	4	5	6	B
852	7	8	9	C
941		0		D

## ■ DTMF Monitor

When pressing the Mic DTMF keys, you will not hear DTMF tones from the speaker. You can make the speaker output the DTMF tones each time you press a DTMF key.

Access Menu 1-8-6 (DTMF MONITOR) and select "ON".



## AUTOMATIC DIALER

If you use the 10 dedicated memory channels to store DTMF numbers, you need not remember a long string of digits.

### ■ Storing a DTMF Number in Memory

**Note:** Audible DTMF tones from other transceivers near you (or from your own speaker) may be picked up by your microphone. If so, you may fail to correctly program a DTMF number.

- 1 Press **[MNU]** to enter Menu mode.
- 2 Select Menu 1–5–1 (STORE), then press **[OK]**.
- 3 Press **[↑]**/ **[↓]** to select a channel from 0 to 9, then press **[OK]**.
  - The display for entering a memory name appears and the first digit blinks.
  - To skip naming the channel, press **[OK]** again. You can jump to step 8.



- 4 Turn the **Tuning** control to select a character.
  - You can enter alphanumeric characters and special ASCII characters.
- 5 Press **[→]**.
  - The cursor moves to the next digit.
- 6 Repeat steps 4 and 5 to enter up to 8 digits.

<b>CHAR</b>	Switches among the sets of alphanumeric characters and special ASCII characters.		
<b>A/a</b>	Switches between small and capital letters.	<b>BACK</b>	Cancels Memory Name Entry.
<b>DEL</b>	Deletes the digit at the cursor position.	←	Moves the cursor backwards.
<b>INS</b>	Inserts the currently selected character.	<b>CLR</b> (left BAND SEL)	Clears all digits and returns the cursor to the first digit.

- 7 Press **[OK]**.
  - The cursor moves to the start of the next field.

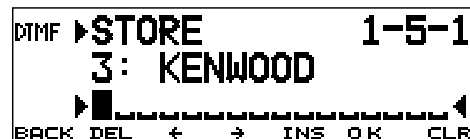

- 8 Press the keys in sequence on the Mic keypad to enter a DTMF number with up to 16 digits.
  - You may turn the **Tuning** control then **[→]** to select each digit. Select a space to include a pause.
- 9 Press **[OK]** to complete the selection.
- 10 Press **[MNU]** to exit Menu mode.

You can confirm the stored DTMF number by following steps 1 to 3.

The keypad on the MC-58DM can also be used to enter alphanumeric characters in step 4. Refer to page 18.



## ■ Transmitting a Stored DTMF Number

- 1 Press Mic [PTT]+ Mic [PF].

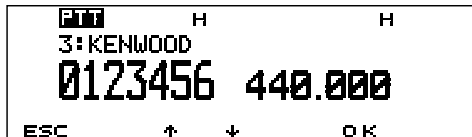

- 2 Release Mic [PF] while still holding Mic [PTT], and press Mic [UP]/ [DWN] to select the desired DTMF memory channel.

- 3 While still holding Mic [PTT], press [0] to [9] corresponding to the channel number.

- The number stored in the channel scrolls across the display accompanied by DTMF tones from the speaker.
- After transmission, the frequency display is restored.

## ■ Selecting TX Speed

Some repeaters may not respond correctly if a DTMF number is transmitted at a fast speed. If this happens, change the DTMF number transmission speed from Fast (default) to Slow.

In Menu mode, access Menu 1–5–2 (TX SPEED) and select “Slow”.



## ■ Selecting Pause Duration

You can also change the pause duration stored in the memory channels. The default is 500 milliseconds.

In Menu mode, access Menu 1–5–3 (PAUSE) and select from 100, 250, 500, 750, 1000, 1500, and 2000 ms.

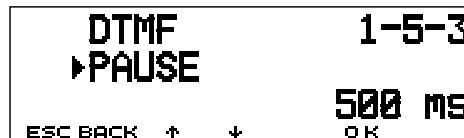

12

# PROGRAMMABLE FUNCTION (PF) KEYS

The Programmable Function keys, [PF], [MR], [VFO], and [CALL], are located on the front of the microphone. These keys have the following default functions:

[PF] (PF1)	Band Select
[MR] (PF2)	Memory Recall
[VFO] (PF3)	VFO Select
[CALL] (PF4)	Call Channel Select

If desired, you can change the defaults to the following key functions:

Key Function	Ref. Page	Key Function	Ref. Page	Key Function	Ref. Page
A/B	17	MHz	20	C. IN	37
MONITOR	19	TONE	28, 53, 55	LOCK	65
ENTER	28, 35, 54, 61	REV	31	T. SEL	28, 53, 55
VOICE	77	LOW	21	SHIFT	27
1750	30	MUTE	69	STEP	62
PM	42	CTRL	17	VISUAL	46
MENU	22	PM IN	42	DIM	63
VFO	15	A.B.C.	64	SUB-BAND SEL	17
MR	35	M▶V	38	PWR	19
CALL	37	M. IN	34	(PF1 only)	

- 1 Press [MNU] to enter Menu mode.
- 2 Press [↑]/[↓] to select “MIC (1–8–)”, then press [OK].
- 3 Press [↑]/[↓] to select “PF1 (1–8–1)” to “PF4 (1–8–4)”, then press [OK].



- 4 Press [↑]/[↓] to select your desired function.
- 5 Press [OK] to complete the setting.
- 6 Press [MNU] to exit Menu mode.

Alternatively, you can skip steps 1 to 3. With the transceiver power OFF, press and hold the programmable function key you want to program (PF1 ~ PF4) while turning the transceiver power ON. Continue from step 4 to program the key.

### Note:

- ◆ Without an optional VS-3 unit installed or with OFF selected in Menu 1–2–4 (VOICE), pressing the PF key programmed with Voice causes the transceiver to announce the current frequency using beeps of different frequencies.
- ◆ To restore the default functions, perform a Full Reset {page 39}.

# AUXILIARY FUNCTIONS

## DIRECT FREQUENCY ENTRY (WITH MC-58DM ONLY)

If the desired operating frequency is far from the current frequency, using the Mic keypad is the quickest way to change the frequency. First program one of the Mic PF keys as the ENTER key {page 60}.

- 1 Press the left or right **[BAND SEL]** to select band A or B.
  - If necessary, press **[F]**, then the same **[BAND SEL]** to recall the sub-band.
- 2 Press **[VFO]**.
- 3 Press Mic **[ENTER]**.
  - The display for Direct Frequency Entry appears.

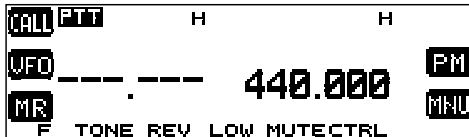

- 4 Press the numeric keys in sequence on the keypad.

### Note:

- ◆ The 1 kHz and subsequent digits are corrected according to which key is pressed for the 1 kHz digit.
- ◆ Entering a digit that is outside the allowable range causes the nearest digit within range to be displayed.
- ◆ You cannot enter a frequency in a band which cannot be recalled on the current band.

If you press Mic **[VFO]** while entering a frequency, the new data is accepted for the entered digits and the previous data remains unchanged for the digits that are not yet entered.

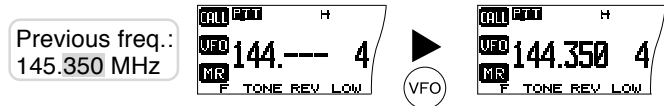

**Note:** The 1 kHz and subsequent digits may be corrected depending on combinations of the previous frequency and the current frequency step size.

If you press Mic **[ENTER]** while entering a frequency, the new data is accepted for the entered digits and 0 is programmed for the digits that are not yet entered.

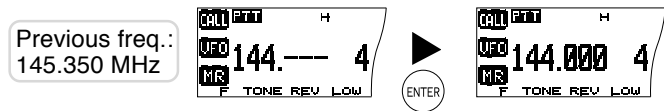

## CHANGING FREQUENCY STEP SIZE

Choosing the correct step size is essential in order to select your exact frequency using the **Tuning** control or Mic **[UP]/ [DWN]**. The default step size is 5 kHz on the 144 MHz band and 25 kHz on the 440 MHz band.

The default on the 118, 220, or 300 MHz band is 12.5 kHz and the default on the 1.2 GHz band is 25 kHz.

- 1 Press the left or right **[BAND SEL]** to select band A or B.
  - If necessary, press **[F]**, then the same **[BAND SEL]** to recall the sub-band.
- 2 Press **[VFO]**.
- 3 Press **[F]**, **[STEP]**.
  - The current step size appears and blinks.



- 4 Press **[↑]/ [↓]** to select your desired step size.
  - The selectable step sizes are 5, 6.25, 10, 12.5, 15, 20, 25, 30, 50, and 100 kHz.
- 5 Press **[OK]** to complete the setting.

---

**Note:** Changing between step sizes may correct the displayed frequency. For example, if 144.995 MHz is displayed with a 5 kHz step size selected, changing to a 12.5 kHz step size corrects the displayed frequency to 144.9875 MHz.

---

## PROGRAMMABLE VFO

If you always check frequencies within a certain range, set upper and lower limits for frequencies that are selectable using the **Tuning** control or Mic **[UP]/ [DWN]**. For example, if you select 145 MHz for the lower limit and 146 MHz for the upper limit, the tunable range will be from 145.000 MHz to 146.995 MHz.

- 1 Press the left or right **[BAND SEL]** to select band A or B, then press **[VFO]**.
  - If necessary, press **[F]**, then the same **[BAND SEL]** to recall the sub-band.
- 2 Press **[MNU]**, select Menu 1–3–1 (PROGRAMMABLE VFO), then press **[OK]**.
  - The current lower frequency limit blinks.



- 3 Press **[↑]/ [↓]** to select your desired lower frequency limit, then press **[OK]**.
  - The current upper frequency limit blinks.
- 4 Press **[↑]/ [↓]** to select your desired upper frequency limit, then press **[OK]**.
- 5 Press **[MNU]** to exit Menu mode.

---

**Note:**

- ◆ You cannot program the 100 kHz and subsequent digits.
  - ◆ The exact 100 kHz and subsequent digits of the upper limit depends on the frequency step size selected.
-

## DISPLAY DIMMER

You can manually change the display illumination to suit the lighting conditions where you are operating.

- 1 Press **[F]**, **[DIM]**.
  - The current illumination level appears and blinks. The default is level 1.

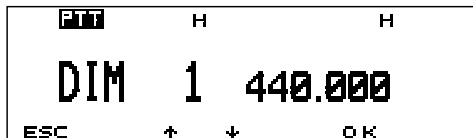

- 2 Press **[↑]**/**[↓]** to select from 5 levels, including OFF.
- 3 Press **[OK]** to complete the setting.

---

**Note:** Selecting OFF automatically switches Auto Dimmer Change ON.

---

## AUTO DIMMER CHANGE

This function increases the display intensity one step brighter for approximately 5 seconds when you press a front panel key or Mic key, or turn the **Tuning** control. No change occurs if you have selected the brightest level. Access Menu 1–1–4 (AUTO DIMMER) and select "ON".



## DISPLAY CONTRAST ADJUST

The display visibility changes depending on the ambient conditions, for example between daytime and night. When you find the display is not clear, use this function to select the optimum display contrast.

Access Menu 1–1–2 (CONTRAST) and select from levels 1 to 16. The default is level 8.



---

**Note:** The display contrast may be affected by a change in temperature. Adjust the contrast as necessary.

---

## POSITIVE/ NEGATIVE REVERSAL

You can change the display status between Negative and Positive (default) using Menu 1–1–3 (REVERSE MODE).



14

## BLANKING A BAND DISPLAY

If you have no plans to use one of band A or B, end the frequency display on the unused band. This saves power consumption and makes it simpler to read the information presented.

Press the left **[BAND SEL]** (1 s) to blank band B, or the right **[BAND SEL]** (1 s) to blank band A.



To restore Dual-band mode, press the same **[BAND SEL]** (1 s).

---

**Note:** You cannot operate the blanked band nor use this band to receive or transmit.

---

## AUTOMATIC BAND CHANGE (ABC)

ABC will temporarily switch the RX only band to the TX band immediately after a signal is received on the RX only band. This function allows you to reply to a caller without manually selecting the correct band.

Press **[F]**, **[A.B.C.]** to switch the function ON (or OFF).

- “A.B.C.” appears when this function is ON.



- Pressing **[BAND SEL]** or Mic **[PTT]** cancels ABC.
- The original TX band is restored 2 seconds after the signal drops out.

---

### Note:

- ◆ You cannot use ABC when in Single-band mode. After activating ABC, changing from Dual-band mode to Single-band mode switches the ABC OFF.
  - ◆ After activating ABC, starting Visual Scan deactivates ABC. Canceling Visual Scan reactivates ABC.
-

## TRANSCEIVER LOCK

Transceiver Lock is suitable for a typical mobile installation where you alter most functions with your microphone. This Lock disables all functions excluding the following:

<b>PWR</b> switch	<b>[F]</b>	<b>[F], [MHz]</b>
<b>SQL</b> controls	<b>VOL</b> controls	Mic keys

Press **[F]**, **[MHz]** to switch this function ON (or OFF).

- “LOCK” appears when this function is ON.

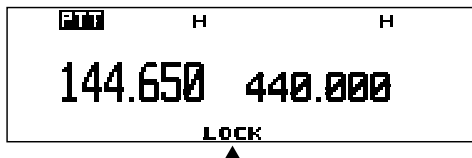

## ALL-CONTROL LOCK

All-control Lock is ideal when you have no plans to transmit but you want to monitor a specific frequency. This Lock disables all functions excluding power ON/OFF and All-control Lock ON/OFF.

After switching Transceiver Lock ON, switch the transceiver OFF, then press **[MHz]+ POWER ON** to switch this function ON (or OFF).

- “ALL LOCK” appears when this function is ON.



## S-METER SQUELCH

S-meter Squelch causes the squelch to open only when a signal with the same or greater strength than the S-meter setting is received. This function relieves you from constantly resetting the squelch when receiving weak stations in which you have no interest.

- 1 Select your desired band.
- 2 Press **[MNU]** to enter Menu mode.
- 3 Select Menu 1–3–2 (S-METER SQUELCH), then press **[OK]**.



- 4 Press **[↑]/[↓]** to switch this function ON (or OFF).
- 5 Press **[OK]** to complete the setting.
- 6 Press **[MNU]** to exit Menu mode.
  - The S-meter setting segments appear.



- 7 To select the desired S-meter setting, turn the left (band A) or right (band B) **SQL** control.

## ■ Squelch Hang Time

When using S-meter Squelch, you may want to adjust the time interval between when the received signals drop and when the squelch closes.

Access Menu 1-3-3 (SQUELCH HANG TIME) and select from OFF (default), 125, 250, and 500 ms.

```
TX/RX          1-3-3
▶SQUELCH HANG TIME
OFF
ESC BACK  ↑  ↓      OK
```

## CHANGING BEEP VOLUME

The transceiver beeps each time you press a front panel key or Mic key. You can change the beep volume or turn it off.

Access Menu 1-2-1 (BEEP VOLUME) and select the volume from levels 1 to 7 and OFF. The default is level 5.

```
AUDIO          1-2-1
▶BEEP VOLUME
LEVEL 5
ESC BACK  ↑  ↓      OK
```

## KEY BEEP ON/ OFF

If you are distracted by beeps generated when pressing a front panel key or Mic key, switch the Key Beep OFF.

Access Menu 1-2-2 (KEY BEEP) and select "OFF".

```
AUDIO          1-2-2
▶KEY BEEP
ON
ESC BACK  ↑  ↓      OK
```

---

**Note:** After selecting OFF, you will still hear TOT and APO alarms.

---

## SWITCHING FM/AM MODE

This transceiver is also capable of receiving (not transmitting) AM signals on band A. The default mode on the 118 MHz band is AM while the default on the 144, 220, 300, or 440 MHz band is FM. After recalling the desired band on band A, access Menu 1-3-4 (FM/AM MODE) and switch between FM and AM.

```
TX/RX          1-3-4
▶FM/AM MODE
AM
ESC BACK  ↑  ↓      OK
```

- The 1 MHz decimal becomes elongated when AM is selected.

---

**Note:** You cannot switch between FM and AM to receive on band B.

---



## ADVANCED INTERCEPT POINT (AIP)

The VHF band is often crowded in urban areas. AIP helps eliminate interference and reduce audio distortion caused by intermodulation. You can use this function when operating on the VHF band. Access Menu 1-3-5 (VHF AIP) and select "ON".



### Note:

- ◆ This transceiver does not allow you to use the AIP on the UHF band.
- ◆ Switching the AIP ON also affects the VHF sub-band on band B.

## Intermodulation and Sensitivity Adjustments

This feature will help reduce RF interference due to high intermodulation in your area. If you experience intermodulation interference, turn the AIP feature ON.

The TM-V708A design has good sensitivity performance capability. If you do not experience interference in your area, it is suggested to turn OFF the AIP for better signal reception.

## TIME-OUT TIMER (TOT)

It is sometimes necessary or desirable to restrict a single transmission to a time limit. You may use this function to prevent repeater time-outs when accessing repeaters, or to conserve battery power.

When timer expires, warning tones sound and the transceiver returns to reception mode. To resume transmitting, release and then press Mic [PTT] again.

Access Menu 1-9-4 (TOT) and select 3, 5, or 10 (default) minutes.

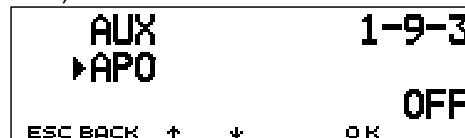

## AUTOMATIC POWER OFF (APO)

Automatic Power Off is a background function that monitors whether or not any keys have been pressed or the **Tuning** control has been turned. After 3 hours pass with no operations, APO turns the power OFF. However, 1 minute before the power turns OFF, "APO" appears and blinks, and a series of warning tones sound.

Access Menu 1-9-3 (APO) and select "ON".

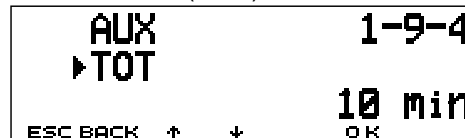

**Note:** If any settings are changed during the 3 hour period while APO is ON, the timer resets. When you stop changing the settings, the timer begins counting again from 0.

## POWER-ON MESSAGE

Each time you switch the transceiver ON, "HELLO !!!" appears for approximately 2 seconds. You can program your favorite message in place of the factory default.

- 1 Press **[MNU]** to enter Menu mode.
- 2 Select Menu 1-1-1 (POWER-ON MSG), then press **[OK]**.
  - The display for entering a message appears and the first digit blinks.



- 3 Turn the **Tuning** control to select a character.
  - You can enter alphanumeric characters and special ASCII characters.
- 4 Press **[→]**.
  - The cursor moves to the next digit.
- 5 Repeat steps 3 and 4 to enter up to 8 digits.

<b>CHAR</b>	Switches between alphanumeric characters and special ASCII characters		
<b>A/S</b>	Switches between small and capital letters	<b>BACK</b>	Cancels Memory Name Entry
<b>DEL</b>	Deletes the digit or the cursor position	<b>+</b>	Moves the cursor backwards
<b>INS</b>	Inserts the digit or selected character	<b>CLR</b> (EMERGENCY BAND SEC)	Cancels all programmed transmit frequencies

- 6 Press **[OK]** to complete the setting.
- 7 Press **[MNU]** to exit Menu mode.

The keypad on the MC-58DM can also be used to enter alphanumeric characters in step 3. Refer to page 18.

## DISPLAY DEMONSTRATION

By initiating this function, various preprogrammed displays appear. You still continue to use the transceiver normally, in this mode. Pressing a front panel key or Mic key, or turning the **Tuning** control restores the operating display immediately. If there is no key entry or **Tuning** control adjustment for approximately 10 seconds, the transceiver reverts back to Demonstration mode.

Press **[F]+ POWER ON** to switch this function ON (or OFF).

## CHANGING SPEAKER CONFIGURATIONS

This transceiver has two speaker jacks. You can enjoy a variety of speaker configurations by using one or two external speakers.

Access Menu 1–2–3 (SPEAKER) and select mode 1 (default) or 2, depending on how you want the internal and/or external speakers to function.



Connection	Mode	Band A	Band B
Only SP1 jack is connected to an external speaker	Mode 1	External	External
	Mode 2	External	External
Only SP2 jack is connected to an external speaker	Mode 1	External	Internal
	Mode 2	Internal	External
Both SP1 and SP2 jacks are connected to external speakers	Mode 1	External 2	External 1
	Mode 2	External 1	External 2

## SPEAKER MUTE

While receiving or transmitting on the TX band, you may not want to hear audio received on the other band. Use this function to mute the speaker allocated to that band (not the TX band).

Press **[MUTE]** to switch this function ON (or OFF).

- “MUTE” appears when this function is ON.

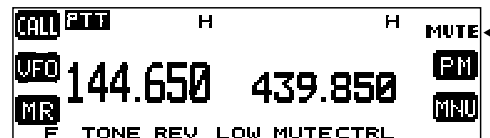

## PACKET OPERATION

A packet is a unit of data transmitted as a whole from one computer to another, on a network. Packets can be transmitted on radio waves as well as on communication lines. Besides a transceiver and a computer, all you need is a terminal node controller (TNC). A TNC converts packets to audio tones and vice versa, as one of its tasks.

A variety of packet applications developed by hams include packet bulletin board systems (PBBSs). PBBSs are created and maintained by volunteers called System Operators (SysOp). You may access one of your local PBBSs to send e-mail, download files, or obtain various useful information. Thousands of PBBSs, which have formed a worldwide network, relay e-mail to its intended destination around the world.

PBBS

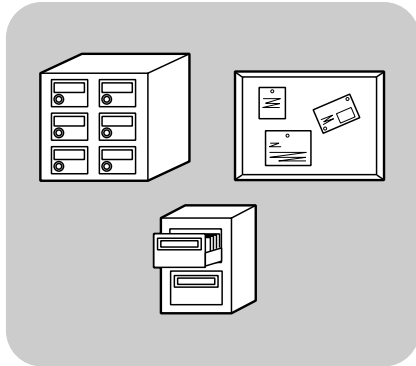

When you access a local PBBS for the first time, you often need to register as a new user. After you are successfully registered, it will then be available as your home PBBS. E-mail addressed to you will be held under a directory, called a mailbox, on your home PBBS.

To send e-mail, you must designate the address of a recipient, using their call sign and the call sign of their home PBBS; ex. KD6NUH@KJ6HC. In this example, e-mail is addressed to KD6NUH whose home PBBS is KJ6HC. If your home PBBS cannot find KJ6HC in its address file to forward your mail, you must designate the address in more detail. You may enter "KD6NUH@KJ6HC.#ABC.CA", or "KD6NUH@KJ6HC.#ABC.CA.USA", or up to "KD6NUH@KJ6HC.#ABC.CA.USA.NA", as necessary. The complete address of a recipient living in the U.S., for example, should include an appropriate region code (preceded by a #), state, country, and continent abbreviations as above.

For further information, consult reference books which should be available at any store that handles Amateur Radio equipment. Web pages relating to Packet will also be helpful. On Internet search engines, use "Packet Radio" as a key word to find those web pages.

---

**Note:** If there is an amateur radio club in your area, consider becoming a member. You can learn more in an hour from experienced hobbyists, than in a month of independent research. Ask on the local repeaters, or contact your national amateur radio organization for information on local amateur radio clubs.

---

## CONNECTING WITH A TNC AND PERSONAL COMPUTER

### Note:

- ◆ Turn the transceiver power OFF before making any connections.
- ◆ Do not share a single power supply between the transceiver and the TNC.
- ◆ Keep as wide a separation as possible between the transceiver and the computer, to reduce noise-pickup by the transceiver.

To connect an external TNC to the transceiver, use an optional PG-5A cable. The DATA connector on the front of the main unit mates with the 6-pin mini DIN plug on this cable.

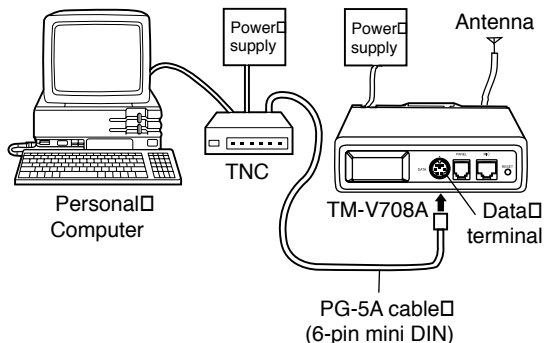
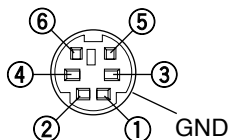

Pin No.	Pin Name	Function
1	PKD	Packet data input • TX data from TNC to transceiver.
2	DE	Ground for PKD
3	PKS	Packet standby • TNC can use this pin to inhibit the transceiver microphone input while transmitting packet signals.
4	PR9	Output of detected 9600 bps data (500 mV <sub>P-P</sub> , 10 kΩ) • Also functions as a common pin for 1200 bps and 9600 bps data output.
5	PR1	Output of detected 1200 bps data (500 mV <sub>P-P</sub> , 10 kΩ)
6	SQC	Squelch control output • Inhibits TNC data transmitting while transceiver squelch is open. • Prevents interference to voice communications on the same frequency. Also prevents retries. • Output Level Open squelch: +5 V (High) Closed squelch: 0 V (Low)

### Note:

- ◆ If the external TNC has a common pin for 1200 bps and 9600 bps data input, connect this pin to the DATA connector PR9 pin. Shorting the PR9 and PR1 pins will cause the TNC to malfunction.
- ◆ If DC voltage is input to the PR1 pin, the external TNC may not function. If this problem happens, add a 10 μF capacitor between the PR1 pin and the TNC. Be careful with the polarity of the capacitor.

## SELECTING A DATA TRANSFER RATE

The default data transfer rate is 1200 bps. If your network uses a 9600 bps transfer rate, you can change the default setting.

- 1 Press **[MNU]** to enter Menu mode.
- 2 Press **[↑]/[↓]** to select “TNC (1–9–)”, then press **[OK]**.
- 3 Press **[↑]/[↓]** to select “DATA SPEED (1–9–6)”, then press **[OK]**.



- 4 Press **[↑]/[↓]** to select 9600 or 1200 bps.
- 5 Press **[OK]** to complete the setting.
- 6 Press **[MNU]** to exit Menu mode.

---

### Note:

- 15**
- ◆ Transmit data input sensitivity is 40 mV<sub>p-p</sub> for 1200 bps baud rate and 2V<sub>p-p</sub> for 9600 bps baud rate. Input impedance for both baud rates is 10 kΩ. Using a modulator input level that is different than these optimum specifications may result in deterioration of S/N ratio or signal distortion, which could result in increased errors or a complete failure to connect with other stations.
  - ◆ The TX delay parameter on your TNC (for example, 300 ms) should be set using your computer.
  - ◆ Packet operation, easily affected by transmit and receive conditions, requires a full-scale S-meter reading for reliable communication.
-

# MICROPHONE CONTROL (WITH MC-58DM ONLY)

You can change numerous transceiver settings by operating the Mic DTMF keys.

To activate this function, access Menu 1–8–5 (MIC CONTROL) and select “ON”.



The following table shows which functions are switched ON/OFF or which settings are changed, by pressing the DTMF keys.

1	Visual Scan	9	Squelch Adjustment <sup>2,3</sup>
2	Tone/ CTCSS/ DCS	0	TX Power Change
3	Reverse	A	Enter
4	1 MHz Step Change	B	Control Band Select
5	Monitor	C	Repeater
6	Frequency Readout by Beeps <sup>1</sup>	D	[F] key
7	Volume Change <sup>2,3</sup>	*	Down <sup>4</sup>
8	Speaker Mute	#	Up <sup>4</sup>

<sup>1</sup> The transceiver announces the displayed information if you have installed an optional VS-3 unit and selected “English” in Menu 1–2–4 (VOICE) {page 77}.

<sup>2</sup> After entering the selection mode, press [\*] or [#] to change the level or selection.

<sup>3</sup> Volume Change and Squelch Adjustment cannot both be activated at the same time.

<sup>4</sup> Volume Change and Squelch Adjustment must both be OFF to change the tone or frequency step using this key.

You can also make the following settings by pressing [D] first (ex. [D], then [2]).

2	Tone or CTCSS Frequency/ DCS Code Select <sup>1</sup>	7	Band A/ B Select
		8	Sub-band Select
3	Offset Direction Select	D	Multi-function Mode Cancel
5	DTMF Keypad Lock	*	Down
6	DTMF Keypad Unlock	#	Up

<sup>1</sup> After entering the selection mode, press [\*] or [#] to change the level or selection.

Before pressing [D], [2], press [2] to activate the Tone, CTCSS, or DCS function.

Press [OK] on the front panel of the transceiver to complete the setting.

**Note:** Audible DTMF tones from other transceivers near you may be picked up by your MC-58DM microphone. If so, this could prevent the microphone control from working correctly.

# WIRELESS REMOTE CONTROL

If you also have a compatible **KENWOOD** handy transceiver, you may use it as a remote control for this mobile transceiver. You will control one band on the mobile while sending DTMF tones to the other band from the handheld. This function will be useful, for example, when you want to control the mobile from a location outside your vehicle.

## Note:

- ◆ As a remote control, you can also use a handy transceiver which does not have a remote control function but a DTMF function. You, however, must manually send DTMF tones for control code strings. Skip steps 1 and 3 in "PREPARATION".
- ◆ The FCC rules permit you to send control codes only on the 440 MHz band.

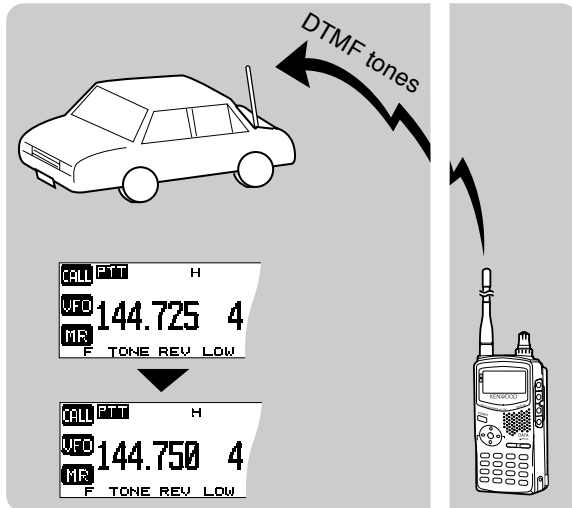

## PREPARATION

Let us assume band A (VHF) of the mobile transceiver will be controlled.

On the handy transceiver:

- 1 Program a 3-digit secret number.
  - For the programming method, see the instruction manual for the handheld.
  - If using a TH-D7A, see "WIRELESS REMOTE CONTROL" on its instruction manual.
- 2 Select the transmit frequency on the UHF band.
- 3 Make the handheld enter Remote Control mode.
  - For the method, see the instruction manual for the handheld. If not described, consult your dealer.

On the mobile transceiver:

- 4 Access Menu 1-A-1 (CODE), and select the same secret number as you selected in step 1.



- Turn the **Tuning** control to select each digit. Press [**→**] (or [**←**]) to move the cursor to the next (or previous) digit.
- You can also press Mic [**0**] to [**9**] in sequence to enter 3 digits.



- 5 Select the receive frequency on band B (UHF).
  - Mate this frequency with the transmit frequency on the handheld.
- 6 Select band A (VHF) as the TX band or Control band {page 17}.
- 7 To cause the mobile to send a control acknowledgment to the handheld, access Menu 1-A-2 (ANSWER BACK) and select "ON".

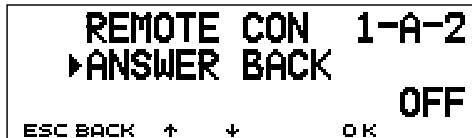

- DTMF tones which represent the secret number will be used as an acknowledgment.
- 8 Access Menu 1-A-3 (CONTROL) and select "ON".
    - "REMOTE CON" and "LOCK" appear when the mobile enters Remote Control mode.

## CONTROL OPERATION

When in Remote Control mode, the DTMF keys of the handheld will function as shown in the table. Each time you press the desired key, the handheld will automatically enter transmit mode and send the corresponding command to the mobile.

**Note:** If using a handheld without a remote control function, manually send "AXXX#YA#" where "XXX" is a 3-digit secret number and "Y" is a single-digit control command. If you do not add "A#" to the end, you can skip sending "AXXX#" next time; however, the mobile may be accidentally controlled by other stations.

1	REV ON	9	MR
2	TONE ON	0	LOW
3	CTCSS ON	A	ENTER
4	REV OFF	B	TONE SEL
5	TONE OFF	C	REPEATER ON
6	CTCSS OFF	D	REPEATER OFF
7	CALL	*	DOWN
8	VFO	#	UP

To change the transmit/ receive frequency:

([VFO] → [ENTER] → [0] ~ [9] (enter the necessary digits) → [ENTER]) or ([VFO] → [UP]/ [DOWN])

To recall a memory channel:

([MR] → [ENTER] → [0] ~ [9] (enter the necessary digits) → [ENTER]) or ([MR] → [UP]/ [DOWN])

To change the tone (or CTCSS) frequency:

([TONE SEL] → [0] ~ [9] (enter 2 digits; ex. [0], [5]) → [TONE SEL])

- Use Nos. 01 to 38 shown in the table in page 28.
- First activate the Tone or CTCSS function. You can select a separate tone frequency for the Tone and CTCSS functions.

**Note:** When in Remote Control mode, you can perform only the following operations on the mobile transceiver.

- Transmit
- Answer Back ON/ OFF
- Secret Number Change
- Partial/ Full Reset (with RESET button)

# REPEATER FUNCTION

This transceiver is capable of receiving signals on one band and retransmitting signals on the other band. This function repeats signals originating from one band, using the other band. For example, a signal received on band A (VHF) is retransmitted on band B (UHF). Similarly, a signal received on band B (UHF) is retransmitted on band A (VHF).

Access Menu 1-7-6 (REPEATER) and select Locked-band Repeater or Cross-band Repeater. The default is "OFF".



- "PTT" blinks when in the Locked-band or Cross-band Repeater mode.

## Locked-band Repeater

The transceiver always uses the same band to receive or transmit a signal as a repeater. Before accessing Menu 1-7-6, select one band as the TX band and the other band as the control band.

18

## Cross-band Repeater

If receiving a signal on the TX band, the transceiver switches the current RX only band to the TX band. Before accessing Menu 1-7-6, select the same band as the TX and control bands.

If necessary, you can cause this transceiver to remain in the transmit mode for 500 ms after signals drop. Access Menu 1-7-5 (REPEATER HOLD) and select "ON".

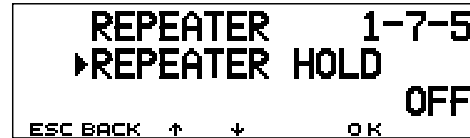

### Note:

- ◆ You cannot activate the Repeater function after recalling the same frequency band (VHF or UHF) on band A and B, or while blanking a band display.
- ◆ Activating the Repeater function switches OFF Automatic Band Change (A.B.C.) or Automatic Simplex Check (ASC).
- ◆ The Time-Out Timer is locked at 3 minutes.
- ◆ After activating the Repeater function, you cannot access Menu Nos. other than 1-7-5 and 1-7-6.

## VS-3 VOICE SYNTHESIZER (OPTIONAL)

Install the optional VS-3 unit to use this function {page 79}. Each time you change the transceiver mode, such as VFO or Memory Recall, the transceiver automatically announces the new mode.

To use the installed VS-3 unit, access Menu 1–2–4 (VOICE) and select “English”. The default is OFF.

The table below shows what the transceiver automatically announces when it enters a new mode.

Key Pressed	New Mode	Announcement
[VFO]	VFO	“VFO”
[MR]	Memory Recall	“MR”
[CALL]	Call Channel	“Call”
[PM]	Programmable Memory	“PM”
[MNU]	Menu	“Menu” and current menu number
[BAND SEL]	New TX/ Control band	“A” or “B”, current frequency, and current TX power <sup>1</sup>
Mic PF key programmed with Enter {page 60} <sup>2</sup>	Keypad Direct Entry	“Enter” (and numbers as they are entered)

<sup>1</sup> When pressed in Memory Recall mode, the transceiver announces “A” or “B”, the channel number, “channel”, the frequency, and the TX power. When in Call Channel mode, the transceiver announces “A” or “B”, “call”, the frequency, and the TX power.

<sup>2</sup> When pressed in VFO or Memory Recall mode.

You can also press Mic [6] in Microphone Control mode {page 73} or the PF key programmed with Voice {page 60}. The transceiver announces the displayed information as follows, depending on the current mode.

VFO	VFO frequency on the current band beginning with the 100 MHz digit. (MHz decimal point: “point”)
Memory Recall	Channel number, “channel”, and the frequency. For the L or U channels, “low” or “up”, the channel number, and the frequency.
Channel Display	Channel number and “channel”. For the L or U channels, “low” or “up” and the channel number.
Call Channel Recall	“Call” and the frequency.
Menu	Menu number (with Voice key only).
Tone frequency, CTCSS frequency, DCS code select	Current Tone frequency, CTCSS frequency, or DCS code.

To change the volume of voice output, access Menu 1–2–5 (VOICE VOLUME) and select from levels 1 to 7. The default is level 5.

**Note:** While using Transceiver Lock, the transceiver makes an announcement only when pressing Mic [6] in Microphone Control mode or the PF key programmed with Voice. When in All-control Lock mode, pressing these keys simply causes an error tone to sound. The transceiver does not make an announcement in any case.

## OPTIONAL ACCESSORIES

### PS-33

Regulated DC Power  
Supply



### SP-50B

Communications Speaker



### VS-3

Voice Synthesizer Unit



### PG-2N

DC Power Cable



### PG-3B

DC Line Noise Filter



### PG-4X

Extension Cable Kit



### PG-5A

Data Cable



### MC-45

Microphone



# INSTALLING OPTIONS

## INSTALLING THE VS-3 VOICE SYNTHESIZER UNIT



Always switch the power OFF and unplug the DC power cable first.

- 1 Remove the 6 screws from the lower cover of the main unit.

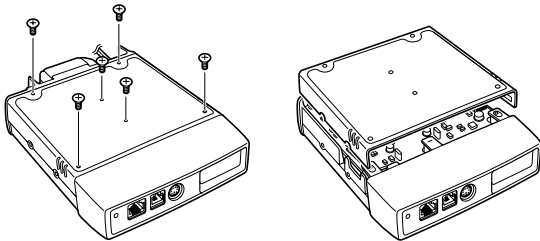

- 2 Hold the VS-3 unit with the component side facing up, then insert the VS-3 connector into the corresponding transceiver connector.
  - The component side must not face downward.

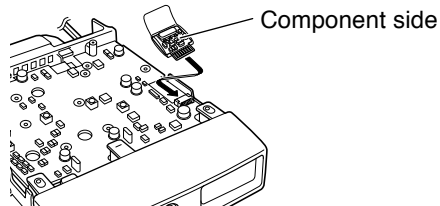

- 3 Replace the lower cover (6 screws).

## INSTALLING THE PG-4X EXTENSION CABLE KIT

The PG-4X kit is available to extend the various connection cables. For cable connections, see page 80. With two PG-4X kits, you can extend the cables to the maximum length.

The PG-4X kit also includes noise filters, modular plug adapter cushions, and cable clamps. The following diagrams illustrate how to install these accessories.

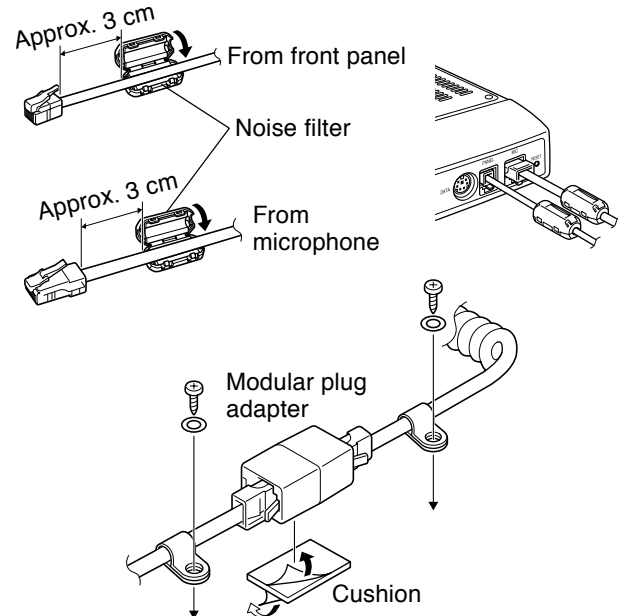

## Connections Using One PG-4X Kit

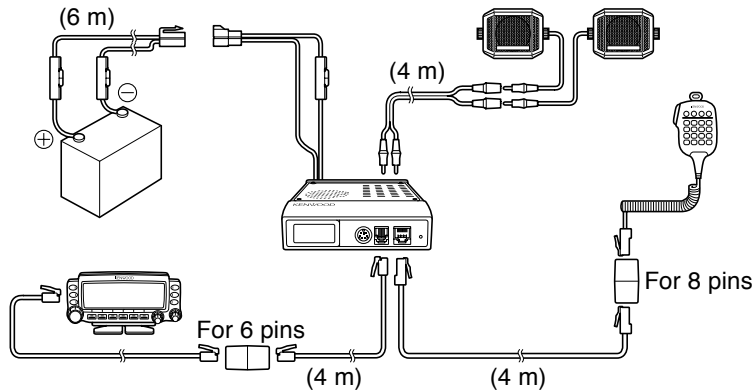

## Connections Using Two PG-4X Kits

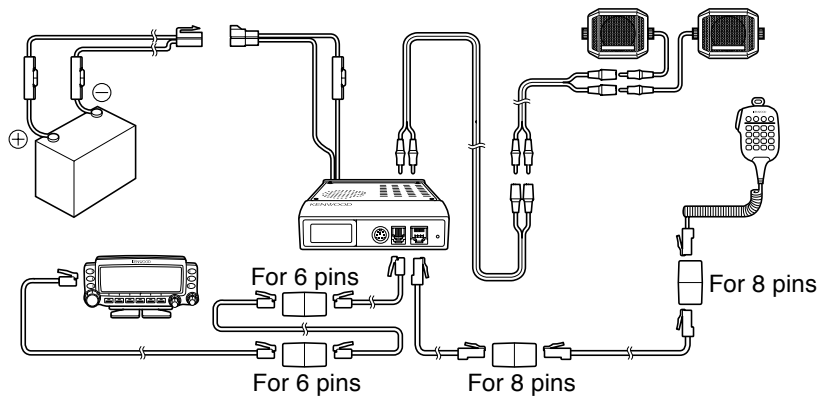

21

**Note:** Always connect the 4-pin plug on the modular plug cable supplied with the transceiver to the front panel.

## GENERAL INFORMATION

This product has been factory aligned and tested to specification before shipment. Attempting service or alignment without factory authorization can void the product warranty.

## SERVICE

When returning this product to your dealer or service center for repair, pack it in its original box and packing material. Include a full description of the problem(s) experienced. Include your telephone number along with your name and address in case the service technician needs to contact you; if available, also include your fax number and e-mail address. Don't return accessory items unless you feel they are directly related to the service problem.

You may return this product for service to the authorized **KENWOOD** dealer from whom you purchased it, or any authorized **KENWOOD** service center. Please do not send subassemblies or printed circuit boards. Send the complete product. A copy of the service report will be returned with the product.

## SERVICE NOTE

If you desire to correspond on a technical or operational problem, please make your note legible, short, complete, and to the point. Help us help you by providing the following:

- Model and serial number of equipment
- Question or problem you are having
- Other equipment in your station pertaining to the problem



### CAUTION

Do not pack the equipment in crushed newspapers for shipment! Extensive damage may result during rough handling or shipping.

### Note:

- ◆ Record the date of purchase, serial number and dealer from whom this product was purchased.
- ◆ For your own reference, retain a written record of any maintenance performed on this product.
- ◆ When claiming warranty service, please include a photocopy of the bill of sale, or other proof-of-purchase showing the date of sale.

## CLEANING

To clean the case of this product, use a neutral detergent (no strong chemicals) and a damp cloth.

## TROUBLESHOOTING

The problems described in this table are commonly encountered operational malfunctions and are usually not caused by circuit failure.

Problem	Probable Cause	Corrective Action	Page Ref.
The transceiver will not power up after connecting a 13.8 V DC power supply and pressing the <b>PWR</b> switch. Nothing appears on the display.	<b>1</b> The power cable was connected backwards.	<b>1</b> Connect the supplied DC power cable correctly: Red → (+); Black → (-).	5, 6
	<b>2</b> One or more of the power cable fuses are open.	<b>2</b> Look for the cause of the blown fuse(s). After inspecting and correcting any problems, install a new fuse(s) with the same rating.	7
	<b>3</b> The modular plug cable was not connected correctly.	<b>3</b> Correctly connect the modular plug cable between the front panel and main unit.	4
The display is too dim, even though you selected a high dimmer level.	The supply voltage is too low.	The supply voltage requirement is 13.8 V DC 15% (11.7 V to 15.8 V DC). If the input voltage is outside this range, recharge your battery, adjust your regulated power supply, and/or check all power cable connections.	—
The frequency cannot be selected by turning the <b>Tuning</b> control or by pressing Mic <b>[UP]/ [DWN]</b> .	Memory Recall was selected.	Press <b>[VFO]</b> .	15
Most keys and the <b>Tuning</b> control do not function.	One of the Lock functions is ON.	Unlock all of the Lock functions.	65
Memory channels cannot be selected by turning the <b>Tuning</b> control or by pressing Mic <b>[UP]/ [DWN]</b> .	No data has been stored in any memory channels.	Store data in some memory channels.	34
You cannot transmit even though you press Mic <b>[PTT]</b> .	<b>1</b> The microphone plug was not inserted completely into the front panel connector.	<b>1</b> Switch the power OFF, then insert the microphone plug until the locking tab clicks in place.	8
	<b>2</b> You selected a transmit offset that places the transmit frequency outside the allowable transmission range.	<b>2</b> Press <b>[F]</b> , <b>[SHIFT]</b> repeatedly so neither “+” nor “-” is visible.	27



# SPECIFICATIONS

Specifications are subject to change without notice due to advancements in technology.

General		VHF Band	UHF Band
Frequency range <sup>1</sup>		144 ~ 148 MHz	438 ~ 450 MHz
Mode		F3E (FM)	
Antenna impedance		50 Ω	
Usable temperature range		-20 C ~ +60 C (-4 F ~ +140 F)	
Power supply		13.8 V DC 15% (11.7 ~ 15.8 V)	
Grounding method		Negative ground	
Current	Transmit (max.)	11.5 A or less	10.0 A or less
	Receive (at 2 W output)	1.0 A or less	
Frequency stability (-10 C ~ +50 C)		Within 3 ppm	
Dimensions (W x H x D projections not included)	Front panel	140 x 60 x 33 mm/ 5.51" x 2.36" x 1.30"	
	Main unit	140 x 40 x 195 mm/ 5.51" x 1.57" x 7.68"	
Weight	Front panel	Approx. 180 g/ 6.3 oz	
	Main unit	Approx. 1.2 kg/ 2.6 lb	

<sup>1</sup> Band A receive range: 136 ~ 200 MHz, 118 ~ 136 MHz (sub), 200 ~ 300 MHz (sub), 300 ~ 400 MHz (sub), 400 ~ 470 MHz (sub)  
 Band B receive range: 400 ~ 524 MHz, 136 ~ 175 MHz (sub), 300 ~ 400 MHz (sub), 800 ~ 1300 MHz (sub/ excluding specific frequency ranges)

Transmitter		VHF Band	UHF Band
Power output	High	50 W	35 W
	Medium	Approx. 10 W	
	Low	Approx. 5 W	
Modulation		Reactance	
Spurious emissions		-60 dB or less	
Maximum frequency deviation		5 kHz	
Audio distortion (at 60% modulation)		3% or less	
Microphone impedance		600 $\Omega$	

Receiver		VHF Band	UHF Band
Circuitry		Double conversion superheterodyne	
Intermediate frequency (1st/ 2nd)		38.85 MHz/ 450 kHz	45.05 MHz/ 455 kHz
Sensitivity (12 dB SINAD)	VHF or UHF band	0.16 V or less	
	Sub VHF or UHF band	0.25 V or less	
Selectivity (-6 dB)		12 kHz or more	
Selectivity (-40 dB)		28 kHz or less	
Squelch sensitivity		0.1 V or less	
Audio output (8 ohms, 5% distortion)		2 W or higher	
Audio output impedance		8 $\Omega$	

**Note:** Receiver specifications apply only when using the main VHF or UHF band. They do not apply to the sub VHF or UHF bands.

# INDEX

Advanced Intercept Point (AIP) .....	67	Frequencies, Selecting		Offset		Group .....	49
Automatic Band Change (ABC) .....	64	Microphone [UP]/ [DWN] ..	20	Direction .....	27	Memory .....	48
Automatic Power Off (APO) .....	67	Tuning Control .....	20	Frequency .....	27	MHz .....	51
Automatic Simplex Check (ASC) .....	31	Frequency Step Size .....	62	Packet Operation		Program .....	50
Autopatch .....	57	Fuses, Replacing .....	7	Connecting to a TNC .....	71	Seek .....	47
Channel Display .....	38	Keypad Direct Entry		Data Speed .....	72	Time-Operated Resume ...	47
Continuous Tone Coded Squelch System (CTCSS)		CTCSS Frequency		Power-ON Message .....	68	VFO .....	48
Frequency ID .....	54	Number .....	54	Programmable Function		Visual .....	45
Using .....	53	Frequency .....	61	(PF) Keys .....	60	Speaker	
Digital Code Squelch (DCS)		Memory Channel		Programmable Memory (PM)		Configurations, changing ..	69
Code ID .....	56	Number .....	35	Auto Storing .....	43	Mute .....	69
Using .....	55	Tone Freq. Number .....	28	Recalling .....	42	Squelch	
Display		Lock		Resetting .....	43	Adjusting .....	20
Blanking .....	64	All-control Lock .....	65	Storing .....	42	Hang Time .....	66
Contrast .....	63	Transceiver Lock .....	65	Programmable VFO .....	62	S-meter .....	65
Demonstration .....	68	Memory Channels		Repeater Access .....	26	Switching FM/AM .....	66
Dimmer, Changing .....	63	Call Channel, Changing ....	37	Repeater Function		Time-Out Timer (TOT) .....	67
Reversal .....	63	Call Channel, Recalling ....	37	Cross-band .....	76	Tone	
Dual Tone Multi-Frequency (DTMF) Functions		Clearing .....	35	Locked-band .....	76	Activating .....	28
Making Calls .....	57	Locking Out .....	49	Reset		Frequency ID .....	32
Pause Duration .....	59	Naming .....	36	Full (Memory) .....	39	Selecting .....	28
Storing Numbers .....	58	Recalling .....	35	Partial (VFO) .....	39	Transmit Output Power .....	21
Transmitting Stored		Storing, Odd-split .....	34	Programmable Memory		Voice Synthesizer (VS-3)	
Numbers .....	59	Storing, Simplex .....	34	(PM) .....	43	Installing .....	79
TX Speed .....	59	Transfer to VFO .....	38	Reverse Function .....	31	Operation .....	77
		Menu		Scan		Volume	
		Access .....	22	Call/Memory .....	52	Audio .....	19
		Configuration .....	23	Call/VFO .....	52	Beep .....	66
		Microphone Control .....	73	Carrier-Operated		Wireless Remote Control ...	74
				Resume .....	47		

KENWOOD

## Free Manuals Download Website

<http://myh66.com>

<http://usermanuals.us>

<http://www.somanuals.com>

<http://www.4manuals.cc>

<http://www.manual-lib.com>

<http://www.404manual.com>

<http://www.luxmanual.com>

<http://aubethermostatmanual.com>

Golf course search by state

<http://golfingnear.com>

Email search by domain

<http://emailbydomain.com>

Auto manuals search

<http://auto.somanuals.com>

TV manuals search

<http://tv.somanuals.com>