

KENWOOD

AUDIO VIDEO SURROUND RECEIVER

VRS-7100

INSTRUCTION MANUAL

KENWOOD CORPORATION

Quick Start Reference

Please read the following pages so that you can enjoy the surround sound at the best condition.

(These pages give shortcut explanations on how to connect the speaker system to the receiver, set up the speakers and play a source.)

"Let's play DVD video software" - 20 - 21, - 22 - 23

About the supplied remote control

Compared to standard remote controls, the remote control supplied with this receiver has several operation modes. These modes enable the remote control to control other audio/video components. In order to effectively use the remote control it is important to read the operating instructions and obtain a proper understanding of the remote control and how to switch its operation modes (etc.).

Using the remote control without completely understanding its design and how to switch the operation modes may result in incorrect operations.



B60-5462-10 02 (MA) (K, P, E, X) (AP) 0312

Before applying power

 **Caution** : Read this page carefully to ensure safe operation.





Units are designed for operation as follows.

U.S.A. and Canada AC 120 V only
Australia AC 240 V only

Europe AC 230 V only

Safety precautions

WARNING : TO PREVENT FIRE OR ELECTRIC SHOCK, DO NOT EXPOSE THIS APPLIANCE TO RAIN OR MOISTURE.

	CAUTION RISK OF ELECTRIC SHOCK DO NOT OPEN		CAUTION: TO REDUCE THE RISK OF ELECTRIC SHOCK, DO NOT REMOVE COVER (OR BACK). NO USER-SERVICEABLE PARTS INSIDE. REFER SERVICING TO QUALIFIED SERVICE PERSONNEL.
	THE LIGHTNING FLASH WITH ARROWHEAD SYMBOL, WITHIN AN EQUILATERAL TRIANGLE, IS INTENDED TO ALERT THE USER TO THE PRESENCE OF UNINSULATED "DANGEROUS VOLTAGE" WITHIN THE PRODUCT'S ENCLOSURE THAT MAY BE OF SUFFICIENT MAGNITUDE TO CONSTITUTE A RISK OF ELECTRIC SHOCK TO PERSONS.		
	THE EXCLAMATION POINT WITHIN AN EQUILATERAL TRIANGLE IS INTENDED TO ALERT THE USER TO THE PRESENCE OF IMPORTANT OPERATING AND MAINTENANCE (SERVICING) INSTRUCTIONS IN THE LITERATURE ACCOMPANYING THE APPLIANCE.		

How to use this manual

This manual is divided into four sections, Preparations, Operations, Remote Control, and Additional Information.

Preparations

Shows you how to connect your audio and video components to the receiver and prepare the surround processor. Since this receiver works with all your audio and video components, we will guide you in setting up your system to be as easy as possible.

Operations

Shows you how to operate the various functions available on the receiver.

Remote Control

Shows you how to operate other components using the remote control, as well as a detailed explanation of all remote control operations. Once you have registered your components with the proper setup codes, you'll be able to operate both this receiver and your other AV components (TV, VCR, DVD player, CD player, etc.) using the remote control supplied with this receiver.

Additional Information

Shows you additional information such as "In case of difficulty" (trouble shooting) and "Specifications".

Maintenance of the unit

When the front panel or case becomes dirty, wipe with a soft, dry cloth. Do not use thinner, benzine, alcohol, etc. for these agents may cause discoloration.

In regard to contact cleane

Do not use contact cleaners because it could cause a malfunction. Be specially careful not to use contact cleaners containing oil, for they may deform the plastic component.

Unpacking

Unpack the unit carefully and make sure that all the accessories are present.

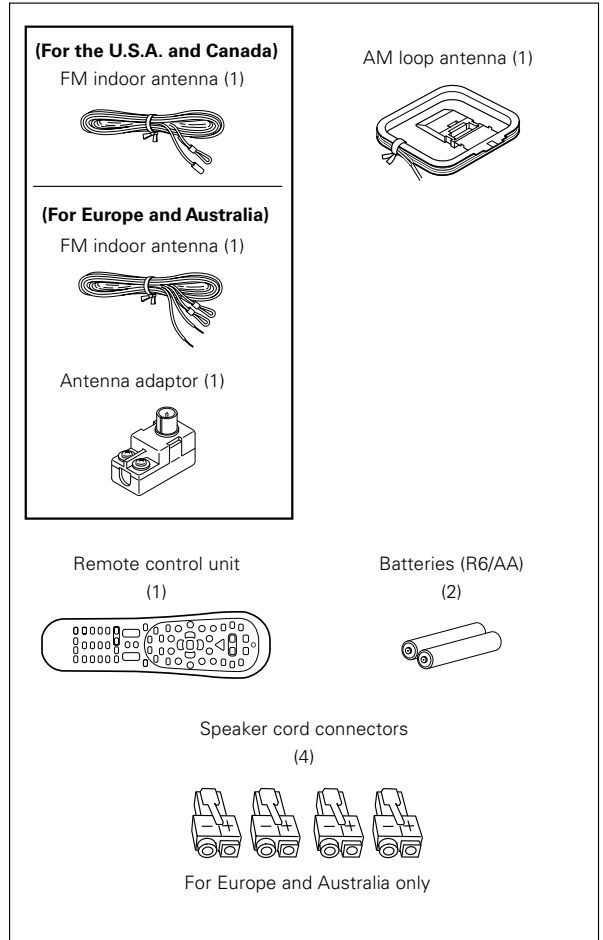

If any accessories are missing, or if the unit is damaged or fails to operate, notify your dealer immediately. If the unit was shipped to you directly, notify your shipper immediately. Kenwood recommends that you retain the original carton and packing materials in case you need to move or ship the unit in the future. **Keep this manual handy for future reference.**

Special features

True home theater sound → 37 ~ → 39

This receiver incorporates a wide variety of surround modes to bring you maximum enjoyment from your video software. Select a surround mode according to your equipment or the software you are going to play and enjoy!

- Dolby Digital EX
- Dolby PRO LOGIC IIX, Dolby PRO LOGIC II
- Dolby Digital
- DTS-ES
- DTS NEO:6
- DTS 96/24
- DTS
- DSP Mode
- Dolby Virtual Speaker
- Dolby Headphone

GAME mode function → 27

When you connect a game machine to the **GAME** jacks on the front panel, the input selector of the receiver switches automatically to "GAME" and the optimum sound field for enjoying games is set. This feature improves your convenience in playing video games.

DUAL SOURCE function → 30

While you enjoy audio listening through the speakers, another person can enjoy another source (audio + video) through headphones by connecting the source to the **GAME, FRONT AUX** jacks.

ACTIVE EQ → 31

ACTIVE EQ mode will produce a more dynamic sound quality in any condition. You can enjoy a more impressive sound effect when ACTIVE EQ is turned on during Dolby Digital and DTS playback.

Remote control → 45

In addition to the basic receiver, the remote control supplied with this receiver can also operate almost all of your remote controllable audio and video components. Just follow the simple setup procedure to register the components you have connected.

RDS (Radio Data System) tuner (For Europe) → 35



The receiver is equipped with an RDS tuner that provides several convenient tuning functions: RDS Auto Memory, to automatically preset up to 40 RDS stations broadcasting different programs; station name display, to show you the name of the current broadcast station; and PTY search to let you tune stations by program type.

PTY (Program TYPe) search (For Europe) → 36

Tune the stations by specifying the type of program you want to hear.

Contents

Caution : Read the pages marked  carefully to ensure safe operation.

	Before applying power	2
	Safety precautions	2
	How to use this manual	3
	Unpacking	3
	Special features	4
	Contents	5
	Names and functions of parts	6
	Main unit	6
	Remote control unit	7

Preparations	Setting up the system	8
	Connecting a DVD player	9
	Connecting video components, audio components	10
	Digital connections	12
	Connecting the speakers	13
	Connecting the speaker terminals ...	15
	PRE OUT connections	16
	Connecting to the GAME jacks / FRONT AUX jacks	17
	Connecting the antennas	18
	Preparing the remote control	19
	Let's play DVD video software (For U.S.A. and Canada)	20
	Let's play DVD video software (For Europe and Australia)	22
	Preparing for playback	24
	Speaker settings	24
	Re-assignment of rear panel jacks ...	28

Operations	Normal playback	29
	Listening to a source component ...	29
	Listening with headphones	30
	Adjusting the sound	30
	Recording	32
	Analog sources	32
	Digital sources	32
	Listening to radio broadcasts	33
	Tuning (non-RDS) radio stations ...	33
	Presetting radio stations	33
	Receiving preset stations	34
	Receiving preset stations in order (P.CALL)	34
	Using RDS (Radio Data System) (For Europe only)	35
	Using the RDS Disp. (Display) key ...	35
	Tuning by Program TYpe (PTY search)	36

Operations	Ambience effects	37
	Surround modes	37
	Virtual modes	39
	Surround play	40
	Convenient functions	42

Remote Control	Basic remote control operations for other components	45
	Registering setup codes for other components	45
	Searching for your code	45
	Checking the codes	46
	Re-assigning device keys	46
	Operating other components	46
	Clearing all of the settings registered or stored in the remote control unit	46
	Setup code chart (RC-R0730) (For U.S.A., Canada and Australia)	47
	Setup code chart (RC-R0730E) (For Europe)	51
	DVD player , MD recorder CD player & TV operations	58
	VCR , Satellite receiver & Cable con- verter operations	59

Additional Information	In case of difficulty	60
	Specifications	62

Names and functions of parts

Main unit

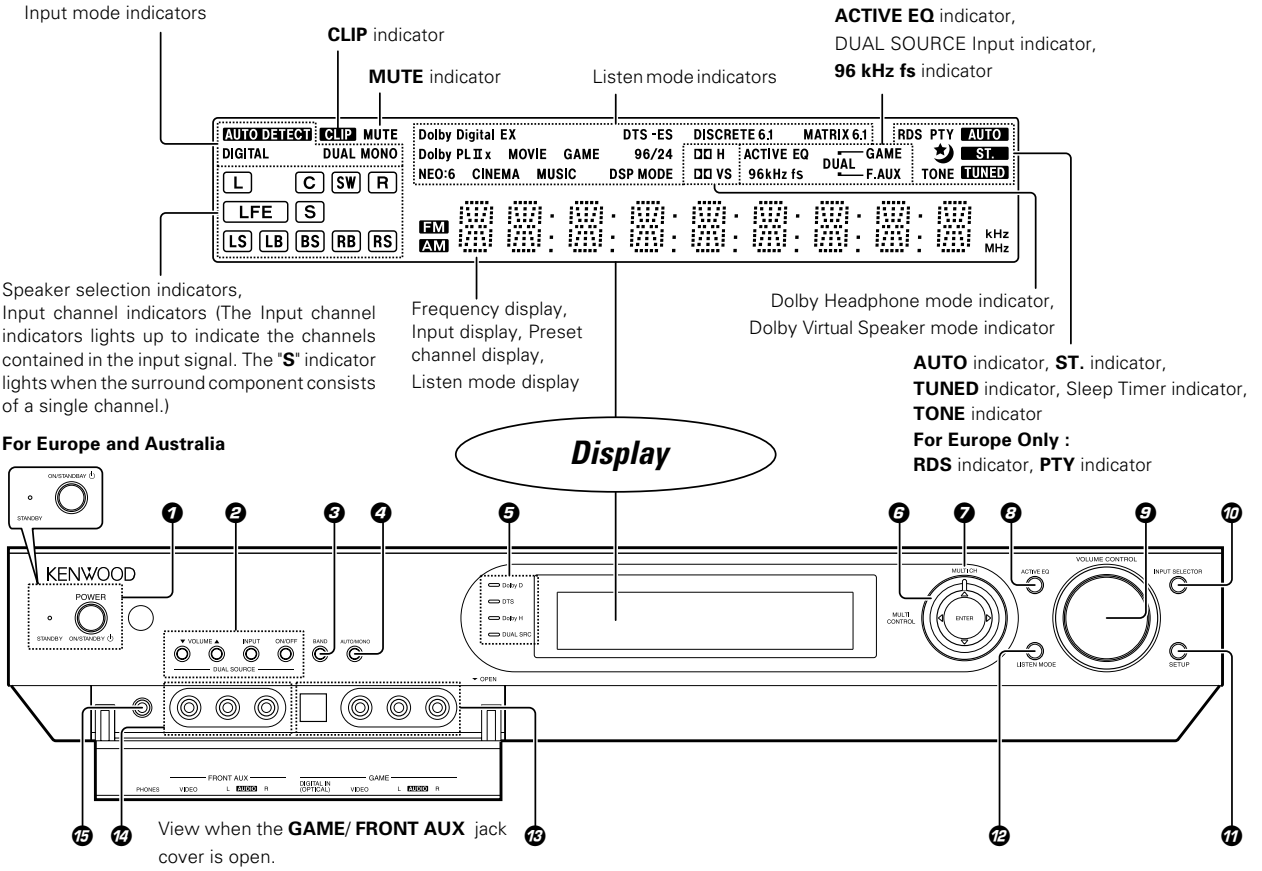

- 1 (For the U.S.A. and Canada) POWER ON/STANDBY key** - 24
Use to turn the power ON/STANDBY.
- (For Europe and Australia) ON/STANDBY key** - 24
Use to turn the power ON/STANDBY.
- STANDBY indicator**
Lights when the power is in the standby mode.
- 2 DUAL SOURCE VOLUME / keys** - 30
Use to adjust the volume in the DUAL SOURCE mode.
- DUAL SOURCE INPUT key** - 30
Use to select the input for the DUAL SOURCE mode.
- DUAL SOURCE ON/OFF key** - 30
Use to switch the DUAL SOURCE mode ON/OFF.
- 3 BAND key** - 33
Use to select the broadcast band.
- 4 AUTO/MONO key** - 33
Use to select the auto or manual tuning mode.

- 5 Dolby D indicator** - 40
Lights when the receiver is in the Dolby Digital mode.
- DTS indicator** - 40
Lights when the receiver is in the DTS mode.
- Dolby H indicator** - 39
Lights when the Dolby H mode is ON.
- DUAL SRC indicator** - 30
Lights when the DUAL SOURCE mode is ON.
- 6 Joystick**
MULTI CONTROL / - 21 - 23 - 33
Use to control a variety of settings. Use to tuning of radio broadcasting.
- MULTI CONTROL /** - 21 - 23 - 34
Use to control a variety of settings. Use to selection of preset radio stations.
- ENTER** - 21 - 23 - 33
Use to control a variety of settings. Use to presetting of radio stations.
- 7 MULTI CH indicator** - 40
Lights during multi-channel playback.

- 8 ACTIVE EQ key** - 31
Use to select ACTIVE EQ's setting.
- 9 VOLUME CONTROL knob** - 29
Use to adjust the receiver volume.
- 10 INPUT SELECTOR key** - 29
Use to select input sources.
- 11 SETUP key** - 21 - 23 - 32
Use to select the speakers' settings etc. Use to select the REC MODE.
- 12 LISTEN MODE key** - 40
Use to select the listening mode.
- 13 GAME jacks** - 17 - 27 - 30
- 14 FRONT AUX jacks** - 17 - 30
- 15 PHONES jack** - 30
Use for headphone listening.

Standby mode

While the standby indicator is lit, a small amount of power is supplied to the system to back up the memory. This is called standby mode. Under the condition, the system can be turned ON by the remote control unit.

Remote control unit

This remote control unit can be used not only for Kenwood products but also for other non-Kenwood products by setting the appropriate manufacturer's setup codes. - [47]

For the U.S.A., Canada and Australia: RC-R0730

For Europe : RC-R0730E

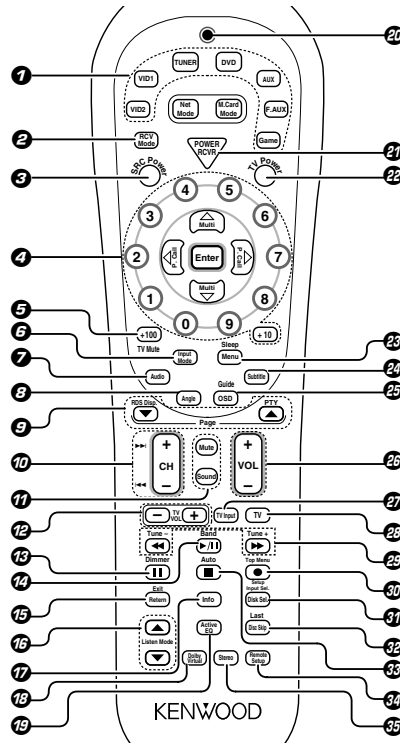
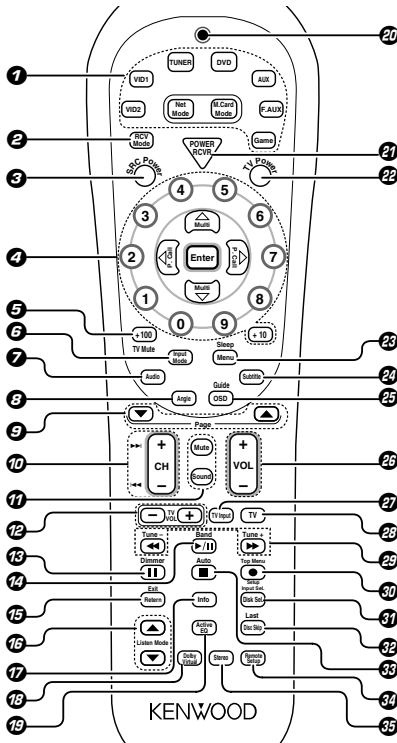

If the name of a function is different on the receiver and on the remote control, the name of the remote control key in this manual is indicated in parentheses.

- 1 **Input Selector keys (TUNER, DVD, VID 1, VID 2, AUX, F. AUX, Game)** - [29]
Use to select input sources.
Sources keys (TUNER, DVD, VID 1, VID 2, AUX, F. AUX, Game) - [45]
To control one of the registered sources without switching the receiver's input selector to that source, press and hold the desired input selector key for more than 3 seconds.
Net Mode key, M.Card Mode key
Availability may differ depending on the country and sales area.
- 2 **RCV (receiver) Mode key** - [24] - [42]
Use to switch the remote control to the receiver control mode.
- 3 **SRC (source) Power key**
Use to turn the other components ON/OFF.
- 4 **Numeric keys** - [34] - [45]
Use to selection of preset radio stations. Use to operate other components.
Multi (Δ/▽) keys - [24] - [33]
Use to control a variety of settings as well as in tuning of radio broadcasting. Use to operate other components.
P.Call </> keys - [24] - [34]
Use to control a variety of settings. Use to selection of preset radio stations.
Enter key - [24]
Use to control a variety of settings. Use to operate other components.
- 5 **+100 key**
Use to select MD tracks when the remote control controls the MD recorder.

- TV Mute key**
Use to temporarily mute the TV sound.
- 6 **Input Mode key** - [8]
Use to switch between the full auto, digital and analog input.
- 7 **Audio key**
Use to operate the DVD component.
- 8 **Angle key**
Use to operate the DVD component.
- 9 **Page ▲/▼ keys (For Europe only)**
RDS Disp. key
Use to receive RDS broadcast.
PTY key
Use for PTY search.
- 10 **CH +/- keys**
Use to select the channels.
▶▶/◀◀ keys
If CD, MD or DVD is selected as the input source, these keys function as skip keys.
- 11 **Mute key** - [31]
Use to temporarily mute the sound.
Sound key - [28] - [30] - [42]
Use to adjust the sound quality and the ambience effects.
- 12 **TV VOL +/- keys**
Use to adjust the TV's volume.
- 13 **II key**
Use to operate other components.
Dimmer key - [44]
Use to adjust the brightness of the display.

- 14 **▶/II key**
If CD is selected as the input source, this key functions as the play/pause key. If DVD, MD or VCR is selected as the input source, this key functions as the play key.
Band key - [33]
Use to select the broadcast band.
- 15 **Return key**
Use to operate the DVD component.
Exit key
Use to operate other components.
- 16 **Listen Mode ▲/▼ keys** - [40]
Use to select the listening mode.
- 17 **Info key**
Use to operate other components.
- 18 **Dolby Virtual key** - [39]
Use to select the Dolby Virtual mode.
- 19 **Active EQ key** - [31]
Use to select ACTIVE EQ 's setting.
- 20 **LED indicator**
Blinks to show that signals are being transmitted.
- 21 **POWER RCVR (receiver) key** - [24]
Use to turn the receiver ON/STANDBY.
- 22 **TV Power key**
Use to turn the TV on and off.
- 23 **Menu key**
Use to operate other components.
Sleep key - [44]
Use to set the Sleep timer.
- 24 **Subtitle key**
Use to operate the DVD component.
- 25 **OSD key**
Use to operate the DVD component.
Guide key
Use to operate other components.
- 26 **VOL +/- keys** - [29]
Use to adjust the receiver volume.
- 27 **TV Input key**
Use when in TV operation.
- 28 **TV key**
Use when in TV operation.
- 29 **◀◀ / ▶▶ keys**
If CD, MD or DVD is selected as the input source, these keys function as search key.
Tune +/- keys - [33]
Use to tuning of radio broadcasting.
- 30 **● key**
If MD or VCR is selected, this key functions as record key.
If VCR is selected, this key functions as record key when it is pressed twice sequentially.
Top Menu key
Use to operate the DVD component.
Setup key - [24]
Use to select the speakers ' settings etc.
- 31 **Disc Sel. key**
Use to operate other components.
Input Sel. key
Use to operate other components.
- 32 **Disc Skip key**
If CD is selected as the input source, this key functions as the multi-CD player disc skip key.
Last key
Use to operate other components.
- 33 **■ key**
If CD, MD or DVD is selected as the input source, this key functions as the stop key.
Auto key - [33]
Use to select the auto or manual tuning mode.
- 34 **Remote Setup key** - [45] - [46]
Use to register other components.
- 35 **Stereo key** - [41]
Use to switch the listen mode temporary to the stereo mode.

Setting up the system

CAUTION

Make sure that the power cord plug is disconnected from the AC wall outlet before proceeding to connections. Also be sure to disconnect the power cord plug from the AC wall outlet before changing connections. For the connections of other system components, see pages 9 to 18.

When connecting an associated system component, be sure to read its instruction manual.

Microcomputer malfunction

If operation is not possible or an erroneous display appears, even though all connections have been made properly, reset the micro computer referring to "In case of difficulty". - [60]

Notes

1. Be sure to turn off the system components before connecting them.
2. Be sure to insert every connection cable completely into the jack. Incomplete connection may result in absence of audio output or production of noise.
3. Be sure to disconnect the power cord from the AC wall outlet before inserting or removing a connection cable.
4. Installation of outdoor antenna is a dangerous work. Please have your dealer or a specialized technician install it.
5. Select the speaker installation locations with care. If a speaker is installed near a source of magnetism including a magnet, the mutual interference with the speaker may produce color irregularities on the TV screen.

Analog audio connections

Audio connections are made using RCA pin cords. These cables transfer stereo audio signal in an "analog" form. This means the audio signal corresponds to the actual audio of two channels. These cables usually have 2 plugs on each end, one red for the right channel and one white for the left channel.

These cables are to be prepared separately by the user.

CAUTION

Be sure to adhere to the following, or proper ventilation will be blocked causing damage or fire hazard.

- Do not place any objects impairing heat radiation onto the top of the unit.
- Leave some space around the unit (from the largest outside dimension including projection) equal to or greater than, shown below.

Top panel	: 50 cm
Side panel	: 10 cm
Back panel	: 10 cm

Input mode settings

DVD, VIDEO 1, VIDEO 2, AUX and **GAME** inputs each include jacks for digital audio input and analog audio input.

The initial factory settings for audio signal playback for DVD, VIDEO 1, VIDEO 2, AUX and GAME are full auto.

After completing connections and turning on the receiver, follow the steps below.

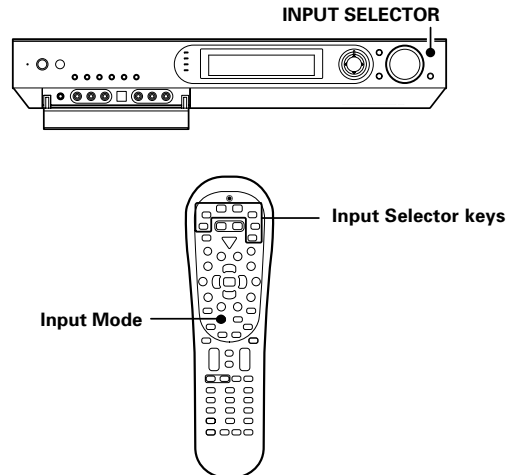

❶ Use the **INPUT SELECTOR** key (or Input Selector keys) to select **DVD, VIDEO 1, VIDEO 2, AUX** or **GAME**.

❷ Press the **Input Mode** key.

Each press switches the setting as follows:

- ① **"F-AUTO"**: Auto detect
("AUTO DETECT" indicator lights up)
 - ② **"D-MANUAL"**: Fixed to digital input
("DIGITAL" indicator lights up)
 - ③ **"ANALOG"**: Fixed to analog input *
("AUTO DETECT", "DIGITAL" indicator goes off)
- * Can not be selected for DTS playback.

Auto detect:

In **"F-AUTO (FULL AUTO)"** mode ("AUTO DETECT" indicator light up), the receiver detects the digital or analog input signals automatically. The receiver will select the input mode and listening mode automatically during playback to match the type of input signal (Dolby Digital, PCM, DTS) and the speaker setting. - [40]
The **"DIGITAL"** indicator lights up when a digital signal is detected. The **"DIGITAL"** indicator is extinguished when no digital signal is detected.

Fixed to digital input:

Select this mode if you want to keep the decoding condition (Dolby Digital, DTS, PCM, etc.) in the current listen mode. When **"D-MANUAL (DIGITAL MANUAL)"** mode is selected, the set listen modes may be changed automatically depending on the listen mode. - [40]

Fixed to analog input:

Select this setting to play analog signals from a VCR, etc.

If the **Input Mode** key is pressed quickly, sound may not be produced. Press the **Input Mode** key again.

Connecting a DVD player

If you have connected a DVD player to the receiver with digital connection, be sure to read the "Input mode settings", "Re-assignment of rear panel jacks" section carefully. → 8 → 29

- Digital audio connections are required when playing multi-channel signals such as the Dolby Digital and DTS signals.
- To play the DVD player connected in this page, select the "DVD" input selector. → 29

For U.S.A. and Canada

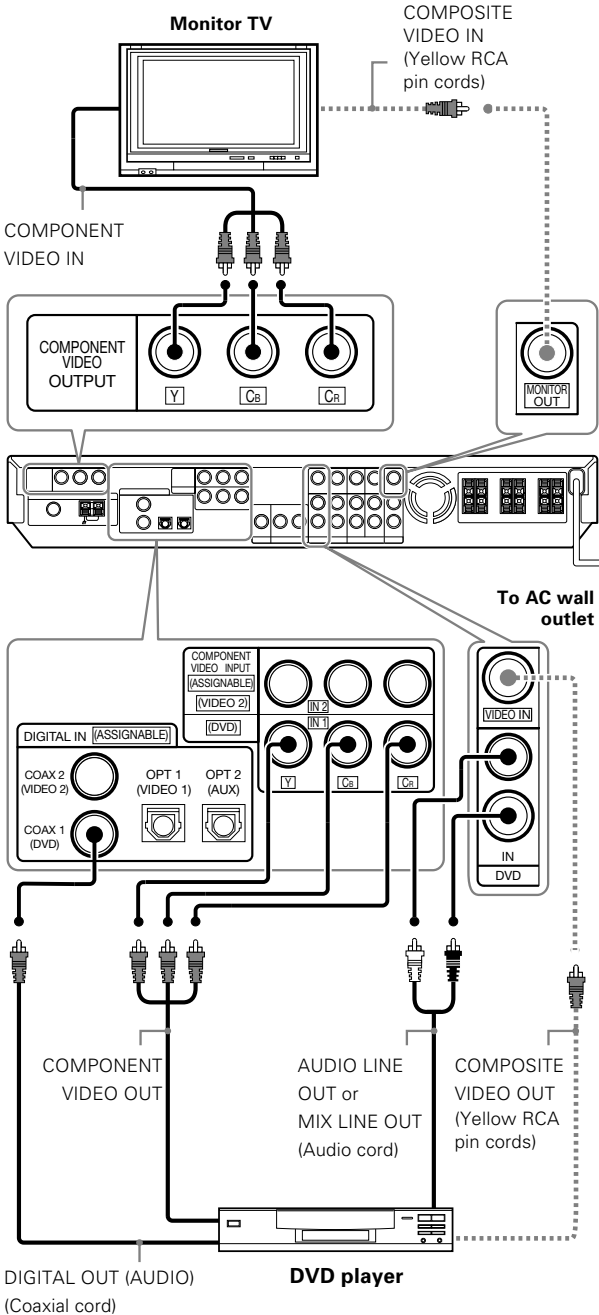

For Europe and Australia

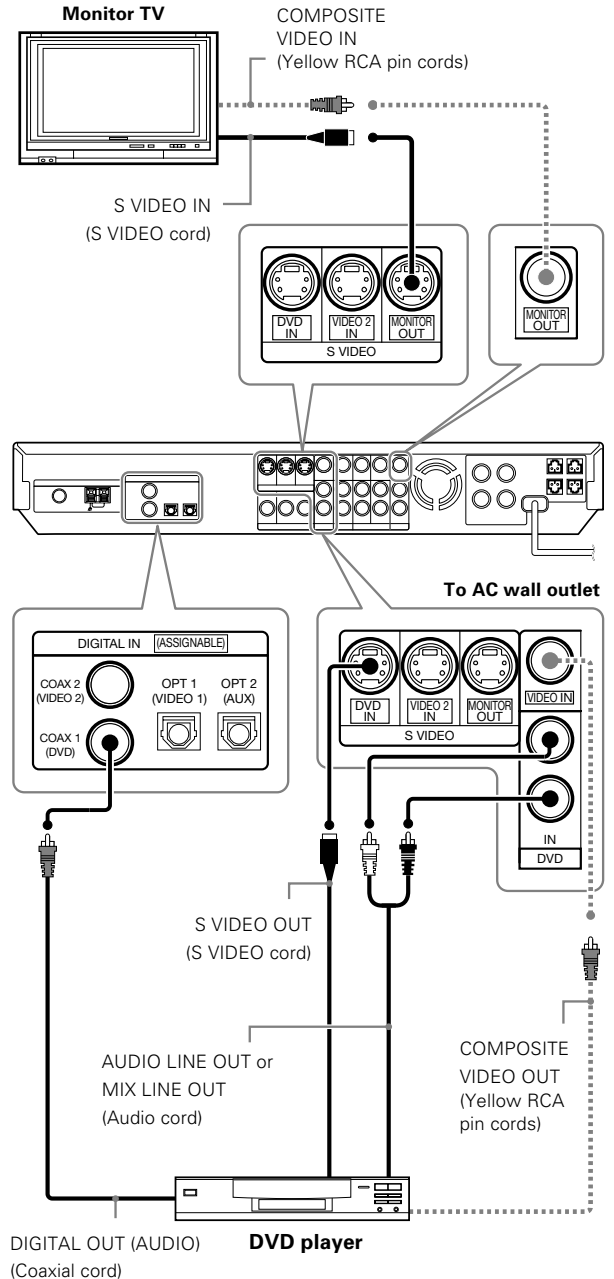

Connecting video components, audio components

For U.S.A. and Canada

Audio components

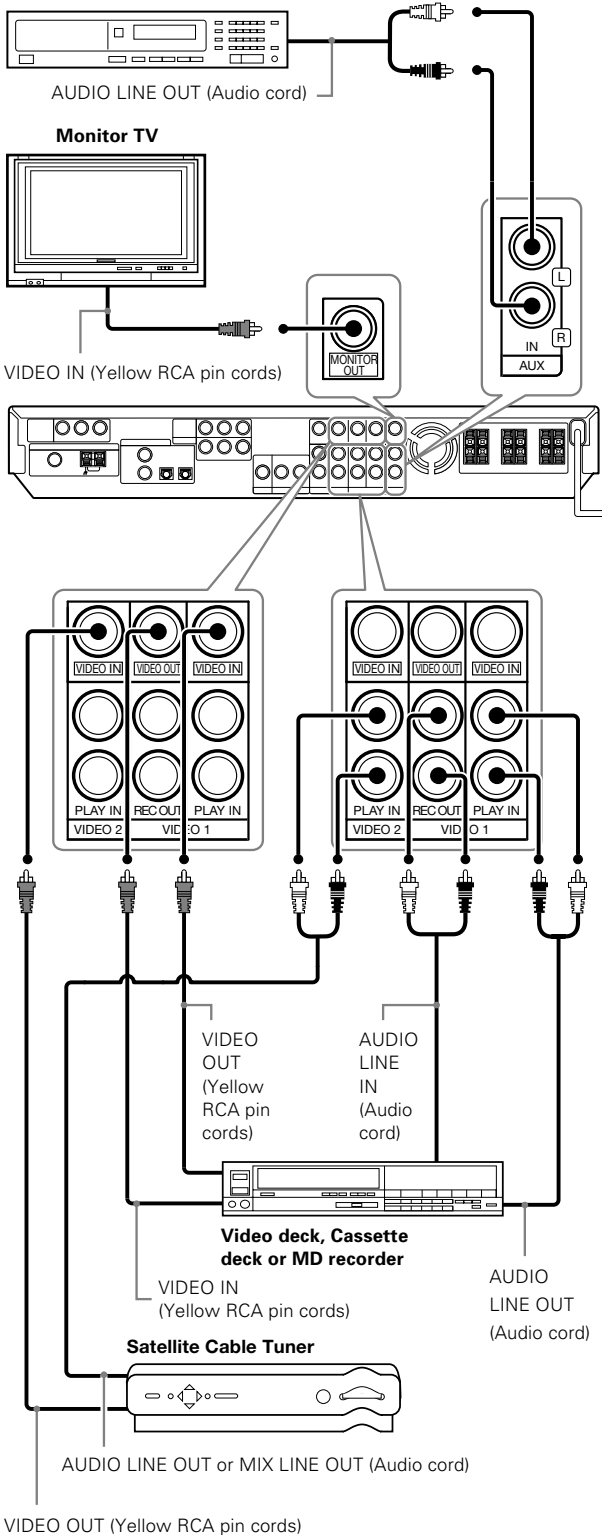

Connecting video components (COMPONENT VIDEO)

If you have connected the receiver to a video component with COMPONENT jacks, you can get a better picture quality than by connecting to the S VIDEO jacks.

When connecting a video component with COMPONENT jacks, see "Re-assignment of rear panel jacks" - 28

When connecting the TV to the COMPONENT jacks, be sure to connect all the other components to the COMPONENT jacks.

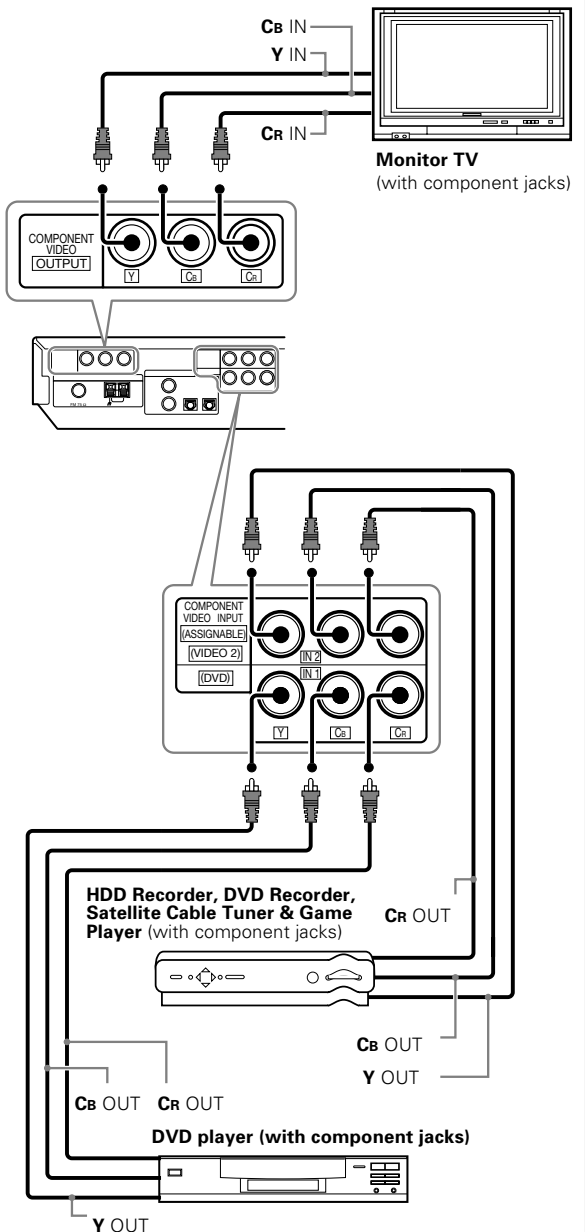

For Europe and Australia

Audio components

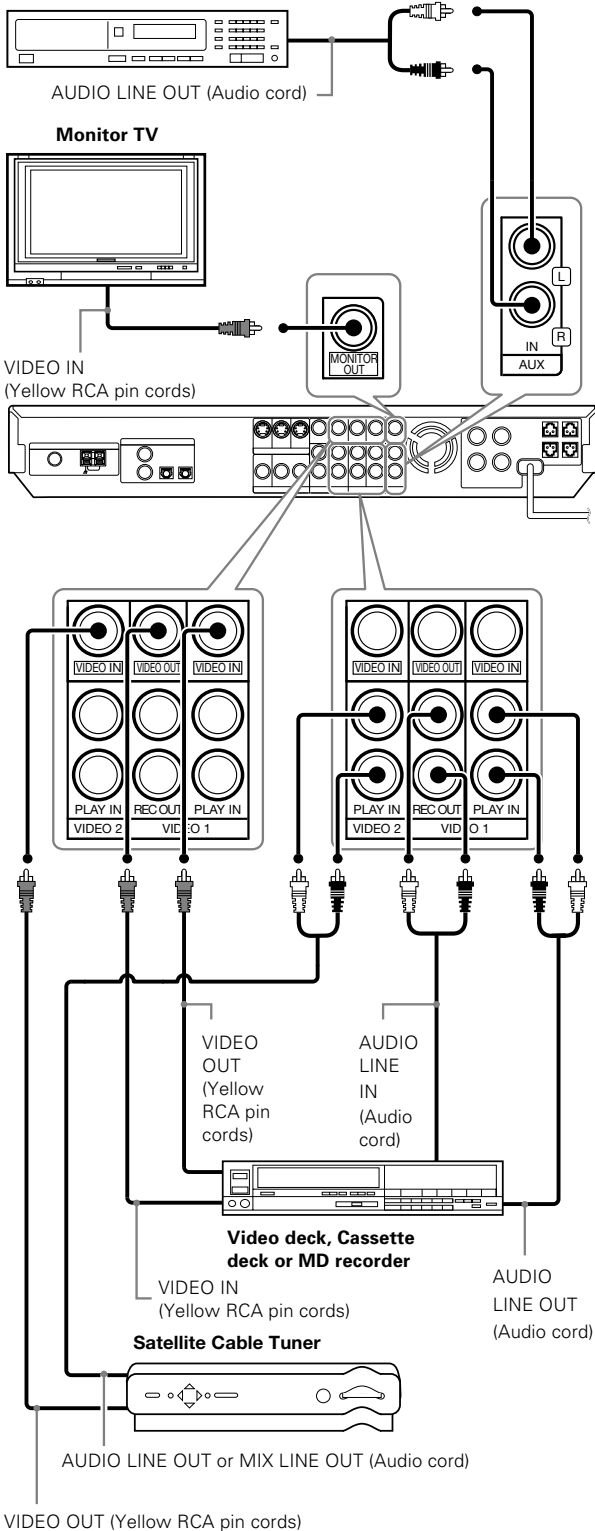

Connecting video components (S VIDEO)

Use the S VIDEO jacks to make connections to video components with S VIDEO IN/OUT jacks.

- If you use the S VIDEO jacks to connect your video playback components, be sure to use the S VIDEO jacks when connecting your monitor and video recording components.

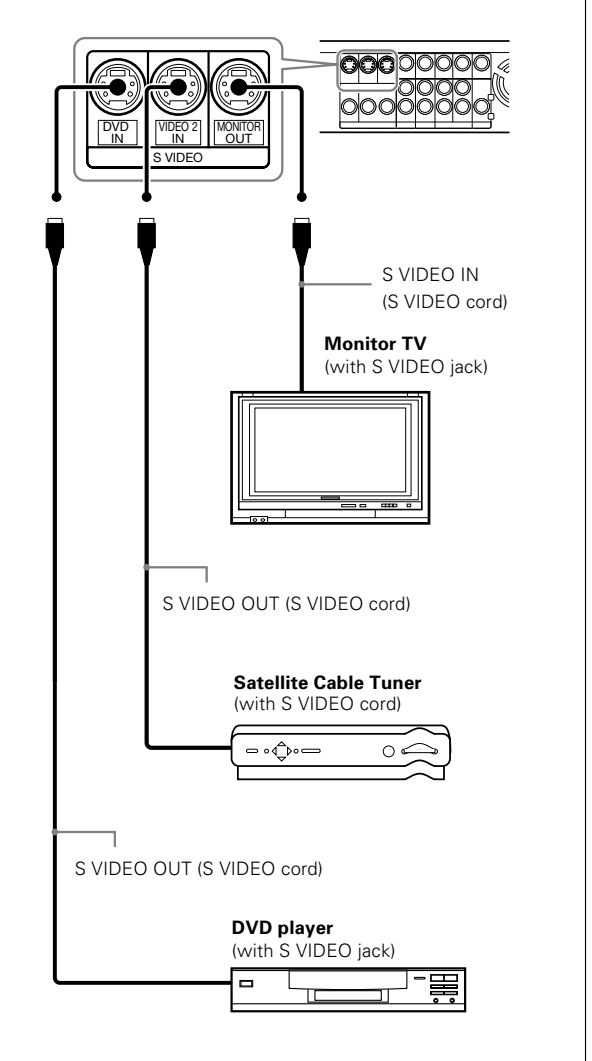

Digital connections

The digital in jacks can accept DTS, Dolby Digital, or PCM signals. Connect components capable of outputting DTS, Dolby Digital or PCM (CD) digital signals.

If you have connected a DVD player to the receiver with digital connection, be sure to read the "Input mode settings", "Re-assignment of rear panel jacks" section carefully. - [8] - [28]

DTS disclaimer clause

When playing DTS-encoded discs, excessive noise will be exhibited from the analog stereo outputs of the CD or DVD player. To enjoy DTS Digital Surround™ playback, this unit must be connected to the digital output of the CD or DVD player.

For U.S.A. and Canada

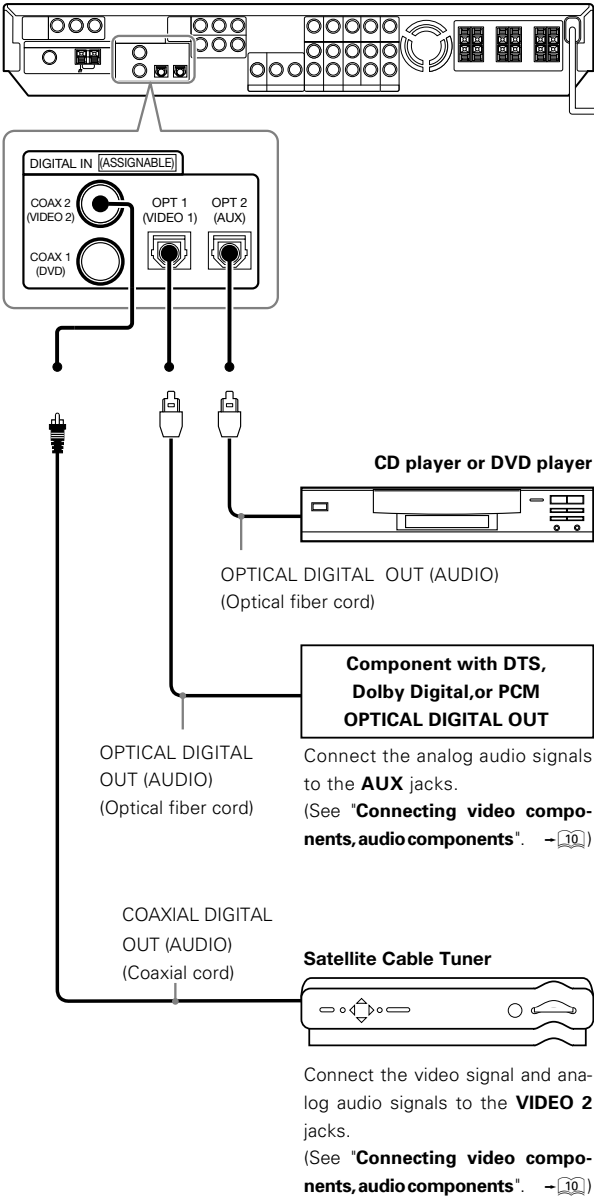

For Europe and Australia

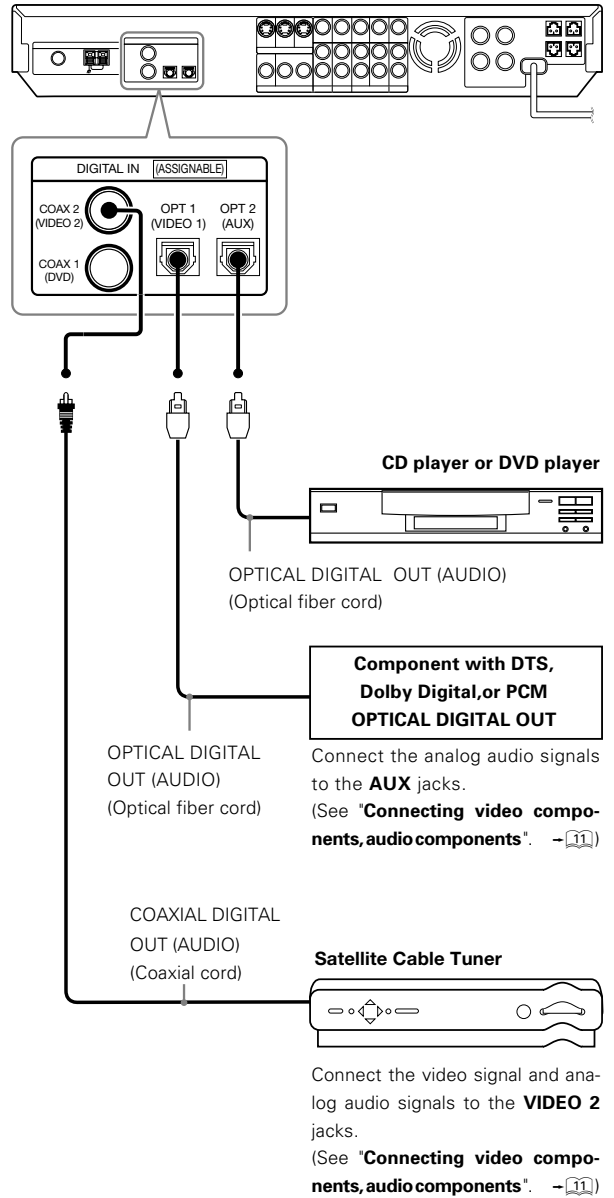

Connecting the speakers

For U.S.A. and Canada

CAUTION

Make sure that the power cord plug is disconnected from the AC wall outlet before proceeding to speaker cord connections. If the conductor wires on the extremity of speaker cord are untwisted, there is a risk of short-circuiting. Be sure to twist them well before connecting the speaker cord.

Whether each speaker is connected properly can be confirmed by outputting the test tone and checking if each speaker channel outputs audio. For details, see "Speaker settings" (Step 2 Adjust the speaker volume level). → 26

Protection circuitry

This unit incorporates protection circuitry, which may be activated during high-power reproduction or in case of extreme rise in temperature.

When the protection circuitry is activated, the output from this unit is shut down and the STANDBY indicator blinks.

In this case, turn this unit OFF then ON again and reduce the output volume level.

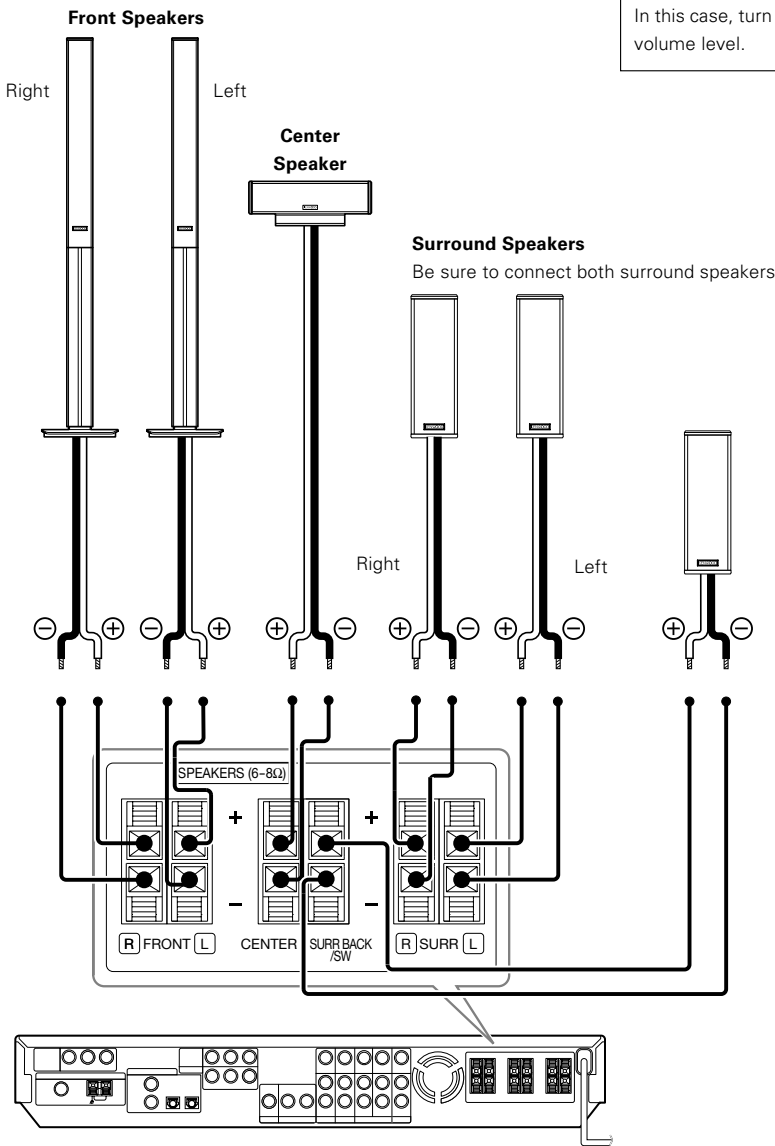

Subwoofer/ Surround Back Speaker

When the surround back speaker is connected to these terminals, set the speaker setting to "BS/SW BS".

In this case, the subwoofer should be connected to the PRE OUT SUBWOOFER jack → 16

For Europe and Australia

CAUTION

Make sure that the power cord plug is disconnected from the AC wall outlet before proceeding to speaker cord connections. If the conductor wires on the extremity of speaker cord are untwisted, there is a risk of short-circuiting. Be sure to twist them well before connecting the speaker cord.

Whether each speaker is connected properly can be confirmed by outputting the test tone and checking if each speaker channel outputs audio. For details, see "Speaker settings" (Step 2 Adjust the speaker volume level). → 26

Protection circuitry

This unit incorporates protection circuitry, which may be activated during high-power reproduction or in case of extreme rise in temperature.

When the protection circuitry is activated, the output from this unit is shut down and the STANDBY indicator blinks.

In this case, turn this unit OFF then ON again and reduce the output volume level.

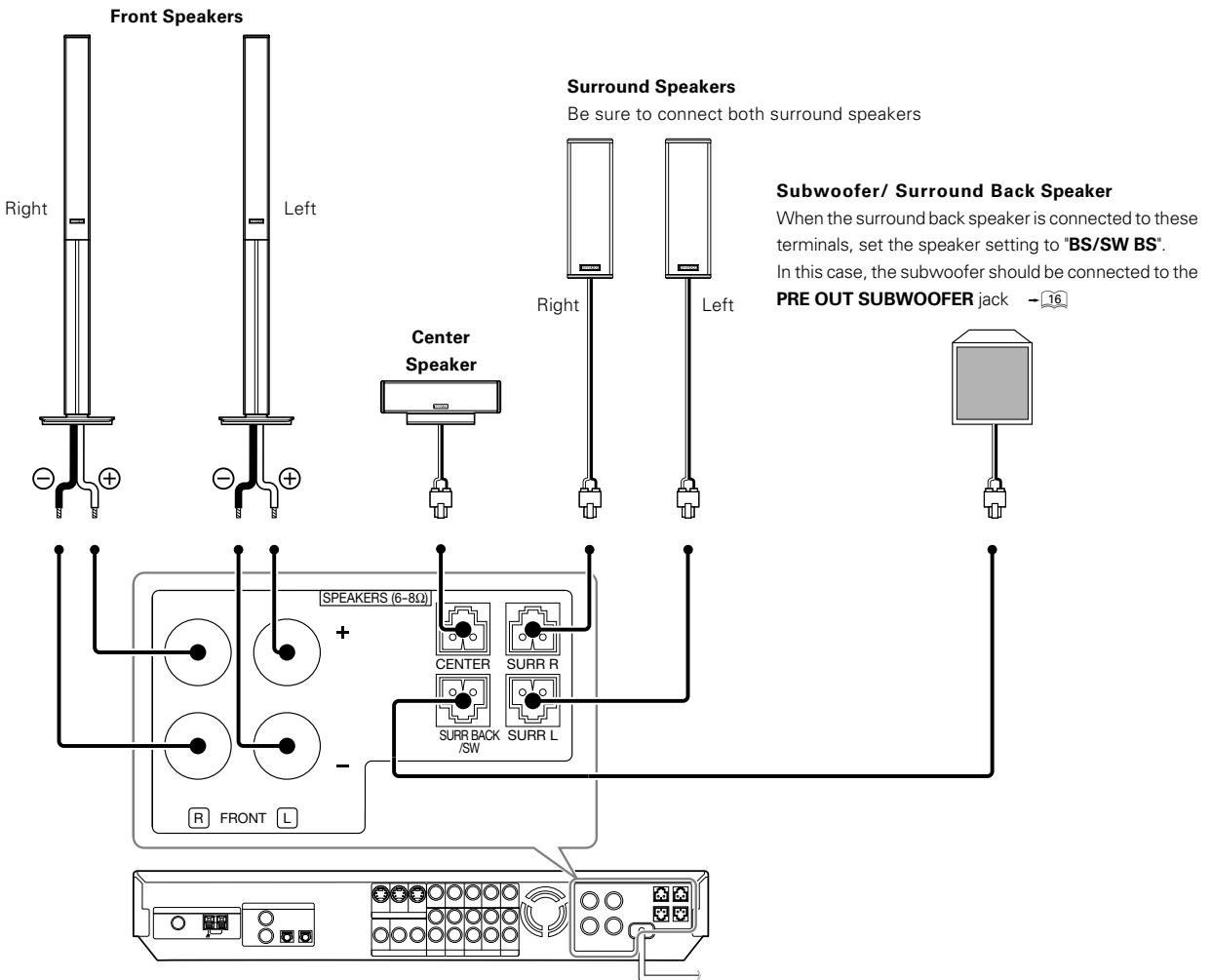

Connecting the speaker terminals

For U.S.A. and Canada

1 Strip coating.



Twist

2 Push the lever.

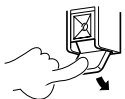

3 Insert the cord.

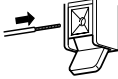

4 Return the lever.

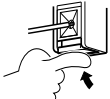

For Europe and Australia

1 Strip coating.

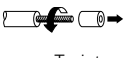

Twist

2 Loosen.



3 Insert.



4 Secure.



If the provided speaker cords are too short, they can be replaced with commercially available speaker cords [AWG24-18 standard (conductor section diameter 0.511 to 1.024 mm(0.02 to 0.04 in.))]. When using commercially available speaker cords, strip the vinyl coating on the end of each cord by about 1 cm (0.39 in.) and twist the conductor wires so that they are not disentangled.

Attaching the speaker cord connectors;

Connect each speaker cord by matching the color of the connector with that of the terminal to which the speaker cord is to be connected.

Connected speaker	Connector	Connected terminal
Center speaker	Green	CENTER
Surround speaker (Right)	Grey	SURR R
Surround speaker (Left)	Blue	SURR L
Surround back speaker or Subwoofer	Brown	SURR BACK/SW

While applying the projected part of the connector against a hard desktop, etc., insert the conductor sections of the speaker cord into the connector.

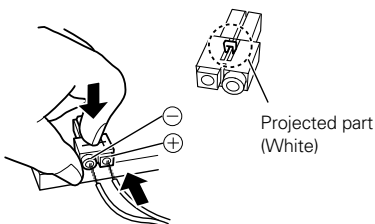

- After attaching the speaker cord connector, hold it and pull the speaker cord lightly to ensure that it will not come out.

Connect the connector to the terminal on the receiver with the same color by inserting the connector straight until it clicks.

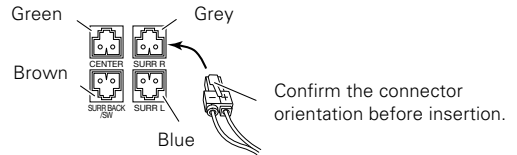

- Never short circuit the + and – speaker cords.
- If the left and right speakers are connected inversely or the speaker cords are connected with reversed polarity, the sound will be unnatural with ambiguous acoustic imaging. Be sure to connect the speakers correctly.

Speaker impedance

After confirming the speaker impedance indications printed on the rear panel of the receiver, connect speakers with matching impedance ratings. Using speakers with a rated impedance other than that indicated on the rear panel of the receiver could result in malfunctions or damage to the speakers or receiver.

Speaker placement

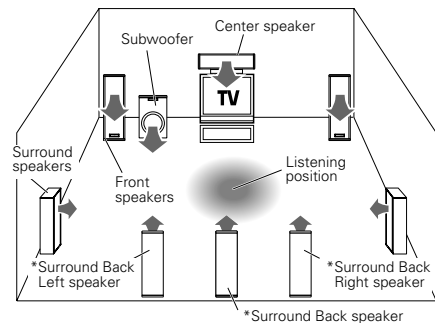

* For Surround Back speaker, you may place either two Surround Back speakers (Surround Back Left speaker and Surround Back Right speaker) for 7.1 channel surround sound system or one Surround Back speaker for 6.1 channel surround sound system.

Front speakers: Place the left and right speakers at each side of your TV. Angle the speakers towards the listening area to enhance the stereo effect.

Center speaker: Place the center speaker on the center between the front left and right speakers. Tilt the speaker upward or down-ward so that it is directly facing the listening area.

Surround speakers: Place the surround speakers as high as possible, either directly to the sides of the listening area or else slightly behind the listening area. Adjust the angles so that these speakers are facing directly towards the listeners.

Subwoofer: Usually, place the subwoofer in the front center position in the listening room, near one of the front speakers near the center speaker. (Since the subwoofer has less directivity than other speakers, it can be placed almost in any position that can offer the best low frequency reproduction according to the room layout.)

Surround back speakers: Place the surround back speaker behind the listening position, at the same height as the left and right surround speakers.

- Although the ideal surround system consists of all the speakers listed above, if you don't have a center speaker or a subwoofer, you can divide those signals between the available speakers in the speaker settings steps to obtain the best possible surround reproduction from the speakers you have available. → 24

PRE OUT connections

The receiver has additional **PRE OUT** jacks.

Note that the output from the **PRE OUT** jacks needs to be connected to an external power amplifier.

If you want to connect surround back speakers to these jacks, be always sure to connect two surround back speakers for the left and right.

● Connecting a speaker cord directly to a **PRE OUT** jack will not produce any sound from the speaker.

For U.S.A. and Canada

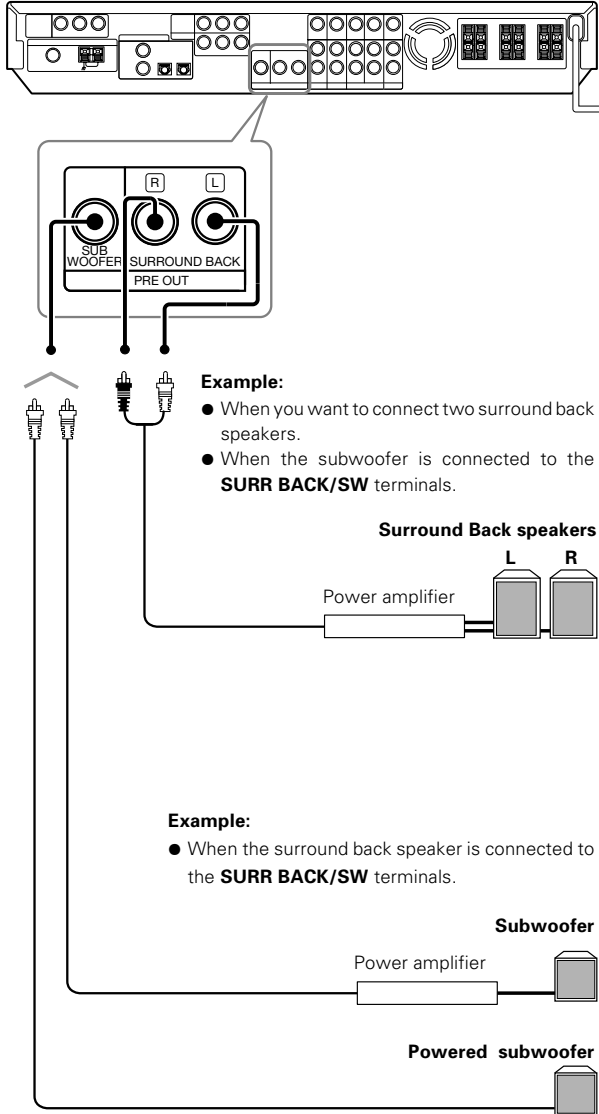

For Europe and Australia

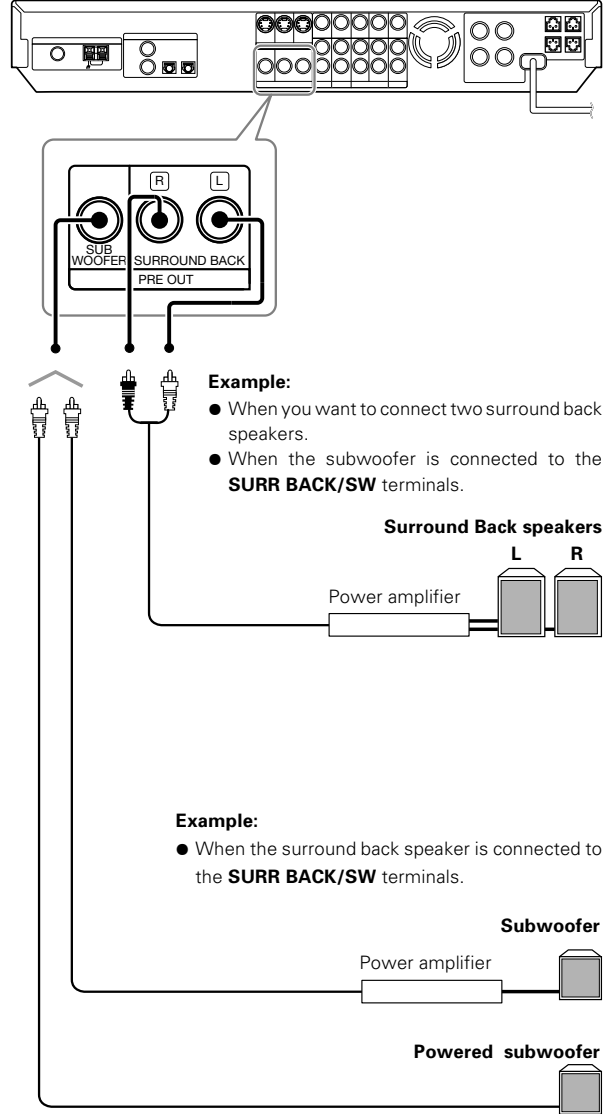

Connecting to the GAME jacks / FRONT AUX jacks

If you use a component that you do not usually connect to the receiver, such as a portable video camera, connect it to the **GAME** or **FRONT AUX** jacks on the front panel of the receiver. These jacks are particularly convenient when dubbing audio/video from a portable video camera.

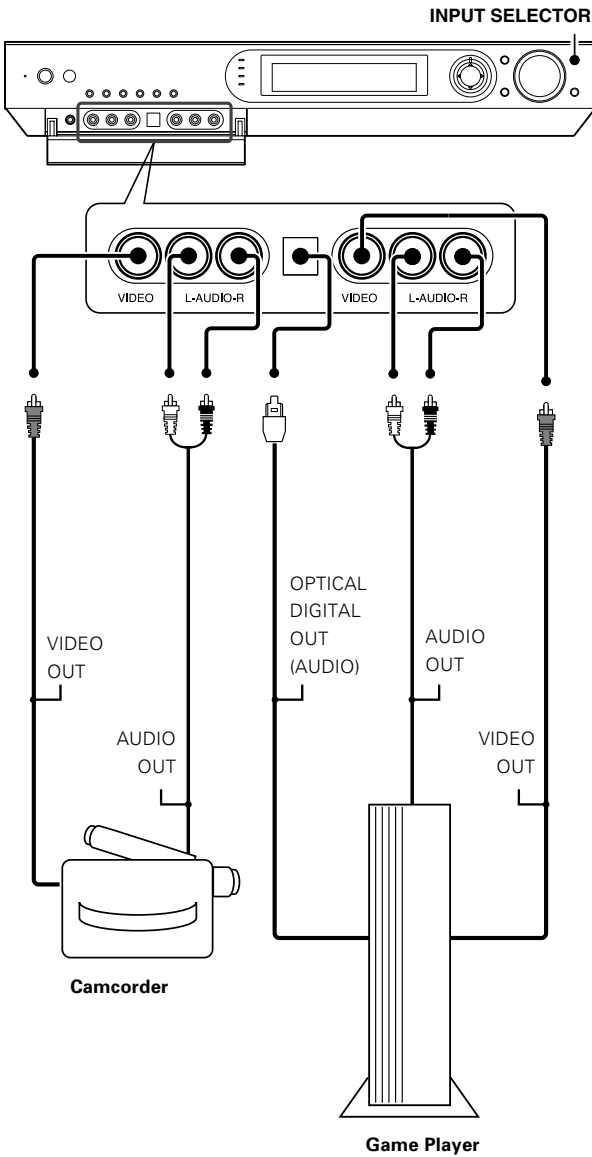

- The DIGITAL IN (OPTICAL) jack in the GAME jack section can be used for connection of digital audio input. This is convenient for playing a video game through the receiver. - 27

Connecting the antennas

AM loop antenna

The supplied loop antenna is for use indoors. Place it as far as possible from the receiver, TV set, speaker cords and power cord, and adjust the direction for best reception.

AM antenna terminal connections

- 1 Push lever.
- 2 Insert cord.
- 3 Release lever.

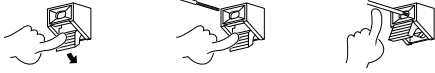

FM indoor antenna

The supplied indoor antenna is for temporary use only. For stable signal reception we recommend using an outdoor antenna. Disconnect the indoor antenna when you connect one outdoors.

FM antenna terminal connections Insert the connector.



(For the U.S.A. and Canada)

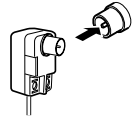

(For Europe and Australia)

FM outdoor antenna

Lead the 75Ω coaxial cable connected to the FM outdoor antenna into the room and connect it to the **FM 75Ω** terminal.

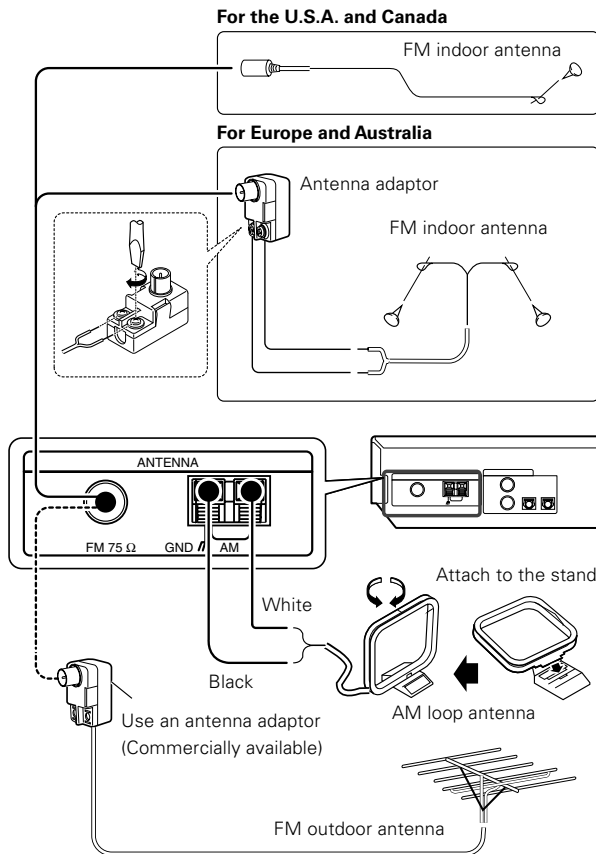

Preparing the remote control

Loading the batteries

❶ Remove the cover.



❷ Insert the batteries.

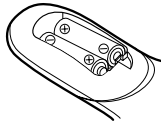

❸ Close the cover.



- Insert two AA-size (R6) batteries as indicated by the polarity markings.

Remote control operation

When the **STANDBY** indicator is lit, the power turns ON when you press the **POWER RCVR** on the remote control. When the power comes ON, press the key you want to operate.

Operating other component range

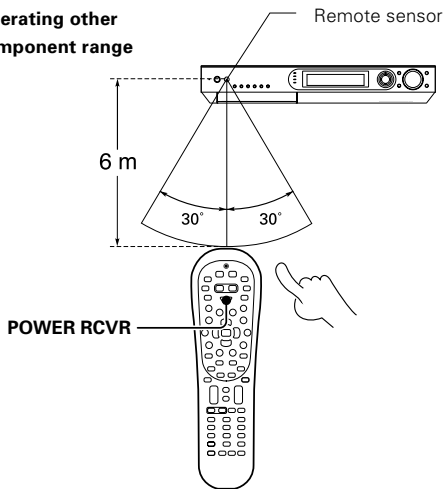

- When pressing more than one remote control key successively, press the keys securely by leaving an interval of 1 second or more between keys.

Notes

1. The supplied batteries may have shorter lives than ordinary batteries due to use during operation checks.
2. When the remote-controllable distance gets shorter than before, replace both batteries with new ones.
3. Placing the remote sensor in direct sunlight, or in direct light from a high frequency fluorescent lamp may cause a malfunction.
In such a case, change the location of the system installation to prevent malfunction.

STEP 1 Connect the speakers and TV to the receiver.

For details, see "Setting up the system" - [8] ~ - [17]

CAUTION

Make sure that the power cord plug is disconnected from the AC wall outlet before proceeding to speaker cord connections. If the conductor wires on the extremity of speaker cord are untwisted, there is a risk of short-circuiting. Be sure to twist them well before connecting the speaker cord.

Connection of speakers:

(A)	Front speakers (L,R)
(B)	Center speaker
(C)	Subwoofer
(D)	Surround speakers (L,R)
(E)	Surround back speaker

- If you want to connect two surround back speakers (LB and RB) to the **PRE OUT SURROUND BACK** jacks, see "PRE OUT connections". - [16]

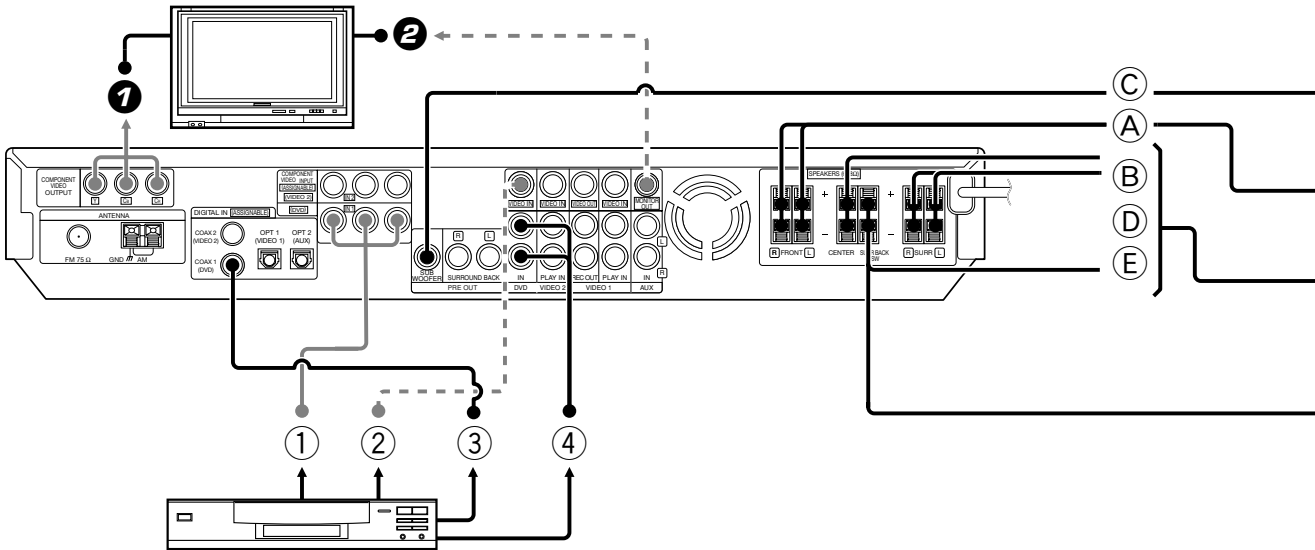
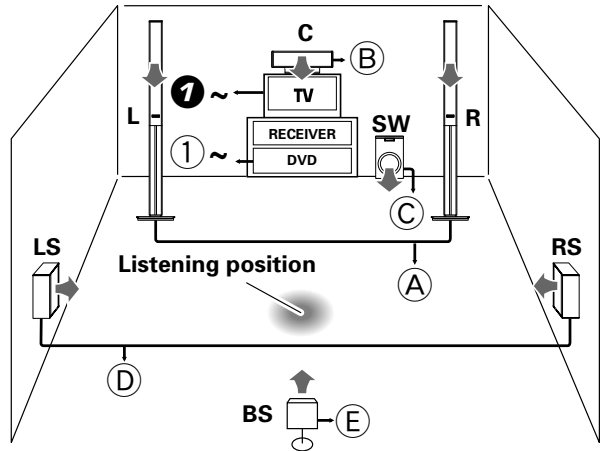

Connection of TV monitor:

①.....	Component video connection
②==	Composite video connection

- For the video input connection from the DVD player and the video output connection to the TV monitor, use either the component video or composite video connection for both of them.



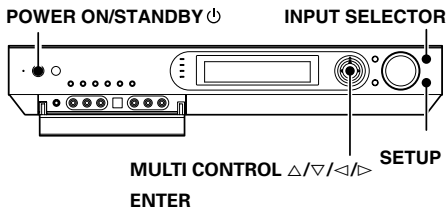

Connection of DVD player:

①.....	Component video connection
②==	Composite video connection
③	Digital audio connection (Coaxial cord)
④	Analog audio connection



STEP 2 Set up the speakers.



For details, see "Speaker settings" . -[24] ~ -[27]

- 1 Connect the power cord to the AC wall outlet and press .
- 2 Press , press  to select "SP SETUP" and press .

If you connect KENWOOD speaker system KS-2100HT, KS-3100EX, KS-708HT, KS-308HT, KS-708HT+KS-308EX, KS-308HT+ KS-308EX, KS-908HT or KS-908EX:

Press  to select the model of the connected speaker system and press .

"HTB1 6.1CH": Speaker system KS-3100EX.

"HTB1 5.1CH": Speaker system KS-2100HT.



"HTB2 6.1CH": SPEAKER SYSTEM KS-708HT+KS-308EX or KS-308HT+ KS-308EX.

"HTB2 5.1CH": Speaker system KS-708HT or KS-308HT.

"HTB3 6.1CH": Speaker system KS-908EX.

"HTB3 5.1CH": Speaker system KS-908HT.



Model availability may differ depending on the country and sales area.



If your selection is correct, press  to select "OK" and press . Now the speaker setup is complete. (Select "CANCEL" to return to the status before setup.)

- When the speaker setting is set to "HTB1 5.1CH", "HTB2 5.1CH" or "HTB3 5.1CH", the PL IIx, DTS-ES and DOLBY EX listen modes cannot be selected.

If you use another speaker system want a setup according to it:

Press  to select "CUSTOM" and press  to select each of the speaker setup items.

Press  to select the speaker setup item	Press  to select the setting for each item
SUBW	SUBW ON: A subwoofer is connected. SUBW OFF: No speaker is connected.
FRNT	Speaker size ? LRG: Relatively large-size speakers. NML: Normal-size speakers.
CNTR, SURR, BS	Speaker size ? LRG: Relatively large-size speakers. NML: Normal-size speakers. OFF: No speaker is connected.
BS/SW	BS/SW BS: A surround back speaker is connected to the SURR BACK/SW terminals. BS/SW SW: A subwoofer is connected to the SURR BACK/SW terminals. BS/SW OFF: No speaker is connected.

After completing the setup, press . If your selection is correct, press  to select "OK" and press .

Now the speaker setup is complete. (Select "CANCEL" to return to the status before setup.)

- When the speaker setting is set to "BS/SW OFF", the PL IIx, DTS-ES and DOLBY EX listen modes cannot be selected.
- More detailed settings such as the volume level of each speaker and distance to each speaker are also available. -[26] -[27]

STEP 3 Play a disc on the DVD player.

- 1 Press  to select "DVD".
- 2 Start playback of the DVD player.

For the operation, also refer to the instruction manual for your DVD player.

- You can select various listen modes to enjoy surround playback of various kinds of video software. -[40]

STEP 1 Connect the speakers and TV to the receiver.

For details, see "Setting up the system" - [8] ~ [17]

CAUTION

Make sure that the power cord plug is disconnected from the AC wall outlet before proceeding to speaker cord connections. If the conductor wires on the extremity of speaker cord are untwisted, there is a risk of short-circuiting. Be sure to twist them well before connecting the speaker cord.

Connection of speakers:

(A)	Front speakers (L,R)
(B)	Center speaker
(C)	Subwoofer
(D)	Surround speakers (L,R)
(E)	Surround back speaker

- If you want to connect two surround back speakers (LB and RB) to the **PRE OUT SURROUND BACK** jacks, see "PRE OUT connections" - [16]

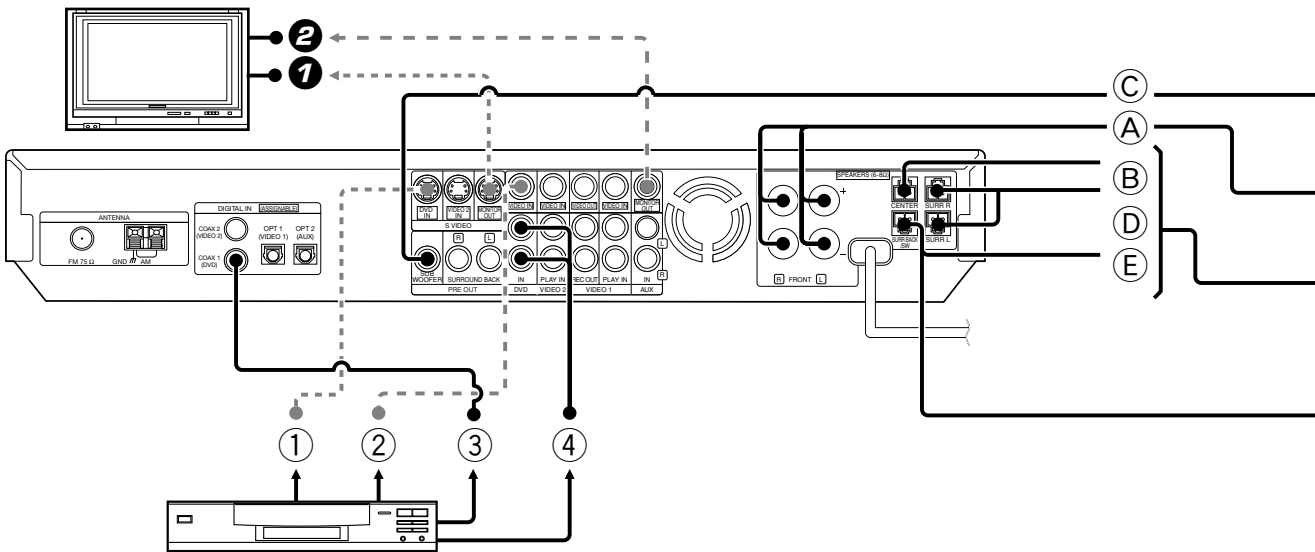
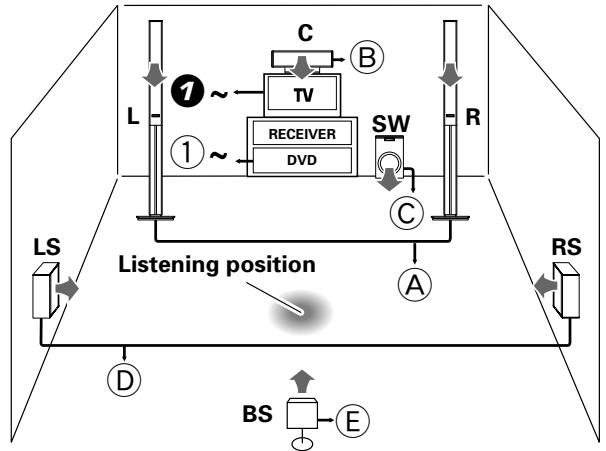

Connection of TV monitor:

①.....	S VIDEO connection
②==	Composite video connection

Connection of DVD player:

①.....	S VIDEO connection
②==	Composite video connection



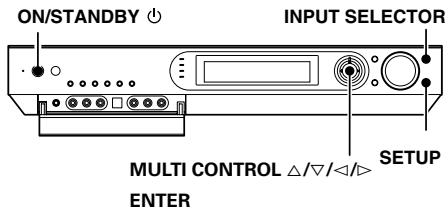

- For the video input connection from the DVD player and the video output connection to the TV monitor, use either the S VIDEO or composite video connection for both of them.

③	Digital audio connection (Coaxial cord)
④	Analog audio connection



STEP 2 Set up the speakers.



For details, see "Speaker settings" . -[24] ~ -[27]

- 1 Connect the power cord to the AC wall outlet and press .
- 2 Press , press  to select "SP SETUP" and press .

If you connect KENWOOD speaker system KS-2100HT, KS-3100EX, KS-708HT, KS-308HT, KS-708HT+KS-308EX, KS-308HT+KS-308EX, KS-908HT or KS-908EX:

Press  to select the model of the connected speaker system and press .

"HTB1 6.1CH": Speaker system KS-3100EX.

"HTB1 5.1CH": Speaker system KS-2100HT.



"HTB2 6.1CH": SPEAKER SYSTEM KS-708HT+KS-308EX or KS-308HT+KS-308EX.

"HTB2 5.1CH": Speaker system KS-708HT or KS-308HT.

"HTB3 6.1CH": Speaker system KS-908EX.

"HTB3 5.1CH": Speaker system KS-908HT.



Model availability may differ depending on the country and sales area.



If your selection is correct, press  to select "OK" and press . Now the speaker setup is complete. (Select "CANCEL" to return to the status before setup.)

- When the speaker setting is set to "HTB1 5.1CH", "HTB2 5.1CH" or "HTB3 5.1CH", the PL IIx, DTS-ES and DOLBY EX listen modes cannot be selected.

If you use another speaker system want a setup according to it:

Press  to select "CUSTOM" and press  to select each of the speaker setup items.

Press  to select the speaker setup item	Press  to select the setting for each item
SUBW	SUBW ON: A subwoofer is connected. SUBW OFF: No speaker is connected.
FRNT	Speaker size ? LRG: Relatively large-size speakers. NML: Normal-size speakers.
CNTR, SURR, BS	Speaker size ? LRG: Relatively large-size speakers. NML: Normal-size speakers. OFF: No speaker is connected.
BS/SW	BS/SW BS: A surround back speaker is connected to the SURR BACK/SW terminals. BS/SW SW: A subwoofer is connected to the SURR BACK/SW terminals. BS/SW OFF: No speaker is connected.

After completing the setup, press . If your selection is correct, press  to select "OK" and press .

Now the speaker setup is complete. (Select "CANCEL" to return to the status before setup.)

- When the speaker setting is set to "BS/SW OFF", the PL IIx, DTS-ES and DOLBY EX listen modes cannot be selected.
- More detailed settings such as the volume level of each speaker and distance to each speaker are also available. -[26] -[27]

STEP 3 Play a disc on the DVD player.

- 1 Press  to select "DVD".
- 2 Start playback of the DVD player.

For the operation, also refer to the instruction manual for your DVD player.

- You can select various listen modes to enjoy surround playback of various kinds of video software. -[40]

Preparing for playback

Speaker settings

To enable you to obtain optimum enjoyment from the receiver's listening modes, make sure to complete the speaker settings (subwoofer, front, center, surround and surround back speakers) as described below.

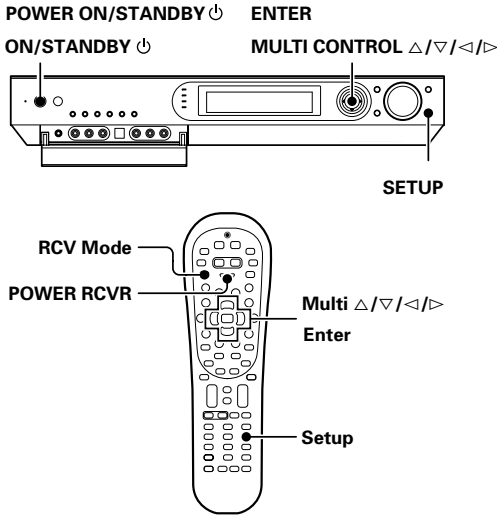

1 Turn on the power to this receiver by pressing the **POWER ON/STANDBY** (For U.S.A. and Canada) or **ON/STANDBY** (For Europe and Australia) key (or **POWER RCVR** key).

2 If you want to use the remote control unit, press the **RCV Mode** key on the remote to set it to the receiver control mode.

3 Initiate the setup mode.

- 1 Press the **SETUP** key (or the **Setup** key).
- 2 Use the **MULTI CONTROL** (or the **Multi**) keys for the following displays.

- 1 "SP SETUP"
- 2 "SP LEVEL"
- 3 "DISTANCE"
- 4 "ASSIGN."
- 5 "LFE LEVEL"
- 6 "GAME FUNC"
- 7 "EXIT"

While the main setup screen is displayed, the setup mode can be canceled by pressing the **SETUP** key (or the **Setup** key) or selecting "EXIT" and then pressing the **ENTER** (or the **Enter** key).

4 Select the setup method.

- 1 Select "SP SETUP" and press the **ENTER** key (or the **Enter** key) to select the speaker setup method.

2 Use the **MULTI CONTROL** (or the **Multi**) keys for the following displays.

- 1 "HTB1 6.1CH": Select "HTB1 6.1CH" if you use speaker system KS-3100EX. *
- 2 "HTB1 5.1CH": Select "HTB1 5.1CH" if you use speaker system KS-2100HT. *
- 3 "HTB2 6.1CH": Select "HTB2 6.1CH" if you use speaker system KS-708HT+KS-308EX or KS-308HT+KS-308EX. *
- 4 "HTB2 5.1CH": Select "HTB2 5.1CH" if you use speaker system KS-708HT or KS-308HT. *
- 5 "HTB3 6.1CH": Select "HTB3 6.1CH" if you use speaker system KS-908EX. *
- 6 "HTB3 5.1CH": Select "HTB3 5.1CH" if you use speaker system KS-908HT. *
- 7 "CUSTOM": Select to set up the speakers according to the speaker system in use. (Speaker setup is required every time after the speaker system is changed.)
- 8 "EXIT": Press the **ENTER** (or the **Enter** key) again to return to the main setup displays.

* Model availability may differ depending on the country and sales area.

When the 5.1 channel speaker system configuration is used or the speaker setting is set to "BS/SW OFF", the PL IIx, DTS-ES and DOLBY EX listen modes cannot be selected.

If you selected "HTB1 6.1CH", "HTB1 5.1CH", "HTB2 6.1CH", "HTB2 5.1CH", "HTB3 6.1CH" or "HTB3 5.1CH" in the above:

Press **ENTER** (or the **Enter** key), then press **MULTI CONTROL** (or the **Multi**) key to select "OK", and press **ENTER** (or the **Enter** key) again to establish the setup.

- Select "CANCEL" to return to the status before setup.
- When you use a KENWOOD speaker system and select "HTB1 6.1CH", "HTB1 5.1CH", "HTB2 6.1CH", "HTB2 5.1CH", "HTB3 6.1CH" or "HTB3 5.1CH" set the speaker setup, the audio will be corrected automatically according to the speaker characteristics.

If you selected "CUSTOM" in the above:

Press **ENTER** (or the **Enter** key) to proceed to detailed setups.

The flow of the SETUP is as follows;

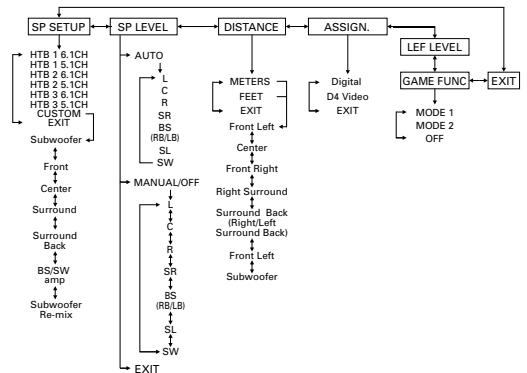

- The subwoofer setting indication "SUBW" appears.

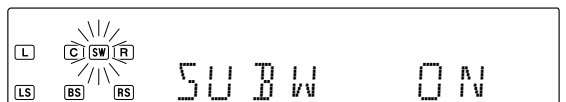

Continued to next page

5 Select a speaker system.

1 Use the MULTI CONTROL Δ / ∇ (or the Multi Δ / ∇ keys) to select the appropriate subwoofer setting.

- ① "SUBW ON" :
When a subwoofer is connected.
- ② "SUBW OFF" :
When no subwoofer is connected.
- The initial setting is "SUBW ON".
- When "SUBW OFF" is selected and the selection is established by pressing MULTI CONTROL \triangleright (or the Multi \triangleright key) in step 2 below, the front speakers are set automatically to "FRNT LRG" and the procedure jumps to step 3.

2 Use the MULTI CONTROL \triangleright (or the Multi \triangleright key) to accept the setting.

- The front speakers setting indication "FRNT" appears.

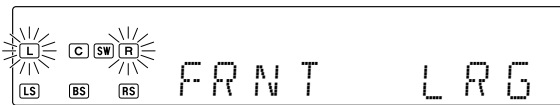

3 Use the MULTI CONTROL Δ / ∇ (or the Multi Δ / ∇ keys) to select the appropriate front speakers setting.

- ① "FRNT LRG" :
Large front speakers are connected to the receiver.
- ② "FRNT NML" :
Average size front speakers are connected to the receiver.
- When the subwoofer setting is "SUBW ON", front speakers setting is "FRNT LRG" and a stereo source is played, the low frequencies may be reproduced through the front speakers and no audio output from the subwoofer in certain listen modes. In this case, set the subwoofer remix setting in step 10 to "REMIX ON" to output the low frequencies from the subwoofer.

4 Use the MULTI CONTROL \triangleright (or the Multi \triangleright key) to accept the setting.

- The center speaker setting indication "CNTR" appears.

5 Use the MULTI CONTROL Δ / ∇ (or the Multi Δ / ∇ keys) to select the appropriate center speaker setting.

If you selected "FRNT LRG" as the front speakers setting:

- ① "CNTR LRG" :
A large center speaker is connected to the receiver.
- ② "CNTR NML" :
An average size center speaker is connected to the receiver.
- ③ "CNTR OFF" :
When no center speaker is connected.

If you selected "FRNT NML" as the front speakers setting:

- ① "CNTR NML" :
Average size front speakers are connected to the receiver.
- ② "CNTR OFF" :
When no center speaker is connected.

6 Use the MULTI CONTROL \triangleright (or the Multi \triangleright key) to accept the setting.

- The surround speaker setting indication "SURR" appears.

7 Use the MULTI CONTROL Δ / ∇ (or the Multi Δ / ∇ keys) to select the appropriate surround speaker setting.

- ① "SURR LRG" :
Large surround speakers are connected to the receiver.
- ② "SURR NML" :
Average size surround speakers are connected to the receiver.
- ③ "SURR OFF" :
When no surround speakers are connected.
- When "SURR OFF" is selected and the selection is established by pressing MULTI CONTROL \triangleright in step 8 below, the procedure jumps to step 13. However, if the subwoofer setting is "SUBW OFF", the procedure jumps to step 14 so that you can complete the speaker setup and proceed to the speaker volume level adjustment in step 14.

8 Use the MULTI CONTROL \triangleright (or Multi \triangleright key) to accept the setting.

- The surround back speaker setting indication "BS" appears.

9 Use the MULTI CONTROL Δ / ∇ (or the Multi Δ / ∇ keys) to select appropriate surround back speaker setting.

If you selected "SURR LRG" as the surround speaker setting :

- ① "BS LRG" :
Large surround back speaker is connected to the receiver.
- ② "BS NML" :
Average size surround back speaker is connected to the receiver.
- ③ "BS OFF" :
When no surround back speakers is connected.

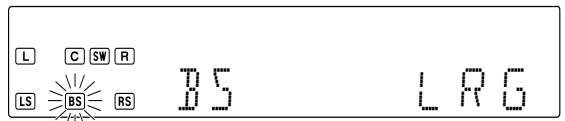

If you selected "SURR NML" as the surround speaker setting :

- ① "BS NML" :
Average size surround back speaker is connected to the receiver.
- ② "BS OFF" :
When no surround back speakers is connected.

10 Use the MULTI CONTROL \triangleright (or the Multi \triangleright key) to accept the setting.

- The surround back speaker and subwoofer setting mode indication "BS/SW" appears.

11 Use the MULTI CONTROL Δ / ∇ (or the Multi Δ / ∇ keys) to select the appropriate BS/SW amp setting.

➔ ① "BS/SW BS":

Select this setting when a surround back speaker is connected to the **SURR BACK/SW** terminals. In this case, the subwoofer signal will be output from the **PRE OUT SUBWOOFER** jack.

➔ ② "BS/SW SW":

Select when the subwoofer speaker is connected to the **SURR BACK/SW** terminals. In this case, the surround back signals will be output from the **PRE OUT SURROUND BACK** jacks.

➔ ③ "BS/SW OFF":

Select when no speaker is connected to the **SURR BACK/SW** terminals. In this case, the subwoofer signal will be output from the **PRE OUT SUBWOOFER** jack and the surround back signals will be output from the **PRE OUT SURROUND BACK** jacks.

- If "BS/SW BS" is selected, only one surround back speaker can be connected to the receiver.
- If "BS/SW SW" or "BS/SW OFF" is selected, two surround back speakers can be connected to the **PRE OUT SURROUND BACK** jacks through an external power amplifier. -[16]

12 Use the MULTI CONTROL \triangleright (or the Multi \triangleright key) to accept the setting.

- The subwoofer re-mix setting indication "REMIX" appears.

13 Use the MULTI CONTROL Δ / ∇ (or the Multi Δ / ∇ keys) to select the appropriate subwoofer re-mix setting.

If "REMIX ON" is selected as the subwoofer re-mix setting, the low frequencies are enhanced by adding the low frequencies of other channels to the subwoofer channel or adding the low frequencies of the subwoofer to other channels depending on the speaker setup.

➔ ① "REMIX ON":

Subwoofer re-mix setting mode to the receiver is ON.

➔ ② "REMIX OFF":

Subwoofer re-mix setting mode to the receiver is OFF.

- The initial setting is "REMIX ON".
- The subwoofer re-mix setting is possible only when the subwoofer setting is "SUBW ON" and the front speaker setting is "FRNT LRG".

14 Press ENTER (or the Enter key). If your selection is correct, press MULTI CONTROL Δ / ∇ (or the Multi Δ / ∇ key) to select "OK".

Press the ENTER (or the Enter key) again to return to the main setup displays.

- Select "CANCEL" and press the **ENTER** (or the **Enter** key) to return to the status before setup.
- In steps 5 and 7, indications appear only for the selected channels of the speakers that require adjusting.

5 Adjust the speaker volume level.

From your usual listening position, adjust the volume levels. The volume levels from each speaker should be the same.

1 Use the MULTI CONTROL \triangleleft / \triangleright (or the Multi \triangleleft / \triangleright keys) to select "SP LEVEL" on setup displays, and press the ENTER (or the Enter key).

2 Use the MULTI CONTROL \triangleleft / \triangleright (or the Multi \triangleleft / \triangleright keys) to select "AUTO", "MANUAL" or "OFF".

➔ ① "AUTO": Select this setting to adjust the speaker volume levels using the test tone. The test tone will be output from every speaker channel in automatic sequence.

➔ ② "MANUAL": Select to select the speaker channel to output the test tone using **MULTI CONTROL \triangleleft / \triangleright** (or the **Multi \triangleleft / \triangleright** key).

➔ ③ "OFF": Select to adjust the speaker volume levels using the current output signals. The speaker channel to output the output signal can be selected using **MULTI CONTROL \triangleleft / \triangleright** (or the **Multi \triangleleft / \triangleright** key).

➔ ④ "EXIT": Press the **ENTER** (or the **Enter** key) again to return to the main setup displays.

When "AUTO" or "MANUAL" is selected and ENTER (or the Enter key) is pressed again, the test tone output will start.

Use the MULTI CONTROL Δ / ∇ (or the Multi Δ / ∇ keys) to adjust the volume level of the test tone output from the speaker channel to be adjusted.

For "AUTO" selection, the first test tone is heard from the front left speaker for 2 seconds. The next test tone is heard from the speakers in the following sequence for 2 seconds each.

When the "BS/SW BS" has been selected:

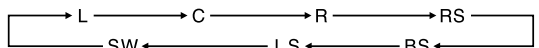

When the "BS/SW SW" or "BS/SW OFF" has been selected:

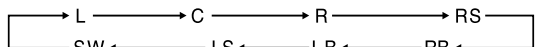

The channel indication blinks while the test tone is being output.

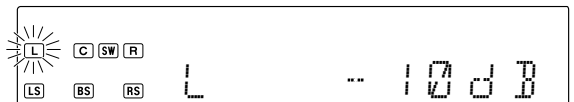

- If you change the volume level settings for the speakers while listening to music, the settings referred to on this page are also changed. -[42]
- If the speaker setting selects are OFF, the speaker level settings are reset.

When "MANUAL" or "OFF" is selected, press MULTI CONTROL \triangleleft / \triangleright (or the Multi \triangleleft / \triangleright key) to select the speaker channel and then press MULTI CONTROL Δ / ∇ (or the Multi Δ / ∇ key) to adjust the speaker volume level.

3 Press the ENTER (or the Enter key) again to return to the main setup displays.

- The test tone is turned off and return to the main setup displays.

7 *Input the distance to the speakers.*

This setting allows the signals output from different speakers to reach the listening position simultaneously.

Measure the distance from the listening position to each of the speakers.

Jot down the distance to each of the speakers.

- Distance to Front speaker (L) : ___ feet (meters)
- Distance to Center speaker (C) : ___ feet (meters)
- Distance to Front speaker (R) : ___ feet (meters)
- Distance to Surround speaker (RS) : ___ feet (meters)
- Distance to Surround back speaker (RB) : ___ feet (meters)
- Distance to Surround back speaker (LB) : ___ feet (meters)
- Distance to Surround speaker (LS) : ___ feet (meters)
- Distance to Subwoofer (SW) : ___ feet (meters)

1 Use the **MULTI CONTROL** </> (or the **Multi** </> keys) to select **"DISTANCE"** on setup displays, and press the **ENTER** (or the **Enter** key).

2 Use the **MULTI CONTROL** </> (or the **Multi** </> key) to select the unit and press **ENTER** (or the **Enter** key).

- ① "METERS"
- ② "FEET"
- ③ "EXIT": Press the **ENTER** (or the **Enter** key) again to return to the main setup displays.

3 Use the **MULTI CONTROL** </> (or the **Multi** </> keys) to select the speakers and the **MULTI CONTROL** Δ / ▽ (or the **Multi** Δ / ▽ keys) to adjust the distance to the front speakers.

The speaker indicator to be adjusted blinks.
 • The speakers you have selected should appear on the display. Confirm that all the speakers have been correctly selected.



Indication in meters

- The allowable setting range is 1 to 30 feet (0.3 to 9.0 m), adjustable in 1 foot (0.3 m) increments.

4 Repeat steps **3** to input the distance for each of the speakers.

5 Press the **ENTER** (or the **Enter** key) again to return to the main setup displays.

8 *Adjust the LFE LEVEL (Low Frequency Effects level)*

Adjust the level of the low-frequency fields effect (LFE) signal, which is the signal used exclusively for giving the field effect of bass tone, in the Dolby Digital or DTS signal.

1 Use the **MULTI CONTROL** </> (or **Multi** </> keys) to select **"LFE LEVEL"** on setup displays, and press the **ENTER** (or the **Enter** key).

2 Use the **MULTI CONTROL** Δ / ▽ (or **Multi** Δ / ▽ keys) to adjust the LFE LEVEL.

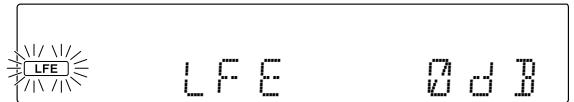

- The LFE LEVEL is adjusted from 0dB to -10dB in 1dB step decrements.

3 Press the **ENTER** (or the **Enter** key) again to return to the main setup displays.

9 *Set up the GAME jacks on the front panel.*

Perform the setup for convenience of playing a video game using the receiver.

1 Use the **MULTI CONTROL** </> (or **Multi** </> keys) to select **"GAME FUNC"** on setup displays, and press the **ENTER** (or the **Enter** key).

2 Press **MULTI CONTROL** Δ / ▽ (or the **Multi** Δ / ▽ key) to select the game mode.

- ① "MODE 1" :
When the connected game machine is turned ON, the input selector is switched automatically to "GAME". In addition, the ACTIVE EQ function is switched to "EQ GAME" and the listen mode is switched to the appropriate mode for games.
- ② "MODE 2" :
When the connected game machine is turned ON, the input selector is switched automatically to "GAME".
- ③ "OFF" :
The game mode is switched OFF.

- The game mode is not activated if no video signal is input to the **VIDEO** jack in the **GAME** jack section.
- The game mode is not activated when the DUAL SOURCE function is switched ON. → (30)

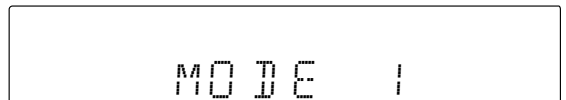

3 Press the **ENTER** (or the **Enter** key) again to return to the main setup displays.

Input level adjustment (analog sources only)

If the input level of an analog source signal is too high, the "CLIP" indicator will light up to indicate the source signal. Adjust the input level.

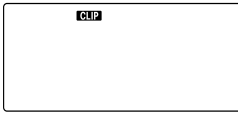

- ➊ Press the RCV Mode key on the remote control unit to set it to the receiver control mode.
- ➋ Press the Sound key.
- ➌ Use the MULTI CONTROL </> (or the Multi </> keys) to select "INPUT", and press the ENTER (or the Enter key).
- ➍ Use the MULTI CONTROL Δ / ▽ (or the Multi Δ / ▽ keys) to adjust the input level.

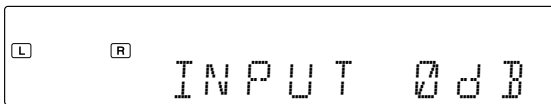

- The adjustment mode is displayed for approximately 20 seconds.
 - The input level may be adjusted to any one of three settings: 0dB, -3dB, and -6dB. (The initial setting is 0dB.)
 - You can store a separate input level for each input selector.
- ➎ Press the Sound key again to return to the input indication.

Re-assignment of rear panel jacks

The assignment of the input selector positions to the digital audio and component video input jacks can be changed as desired.

- ➊ Press the SETUP key (or the Setup key).
- ➋ Use the MULTI CONTROL </> (or the Multi </> keys) to select "ASSIGN." on setup displays, and press the ENTER (or the Enter key).
- ➌ Use the MULTI CONTROL </> (or Multi </> keys) to select "DIGITAL" or "COMPONENT VIDEO", and press the ENTER (or the Enter key).

- ➍ ① "DIGITAL": Select to change the assignment of the digital audio input jacks of the receiver.
 - ➍ ② "COMPONENT VIDEO"*: Select to change the assignment of the component video input jacks of the receiver.
 - ➍ ③ "EXIT": Press the ENTER (or the Enter key) again to return to the main setup displays.
- * For U.S.A. and Canada only.

- ➍ ④ Press MULTI CONTROL </> (or the Multi </> key) to select the input jack name and then press MULTI CONTROL Δ / ▽ (or the Multi Δ / ▽ key) to select the input selector position.

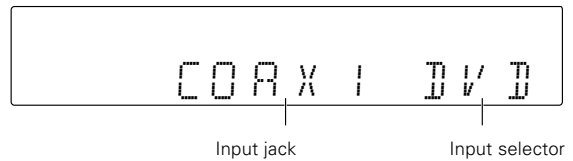

When the "DIGITAL" has been selected :

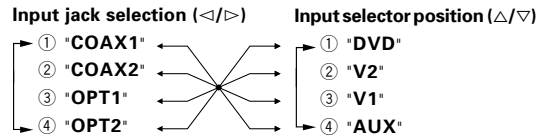

When the "COMPONENT" has been selected :

(For U.S.A. and Canada only)

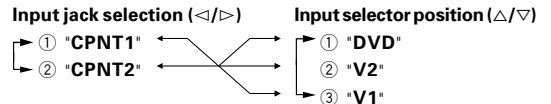

Use the following table for your memorandum.

Jack name	Assigned input selector
COAX1 (DVD)	
COAX2 (VIDEO 2)	
OPT1 (VIDEO 1)	
OPT2 (AUX)	
COMPONENT VIDEO INPUT IN1 (DVD)	
COMPONENT VIDEO INPUT IN2 (VIDEO 2)	

- It is not permitted to assign two input selector positions for one input jack. In this case, you will have to assign different input selector positions again.

- ➍ ⑤ Repeat step ➍ until you have assigned the desired jacks to the desired input selector positions.
- ➍ ⑥ Press the ENTER (or the Enter key) again to return to the main setup displays.

Normal playback

Some preparatory steps are needed before starting playback.

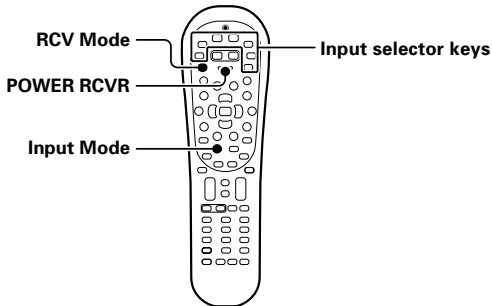
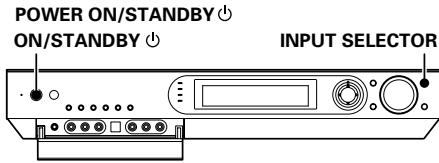

Turning on the receiver

- 1 Turn on the power to the related components.
- 2 Turn on the power to this receiver by pressing the **POWER ON/STANDBY** or **ON/STANDBY** key (or the **POWER RCVR** key).

Selecting the input mode

If you have selected a component connected to the **COAX 1 (DVD)**, **COAX 2 (VIDEO 1)**, **OPT 1 (VIDEO 2)**, **OPT 2 (AUX)** or **DIGITAL IN (OPTICAL)** jacks, make sure that the input mode setting is correct for the type of audio signal to be used. → 8

Listening to a source component

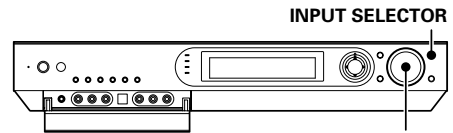

VOLUME CONTROL

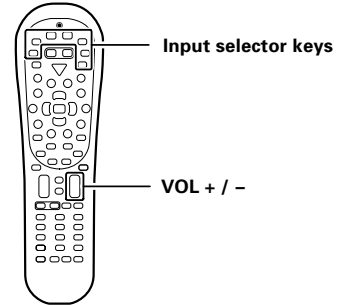

- 1 Press the **INPUT SELECTOR** key (or the **Input selector keys/ DVD, VID1, VID2, AUX, F.AUX, Game, TUNER**) to select the source you want to listen to.

- 1 Tuner (FM/AM broadcast reception)
- 2 "DVD"
- 3 "VIDEO1"
- 4 "VIDEO2"
- 5 "GAME"
- 6 "FRONT AUX"
- 7 "AUX"

- 2 Start playback from the selected source.

- 3 Use the **VOLUME CONTROL** knob (or the **VOL +/-** keys) to adjust the volume.

Listening with headphones

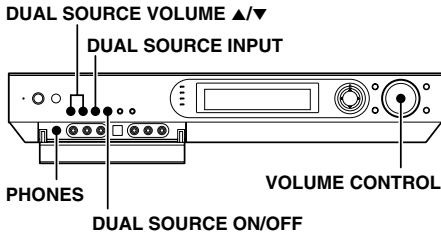

- 1 Connect headphones to the PHONES jack.



- 2 Use the VOLUME CONTROL knob (or the VOL +/- keys) to adjust the volume.

Playing different sources through speakers and headphones (DUAL SOURCE function)

While you enjoy audio listening through the speakers, another person can enjoy another source (audio + video) through headphones by connecting the source to the GAME or FRONT AUX jacks.

- 1 Connect headphones to the PHONES jack.
- 2 Press the DUAL SOURCE ON/OFF key to switch the DUAL SOURCE function ON.
 - When the DUAL SOURCE function is ON, the video and headphone outputs reproduce only the second input source of the DUAL SOURCE function. Switching the DUAL SOURCE function OFF restores the main input source signals at these outputs.

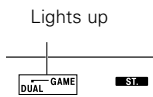

- 3 Press the DUAL SOURCE INPUT key to select the second input source for the DUAL SOURCE function.
 - 1 "GAME" :
The "GAME" input is selected as the second input source for the DUAL SOURCE function.
 - 2 "F. AUX" :
The "F. AUX" input is selected as the second input source for the DUAL SOURCE function.

- 4 Press the DUAL SOURCE VOLUME ▲ / ▼ to adjust the headphone listening volume.
 - When the DUAL SOURCE function is switched ON, the input mode is fixed at "ANALOG". The listen mode cannot be changed. → 8 → 40

Adjusting the sound

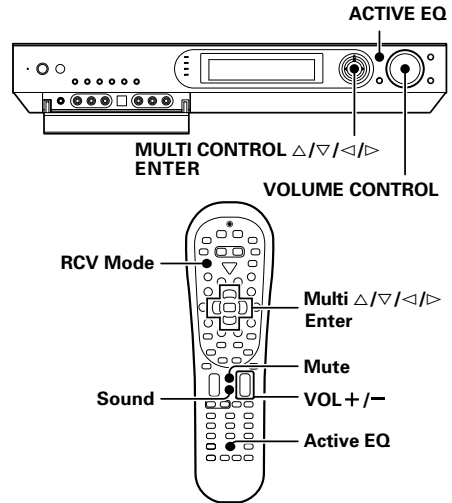

Adjusting the TONE (PCM stereo and analog stereo mode only)

- 1 Press the RCV Mode key on the remote control unit to set it to the receiver control mode.
- 2 Press the Sound key.
- 3 Use the MULTI CONTROL ◀ / ▶ (or the Multi ◀ / ▶ keys) to select "TONE", and press the ENTER (or the Enter key).
- 4 Use the MULTI CONTROL ▲ / ▼ (or the Multi ▲ / ▼ keys) to select "TONE ON", and press the ENTER (or the Enter key).

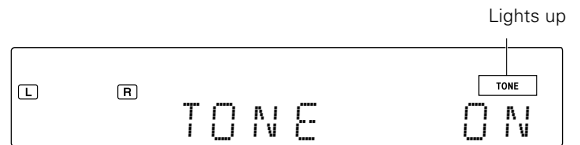

- 5 Use the MULTI CONTROL ◀ / ▶ (or the Multi ◀ / ▶ keys) to select "BASS" or "TREBLE".
 - 1 "BASS" :
Select this to adjust the low frequency range.
 - 2 "TREBLE" :
Select this to adjust the high frequency range.
- 6 Use the MULTI CONTROL ▲ / ▼ (or the Multi ▲ / ▼ keys) to adjust the sound quality.

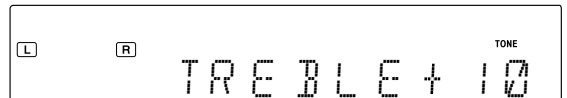

- 7 Repeat steps 5 and 6 as required.
 - The bass and treble levels are adjustable from -10 to +10 in 2 step increments.
 - The adjustment item is displayed for approximately 20 seconds.
- 8 Press the Sound key again to return to the input indication.

ACTIVE EQ mode

You can enjoy a more impressive sound effect when ACTIVE EQ is turned ON.

Press the **ACTIVE EQ** key (or the **Active EQ** key) for the following selections:

- ① **"EQ MUSIC"** : (The **"ACTIVE EQ"** indicator lights up)
Effective when listening to music.
- ② **"EQ CINEMA"** : (The **"ACTIVE EQ"** indicator lights up)
Effective when watching a movie.
- ③ **"EQ GAME"** : (The **"ACTIVE EQ"** indicator lights up)
Effective when playing a game.
- ④ **"EQ OFF"** : (The **"ACTIVE EQ"** indicator goes off)
The ACTIVE EQ function is turned OFF.

- The ACTIVE EQ function is not available in when the REC MODE or virtual mode is ON.

Muting the sound

The **Mute** key lets you mute the sound of the speakers or headphones.

Press the Mute key.

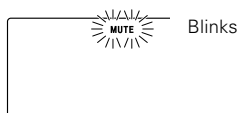

To cancel

Press the Mute key again so that the **"MUTE"** indicator goes off.

- MUTE ON can also be deactivated by turning the **VOLUME CONTROL** knob or pressing the **VOL +/-** keys.

Recording

Analog sources

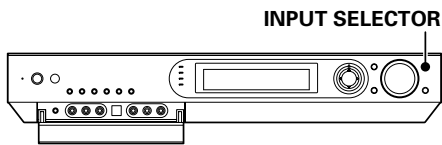

- 1 Use the **INPUT SELECTOR** key (or the input selector key) to select the source (other than "VIDEO 1") you want to record.
- 2 Put the component connected to the **VIDEO 1** jacks to the record-pause mode.
- 3 Start playback, then start recording.
 - Recording may not be normal for some video software. This is due to the copy guard condition. 

Digital sources

Switch on the **REC MODE** to record a digital input source. When the digital mode changes during recording in the **REC MODE**, the audio signal may be interrupted momentarily.

Recording music in REC mode

When a multi-channel source such as the Dolby Digital or DTS input signal is recorded in **REC mode**, the signal in the current surround mode can be recorded down-mixed to 2-channel.

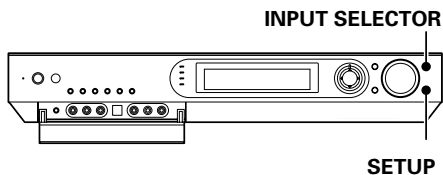

- 1 Use the **INPUT SELECTOR** key (or the Input Selector keys) to select the source (DVD, VIDEO 2, AUX, GAME) you want to record.
- 2 Put the component connected to the **VIDEO 1** jacks to the record-pause mode.
- 3 Press and hold the **SETUP** key (or Setup key) for more than 2 seconds to select the "**REC MODE**".
 - 1 **REC mode off**
 - 2 ***REC MODE*: REC mode on**

Multi-channel digital signals (DTS or Dolby Digital) are down-mixed to 2-channel before being output from the analog recording (REC OUT) jacks.

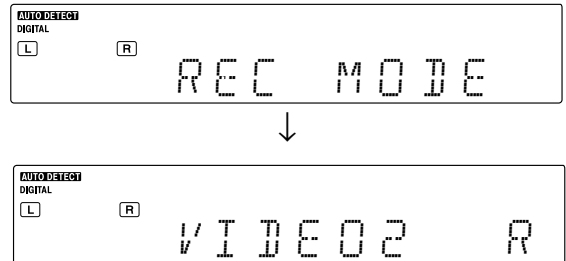

The display switches automatically.

- 4 Start playback, then start recording.

Listening to radio broadcasts

The receiver can store up to 40 stations in the memory and recall them by one-touch operation. Radio stations can be classified into RDS (Radio Data System) stations and other stations. To listen to or store RDS stations in the preset memory see "Using RDS (Radio Data System) (For Europe)". → 35

Tuning (non-RDS) radio stations

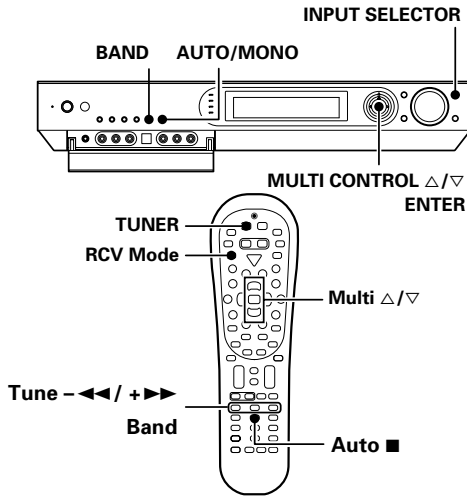

- 1** Use the **INPUT SELECTOR** key (or the **TUNER** key) to select the tuner.
- 2** Use the **BAND** key (or the **Band** key) to select the desired broadcast band.

Each press switches the band.



- 3** Use the **AUTO/MONO** key (or the **Auto ■** key) to select the desired tuning method.

Each press switches the tuning method to either auto or manual tuning.

- ① Auto tuning:
The "AUTO" indicator lights up
- ② Manual tuning:
The "AUTO" indicator goes off

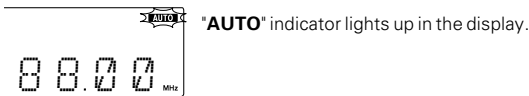

- Normally, set to "AUTO" (auto tuning). If the radio waves are weak and there is a lot of interference, switch to manual tuning. (With manual tuning, stereo broadcasts will be received in monaural.)

- 4** Use the **MULTI CONTROL** Δ/∇ (or **Multi** Δ/∇ keys, **Tune +/-** keys) to select the station.

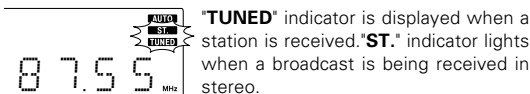

Auto tuning:

The next station is tuned automatically.

Manual tuning:

Use the **MULTI CONTROL** Δ/∇ (or **Multi** Δ/∇) to select the desired station.

Presetting radio stations

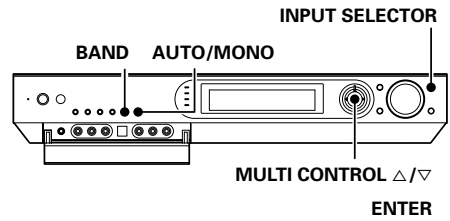

Collective presetting of stations

(For U.S.A., Canada and Australia)

- 1** Use the **INPUT SELECTOR** key (or the **TUNER** key) to select the tuner.
- 2** Use the **BAND** key (or the **Band** key) to select the broadcast band to "FM".
- 3** Press and hold the **ENTER** for more than 2 seconds.

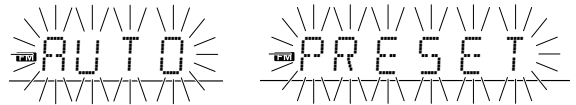

The blinking "AUTO" display and blinking "PRESET" display appear alternately.

- A maximum of 40 stations of the band presently being received will be preset.
- Use the Manual Preset function if a desired FM station cannot be preset using the Auto Preset function or when it is required to preset AM stations.

Presetting radio stations manually

- 1** Tune to the station you want to store.
- 2** Press the **ENTER** while receiving the station.

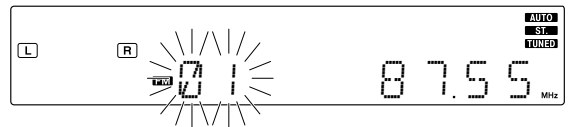

Proceed to step **3** within 5 seconds. (If more than 5 seconds elapse, press the **ENTER** again).

- 3** Use the **MULTI CONTROL** Δ/∇ (or the **Multi** Δ/∇ keys) to select one of the station presets (1 – 40).
- 4** Press the **ENTER** again to confirm the setting.

- Repeat steps **1**, **2**, **3**, and **4** to store as many stations as necessary.
- If you store a station at a previously used preset, the old station will be replaced by the new one.

Receiving preset stations

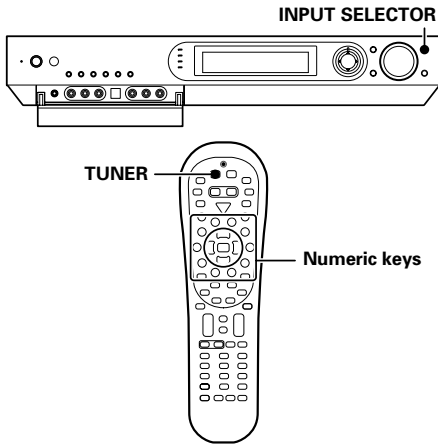

- 1** Use the **INPUT SELECTOR** key (or the **TUNER** key) to select tune as the source.
- 2** Enter the number of the preset station you want to receive (up to "40").

Press the numeric keys in the following order:

- For "15", press **+10**, **5**
- For "20", press **+10**, **+10**, **0**

- If you make a mistake entering a two digit number, press the +10 key repeatedly to return to the original display and start again.

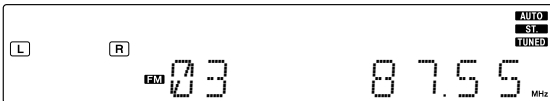

Receiving preset stations in order (P.CALL)

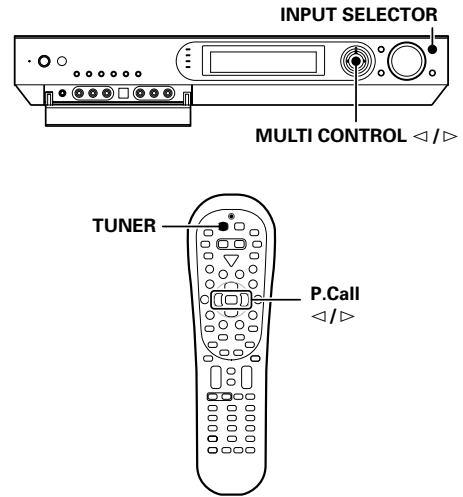

- 1** Use the **INPUT SELECTOR** key (or the **TUNER** key) to select tune as the source.
- 2** Use the **MULTI CONTROL </>** (or the **P.Call </>** keys) to select the desired station.

- Each time you push the Joystick, another preset station is received in order.

Pushing the Joystick to **▷** does the following:

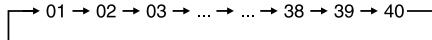

Pushing the Joystick to **◁** does the following:

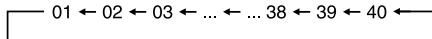

Holding the Joystick on **▷** or **◁** direction, lets you skip through the presets, receiving each preset station at 0.5 second intervals.

Using RDS (Radio Data System) (For Europe only)

RDS is a system that transmits useful information (in the form of digital data) for FM broadcasts along with the broadcast signal. Tuners and receivers designed for RDS reception can extract the information from the broadcast signal for use with various functions, such as automatic display of the station name.

RDS functions:

PTY (Program TYPe Identification) Search

-- [36]

Automatically tunes to a station that is currently broadcasting the specified program type (genre).

PS (Program Service Name) Display

Automatically displays the station name transmitted by the RDS station.

RDS AUTO MEMORY function

-- [36]

Automatically selects and stores up to 40 RDS stations in the preset memory.

If fewer than 40 RDS stations have been stored in the preset memory, regular FM stations will be stored in the remaining places.

Radio Text function

Displays the radio text data transmitted by some RDS stations when you press the RDS Disp. (display) key. There is "NO RT" if no text data is transmitted.

The "RDS" indicator lights up when an RDS broadcast (signal) is received.

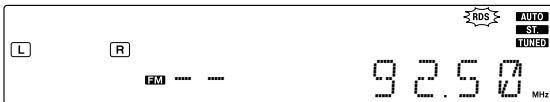

Note

Some functions and function names may differ for certain countries and areas.

Before using a function utilizing the RDS, be sure to perform the RDS Auto Memory operation by referring to the description in "Presetting RDS stations (RDS AUTO MEMORY)".

-- [36]

Using the RDS Disp. (Display) key

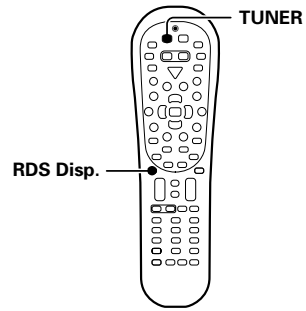

Pressing the RDS Disp. key changes the contents of the display.

Each press switches the display mode as follows :

- 1 PS (Program Service name) display
- 2 RT (Radio Text) display
- 3 Frequency display

1 PS (Program Service name) display :

The station name is displayed automatically when an RDS broadcast is received.

If no PS data was sent, "NO PS" is displayed.

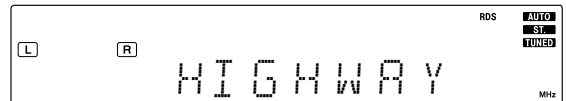

2 RT (Radio Text) display :

Text data accompanying the RDS broadcast scrolls across the display. "NO RT" or "RT ----" is displayed if the current RDS station does not provide RT data.



3 Frequency display :

Displays the frequency of the current station.

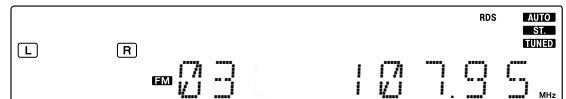

Presetting RDS stations (RDS AUTO MEMORY)

This function automatically stores up to 40 RDS stations in the preset memory. In order to use the PTY function, the RDS stations must be stored in the preset memory using the RDS Auto Memory function.

- 1** Use the **INPUT SELECTOR** key (or the **TUNER** key) to select tune as the source.
- 2** Use the **BAND** key (the **Band** key) to select the broadcast band to "FM".
- 3** Press and hold the **ENTER** for more than 2 seconds will start **AUTO MEMORY**.



The blinking "AUTO" display and blinking "MEMORY" display appear alternately.

- After a few minutes, up to 40 RDS stations are preset in order from channel "01".
- Stations already stored in the preset memory may be replaced by RDS stations. (i.e., If the RDS AUTO MEMORY function detects 15 RDS stations, the stations currently preset at numbers 01~15 will be replaced by the RDS stations.)

Tuning by Program Type (PTY search)

This function lets you set the tuner to automatically search for stations which are currently broadcasting the type of program (genre) you want to listen to.

Under certain receiving conditions, it may take more than 1 minute to complete the search.

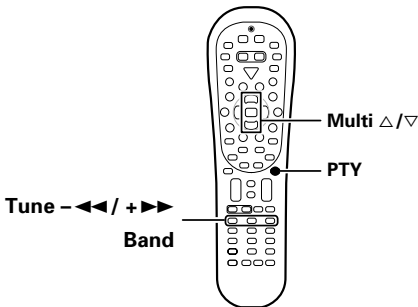

Preparations

- Execute the RDS auto memory procedure.
- Set the broadcast band to FM.
- Tune to an RDS station.

- 1** Press the **PTY** key to activate the **PTY** search mode.

Lights up

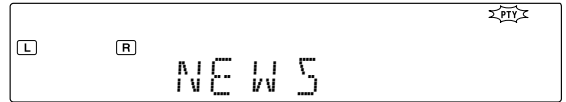

When an RDS broadcast is received, the program type is shown on the display. If no PTY data is available, or if the station is not an RDS station, "NONE" is displayed.

- 2** While the "PTY" indicator is lit, use the **Tune +/-** keys to select the program type of your choice.

w

Program type table

Program Type Name	Display	Program Type Name	Display
Pop Music	POP M	Weather	WEATHER
Rock Music	ROCK M	Finance	FINANCE
Easy Listening Music	EASY M	Children's Programmes	CHILDREN
Light Classical Music	LIGHT M	Social Affairs	SOCIAL
Serious Classical Music	CLASSICS	Religion	RELIGION
Other Music	OTHER M	Phone In	PHONE IN
News	NEWS	Travel	TRAVEL
Current Affairs	AFFAIRS	Leisure	LEISURE
Information	INFO	Jazz Music	JAZZ
Sport	SPORT	Country Music	COUNTRY
Education	EDUCATE	National Music	NATION M
Drama	DRAMA	Oldies Music	OLDIES
Culture	CULTURE	Folk Music	FOLK M
Science	SCIENCE	Documentary	DOCUMENT
Varied Speech	VARIED		

- 3** Press the **PTY** key to start searching.

Example: Searching for a Pop Music broadcast.

Display while searching.

Blinks

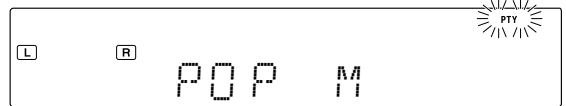

Program type name display

Display when a station is received.

Goes out

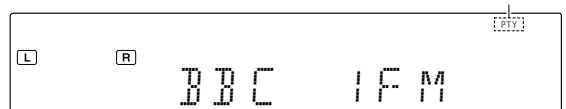

Station name display

- No sound is heard while "PTY" is blinking.
- If the desired program type cannot be found, "NO PROG" is displayed, then after several seconds the display returns to the original display.

To select another program type.

Repeat steps **1**, **2** and **3**.

Ambience effects

This receiver is equipped with listening modes that allow you to enjoy an enhanced sonic ambience with a variety of video sources.

In order to obtain the optimum effect from the surround modes, make sure to input the proper speaker settings beforehand. → [24]

Surround modes

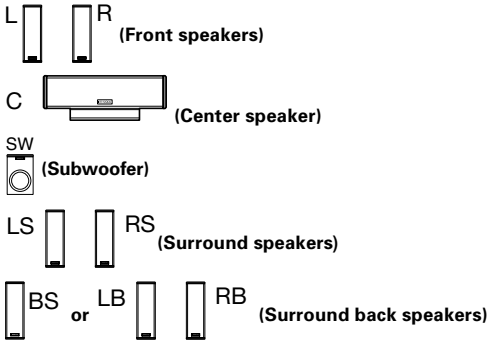

Dolby Digital EX

Dolby Digital EX is an extension of Dolby Digital technology, Dolby Digital EX creates six full-bandwidth output channels from 6.1-channel sources. This is done using a matrix decoder that derives three surround channels from the two in the original recording.

This is achieved by using three different surround signals, Left Surround, Right Surround, and Back Surround, each driving its own array of speakers. Think of it as adding a center channel for the rear speakers, which give more diffuse and natural surround effect, even if you wanted the ability to completely encircle the audience with sound, positioning sound effects exactly where they would be heard in real life.

Note

For best results, Dolby Digital EX should be used with movie soundtracks recorded with Dolby Digital Surround EX which contain a digital flag that will automatically activate this feature. However, for titles released prior to late 2001, this feature has to be activated manually.

This model lets you enjoy Dolby Digital (and Dolby Surround) program sources, even if you connect only the Front Speakers. However, in order to enjoy the benefit of true 6.1 channel Dolby Digital Surround EX sound, KENWOOD recommends that you connect a full set of speakers.

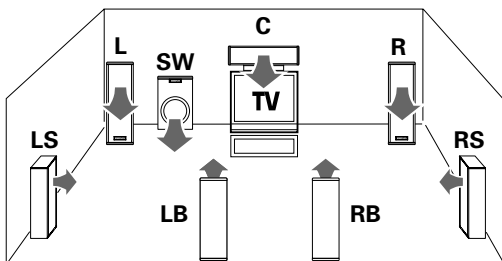

Dolby PRO LOGIC IIx/Dolby PRO LOGIC II

Dolby Pro Logic IIx was designed specifically to provide a new sense of spatiality, directionality and articulation of sounds from Dolby Surround encoded sources.

This is achieved with an intelligent, built-in feedback logic design, a matrix surround decoding and the decoding of stereo, full bandwidth surround outputs. The PRO LOGIC IIx modes programmed into this receiver are "MOVIE", "MUSIC" and "GAME". The "MOVIE" mode of the PRO LOGIC IIx has preset characteristics to produce a calibrated, high-level surround sound playback while the "MUSIC" mode has user-adjustable characteristics to offer the three optional controls, like "Dimension", "Center Width" and "Panorama" modes to allow optimization of the soundfields as desired. The "Dimension" control allows the user to gradually adjust the soundfield either towards the front or towards the rear; the "Center Width" control allows various adjustment of the left-center-right speakers' balance; the "Panorama" mode extends the front stereo image to include the surround speakers for an exciting "wraparound" effect with side wall imaging. The "GAME" mode is designed for playing video games and enhances the powerful feeling of sound.

Dolby PRO LOGIC IIx

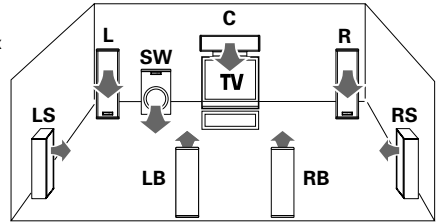

Dolby PRO LOGIC II

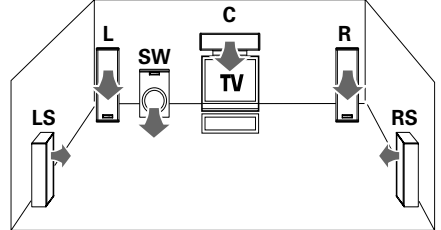

Dolby Digital

Dolby Digital surround format lets you enjoy up to 5.1 channels of digital surround sound from Dolby Digital program sources (such as Laserdisc or DVD software marked). Compared with previous Dolby surround, Dolby Digital provides even better sound quality, greater spatial accuracy, and improved dynamic range.

This model lets you enjoy Dolby Digital (and Dolby Surround) program sources, even if you connect only the Front Speakers. However, in order to enjoy the benefit of true 5.1 channel Dolby Digital surround sound, KENWOOD recommends that you connect a full set of speakers.

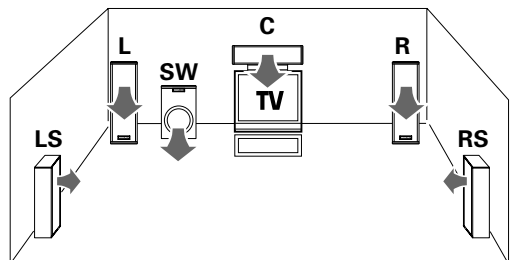

DTS-ES

The DTS-ES (Digital Theater System-Extended Surround) represents 6.1-channel Discrete Surround format, expanding upon 5.1 surround. DTS-ES format is a 6.1 channel sound system for movie theaters that includes an additional surround center channel matrixed within surround left and surround right. It's compatible on predecessor DTS 5.1 system. The extra channel allows more accurate placement and steering of sound across the rear soundstage. The DTS-ES receiver will be required, to experience a discrete 6.1-channel mix. The DTS-ES decoders used in home cinema systems have decoding options for utilizing the extra channel, in addition to processing existing 5.1 channel surround sound :

DTS-ES Discrete 6.1 and DTS-ES Matrix 6.1 add the surround back channel audio to the DTS 5.1-channel format to improve the acoustic positioning and makes acoustic image movement more natural with the 6.1-channel reproduction.

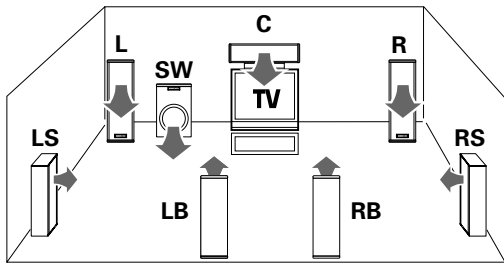

DTS

The DTS employs a larger amount of data than Dolby Digital to play surround sound with higher quality. The DTS can be used with DVD and LaserDisc software carrying the  mark. Although the number of channels is 5.1 and identical to Dolby Digital, the DTS format features lower audio compression rate in digital recording, which enables audio with more profoundness and higher S/N. The wider dynamic range and better channel separation also contribute to make the surround sound more precise and larger in scale.

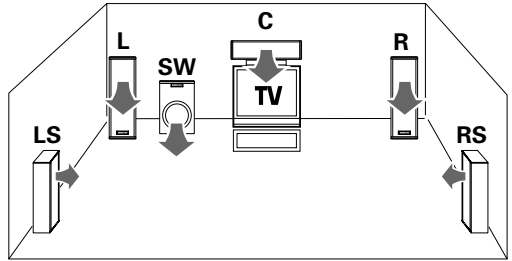

NEO:6

NEO:6 is a new technology which decodes 2-channel signals into 6-channel signals using high-accuracy digital matrix technology. For the best results, DTS-ES should be used with movie sound tracks recorded with DTS-ES format which contain a digital flag that will automatically activate this feature. However, for some titles, this feature has to be activated manually. According to the signals to be played back, DTS NEO:6 uses either the NEO:CINEMA mode optimized for movie playback or the NEO:MUSIC mode optimized for music playback.

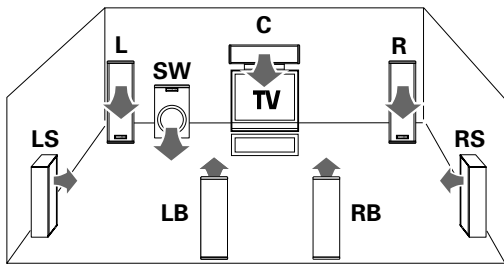

DSP mode

The DSP mode lets you add the atmosphere of a live concert or hall to almost any type of program source. These modes are particularly effective when used with stereo program sources, like CD, television, and FM radio. You might enjoy trying the ARENA, JAZZ CLUB, THEATER, STADIUM or DISCO mode the next time you watch a concert or sporting event!

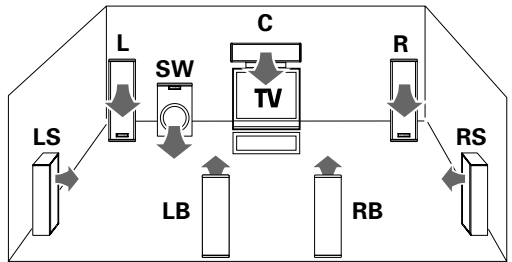

What's DSP?

DSP stands for Digital Signal Processor.

The way a sound is heard in an actual environment depends on a variety of different factors. One of the most important is reverberation (the act of decaying elements of sound echoing in various places). The DSP modes produce the feeling of presence by using the DSP to create reverberation, without spoiling the sound quality of the original signal.

DTS 96/24

The DTS 96/24 enables 5.1-channel playback with broad bandwidth over 40 kHz and high resolution without affecting the picture quality of DVD video. As it is compatible with the DTS surround playback, it makes it possible to play DTS 5.1-channel surround audio even when the AV amplifier incorporates only the DTS or DTS-ES decoder.

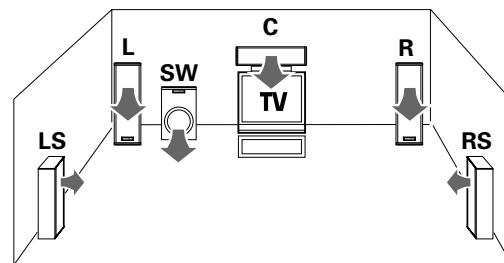

LFE = Low Frequency Effects. This channel delivers separate non-directional bass signals to the subwoofer for more dynamic deep bass sound effects. When there is a LFE channel input in the DOLBY DIGITAL or DTS format, the 'LFE' indicator lights on the display of the receiver.

Dolby Virtual Speaker

The Dolby Virtual Speaker features a virtual surround sound field. This implements an effect as if there are multiple speakers in the listening room.

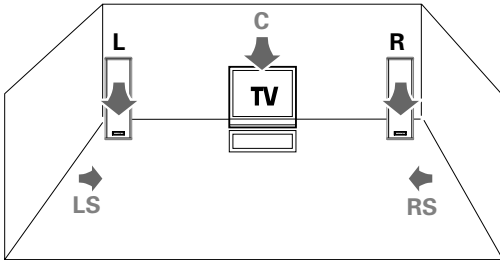

Dolby Headphone

When headphones are used in music listening, the audio of the left (or right) channel reaches only the left (or right) ear so the listener cannot feel the presence of acoustic images on the front. The Dolby Headphone simulates a virtual room and include its acoustic characteristics in the left and right headphone signals. As a result, the listener can hear the same components as in speaker listening through the left and right ears and therefore feel as if the sound source is located on the front of the listener.

Virtual modes

The following modes allow you to enjoy powerful surround audio even when you use only two speakers or listen through headphones.

- In the Dolby Virtual Speaker and Dolby Headphone modes, only the listen modes for 2 channels can be selected. Also, the desired listen mode may be unable to be selected depending on the reproduced signals. → [40]

How to set the Dolby Virtual Speaker mode (when not using headphones):

Press the Dolby Virtual key for the following selections:

- ① **"DVS WIDE"** : The virtual surround effect can be given added expansion and spatial feeling.
 - ② **"DVS REF"** : * Standard setting.
 - ③ **"DVS OFF"** : Cancel
- * This mode can be selected only when the surround speaker setting is OFF.

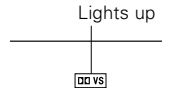

How to set the Dolby Headphone mode (when using headphones):

Press the Dolby Virtual key for the following selections:

- ① **"DH 1"**: Small, acoustically dry room.
- ② **"DH 2"**: More lively room than "DH 1".
- ③ **"DH 3"**: Larger room than "DH 1" for enhanced feelings of distance and sound diffusion effect.
- ④ **"OFF"**: Cancel

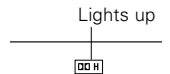

- The Dolby Virtual Speaker or Dolby Headphone mode is defeated when the DUAL SOURCE mode or REC MODE is ON.

Manufactured under license from Dolby Laboratories. "Dolby", "Pro Logic", "Surround EX" and the double-D symbol are trademarks of Dolby Laboratories.

"DTS", "DTS-ES Extended Surround", "Neo:6" and "DTS 96/24" are trademarks of Digital Theater Systems, Inc.

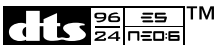

Surround play

The desired listen mode can be selected according to the input signal.

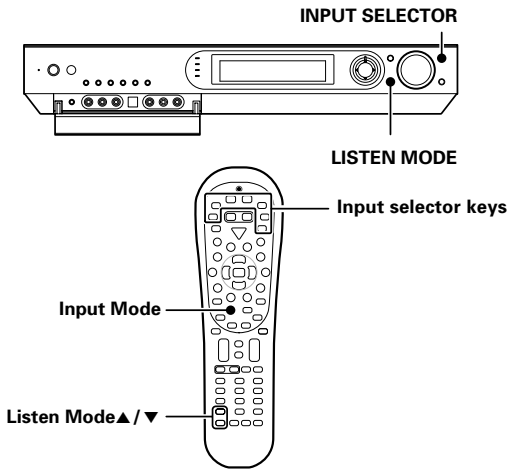

Preparations

- Turn ON related components.
- Complete **"Preparing for playback" (speaker settings)**. → 24
- Use the **INPUT SELECTOR** key (or Input Selector keys) to select the component you wish to play back with surround sound.
- Use the **Input Mode** key to select the input mode (analog or digital) for the source you wish to play back. → 8
- Noise will be produced when a DTS source is played by selecting the analog input.

1 Start playing the video software.

2 Press the LISTEN MODE key (or the Listen Mode ▲/▼ keys) to select the listening mode.

The listening mode settings are stored separately for each input selector.

If the input mode is set to full auto ("AUTO DETECT" lights), this model selects the optimal listening mode automatically based on the type of input signal and the speaker settings.

Each press the LISTEN MODE key (or the Listen Mode ▲/▼ keys) switches the setting as listed below.

The listening mode settings are different depending on the type of input signal.

- The **"MULTI CH"** indicator lights during playback through multiple channels.

Listen modes available with Dolby Digital EX or Dolby Digital playback: ("Dolby D" indicator lights up)

Main example of medium:

Multi-channel digital source such as DVD.

- ① **"DOLBY D"**:
DOLBY DIGITAL surround
- ② **"DOLBY D EX"**:
DOLBY DIGITAL EX surround
- ③ **"DOLBY D + PLIIx MOVIE"**:
DOLBY DIGITAL surround +
DOLBY PRO LOGIC IIX surround MOVIE mode*
- ④ **"DOLBY D + PLIIx MUSIC"**:
DOLBY DIGITAL surround +
DOLBY PRO LOGIC IIX surround MUSIC mode
- ⑤ **"STEREO"**:
Normal stereo playback.

* Can be selected only when two surround back speakers are connected.

- You can also adjust the midnight mode as desired. → 44

Listen modes available with DTS, DTS-ES (Matrix or Discrete) or DTS-96/24 playback: ("DTS" indicator lights up)

Main example of medium:

Multi-channel digital source such as DVD.

- ① **"DTS"**:
DTS surround
- ② **"DTS + NEO6 CINEMA"**:
DTS surround + DTS NEO:6 surround CINEMA mode
- ③ **"DTS-ES MATRIX 6.1"**:
DTS-ES 6.1-channel Matrix surround *1
- ④ **"DTS-ES DISCRETE 6.1"**:
DTS-ES 6.1-channel Discrete surround *2
- ⑤ **"DTS 96/24"**:
DTS 96/24 surround *3
- ⑥ **"STEREO"**:
Normal stereo playback.

*1 Can be selected only with DTS-ES 6.1ch Matrix Surround.

*2 Can be selected only with DTS-ES 6.1ch Discrete Surround.

*3 Can be selected only with DTS 96/24 Surround.

- You can also adjust the midnight mode as desired. → 44

Listen modes available with analog or PCM playback:

Main example of medium:

- Digital sources including DVD 96 kHz linear PCM and CD.
- Analog source such as VCR or radio broadcasting.

①	"PL IIx MOVIE": DOLBY PRO LOGIC IIx surround MOVIE mode *1
②	"PL IIx MUSIC": DOLBY PRO LOGIC IIx surround MUSIC mode *1 *2
③	"PL IIx GAME": DOLBY PRO LOGIC IIx surround GAME mode *1
④	"PL II MOVIE": DOLBY PRO LOGIC II surround MOVIE mode
⑤	"PL II MUSIC": DOLBY PRO LOGIC II surround MUSIC mode *2
⑥	"PL II GAME": DOLBY PRO LOGIC II surround GAME mode
⑦	"PRO LOGIC": DOLBY PRO LOGIC surround
⑧	"NEO6 CINEMA" or "NEO6 96K CINEMA": DTS NEO:6 surround CINEMA mode
⑨	"NEO6 MUSIC" or "NEO6 96K MUSIC": DTS NEO:6 surround MUSIC mode *3
⑩	"ARENA": DSP surround ARENA mode *4
⑪	"JAZZ CLUB": DSP surround JAZZ CLUB mode *4
⑫	"THEATER": DSP surround THEATER mode *4
⑬	"STADIUM": DSP surround STADIUM mode *4
⑭	"DISCO": DSP surround DISCO mode *4
⑮	"STEREO":*5 Normal stereo playback.

*1 Cannot be selected in Dolby Virtual Speaker and Dolby Headphone modes.

*2 The sound field can be adjusted as desired using the PANORAMA, DIMENSION and CENTER WIDTH modes. → [43]

*3 The sound field can be adjusted as desired using the CENTER IMAGE modes. → [44]

*4 Cannot be selected in Dolby Virtual Speaker and Dolby Headphone modes or with a 96 kHz linear PCM signal input.

The effect level of the DSP surround mode can be adjusted as desired. → [42]

*5 In Dolby Virtual Speaker and Dolby Headphone modes, the Dolby Digital signal input cannot be listened to in the stereo mode.

3 Adjust the volume.

Note

- Certain modes may be unavailable depending on the type of input signal or speaker setting.
- If an optimum surround effect cannot be obtained or the desired mode cannot be selected, check the speaker and input mode settings. → [8] → [24]

Dolby Digital Surround EX compliant disc :

Dolby Digital Surround EX compliant disc contains identification signals. When you choose FULL AUTO during "Input mode settings" (→ [8]), this amplifier detects the identification signals and change the LISTEN mode to the DOLBY DIGITAL EX (Dolby Digital Surround EX mode) automatically. But sometimes we find some discs which are Dolby Digital Surround EX compliant disc but it does not contain the identification signals. If you find the notice like "Surround EX" on the label of disc or package, you can choose DOLBY DIGITAL EX, then you can enjoy Dolby Digital Surround EX sound.

Switching the listen mode temporarily to the stereo mode

Press the **Stereo** key to switch the current listen mode temporarily to the Stereo mode. Pressing the key again restores the original listen mode.

- The original listen mode is also restored when the input selector is switched or the receiver is turned OFF then ON again.

Convenient functions

You can make further adjustments to the sound while listening to playback in the surround mode.

- The mode using **Sound** key is defeated when the REC MODE is ON. - 32

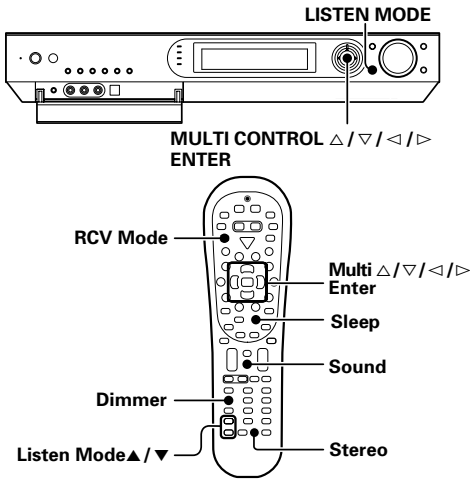

Adjusting the sound

- 1 Press the RCV Mode key on the remote control unit to set it to the receiver control mode.
- 2 Press the Sound key
- 3 Press MULTI CONTROL </> (or the Multi </> key) to select the setting item and press ENTER (or the Enter key).

Note that some items are not displayed in certain modes.

- 1 *SP LEVEL*: *1
Adjusting the volume level of each channel
- 2 *INPUT*: (Analog mode only) - 28
Input level adjustment
- 3 *TONE*: *2 - 30
Tone level adjustment
- 4 *EFFECT*: (DSP mode only)
DSP effect level adjustment
- 5 *DUAL MONO*: *3 - 43
Selection between Stereo, Main audio, Sub audio and Main + Sub audio
- 6 *MIDNIGHT*: *4 - 44
Midnight mode adjustment
- 7 *PANORAMA*: *5 - 43
Panorama mode ON/OFF
- 8 *DIMENSION*: *5 - 43
Dimension adjustment
- 9 *C WIDTH*: *5 - 43
Center width adjustment
- 10 *C IMAGE*: *6 - 44
Center image mode adjustment

*1 The setting in the SOUND mode is temporary. It returns automatically to the original level set in "Speaker settings" when the receiver is turned OFF/ON.

*2 PCM stereo and analog stereo mode only.

*3 DOLBY DIGITAL mode only

*4 DOLBY DIGITAL, DTS mode only

*5 Only when the input signal is a 2-channel signal in the DOLBY PRO LOGIC IIx MUSIC or DOLBY PRO LOGIC II MUSIC mode.

*6 Only when the input signal is a 2-channel signal in the DTS NEO:6 MUSIC mode.

- 4 Use the MULTI CONTROL </> (or the Multi </>) to adjust the setting as desired.

• The adjustment item is displayed for approximately 20 seconds.

- 5 Press the Sound key again to return to the input indication.

Adjusting the volume level of each channel

The volume levels of the center speaker, subwoofer, surround speaker and surround back speaker channels can be adjusted during playback.

- 1 Press the RCV Mode key on the remote control unit to set it to the receiver control mode.
- 2 Press the Sound key
- 3 Use the MULTI CONTROL </> (or the Multi </> keys) to select "SP LEVEL" on setup displays, and press the ENTER (or Enter key).
- 4 Use the MULTI CONTROL </> (or the Multi </> keys) to select the speaker.
 - 1 Subwoofer level adjustment ("SW" indicator blinks)
 - 2 Center speaker level adjustment ("C" indicator blinks)
 - 3 Surround speaker level adjustment ("LS", "RS" indicator blinks)
 - 4 Surround back speaker level adjustment ("LB", "RB" or "BS" indicator blinks)
- 5 Use the MULTI CONTROL </> (or the Multi </> keys) to adjust the speaker volume level.

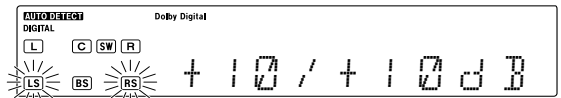

- The level of each speaker channel can be adjusted in 1 dB steps between -10 dB and +10 dB.

- 6 Repeat steps 4 and 5 as required.
- 7 Press the Sound key again to return to the input indication.

• The setting in the SOUND mode is temporary. It returns automatically to the original level set in "Speaker settings" when the receiver is turned OFF/ON.

Adjusting the DSP effect level (DSP mode only)

The DSP effect level can be adjusted when the listen mode is a DSP surround mode "ARENA", "JAZZ CLUB", "THEATER", "STADIUM" or "DISCO".

- 1 Press the RCV Mode key on the remote control unit to set it to the receiver control mode.
- 2 Press the Sound key
- 3 Use the MULTI CONTROL </> (or the Multi </> keys) to select "EFFECT" on setup displays, and press the ENTER (or Enter key).
- 4 Use the MULTI CONTROL </> (or the Multi </>) to adjust the EFFECT LEVEL.

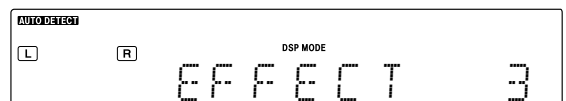

- The DSP effect level can be adjusted in the range between 1 and 5.

- 5 Press the Sound key again to return to the input indication.

Switching between main audio and sub audio

(DOLBY DIGITAL mode only)

When listening to audio multiplex broadcasting such as two-language satellite digital broadcasting, the main and sub audio can be switched over.

- ➊ Press the RCV Mode key on the remote control unit to set it to the receiver control mode.
- ➋ Press the Sound key while the "DUAL MONO" indicator is lit.
- ➌ Use the MULTI CONTROL </> (or the Multi </> keys) to select "DUAL MONO" on setup displays, and press the ENTER (or the Enter key).
- ➍ Use the MULTI CONTROL Δ / ∇ (or the Multi Δ / ∇ keys) to select the audio.

- ➎ ① "MAIN": The main audio is output.
- ➎ ② "SUB": The sub audio is output.
- ➎ ③ "MAIN + SUB": The mixture of main audio and sub audio is output.
- ➎ ④ "STEREO": The left channel outputs the main audio and the right channel outputs the sub audio.

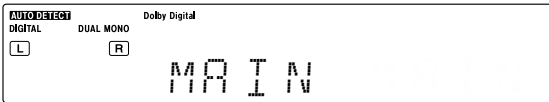

- ➏ Press the Sound key again to return to the input indication.
 - If the audio multiplex broadcasting is not monaural, the audio cannot be switched on this receiver. In this case, use the audio switching function on the tuner.

Panorama mode

(Only when the input signal is a 2-channel signal in the DOLBY PRO LOGIC IIx MUSIC or DOLBY PRO LOGIC II MUSIC mode)

When listening to music, you will be able to enjoy the "wraparound" sound effect when you adjust the panorama mode.

- ➊ Press the RCV Mode key on the remote control unit to set it to the receiver control mode.
- ➋ Press the Sound key
- ➌ Use the MULTI CONTROL </> (or the Multi </> keys) to select "PANORAMA" on setup displays, and press the ENTER (or the Enter key).
- ➍ Use the MULTI CONTROL Δ / ∇ (or the Multi Δ / ∇) to select PANORAMA ON or OFF.

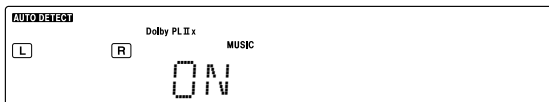

- ➏ Press the Sound key again to return to the input indication.

Dimension mode

(Only when the input signal is a 2-channel signal in the DOLBY PRO LOGIC IIx MUSIC or DOLBY PRO LOGIC II MUSIC mode)

When listening to music with certain recordings, you will also be able to achieve a suitable balance from all the speakers by adjusting the dimension mode.

- ➊ Press the RCV Mode key on the remote control unit to set it to the receiver control mode.
- ➋ Press the Sound key
- ➌ Use the MULTI CONTROL </> (or the Multi </> keys) to select "DIMENSION" on setup displays, and press the ENTER (or Enter key).

- ➍ Use the MULTI CONTROL Δ / ∇ (or the Multi Δ / ∇) to adjust the soundfield towards the rear or the front. Soundfield is adjusted towards the front.



Standard setting.



Soundfield is adjusted towards the rear.



- ➏ Press the Sound key again to return to the input indication.

Center Width mode

(Only when the input signal is a 2-channel signal in the DOLBY PRO LOGIC IIx MUSIC or DOLBY PRO LOGIC II MUSIC mode)

Center width adjustment allows you to enjoy an enhanced sound when listening to music through center image from only center speaker, or left and right speakers or various combinations adjustments.

- ➊ Press the RCV Mode key on the remote control unit to set it to the receiver control mode.
- ➋ Press the Sound key
- ➌ Use the MULTI CONTROL </> (or the Multi </> keys) to select "C WIDTH" on setup displays, and press the ENTER (or the Enter key).
 - When the center speaker is switched OFF, this mode will not be effective.
- ➍ Use the MULTI CONTROL Δ / ∇ (or the Multi Δ / ∇) to adjust the left-center-right output.

Center image will be heard from center speaker only.

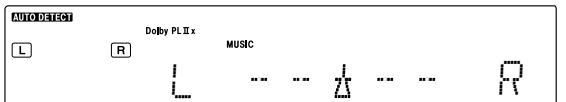

Center image will be heard from left and right speakers only.

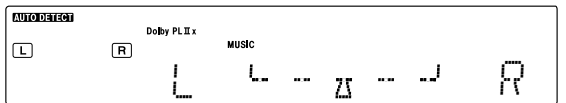

- When in other position, center image from center speaker, left and right speakers can be heard simultaneously with various combinations.

- ➏ Press the Sound key again to return to the input indication.

Center Image mode (Only when the input signal is a 2-channel signal in the DTS NEO:6 MUSIC mode.)

In the CENTER IMAGE setting mode of the NEO:6 MUSIC listen mode, it is possible to enhance the center channel audio by adjusting the center signal component.

- ➊ Press the RCV Mode key on the remote control unit to set it to the receiver control mode.
- ➋ Press the Sound key
- ➌ Use the MULTI CONTROL </> (or the Multi </> keys) to select "C IMAGE" on setup displays, and press the ENTER (or the Enter key).
 - When the center speaker is switched OFF, this mode will not be effective.
- ➍ Use the MULTI CONTROL Δ / ▽ (or the Multi Δ / ▽) to adjust the left-center-right output.



- Adjust the center component level.

- ➎ Press the Sound key again to return to the input indication.

Midnight mode (DOLBY DIGITAL and DTS mode only)

When watching movies at night, you might not be able to raise the volume as loud as normal. Midnight mode compresses the dynamic range of previously specified parts of the DOLBY DIGITAL or DTS sound track (like scenes with sudden increases in volume) to minimize the difference in volume between the specified and non-specified parts. This makes it easy to hear all of the sound track, even when listening at low volumes.

- ➊ Press the RCV Mode key on the remote control unit to set it to the receiver control mode.
- ➋ Press the Sound key
- ➌ Use the MULTI CONTROL </> (or the Multi </> keys) to select "MIDNIGHT" on setup displays, and press the ENTER (or the Enter key).
 - This can be selected only if DVD, VIDEO 1, VIDEO 2, AUX or GAME is selected as the source and the listen mode is set to "DOLBY DIGITAL" or "DTS".
- ➍ Use the MULTI CONTROL Δ / ▽ (or the Multi Δ / ▽) to select the "MIDNIGHT2", "MIDNIGHT1" or "OFF" setting.

- ➊ "MIDNIGHT2": Large effect
Suitable for late-night use.
- ↕
- ➋ "MIDNIGHT1": Medium effect
- ↕
- ➌ "OFF"

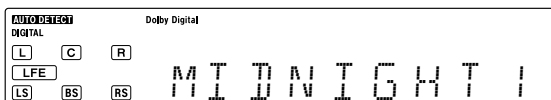

- The adjustment item is displayed for approximately 20 seconds.
- Some DOLBY DIGITAL or DTS software may not be compatible with the Midnight mode.

- ➎ Press the Sound key again to return to the input indication.

Display dimmer adjustment

The dimmer function lets you select the brightness of the receiver's display. You might find this useful if you darken your room to watch movies or listen to music.

Each time you press the Dimmer key, the display's brightness changes among the three available settings.

Select the brightness level you find most pleasing.

- ➊ Bright
- ➋ Dark
- ➌ Dark (Indicators on the receiver are also OFF.)

Sleep timer

The sleep timer function turns the receiver OFF (to the standby mode) automatically when the set timer period has elapsed. The sleep timer period can be set in 10-minute steps up to 90 minutes.

Press the Sleep key repeatedly until the desired period before turning the receiver OFF (standby mode) is displayed.

- Each press increments the sleep timer period by 10 minutes.
- 10 → 20 → 3070 → 80 → 90 → Cancel → 10 → 20 → ...

The sleep timer indicator lights up

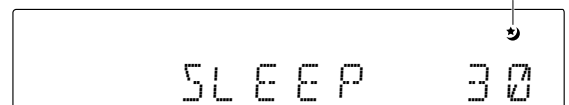

- Pressing the Sleep key after the sleep timer has started allows you to check the remaining time period.
- To cancel the sleep timer, turn the receiver OFF (standby mode) or press the Sleep key repeatedly until the Sleep timer indicator disappears.

Basic remote control operations for other components

The remote control supplied with this receiver is also capable of controlling components from a variety of manufacturers once you register the appropriate setup codes into the remote control unit.

Low battery warning

Replace all two batteries with new ones when you notice a shortening of the distance from which the remote control will operate. The remote control is designed to retain setup codes in memory while you change batteries.

Registering setup codes for other components

When the setup code defined for remote control of every system component is registered in one of the input selector keys of the remote control unit, you can control that component simply after selecting it using the corresponding input selector key of the remote control unit.

- When recording audio on a VCR or MD recorder, for example, you can also control the system component by switching only the remote control unit, without switching the input source of the receiver.

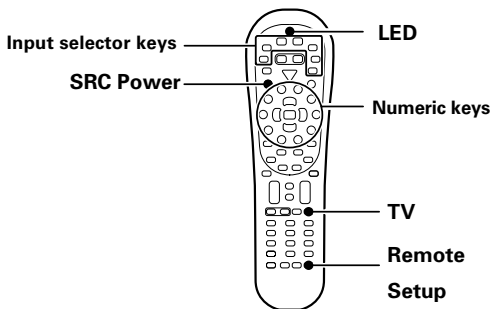

1 Find the setup code of the component to be registered.

Refer to the setup code lists to find the setup code for the component to be registered. → [47] → [51]

Example: To register a DVD made by KENWOOD, you would enter *0490* or *0534*.

2 Press the input selector key (DVD, VID1, VID2, AUX, F.AUX or Game) you want to register a system component.

The following table shows the type of components that can be registered in each input selector key.

Input selector key	Registerable component	Input jacks where the component is connected
DVD	DVD player	DVD
VID1	VCR	VIDEO1
VID2	Cable Converters Satellite Receivers	VIDEO2
AUX	CD player, MD recorder (KENWOOD)	AUX
F. AUX	DVD player	FRONT AUX
Game	DVD player	GAME
TV	TV (including TVs incorporating VCR)	—

- Make sure that a source belonging to the registerable component is connected to the corresponding input jacks on the receiver.
- A second DVD recorder, CD player or VCR can also be connected by changing the assignment of the registerable component devices. See "Re-assigning device keys" on page 46.

3 Press and hold the Remote Setup key until the LED blinks twice, then release the Remote Setup key.

- Proceed to the next steps in less than 10 seconds after the LED blinks twice.

4 Press the numeric key to enter the four-digit code for the component to be registered.

- The LED blinks twice when registration is completed successfully.

5 Ensure that the registered component functions properly.

To ensure the proper function, perform the following operation and check if the component functions as intended.

Point the remote control unit to the component and press the **SRC Power** key (or the **TV Power** key if the component is a TV) once. If the setup code is registered properly, the component should be turned ON or OFF. If the component is a VCR, turn the VCR ON and load a video tape and perform an operation such as playback. The VCR should function as controlled if its setup code is registered properly.

If the component does not function properly:

If more than one setup code is listed for the component, try registering another setup code by performing steps 3 to 5.

- Repeat steps 1 to 5 above to register the setup code of another component.
- To change the registered setup code, register a new setup code again by performing steps 1 to 5 above.

Note

Although each setup code is designed to work with a number of different models, certain codes may not work with some models. (Also, certain codes may only operate some of the functions available on a given model.)

Searching for your code

If your component does not respond after trying all the codes listed for your component, or if your component is not listed at all, try searching for your code.

For example, to search for a code for your TV.

1 Press the TV key once.

When searching for the setup code of a component other than TV:

Press the desired input selector key instead of the **TV** key.

2 Press and hold the Remote Setup key until the LED blinks twice, then release the Remote Setup key.

- Proceed to the next steps in less than 10 seconds after the LED blinks twice.

3 Press the numeric key to enter "9 9 1".

- The LED will blink twice.

4 Point the remote control at the TV and slowly alternate between pressing the TV Power and TV keys. Stop when the TV turns on or off.

- In the search mode, the remote control will send IR codes from its library to the selected device, starting with the most popular code first.

When searching for the setup code of a component other than TV:

To search for the setup code of a DVD, CD, MD or VCR, press the input selector key pressed in 1 and the **SRC Power** key alternately and check if the component to be registered is turned ON and OFF. To search for the setup code of a VCR, turn the VCR ON, load a tape and press the input selector key pressed in step 1 (i.e. VID1) and an operation key such as the play key alternately and check if the VCR is controlled as intended.

5 Press the Remote Setup key once to lock in the code.

Checking the codes

The 4-digit setup codes registered in the input selector keys can be checked as follows.

- 1 Press the input selector key in which the setup code of the desired component is registered.**
- 2 Press and hold the Remote Setup key until the LED blinks twice, then release the Remote Setup key.**
 - Proceed to the next steps in less than 10 seconds after the LED blinks twice.
- 3 Press the numeric key to enter "9 9 0".**
 - The LED will blink twice.
- 4 Press the numeric key "1" once.**

The LED blinks for the same number of times as the numeral in the first digit of the 4-digit code. When the registered setup code is "1338", for example, the LED will blink once. If a code digit is "0", the LED will not blink.
- 5 Repeat step 4 three more times for the remaining digit. Use "2" for the second digit, "3" for the third digit, and "4" for the fourth digit.**

Re-assigning device keys

The type of component device that can be registered is assigned in advance in each input selector key, but this assignment can be changed as desired by the user.

For example, the initial status is set so that a VCR can be registered in the input selector **VID1** key. If you want to register the setup code of a DVD player in the **VID1** key just like in the **DVD** key, reassign the key (change the registerable component type assignment for the input selector key) as described below.

- 1 Press and hold the Remote Setup key until the LED blinks twice, then release the Remote Setup key.**
 - Proceed to the next steps in less than 10 seconds after the LED blinks twice.
- 2 Press the numeric key to enter "9 9 2".**
 - The LED will blink twice.
- 3 Press the DVD key once, then press the VID1 key once.**

The LED blinks twice, and it is possible to register the setup code of a DVD player in the **VID1** key just like in the **DVD** key. Now register the setup code according to the model of the DVD player. The combination of components assignable to the input selector keys can be changed by pressing different keys in step 2. For example, to change the key assignment so that the same component as that registered in input selector "B" key can be registered in input selector "A" key, press the "B" key then the "A" key after entering "9 9 2" with the numeric keys.

 - For the originally assigned relationship between the input selector keys and system component types, see the table on the previous page.
 - To restore the original component type assignment of an input selector key, press that input selector key twice after entering "992".
 - It is not possible to register a component in the **TUNER** key.

Examples of key re-assignment and the order of pressing the keys:

Registration of a DVD player in the **VID1** key

To change the VID1 key to another DVD:

"9 9 2" → "DVD" → "VID1"

Restoration of the original key assignment

To return the VID1 key to the VID1 key:

"9 9 2" → "VID1" → "VID1"

Registration of a VCR in the **VID2** key

To change the VID2 key to another VCR:

"9 9 2" → "VID1" → "VID2"

Restoration of the original key assignment

To return the VID2 key to the VID2 key:

"9 9 2" → "VID2" → "VID2"

Operating other components

This operation lets you operate the registered components.

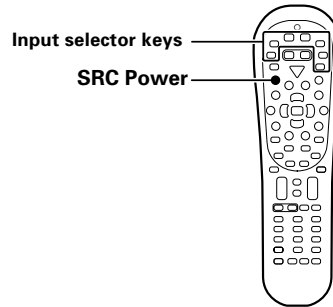

- 1 Use the Input Selector keys to select the component you desire.**

When the input selector key is pressed, the system component registered in the pressed key becomes ready to be controlled. The input selector of the receiver is also switched accordingly. If you want to control the component registered in the remote's input selector key without switching the receiver's input selector to that source, press and hold the input selector key for more than 3 seconds.

 - To put the remote control unit to the receiver control mode, press the **RCV Mode** key.
- 2 Turn the component ON.**
 - A DVD player, CD player, MD recorder or VCR registered in one of the remote's input selector keys can be turned ON by pressing the remote's **SRC Power**.
 - A TV registered in one of the remote's input selector keys can be turned ON by pressing the remote's **TV Power** key.
- 3 Press the operation keys you desire.**
 - For the keys that can be used with each system component, see pages 58 to 59.

Clearing all of the settings registered or stored in the remote control unit

You can reset the remote control unit to the initial status after purchase, clearing all of the component registration using setup codes and other data stored using the learning functions.

- 1 Press and hold the Remote Setup key until the LED blinks twice, then release the Remote Setup key.**
 - Proceed to the next steps in less than 10 seconds after the LED blinks twice.
- 2 Press the numeric key to enter "9 8 1".**
 - The LED blinks four times, and all of the data you registered or stored in the remote control unit is cleared.

Setup code chart (RC-R0730) (For U.S.A., Canada and Australia)

Even when a component is manufactured by a maker listed in the setup code chart, it may be unable to be registered depending on the model and year of production. Also, when a setup code of a non-KENWOOD maker is registered, certain component models may be unable to be controlled or only the limited functions may be controllable. In this case, it is recommended to use the remote control unit provided with the system component. For how to register the setup codes, read **'Registering setup codes for other components'** carefully. → [45](#)

Cable Converters

Maker	Setup codes
ABC	0003, 0008, 0014
Americast	0899
Bell & Howell	0014
Bell South	0899
Clearmaster	0883
ClearMax	0883
Coolmax	0883
Director	0476
General Instrument	0476, 0810, 0276, 0003
GoldStar	0144
Hamlin	0009, 0273
Jerrold	0476, 0810, 0276, 0003, 0014
Memorex	0000
Motorola	0476, 0810, 0276, 1254, 1376
Pace	0237
Panasonic	0000, 0107
Paragon	0000
Philips	0305, 0317
Pioneer	0877, 1877, 0144, 0533
Pulsar	0000
Quasar	0000
RadioShack	0883
Regal	0279, 0273
Runco	0000
Samsung	0144
Scientific Atlanta	877, 1877, 0477, 0008
Sony	1006
Starcom	0003
Supercable	0276
Supermax	0883
Torx	0003
Toshiba	0000
Tristar	0883
V2	0883
Viewmaster	0883
Vision	0883
Vortex View	0883
Zenith	0000, 0525, 0899

CD player

Maker	Setup codes
Kenwood	0681, 0826, 0626, 0028, 0037, 0339, 1490, 0338, 0523, 0859, 0190, 0340, 0677, 0858, 1338
Marantz	0626
Optimus	0037
Philips	0626
Sharp	0037
Yamaha	0036

MD recorder

Maker	Setup codes
Kenwood	0681, 0826, 1339

Audio Amp/Tuners

Maker	Setup codes
Kenwood (Sirius Satellite Radio)	2000

Video Accessories

Maker	Setup codes
Macro Image Technology	1383
MyHD	1383
Panasonic	1120
Pioneer	1010
Princeton	0113, 0295
Samsung	1490
Sensory Science	1126
Sharp	1010
Viewsonic	1329

Satellite Receivers

Maker	Setup codes
AlphaStar	0772
Chaparral	0216
Crossdigital	1109
DirecTV	0392, 0566, 0639, 1639, 1142, 0247, 0749, 1749, 0724, 0819, 1856, 1076, 1109, 0099
Dish Network System	1005, 0775
Dishpro	1005, 0775
Echostar	1005, 0775
Expressvu	0775
GE	0566
General Instrument	0869
GOI	0775
Hitachi	0819
HTS	0775
Hughes Network Systems	1142, 0749, 1749
JVC	0775
Magnavox	0724, 0722
Memorex	0724
Mitsubishi	0749
Motorola	0869
Next Level	0869
Panasonic	0247, 0701
Paysat	0724
Philips	1142, 0749, 1749, 0724, 1076, 0722, 0099
Proscan	0392, 0566
RadioShack	0869
RCA	0392, 0566, 0855, 0143
Samsung	1276, 1109
SKY	0856
Sony	0639, 1639
Star Choice	0869
Tivo	1142
Toshiba	0749, 1749, 0790, 1285
Uniden	0724, 0722
Zenith	0856, 1856

TV

Maker	Setup codes
Admiral	0093, 0463
Aiko	0092
Aiwa	1914
Akai	0812, 0702, 0030, 0672
Albatron	0843
America Action	0180
Ampro	0751
Anam	0180
AOC	0030
Apex Digital	0748, 0765, 1943
Audiovox	0451, 0180, 0092
Bell & Howell	0154
Bradford	0180
Broksonic	0236, 0463, 1935, 1929, 1938
Candle	0030
Carnivale	0030
Carver	0054
Celebrity	0000
Celera	0765
Changhong	0765
Citizen	0060, 0030, 1928, 0092
Clarion	0180
Contec	0180
Craig	0180
Crosley	0054
Crown	0180
Curtis Mathes	0047, 0054, 0154, 0451, 0093, 0060, 0702, 0030, 0145, 0166, 1919, 1347
CXC	0180
Daewoo	0451, 1661, 0672, 1928, 0092
Denon	0145
Dumont	0017
Durabrand	0180, 0178
Dwin	0720
Electroband	0000
Elektra	0017, 1661
Emerson	0154, 0236, 0463, 0180, 0178, 0171, 1944, 1929, 1928
Envision	0030
Epson	0833
Fisher	0154
Fujitsu	0853, 0809, 0683
Funai	0180, 0171
Futuretech	0180
Gateway	1756, 1755
GE	0047, 0051, 0451, 0178, 1347, 1922, 1919, 1917
Gibraltar	0017, 0030
GoldStar	0030, 0178, 1926
Grunpy	0180
Hallmark	0178
Harman/Kardon	0054
Harvard	0180
Havermy	0093
Hello Kitty	0451
Himitsu	0180
Hisense	0748
Hitachi	1145, 0145
Hyundai	0849
Infinity	0054
Inteq	0017

TV (Continued)

Maker	Setup codes
JBL	0054
JCB	0000
JVC	0053
KEC	0180
Kenwood	0030
KLH	0765
KTV	0180, 0030
LG	0856
LXI	0047, 0054, 0154, 0156, 0178
Magnasonic	1928, 1913
Magnavox	0054, 0030, 1454, 0706, 1254, 1931, 1913
Marantz	0054, 0030
Matsushita	0250, 0650
Megatron	0178, 0145
Memorex	0154, 0463, 0150, 0178, 1926
MGA	0150, 0030, 0178
Midland	0047, 0017, 0051
Mitsubishi	0093, 0150, 1250, 0178, 1917
Monivision	0843
Motorola	0093
MTC	0060, 0030
Multitech	0180
NAD	0156, 0178, 0866
NEC	0030, 1704, 0497
Nikko	0030, 0178, 0092
Norcent	0748, 0824
NTC	0092
Onwa	0180
Optimus	0154, 0250, 0166, 1913, 0650
Optonica	0093
Orion	0236, 0463, 1929
Panasonic	0250, 0051, 0650, 1946, 1941, 1919
Penney	0047, 0156, 0051, 0060, 0030, 0178, 1926, 1919, 1347
Philco	0054, 0030
Philips	0054, 1454, 0690
Pilot	0030
Pioneer	0166, 0866, 0679
Portland	0092
Prism	0051
Proscan	0047, 1922
Proton	0178
Pulsar	0017
Quasar	0250, 0051, 1919, 0650
RadioShack	0047, 0154, 0180, 0030, 0178
RCA	0047, 1919, 0090, 1247, 1917, 1948, 1047, 1547, 1922, 0679, 1347
Realistic	0154, 0180, 0030, 0178
Runco	0017, 0030, 0497, 0603
Sampo	0030, 1755
Samsung	0060, 0812, 0702, 0030, 0178, 1060, 0766, 1903
Sansui	0463, 1929
Sanyo	0154, 0799
Scotch	0178
Scott	0236, 0180, 0178
Sears	0047, 0054, 0154, 0156, 0178, 0171, 1926
Sharp	0093, 0688, 1917, 0491, 0851, 0689

TV (Continued)

Maker	Setup codes
Sheng Chia	0093
Sony	0000, 0834, 1925
Soundesign	0180, 0178
Squareview	0171
SSS	0180
Starlite	0180
Supreme	0000
SVA	0748
Sylvania	0054, 0030, 0171, 1944, 1931
Symphonic	0180, 0171, 1913
Tandy	0093
Technics	0250, 0051
Techwood	0051
Teknika	0054, 0180, 0150, 0060, 0092
Telefunken	0702
TMK	0178
TNCi	0017
Toshiba	0154, 0156, 0060, 1935, 0650, 1704, 1945, 1356, 1936, 0832
TVS	0463
Vector Research	0030
Victor	0053
Vidikron	0054
Vidtech	0178
Viewsonic	1755
Wards	0054, 0030, 0178, 0866
Waycon	0156
White Westinghouse	0463
Yamaha	0030, 0769, 0833
Zenith	0017, 0463, 0178, 0092, 1929

Video Projector

Maker	Setup codes
Ampro	0751
Dwin	0720
Epson	0833
NEC	0497
RCA	0047
Runco	0603, 0497
Sanyo	0799
Sharp	0688, 0491, 0851, 0689
Sony	0834
Toshiba	0832
Yamaha	0833
Zenith	0017

TV/VCR Combination

Maker	Setup codes
Aiwa	1914
America Action	0180
Audiovox	0180
Broksonic	1929
Citizen	1928
Curtis Mathes	1919
Daewoo	1928
Emerson	0236, 1929, 1928
GE	1922, 1919, 1917
GoldStar	1926
Magnasonic	1928, 1913
Magnavox	1913, 1931

TV/VCR Combination (Continued)

Maker	Setup codes
Memorex	1926
Mitsubishi	1917
Optimus	1913
Orion	1929
Panasonic	1919
Penney	1926, 1919
Quasar	1919
RCA	1922, 1919, 1917
Sansui	1929
Sears	1926
Sony	1925
Sylvania	1931
Symphonic	1913
Toshiba	1936
Zenith	1929

TV/DVD Combination

Maker	Setup codes
Apex Digital	1943
Broksonic	1935
Panasonic	1941
RCA	1948
Samsung	1903
Sylvania	0171
Toshiba	1935

VCR

Maker	Setup codes
Admiral	0048
Aiwa	0037
American High	0035
Asha	0240
Audiovox	0037
Beaumark	0240
Bell & Howell	0104
Broksonic	0184, 0121
Calix	0037
Canon	0035
Carver	0081
Citizen	0037
Craig	0037, 0047, 0240
Curtis Mathes	0060, 0035, 0162
Cybernex	0240
Daewoo	0045
Denon	0042
Durabrand	0039
Electrohome	0037
Electrophonic	0037
Emerex	0032
Emerson	0037, 0184, 0121, 0043
Fisher	0047, 0104
Fuji	0035, 0033
GE	0060, 0035, 0240
GoldStar	0037
Harman/Kardon	0081
HI-Q	0047
Hitachi	0042
Hughes Network Systems	0042
JVC	0067
KEC	0037

VCR (Continued)

Maker	Setup codes
Kenwood	0067
Kodak	0035, 0037
LXI	0037
Magnavox	0035, 0039, 0081
Magnin	0240
Marantz	0035, 0081
Marta	0037
Matsushita	0035, 0162
MEI	0035
Memorex	0035, 0162, 0037, 0048, 0039, 0047, 0240, 0104
MGA	0240, 0043
MGN Technology	0240
Minolta	0042
Mitsubishi	0067, 0043
Motorola	0035, 0048
MTC	0240
NEC	0104, 0067
Nikko	0037
Noblex	0240
Olympus	0035
Optimus	0162, 0037, 0048, 0104
Orion	0184
Panasonic	0035, 0162, 0616
Penney	0035, 0037, 0240, 0042
Pentax	0042
Philco	0035
Philips	0035, 0081, 0618
Pilot	0037
Pioneer	0067
Polk Audio	0081
Profitronic	0240
Proscan	0060
Pulsar	0039
Quasar	0035, 0162
Radix	0037
Randex	0037
RCA	0060, 0240, 0042, 0880
Realistic	0035, 0037, 0048, 0047, 0104
ReplayTV	0616
Runco	0039
Samsung	0240, 0045
Sanky	0048, 0039
Sansui	0067
Sanyo	0047, 0240, 0104
Scott	0184, 0045, 0121, 0043
Sears	0035, 0037, 0047, 0042, 0104
Sharp	0048
Shogun	0240
Sonic Blue	0616
Sony	0035, 0032, 0033, 0636
STS	0042
Sylvania	0035, 0081, 0043
Technics	0035, 0162
Teknika	0035, 0037
Tivo	1503, 0636, 0618
TMK	0240
Toshiba	0045, 0043, 1503
Totevision	0037, 0240
Unitech	0240
Vector	0045

VCR (Continued)

Maker	Setup codes
Video Concepts	0045
Videomagic	0037
Videosonic	0240
Wards	0060, 0035, 0048, 0047, 0081, 0240, 0042
XR-1000	0035
Zenith	0039, 0033

PVR

Maker	Setup codes
Panasonic	0616
Philips	0618
ReplayTV	0616
Sonic Blue	0616
Sony	0636
Tivo	0636, 0618

DVD player

Maker	Setup codes
Allegro	0869
Apex Digital	0672, 0717, 0796, 0794, 1061
Blaupunkt	0717
Blue Parade	0571
CineVision	0876, 0869
CyberHome	0816
Daewoo	0784, 0833
Denon	0490
DVD2000	0521
Emerson	0591, 0675
Enterprise	0591
Fisher	0670
Funai	0675
GE	0522, 0815, 0717
Go Video	0715, 0783
Greenhill	0717
Hitachi	0573, 0664
Hiteker	0672
Initial	0717
InterAct	0697
JVC	0558, 0623, 0867
Kenwood	0490, 0534
KLH	0717, 1020
Koss	0651
Lasonic	0798
Mad Catz	1108, 1002
Magnavox	0503, 0675
Marantz	0539
Microsoft	0522
Mintek	0717
Mitsubishi	1521, 0521
Nesa	0717
Norcent	1003
Onkyo	0503
Oritron	0651
Panasonic	0490, 1762
Pelican Accessories	0731
Philips	0503, 0539, 0646
Pioneer	0525, 0571
Polk Audio	0539
Proscan	0522

DVD player (Continued)

Maker	Setup codes
Qwestar	0651
RCA	0522, 0571, 0717, 0822
Rio	0869
Rotel	0623
Saitek	0731
Samsung	0490, 0573, 1075, 0820
Sanyo	0670, 0873
Sharp	0630
Shinsonic	0533
Sonic Blue	0869
Sony	0533, 0864, 0772, 1033
Sylvania	0675
Symphonic	0675
Technics	0490
Theta Digital	0571
Thrustmaster	0498
Toshiba	0503
Tredex	0799
Urban Concepts	0503
Xbox	0522
Yamaha	0490, 0539, 0545
Zenith	0503, 0591, 0869

Setup code chart (RC-R0730E) (For Europe)

Even when a component is manufactured by a maker listed in the setup code chart, it may be unable to be registered depending on the model and year of production. Also, when a setup code of a non-KENWOOD maker is registered, certain component models may be unable to be controlled or only the limited functions may be controllable. In this case, it is recommended to use the remote control unit provided with the system component. For how to register the setup codes, read '**Registering setup codes for other components**' carefully. → 45

Cable Converters

Maker	Setup codes
ADB	1063
Birmingham Cable Communications	0276
Cable & Wireless	1068
Decsat	0423
Filmnet	0443
Golden Channel	1110, 1063
HyperVision	0619
Jerrold	0276
MNET	0443
Noos	0817
NTL	1068
Ono	1068
Pace	1068, 1060
Philips	0619
Sagem	0817
Supercable	0276
Tele Danmark	1016
Tele+1	0443
Telewest	1068
Thomson	1110
Visionetics	1064

CD player

Maker	Setup codes
Arcam	0157
Audio Research	0157
Audiolab	0157
Audiomeca	0157
Audioton	0157
Cairn	0157
Cyrus	0157
DMX Electronics	0157
Grundig	0157
Kenwood	0028, 0190, 0626, 1059, 0523, 0692, 0681 0338, 0339, 0826, 0340, 0858, 0859, 1490, 1338
Linn	0157
Marantz	0157
Matsui	0157
Meridian	0157
Micromega	0157
Myryad	0157
Naim	0157
Philips	0157, 0626
Quad	0157
Revox	0157
Rotel	0157
Sharp	0037
Simaudio	0157

CD player (Continued)

Maker	Setup codes
TAG McLaren	0157
Thorens	0157
Thule	0157
Toshiba	0692
Trio	0677
Universum	0157
Yamaha	0036

MD recorder

Maker	Setup codes
Kenwood	1059, 0681, 1339

Satellite Receivers

Maker	Setup codes
@sat	1300
@Sky	1334
ABsat	0123
Amstrad	0847, 0811, 0501
Arcon	1205
Aston	1261
Astro	0173, 0548, 0501
Atsat	1300
AtSky	1334
Blaupunkt	0173
British Sky Broadcasting	0847, 1175, 1848
Canal Digital	0853
Canal Satellite	0853, 1339
Canal+	0853
CityCom	0115, 1176
Clark	0811
Conrad	0115
Cyrus	0200
D-box	0873
Daewoo	1201, 1296
Digenius	1161, 0299
Distratel	0885
DMT	1075
DNT	0200
Dream Multimedia	1237
Echostar	0853, 0167, 0610, 1086, 0511, 0871, 0775
Engel	1017
Fidelity	0811
Force NO AS	1101, 1194
Fracarro	0871
FTE	0811, 1121, 0863
Galaxis	1111, 0283, 1101, 0863
GbSAT	1214
GOI	0775
Gold Box	0853
Gooding	0571
Goodmans	1284
Grundig	0847, 0173, 0750, 1150, 0571, 0805, 1330
Hauppauge	1298
HDT	1011, 1159
Hirschmann	0173, 0573, 0501, 1085, 0882
HTS	0775
Humax	0283, 1176, 1048, 0863
Hyundai	1159, 1011
InVideo	0871

Satellite Receivers (Continued)

Maker	Setup codes
JVC	0571, 0775
Kathrein	0173, 0200, 1057, 0658, 1221, 0123, 0249, 1058
Kreiselmeyer	0173
Labgear	1296
Logix	1017
Lorenzen	0299
Luxor	0573
Manhattan	1083, 1017
Marantz	0200
Maspro	0750
Matsui	0571
MediaSat	0853
Medion	1232
Metronic	1216, 1210, 1334
Micronik	1003
Minerva	0571
Morgan's	1103
Multichoice	0879, 0642
Myryad	0200
Netgem	1322
Neuhaus	0501
NextWave	1239, 1143, 1119
Nokia	0751, 0873, 1023, 1311, 1310, 1223, 1723, 0573
Opentel	1232
Optex	1069
Orbitech	1100, 0501
Pace	0847, 1175, 0241, 0867, 1323, 0791
Palladium	0571
Palsat	0501
Panasat	0879
Panasonic	0847, 1104, 1320
Philips	0853, 0200, 0805, 0133, 0750, 0571
Pioneer	0853, 0352, 0329
Pixx	0552
Praxis	0629
Preisner	1262
Radiola	0200
Radix	1317, 0882
Rebox	1214
RFT	0200
Saba	0885
Sagem	0820, 1114, 1307
Samsung	1244, 1243, 1293, 1017, 1292
Sat Control	1300
SatPartner	0811
Satstation	1083
Schneider	0805
Schwaiger	1111, 0552
SEG	1191, 1087
Siemens	0173
SKY	0847, 1175, 1848
SM Electronic	1200, 0587
Sony	0847, 0278
Strong	0879, 1105, 1158, 1157, 1146, 1159
Supermax	1143
TechniSat	0501, 1100, 1099, 0548
Technosat	0839

Satellite Receivers (Continued)

Maker	Setup codes
Telestar	1100, 0501, 1202
Thomson	0853, 1046, 0265, 1291
Topfield	1207, 1206
TPS	0820, 1307
Triasat	0501
Triax	0115
Universum	0173, 0571
Ventana	0200
Vortec	0815
WinsTec	1240, 1241
Wisi	0173
Wisplus	1258
Xsat	0123, 1323
Zehnder	1075, 0552, 1251

TV

Maker	Setup codes
Acura	0009
Admiral	0087, 0163
Adyson	0217
AGB	0516
Aiwa	1916, 0701
Akai	0361, 0208, 0602, 0516, 0696
Akura	0264, 0218
Alba	0037, 0668, 0218, 0036, 0235, 0009, 0581, 0371
Amplivision	0217
Amstrad	0037, 0433, 0412, 0009, 0371, 0516, 0177
Anitech	0009
Arcam	0216, 0217
ASA	0104, 0087
Asuka	0218
Atlantic	0206
Audiosonic	0037, 0109
Autovox	0206, 0087
Bang & Olufsen	0565, 0087
Barco	0479, 0410
Basic Line	0218, 0009
Baur	0037, 0361, 0512, 0349
Beaumark	0178
Beko	0714, 0486, 0715, 0370
Beon	0037
Binatone	0217
Blaupunkt	0195, 0191
Blue Sky	0668, 1037, 0218
Blue Star	0282
Boots	0217
BPL	0282
Brandt	0109, 0335
Brionvega	0087
Britannia	0216
Bruns	0087
BTC	0218
Bush	0037, 0668, 1037, 0698, 0218, 0036, 0282, 0371, 0581, 0009, 0355, 0519, 0349, 0374, 1900
Carrefour	0036
Cascade	0009
Cathay	0037

TV (Continued)

Maker	Setup codes
Centurion	0037
Century	0087
Cimline	0009
Clarivox	0037
Clatronic	0370
Condor	0370, 0320
Conrac	0808
Contec	0036, 0009, 0216
Crosley	0087
Crown	0037, 0370, 0579, 0009, 0418
CS Electronics	0216
Cybertron	0218
Daewoo	0037, 0634, 1909, 0374, 1902, 0009, 0499
Dainichi	0218
Dansai	0037
Dayton	0009
De Graaf	0548, 0208
Decca	0037, 0516, 0072
Digatron	0037
Dixi	0037, 0009
Dual	0519
Dual Tec	0217
Dumont	0087, 0070
Eiki	0735
Elbe	0259
Elin	0037, 0548
Elite	0218, 0320
Elta	0009
Emerson	1909, 0361, 0087
Erres	0037, 0012
Europhon	0516
Expert	0206
Ferguson	0037, 0560, 0073, 0193, 0190, 0335, 0109, 0238
Fidelity	0361, 0216, 0193
Finlandia	0208, 0346
Finlux	0037, 0070, 0104, 0411, 0087, 0346, 0072, 0105, 0516
Firstline	0668, 0216, 0009, 0217
Fisher	0370, 0208, 0104, 0217
Flint	0455
Forgestone	0193
Formenti	0037, 0087, 0320
Frontech	0264, 0163
Fujitsu	0683, 0206, 0072, 0853
Funai	0264
GE	1907, 0735, 1922
GEC	0037, 0072, 0516, 0217
Geloso	0009
Genexxa	0218, 0163
GoldStar	0037, 0217, 0178, 0109, 0377
Goodmans	0037, 0634, 1909, 0036, 0072, 0371, 0235, 0499, 0217, 0374, 1900
Gorenje	0370
GPM	0218
Graetz	0361, 0163
Granada	0037, 0208, 0516, 0072, 0339, 0045, 0217
Grandin	0610, 0282
Grundig	0556, 0195, 0487, 0587, 0070, 1935, 0191

TV (Continued)

Maker	Setup codes
Hanimex	1908
Hanseatic	0556, 0037, 0361, 0320
Hantarex	0516
Havermy	0093
HCM	0412, 0282, 0009
Hinari	0037, 0218, 0036, 1908, 0009
Hisawa	0455, 0282
Hitachi	0548, 1037, 0036, 0225, 0105, 0217, 0356, 0578, 0044, 0163, 0349, 0744, 1225, 0109, 0481, 0719, 1045
Huanyu	0374, 0216
Hypson	0037, 0264, 0282
ICE	0264, 0371, 0217
ICeS	0218
Imperial	0370, 0418
Indiana	0037
Ingelen	0163
Inno Hit	0072, 0516
Interfunk	0037, 0361, 0163, 0512
Intervision	0037, 0264, 0102, 0377, 0217
Isukai	0218
ITS	0371
ITT	0548, 0361, 0163
JVC	0606, 0036, 0653, 0371, 0683, 0190
Kaisui	0218, 0216, 0282, 0009, 0217
Kapsch	0206, 0163
Karcher	0610
Kathrein	0556
Kendo	0037, 0235
Kingsley	0216
Kneissel	0435, 0259
Konka	0725, 0726
Korpel	0037
Korting	0087
Koyoda	0009
L&S Electronic	0808
Leyco	0037, 0264, 0072
LG	0037, 0714, 1934, 0823
Liesen & Tter	0037
Loewe	0790, 0512, 0087, 0791, 0633
Luma	0206
Luxor	0361, 0194, 0356, 0349
M Electronic	0037, 0480, 0104, 0163, 0374, 0109, 0346, 0009, 0105, 0217
Magnadyne	0516, 0102, 0087
Magnafon	0516, 0102
Magnin	1907
Magnum	0648
Manesth	0264, 0235, 0217, 0320
Manhattan	0778
Marantz	0556, 0037
Marelli	0087
Mark	0037
Matsui	0037, 0487, 0036, 0579, 0035, 0072, 0217, 0371, 0516, 0011, 0208, 0355, 0009, 0177, 0235, 0443
Maxivideo	0792
Mediator	0037, 0012
Medion	0668, 1037, 0808
Memorex	1037, 0009

TV (Continued)

Maker	Setup codes
Memphis	0337
Metronic	0625
Metz	0275, 0746, 0087, 0447, 0367
MGA	1907
Micromaxx	0808
Microstar	0808
Minerva	0487, 0070
Minoka	0412
Mirror	1900
Mitsubishi	0036, 0108, 0087, 0512
Mivar	0292, 0216, 0609, 0516
MTC	0512, 0349
Multitech	0216, 0102, 0009
Myryad	0556
NEC	0704, 0170, 1704
Neckermann	0556, 0037, 0087, 0349, 0191
NEI	0037, 0337
Nikkai	0037, 0264, 0218, 0035, 0216, 0337, 0072
Noblisko	0102
Nokia	0548, 0606, 0361, 1912, 0480, 0631
Nordmende	0560, 0109
Oceanic	0361, 0163
Onwa	0433
Orion	0037, 0177, 0355, 0655, 0320, 0516, 0235, 0443
Osaki	0264, 0218, 0217, 0412, 0072
Oso	0218
Osume	0072
Otto Versand	0556, 0037, 0036, 0512, 0191, 0349, 0320, 0217
Palladium	0370, 0418
Panama	0264, 0217
Panasonic	0650, 0226, 0163, 1930, 0367, 1650, 0850
Pathe Cinema	0320, 0238, 0216
Pausa	0009
Penney	1907
Perdio	0320
Philco	0087
Philips	0556, 0037, 0087, 0374, 0012, 0193, 0721
Phoenix	0087
Phonola	0037, 0012, 0087
Pioneer	0760, 0163, 0109
Plus	0771
Polytron	0697
Prandoni-Prince	0516
Profex	0361, 0009
Protech	0037, 0668, 0264, 0009, 0217, 0418, 0102, 0337
Pye	0037, 0012
Quelle	0037, 0361, 0011, 0104, 0070, 0512
Questa	0036
R-Line	0037
Radiola	0037, 0012
Radiomarelli	0087, 0516
Rank Arena	0036
RBM	0070
RCA	1922, 1907
Rediffusion	0361

TV (Continued)

Maker	Setup codes
Reoc	0714
Revox	0037
Rex	0264, 0206, 0163, 0259
RFT	0087
Roadstar	0264, 0218, 0009, 0418
Saba	0109, 0087, 0335, 0163
Saccs	0238
Sagem	0610, 0830
Saisho	0264, 0011, 0009, 0235, 0177, 0516
Salora	0548, 0361, 0194, 0163, 0356, 0349
Sambers	0516, 0102
Samsung	0556, 0037, 0264, 0370, 0587, 0618, 0009, 0217, 0644, 0060
Sandra	0216
Sansui	0655
Sanyo	0036, 0104, 0735, 0011, 0072, 0339, 1907, 0045, 0208, 0799
SBR	0037, 0012, 0193
Schaub Lorenz	0361
Schneider	0037, 0668, 1137, 0218, 0371
SEG	0668, 1037, 0264, 0036, 0217
SEI	0177, 0102, 0087, 0516
Seleco	0206, 0163, 0411, 0259
Sentra	0035
Sharp	0036, 1193, 0818, 0093
Siarem	0516, 0102, 0087
Siemens	0037, 0195, 0191
Silver	0036
Singer	0087
Sinudyne	0087, 0235, 0177, 0102, 0516
Skantic	0356
Skysonic	0696
Solavox	0163
Sonitron	0208
Sonoko	0037, 0009
Sonolor	0163, 0208
Sontec	0037
Sony	1505, 0036, 0011, 0732, 0353, 1010, 0742, 1651
Soundwave	0037, 0418
Standard	0218, 0009, 0217
Stern	0163, 0259, 0206
Sunkai	0355
Susumu	0218
SVA	0587
Sysline	0037
T + A	0447
Tandy	0218, 0163, 0072, 0217
Tashiko	0036, 0217
Tatung	0037, 0217, 0072, 0516
TCM	0808
Teac	0037, 0698, 0712, 1949, 0721
Tec	0217
Technema	0320
Technics	0650
Telefunken	0625, 0335, 0109
Telemagic	0735
Telemeister	0320
Teletech	0009
Teleton	0036, 0349, 0217, 0206

TV (Continued)

Maker	Setup codes
Tensai	0218, 0320
Texet	0218, 0216
Thomson	0625, 0560, 0349, 0109
Thorn	0037, 0361, 0190, 0499, 0035, 0104, 0072, 0193, 0512
Tomashi	0282
Toshiba	0036, 0618, 0508, 0035, 1508, 0070, 0718
Triumph	0177, 0516
Uher	0320, 0206
Ultravox	0102
Universum	0037, 0264, 0370, 0104, 0346, 0492, 0421, 0105, 1901
Vestel	0037
Videotechnic	0217
Vision	0320
Voxson	0163, 0087
Wallis	0792
Waltham	0356, 0217
Watson	0037, 0320
Watt Radio	0102
Wega	0036, 0087
White Westinghouse	0037, 0216, 0320
Yoko	0037, 0264, 0217
Zanussi	0206

Video Projector

Maker	Setup codes
Barco	0479, 0410
Eiki	0735
GE	0735
JVC	0683
LG	0823
Maxivideo	0792
Plus	0771
Sanyo	0799, 0735
Sony	0742, 0732, 0353
Wallis	0792

TV/VCR Combination

Maker	Setup codes
Aiwa	1916
Daewoo	1909
Emerson	1909
GE	1907, 1922
Goodmans	1909
Hanimex	1908
Hinari	1908
LG	1934
Magnin	1907
MGA	1907
Nokia	1912
Panasonic	1930
Penney	1907
RCA	1922, 1907
Sanyo	1907

TV/DVD Combination

Maker	Setup codes
Bush	1037, 1900
Daewoo	1902
Goodmans	1900
Grundig	1935
Mirror	1900
Teac	0698, 1949 1935

VCR

Maker	Setup codes
Aiwa	0348, 0000, 0307
Akai	0315, 0106, 0041
Alba	0278, 0315
Amstrad	0000
ASA	0081, 0037
Asuka	0037
Baird	0000, 0041
Bang & Olufsen	0499
Basic Line	0278
Blaupunkt	0226, 0034
Brandt	0320
Brandt Electronic	0041
Bush	0278
CGE	0000
Crown	0278
Cyrus	0081
Daewoo	0278, 0637, 0642, 0561
De Graaf	0042, 0166
Decca	0081, 0000
Denon	0042
Dual	0041
Dumont	0081, 0000, 0105
Emerson	0637, 0561
ESC	0278, 0240
Fast	0897
Ferguson	0320, 0041
Fidelity	0000
Finlandia	0081
Finlux	0081, 0000, 0042, 0105
Firstline	0037, 0045, 0043
Fisher	0047, 0046
Funai	0000
GEC	0081
GoldStar	0037
Goodmans	0278, 0637, 0037, 0000
Graetz	0041, 0240
Granada	0081, 0046
Grandin	0037, 0000
Grundig	0081, 0226, 0034, 0349, 0080, 0347
Hanseatic	0037
Hinari	0240
Hitachi	0000, 0042, 0240, 0041, 0166, 0105
Imperial	0000
Interfunk	0081
ITT	0384, 0106, 0041, 0240, 0046
ITV	0278, 0037
JVC	0384, 0067, 0041, 0008
Kendo	0106
Kenwood	0041
Lenco	0278
Loewe	0081, 1562, 0037, 0080, 0866

VCR (Continued)

Maker	Setup codes
Logik	0240
Luxor	0048, 0043, 0106, 0046
M Electronic	0000
Manesth	0045
Marantz	0081, 0146
Matsui	0348
Medion	0348
Memorex	0037, 0000, 0046
Metronic	0081
Metz	1562, 0037, 0347
Mitsubishi	0081, 0067, 0043
Multitech	0000
Murphy	0000
Myryad	0081
NEC	0067, 0041
Neckermann	0081
Nokia	0106, 0046, 0041, 0240
Nordmende	0320, 0384, 0041
Oceanic	0000, 0041
Okano	0348, 0315
Orion	0348
Osaki	0037, 0000
Otto Versand	0081, 0080
Palladium	0037, 0041
Panasonic	1562, 0226
Pathe Marconi	0041
Pentax	0042, 0105
Perdio	0000
Philips	0081, 0384, 0080, 0146
Phonola	0081, 0080
Pioneer	0081, 0067
Profitronic	0240
Proline	0000
Pye	0081
Quartz	0046
Quelle	0081, 0080
Radiola	0081
Reoc	0348
Rex	0384, 0041
Roadstar	0278, 0037, 0240
Saba	0320, 0384, 0041
Salora	0043, 0106, 0046
Samsung	0432, 0240
Sansui	0067, 0041
Sanyo	0046
SBR	0081, 0080, 0146
Schaub Lorenz	0000, 0041
Schneider	0081, 0000, 0897
SEG	0240
SEI	0081
Seleco	0041
Sharp	0048, 0569
Siemens	0081, 0037, 0146
Silva	0037
Singer	0045
Sinudyne	0081
Sonolor	0046
Sontec	0037
Sony	0032, 0034, 0033, 1032
Sunkai	0348
Sunstar	0000
Suntronic	0000

VCR (Continued)

Maker	Setup codes
Tashiko	0000
Tatung	0081, 0000, 0041
Technics	0226
Teleavia	0041
Telefunken	0320, 0384, 0041
Tensai	0000
Thomson	0320, 0384, 0067, 0722, 0041
Thorn	0041
Tivo	0722
Toshiba	0081, 0384, 0045, 0043, 0041, 1008
Uher	0240
Universum	0081, 0037, 0000, 0106, 0240
Videomagic	0037
Villain	0000
Wharfedale	0615
Yoko	0240

DVD player

Maker	Setup codes
Acoustic Solutions	0730
Afreey	0698
Aiwa	0641
Alba	0717
Amoisonic	0764
Amstrad	0713
Apex Digital	0795, 0672
Bush	0811, 0713, 0690
Cat	0789, 0787, 0786
Clatronic	0788
Clayton	0713
CyberHome	0714, 0816
Cytron	0716
Daewoo	0770, 0833, 0832
Dansai	0770
Decca	0770
Denon	0490, 0634
Denver	0778
DiViDo	0705
Enterprise	0591
Gamester	1030
GoldStar	0741
Goodmans	0790, 1004
GPX	0769
Greenhill	0717
Grundig	0539, 0695, 0775, 0705, 0701
H & B	0841, 0818
Harman/Kardon	0702
Himage	0518
Hitachi	0664
Hiteker	0672
HiMAX	0843
Jaton	0665
JMB	0695
Joytech	0776
JVC	0623, 0558
Kenwood	0490, 0737, 0534
Kiss	0841, 0665
Konka	0711
Lasonic	0743
Lecson	0696

DVD player (Continued)

Maker	Setup codes
Lenco	0774
Lenoxx	0819
LG	0741, 0591
Limit	0768
Logix	0783
Mebeteck	0562
Mediencom	0746
Metronic	0690
MiCO	0723
Minato	0752
Minowa	0712
Mirror	0752
Mitsubishi	0521
Monyka	0665
Mustek	0730
NAD	0692
Olidata	0672
Onkyo	0627
Optim	0747
Oritron	0651
Panasonic	0490, 1010
Philco	0690
Philips	0539, 0646
Pioneer	0571, 0525, 0631
Proline	0686
REC	0689
Redstar	0763, 0748
Remotec	0767
Reoc	0752
Revoy	0699
Roadstar	0689
Rotel	0623
Samsung	0573, 0744
Sanyo	0670
Schneider	0783
Schwaiger	0752
Scott	0718
Sharp	0630
Sherwood	0633
Shinco	0717
Skyworth	0766
SM Electronic	0730, 0690
Sony	0533, 0772, 1533, 1033
Tatung	0770, 0771
Teac	0759
Technics	0490
TerraTec	0825
Thomson	0551, 0522
Tokai	0665
Toshiba	0503, 1045
Tredex	0799, 0843
Umax	0531, 0690
Universum	0591
Wesder	0699
Wharfedale	0686, 0696
Xbox	0522
Xoro	0806
Xwave	0709
Yamada	1004
Yamakawa	0765, 0710, 0665
Yelo	0780

DVD player, MD recorder CD player & TV operations

Refer to the following for the type of remote control operations available for each component.

- ❶ Select the input source.
- ❷ Press the keys corresponding to the operations you desire. Refer to the following sections for details.

- When pressing keys in succession, press each key firmly and be sure to wait at least 1 second before pressing the next key.
- Numeric keys function the same as the numeric keys on the original remote.

These keys can be used to perform the basic operations of KENWOOD and other manufacturers' components which the setup code for each component had been entered beforehand. - 47 - 51

DVD player operation keys

MD recorder operation keys (made by KENWOOD)

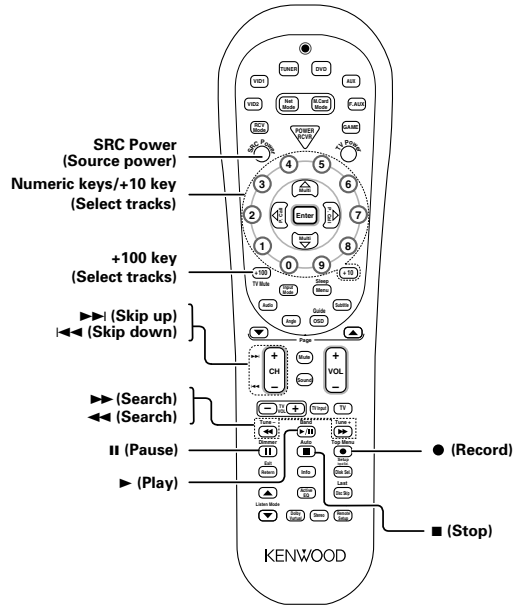
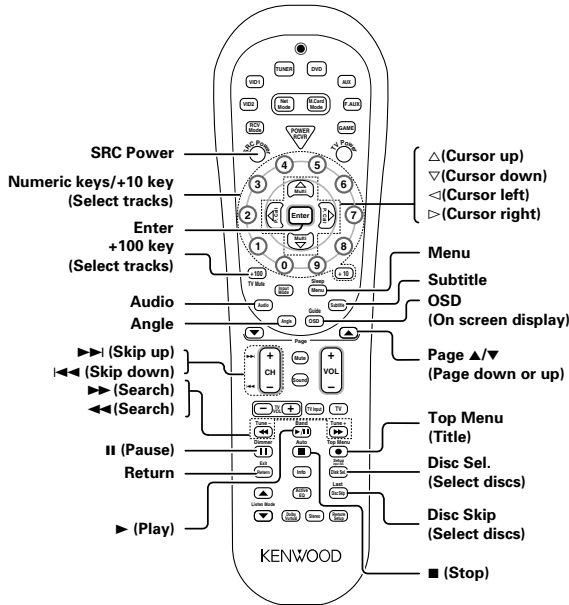

CD player operation keys

TV operation keys (including TVs incorporating VCR)

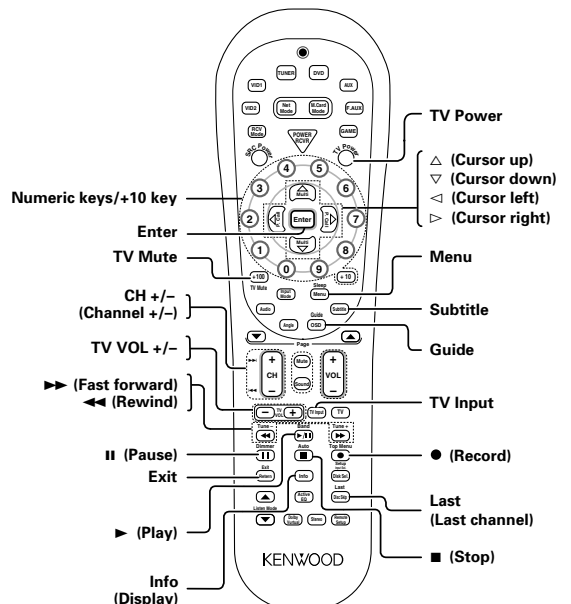
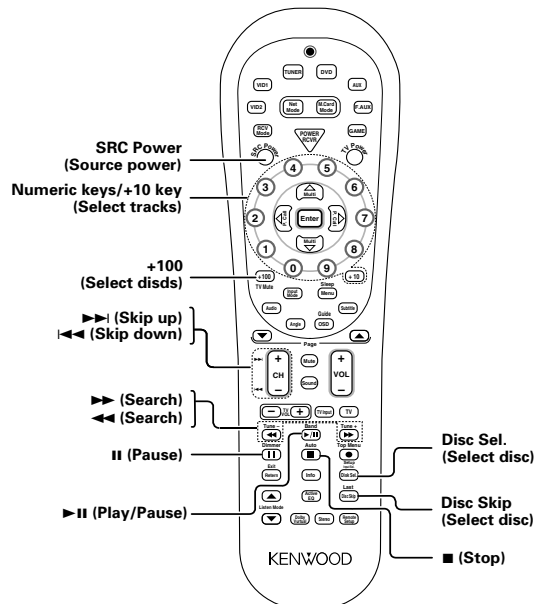

VCR, Satellite receiver & Cable converter operations

Refer to the following for the type of remote control operations available for each component.

- ❶ Select the input source.
- ❷ Press the keys corresponding to the operations you desire. Refer to the following sections for details.

- When pressing keys in succession, press each key firmly and be sure to wait at least 1 second before pressing the next key.
- Numeric keys function the same as the numeric keys on the original remote.

These keys can be used to perform the basic operations of KENWOOD and other manufacturers' components which the setup code for each component had been entered beforehand. - 47 - 51

VCR operation keys

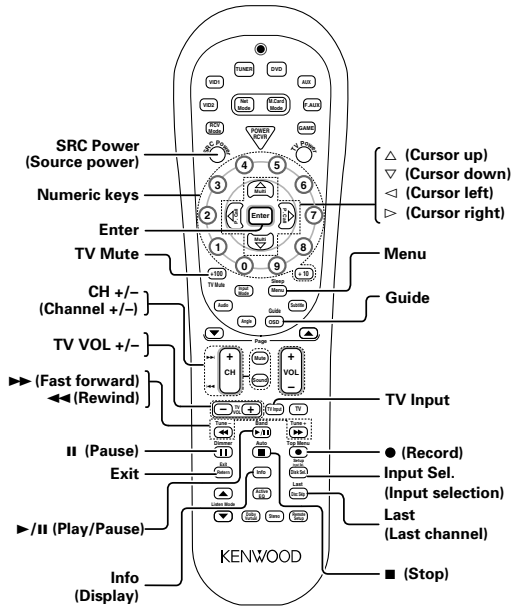

Satellite receiver operation keys

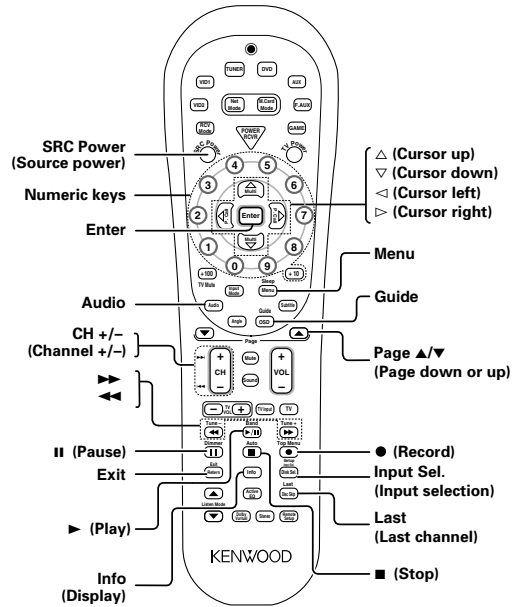

Cable converter operation keys

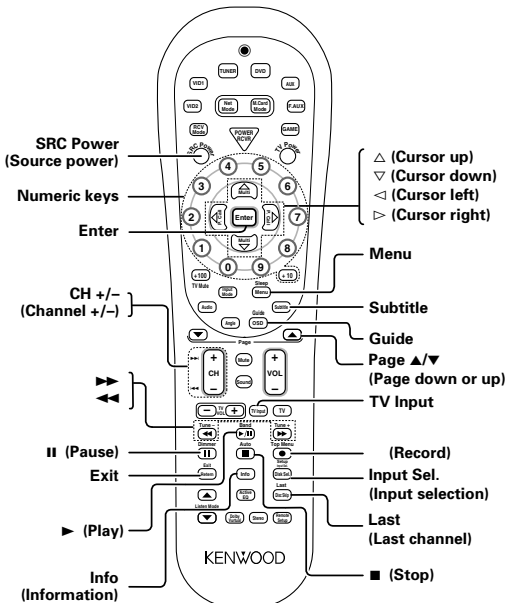

Sirius operation keys (made by KENWOOD)

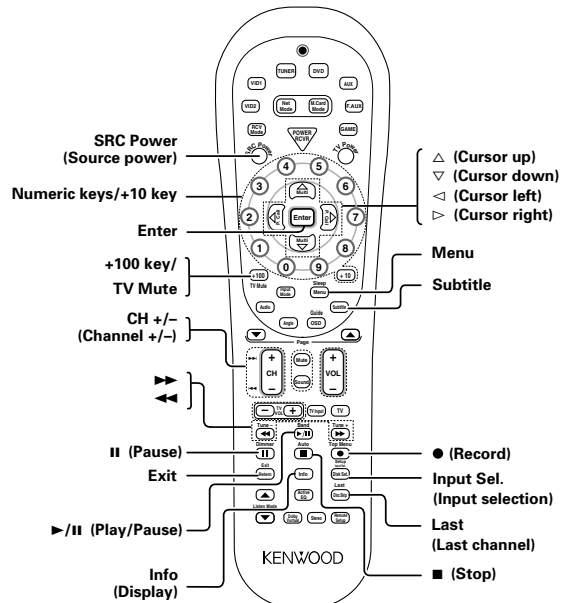

In case of difficulty

Resetting the Microcomputer

The microcomputer may malfunction (unit cannot be operated, or shows an erroneous display) if the power cord is unplugged while the power is ON, or due to some other external factor. If this happens, execute the following procedure to reset the microcomputer and return the unit to its normal operating condition.

Unplug the power cord from the wall outlet, then plug it back in while holding down the POWER ON/STANDBY \odot (For U.S.A and Canada) or ON/STANDBY \odot key (For Europe and Australia).

- Please note that resetting the microcomputer will clear the contents of the memory and returns the unit to the state it was in when it left the factory.

Amplifier

Symptom	Remedy
No sound from the speakers.	<ul style="list-style-type: none"> ● Connect them properly referring to "Connecting the speakers" --13 ● If muting is ON, release it. --31 ● If headphones are connected, disconnect them. --30 ● Press the Input Mode key to select to full auto mode. --8 ● Check if the assignment of digital audio input jacks is correct. --28
Sound is not output from the speaker, or their sound is very small.	<ul style="list-style-type: none"> ● Connect them properly referring to "Connecting the speakers" --13 ● See "Speaker settings" and check if the setting for all of the speakers is correct. --24 ● Select a surround mode. ● Adjust the speaker levels using the test tone. --26
The standby indicator blinks and sound is not output.	<ul style="list-style-type: none"> ● The protection circuitry is activated because speaker cords are short-circuited. Disconnect the power cord from the AC wall outlet, switch the receiver OFF, remove the short-circuiting and turn the receiver ON again. ● The protection circuitry is activated because the output power is too high. Turn this unit OFF then ON again and reduce the output volume level. ● The protection circuitry activated due to extreme rise in temperature. Turn this unit OFF then ON again and reduce the output volume level. ● The protection circuitry is activated because the impedance of the speakers in use is lower than specified. Use speakers of the specified impedance.
The audio and video of a different channel are output.	<ul style="list-style-type: none"> ● Check if the assignment of digital audio input jacks and component video jacks is correct. --28
The video is not output.	<ul style="list-style-type: none"> ● Connect the video source to be played to this unit and this unit to the monitor TV using the same type of cords (Component video cords, S VIDEO cords or yellow RCA video cords) correctly. --10
Audio cannot be recorded.	<ul style="list-style-type: none"> ● Connect the equipment correctly by referring to "Connecting video components, audio components" and "Digital connections". --10 --12 ● If it is the digital audio that you attempt to record, set up the unit correctly by referring to "Recording music in REC mode". --32
A video source cannot be recorded normally.	<ul style="list-style-type: none"> ● Copy-guarded video software cannot be recorded. ● The S VIDEO and component video inputs cannot be recorded. Connect the video source to the yellow RCA video jack. --10
When playing a digital source signal, the sound is cut off soon after it starts.	<ul style="list-style-type: none"> ● There are many possible causes for this problem, depending on the type of player used. Switch the input mode to DIGITAL MANUAL during playback of the digital source, and restart the playback from the beginning. --8
Dolby Digital or DTS audio software cannot be played in multi-channel audio.	<ul style="list-style-type: none"> ● Check if the digital output setting of the digital audio player is correct.
The audio of a satellite digital broadcasting cannot be switched.	<ul style="list-style-type: none"> ● With certain broadcasting, the audio cannot be switched on the receiver. In this case, switch the audio on your satellite digital tuner.
The input for the unit is set automatically to "GAME" when the unit is turned ON.	<ul style="list-style-type: none"> ● The GAME mode function is activated. --27

Tuner

Symptom	Remedy
Radio stations cannot be received.	<ul style="list-style-type: none"> ● Connect an antenna properly. → 18 ● Set the broadcast band properly. → 33 ● Tune the frequency of the desired station.
Interference.	<ul style="list-style-type: none"> ● Install the outdoor antenna away from the road. ● Turn off the power to the appliance. ● Install the receiver farther away from the TV.
A station which was preset cannot be received by pressing the corresponding numeric key.	<ul style="list-style-type: none"> ● Preset a station with a receivable frequency.

Remote control unit

Symptom	Remedy
Control of another component is impossible.	<ul style="list-style-type: none"> ● Register its setup code correctly. → 45
Remote control operation is not possible.	<ul style="list-style-type: none"> ● Press the input selector key and select the optimum control mode. ● Replace with new batteries. ● Point the remote control unit to the remote sensor of the receiver. → 19 ● Connect them properly referring to "Setting up the system" ● The remote control has not been set to the operation mode for the component you wish to control. Press the source select keys or SRC Power key to activate the operation mode for the component you want to control before operation. → 46

Memory back-up function

If the power supply to the receiver is shut down for about a day or more, the following settings will be reset to the initial conditions. Please be careful.

- Power mode = OFF
- Volume level = - 66 dB
- Dimmer level = OFF (Brightest condition)
- Broadcast band = FM
- Frequency setting = 87.50 MHz
- Tuning mode = AUTO

For the U.S.A.

Note to CATV system installer

This reminder is provided to call the CATV system installer's attention to Article 820-40 of the NEC that provides guidelines for proper grounding and, in particular, specifies that the cable ground shall be connected to the grounding system of the building, as close to the point of cable entry as practical.

For the U.S.A.

FCC WARNING

This equipment may generate or use radio frequency energy. Changes or modifications to this equipment may cause harmful interference unless the modifications are expressly approved in the instruction manual. The user could lose the authority to operate this equipment if an unauthorized change or modification is made.

NOTE:

This equipment has been tested and found to comply with the limits for a Class B digital device, pursuant to Part 15 of the FCC Rules. These limits are designed to provide reasonable protection against harmful interference in a residential installation. This equipment may cause harmful interference to radio communications, if it is not installed and used in accordance with the instructions. However, there is no guarantee that interference will not occur in a particular installation. If this equipment does cause harmful interference to radio or television reception, which can be determined by turning the equipment off and on, the user is encouraged to try to correct the interference by one or more of the following measures:

- Reorient or relocate the receiving antenna.
- Increase the separation between the equipment and receiver.
- Connect the equipment into an outlet on a circuit different from that to which the receiver is connected.
- Consult the dealer or an experienced radio / TV technician for help.

For the U.S.A.



As an ENERGY STAR® Partner, Kenwood Corporation has determined that this products meets the ENERGY STAR® guidelines for energy efficiency. This product can save energy. Saving energy reduces air pollution and lowers utility bills.

Specifications (For U.S.A., Canada and Australia)

AUDIO section

For U.S.A., and Canada

Rated power output during STEREO operation

70 watts per channel minimum RMS, both channels driven, at 8 Ω from 20 Hz to 20 kHz with no more than 0.7% total harmonic distortion. (FTC)

100 watts per channel minimum RMS, both channels driven, at 6 Ω from 20 Hz to 20 kHz with no more than 0.7% total harmonic distortion.

Effective power output during STEREO operation ... 130 W + 130 W
(1 kHz, 10% T.H.D. at 6 Ω)

For Australia

Rated power output during STEREO operation

70 watts per channel minimum RMS, both channels driven, at 8 Ω from 20 Hz to 20 kHz with no more than 0.7% total harmonic distortion. (FTC)

Rated power output during STEREO operation .. 100 W + 100 W
DIN/IEC (20 Hz ~ 20 kHz, 0.7% T.H.D. at 6 Ω)

Effective power output during STEREO operation ... 130 W + 130 W
(1 kHz, 10% T.H.D. at 6 Ω)

Effective power output during SURROUND operation

FRONT 100 W + 100 W
(1 kHz, 0.5% T.H.D. at 6 Ω one channel driven)
130 W + 130 W
(1 kHz, 10% T.H.D. at 6 Ω one channel driven)

CENTER 100 W
(1 kHz, 0.5% T.H.D. at 6 Ω one channel driven)
130 W
(1 kHz, 10% T.H.D. at 6 Ω one channel driven)

SURROUND 100 W + 100 W
(1 kHz, 0.5% T.H.D. at 6 Ω one channel driven)
130 W + 130 W
(1 kHz, 10% T.H.D. at 6 Ω one channel driven)

SURROUND BACK/SUBWOOFER 100 W
(1 kHz, 0.5% T.H.D. at 6 Ω one channel driven)
130 W
(1 kHz, 10% T.H.D. at 6 Ω one channel driven)

Total harmonic distortion 0.09% (1 kHz, 50 W, 6 Ω)

Frequency response

DIGITAL IN (DVD, VIDEO 1, VIDEO 2, AUX, GAME)
..... 10 Hz ~ 44 kHz, Sampling frequency 96kHz, +0 dB ~ -3.0 dB

Signal to noise ratio

DIGITAL IN (DVD, VIDEO 1, VIDEO 2, AUX, GAME) 96 dB

Input sensitivity / impedance

LINE (DVD, VIDEO 1, VIDEO 2, AUX, FRONT AUX, GAME)
..... 400 mV / 47 kΩ

Output level / impedance

REC OUT 400 mV / 1 kΩ

PRE OUT (SURROUND BACK) 1 V / 1 kΩ

PRE OUT (SUBWOOFER) 1 V / 1 kΩ

Tone control

BASS ±10 dB (at 100 Hz)

TREBLE ±10 dB (at 10 kHz)

DIGITAL AUDIO section

Sampling frequency 32 kHz, 44.1 kHz, 48 kHz, 88.2 kHz, 96 kHz

Input level / impedance / wave length

Optical (VIDEO 1, AUX, GAME)

..... (-15 dBm ~ -24 dBm), 660 nm ±30 nm

Coaxial (DVD, VIDEO 2) 0.5 Vp-p / 75 Ω

VIDEO section

Input sensitivity / impedance

Composite (DVD, VIDEO 1, VIDEO 2, FRONT AUX, GAME)

..... 1 Vp-p / 75 Ω

S VIDEO (DVD, VIDEO 2) (For Australia)

Luminance signal 1 Vp-p / 75 Ω

Chrominance signal 0.286 Vp-p / 75 Ω

COMPONENT VIDEO (DVD, VIDEO 2) (For U.S.A. and Canada)

Luminance signal 1 Vp-p / 75 Ω

Cb/CR-signal ±0.32 Vp-p / 75 Ω

Output level / impedance

Composite (VIDEO 1, MONITOR OUT) 1 Vp-p / 75 Ω

S VIDEO (MONITOR OUT) (For Australia)

Luminance signal 1 Vp-p / 75 Ω

Chrominance signal 0.286 Vp-p / 75 Ω

COMPONENT VIDEO (MONITOR OUT) (For U.S.A. and Canada)

Luminance signal 1 Vp-p / 75 Ω

Cb/CR-signal ±0.32 Vp-p / 75 Ω

FM tuner section

Tuning frequency range 87.5 MHz ~ 108 MHz

Usable sensitivity (MONO)

..... 1.3 μV (75 Ω) / 13.2 dBf (75 kHz dev, SINAD 30 dB)

50 dB quieting sensitivity

STEREO 28 μV (75 Ω) / 40.2 dBf (75 kHz dev)

Total harmonic distortion (1 kHz)

MONO 0.5% (71.2 dBf input)

STEREO 0.7% (71.2 dBf input)

Signal to noise ratio (1 kHz)

MONO 75 dB (71.2 dBf input)

STEREO 68 dB (71.2 dBf input)

Selectivity (±400 kHz) 70 dB

Stereo separation (1 kHz) 40 dB

Frequency response (30 Hz ~ 15kHz) +0.5 dB, -3.0 dB

AM tuner section

Tuning frequency range

For U.S.A., and Canada 530 kHz ~ 1,700 kHz

For Australia 531 kHz ~ 1,602 kHz

Usable sensitivity (30% mod, S/N 20 dB) 16 μV / (600 μV/m)

Signal to noise ratio (30% mod, 400 Hz)

..... 50 dB (60 dBμ V EMF input)

GENERAL

Power consumption 85 W

Dimensions W: 440 mm (17-5/16")

H : 79 mm (3-1/8")

D : 364 mm (14-5/16")

Weight (Net) 4.4 kg (9.7 lb)

Notes

1.KENWOOD follows a policy of continuous advancements in development. For this reason specifications may be changed without notice.

2.The full performance may not be exhibited in an extremely cold location (under a water-freezing temperature).

Specifications (For Europe)

AUDIO section

Rated power output during STEREO operation	100 W + 100 W
DIN/IEC (20 Hz ~ 20 kHz, 0.7% T.H.D. at 6 Ω)	
Effective power output during STEREO operation	130 W + 130 W
(1 kHz, 10% T.H.D. at 6 Ω)	
Effective power output during SURROUND operation	
FRONT	100 W + 100 W
(1 kHz, 0.5% T.H.D. at 6 Ω one channel driven)	
130 W + 130 W	
(1 kHz, 10% T.H.D. at 6 Ω one channel driven)	
CENTER	100 W
(1 kHz, 0.5% T.H.D. at 6 Ω one channel driven)	
130 W	
(1 kHz, 10% T.H.D. at 6 Ω one channel driven)	
SURROUND	100 W + 100 W
(1 kHz, 0.5% T.H.D. at 6 Ω one channel driven)	
130 W + 130 W	
(1 kHz, 10% T.H.D. at 6 Ω one channel driven)	
SURROUND BACK/SUBWOOFER	100 W
(1 kHz, 0.5% T.H.D. at 6 Ω one channel driven)	
130 W	
(1 kHz, 10% T.H.D. at 6 Ω one channel driven)	
Total harmonic distortion	0.09% (1 kHz, 50 W, 6 Ω)
Frequency response	
DIGITAL IN (DVD, VIDEO 1, VIDEO 2, AUX, GAME)	
.....	10 Hz ~ 44 kHz, Sampling frequency 96kHz, +0 dB ~ -3.0 dB
Signal to noise ratio	
DIGITAL IN (DVD, VIDEO 1, VIDEO 2, AUX, GAME)	96 dB
Input sensitivity / impedance	
LINE (DVD, VIDEO 1, VIDEO 2, AUX, FRONT AUX, GAME)	
.....	400 mV / 47 kΩ
Output level / impedance	
REC OUT	400 mV / 1 kΩ
PRE OUT (SURROUND BACK)	1 V / 1 kΩ
PRE OUT (SUBWOOFER)	1 V / 1 kΩ
Tone control	
BASS	±10 dB (at 100 Hz)
TREBLE	±10 dB (at 10 kHz)

DIGITAL AUDIO section

Sampling frequency	32 kHz, 44.1 kHz, 48 kHz, 88.2 kHz, 96 kHz
Input level / impedance / wave length	
Optical (VIDEO 1, AUX, GAME)	
.....	(-15 dBm ~ -24 dBm), 660 nm ±30 nm
Coaxial (DVD, VIDEO 2)	0.5 Vp-p / 75 Ω

VIDEO section

Input sensitivity / impedance	
Composite (DVD, VIDEO 1, VIDEO 2, FRONT AUX, GAME)	
.....	1 Vp-p / 75 Ω
S VIDEO (DVD, VIDEO 2)	
Luminance signal	1 Vp-p / 75 Ω
Chrominance signal	0.286 Vp-p / 75 Ω
Output level / impedance	
Composite (VIDEO 1, MONITOR OUT)	
.....	1 Vp-p / 75 Ω
S VIDEO (MONITOR OUT)	
Luminance signal	1 Vp-p / 75 Ω
Chrominance signal	0.286 Vp-p / 75 Ω

FM tuner section

Tuning frequency range	87.5 MHz ~ 108 MHz
Usable sensitivity (DIN at 75 Ω)	
MONO	1.3 μV/ 13.2 dBf (40 kHz dev, S/N 26 dB)
STEREO	45 μV/ 42.1 dBf (40 + 6 kHz dev, S/N 46 dB)
Total harmonic distortion (DIN at 1 kHz)	
MONO	0.2% (71.2 dBf input)
STEREO	0.8% (71.2 dBf input)
Signal to noise ratio (DIN weighted at 1 kHz)	
MONO	65 dB (71.2 dBf input)
STEREO	60 dB (71.2 dBf input)
Selectivity (DIN ±300 kHz)	64 dB
Stereo separation (1 kHz)	36 dB
Frequency response (30 Hz ~ 15kHz)	+0.5 dB, -3.0 dB

AM tuner section

Tuning frequency range	531 kHz ~ 1,602 kHz
Usable sensitivity (30% mod, S/N 20 dB)	16 μV / (600 μV/m)
Signal to noise ratio (30% mod, 400 Hz)	
.....	50 dB (60 dBμ V EMF input)

GENERAL

Power consumption	85 W
Dimensions	W: 440 mm (17-5/16")
H : 79 mm (3-1/8")	
D : 364 mm (14-5/16")	
Weight (Net)	4.4 kg (9.7 lb)

Notes

- 1.KENWOOD follows a policy of continuous advancements in development. For this reason specifications may be changed without notice.
- 2.The full performance may not be exhibited in an extremely cold location (under a water-freezing temperature).

KENWOOD

For your records

Record the serial number, found on the back of the unit, in the spaces designated on the warranty card, and in the space provided below. Refer to the model and serial numbers whenever you call upon your dealer for information or service on this product.

Model _____ Serial Number _____

Free Manuals Download Website

<http://myh66.com>

<http://usermanuals.us>

<http://www.somanuals.com>

<http://www.4manuals.cc>

<http://www.manual-lib.com>

<http://www.404manual.com>

<http://www.luxmanual.com>

<http://aubethermostatmanual.com>

Golf course search by state

<http://golfingnear.com>

Email search by domain

<http://emailbydomain.com>

Auto manuals search

<http://auto.somanuals.com>

TV manuals search

<http://tv.somanuals.com>