

KENWOOD

AUDIO VIDEO SURROUND RECEIVER

VRS-7200



INSTRUCTION MANUAL

KENWOOD CORPORATION

Quick Start Reference

Please read the following pages so that you can enjoy the surround sound at the best condition.

(These pages give shortcut explanations on how to connect the speaker system to the receiver, set up the speakers and play a source.)

"Let's play DVD video software" -  - 

About the supplied remote control

Compared to standard remote controls, the remote control supplied with this receiver has several operation modes. These modes enable the remote control to control other audio/video components. In order to effectively use the remote control it is important to read the operating instructions and obtain a proper understanding of the remote control and how to switch its operation modes (etc.).

Using the remote control without completely understanding its design and how to switch the operation modes may result in incorrect operations.



B60-5585-00 00  (K, P, E, X) KW 0410

Before applying power

 **Caution** : Read this page carefully to ensure safe operation.

Units are designed for operation as follows.

U.S.A. and Canada AC 120 V only
Australia AC 240 V only

Europe AC 230 V only

Safety precautions

WARNING: TO PREVENT FIRE OR ELECTRIC SHOCK, DO NOT EXPOSE THIS APPLIANCE TO RAIN OR MOISTURE.



CAUTION
RISK OF ELECTRIC SHOCK
DO NOT OPEN



CAUTION: TO REDUCE THE RISK OF ELECTRIC SHOCK, DO NOT REMOVE COVER (OR BACK). NO USER-SERVICEABLE PARTS INSIDE. REFER SERVICING TO QUALIFIED SERVICE PERSONNEL.



THE LIGHTNING FLASH WITH ARROWHEAD SYMBOL, WITHIN AN EQUILATERAL TRIANGLE, IS INTENDED TO ALERT THE USER TO THE PRESENCE OF UNINSULATED "DANGEROUS VOLTAGE" WITHIN THE PRODUCT'S ENCLOSURE THAT MAY BE OF SUFFICIENT MAGNITUDE TO CONSTITUTE A RISK OF ELECTRIC SHOCK TO PERSONS.



THE EXCLAMATION POINT WITHIN AN EQUILATERAL TRIANGLE IS INTENDED TO ALERT THE USER TO THE PRESENCE OF IMPORTANT OPERATING AND MAINTENANCE (SERVICING) INSTRUCTIONS IN THE LITERATURE ACCOMPANYING THE APPLIANCE.

How to use this manual

This manual is divided into four sections, Preparations, Operations, Remote Control, and Additional Information.

Preparations

Shows you how to connect your audio and video components to the receiver and prepare the surround processor. Since this receiver works with all your audio and video components, we will guide you in setting up your system to be as easy as possible.

Operations

Shows you how to operate the various functions available on the receiver.

Remote Control

Shows you how to operate other components using the remote control, as well as a detailed explanation of all remote control operations. Once you have registered your components with the proper setup codes, you'll be able to operate both this receiver and your other AV components (TV, VCR, DVD player, CD player, etc.) using the remote control supplied with this receiver.

Additional Information

Shows you additional information such as "In case of difficulty" (trouble shooting) and "Specifications".

Unpacking

Unpack the unit carefully and make sure that all the accessories are present.

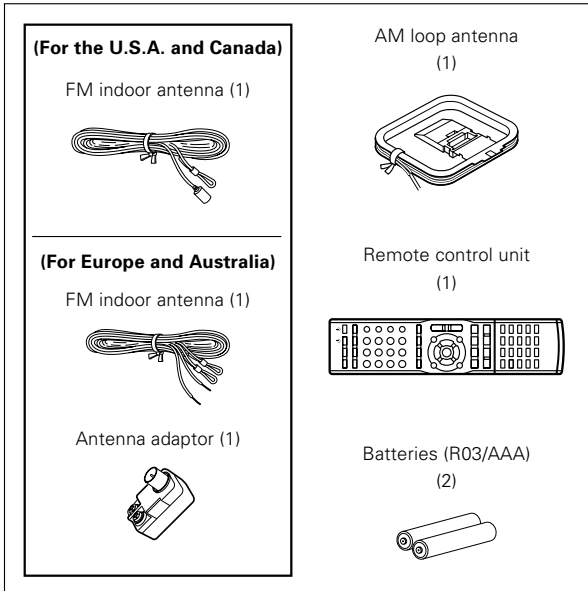

If any accessories are missing, or if the unit is damaged or fails to operate, notify your dealer immediately. If the unit was shipped to you directly, notify your shipper immediately. Kenwood recommends that you retain the original carton and packing materials in case you need to move or ship the unit in the future.

Keep this manual handy for future reference.

Special features

True home theater sound

This receiver incorporates a wide variety of surround modes to bring you maximum enjoyment from your video software and audio source. Select a surround mode according to your equipment or the software you are going to play and enjoy!

- Dolby Digital EX
- Dolby PRO LOGIC IIX, Dolby PRO LOGIC II
- Dolby Digital
- DTS-ES
- DTS NEO:6
- DTS 96/24
- DTS
- DSP Mode
- Dolby Virtual Speaker
- Dolby Headphone

GAME mode function

When you connect a game machine to the **GAME** jacks on the front panel, the input selector of the receiver switches automatically to **"GAME"** and the optimum sound field for enjoying games is set. This feature improves your convenience in playing video games.

DUAL SOURCE function

While you enjoy audio listening through the speakers, another person can enjoy another source (audio + video) through headphones by connecting the source to the **GAME, FRONT AUX** jacks.

ACTIVE EQ

ACTIVE EQ mode will produce a more dynamic sound quality in any condition. You can enjoy a more impressive sound effect when ACTIVE EQ is turned on during Dolby Digital and DTS playback.

Remote control

In addition to the basic receiver, the remote control supplied with this receiver can also operate almost all of your remote controllable audio and video components. Just follow the simple setup procedure to register the components you have connected.

RDS (Radio Data System) tuner (For Europe and Australia)

The receiver is equipped with an RDS tuner that provides several convenient tuning functions: RDS Auto Memory, to automatically preset up to 40 RDS stations broadcasting different programs; station name display, to show you the name of the current broadcast station; and PTY search to let you tune stations by program type.

Names and functions of parts

Main unit

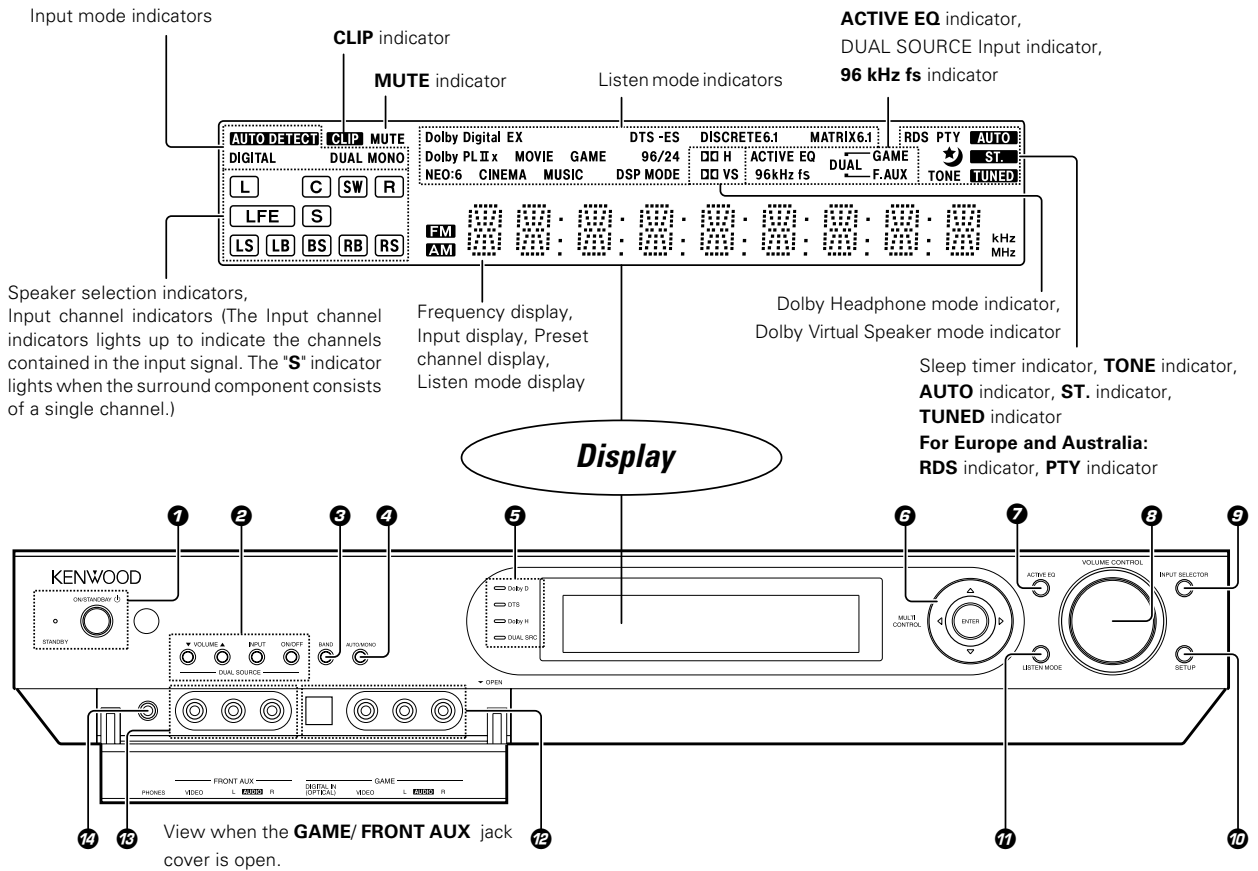

1 ON/STANDBY key

Use to turn the power ON/STANDBY. - 18

STANDBY indicator

Lights when the power is in the standby mode.

2 DUAL SOURCE VOLUME / keys

Use to adjust the volume in the DUAL SOURCE mode. - 24

DUAL SOURCE INPUT key

Use to select the input for the DUAL SOURCE mode. - 24

DUAL SOURCE ON/OFF key

Use to switch the DUAL SOURCE mode ON/OFF. - 24

3 BAND key

Use to select the broadcast band. - 27 - 29

4 AUTO/MONO key

Use to select the auto or manual tuning mode. - 27 - 29

5 Dolby D indicator

Lights when the receiver is in the Dolby Digital mode. - 34

DTS indicator

Lights when the receiver is in the DTS mode. - 34

Dolby H indicator

Lights when the Dolby Headphone mode is ON. - 33

DUAL SRC indicator

Lights when the DUAL SOURCE mode is ON. - 24

6 Joystick

MULTI CONTROL /

Use to control a variety of settings. - 16 - 18

Use to tune of radio broadcasting. - 27

MULTI CONTROL /

Use to control a variety of settings. - 16 - 18

Use to select of preset radio stations. - 28

ENTER

Use to control a variety of settings. - 16 - 18

Use to presetting of radio stations. - 27

7 ACTIVE EQ key

Use to switch the status of ACTIVE EQ. - 25

8 VOLUME CONTROL knob

Use to adjust the receiver volume. - 23

9 INPUT SELECTOR key

Use to select input sources. - 23

10 SETUP key

Use to select the speakers' settings etc. - 16 - 18

Use to switch the status of REC MODE. - 26

11 LISTEN MODE key

Use to select the listening mode. - 34

12 GAME jacks

- 14 - 21 - 24

13 FRONT AUX jacks

- 14 - 24

14 PHONES jack

Use for headphone listening. - 24

Standby mode

While the standby indicator is lit, a small amount of power is supplied to the system to back up the memory. This is called standby mode. Under the condition, the system can be turned ON by the remote control unit.

Remote control unit

This remote control unit can be used not only for Kenwood products but also for other non-Kenwood products by setting the appropriate manufacturer's setup codes. → 41 → 44

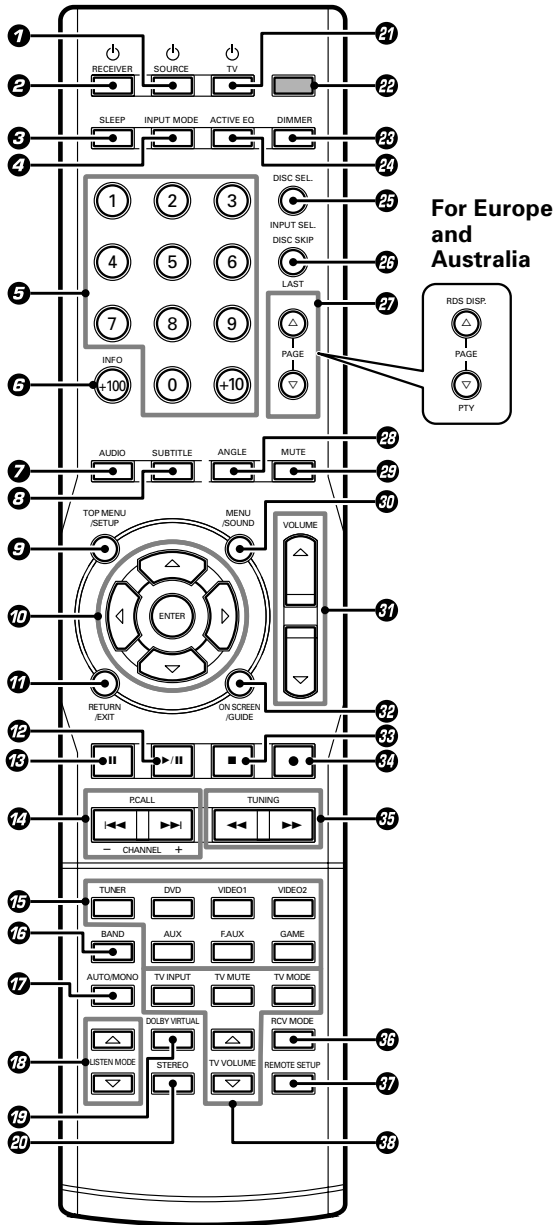

If the name of a function is different on the receiver and on the remote control, the name of the remote control key in this manual is indicated in parentheses.

- 1** **SOURCE key**
Use to turn the other components ON/OFF. → 39
- 2** **RECEIVER key**
Use to turn the power ON/STANDBY. → 18
- 3** **SLEEP key**
Use to set the Sleep timer. → 38
- 4** **INPUT MODE key**
Use to switch between the full auto, digital and analog input. → 8
- 5** **Numeric keys**
Use to selection of preset radio stations. → 28
Use to operate other components. → 39
- 6** **+100 key**
Use to operate other components. → 39
- 7** **INFO key**
Use to operate other components. → 39
- 8** **AUDIO key**
Use to operate the DVD component. → 39
- 9** **SUBTITLE key**
Use to operate the DVD component. → 39
- 9** **SETUP key**
Use to select the speakers' settings etc. → 18
- 10** **TOP MENU key**
Use to operate the DVD component. → 39
- 11** **Δ / ▽ keys**
Use to control a variety of settings. → 18
Use to tuning of radio broadcasting. → 27
Use to operate other components. → 39
- 12** **</> keys**
Use to control a variety of settings. → 18
Use to selection of preset radio stations. → 28
- 13** **ENTER key**
Use to control a variety of settings. → 18
Use to operate other components. → 39
- 14** **RETURN key**
Use to operate the DVD component. → 39
- 15** **EXIT key**
Use to operate other components. → 39
- 16** **▶/|| key**
Use to operate the CD, DVD, MD or VCR component. → 39
- 17** **|| key**
Use to operate other components. → 39
- 18** **P.CALL keys**
Use to selection of preset radio stations. → 28
- 19** **◀◀ / ▶▶ keys**
Use to operate the CD, DVD or MD component. → 39
- 20** **CHANNEL +/- keys**
Use to select the channels. → 39

Continued to next page

15 Input selector keys (TUNER, DVD, VIDEO 1, VIDEO 2, AUX, F. AUX, GAME)

Use to select input sources. → 23

Sources keys (DVD, VIDEO 1, VIDEO 2, AUX, F. AUX, GAME)

To control one of the registered sources without switching the receiver's input selector to that source, press and hold the desired input selector key for more than 3 seconds. → 39

16 BAND key

Use to select the broadcast band. → 27

17 AUTO/MONO key

Use to select the auto or manual tuning mode. → 27

18 LISTEN MODE Δ/∇ keys

Use to select the listening mode. → 34

19 DOLBY VIRTUAL key

Use to select the Dolby Virtual mode. → 33

20 STEREO key

Use to switch the listen mode temporary to the stereo mode. → 35

21 $\text{\textcircled{P}}$ TV key

Use to turn the TV on and off.

22 LED indicator

Blinks to show that signals are being transmitted.

23 DIMMER key

Use to adjust the brightness of the display. → 38

24 ACTIVE EQ key

Use to switch the status of ACTIVE EQ. → 25

25 DISC SEL. key

Use to operate other components. → 39

INPUT SEL. key

Use to operate other components. → 39

26 DISC SKIP key

Use to operate the multi-CD player. → 39

LAST key

Use to operate other components. → 39

27 PAGE Δ/∇ keys

Use to operate the DVD component. → 39

(For Europe and Australia)

RDS DISP. key → 29

Use to receive RDS broadcast.

PTY key → 30

Use for PTY search.

28 ANGLE key

Use to operate the DVD component. → 39

29 MUTE key

Use to temporarily mute the sound. → 25

30 SOUND key

Use to adjust the sound quality and the ambience effects. → 22 → 24 → 36

MENU key

Use to operate other components. → 39

31 VOLUME Δ/∇ keys

Use to adjust the receiver volume. → 23

32 ON SCREEN key

Use to operate the DVD component. → 39

GUIDE key

Use to operate other components. → 39

33 \blacksquare key

Use to operate the CD, DVD, MD or VCR component. → 39

34 \bullet key

Use to operate the MD or VCR component. → 39

35 TUNING keys

Use to tuning of radio broadcasting. → 27

\lll / \ggg keys

Use to operate the CD, DVD, MD or VCR component. → 39

36 RCV (receiver) MODE key

Use to switch the remote control to the receiver control mode. → 18 → 36

37 REMOTE SETUP key

Use to register other components. → 39 → 40

38 TV INPUT key

Use to select TV input.

TV MUTE key

Use to temporarily mute the TV sound.

TV MODE key

Use to switch the remote control to the TV control mode.

TV VOLUME Δ/∇ keys

Use to adjust the TV's volume.

Setting up the system

CAUTION

Make sure that the power cord plug is disconnected from the AC wall outlet before proceeding to connections. Also be sure to disconnect the power cord plug from the AC wall outlet before changing connections. For the connections of other system components, see pages 9 to 15.

When connecting an associated system component, be sure to read its instruction manual.

Microcomputer malfunction

If operation is not possible or an erroneous display appears, even though all connections have been made properly, reset the micro computer referring to "In case of difficulty". → [57]

Notes

1. Be sure to turn off the system components before connecting them.
2. Be sure to insert every connection cable completely into the jack. Incomplete connection may result in absence of audio output or production of noise.
3. Be sure to disconnect the power cord from the AC wall outlet before inserting or removing a connection cable.
4. Installation of outdoor antenna is a dangerous work. Please have your dealer or a specialized technician install it.

Analog audio connections

Audio connections are made using RCA pin cords. These cables transfer stereo audio signal in an "analog" form. This means the audio signal corresponds to the actual audio of two channels. These cables usually have 2 plugs on each end, one red for the right channel and one white for the left channel.

These cables are to be prepared separately by the user.

CAUTION

Be sure to adhere to the following, or proper ventilation will be blocked causing damage or fire hazard.

- Do not place any objects impairing heat radiation onto the top of the unit.
- Leave some space around the unit (from the largest outside dimension including projection) equal to or greater than, shown below.

| | |
|------------|---------------------|
| Top panel | : 50 cm (19-11/16") |
| Side panel | : 10 cm (3-15/16") |
| Back panel | : 10 cm (3-15/16") |

Input mode settings

DVD, VIDEO 1, VIDEO 2, AUX and GAME inputs each include jacks for digital audio input and analog audio input.

The initial factory settings for audio signal playback for DVD, VIDEO 1, VIDEO 2, AUX and GAME are full auto.

After completing connections and turning on the receiver, follow the steps below.

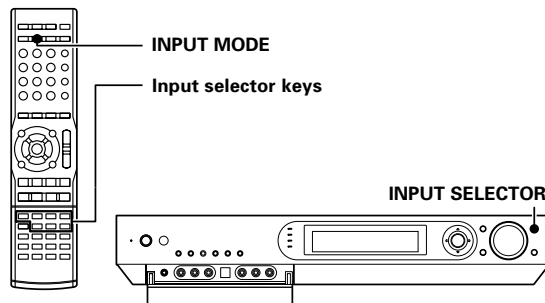

① Use the INPUT SELECTOR key (or input selector keys) to select DVD, VIDEO 1, VIDEO 2, AUX or GAME.

② Press the INPUT MODE key.

Each press switches the setting as follows:

- ① "F-AUTO": Auto detect
("AUTO DETECT" indicator lights up)
 - ② "D-MANUAL": Fixed to digital input
("DIGITAL" indicator lights up)
 - ③ "ANALOG": Fixed to analog input *
("AUTO DETECT", "DIGITAL" indicator goes off)
- * Can not be selected for DTS playback.

Auto detect:

In "F-AUTO (FULL AUTO)" mode ("AUTO DETECT" indicator light up), the receiver detects the digital or analog input signals automatically. The receiver will select the input mode and listening mode automatically during playback to match the type of input signal (Dolby Digital, PCM, DTS) and the speaker setting. → [34]
The "DIGITAL" indicator lights up when a digital signal is detected. The "DIGITAL" indicator is extinguished when no digital signal is detected.

Fixed to digital input:

Select this mode if you want to keep the decoding condition (Dolby Digital, DTS, PCM, etc.) in the current listen mode. When "D-MANUAL (DIGITAL MANUAL)" mode is selected, the set listen modes may be changed automatically depending on the input signal. → [34]

Fixed to analog input:

Select this setting to play analog signals from a VCR, etc.

If the INPUT MODE key is pressed quickly, sound may not be produced. Press the INPUT MODE key again.

Connecting a DVD player

If you have connected a DVD player to the receiver with digital connection, be sure to read the "Input mode settings", "Re-assignment of rear panel jacks" section carefully. → 8 → 22

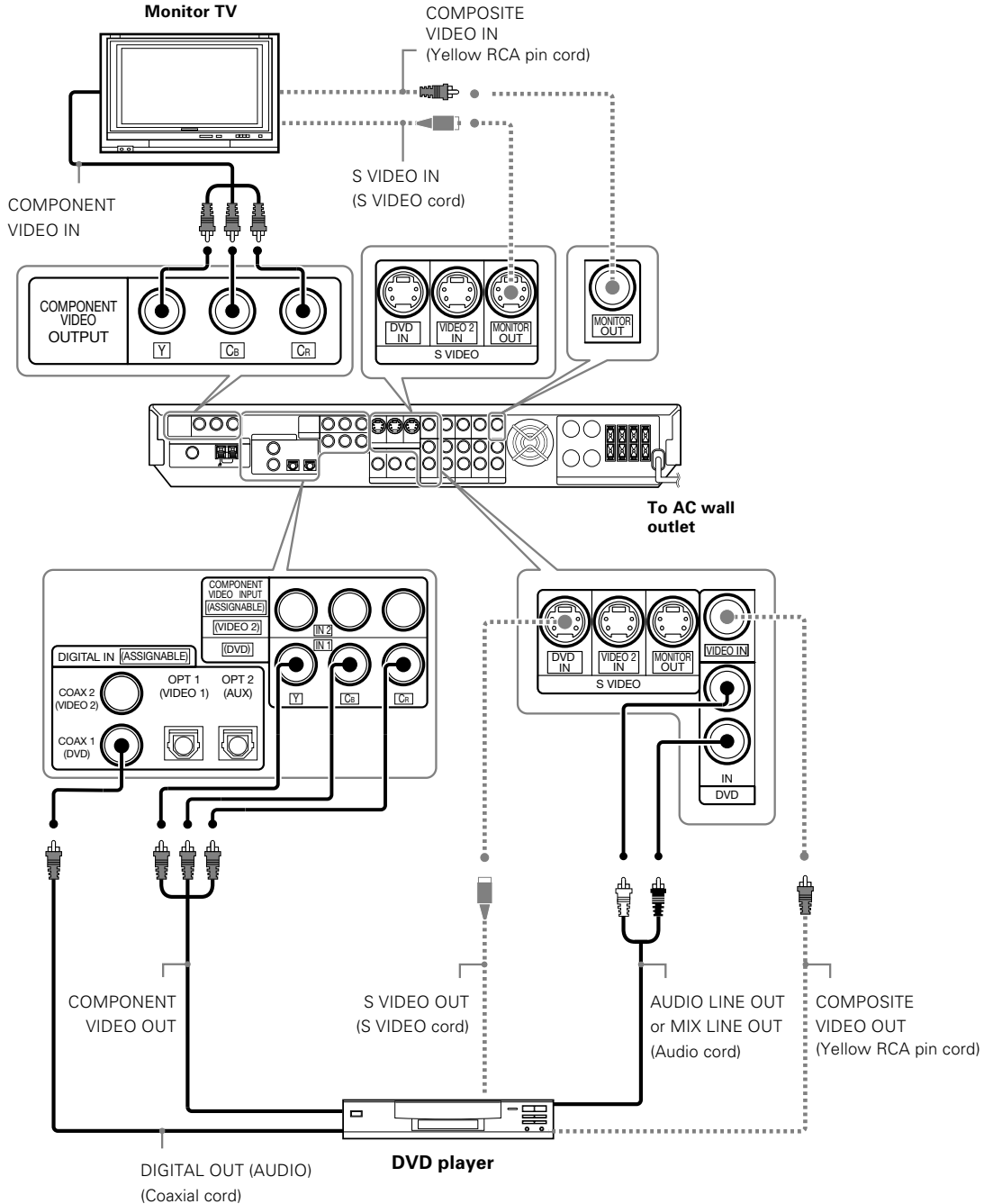

- Digital audio connections are required when playing multi-channel signals such as the Dolby Digital and DTS signals.
- To play the DVD player connected in this page, select the "DVD" input selector. → 23

Connecting video components, audio components

Audio components

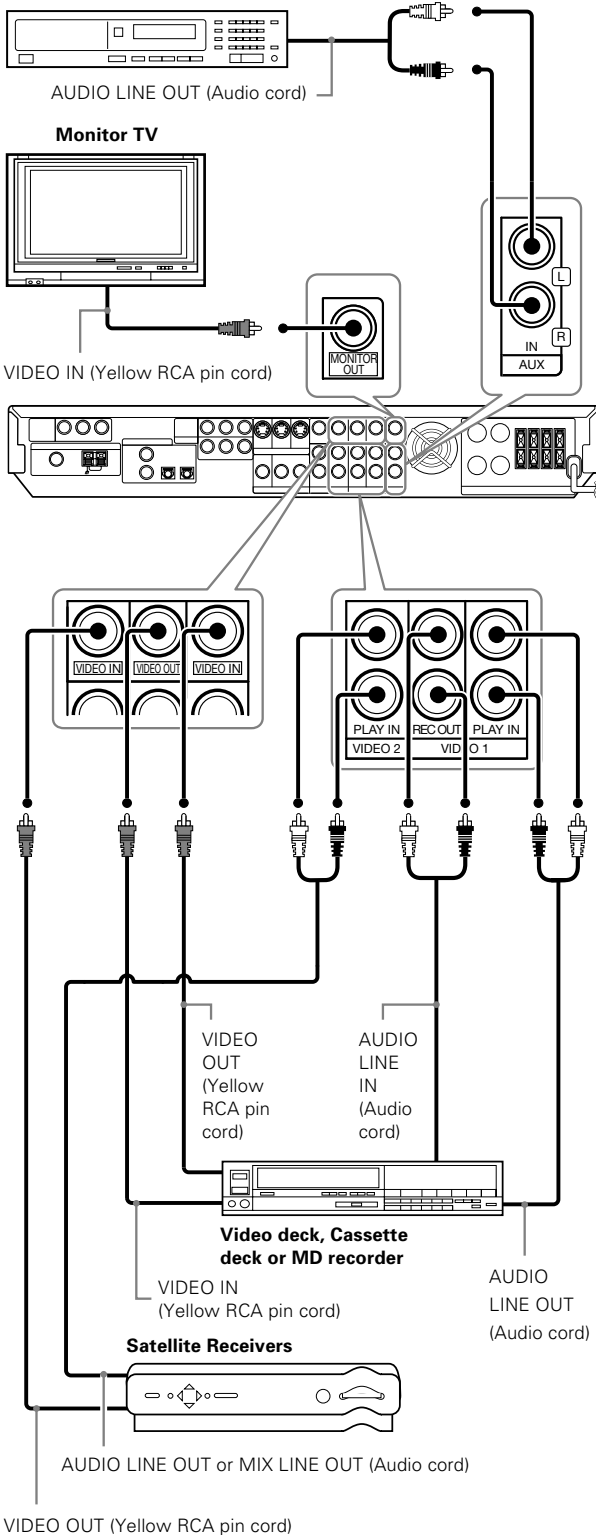

Connecting video components (COMPONENT VIDEO)

If you have connected the receiver to a video component with **COMPONENT** jacks, you can get a better picture quality than by connecting with the **S VIDEO** jacks.

When connecting a video component with **COMPONENT** jacks, see "Re-assignment of rear panel jacks" → [22]

When connecting the TV to the COMPONENT jacks, be sure to connect all the other components to the COMPONENT jacks.

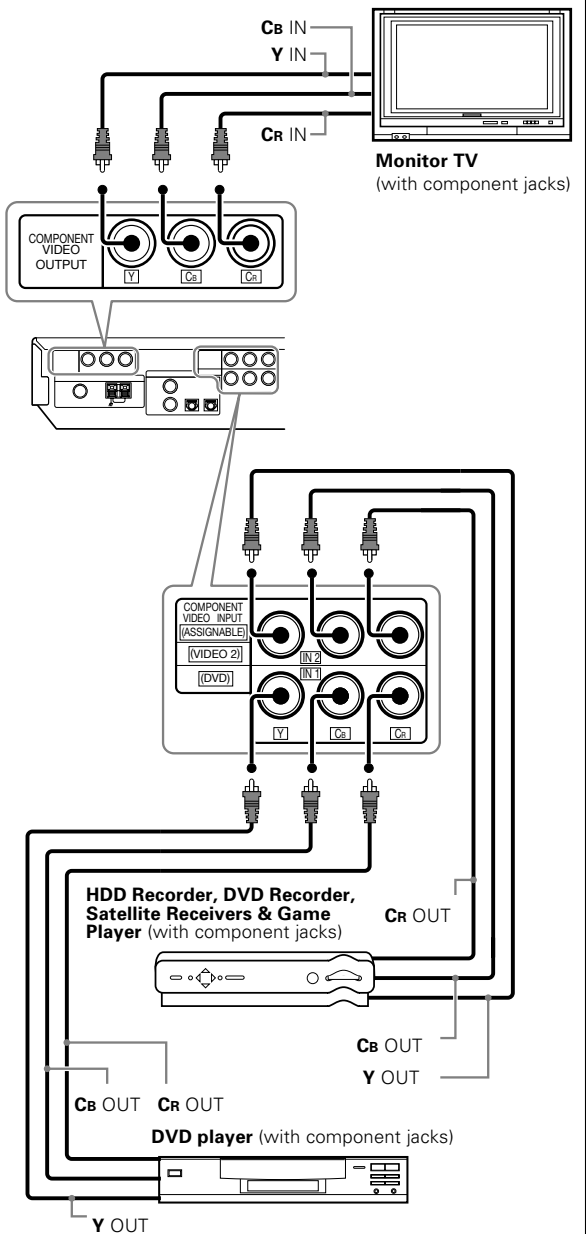

Digital connections

The digital in jacks can accept DTS, Dolby Digital, or PCM signals. Connect components capable of outputting DTS, Dolby Digital or PCM (CD) digital signals.

If you have connected components with digital audio output to the receiver with digital connection, be sure to read the "Input mode settings", "Re-assignment of rear panel jacks" section carefully. - [8] - [22]

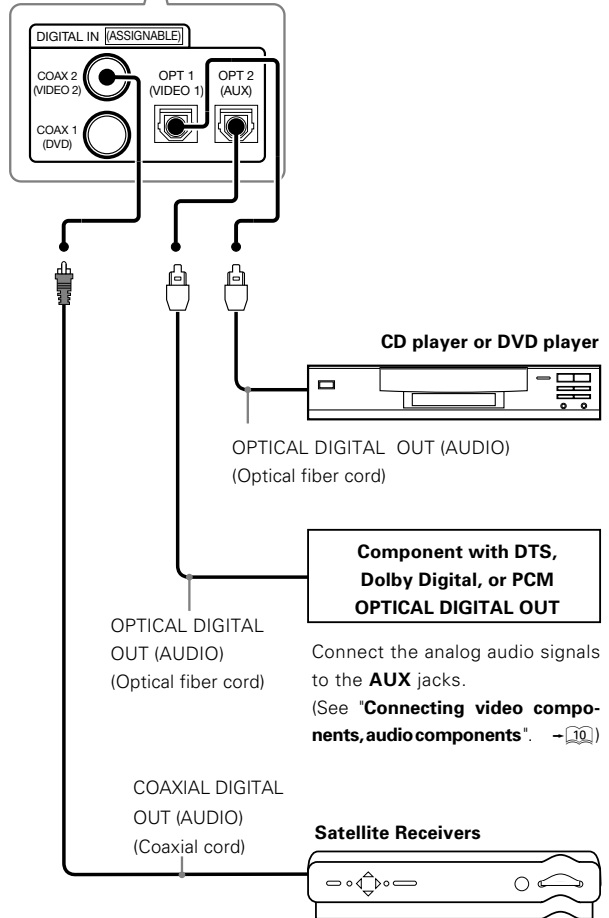
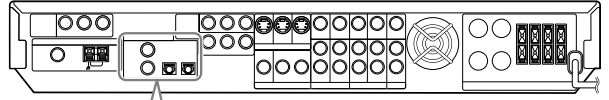

Connect the analog audio signals to the **AUX** jacks. (See "Connecting video components, audio components". - [10])

Connect the video signal and analog audio signals to the **VIDEO 2** jacks. (See "Connecting video components, audio components". - [10])

DTS disclaimer clause

When playing DTS-encoded discs, excessive noise will be exhibited from the analog stereo outputs of the CD or DVD player. To enjoy DTS Digital Surround™ playback, this unit must be connected to the digital output of the CD or DVD player.

Connecting video components (S VIDEO)

Use the S VIDEO jacks to make connections to video components with S VIDEO IN/OUT jacks.

- If you connect a video playback component such as a VCR through a S VIDEO cord, be sure to use a S VIDEO cord in connection to the monitor TV.

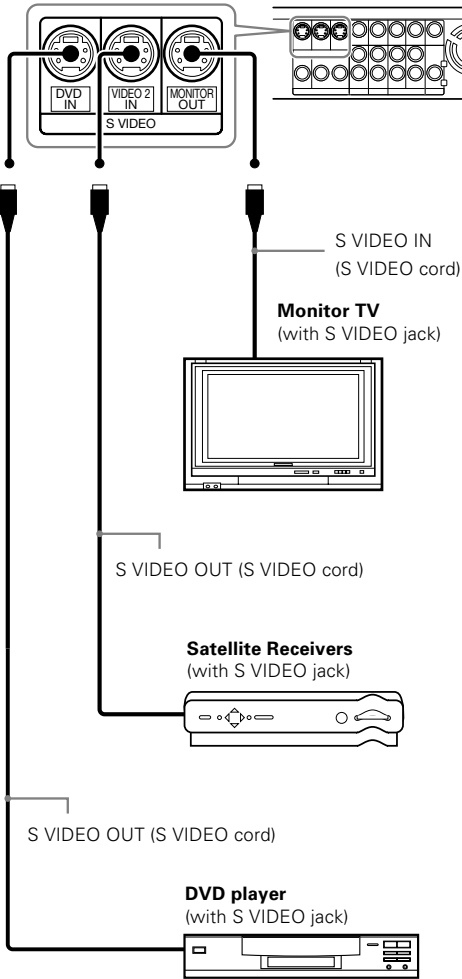

Connecting the speakers

CAUTION

Make sure that the power cord plug is disconnected from the AC wall outlet before proceeding to speaker cord connections. If the conductor wires on the extremity of speaker cord are untwisted, there is a risk of short-circuiting. Be sure to twist them well before connecting the speaker cord.

Whether each speaker is connected properly can be confirmed by outputting the test tone and checking if each speaker channel outputs audio. For details, see "Speaker settings" (Step 2 Adjust the speaker volume level). - [20]

Protection circuitry

This unit incorporates protection circuitry, which may be activated during high-power reproduction or in case of extreme rise in temperature.

When the protection circuitry is activated, the output from this unit is shut down and the **STANDBY** indicator blinks.

In this case, turn this unit OFF then ON again and reduce the output volume level.

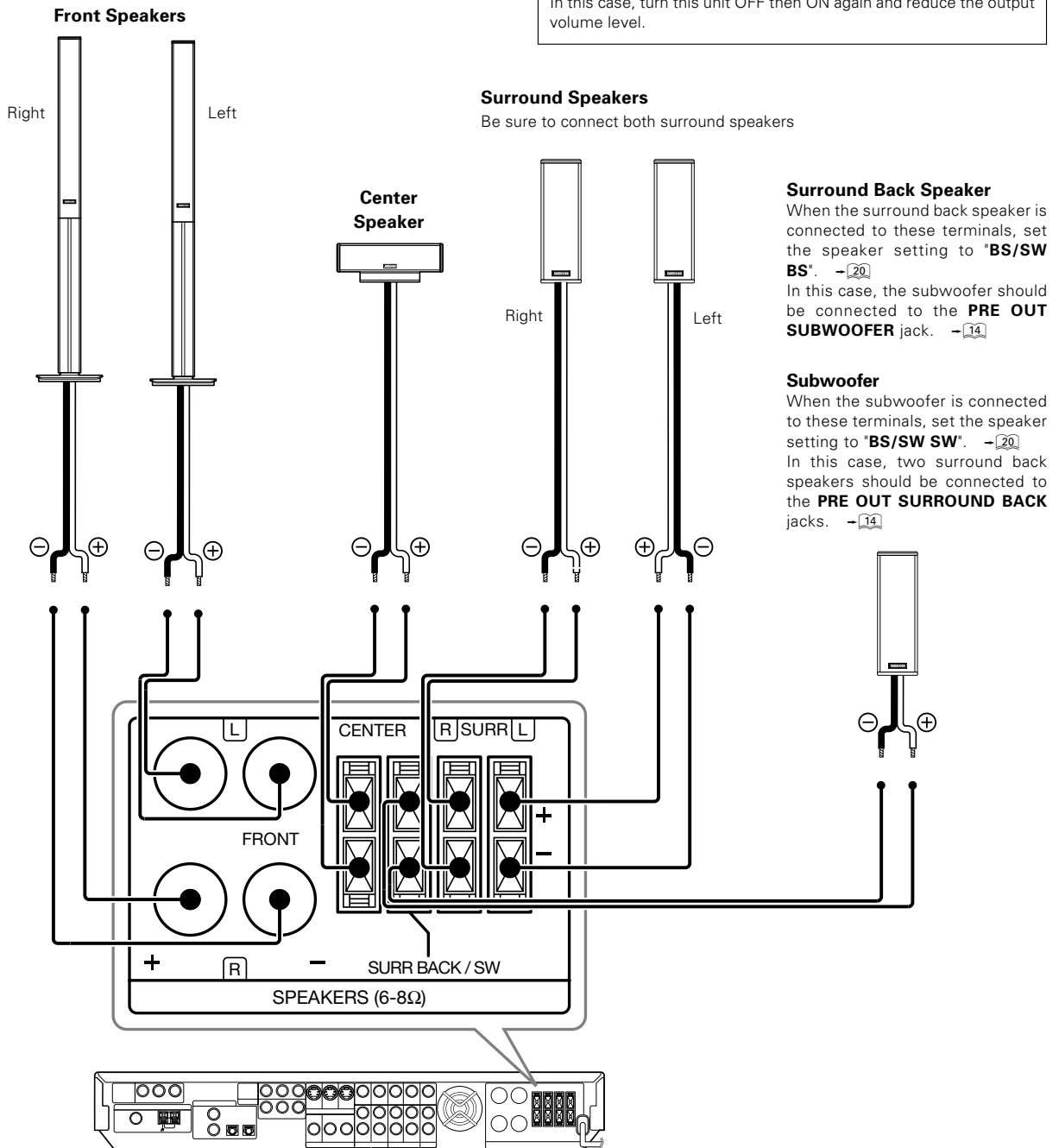

Connecting the speaker terminals

Front

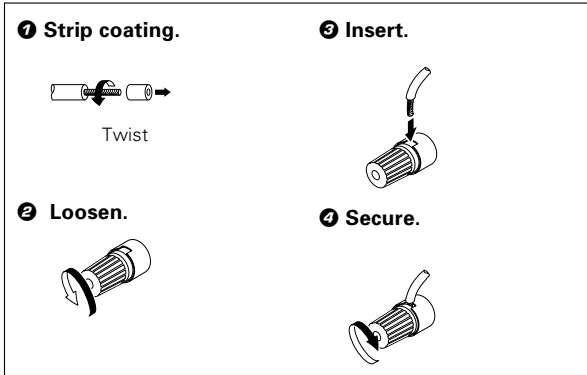

Center, Surround, Surround back, Subwoofer

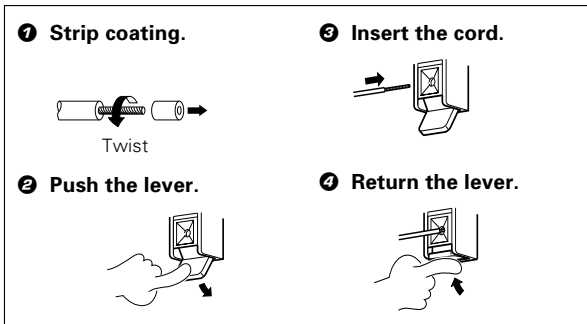

- Never short circuit the + and – speaker cords.
- If the left and right speakers are connected inversely or the speaker cords are connected with reversed polarity, the sound will be unnatural with ambiguous acoustic imaging. Be sure to connect the speakers correctly.

Speaker impedance

After confirming the speaker impedance indications printed on the rear panel of the receiver, connect speakers with matching impedance ratings. Using speakers with a rated impedance other than that indicated on the rear panel of the receiver could result in malfunctions or damage to the speakers or receiver.

Speaker placement

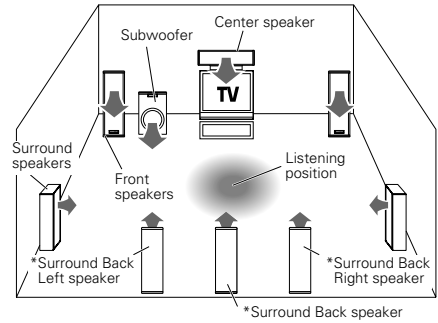

* For Surround Back speaker, you may place either two Surround Back speakers (Surround Back Left speaker and Surround Back Right speaker) for 7.1 channel surround sound system or one Surround Back speaker for 6.1 channel surround sound system.

Front speakers : Place the left and right speakers at each side of your TV. Angle the speakers towards the listening area to enhance the stereo effect.

Center speaker : Place the center speaker on the center between the front left and right speakers. Tilt the speaker upward or downward so that it is directly facing the listening area.

Surround speakers : Place the surround speakers as high as possible, either directly to the sides of the listening area or else slightly behind the listening area. Adjust the angles so that these speakers are facing directly towards the listeners.

Subwoofer : Usually, place the subwoofer in the front center position in the listening room, near one of the front speakers. (Since the subwoofer has less directivity than other speakers, it can be placed almost in any position that can offer the best low frequency reproduction according to the room layout.)

Surround back speakers : Place the surround back speaker behind the listening position, at the same height as the left and right surround speakers.

- Although the ideal surround system consists of all the speakers listed above, if you don't have a center speaker or a subwoofer, you can divide those signals between the available speakers in the speaker settings steps to obtain the best possible surround reproduction from the speakers you have available. → 18

PRE OUT jacks connections

The receiver has additional **PRE OUT** jacks.
 Note that the output from the **PRE OUT** jacks needs to be connected to an external power amplifier.
 If you want to connect surround back speakers to these jacks, be always sure to connect two surround back speakers for the left and right.

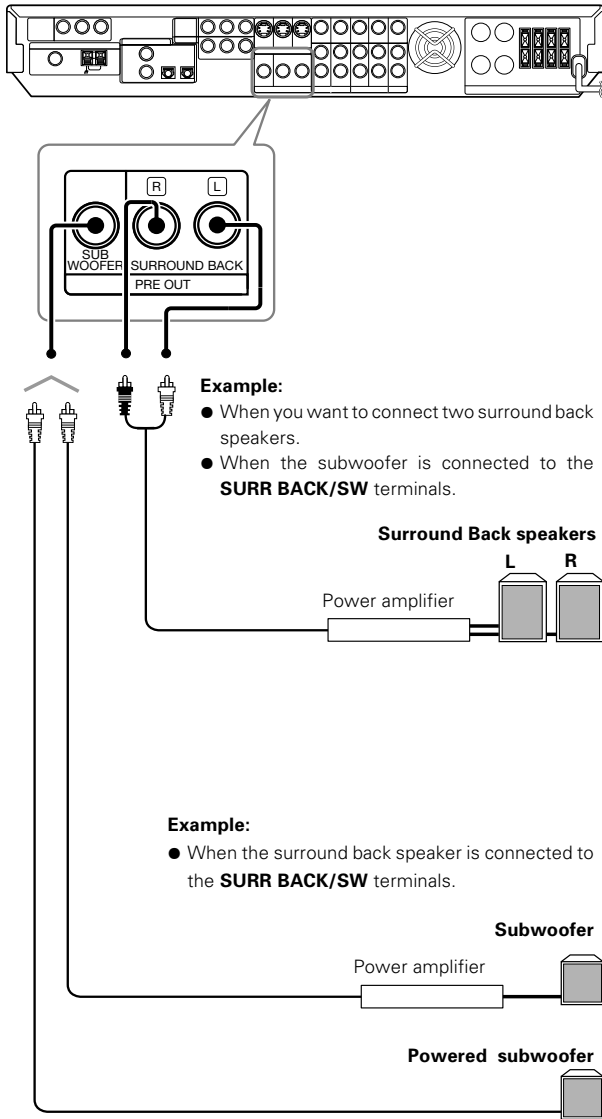

Connecting to the GAME jacks / FRONT AUX jacks

If you use a component that you do not usually connect to the receiver, such as a portable video camera, connect it to the **GAME** or **FRONT AUX** jacks on the front panel of the receiver. These jacks are particularly convenient when dubbing audio/video from a portable video camera.

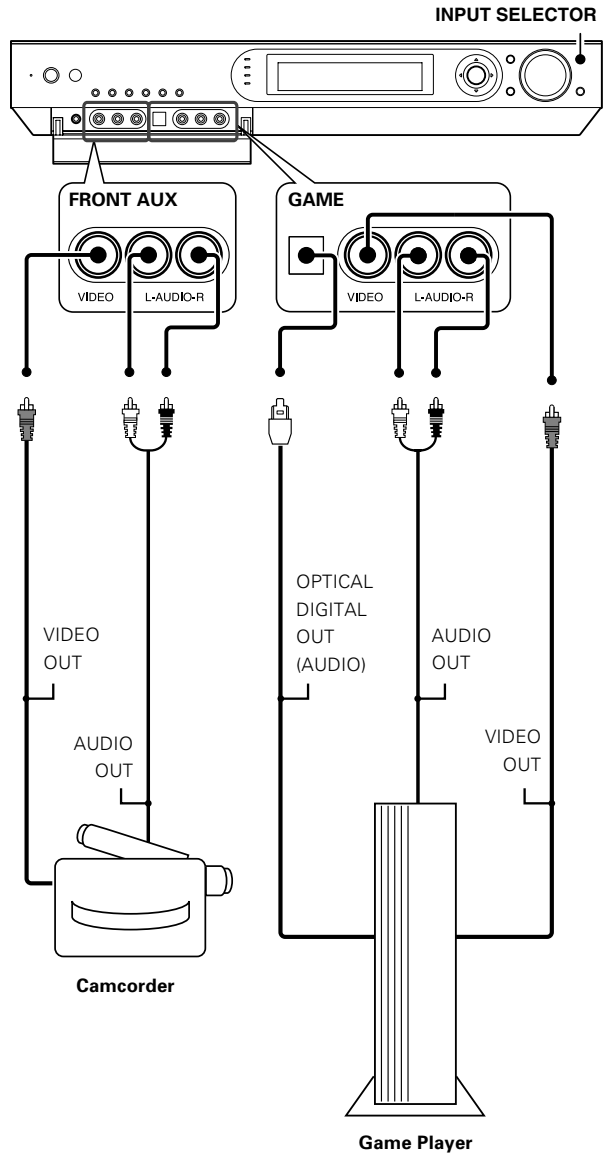

● Connecting a speaker cord directly to a PRE OUT jack will not produce any sound from the speaker.

● The DIGITAL IN (OPTICAL) jack in the GAME jack section can be used for connection of digital audio input. This is convenient for playing a video game through the receiver. — 21

Connecting the antennas

The broadcast reception cannot be made unless the antennas are connected. Connect the antennas correctly as instructed below.

AM loop antenna

The supplied loop antenna is for use indoors. Place it as far as possible from the receiver, TV set, speaker cords and power cord, and adjust the direction for best reception.

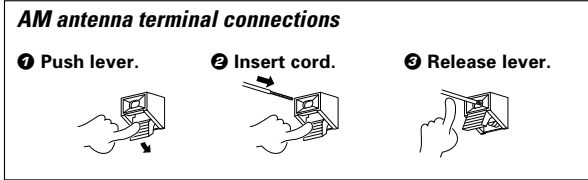

FM indoor antenna

The supplied indoor antenna is for temporary use only. For stable signal reception we recommend using an outdoor antenna. Disconnect the indoor antenna when you connect one outdoors.

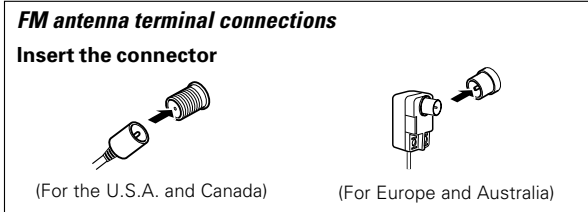

FM outdoor antenna

Lead the 75Ω coaxial cable connected to the FM outdoor antenna into the room and connect it to the **FM 75Ω** terminal.

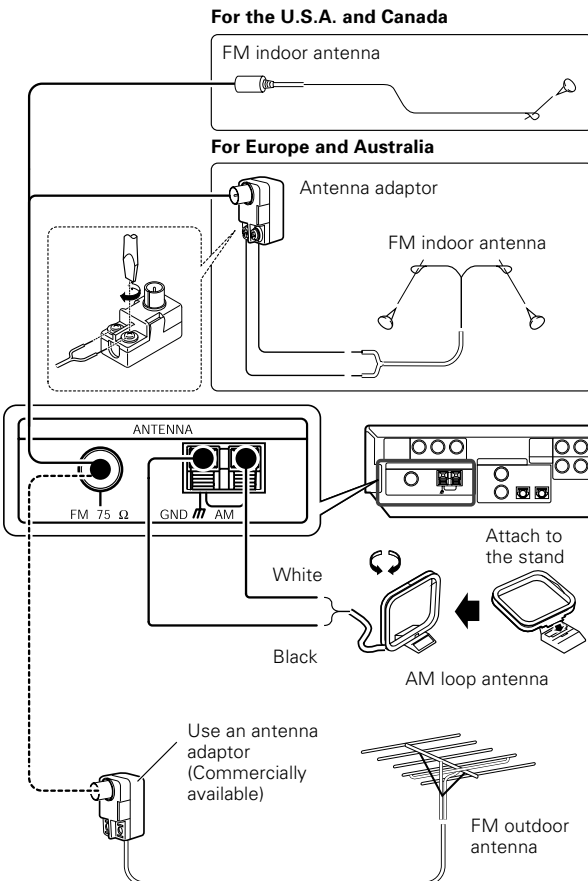

Preparing the remote control

Loading the batteries

① Remove the cover.

② Insert the batteries.

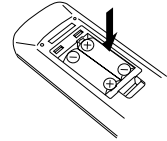
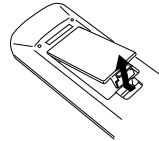

③ Close the cover.

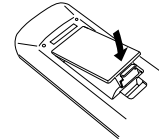

● Insert two AAA-size (R03) batteries as indicated by the polarity markings.

Remote control operation

When the **STANDBY** indicator is lit, the power turns ON when you press the **RECEIVER** on the remote control. When the power comes ON, press the key you want to operate.

Operating range (Approx.)

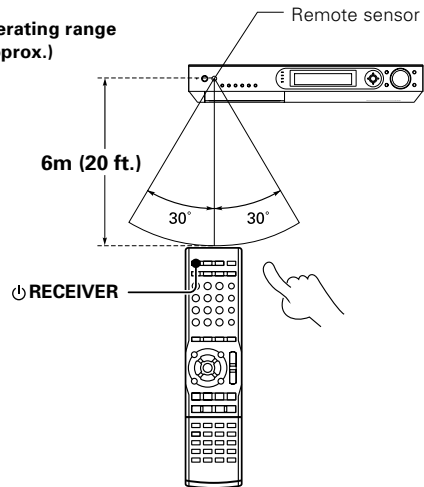

● When pressing more than one remote control key successively, press the keys securely by leaving an interval of 1 second or more between keys.

Notes

1. The supplied batteries may have shorter lives than ordinary batteries due to use during operation checks.
2. When the remote-controllable distance gets shorter than before, replace both batteries with new ones.

The remote control unit is designed so that the setup codes stored in it are saved even after the batteries are removed for replacement.

3. Placing the remote sensor in direct sunlight, or in direct light from a high frequency fluorescent lamp may cause a malfunction. In such a case, change the location of the system installation to prevent malfunction.

Let's play DVD video software

CAUTION

Make sure that the power cord plug is disconnected from the AC wall outlet before proceeding to speaker cord connections. If the conductor wires on the extremity of speaker cord are untwisted, there is a risk of short-circuiting. Be sure to twist them well before connecting the speaker cord.

STEP 1

Connect the speakers, DVD and TV to the receiver.

For details, see "Setting up the system" - 8 ~ 13

Connection of speakers:

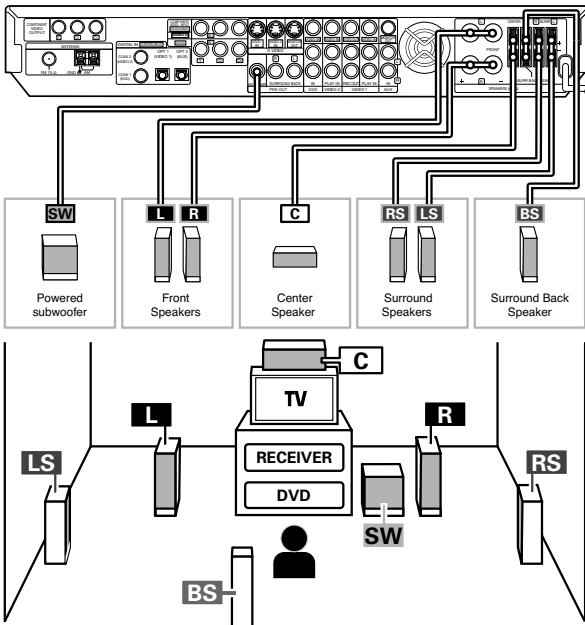

- If you want to connect two surround back speakers (LB and RB) to the **PRE OUT SURROUND BACK** jacks, see "PRE OUT jacks connections". - 14

Connection of DVD player:

For the video input connection from the DVD player and the video output connection to the TV monitor, connect any one in a pair.

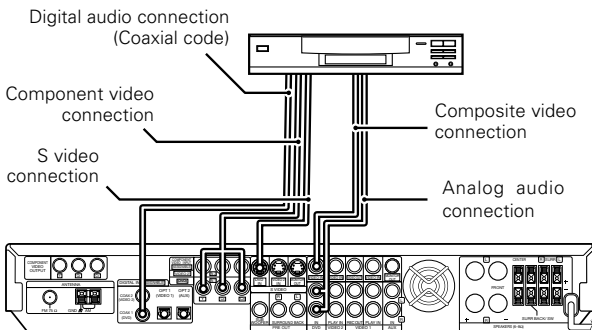

Connection of TV monitor:

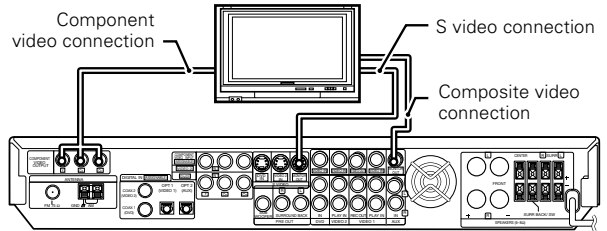

STEP 2

Set up the speakers.

For details, see "Speaker settings". - 18 ~ 21

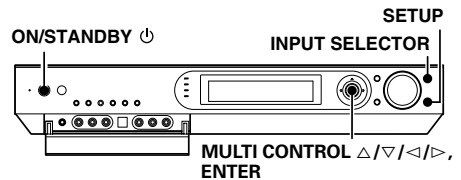

- 1 Connect the power cord to the AC wall outlet and press the **ON/STANDBY** button.
- 2 Press the **SETUP** key, press the **MULTI CONTROL** </> to select "SP SETUP" and press the **ENTER**.

If you connect KENWOOD speaker system:

- 1 Press the **MULTI CONTROL** </> to select the model of the connected speaker system and press the **ENTER**.

- ① "HTB1 6.1CH": Speaker system **KS-4200EX***.
- ② "HTB1 5.1CH": Speaker system **KS-2200HT***.
- ③ "HTB2 6.1CH": Speaker system **KS-3200HT*+KS-3200EX***, **KS-5200EX***, **KS-7200HT*+KS-3200EX***.
- ④ "HTB2 5.1CH": Speaker system **KS-3200HT***, **KS-5200HT***, **KS-7200HT***.
- ⑤ "HTB3 6.1CH": Speaker system **KS-8200EX***.
- ⑥ "HTB3 5.1CH": Speaker system **KS-8200HT***.

* Model availability may differ depending on the country and sales area.

- When the speaker setting is set to "HTB1 5.1CH", "HTB2 5.1CH" or "HTB3 5.1CH", the **DOLBY PRO LOGIC IIx**, **DTS-ES** and **DOLBY DIGITAL EX** listen modes cannot be selected.
- 2 If your selection is correct, press the **MULTI CONTROL** </> to select "OK" and press the **ENTER**. Now the speaker setup is complete. (Select "CANCEL" to return to the status before setup.)

• More detailed settings such as the volume level of each speaker and distance to each speaker are also available. - 20 ~ 21

Continued to next page

If you use another speaker system want a setup according to it:

❶ Press the MULTI CONTROL ◀ / ▶ to select "CUSTOM" and press the ENTER to select each of the speaker setup items.

❷ Press the MULTI CONTROL ◀ / ▶ to select the speaker setup item.

Press the MULTI CONTROL △ / ▽ to select the setting for each item.

| | | |
|--------------------------|-----------|-------------------------|
| Subwoofer | : "SUBW" | ⇒ "ON" or "OFF" |
| Front speakers | : "FRNT" | ⇒ "LRG" or "NML" |
| Center speaker | : "CNTR" | ⇒ "LRG", "NML" or "OFF" |
| Surround speakers | : "SURR" | ⇒ "LRG", "NML" or "OFF" |
| Back Surround speakers | : "BS" | ⇒ "LRG", "NML" or "OFF" |
| BS/SW Amp | : "BS/SW" | ⇒ "BS", "SW" or "OFF" |
| Subwoofer re-mix setting | : "REMIX" | ⇒ "ON" or "OFF" |

- "ON" : A subwoofer is connected. Subwoofer re-mix setting mode to the receiver is ON.
- "OFF" : No speaker is connected. Subwoofer re-mix setting mode to the receiver is OFF.
- "LRG" : Relatively large-size speakers.
- "NML" : Normal-size speakers.
- "BS" : A surround back speaker is connected to the SURR BACK/SW terminals.
- "SW" : A subwoofer is connected to the SURR BACK/SW terminals.

- When the subwoofer is set to "SUBW OFF", the front speaker is set automatically to "FRNT LRG".
- Options "LRG" for the center speaker, surround speakers and back surround speakers can be selected only when the front speakers setting is "FRNT LRG". However, when the surround speaker setting is "SURR NML", option "LRG" for the back surround speakers cannot be selected.

Subwoofer re-mix setting

If "REMIX ON" is selected as the subwoofer re-mix setting, the low frequencies are enhanced by adding the low frequencies of other channels to the subwoofer channel depending on the speaker setup.

Example: 5.1 ch Surround System

| | | |
|--------------------------|-----------|---------|
| Subwoofer | : "SUBW" | ⇒ "ON" |
| Front speakers | : "FRNT" | ⇒ "LRG" |
| Center speaker | : "CNTR" | ⇒ "NML" |
| Surround speakers | : "SURR" | ⇒ "NML" |
| Back Surround speakers | : "BS" | ⇒ "OFF" |
| BS/SW Amp | : "BS/SW" | ⇒ "OFF" |
| Subwoofer re-mix setting | : "REMIX" | ⇒ "ON"* |

Example: 6.1 ch Surround System

| | | |
|--------------------------|-----------|---------|
| Subwoofer | : "SUBW" | ⇒ "ON" |
| Front speakers | : "FRNT" | ⇒ "LRG" |
| Center speaker | : "CNTR" | ⇒ "NML" |
| Surround speakers | : "SURR" | ⇒ "NML" |
| Back Surround speakers | : "BS" | ⇒ "NML" |
| BS/SW Amp | : "BS/SW" | ⇒ "BS" |
| Subwoofer re-mix setting | : "REMIX" | ⇒ "ON"* |

Example: 7.1 ch Surround System

- Connect two surround back speakers (LB and RB) to the PRE OUT SURROUND BACK jacks, see "PRE OUT jacks connections". - [14]

| | | |
|--------------------------|-----------|---------|
| Subwoofer | : "SUBW" | ⇒ "ON" |
| Front speakers | : "FRNT" | ⇒ "LRG" |
| Center speaker | : "CNTR" | ⇒ "NML" |
| Surround speakers | : "SURR" | ⇒ "NML" |
| Back Surround speakers | : "BS" | ⇒ "NML" |
| BS/SW Amp | : "BS/SW" | ⇒ "OFF" |
| Subwoofer re-mix setting | : "REMIX" | ⇒ "ON"* |

* When the subwoofer setting is "SUBW ON", front speakers setting is "FRNT LRG" and a stereo source is played, the low frequencies may be reproduced through the front speakers and no audio output from the subwoofer in certain listen modes. In this case, the low-frequency signal can be output from the subwoofer by selecting "REMIX ON" for the subwoofer re-mix setting.

- When the speaker setting is set to "BS OFF", the DOLBY PRO LOGIC IIx, DTS-ES and DOLBY DIGITAL EX listen modes cannot be selected.

❸ After completing the setup, press the ENTER. If your selection is correct, press the MULTI CONTROL △ / ▽ to select "OK" and press the ENTER .

Now the speaker setup is complete. (Select "CANCEL" to return to the status before setup.)

- More detailed settings such as the volume level of each speaker and distance to each speaker are also available. - [20] ~ - [21]

STEP 3

Play a disc on the DVD player.

❶ Press the INPUT SELECTOR key to select "DVD".

❷ Start playback of the DVD player.

For the operation, also refer to the instruction manual for your DVD player.

- You can select various listen modes to enjoy surround playback of various kinds of video software. - [34]

Preparing for playback

Speaker settings

To enable you to obtain optimum enjoyment from the receiver's listening modes, make sure to complete the speaker settings (subwoofer, front, center, surround and surround back speakers) as described below.

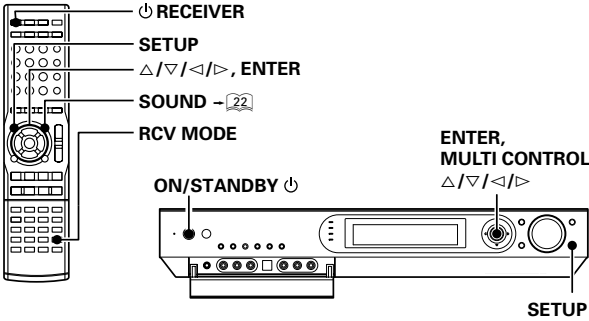

1 Turn on the power to this receiver by pressing the **ON/STANDBY** key (or the **RECEIVER** key).

2 If you want to use the remote control unit, press the **RCV MODE** key on the remote to set it to the receiver control mode.

3 Initiate the setup mode.

1 Press the **SETUP** key.

2 Use the **MULTI CONTROL** (or the keys) for the following displays.

- ① "SP SETUP"
- ② "SP LEVEL"
- ③ "DISTANCE"
- ④ "ASSIGN."
- ⑤ "LFE LEVEL"
- ⑥ "GAME FUNC"
- ⑦ "EXIT"

• While the main setup screen is displayed, the setup mode can be canceled by pressing the **SETUP** key or selecting "EXIT" and then pressing the **ENTER**.

4 Select the setup method.

1 Select "SP SETUP" and press the **ENTER** to select the speaker setup method.

2 Use the **MULTI CONTROL** (or the keys) for the following displays.

- ① "HTB1 6.1CH": Select "HTB1 6.1CH" if you use speaker system **KS-4200EX***.
- ② "HTB1 5.1CH": Select "HTB1 5.1CH" if you use speaker system **KS-2200HT***.
- ③ "HTB2 6.1CH": Select "HTB2 6.1CH" if you use speaker system **KS-3200HT*+KS-3200EX***, **KS-5200EX*** or **KS-7200HT*+KS-3200EX***.
- ④ "HTB2 5.1CH": Select "HTB2 5.1CH" if you use speaker system **KS-3200HT***, **KS-5200HT*** or **KS-7200HT***.
- ⑤ "HTB3 6.1CH": Select "HTB3 6.1CH" if you use speaker system **KS-8200EX***.
- ⑥ "HTB3 5.1CH": Select "HTB3 5.1CH" if you use speaker system **KS-8200HT***.
- ⑦ "CUSTOM": Select to set up the speakers according to the speaker system in use. (Speaker setup is required every time after the speaker system is changed.)
- ⑧ "EXIT": Press the **ENTER** again to return to the main setup displays.

* Model availability may differ depending on the country and sales area.

• When the 5.1 channel speaker system configuration is used or the speaker setting is set to "BS OFF", the DOLBY PRO LOGIC IIX, DTS-ES and DOLBY DIGITAL EX listen modes cannot be selected.

If you selected "HTB1 6.1CH", "HTB1 5.1CH", "HTB2 6.1CH", "HTB2 5.1CH", "HTB3 6.1CH" or "HTB3 5.1CH" in the above:

Press the **ENTER**, then press the **MULTI CONTROL** (or the keys) to select "OK", and press the **ENTER** again to establish the setup.

• Select "CANCEL" to return to the status before setup.

• When you use a KENWOOD speaker system and select "HTB1 6.1CH", "HTB1 5.1CH", "HTB2 6.1CH", "HTB2 5.1CH", "HTB3 6.1CH" or "HTB3 5.1CH" set the speaker setup, the audio will be corrected automatically according to the speaker characteristics.

If you selected "CUSTOM" in the above:

Press the **ENTER** to proceed to detailed setups.

The flow of the SETUP is as follows;

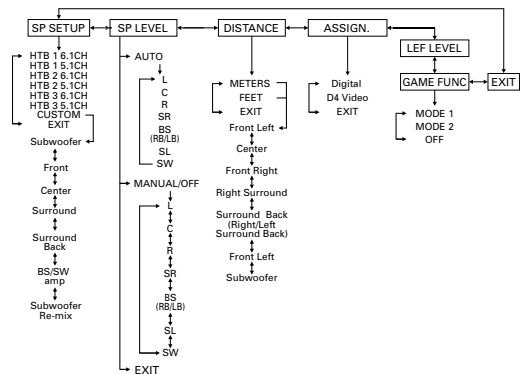

• The subwoofer setting indication "SUBW" appears.

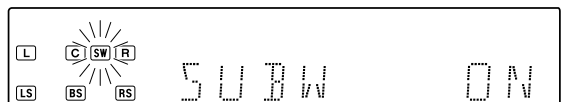

Continued to next page

5 Select a speaker system.

1 Use the MULTI CONTROL Δ / ∇ (or the Δ / ∇ keys) to select the appropriate subwoofer setting.

- ➔ ① "SUBW ON" :
When a subwoofer is connected.
- ➔ ② "SUBW OFF" :
When no subwoofer is connected.

- The initial setting is "SUBW ON".
- When "SUBW OFF" is selected and the selection is established by pressing the MULTI CONTROL \triangleright (or the \triangleright key) in step 2 below, the front speakers are set automatically to "FRNT LRG" and the procedure jumps to step 3.

2 Use the MULTI CONTROL \triangleright (or the \triangleright key) to accept the setting.

- The front speakers setting indication "FRNT" appears.

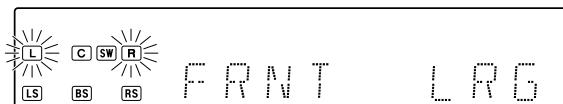

3 Use the MULTI CONTROL Δ / ∇ (or the Δ / ∇ keys) to select the appropriate front speakers setting.

- ➔ ① "FRNT LRG" :
Large front speakers are connected to the receiver.
- ➔ ② "FRNT NML" :
Average size front speakers are connected to the receiver.

- When the subwoofer setting is "SUBW ON", front speakers setting is "FRNT LRG" and a stereo source is played, the low frequencies may be reproduced through the front speakers and no audio output from the subwoofer in certain listen modes. In this case, set the subwoofer re-mix setting in step 10 to "REMIX ON" to output the low frequencies from the subwoofer.

4 Use the MULTI CONTROL \triangleright (or the \triangleright key) to accept the setting.

- The center speaker setting indication "CNTR" appears.

5 Use the MULTI CONTROL Δ / ∇ (or the Δ / ∇ keys) to select the appropriate center speaker setting.

- ➔ ① "CNTR LRG" :*
A large center speaker is connected to the receiver.
- ➔ ② "CNTR NML" :
An average size center speaker is connected to the receiver.
- ➔ ③ "CNTR OFF" :
When no center speaker is connected.

- * "CNTR LRG" cannot be selected when the front speakers have been set to "FRNT NML".

6 Use the MULTI CONTROL \triangleright (or the \triangleright key) to accept the setting.

- The surround speaker setting indication "SURR" appears.

7 Use the MULTI CONTROL Δ / ∇ (or the Δ / ∇ keys) to select the appropriate surround speaker setting.

- ➔ ① "SURR LRG" :*
Large surround speakers are connected to the receiver.
- ➔ ② "SURR NML" :
Average size surround speakers are connected to the receiver.
- ➔ ③ "SURR OFF" :
When no surround speakers are connected.

- * "SURR LRG" cannot be selected when the front speakers have been set to "FRNT NML".

- When "SURR OFF" is selected and the selection is established by pressing the MULTI CONTROL \triangleright in step 8 below, the procedure jumps to step 9. However, if the subwoofer setting is "SUBW OFF", the procedure jumps to step 10 so that you can complete the speaker setup and proceed to the speaker volume level adjustment in step 11.

8 Use the MULTI CONTROL \triangleright (or \triangleright key) to accept the setting.

- The surround back speaker setting indication "BS" appears.

9 Use the MULTI CONTROL Δ / ∇ (or the Δ / ∇ keys) to select appropriate surround back speaker setting.

- ➔ ① "BS LRG" :*
Large surround back speaker is connected to the receiver.
- ➔ ② "BS NML" :
Average size surround back speaker is connected to the receiver.
- ➔ ③ "BS OFF" :
When no surround back speakers is connected.

- * "BS LRG" cannot be selected when the surround speaker have been set to "SURR NML".

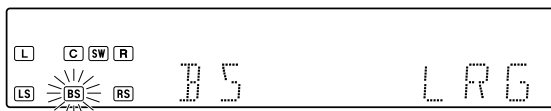

10 Use the MULTI CONTROL \triangleright (or the \triangleright key) to accept the setting.

- The surround back speaker and subwoofer setting mode indication "BS/SW" appears.

12 Use the MULTI CONTROL Δ / ∇ (or the Δ / ∇ keys) to select the appropriate BS/SW amp setting.

① "BS/SW BS":

Select this setting when a surround back speaker is connected to the **SURR BACK/SW** terminals. In this case, the subwoofer signal will be output from the **PRE OUT SUBWOOFER** jack.

② "BS/SW SW":

Select when the subwoofer speaker is connected to the **SURR BACK/SW** terminals. In this case, the surround back signals will be output from the **PRE OUT SURROUND BACK** jacks.

③ "BS/SW OFF":

Select when no speaker is connected to the **SURR BACK/SW** terminals. In this case, the subwoofer signal will be output from the **PRE OUT SUBWOOFER** jack and the surround back signals will be output from the **PRE OUT SURROUND BACK** jacks.

- If "BS/SW BS" is selected, only one surround back speaker can be connected to the receiver.
- If "BS/SW SW" or "BS/SW OFF" is selected, two surround back speakers can be connected to the **PRE OUT SURROUND BACK** jacks through an external power amplifier. 

13 Use the MULTI CONTROL \triangleright (or the \triangleright key) to accept the setting.

- The subwoofer re-mix setting indication "REMIX" appears.

13 Use the MULTI CONTROL Δ / ∇ (or the Δ / ∇ keys) to select the appropriate subwoofer re-mix setting.

If "REMIX ON" is selected as the subwoofer re-mix setting, the low frequencies are enhanced by adding the low frequencies of other channels to the subwoofer channel depending on the speaker setup.

① "REMIX ON":

Subwoofer re-mix setting mode to the receiver is ON.

② "REMIX OFF":

Subwoofer re-mix setting mode to the receiver is OFF.

- The initial setting is "REMIX ON".
- The subwoofer re-mix setting is possible only when the subwoofer setting is "SUBW ON" and the front speaker setting is "FRNT LRG".

14 Press the ENTER. If your selection is correct, press the MULTI CONTROL Δ / ∇ (or the Δ / ∇ keys) to select "OK".

Press the ENTER again to return to the main setup displays.

- Select "CANCEL" and press the ENTER to return to the status before setup.

6 Adjust the speaker volume level.

From your usual listening position, adjust the volume levels. The volume levels from each speaker should be the same.

- In steps **6**, indications appear only for the selected channels of the speakers that require adjusting.

① Use the MULTI CONTROL $\triangleleft / \triangleright$ (or the $\triangleleft / \triangleright$ keys) to select "SP LEVEL" on setup displays, and press the ENTER.

② Use the MULTI CONTROL $\triangleleft / \triangleright$ (or the $\triangleleft / \triangleright$ keys) to select "AUTO", "MANUAL" or "OFF".

① "AUTO": Select this setting to adjust the speaker volume levels using the test tone. The test tone will be output from every speaker channel in automatic sequence.

② "MANUAL": Select to select the speaker channel to output the test tone using the MULTI CONTROL $\triangleleft / \triangleright$ (or the $\triangleleft / \triangleright$ keys).

③ "OFF": Select to adjust the speaker volume levels using the current output signals. The speaker channel to output the output signal can be selected using the MULTI CONTROL $\triangleleft / \triangleright$ (or the $\triangleleft / \triangleright$ keys).

④ "EXIT": Press the ENTER again to return to the main setup displays.

When "AUTO" or "MANUAL" is selected and the ENTER is pressed again, the test tone output will start.

Use the MULTI CONTROL Δ / ∇ (or the Δ / ∇ keys) to adjust the volume level of the test tone output from the speaker channel to be adjusted.

For "AUTO" selection, the first test tone is heard from the front left speaker for 2 seconds. The next test tone is heard from the speakers in the following sequence for 2 seconds each.

When the "BS/SW BS" has been selected:

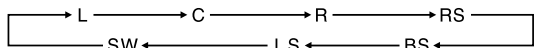

When the "BS/SW SW" or "BS/SW OFF" has been selected:

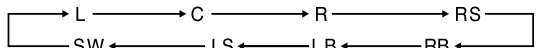

The channel indication blinks while the test tone is being output.



- When a speaker setup is set to off the volume level for the corresponding speakers is reset to 0 dB.

When "MANUAL" or "OFF" is selected, press the MULTI CONTROL $\triangleleft / \triangleright$ (or the $\triangleleft / \triangleright$ keys) to select the speaker channel and then press the MULTI CONTROL Δ / ∇ (or the Δ / ∇ keys) to adjust the speaker volume level.

③ Press the ENTER again to return to the main setup displays.

- The test tone is turned off and return to the main setup displays.

7 Input the distance to the speakers.

This setting allows the signals output from different speakers to reach the listening position simultaneously.

- In steps **7**, indications appear only for the selected channels of the speakers that require adjusting.

Measure the distance from the listening position to each of the speakers.

Jot down the distance to each of the speakers.

- Distance to Front speaker (L) : ___ feet (meters)
- Distance to Center speaker (C) : ___ feet (meters)
- Distance to Front speaker (R) : ___ feet (meters)
- Distance to Surround speaker (RS) : ___ feet (meters)
- Distance to Surround back speaker (RB) : ___ feet (meters)
- Distance to Surround back speaker (LB) : ___ feet (meters)
- Distance to Surround speaker (LS) : ___ feet (meters)
- Distance to Subwoofer (SW) : ___ feet (meters)

1 Use the MULTI CONTROL \leftarrow / \rightarrow (or the \leftarrow / \rightarrow keys) to select "DISTANCE" on setup displays, and press the ENTER.

2 Use the MULTI CONTROL \leftarrow / \rightarrow (or the \leftarrow / \rightarrow keys) to select the unit and press the ENTER.

- ① "METERS"
- ② "FEET"
- ③ "EXIT": Press the ENTER again to return to the main setup displays.

3 Use the MULTI CONTROL \leftarrow / \rightarrow (or the \leftarrow / \rightarrow keys) to select the speakers and the MULTI CONTROL \triangle / ∇ (or the \triangle / ∇ keys) to adjust the distance to the front speakers.

- The speaker indicator to be adjusted blinks.
- The speakers you have selected should appear on the display. Confirm that all the speakers have been correctly selected.

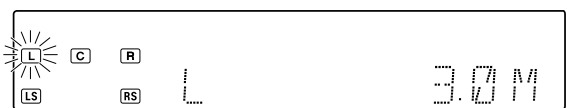

- The allowable setting range is 1 to 30 feet (0.3 to 9.0 m), adjustable in 1 foot (0.3 m) increments.

4 Repeat steps **3** to input the distance for each of the speakers.

5 Press the ENTER again to return to the main setup displays.

8 Adjust the LFE LEVEL (Low Frequency Effects level).

Adjust the level of the low-frequency fields effect (LFE) signal, which is the signal used exclusively for giving the field effect of bass tone, in the Dolby Digital or DTS signal.

1 Use the MULTI CONTROL \leftarrow / \rightarrow (or the \leftarrow / \rightarrow keys) to select "LFE LEVEL" on setup displays, and press the ENTER.

2 Use the MULTI CONTROL \triangle / ∇ (or the \triangle / ∇ keys) to adjust the LFE LEVEL.

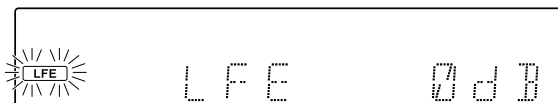

- The LFE LEVEL is adjusted from 0dB to -10dB in 1dB step decrements.

3 Press the ENTER again to return to the main setup displays.

9 Set up the GAME jacks on the front panel.

Perform the setup for convenience of playing a video game using the receiver.

1 Use the MULTI CONTROL \leftarrow / \rightarrow (or the \leftarrow / \rightarrow keys) to select "GAME FUNC" on setup displays, and press the ENTER.

2 Press the MULTI CONTROL \triangle / ∇ (or the \triangle / ∇ keys) to select the game mode.

- ① "MODE 1" :
When the connected game machine is turned ON, the input selector is switched automatically to "GAME". In addition, the ACTIVE EQ function is switched to "EQ GAME" and the listen mode is switched to the appropriate mode for games.
- ② "MODE 2" :
When the connected game machine is turned ON, the input selector is switched automatically to "GAME".
- ③ "OFF" :
The game mode is switched OFF.

- The game mode is not activated if no video signal is input to the VIDEO jack in the GAME jack section.
- The game mode is not activated when the DUAL SOURCE function is switched ON. → [24]

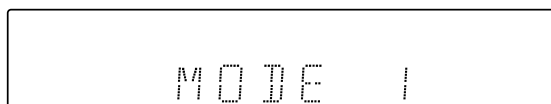

3 Press the ENTER again to return to the main setup displays.

Input level adjustment (analog sources only)

If the input level of an analog source signal is too high, the "CLIP" indicator will light up. Adjust the input level.

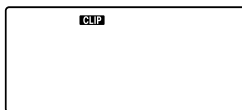

- ❶ Press the **RCV MODE** key on the remote control unit to set it to the receiver control mode.
- ❷ Press the **SOUND** key.
- ❸ Use the **MULTI CONTROL** </> (or the </> keys) to select "INPUT", and press the **ENTER**.
- ❹ Use the **MULTI CONTROL** Δ / ▽ (or the Δ / ▽ keys) to adjust the input level.

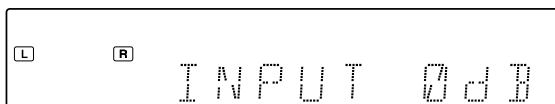

- The adjustment mode is displayed for approximately 20 seconds.
 - The input level may be adjusted to any one of three settings: 0dB, -3dB, and -6dB. (The initial setting is 0dB.)
 - You can store a separate input level for each input selector.
- ❺ Press the **SOUND** key again to return to the input indication.

Re-assignment of rear panel jacks

The assignment of the input selector positions to the digital audio and component video input jacks can be changed as desired.

- ❶ Press the **SETUP** key.
- ❷ Use the **MULTI CONTROL** </> (or the </> keys) to select "ASSIGN." on setup displays, and press the **ENTER**.
- ❸ Use the **MULTI CONTROL** </> (or the </> keys) to select "DIGITAL" or "COMPONENT", and press the **ENTER**.
 - ❶ "DIGITAL": Select to change the assignment of the digital audio input jacks of the receiver.
 - ❷ "COMPONENT": Select to change the assignment of the component video input jacks of the receiver.
 - ❸ "EXIT": Press the **ENTER** again to return to the main setup displays.

- ❹ Press the **MULTI CONTROL** </> (or the </> keys) to select the input jack name and then press the **MULTI CONTROL** Δ/▽ (or the Δ/▽ keys) to select the input selector position.

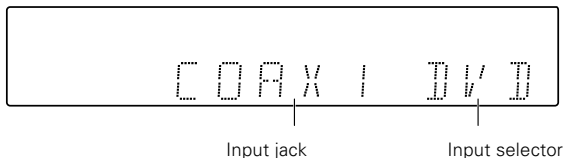

When the "DIGITAL" has been selected:

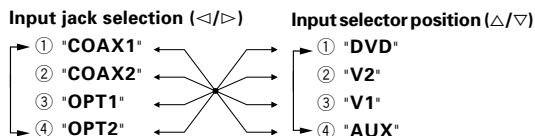

When the "COMPONENT" has been selected:

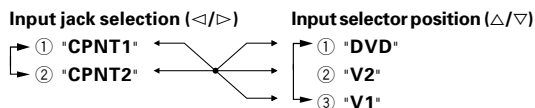

Use the following table for your memorandum.

| Jack name | Assigned input selector |
|-------------------------------------|-------------------------|
| COAX1 (DVD) | |
| COAX2 (VIDEO 2) | |
| OPT1 (VIDEO 1) | |
| OPT2 (AUX) | |
| COMPONENT VIDEO INPUT IN1 (DVD) | |
| COMPONENT VIDEO INPUT IN2 (VIDEO 2) | |

- It is not permitted to assign two input selector positions for one input jack.

- ❺ Repeat step ❹ until you have assigned the desired jacks to the desired input selector positions.
- ❻ Press the **ENTER** again to return to the main setup displays.

Normal playback

Some preparatory steps are needed before starting playback.

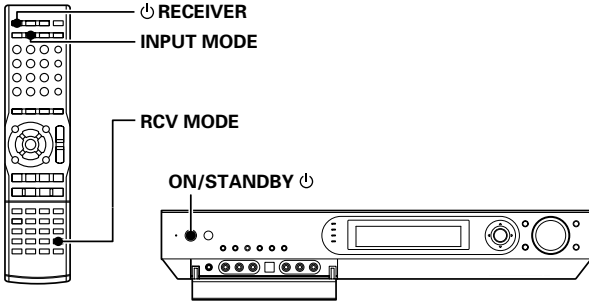

Turning on the receiver

- 1 Turn on the power to the related components.
- 2 Turn on the power to this receiver by pressing the ON/STANDBY ⏻ key (or the ⏻ RECEIVER key).

Selecting the input mode

If you have selected a component connected to the COAX 1 (DVD), COAX 2 (VIDEO 2), OPT 1 (VIDEO 1), OPT 2 (AUX) or DIGITAL IN (OPTICAL) jacks, make sure that the input mode setting is correct for the type of audio signal to be used. → 8

Listening to a source component

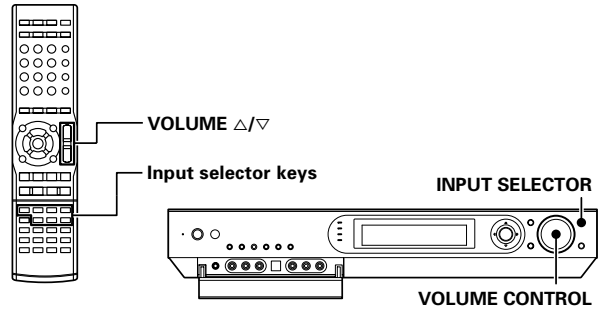

- 1 Press the INPUT SELECTOR key (or the input selector keys/ DVD, VIDEO 1, VIDEO 2, AUX, F.AUX, GAME, TUNER) to select the source you want to listen to.

- 1 Tuner (FM/AM broadcast reception)
- 2 "DVD"
- 3 "VIDEO1"
- 4 "VIDEO2"
- 5 "GAME"
- 6 "FRONT AUX"
- 7 "AUX"

- 2 Start playback from the selected source.

- 3 Use the VOLUME CONTROL knob (or the VOLUME Δ/∇ keys) to adjust the volume.

Listening with headphones

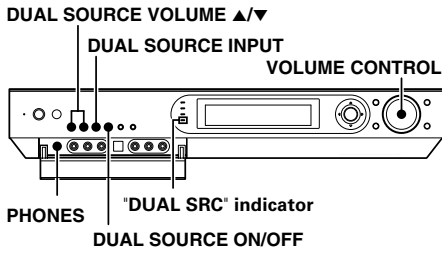

- 1 Connect headphones to the PHONES jack.

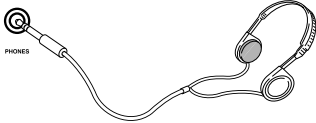

- 2 Use the VOLUME CONTROL knob (or the VOLUME Δ/∇ keys) to adjust the volume.

Playing difference sources through speakers and headphones (DUAL SOURCE function)

While you enjoy audio listening through the speakers, another person can enjoy another source (audio + video) through headphones by connecting the source to the **GAME** or **FRONT AUX** jacks.

- 1 Connect headphones to the PHONES jack.
- 2 Press the DUAL SOURCE ON/OFF key to switch the DUAL SOURCE function ON.
 - When the DUAL SOURCE function is ON, the video and headphone outputs reproduce only the second input source of the DUAL SOURCE function. At this time, the audio from the main source, which is selected with the input selector, continues to be monitored through the speakers. Switching the DUAL SOURCE function OFF restores the main input source signals to the video and headphone outputs.

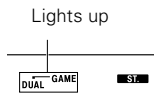

- 3 Press the DUAL SOURCE INPUT key to select the second input source for the DUAL SOURCE function.

1 "GAME" :

The "GAME" input is selected as the second input source for the DUAL SOURCE function.

2 "F. AUX" :

The "F. AUX" input is selected as the second input source for the DUAL SOURCE function.

- 4 Press the DUAL SOURCE VOLUME Δ/∇ to adjust the headphone listening volume.

- When the DUAL SOURCE function is ON, the input mode for the second input source is fixed at "ANALOG".

The listen mode cannot be changed. \rightarrow [8] \rightarrow [34]

Adjusting the sound

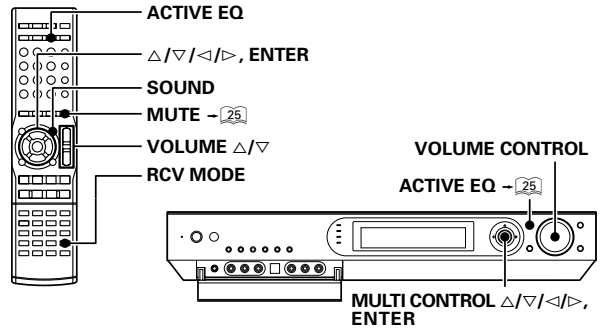

Adjusting the TONE (PCM stereo and analog stereo mode only)

- 1 Press the RCV MODE key on the remote control unit to set it to the receiver control mode.
- 2 Press the SOUND key.
- 3 Use the MULTI CONTROL \triangle/\triangleright (or the \triangle/\triangleright keys) to select "TONE", and press the ENTER.
- 4 Use the MULTI CONTROL Δ/∇ (or the Δ/∇ keys) to select "TONE ON", and press the ENTER.

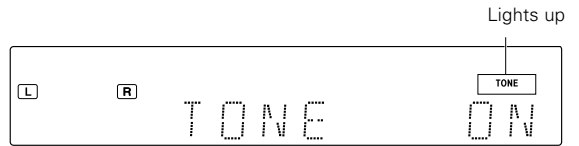

- 5 Use the MULTI CONTROL \triangle/\triangleright (or the \triangle/\triangleright keys) to select "BASS" or "TREBLE".

1 "BASS" :

Select this to adjust the low frequency range.

2 "TREBLE" :

Select this to adjust the high frequency range.

- 6 Use the MULTI CONTROL Δ/∇ (or the Δ/∇ keys) to adjust the sound quality.

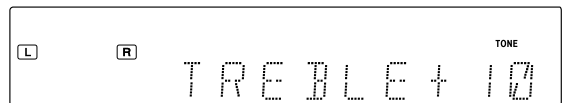

- 7 Repeat steps 5 and 6 as required.

- The bass and treble levels are adjustable from -10 to +10 in 2 step increments.
- The adjustment item is displayed for approximately 20 seconds.

- 8 Press the SOUND key again to return to the input indication.

ACTIVE EQ mode

You can enjoy a more impressive sound effect when ACTIVE EQ is turned ON.

Press the **ACTIVE EQ** key for the following selections:

- ① **"EQ MUSIC"** : (The **"ACTIVE EQ"** indicator lights up)
Effective when listening to music.
- ② **"EQ CINEMA"** : (The **"ACTIVE EQ"** indicator lights up)
Effective when watching a movie.
- ③ **"EQ GAME"** : (The **"ACTIVE EQ"** indicator lights up)
Effective when playing a game.
- ④ **"EQ OFF"** : (The **"ACTIVE EQ"** indicator goes off)
The ACTIVE EQ function is turned OFF.

- The ACTIVE EQ function is not available in when the REC MODE or virtual mode is ON.

Muting the sound

The **MUTE** key lets you mute the sound of the speakers or headphones.

Press the **MUTE** key.

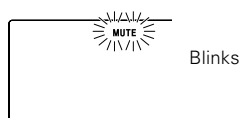

To cancel

Press the **MUTE** key again so that the **"MUTE"** indicator goes off.

- MUTE ON can also be deactivated by turning the **VOLUME CONTROL** knob (or pressing the **VOLUME** Δ/∇ keys).

Recording

Analog sources

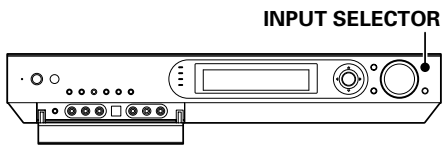

- 1 Use the **INPUT SELECTOR** key (or the input selector key) to select the source (other than "VIDEO 1") you want to record.
- 2 Put the component connected to the **VIDEO 1** jacks to the record-pause mode.
- 3 Start playback, then start recording.
 - Recording may not be normal for some video software. This is due to the copy guard condition.

Digital sources

Switch on the REC MODE to record a digital input source. When the digital input source changes during recording in the REC MODE, the audio signal may be interrupted momentarily.

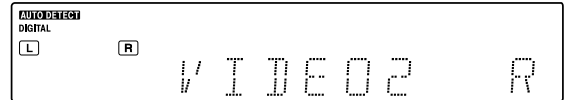

The display switches automatically.

- 4 Start playback, then start recording.

Recording music in REC mode

When a multi-channel source such as the Dolby Digital or DTS input signal is recorded in REC mode, the multi channel signal in the current surround mode can be recorded down-mixed to 2-channel.

- DTS 5.1 MUSIC DISC (DTS CD) cannot be recorded.

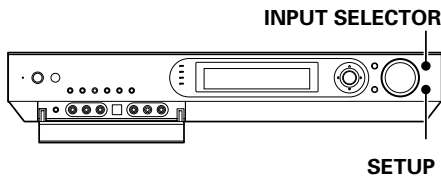

- 1 Use the **INPUT SELECTOR** key (or the input selector keys) to select the source ("DVD", "VIDEO 2", "AUX" or "GAME") you want to record.
- 2 Put the component connected to the **VIDEO 1** jacks to the record-pause mode.
- 3 Press and hold the **SETUP** key for more than 2 seconds to select the "REC MODE".

- 1 REC mode off
- 2 "REC MODE": REC mode on

Multi-channel digital signals (DTS or Dolby Digital) are down-mixed to 2-channel before being output from the analog recording (REC OUT) jacks.

Listening to radio broadcasts

The receiver can store up to 40 stations in the memory and recall them by one-touch operation. Radio stations can be classified into RDS (Radio Data System) stations and other stations. To listen to or store RDS stations in the preset memory see "Using RDS (Radio Data System) (For Europe and Australia)". → 29

Tuning (non-RDS) radio stations

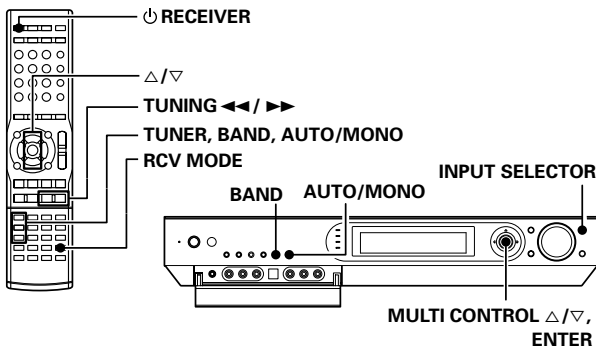

1 Use the **INPUT SELECTOR** key (or the **TUNER** key) to select the tuner.

2 Use the **BAND** key to select the desired broadcast band.

Each press switches the band.

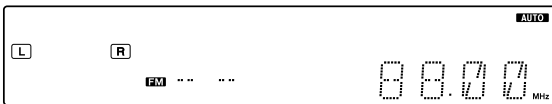

3 Use the **AUTO/MONO** key to select the desired tuning method.

Each press switches the tuning method to either auto or manual tuning.

- ① Auto tuning:
The "AUTO" indicator lights up.
- ② Manual tuning:
The "AUTO" indicator goes off.

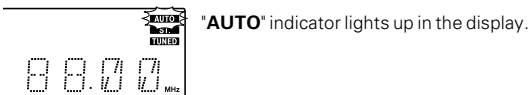

- Normally, set to "AUTO" (auto tuning). If the radio waves are weak and there is a lot of interference, switch to manual tuning. (With manual tuning, stereo broadcasts will be received in monaural.)

4 Use the **MULTI CONTROL** Δ/∇ (or the Δ/∇ keys, **TUNING** \leftarrow/\rightarrow) to select the station.

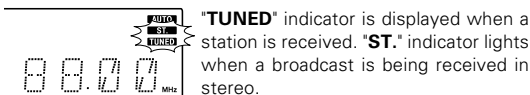

Auto tuning:
The next station is tuned automatically.

Manual tuning:
Use the **MULTI CONTROL** Δ/∇ (or the Δ/∇ keys) to select the desired station.

Presetting radio stations

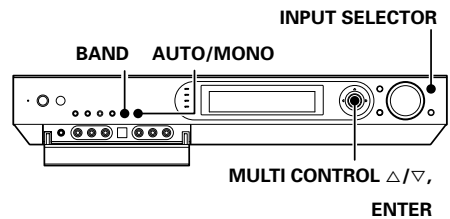

Collective presetting of stations

(For U.S.A. and Canada)

- 1** Use the **INPUT SELECTOR** key (or the **TUNER** key) to select the tuner.
- 2** Use the **BAND** key to select the broadcast band to "FM".
- 3** Press and hold the **ENTER** for more than 2 seconds.

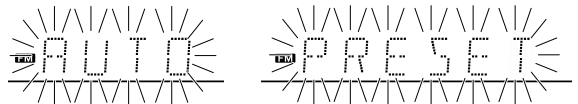

The "AUTO" display and "PRESET" display appear alternately.

- A maximum of 40 stations of the band presently being received will be preset.
- Use the Manual Preset function if a desired FM station cannot be preset using the Auto Preset function or when it is required to preset AM stations.

Presetting radio stations manually

- 1** Tune to the station you want to store.
- 2** Press the **ENTER** while receiving the station.

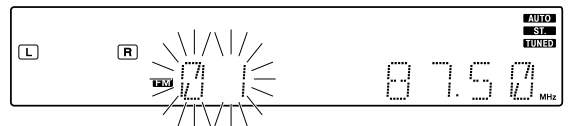

Proceed to step **3** within 20 seconds. (If more than 20 seconds elapse, press the **ENTER** again).

- 3** Use the **MULTI CONTROL** Δ/∇ (or the Δ/∇ keys) to select one of the station presets (1 – 40).
- 4** Press the **ENTER** again to confirm the setting.
 - Repeat steps **1**, **2**, **3**, and **4** to store as many stations as necessary.
 - If you store a station at a previously used preset, the old station will be replaced by the new one.

Receiving preset stations

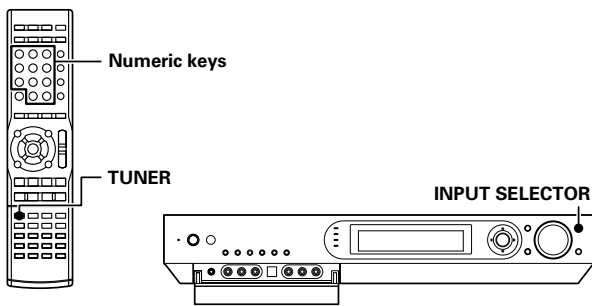

1 Use the **INPUT SELECTOR** key (or the **TUNER** key) to select tune as the source.

2 Enter the number of the preset station you want to receive (up to "40").

Press the numeric keys in the following order:

For "15", press **+10**, **5**

For "20", press **+10**, **+10**, **0**

- If you make a mistake entering a two digit number, press the **+10** key repeatedly to return to the original display and start again.

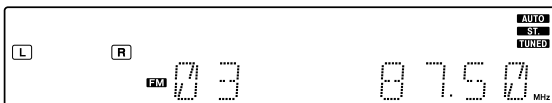

Receiving preset stations in order (P.CALL)

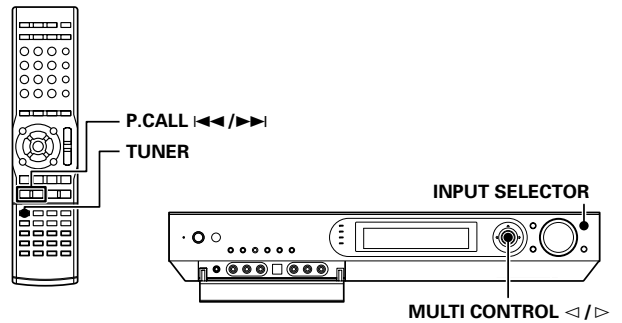

1 Use the **INPUT SELECTOR** key (or the **TUNER** key) to select tune as the source.

2 Use the **MULTI CONTROL** $\triangleleft/\triangleright$ (or the **P.CALL** $\triangleleft\triangleleft/\triangleright\triangleright$ keys) to select the desired station.

- Each time you push the Joystick, another preset station is received in order.

Pushing the Joystick to \triangleright does the following:

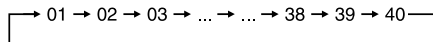

Pushing the Joystick to \triangleleft does the following:

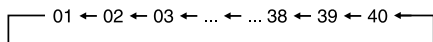

Holding the Joystick on \triangleright or \triangleleft direction, lets you skip through the presets, receiving each preset station at 0.5 second intervals.

Using RDS (Radio Data System) (For Europe and Australia)

Before using a function utilizing the RDS, be sure to perform the RDS Auto Memory operation by referring to the description in "Presetting RDS stations (RDS AUTO MEMORY)".

RDS is a system that transmits useful information (in the form of digital data) for FM broadcasts along with the broadcast signal. Tuners and receivers designed for RDS reception can extract the information from the broadcast signal for use with various functions, such as automatic display of the station name.

RDS functions:

PTY (Program TYPe Identification) Search

-30

Automatically tunes to a station that is currently broadcasting the specified program type (genre).

PS (Program Service Name) Display

Automatically displays the station name transmitted by the RDS station.

RDS AUTO MEMORY function

Automatically selects and stores up to 40 RDS stations in the preset memory.

If fewer than 40 RDS stations have been stored in the preset memory, regular FM stations will be stored in the remaining places.

Radio Text function

Displays the radio text data transmitted by some RDS stations when you press the **RDS DISP.** (display) key. There is "NO RT" if no text data is transmitted.

The "RDS" indicator lights up when an RDS broadcast (signal) is received.

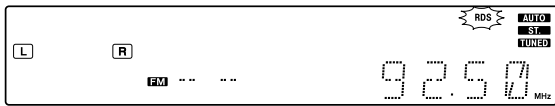

Note

Some functions and function names may differ for certain countries and areas.

Presetting RDS stations (RDS AUTO MEMORY)

This function automatically stores up to 40 RDS stations in the preset memory. In order to use the PTY function, the RDS stations must be stored in the preset memory using the RDS Auto Memory function.

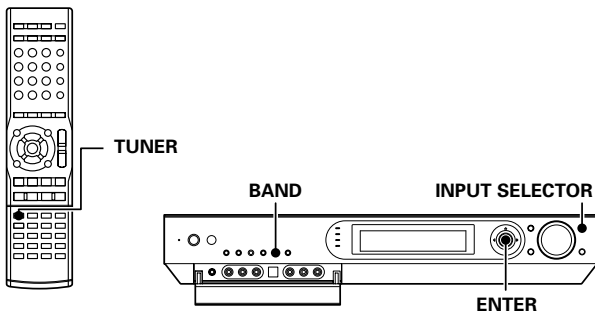

1 Use the **INPUT SELECTOR** key (or the **TUNER** key) to select tuner as the source.

2 Use the **BAND** key to select the broadcast band to "FM".

3 Press the **ENTER** key continuously for more than 2 seconds will start **AUTO MEMORY**.

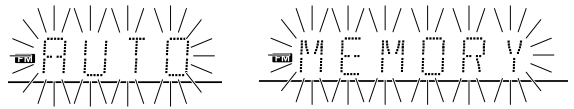

The "AUTO" display and "MEMORY" display appear alternately.

- After a few minutes, up to 40 RDS stations are preset in order from channel "01".
- Stations already stored in the preset memory may be replaced by RDS stations. (i.e., If the RDS AUTO MEMORY function detects 15 RDS stations, the stations currently preset at numbers 01~15 will be replaced by the RDS stations.)

Using the RDS DISP. (Display) key

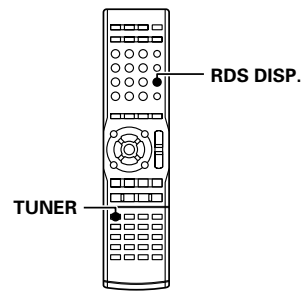

Pressing the **RDS DISP.** key changes the contents of the display.

Each press switches the display mode as follows :

- 1 PS (Program Service name) display
- 2 RT (Radio Text) display
- 3 Frequency display

1 PS (Program Service name) display :

The station name is displayed automatically when an RDS broadcast is received.

If no PS data was sent, "NO PS" is displayed.

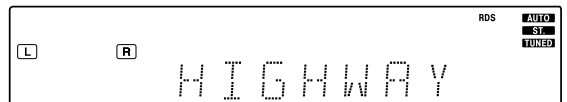

2 RT (Radio Text) display :

Text data accompanying the RDS broadcast scrolls across the display. "NO RT" or "RT ----" is displayed if the current RDS station does not provide RT data.

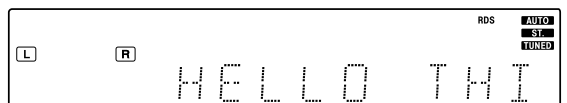

3 Frequency display :

Displays the frequency of the current station.



Tuning by Program Type (PTY search)

This function lets you set the tuner to automatically search for stations which are currently broadcasting the type of program (genre) you want to listen to.

Under certain receiving conditions, it may take more than 1 minute to complete the search.

Preparations

- Execute the RDS auto memory procedure.
- Set the broadcast band to FM.

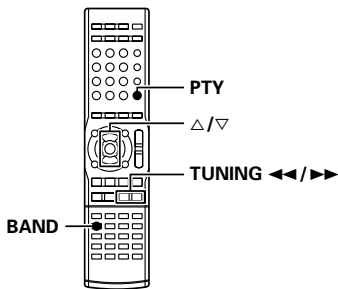

1 Press the PTY key to activate the PTY search mode.

Lights up



When an RDS broadcast is received, the program type is shown on the display. If no PTY data is available, or if the station is not an RDS station, "NONE" is displayed.

2 While the "PTY" indicator is lit, use the Δ/∇ keys (or the TUNING <</> keys) to select the program type of your choice.

Program type table

| Program Type Name | Display | Program Type Name | Display |
|-------------------------|----------|-----------------------|----------|
| Pop Music | POP M | Weather | WEATHER |
| Rock Music | ROCK M | Finance | FINANCE |
| Easy Listening Music | EASY M | Children's Programmes | CHILDREN |
| Light Classical Music | LIGHT M | Social Affairs | SOCIAL |
| Serious Classical Music | CLASSICS | Religion | RELIGION |
| Other Music | OTHER M | Phone In | PHONE IN |
| News | NEWS | Travel | TRAVEL |
| Current Affairs | AFFAIRS | Leisure | LEISURE |
| Information | INFO | Jazz Music | JAZZ |
| Sport | SPORT | Country Music | COUNTRY |
| Education | EDUCATE | National Music | NATION M |
| Drama | DRAMA | Oldies Music | OLDIES |
| Culture | CULTURE | Folk Music | FOLK M |
| Science | SCIENCE | Documentary | DOCUMENT |
| Varied Speech | VARIED | | |

3 Press the PTY key to start searching.

Example: Searching for a Pop Music broadcast.

Display while searching.

Blinks

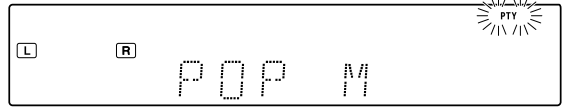

Program type name display

Display when a station is received.

Goes out



Station name display

- No sound is heard while "PTY" is blinking.
- If the desired program type cannot be found, "NO PROG" is displayed, then after several seconds the display returns to the original display.

To select another program type.

Repeat steps 1, 2 and 3.

Ambience effects

This receiver is equipped with listening modes that allow you to enjoy an enhanced sonic ambience with a variety of video sources.

In order to obtain the optimum effect from the surround modes, make sure to input the proper speaker settings beforehand. → 18

Surround modes

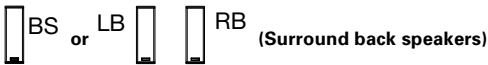
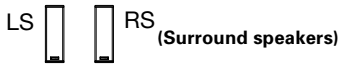
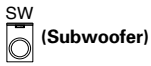
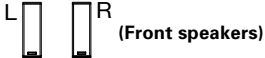

Dolby Digital EX

Dolby Digital EX is an extension of Dolby Digital technology, Dolby Digital EX creates six full-bandwidth output channels from 6.1-channel sources. This is done using a matrix decoder that derives three surround channels from the two in the original recording.

This is achieved by using three different surround signals, Left Surround, Right Surround, and Back Surround, each driving its own array of speakers. Think of it as adding a center channel for the rear speakers, which give more diffuse and natural surround effect, even if you wanted the ability to completely encircle the audience with sound, positioning sound effects exactly where they would be heard in real life.

Note

For best results, Dolby Digital EX should be used with movie soundtracks recorded with Dolby Digital Surround EX which contain a digital flag that will automatically activate this feature. However, for titles released prior to late 2001, this feature has to be activated manually.

This model lets you enjoy Dolby Digital (and Dolby Surround) program sources, even if you connect only the Front Speakers. However, in order to enjoy the benefit of true 6.1 channel Dolby Digital Surround EX sound, KENWOOD recommends that you connect a full set of speakers.

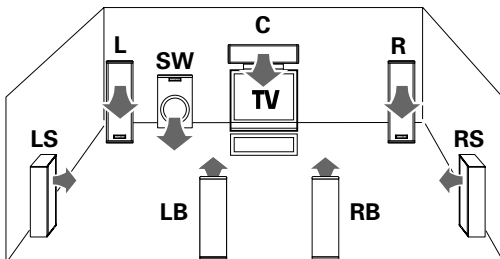

Dolby PRO LOGIC IIX/ Dolby PRO LOGIC II

Dolby Pro Logic IIX was designed specifically to provide a new sense of spatiality, directionality and articulation of sounds from Dolby Surround encoded sources.

This is achieved with an intelligent, built-in feedback logic design, a matrix surround decoding and the decoding of stereo, full bandwidth surround outputs. The PRO LOGIC IIX modes programmed into this receiver are "MOVIE", "MUSIC" and "GAME". The "MOVIE" mode of the PRO LOGIC IIX has preset characteristics to produce a calibrated, high-level surround sound playback while the "MUSIC" mode has user-adjustable characteristics to offer the three optional controls, like "Dimension", "Center Width" and "Panorama" modes to allow optimization of the soundfields as desired. The "Dimension" control allows the user to gradually adjust the soundfield either towards the front or towards the rear; the "Center Width" control allows various adjustment of the left-center-right speakers' balance; the "Panorama" mode extends the front stereo image to include the surround speakers for an exciting "wraparound" effect with side wall imaging. The "GAME" mode is designed for playing video games and enhances the powerful feeling of sound.

Dolby PRO LOGIC IIX

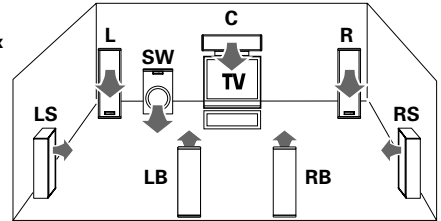

Dolby PRO LOGIC II

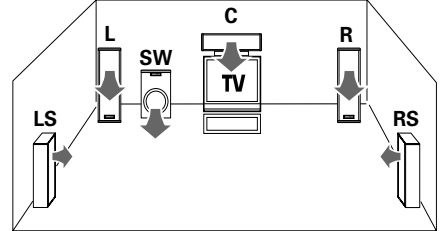

Dolby Digital

Dolby Digital surround format lets you enjoy up to 5.1 channels of digital surround sound from Dolby Digital program sources (such as Laserdisc or DVD software marked). Compared with previous Dolby surround, Dolby Digital provides even better sound quality, greater spatial accuracy, and improved dynamic range.

This model lets you enjoy Dolby Digital (and Dolby Surround) program sources, even if you connect only the Front Speakers. However, in order to enjoy the benefit of true 5.1 channel Dolby Digital surround sound, KENWOOD recommends that you connect a full set of speakers.

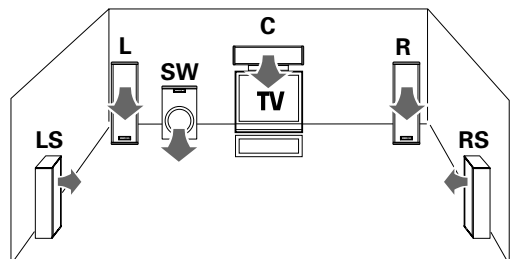

DTS-ES

The DTS-ES (Digital Theater System-Extended Surround) represents 6.1-channel Discrete Surround format, expanding upon 5.1 surround. DTS-ES format is a 6.1 channel sound system for movie theaters that includes an additional surround center channel matrixed within surround left and surround right. It's compatible on predecessor DTS 5.1 system. The extra channel allows more accurate placement and steering of sound across the rear soundstage. The DTS-ES receiver will be required, to experience a discrete 6.1-channel mix. The DTS-ES decoders used in home cinema systems have decoding options for utilizing the extra channel, in addition to processing existing 5.1 channel surround sound :

DTS-ES Discrete 6.1 and DTS-ES Matrix 6.1 add the surround back channel audio to the DTS 5.1-channel format to improve the acoustic positioning and makes acoustic image movement more natural with the 6.1-channel reproduction.

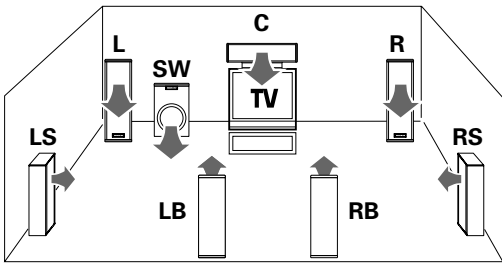

DTS

The DTS employs a larger amount of data than Dolby Digital to play surround sound with higher quality. The DTS can be used with DVD and LaserDisc software carrying the **DTS** mark. Although the number of channels is 5.1 and identical to Dolby Digital, the DTS format features lower audio compression rate in digital recording, which enables audio with more profoundness and higher S/N. The wider dynamic range and better channel separation also contribute to make the surround sound more precise and larger in scale.

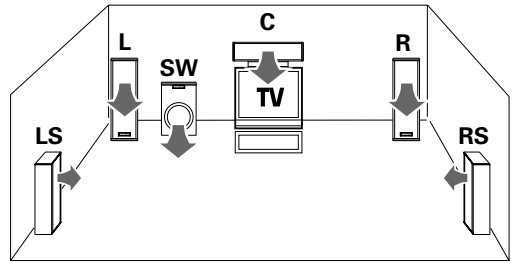

NEO:6

NEO:6 is a new technology which decodes 2-channel signals into 6-channel signals using high-accuracy digital matrix technology. For the best results, DTS-ES should be used with movie sound tracks recorded with DTS-ES format which contain a digital flag that will automatically activate this feature. However, for some titles, this feature has to be activated manually. According to the signals to be played back, DTS NEO:6 uses either the NEO:CINEMA mode optimized for movie playback or the NEO:MUSIC mode optimized for music playback.

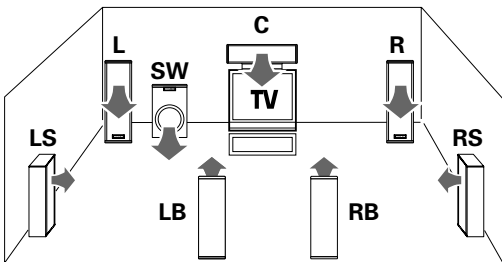

DSP mode

The DSP mode lets you add the atmosphere of a live concert or hall to almost any type of program source. These modes are particularly effective when used with stereo program sources, like CD, television, and FM radio. You might enjoy trying the ARENA, JAZZ CLUB, THEATER, STADIUM or DISCO mode the next time you watch a concert or sporting event!

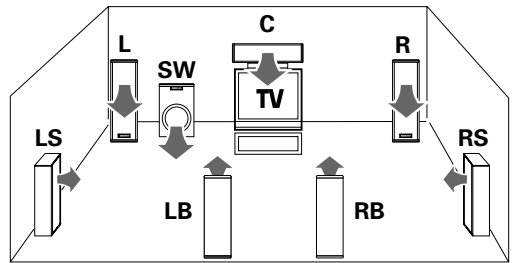

What's DSP?

DSP stands for Digital Signal Processor. The way a sound is heard in an actual environment depends on a variety of different factors. One of the most important is reverberation (the act of decaying elements of sound echoing in various places). The DSP modes produce the feeling of presence by using the DSP to create reverberation, without spoiling the sound quality of the original signal.

DTS 96/24

The DTS 96/24 enables 5.1-channel playback with broad bandwidth over 40 kHz and high resolution without affecting the picture quality of DVD video. As it is compatible with the DTS surround playback, it makes it possible to play DTS 5.1-channel surround audio even when the AV amplifier incorporates only the DTS or DTS-ES decoder.

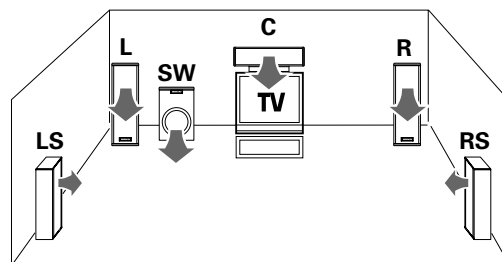

LFE = Low Frequency Effects. This channel delivers separate non-directional bass signals to the subwoofer for more dynamic deep bass sound effects. When there is a LFE channel input in the DOLBY DIGITAL or DTS format, the 'LFE' indicator lights on the display of the receiver.

Dolby Virtual Speaker

The Dolby Virtual Speaker features a virtual surround sound field. This implements an effect as if there are multiple speakers in the listening room.

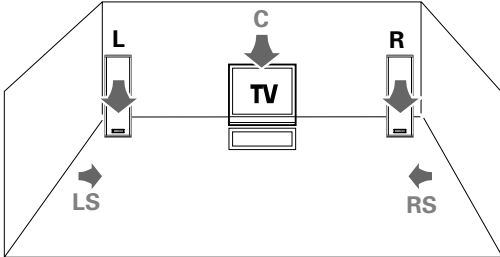

Dolby Headphone

When headphones are used in music listening, the audio of the left (or right) channel reaches only the left (or right) ear so the listener cannot feel the presence of acoustic images on the front.

The Dolby Headphone simulates a virtual room and include its acoustic characteristics in the left and right headphone signals. As a result, the listener can hear the same components as in speaker listening through the left and right ears and therefore feel as if the sound source is located on the front of the listener.

Virtual modes

The following modes allow you to enjoy powerful surround audio even when you use only two speakers or listen through headphones.

- The desired listen mode may be unable to be selected depending on the reproduced signals. → 34

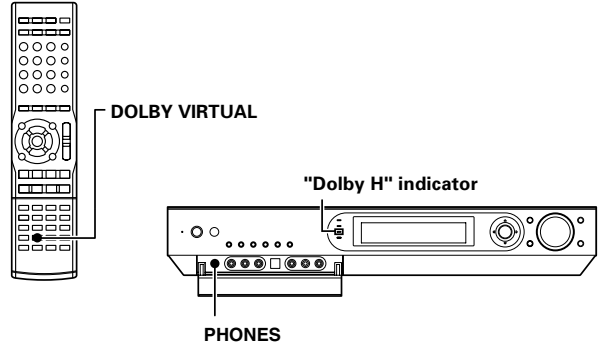

How to set the Dolby Virtual Speaker mode (when not using headphones):

Press the DOLBY VIRTUAL key for the following selections:

- ① "DVS WIDE" :
The virtual surround effect can be given added expansion and spatial feeling.
 - ② "DVS REF" : *
Standard setting.
 - ③ "DVS OFF" : Cancel
- * This mode can be selected only when the surround speaker setting is OFF.

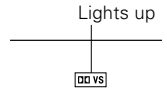

How to set the Dolby Headphone mode (when using headphones):

Press the DOLBY VIRTUAL key for the following selections:

- ① "DH 1":
Monitor room in a studio with small amount of reverberations.
- ② "DH 2":
General listening with optimum amount of reverberations.
- ③ "DH 3":
Wide space such as a movie theater.
- ④ "OFF": Cancel

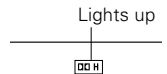

- The Dolby Virtual Speaker or Dolby Headphone mode is defeated when the DUAL SOURCE mode or REC MODE is ON.

Manufactured under license from Dolby Laboratories. "Dolby", "Pro Logic", "Surround EX" and the double-D symbol are trademarks of Dolby Laboratories.

"DTS", "DTS-ES Extended Surround", "Neo:6" and "DTS 96/24" are trademarks of Digital Theater Systems, Inc.

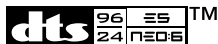

Surround play

The desired listen mode can be selected according to the input signal.

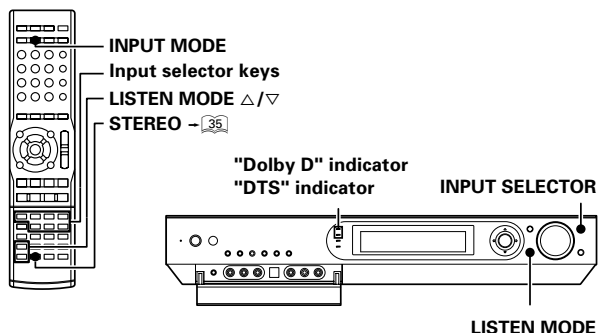

Preparations

- Turn ON related components.
- Complete **"Preparing for playback" (Speaker settings)**. → [18]
- Use the **INPUT SELECTOR** key (or input selector keys) to select the component you wish to play back with surround sound.
- Use the **INPUT MODE** key to select the input mode (analog or digital) for the source you wish to play back. → [8]
- Noise will be produced when a DTS source is played by selecting the analog input.

1 Start playing the video software.

2 Press the LISTEN MODE key (or the LISTEN MODE Δ/▽ keys) to select the listening mode.

The listening mode settings are stored separately for each input selector.

If the input mode is set to full auto ("AUTO DETECT" lights), this model selects the optimal listening mode automatically based on the type of input signal and the speaker settings.

Each press the LISTEN MODE key (or the LISTEN MODE Δ/▽ keys) switches the setting as listed below. The listening mode settings are different depending on the type of input signal.

Listen modes available with Dolby Digital EX or Dolby Digital playback: ("Dolby D" indicator lights up)

Main example of medium:

Multi-channel digital source such as DVD.

- | | |
|----------------------------|--|
| ① "DOLBY D": | DOLBY DIGITAL surround |
| ② "DOLBY D EX": | DOLBY DIGITAL EX surround |
| ③ "DOLBY D + PLIIx MOVIE": | DOLBY DIGITAL surround + DOLBY PRO LOGIC IIX surround MOVIE mode *1 |
| ④ "DOLBY D + PLIIx MUSIC": | DOLBY DIGITAL surround + DOLBY PRO LOGIC IIX surround MUSIC mode |
| ⑤ "STEREO": | Stereo playback*2 |

*1 Can be selected only when two surround back speakers are connected.

*2 In Dolby Virtual Speaker and Dolby Headphone modes, the Dolby Digital signal input cannot be listened to in the stereo mode.

- You can also adjust the midnight mode as desired. → [38]

Listen modes available with DTS, DTS-ES (Matrix or Discrete) or DTS-96/24 playback: ("DTS" indicator lights up)

Main example of medium:

Multi-channel digital source such as DVD.

- | | |
|--------------------------|---|
| ① "DTS": | DTS surround |
| ② "DTS + NEO6 CINEMA": | DTS surround + DTS NEO:6 surround CINEMA mode |
| ③ "DTS-ES MATRIX 6.1": | DTS-ES 6.1-channel Matrix surround *1 |
| ④ "DTS-ES DISCRETE 6.1": | DTS-ES 6.1-channel Discrete surround *2 |
| ⑤ "DTS 96/24": | DTS 96/24 surround *3 |
| ⑥ "STEREO": | Stereo playback *4 |

*1 Can be selected only with DTS-ES 6.1ch Matrix Surround.

*2 Can be selected only with DTS-ES 6.1ch Discrete Surround.

*3 Can be selected only with DTS 96/24 Surround.

*4 In Dolby Virtual Speaker and Dolby Headphone modes, the DTS signal input cannot be listened to in the stereo mode.

- You can also adjust the midnight mode as desired. → [38]

Continued to next page

Listen modes available with analog or PCM playback:

Main example of medium:

Digital sources including DVD 96 kHz linear PCM and CD.

Analog source such as VCR or radio broadcasting.

① **"PL IIx MOVIE":**

DOLBY PRO LOGIC IIx surround MOVIE mode *1

② **"PL IIx MUSIC":**

DOLBY PRO LOGIC IIx surround MUSIC mode *1 *2

③ **"PL IIx GAME":**

DOLBY PRO LOGIC IIx surround GAME mode *1

④ **"PL II MOVIE":**

DOLBY PRO LOGIC II surround MOVIE mode

⑤ **"PL II MUSIC":**

DOLBY PRO LOGIC II surround MUSIC mode *2

⑥ **"PL II GAME":**

DOLBY PRO LOGIC II surround GAME mode *3

⑦ **"PRO LOGIC":**

DOLBY PRO LOGIC surround

⑧ **"NEO6 CINEMA" or "NEO6 96K CINEMA":**

DTS NEO:6 surround CINEMA mode

⑨ **"NEO6 MUSIC" or "NEO6 96K MUSIC":**

DTS NEO:6 surround MUSIC mode *1 *4

⑩ **"ARENA":**

DSP surround ARENA mode *5

⑪ **"JAZZ CLUB":**

DSP surround JAZZ CLUB mode *5

⑫ **"THEATER":**

DSP surround THEATER mode *5

⑬ **"STADIUM":**

DSP surround STADIUM mode *5

⑭ **"DISCO":**

DSP surround DISCO mode *5

⑮ **"STEREO":**

Stereo playback.

*1 Cannot be selected in Dolby Virtual Speaker and Dolby Headphone modes.

*2 The sound field can be adjusted as desired using the PANORAMA, DIMENSION and CENTER WIDTH modes. → [37]

*3 Cannot be selected in Dolby Virtual Speaker modes.

*4 The sound field can be adjusted as desired using the CENTER IMAGE modes. → [38]

*5 Cannot be selected in Dolby Virtual Speaker and Dolby Headphone modes or with a 96 kHz linear PCM signal input.

The effect level of the DSP surround mode can be adjusted as desired. → [36]

3 Adjust the volume.

Notes

- Certain modes may be unavailable depending on the type of input signal or speaker setting.
- If an optimum surround effect cannot be obtained or the desired mode cannot be selected, check the speaker and input mode settings. → [8] - [18]

Dolby Digital Surround EX compliant disc :

Dolby Digital Surround EX compliant disc contains identification signals. When you choose FULL AUTO during "Input mode settings" (→ [8]), this amplifier detects the identification signals and change the LISTEN mode to the DOLBY DIGITAL EX (Dolby Digital Surround EX mode) automatically. But sometimes we find some discs which are Dolby Digital Surround EX compliant disc but it does not contain the identification signals. If you find the notice like "Surround EX" on the label of disc or package, you can choose DOLBY DIGITAL EX, then you can enjoy Dolby Digital Surround EX sound.

Switching the listen mode temporarily to the stereo mode

Press the **STEREO** key to switch the current listen mode temporarily to the Stereo mode. Pressing the key again restores the original listen mode.

- The original listen mode is also restored when the input selector is switched or the receiver is turned OFF then ON again.

Convenient functions

You can make further adjustments to the sound while listening to playback in the surround mode.

- The mode using the **SOUND** key is defeated when the REC MODE is ON. - [26]

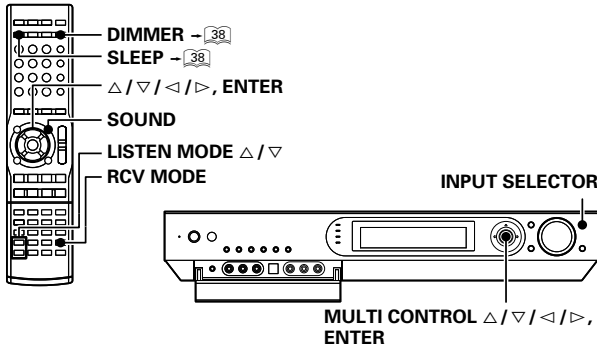

Adjusting the sound

- 1 Press the **RCV MODE** key on the remote control unit to set it to the receiver control mode.
- 2 Press the **SOUND** key.
- 3 Press the **MULTI CONTROL** </> (or the </> keys) to select the setting item and press the **ENTER**.

Note that some items are not displayed in certain modes.

- 1 **"SP LEVEL":** *1
Adjusting the volume level of each channel - [22]
- 2 **"INPUT":** (Analog mode only)
Input level adjustment - [24]
- 3 **"TONE":** *2
Tone level adjustment - [37]
- 4 **"EFFECT":** (DSP mode only)
DSP effect level adjustment - [37]
- 5 **"DUAL MONO":** *3
Selection between Stereo, Main audio, Sub audio and Main + Sub audio - [38]
- 6 **"MIDNIGHT":** *4
Midnight mode adjustment - [38]
- 7 **"PANORAMA":** *5
Panorama mode ON/OFF - [37]
- 8 **"DIMENSION":** *5
Dimension adjustment - [37]
- 9 **"C WIDTH":** *5
Center width adjustment - [37]
- 10 **"C IMAGE":** *6
Center image mode adjustment - [38]

*1 The setting in the SOUND mode is temporary. It returns automatically to the original level set in "Speaker settings" when the receiver is turned OFF/ON. - [18]

*2 PCM stereo and analog stereo mode only.

*3 DOLBY DIGITAL mode only

*4 DOLBY DIGITAL, DTS mode only

*5 Only when the input signal is a 2-channel signal in the DOLBY PRO LOGIC IIx MUSIC or DOLBY PRO LOGIC II MUSIC mode.

*6 Only when the input signal is a 2-channel signal in the DTS NEO:6 MUSIC mode.

- 4 Use the **MULTI CONTROL** Δ / ∇ (or the Δ / ∇ keys) to adjust the setting as desired.

• The adjustment item is displayed for approximately 20 seconds.

- 5 Press the **SOUND** key again to return to the input indication.

Adjusting the volume level of each channel

The volume levels of the center speaker, subwoofer, surround speaker and surround back speaker channels can be adjusted during playback.

- 1 Press the **RCV MODE** key on the remote control unit to set it to the receiver control mode.
- 2 Press the **SOUND** key.
- 3 Use the **MULTI CONTROL** </> (or the </> keys) to select "SP LEVEL" on setup displays, and press the **ENTER**.
- 4 Use the **MULTI CONTROL** </> (or the </> keys) to select the speaker.
 - 1 Subwoofer level adjustment ("SW" indicator blinks)
 - 2 Center speaker level adjustment ("C" indicator blinks)
 - 3 Surround speaker level adjustment ("LS", "RS" indicator blinks)
 - 4 Surround back speaker level adjustment ("LB", "RB" or "BS" indicator blinks)
- 5 Use the **MULTI CONTROL** Δ / ∇ (or the Δ / ∇ keys) to adjust the speaker volume level.

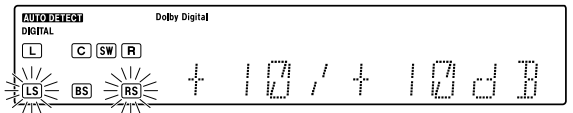

• The level of each speaker channel can be adjusted in 1 dB steps between -10 dB and +10 dB.

- 6 Repeat steps 4 and 5 as required.
- 7 Press the **SOUND** key again to return to the input indication.

• The setting in the SOUND mode is temporary. It returns automatically to the original level set in "Speaker settings" when the receiver is turned OFF/ON. - [18]

Adjusting the DSP effect level (DSP mode only)

The DSP effect level can be adjusted when the listen mode is a DSP surround mode "ARENA", "JAZZ CLUB", "THEATER", "STADIUM" or "DISCO".

- 1 Press the **RCV MODE** key on the remote control unit to set it to the receiver control mode.
- 2 Press the **SOUND** key.
- 3 Use the **MULTI CONTROL** </> (or the </> keys) to select "EFFECT" on setup displays, and press the **ENTER**.
- 4 Use the **MULTI CONTROL** Δ / ∇ (or the Δ / ∇ keys) to adjust the EFFECT LEVEL.

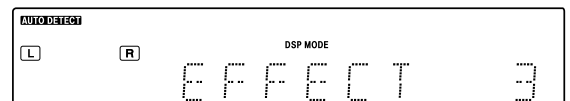

• The DSP effect level can be adjusted in the range between 1 and 5.

- 5 Press the **SOUND** key again to return to the input indication.

Switching between main audio and sub audio

(DOLBY DIGITAL mode only)

When listening to audio multiplex broadcasting such as two-language satellite digital broadcasting, the main and sub audio can be switched over.

- ➊ Press the RCV MODE key on the remote control unit to set it to the receiver control mode.
- ➋ Press the SOUND key while the "DUAL MONO" indicator is lit.
- ➌ Use the MULTI CONTROL </> (or the </> keys) to select "DUAL MONO" on setup displays, and press the ENTER.
- ➍ Use the MULTI CONTROL Δ / ∇ (or the Δ / ∇ keys) to select the audio.

- ➎ ➀ "MAIN": The main audio is output.
- ➎ ➁ "SUB": The sub audio is output.
- ➎ ➂ "MAIN + SUB": The mixture of main audio and sub audio is output.
- ➎ ➃ "STEREO": The left channel outputs the main audio and the right channel outputs the sub audio.

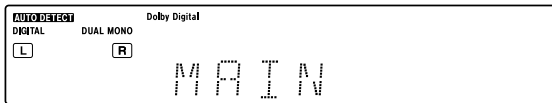

- ➎ Press the SOUND key again to return to the input indication.
 - If the audio multiplex broadcasting is not monaural, the audio cannot be switched on this receiver. In this case, use the audio switching function on the tuner.

Panorama mode

(Only when the input signal is a 2-channel signal in the DOLBY PRO LOGIC IIx MUSIC or DOLBY PRO LOGIC II MUSIC mode)

When listening to music, you will be able to enjoy the "wraparound" sound effect when you adjust the panorama mode.

- ➊ Press the RCV MODE key on the remote control unit to set it to the receiver control mode.
- ➋ Press the SOUND key.
- ➌ Use the MULTI CONTROL </> (or the </> keys) to select "PANORAMA" on setup displays, and press the ENTER.
- ➍ Use the MULTI CONTROL Δ / ∇ (or the Δ / ∇ keys) to select PANORAMA mode "ON" or "OFF".

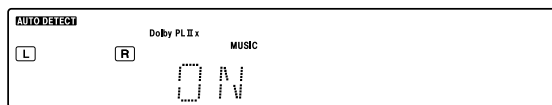

- ➎ Press the SOUND key again to return to the input indication.

Dimension mode

(Only when the input signal is a 2-channel signal in the DOLBY PRO LOGIC IIx MUSIC or DOLBY PRO LOGIC II MUSIC mode)

When listening to music with certain recordings, you will also be able to achieve a suitable balance from all the speakers by adjusting the dimension mode.

- ➊ Press the RCV MODE key on the remote control unit to set it to the receiver control mode.
- ➋ Press the SOUND key.
- ➌ Use the MULTI CONTROL </> (or the </> keys) to select "DIMENSION" on setup displays, and press the ENTER.

- ➍ Use the MULTI CONTROL Δ / ∇ (or the Δ / ∇ keys) to adjust the soundfield towards the rear or the front. Soundfield is adjusted towards the front.



Standard setting.

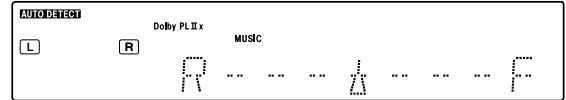

Soundfield is adjusted towards the rear.

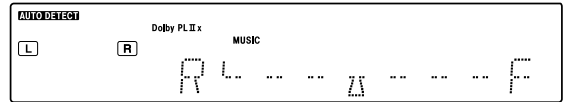

- ➎ Press the SOUND key again to return to the input indication.

Center Width mode

(Only when the input signal is a 2-channel signal in the DOLBY PRO LOGIC IIx MUSIC or DOLBY PRO LOGIC II MUSIC mode)

Center width adjustment allows you to enjoy an enhanced sound when listening to music through center image from only center speaker, or left and right speakers or various combinations adjustments.

- ➊ Press the RCV MODE key on the remote control unit to set it to the receiver control mode.
- ➋ Press the SOUND key.
- ➌ Use the MULTI CONTROL </> (or the </> keys) to select "CWIDTH" on setup displays, and press the ENTER.
 - When the center speaker is switched OFF, "CWIDTH" cannot be selected.
- ➍ Use the MULTI CONTROL Δ / ∇ (or the Δ / ∇ keys) to adjust the left-center-right output.

Center image will be heard from center speaker only.

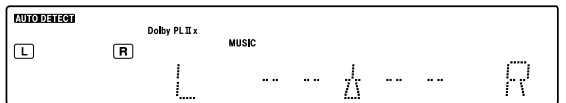

Center image will be heard from left and right speakers only.

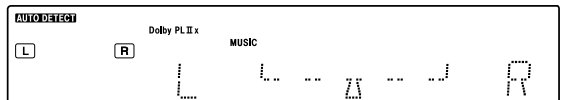

- When in other position, center image from center speaker, left and right speakers can be heard simultaneously with various combinations.

- ➎ Press the SOUND key again to return to the input indication.

Center Image mode (Only when the input signal is a 2-channel signal in the DTS NEO:6 MUSIC mode.)

In the CENTER IMAGE setting mode of the NEO:6 MUSIC listen mode, it is possible to enhance the center channel audio by adjusting the center signal component.

- ❶ Press the **RCV MODE** key on the remote control unit to set it to the receiver control mode.
- ❷ Press the **SOUND** key.
- ❸ Use the **MULTI CONTROL** </> (or the </> keys) to select "C IMAGE" on setup displays, and press the **ENTER**.
 - When the center speaker is switched OFF, "C IMAGE" cannot be selected.
- ❹ Use the **MULTI CONTROL** Δ / ▽ (or the Δ / ▽ keys) to adjust the left-center-right output.

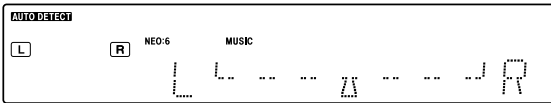

- Adjust the center component level.

- ❺ Press the **SOUND** key again to return to the input indication.

Midnight mode (DOLBY DIGITAL and DTS mode only)

When watching movies at night, you might not be able to raise the volume as loud as normal. Midnight mode compresses the dynamic range of previously specified parts of the DOLBY DIGITAL or DTS sound track (like scenes with sudden increases in volume) to minimize the difference in volume between the specified and non-specified parts. This makes it easy to hear all of the sound track, even when listening at low volumes.

- ❶ Press the **RCV MODE** key on the remote control unit to set it to the receiver control mode.
- ❷ Press the **SOUND** key.
- ❸ Use the **MULTI CONTROL** </> (or the </> keys) to select "MIDNIGHT" on setup displays, and press the **ENTER**.
 - This can be selected only if **DVD**, **VIDEO 1**, **VIDEO 2**, **AUX** or **GAME** is selected as the source and the listen mode is set to "DOLBY DIGITAL" or "DTS".
- ❹ Use the **MULTI CONTROL** Δ / ▽ (or the Δ / ▽ keys) to select the "MIDNIGHT2", "MIDNIGHT1" or "OFF" setting.

- ❶ "MIDNIGHT2": Large effect
Suitable for late-night use.

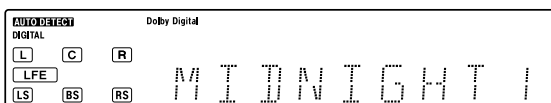
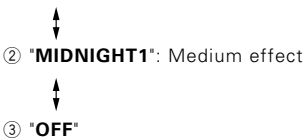

- The adjustment item is displayed for approximately 20 seconds.
- Some DOLBY DIGITAL or DTS software may not be compatible with the Midnight mode.

- ❺ Press the **SOUND** key again to return to the input indication.

Display dimmer adjustment

The dimmer function lets you select the brightness of the receiver's display. You might find this useful if you darken your room to watch movies or listen to music.

Each time you press the DIMMER key, the display's brightness changes among the three available settings.

Select the brightness level you find most pleasing.

- ❶ Bright
- ❷ Dark
- ❸ Dark (LEDs on the receiver are also OFF.)

Sleep timer

The sleep timer function turns the receiver OFF (to the standby mode) automatically when the set timer period has elapsed. The sleep timer period can be set in 10-minute steps up to 90 minutes.

Press the SLEEP key repeatedly until the desired period before turning the receiver OFF (standby mode) is displayed.

- Each press increments the sleep timer period by 10 minutes.
- 10 → 20 → 3070 → 80 → 90 → Cancel → 10 → 20 → ...**

The sleep timer indicator lights up



- Pressing the **SLEEP** key after the sleep timer has started allows you to check the remaining time period.
- To cancel the sleep timer, turn the receiver OFF (standby mode) or press the **SLEEP** key repeatedly until the Sleep timer indicator disappears.

Basic remote control operations for other components

The remote control supplied with this receiver is also capable of controlling components from a variety of manufacturers once you register the appropriate setup codes into the remote control unit.

Low battery warning

Replace all two batteries with new ones when you notice a shortening of the distance from which the remote control will operate. The remote control is designed to retain setup codes in memory while you change batteries.

Registering setup codes for other components

When the setup code defined for remote control of every system component is registered in one of the input selector keys of the remote control unit, you can control that component simply after selecting it using the corresponding input selector key of the remote control unit.

- When recording audio on a VCR or MD recorder, for example, you can also control the system component by switching only the remote control unit, without switching the input source of the receiver.

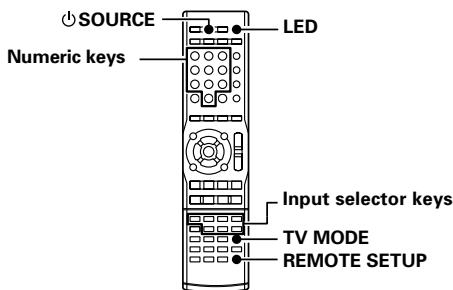

1 Find the setup code of the component to be registered.

Refer to the setup code lists to find the setup code for the component to be registered. → [41] - [44]

Example: To register a DVD made by KENWOOD, you would enter "0490" or "0534".

2 Press the input selector key (DVD, VIDEO 1, VIDEO 2, AUX, F.AUX, GAME or TV MODE) you want to register a system component.

The following table shows the type of components that can be registered in each input selector key.

| Input selector key | Registerable component | Input jacks where the component is connected |
|--------------------|---|--|
| DVD | DVD player | DVD |
| VIDEO 1 | VCR | VIDEO1 |
| VIDEO 2 | Cable Converters Satellite Receivers | VIDEO2 |
| AUX | CD player, MD recorder (KENWOOD) | AUX |
| F. AUX | Game player (Default: Xbox), DVD player | FRONT AUX |
| GAME | Game player (Default: Play Station2), DVD player | GAME |
| TV MODE | TV (including TVs incorporating VCR) | — |

- Make sure that a source belonging to the registerable component is connected to the corresponding input jacks on the receiver.
- A second DVD recorder, CD player or VCR can also be connected by changing the assignment of the registerable component devices. See "Re-assigning device keys" on page 40.

3 Press and hold the REMOTE SETUP key until the LED blinks twice, then release the REMOTE SETUP key.

- Proceed to the next steps in less than 10 seconds after the LED blinks twice.

4 Press the numeric key to enter the four-digit code for the component to be registered.

- The LED blinks twice when registration is completed successfully.

5 Ensure that the registered component functions properly.

To ensure the proper function, perform the following operation and check if the component functions as intended.

Point the remote control unit to the component and press the **SOURCE** key (or the **TV** key if the component is a TV) once. If the setup code is registered properly, the component should be turned ON or OFF. If the component is a VCR, turn the VCR ON and load a video tape and perform an operation such as playback. The VCR should function as controlled if its setup code is registered properly.

If the component does not function properly:

If more than one setup code is listed for the component, try registering another setup code by performing steps 3 to 5.

- Repeat steps 1 to 5 above to register the setup code of another component.
- To change the registered setup code, register a new setup code again by performing steps 1 to 5 above.

Note

Although each setup code is designed to work with a number of different models, certain codes may not work with some models. (Also, certain codes may only operate some of the functions available on a given model.)

Searching for your code

If your component does not respond after trying all the codes listed for your component, or if your component is not listed at all, try searching for your code.

For example, to search for a code for your TV.

1 Press the TV MODE key once.

When searching for the setup code of a component other than TV:

Press the desired input selector key instead of the **TV MODE** key.

2 Press and hold the REMOTE SETUP key until the LED blinks twice, then release the REMOTE SETUP key.

- Proceed to the next steps in less than 10 seconds after the LED blinks twice.

3 Press the numeric key to enter "9 9 1".

- The LED will blink twice.

4 Point the remote control at the TV and slowly alternate between pressing the TV and TV MODE keys. Stop when the TV turns on or off.

- In the search mode, the remote control will send IR codes from its library to the selected device, starting with the most popular code first.

When searching for the setup code of a component other than TV:

To search for the setup code of a DVD, CD, MD or VCR, press the input selector key pressed in 1 and the **SOURCE** key alternately and check if the component to be registered is turned ON and OFF. To search for the setup code of a VCR, turn the VCR ON, load a tape and press the input selector key pressed in step 1 (i.e. VIDEO1) and an operation key such as the play key alternately and check if the VCR is controlled as intended.

5 Press the REMOTE SETUP key once to lock in the code.

Checking the codes

The 4-digit setup codes registered in the input selector keys can be checked as follows.

- 1 Press the input selector key in which the setup code of the desired component is registered.**
- 2 Press and hold the REMOTE SETUP key until the LED blinks twice, then release the REMOTE SETUP key.**
 - Proceed to the next steps in less than 10 seconds after the LED blinks twice.
- 3 Press the numeric key to enter "9 9 0".**
 - The LED will blink twice.
- 4 Press the numeric key "1" once.**

The LED blinks for the same number of times as the numeral in the first digit of the 4-digit code. When the registered setup code is "1338", for example, the LED will blink once. If a code digit is "0", the LED will not blink.
- 5 Repeat step 4 three more times for the remaining digit. Use "2" for the second digit, "3" for the third digit, and "4" for the fourth digit.**

Re-assigning device keys

The type of component device that can be registered is assigned in advance in each input selector key, but this assignment can be changed as desired by the user.

For example, the initial status is set so that a VCR can be registered in the input selector **VIDEO 1** key. If you want to register the setup code of a DVD player in the **VIDEO 1** key just like in the **DVD** key, reassign the key (change the registerable component type assignment for the input selector key) as described below.

- 1 Press and hold the REMOTE SETUP key until the LED blinks twice, then release the REMOTE SETUP key.**
 - Proceed to the next steps in less than 10 seconds after the LED blinks twice.
- 2 Press the numeric key to enter "9 9 2".**
 - The LED will blink twice.
- 3 Press the DVD key once, then press the VIDEO 1 key once.**

The LED blinks twice, and it is possible to register the setup code of a DVD player in the **VIDEO 1** key just like in the **DVD** key. Now register the setup code according to the model of the DVD player. The combination of components assignable to the input selector keys can be changed by pressing different keys in step 4. For example, to change the key assignment so that the same component as that registered in input selector "B" key can be registered in input selector "A" key, press the "B" key then the "A" key after entering "9 9 2" with the numeric keys.

 - For the originally assigned relationship between the input selector keys and system component types, see the table on the previous page.
 - To restore the original component type assignment of an input selector key, press that input selector key twice after entering "9 9 2".
 - It is not possible to register a component in the **TUNER** key.

Examples of key re-assignment and the order of pressing the keys:

Registration of a DVD player in the **VIDEO 1** key

To change the **VIDEO 1** key to the **DVD** key:

'9 9 2' → 'DVD' → 'VIDEO 1'

Restoration of the original key assignment

To return the **VIDEO 1** key to the **VIDEO 1** key:

'9 9 2' → 'VIDEO 1' → 'VIDEO 1'

Registration of a VCR in the **VIDEO 2** key

To change the **VIDEO 2** key to the **VIDEO 1** key:

'9 9 2' → 'VIDEO 1' → 'VIDEO 2'

Restoration of the original key assignment

To return the **VIDEO 2** key to the **VIDEO 2** key:

'9 9 2' → 'VIDEO 2' → 'VIDEO 2'

Operating other components

This operation lets you operate the registered components.

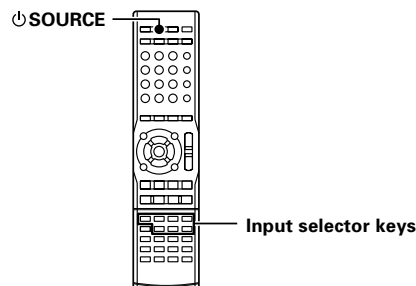

- 1 Use the input selector keys to select the component you desire.**

When the input selector key is pressed, the system component registered in the pressed key becomes ready to be controlled. The input selector of the receiver is also switched accordingly. If you want to control the component registered in the remote's input selector key without switching the receiver's input selector to that source, press and hold the input selector key for more than 3 seconds.

 - To put the remote control unit to the receiver control mode, press the **RCV MODE** key.
- 2 Turn the component ON.**
 - A DVD player, CD player, MD recorder or VCR registered in one of the remote's input selector keys can be turned ON by pressing the remote's **⏻ SOURCE**.
 - A TV registered in one of the remote's input selector keys can be turned ON by pressing the remote's **⏻ TV** key.
- 3 Press the operation keys you desire.**
 - For the keys that can be used with each system component, see pages 55 to 56.

Clearing all of the settings registered or stored in the remote control unit

You can reset the remote control unit to the initial status after purchase, clearing all of the component registration using setup codes and other data stored using the learning functions.

- 1 Press and hold the REMOTE SETUP key until the LED blinks twice, then release the REMOTE SETUP key.**
 - Proceed to the next steps in less than 10 seconds after the LED blinks twice.
- 2 Press the numeric key to enter "9 8 1".**
 - The LED blinks four times, and all of the data you registered or stored in the remote control unit is cleared.

Setup code chart (RC-R0920) (For U.S.A. and Canada)

Even when a component is manufactured by a maker listed in the setup code chart, it may be unable to be registered depending on the model and year of production. Also, when a setup code of a non-KENWOOD maker is registered, certain component models may be unable to be controlled or only the limited functions may be controllable. In this case, it is recommended to use the remote control unit provided with the system component. For how to register the setup codes, read "Registering setup codes for other components" carefully. -[39]

Cable Converters

| Manufacturer | Setup Codes |
|--------------------|------------------------|
| ABC | 0003, 0008 |
| Americast | 0899 |
| Bell South | 0899 |
| Clearmaster | 0883 |
| ClearMax | 0883 |
| Coolmax | 0883 |
| Director | 0476 |
| General Instrument | 0476, 0276, 0003 |
| GoldStar | 0144 |
| Hamlin | 0009, 0273 |
| Jerrold | 0476, 0276, 0003 |
| Memorex | 0000 |
| Motorola | 0476, 0276, 1376 |
| Multitech | 0883 |
| Pace | 1877, 0237 |
| Panasonic | 0000, 0107 |
| Paragon | 0000 |
| Philips | 0317, 1305 |
| Pioneer | 1877, 0877, 0144, 0533 |
| Pulsar | 0000 |
| Quasar | 0000 |
| RadioShack | 0883 |
| Regal | 0279, 0273 |
| Runco | 0000 |
| Samsung | 0144 |
| Scientific Atlanta | 1877, 0877, 0477, 0008 |
| Sony | 1006 |
| Starcom | 0003 |
| Supercable | 0276 |
| Supermax | 0883 |
| Torx | 0003 |
| Toshiba | 0000 |
| Tristar | 0883 |
| V2 | 0883 |
| Viewmaster | 0883 |
| Vision | 0883 |
| Vortex View | 0883 |
| Zenith | 0000, 0525, 0899 |

CD player

| Manufacturer | Setup Codes |
|--------------|--|
| Kenwood | 0681, 0826, 0028, 0037, 0677, 0858, 0190, 0523, 1490, 0340, 0859, 0339, 1338 |
| Optimus | 0037 |
| Sharp | 0037 |

MD recorder

| Manufacturer | Setup Codes |
|--------------|------------------|
| Kenwood | 0681, 0826, 1339 |

Audio Amp/Tuners

| Manufacturer | Setup Codes |
|----------------------------------|-------------|
| Kenwood (Sirius Satellite Radio) | 2000 |

Video Accessories

| Manufacturer | Setup Codes |
|------------------------|-------------|
| Macro Image Technology | 1383 |
| Motorola | 1363 |
| MyHD | 1383 |
| Panasonic | 1120 |
| Pioneer | 1010 |
| Samsung | 1490 |
| Sensory Science | 1126 |
| Sharp | 1010 |
| Viewsonic | 1329 |

Satellite Receivers

| Manufacturer | Setup Codes |
|------------------------|--|
| AlphaStar | 0772 |
| Chaparral | 0216 |
| Crossdigital | 1109 |
| DirecTV | 0392, 0566, 0639, 1639, 1142, 0247, 0749, 1749, 0724, 0819, 1856, 1076, 1109, 0099, 1442, 1108, 1414, 1640 |
| Dish Network System | 1005, 0775, 1775 |
| Dishpro | 1005, 0775, 1775 |
| EchoStar | 1005, 0775, 1775 |
| Expressvu | 0775, 1775 |
| GE | 0566 |
| General Instrument | 0869 |
| GOI | 0775, 1775 |
| Hisense | 1535 |
| Hitachi | 0819, 1250 |
| HTS | 0775, 1775 |
| Hughes Network Systems | 1142, 0749, 1749, 1442 |
| I-Lo | 1535 |
| JVC | 0775, 1775 |
| LG | 1414 |
| Magnavox | 0724, 0722 |
| Memorex | 0724 |
| Mitsubishi | 0749 |
| Motorola | 0869 |
| Next Level | 0869 |
| Panasonic | 0247, 0701 |
| Paysat | 0724 |
| Philips | 1142, 0749, 1749, 0724, 1076, 0722, 0099, 1442 |
| Proscan | 0392, 0566 |
| Proton | 1535 |
| RadioShack | 0869 |
| RCA | 0392, 0566, 0855, 0143 |
| Samsung | 1276, 1109, 1108 |
| SKY | 0856 |
| Sony | 0639, 1639, 1640 |
| Star Choice | 0869 |
| Tivo | 1142, 1442 |
| Toshiba | 0749, 1749, 0790, 1285 |
| UltimateTV | 1640 |
| Uniden | 0724, 0722 |
| US Digital | 1535 |
| USDTV | 1535 |
| Voom | 0869 |
| Zenith | 1856, 0856 |

TV

| Manufacturer | Setup Codes |
|----------------------|--|
| Admiral | 0093, 0463 |
| Advent | 0761, 1933 |
| Aiko | 0092 |
| Akai | 0812, 0702, 0030, 0672 |
| Albatron | 0700, 0843 |
| America Action | 0180 |
| Anam | 0180 |
| AOC | 0030 |
| Apex Digital | 0748, 0765, 1943 |
| Audiovox | 0451, 0180, 0092, 0623 |
| Bell & Howell | 0154 |
| BenQ | 1032 |
| Bradford | 0180 |
| Broksonic | 0236, 0463, 1935 |
| Candle | 0030 |
| Carnivale | 0030 |
| Carver | 0054 |
| Celebrity | 0000 |
| Celera | 0765 |
| Changhong | 0765 |
| Citizen | 0060, 0030, 0092 |
| Clarion | 0180 |
| Commercial Solutions | 1447, 0047 |
| Contec | 0180 |
| Craig | 0180 |
| Crosley | 0054 |
| Crown | 0180 |
| Curtis Mathes | 0047, 0054, 0154, 0451, 0093, 0060, 0702, 0030, 0145, 0166 |
| CXC | 0180 |
| Daewoo | 0451, 1661, 0092, 0661, 0623, 0672 |
| Dell | 1080 |
| Denon | 0145 |
| Dumont | 0017 |
| Durabrand | 0463, 0180, 0178, 0171, 1034 |
| Electroband | 0000 |
| Emerson | 0154, 0236, 0463, 0180, 0178, 0171, 1963, 0623 |
| Envision | 0030 |
| ESA | 0812, 0171 |
| Fisher | 0154 |
| Fujitsu | 0853, 0683 |
| Funai | 0180, 0171 |
| Futuretech | 0180 |
| Gateway | 1755, 1756 |
| GE | 1447, 0047, 0051, 0451, 0178 |
| Gibraltar | 0017, 0030 |
| GoldStar | 0030, 0178 |
| Grunpy | 0180 |
| Haier | 1034 |
| Hallmark | 0178 |
| Harman/Kardon | 0054 |
| Harvard | 0180 |
| Havermy | 0093 |
| Helios | 0865 |

TV (Continued)

| Manufacturer | Setup Codes |
|--------------|--|
| Hello Kitty | 0451 |
| Hisense | 0748 |
| Hitachi | 1145, 0145 |
| Infinity | 0054 |
| Inteq | 0017 |
| JBL | 0054 |
| JCB | 0000 |
| Jensen | 0761, 1933 |
| JVC | 0053, 1253, 1923, 0731 |
| KEC | 0180 |
| Kenwood | 0030 |
| KLH | 0765 |
| KTV | 0180, 0030 |
| LG | 0178, 0856, 0700, 1934 |
| LXI | 0047, 0054, 0154, 0156, 0178 |
| Magnavox | 1454, 0054, 0030, 0706 |
| Marantz | 0054, 0030, 0704 |
| Matsushita | 0250 |
| Maxent | 1755 |
| Megapower | 0700 |
| Megatron | 0178, 0145 |
| Memorex | 0154, 0463, 0150, 0178 |
| MGA | 0150, 0030, 0178 |
| Midland | 0047, 0017, 0051 |
| Mitsubishi | 0093, 1250, 0150, 0178 |
| Monivision | 0843, 0700 |
| Motorola | 0093 |
| MTC | 0060, 0030 |
| Multitech | 0180 |
| NAD | 0156, 0178 |
| NEC | 0030, 1704 |
| Nikko | 0030, 0178, 0092 |
| Norcent | 0748, 0824 |
| NTC | 0092 |
| Onwa | 0180 |
| Optimus | 0154, 0250, 0166 |
| Optoma | 0887 |
| Optonica | 0093 |
| Orion | 0236, 0463 |
| Panasonic | 0250, 0051, 1947, 1946, 1941 |
| Penney | 0047, 0156, 0051, 0060, 0030, 0178 |
| Philco | 0054, 0030 |
| Philips | 1454, 0054, 0690, 1961 |
| Pilot | 0030 |
| Pioneer | 0166, 0679 |
| Portland | 0092 |
| Prima | 0761, 1933 |
| Princeton | 0700 |
| Prism | 0051 |
| Proscan | 1447, 0047 |
| Proton | 0178 |
| Pulsar | 0017 |
| Quasar | 0250, 0051 |
| RadioShack | 0047, 0154, 0180, 0030, 0178 |
| RCA | 1447, 0047, 1953, 0679, 1948, 0090, 1547 |
| Realistic | 0154, 0180, 0030, 0178 |
| Runco | 0017, 0030 |
| Sampo | 0030, 1755 |
| Samsung | 0060, 0812, 0702, 0030, 0178, 1959, 1060 |
| Sansui | 0463, 1935 |

TV (Continued)

| Manufacturer | Setup Codes |
|--------------------|--|
| Sanyo | 0154 |
| Scotch | 0178 |
| Scott | 0236, 0180, 0178 |
| Sears | 0047, 0054, 0154, 0156, 0178, 0171 |
| Sharp | 0093 |
| Sheng Chia | 0093 |
| Sony | 0000, 1925 |
| Soundesign | 0180, 0178 |
| Squareview | 0171 |
| SSS | 0180 |
| Starlite | 0180 |
| Studio Experience | 0843 |
| Supreme | 0000 |
| SVA | 0748, 0865 |
| Sylvania | 0054, 0030, 0171, 1963 |
| Symphonic | 0180, 0171 |
| Tandy | 0093 |
| Tatung | 1756 |
| Technics | 0250, 0051 |
| Techwood | 0051 |
| Teknika | 0054, 0180, 0150, 0060, 0092 |
| Telefunken | 0702 |
| TMK | 0178 |
| TNCi | 0017 |
| Toshiba | 0154, 1256, 0156, 0060, 1935, 1704, 1945, 1356, 1936 |
| TVS | 0463 |
| V Inc. | 1756, 0885 |
| Vector Research | 0030 |
| Victor | 0053 |
| Vidikron | 0054 |
| Vidtech | 0178 |
| Viewsonic | 1755, 0885 |
| Wards | 0054, 0030, 0178 |
| Waycon | 0156 |
| Westinghouse | 0889 |
| White Westinghouse | 0463, 0623 |
| Yamaha | 0030 |
| Zenith | 0017, 0463, 0178, 0092 |

HDTV

| Manufacturer | Setup Codes |
|--------------|-------------|
| Mitsubishi | 0150 |
| Panasonic | 0250 |
| Pioneer | 0679 |
| RCA | 1447 |
| Samsung | 0812, 0702 |
| Toshiba | 1256 |

TV/VCR Combination

| Manufacturer | Setup Codes |
|----------------|-------------|
| America Action | 0180 |
| Audiovox | 0180 |
| Emerson | 0236 |
| JVC | 1923 |
| LG | 1934 |
| Samsung | 1959 |
| Sony | 1925 |
| Toshiba | 1936 |

TV/DVD Combination

| Manufacturer | Setup Codes |
|--------------|-------------|
| Advent | 1933 |
| Apex Digital | 1943 |
| Broksonic | 1935 |
| Emerson | 1963 |
| Jensen | 1933 |
| Panasonic | 1941 |
| Philips | 1961 |
| Prima | 1933 |
| RCA | 1948 |
| Sansui | 1935 |
| Sylvania | 0171, 1963 |
| Toshiba | 1935 |

VCR

| Manufacturer | Setup Codes |
|------------------------|------------------------------------|
| ABS | 1972 |
| Admiral | 0048, 0209 |
| Adventura | 0000 |
| Aiwa | 0037, 0000 |
| Alienware | 1972 |
| American High | 0035 |
| Asha | 0240 |
| Audiovox | 0037 |
| Beaumarck | 0240 |
| Bell & Howell | 0104 |
| Broksonic | 0184, 0121, 0209 |
| Calix | 0037 |
| Canon | 0035 |
| Carver | 0081 |
| Citizen | 0037 |
| Craig | 0037, 0047, 0240 |
| Curtis Mathes | 0060, 0035, 0162 |
| Cybernex | 0240 |
| CyberPower | 1972 |
| Daewoo | 0045 |
| Dell | 1972 |
| Denon | 0042 |
| DirectTV | 0739 |
| Durabrand | 0039 |
| Dynatech | 0000 |
| Electrohome | 0037 |
| Electroponic | 0037 |
| Emerex | 0032 |
| Emerson | 0037, 0184, 0000, 0121, 0043, 0209 |
| Fisher | 0047, 0104 |
| Fuji | 0035, 0033 |
| Funai | 0000 |
| Garrard | 0000 |
| Gateway | 1972 |
| GE | 0060, 0035, 0240 |
| GoldStar | 0037 |
| Gradiente | 0000 |
| Harley Davidson | 0000 |
| Harman/Kardon | 0081 |
| Hewlett Packard | 1972 |
| HI-Q | 0047 |
| Hitachi | 0000, 0042 |
| Howard Computers | 1972 |
| HP | 1972 |
| Hughes Network Systems | 0042, 0739 |
| iBUYPOWER | 1972 |
| JVC | 0067 |
| KEC | 0037 |

VCR (Continued)

| Manufacturer | Setup Codes |
|-----------------|--|
| Kenwood | 0067 |
| Kodak | 0035, 0037 |
| Lloyd's | 0000 |
| LXI | 0037 |
| Magnavox | 0035, 0039, 0081, 0000 |
| Magnin | 0240 |
| Marantz | 0035, 0081 |
| Marta | 0037 |
| Matsushita | 0035, 0162 |
| Media Center PC | 1972 |
| MEI | 0035 |
| Memorex | 0035, 0162, 0037, 0048, 0039, 0047, 0240, 0000, 0104, 0209 |
| MGA | 0240, 0043 |
| MGN Technology | 0240 |
| Microsoft | 1972 |
| Mind | 1972 |
| Minolta | 0042 |
| Mitsubishi | 0067, 0043 |
| Motorola | 0035, 0048 |
| MTC | 0240, 0000 |
| Multitech | 0000 |
| NEC | 0104, 0067 |
| Nikko | 0037 |
| Noblex | 0240 |
| Northgate | 1972 |
| Olympus | 0035 |
| Optimus | 1062, 0162, 0037, 0048, 0104 |
| Orion | 0184, 0209 |
| Panasonic | 1062, 0035, 0162, 0616, 0225 |
| Penney | 0035, 0037, 0240, 0042 |
| Pentax | 0042 |
| Philco | 0035 |
| Philips | 0035, 0081, 0618, 0739 |
| Pilot | 0037 |
| Pioneer | 0067 |
| Polk Audio | 0081 |
| Profitronic | 0240 |
| Proscan | 0060 |
| Pulsar | 0039 |
| Quasar | 0035, 0162 |
| RadioShack | 0000 |
| Radix | 0037 |
| Randex | 0037 |
| RCA | 0060, 0240, 0042 |
| Realistic | 0035, 0037, 0048, 0047, 0000, 0104 |
| ReplayTV | 0616 |
| Runco | 0039 |
| Samsung | 0240, 0045 |
| Sanky | 0048, 0039 |
| Sansui | 0000, 0067, 0209 |
| Sanyo | 0047, 0240, 0104 |
| Scott | 0184, 0045, 0121, 0043 |
| Sears | 0035, 0037, 0047, 0000, 0042, 0104 |
| Sharp | 0048 |
| Shogun | 0240 |
| Sonic Blue | 0616 |
| Sony | 0035, 0032, 0033, 0000, 0636, 1972 |
| STS | 0042 |
| Sylvania | 0035, 0081, 0000, 0043 |
| Symphonic | 0000 |
| Systemax | 1972 |

VCR (Continued)

| Manufacturer | Setup Codes |
|--------------------|--|
| Tagar Systems | 1972 |
| Teac | 0000 |
| Technics | 0035, 0162 |
| Teknika | 0035, 0037, 0000 |
| Thomas | 0000 |
| Tivo | 0739, 0636, 0618, 1503 |
| TMK | 0240 |
| Toshiba | 0045, 0043, 1972, 1503 |
| Totevision | 0037, 0240 |
| Touch | 1972 |
| Unitech | 0240 |
| Vector | 0045 |
| Video Concepts | 0045 |
| Videomagic | 0037 |
| Videosonic | 0240 |
| Viewsonic | 1972 |
| Villain | 0000 |
| Wards | 0060, 0035, 0048, 0047, 0081, 0240, 0000, 0042 |
| White Westinghouse | 0209 |
| XR-1000 | 0035, 0000 |
| Zenith | 0039, 0033, 0000, 0209 |
| ZT Group | 1972 |

PVR

| Manufacturer | Setup Codes |
|------------------|------------------|
| ABS | 1972 |
| Alienware | 1972 |
| CyberPower | 1972 |
| Dell | 1972 |
| Gateway | 1972 |
| Hewlett Packard | 1972 |
| Howard Computers | 1972 |
| HP | 1972 |
| iBUYPOWER | 1972 |
| Media Center PC | 1972 |
| Microsoft | 1972 |
| Mind | 1972 |
| Northgate | 1972 |
| Panasonic | 0616 |
| Philips | 0739, 0618 |
| ReplayTV | 0616 |
| Sonic Blue | 0616 |
| Sony | 1972, 0636 |
| Systemax | 1972 |
| Tagar Systems | 1972 |
| Tivo | 0618, 0739, 0636 |
| Toshiba | 1972 |
| Touch | 1972 |
| Viewsonic | 1972 |
| ZT Group | 1972 |

DVD player

| Manufacturer | Setup Codes |
|--------------|--|
| Allegro | 0869 |
| Apex Digital | 0672, 0717, 1056, 0796, 1020, 0794, 1004, 1061, 0797 |
| Blaupunkt | 0717 |
| Blue Parade | 0571 |
| Broksonic | 0695 |
| CineVision | 0869 |
| Coby | 1086 |
| CyberHome | 0816 |
| Daewoo | 0784, 0833, 1172, 0869 |
| Denon | 0490 |

DVD player (Continued)

| Manufacturer | Setup Codes |
|---------------------|--|
| DVD2000 | 0521 |
| Emerson | 0591, 0675 |
| Enterprise | 0591 |
| Fisher | 0670 |
| Funai | 0675 |
| Gateway | 1158 |
| GE | 0522, 0717 |
| Go Video | 0744, 1730, 0715, 0833, 1158, 0783, 1099, 0869 |
| Greenhill | 0717 |
| Hitachi | 0573, 0664 |
| Hiteker | 0672 |
| Initial | 0717 |
| InterAct | 0697 |
| JVC | 0558, 0623, 0867 |
| Kenwood | 0490, 0534, 0682, 0737 |
| KLH | 0717, 1020 |
| Koss | 0651 |
| Lasonic | 0798 |
| LG | 0591, 0869 |
| Lite-On | 1158, 1058 |
| Mad Catz | 1108 |
| Magnavox | 0503, 0539, 0675 |
| Marantz | 0539 |
| Memorex | 0695 |
| Microsoft | 0522 |
| Mintek | 0717 |
| Mitsubishi | 1521, 0521 |
| Nesa | 0717 |
| Onkyo | 0503 |
| Oritron | 0651 |
| Panasonic | 0490, 1762 |
| Pelican Accessories | 0731 |
| Philips | 0503, 0539, 0646, 0675, 0885 |
| Pioneer | 0525, 0571 |
| Polaroid | 1086, 1061 |
| Polk Audio | 0539 |
| Proscan | 0522 |
| Qwestar | 0651 |
| RCA | 0522, 0571, 0717, 0822 |
| Rio | 0869 |
| Rotel | 0623 |
| Saitek | 0731 |
| Sampo | 0752 |
| Samsung | 0490, 0573, 0820 |
| Sansui | 0695 |
| Sanyo | 0873, 0695, 0670 |
| Sharp | 0630, 0752 |
| Shinsonic | 0533 |
| Sonic Blue | 1099, 0869 |
| Sony | 0864, 1033, 0772 |
| Sylvania | 0675 |
| Symphonic | 0675 |
| Technics | 0490 |
| Theta Digital | 0571 |
| Thrustmaster | 0498 |
| Toshiba | 0503, 0695, 1154 |
| Urban Concepts | 0503 |
| Yamaha | 0490, 0539, 0545 |
| Zenith | 0503, 0591, 0869, 1135 |

Game Player

| Manufacturer | Setup Codes |
|-------------------|-------------|
| Xbox | 0522 |
| Sony PlayStation2 | 0533 |

Setup code chart (RC-R0920E) (For Europe and Australia)

Even when a component is manufactured by a maker listed in the setup code chart, it may be unable to be registered depending on the model and year of production. Also, when a setup code of a non-KENWOOD maker is registered, certain component models may be unable to be controlled or only the limited functions may be controllable. In this case, it is recommended to use the remote control unit provided with the system component. For how to register the setup codes, read "Registering setup codes for other components" carefully. --(39)

Cable Converters

| Manufacturer | Setup Codes |
|---------------------------------|------------------------------------|
| ABC | 0003 |
| ADB | 1269, 1063 |
| Alcatel | 0896 |
| Amstrad | 1222 |
| Austar | 0276 |
| Birmingham Cable Communications | 0276 |
| British Telecom | 0003 |
| Cable & Wireless | 1068 |
| Cabletime | 0448, 0665 |
| Comcrypt | 0443 |
| Comtec | 0019 |
| Contec | 0019 |
| Cryptovision | 0600 |
| Filmnet | 0443 |
| Foxtel | 1222 |
| France Telecom | 0817, 0896, 0451 |
| Galaxi | 0008 |
| General Instruments | 0276, 0003 |
| Golden Channel | 1063, 1110 |
| HyperVision | 0619 |
| i-CAN | 1063 |
| Jerrold | 0276, 0003 |
| Kabelvision | 0003 |
| Macab | 0817 |
| Melita | 0003 |
| MNET | 0019, 0443 |
| Motorola | 0276, 1106 |
| Mr Zap | 1112 |
| Mr Zapp | 0817 |
| Mr. Zap | 1112 |
| Multichoice | 0019, 0443 |
| Noos | 0817 |
| NTL | 1068, 1060, 0276, 0003, 0277, 0250 |
| Oak | 0019 |
| Ono | 1068 |
| Optus | 1060, 0276 |
| Pace | 1068, 1060 |
| Panasonic | 0000 |
| Paragon | 0000 |
| Philips | 0817, 0619 |
| Pioneer | 0144 |
| Pulsar | 0000 |
| PVP Stereo Visual Matrix | 0003 |
| Runco | 0000 |
| Sagem | 0817, 1112 |
| Salora | 0000 |
| Samsung | 1060 |
| Scientific Atlanta | 1068, 0277, 0008 |
| Starcom | 0003 |
| Supercable | 0276 |
| Tele Danmark | 0619 |
| Tele+1 | 0443 |
| Teledanmark | 0619 |
| Telepiu | 0443 |
| Telewest | 1068 |
| Thomson | 1110 |

Cable Converters (Continued)

| Manufacturer | Setup Codes |
|----------------|-------------|
| Torx | 0003 |
| TransACT | 1106 |
| United Cable | 0003 |
| US Electronics | 0276 |
| Videotron | 0250 |
| Videoway | 0250 |
| Visionetics | 1064 |
| Visiopass | 0817, 0451 |
| Zenith | 0000 |

CD player

| Manufacturer | Setup Codes |
|--------------|--|
| Genexxa | 0037 |
| Kenwood | 0028, 0190, 0037, 0338, 0677, 0858, 0523, 0826, 0339, 0681, 0859, 0340, 1490, 1338 |
| Optimus | 0037 |
| Sharp | 0037 |
| Trio | 0677 |

MD recorder

| Manufacturer | Setup Codes |
|--------------|-------------|
| Kenwood | 0681, 1339 |

Satellite Receivers

| Manufacturer | Setup Codes |
|--------------|--|
| @sat | 1300 |
| @Sky | 1334 |
| ABsat | 0832, 0123 |
| ADB | 0642, 1259 |
| Aegir | 0520 |
| AGS | 0710 |
| Akai | 0200 |
| Alba | 0455 |
| Aldes | 0520 |
| Allsat | 0200, 1043, 1017 |
| Allvision | 1412, 1334 |
| Ampere | 0132 |
| Amstrad | 0847, 1175, 0132, 0243, 1113, 0795, 0882, 0345, 0863 |
| AntSat | 1083, 1017 |
| Apollo | 0455 |
| Arcon | 1205, 1075, 1043 |
| Arion | 1205 |
| Armstrong | 0243 |
| Arnion | 1300 |
| Asat | 0200 |
| ASCI | 1334 |
| AssCom | 0853 |
| AST | 0321 |
| Astacom | 0710 |
| Aston | 1261, 0142 |
| Astra | 0607, 0243 |
| Astro | 0173, 0658, 1113, 0133, 0607, 1100, 0520, 1099 |
| Atsat | 1300 |
| AtSky | 1334 |

Satellite Receivers (Continued)

| Manufacturer | Setup Codes |
|--------------------------|--|
| Aurora | 0879, 0642 |
| Austar | 0879, 0642, 0863, 1259, 0497 |
| Axiel | 0710 |
| Axis | 1111, 0880 |
| Beko | 0455 |
| Bentley Walker | 1017 |
| Bestar | 0243 |
| Black Diamond | 1284 |
| Blaupunkt | 0173 |
| Boca | 0132, 0794, 0243 |
| Boston | 0710 |
| Brand Unknown | 0132, 1334, 0299 |
| British Sky Broadcasting | 0847, 1175 |
| BskyB | 0847, 1175 |
| BT | 1296, 0710 |
| Bush | 1284 |
| Canal Digital | 0853 |
| Canal Satellite | 0853 |
| Canal+ | 0853 |
| CanalSatellite | 0853 |
| Cherokee | 0710, 0123 |
| Chess | 1085, 1334 |
| CityCom | 0607, 0299, 1176, 1075 |
| Claasen Nachrichten | 0520 |
| CNT | 0520 |
| Colombia | 0132 |
| Columbia | 0132 |
| Comag | 0132, 1412 |
| Condor | 0607 |
| Conrad | 0132, 0607 |
| Conrad Electronic | 0607 |
| Crown | 0243 |
| Cryptovision | 0795, 0455 |
| Cyrus | 0200 |
| D-box | 0723, 0873 |
| Daewoo | 1111, 1296 |
| Daumling | 0794 |
| Delfa | 0863 |
| Deltasat | 1075 |
| Dgtec | 1242 |
| Digatron | 1294 |
| Digena | 1100 |
| Digenius | 0299 |
| Digitality | 0607 |
| DigiQuest | 0863 |
| DigitAll World | 1227 |
| Discovery | 0710 |
| Diseqc | 0710 |
| Distratel | 1205 |
| DMT | 1075 |
| DNT | 0200 |
| Dream Multimedia | 1237 |
| DREAM multimedia.TV | 1237 |
| DStv | 0879, 0642 |
| Echostar | 0853, 0167, 0610, 1200, 1086, 1467, 0871, 1323 |

Satellite Receivers (Continued)

| Manufacturer | Setup Codes |
|-------------------|--|
| Einhell | 0132, 0794, 0243 |
| Elekta | 0520 |
| Elta | 0200 |
| Emme Esse | 0871 |
| Engel | 1017 |
| EP Sat | 0455 |
| Eurieult | 0882 |
| Eurocrypt | 0455 |
| Europa | 0863, 0607 |
| European | 0794 |
| Europhon | 0132, 0607, 0299 |
| Eurosat | 0243 |
| Eurosky | 0132, 0299, 0243, 0607 |
| Eurostar | 0880, 0607 |
| Ferguson | 0711, 0455, 1291 |
| Finlandia | 0455 |
| Finlux | 0455 |
| Force | 1101 |
| Force NO AS | 1101 |
| Fortec Star | 1083, 1017 |
| Foxtel | 0879, 0720, 0497, 1176, 0455, 1356 |
| Fracarro | 0871 |
| Freesat | 0882 |
| FTEmaximal | 0863 |
| Fuba | 0173, 0299 |
| Galaxis | 0853, 1111, 1101, 0863 |
| Galaxisat | 0321 |
| Garnet | 1075 |
| Gecco | 1412 |
| GF | 1043 |
| GF Star | 1043 |
| GOD Digital | 0200 |
| Gold Box | 0853 |
| Goldbox | 0853, 0292 |
| Goldvision | 1017 |
| Goodmans | 1284, 0455 |
| Gradiente | 0887 |
| Granada | 0455 |
| Grundig | 0847, 0853, 0173, 0879, 1291, 0805, 1435, 0345, 1330 |
| Hanseatic | 1099, 1100 |
| Hanuri | 0520 |
| Hauppauge | 1294 |
| HDT | 1011 |
| Helium | 0607 |
| Hirschmann | 1111, 0173, 0299, 0882, 0710, 0607, 1085 |
| Hitachi | 0455 |
| HNE | 0132 |
| Hornet | 1300 |
| HSnseal & Gretel | 0132 |
| Humax | 0863, 1225, 1176 |
| Huth | 0132, 0794, 0607, 1075, 0243, 1017 |
| Hyundai | 1075, 1011 |
| ID Digital | 1176 |
| Imex | 0520 |
| Ingelen | 0882 |
| International | 0132, 0243 |
| Interstar | 1017 |
| Intertronic | 0243 |
| Intervision | 0607 |
| InVideo | 0871 |
| IR | 0173, 0455, 0282 |
| Irdeto Technology | 0879 |

Satellite Receivers (Continued)

| Manufacturer | Setup Codes |
|----------------|--|
| Italtel | 0871 |
| ITT Nokia | 0723, 0873, 0455 |
| Jaeger | 1334 |
| JOK | 0710 |
| Kamm | 0880 |
| Kaon | 1300 |
| KaTelco | 1111 |
| Kathrein | 0173, 0200, 0658, 0123, 0249, 1221 |
| Kenwood | 0853 |
| Key West | 0132, 0794, 0243 |
| KeyWest | 0794 |
| Klap | 0710 |
| Konig | 0607 |
| Koscom | 1043 |
| Kreiling | 0249, 0658 |
| Kreiselmeier | 0173 |
| L&S Electronic | 0132, 1334, 1043 |
| Labgear | 1296 |
| LaSAT | 0132, 0520, 0299, 0243, 0607 |
| Lenco | 0607 |
| LG | 1075 |
| Lifesat | 0132, 1043, 0299 |
| Lodos | 1284 |
| Loewe | 0243 |
| Logix | 1075, 1017 |
| Lorenzen | 0132, 0607, 1294, 0299, 0867, 0794 |
| Luxor | 0345 |
| Manata | 0132, 0710 |
| Manhattan | 0455, 1083, 1017, 0520 |
| Marantz | 0200 |
| Mascom | 0520 |
| Maspro | 0173 |
| Matsui | 0173, 1284, 0710 |
| Max | 0607 |
| Maximum | 1075 |
| MDS | 1225 |
| Mediacom | 1206 |
| Mediamarkt | 0243 |
| MediaSat | 0853, 0292 |
| Medion | 0132, 1075, 1043, 1412, 0299, 1334 |
| Mega | 0200 |
| Metronic | 0243, 1215, 1205, 0520, 1334 |
| Metz | 0173 |
| Micro | 1294, 0607 |
| Micromaxx | 0299 |
| Microstar | 1075 |
| Mitsubishi | 0455 |
| Morgan's | 0200, 0132, 0243, 0794 |
| Motorola | 0856 |
| Multichoice | 0879, 0642 |
| Muratto | 0321 |
| Myryad | 0200 |
| NEOTION | 1334 |
| Netgem | 1322 |
| Netsat | 0887 |
| Neuhaus | 0607 |
| Neuling | 0132 |
| Nikko | 0200, 0243 |
| Nokia | 0751, 0853, 0723, 0873, 0455, 1723, 1223, 1312, 1023, 1311, 1310 |
| Nordmende | 0520, 0455 |
| OctalTV | 1294 |

Satellite Receivers (Continued)

| Manufacturer | Setup Codes |
|--------------------|--|
| Okano | 0243 |
| OnDigital | 0751, 0241, 0133 |
| Opentel | 1412 |
| Optex | 1043 |
| Optus | 0879 |
| Orbitech | 1100, 1099 |
| Origo | 0497 |
| OSAT | 0345 |
| Ouralis | 1205 |
| Pace | 0847, 0853, 0200, 0887, 0720, 1175, 0241, 0497, 0455, 1356, 0795, 0867, 0329, 1323 |
| Packard Bell | 1111 |
| Packsat | 0710 |
| Palcom | 0299 |
| Palladium | 0243 |
| Panasat | 0879, 0615 |
| Panasonic | 0847, 0455, 1304 |
| Panda | 0173, 0455, 0607 |
| Pansat | 1011 |
| Patriot | 0132, 0710 |
| Philips | 0853, 0173, 0200, 1114, 0292, 0710, 0455, 0133, 0805 |
| Phonotrend | 1200, 0863, 1017 |
| Pino | 1334 |
| Pioneer | 0853, 0292, 0352, 0329, 1308 |
| Planet | 0871 |
| Preisner | 0132, 1113, 1101, 0794 |
| Premier | 0292 |
| Premiere | 0853, 0873, 0292 |
| Prima | 0795 |
| Primacom | 1111 |
| Pro Visat | 0520 |
| Profile | 0710 |
| Promax | 0455 |
| ProVision | 0520 |
| Quadral | 0710 |
| Quelle | 0607, 0299 |
| Radiola | 0200 |
| Radix | 1113, 0882 |
| RFT | 0200 |
| Roadstar | 0853 |
| Saba | 0607, 0520, 0710 |
| Sabre | 0455 |
| Sagem | 0820, 1114, 1253 |
| Samsung | 0853, 1292, 0863, 1243, 1206, 1293, 1017 |
| SAT | 0321 |
| Sat Control | 1300 |
| Sat Partner | 0520 |
| Satcom | 0607 |
| SatPartner | 0520 |
| Satplus | 1100 |
| Satstation | 1083 |
| Schneider | 0805, 0710, 1206 |
| Schwaiger | 1111, 0132, 0607, 1083, 1075, 1334, 0863 |
| SCS | 0299 |
| Sedea Electronique | 0132, 1206 |
| Seemann | 0243 |
| SEG | 1075, 1087 |
| Seleco | 0871 |
| Septimo | 1205 |
| Serino | 0610 |
| Siemens | 0173 |
| Silva | 0299 |

Satellite Receivers (Continued)

| Manufacturer | Setup Codes |
|----------------|--|
| SKY | 0847, 0856, 0887, 1014, 1175, 0711 |
| Sky Television | 1014 |
| SKY+ | 1175 |
| Skymaster | 1200, 1085, 1075, 0880 |
| Skymax | 0200 |
| Skyplus | 1334, 1412 |
| SkySat | 0607 |
| Skyvision | 1334 |
| SL | 0132, 1294, 0299, 0243 |
| SM Electronic | 1200 |
| Smart | 0132, 1113, 0299, 1101, 0882, 0794 |
| Sony | 0847, 0853, 0292, 0282 |
| SR | 0132 |
| Starlite | 0200 |
| Strong | 0853, 0879, 0132, 0520, 1300 |
| Sunkai | 0123 |
| Sunstar | 0642, 0132, 0794, 0243 |
| Supernova | 0887 |
| Tantec | 0455 |
| Tarbs | 1225 |
| Tatung | 0455 |
| Teac | 1322, 1227, 1225 |
| Tecatel | 1200 |
| TechniSat | 0200, 0863, 1195, 0455, 1100, 1099, 1322 |
| Technowelt | 0132, 0607 |
| Techsan | 1017 |
| Techwood | 1284 |
| Teco | 0243 |
| tekComm | 1017 |
| Telasat | 0607 |
| Teleciel | 1043 |
| Telefunken | 0710 |
| Teleka | 0607, 0243 |
| Telemaster | 0520 |
| Telestar | 1099, 1334, 1100 |
| Teletech | 0880 |
| Televés | 0132, 1300, 0455 |
| Televisa | 0887 |
| Thomson | 0847, 0853, 0820, 0292, 0711, 0607, 1046, 0455, 0710, 1291 |
| Thorn | 0455 |
| Tioko | 0132, 0243 |
| Tokai | 0200 |
| Tonna | 0455 |
| Topfield | 1206 |
| Toshiba | 0455 |
| TPS | 0820, 1253 |
| Triad | 0321 |
| Triax | 0853, 0200, 0132, 1227, 1113, 1296, 1099, 1291 |
| Trio | 1075 |
| UEC | 0879 |
| Unisat | 0200, 0132, 0243 |
| Universum | 0173, 0607, 0299, 1099, 1087 |
| Variosat | 0173 |
| Ventana | 0200 |
| VH-Sat | 0299 |
| Visiosat | 0142, 0710 |
| Viva | 0856 |
| VTech | 0321 |
| Wewa | 0455 |
| Wibo | 0243 |

Satellite Receivers (Continued)

| Manufacturer | Setup Codes |
|--------------|------------------------------|
| Wintel | 0299 |
| Wisi | 0173, 0321, 0299, 0607, 0455 |
| Woorisat | 0520 |
| Worldsat | 1323, 0710, 0123 |
| XCOM | 0123, 0832 |
| Xsat | 0847, 0123, 1323 |
| Xtreme | 1300 |
| Yes | 0887 |
| Zehnder | 1334, 1075, 0520, 1412, 0321 |
| Zenith | 0856 |
| Zwergnase | 0243, 0794 |

TV

| Manufacturer | Setup Codes |
|---------------|--|
| A.R. Systems | 0455, 0374 |
| Accent | 0009 |
| Acec | 0012 |
| Acura | 0009 |
| Admiral | 0264, 0087, 0163, 0093 |
| Agashi | 0264 |
| AGB | 0516 |
| Agef | 0087 |
| Aiko | 0264, 0009 |
| Aim | 0037, 0706, 0455 |
| Aiwa | 1916, 0701 |
| Akai | 0556, 0037, 0548, 0714, 0715, 0606, 0361, 0264, 0218, 0433, 0163, 0480, 0371, 0631, 0072, 0473, 0208, 0696, 0178, 0516, 0602, 0009, 0377, 0648 |
| Akiba | 0037, 0218, 0455, 0282, 0294 |
| Akira | 0418, 0190 |
| Akito | 0037 |
| Akura | 0037, 0714, 0668, 0264, 0218, 0282, 0009, 0412 |
| Alba | 0037, 0714, 0668, 1037, 0487, 0218, 0036, 0009, 0163, 0355, 0443, 0247, 0418, 0371 |
| Allorgan | 0294, 0206 |
| Allstar | 0037 |
| Amplivision | 0370 |
| Amstrad | 0037, 1037, 0264, 0218, 0433, 0412, 0648, 0371, 0516, 0009 |
| Anam | 0009 |
| Anglo | 0264, 0009 |
| Anitech | 0037, 0282, 0009 |
| Ansonic | 0668, 0370, 0104, 0009 |
| Apollo | 0473 |
| Arc En Ciel | 0196, 0109, 0198 |
| Ardem | 0037, 0714 |
| Aristona | 0556, 0037, 0012 |
| Arthur Martin | 0163 |
| ASA | 0104, 0087, 0070 |
| Asberg | 0037 |
| Asora | 0009 |
| Astra | 0037 |
| Asuka | 0264, 0218 |
| ATD | 0698 |
| Atlantic | 0037, 0259, 0206 |
| Atori | 0009 |
| Auchan | 0163 |
| Audiosonic | 0037, 0714, 0486, 0715, 0264, 0370, 0218, 0109, 0337, 0374, 0009 |

TV (Continued)

| Manufacturer | Setup Codes |
|----------------|--|
| Audioton | 0486, 0264, 0370 |
| Autovox | 0206, 0087, 0247 |
| Awa | 0606, 0264, 0036, 0108, 0374, 0011, 0009 |
| Axxent | 0009 |
| Baird | 0208, 0072, 0193, 0190, 0073 |
| Bang & Olufsen | 0565, 0087 |
| Basic Line | 0556, 0037, 0668, 1037, 0218, 0455, 0009, 0282, 0374 |
| Baur | 0037, 0361, 0455, 0512, 0009, 0535 |
| Beaumarck | 0178 |
| Beko | 0037, 0714, 1037, 0486, 0715, 0606, 0370, 0418 |
| Beon | 0037, 0418 |
| Berthen | 0668 |
| Best | 0337 |
| Bestar | 0037, 0370, 0374 |
| Bestar-Daewoo | 0374 |
| Black Diamond | 1037 |
| Black Star | 0247 |
| Blacktron | 0282 |
| Blackway | 0218, 0282 |
| Blaupunkt | 0195, 0036, 0455, 0535, 0200, 0328, 0170, 0327 |
| Blue Sky | 0556, 0037, 0714, 0668, 1037, 0715, 0487, 0218, 0455, 0282 |
| Blue Star | 0282 |
| Bondstec | 0247 |
| Boots | 0009 |
| BPL | 0037, 0282 |
| Brandt | 0625, 0560, 0196, 0109, 0335, 0198 |
| Brinkmann | 0037, 0668, 0486, 0418, 0519 |
| Brionvega | 0087 |
| Bruns | 0087 |
| BSR | 0294, 0163 |
| BTC | 0218 |
| Bush | 0556, 0037, 0714, 0668, 1037, 0698, 0487, 0361, 0264, 0218, 0036, 0661, 0355, 0374, 0294, 0009, 0371, 0208, 0519, 0282 |
| Canton | 0218 |
| Capsonic | 0264 |
| Carad | 0668, 1037, 0610 |
| Carena | 0037, 0455 |
| Carrefour | 0036, 0070 |
| Carver | 0170 |
| Cascade | 0037, 0009 |
| Casio | 0037 |
| Cathay | 0037 |
| CCE | 0037 |
| Centrex | 0780, 0826 |
| Centrum | 1037 |
| Centurion | 0037 |
| Century | 0087, 0247 |
| CGE | 0370, 0084, 0418, 0074, 0247 |
| Cimline | 0218, 0009 |
| Cinex | 0648 |
| City | 0009 |
| Clarivox | 0037, 0070 |
| Clatronic | 0037, 0714, 0264, 0370, 0218, 0579, 0009, 0247, 0371 |
| Clayton | 1037 |

TV (Continued)

| Manufacturer | Setup Codes |
|--------------------|--|
| Concorde | 0009 |
| Condor | 0037, 0264, 0370, 0418, 0247, 0282, 0009 |
| Conrac | 0808 |
| Contec | 0037, 0036, 0009 |
| Continental Edison | 0487, 0198, 0196, 0109 |
| Cosmel | 0037, 0009, 0337 |
| Crosley | 0084, 0074, 0247, 0087 |
| Crown | 0037, 0714, 0486, 0715, 0487, 0606, 0712, 0370, 0412, 0009, 0208, 0418, 0579 |
| CS Electronics | 0218, 0247 |
| CTC | 0247 |
| Cybertron | 0218 |
| D-Vision | 0556, 0037 |
| Daewoo | 0556, 0037, 0634, 1909, 0218, 0499, 0661, 0009, 0374 |
| Dainichi | 0218 |
| Dansai | 0037, 0036, 0009, 0208 |
| Dansette | 0412 |
| Dantax | 0714, 0715 |
| Dawa | 0037, 0009 |
| Dayton | 0009 |
| Daytron | 0037, 0374, 0009 |
| De Graaf | 0548, 0208 |
| Decca | 0037, 0621, 0516, 0072 |
| Deitron | 0374 |
| Denko | 0264 |
| Denver | 0037 |
| DER | 0190, 0193 |
| Desmet | 0037, 0087, 0009 |
| Diamant | 0037 |
| Diamond | 0698, 0706, 0264, 0009, 0371 |
| Digatron | 0037 |
| Digiline | 0668 |
| Digital Life | 0780 |
| Digitor | 0037 |
| Dixi | 0037, 0087, 0009 |
| DL | 0780 |
| Domeos | 0668 |
| DTS | 0009 |
| Dual | 0037, 1137, 0631, 0519, 0259 |
| Dumont | 0087, 0070 |
| Dux | 0037, 0012 |
| Dynatron | 0037, 0012 |
| E-Elite | 0218 |
| Ecco | 0706 |
| Edison-Minerva | 0487 |
| Elbe | 0610, 0516, 0259 |
| Elbe-Sharp | 0516 |
| Elekta | 0264, 0282, 0009 |
| ELG | 0037 |
| Elin | 0037, 0548, 0361, 0009, 0104 |
| Elite | 0218 |
| Elta | 0264, 0009 |
| Emco | 0247 |
| Emerson | 0037, 0714, 1909, 0486, 0361, 0370, 0087, 0282, 0371, 0070, 0247, 0178 |
| Emperor | 0282 |
| Erres | 0037, 0012 |
| ESC | 0037 |
| Etron | 0009, 0163 |

TV (Continued)

| Manufacturer | Setup Codes |
|-----------------|--|
| Eurofeel | 0264 |
| Euroman | 0037, 0264, 0370 |
| Europa | 0037 |
| Europhon | 0516 |
| Expert | 0259, 0206, 0163 |
| Exquisit | 0037, 0247 |
| Fenner | 0009, 0374 |
| Ferguson | 0037, 0625, 0548, 0560, 0335, 0073, 0193, 0190, 0109 |
| Fidelity | 0037, 0361, 0264, 0412, 0193, 0371, 0163, 0512 |
| Finlandia | 0548, 0163, 0072, 0346, 0208 |
| Finlux | 0037, 0714, 0715, 0629, 0087, 0473, 0621, 0072, 0346, 0516, 0070, 0631, 0104, 0480 |
| Firstline | 0556, 0037, 0714, 0668, 1037, 0361, 0072, 0294, 0247, 0374, 0009, 0208 |
| Fisher | 0370, 0036, 0072, 0208, 0104, 0087 |
| Flint | 0037, 0610, 0264, 0218, 0455, 0072 |
| Forgestone | 0193 |
| Formenti | 0037, 0087 |
| Fortress | 0093, 0087 |
| Fraba | 0037, 0370 |
| Friac | 0037, 0610, 0370, 0009, 0499 |
| Frontech | 0264, 0009, 0247, 0163 |
| Fujitsu | 0009, 0259, 0206, 0072 |
| Fujitsu General | 0206, 0009 |
| Funai | 0668, 0264, 0294 |
| Futronic | 0264 |
| Galaxi | 0037 |
| Galaxis | 0037, 0370 |
| GBC | 0218, 0009, 0374 |
| GE | 0625, 0560, 0093, 0282, 0178 |
| GEC | 0037, 0361, 0163, 0072, 0516 |
| Geloso | 0009, 0374 |
| General Technic | 0009 |
| Genesis | 0037, 0009 |
| Genexxa | 0037, 0218, 0163, 0412, 0009 |
| Goldfunk | 0668 |
| GoldStar | 0037, 0714, 0715, 0606, 0361, 0178, 0377, 0163, 0109, 0247 |
| Gooding | 0487 |
| Goodmans | 0556, 0037, 0714, 0560, 0668, 0634, 1909, 1037, 0487, 0264, 0218, 0036, 0480, 0516, 0579, 0374, 0499, 0371, 0661, 0009, 0072, 0335 |
| Gorenje | 0370 |
| GPM | 0218 |
| Gradiente | 0170 |
| Graetz | 0487, 0361, 0163, 0371 |
| Gran Prix | 0648 |
| Granada | 0037, 0548, 0560, 0108, 0226, 0473, 0072, 0208, 0516, 0163 |
| Grandin | 0037, 0714, 0668, 1037, 0715, 0610, 0455, 0579, 0163, 0374, 0009, 0282 |
| Grundig | 0556, 0037, 0195, 0487, 0706, 0036, 0587, 0535, 0009, 0070, 0443 |

TV (Continued)

| Manufacturer | Setup Codes |
|------------------|--|
| Haaz | 0706 |
| Haier | 0698 |
| Halifax | 0264 |
| Hanimex | 0218, 0294 |
| Hanseatic | 0556, 0037, 0714, 0634, 0361, 0519, 0661, 0294, 0499, 0009, 0282, 0808, 0377, 0087 |
| Hantarex | 0037, 0009, 0516 |
| Hantor | 0037 |
| Harwood | 0037, 0487, 0009, 0412 |
| Hauppauge | 0037 |
| Havermy | 0093 |
| HCM | 0037, 0264, 0218, 0282, 0009, 0418, 0412 |
| Hema | 0009 |
| Hifivox | 0109, 0198, 0196 |
| Highline | 0037, 0264 |
| Hikona | 0218 |
| Hinari | 0037, 0264, 0218, 0036, 0009, 0355, 0294 |
| Hisawa | 0714, 0610, 0218, 0455, 0282 |
| Hisense | 0508, 0009, 0780, 0208 |
| Hit | 0087 |
| Hitachi | 0037, 0548, 0634, 1037, 1137, 0036, 0108, 0225, 0730, 0072, 0499, 0163, 0578, 0198, 0719, 0480, 0109, 0196, 0473, 0744, 0516, 1481, 0194, 0629 |
| Hitachi Fujian | 0108 |
| Hitsu | 0610, 0218, 0455, 0009 |
| HMV | 0087, 0193 |
| Home Electronics | 0606 |
| Hornlyphon | 0037, 0012 |
| Hoshai | 0282 |
| Huanyu | 0374 |
| Hyper | 0247, 0009 |
| Hypson | 0037, 0714, 0668, 1037, 0715, 0264, 0455, 0621, 0282 |
| H_er | 0714 |
| Iberia | 0037 |
| ICE | 0264, 0218, 0371 |
| ICeS | 0218 |
| Imperial | 0037, 0370, 0196, 0418, 0084, 0074, 0247 |
| Indiana | 0037 |
| Ingelen | 0714, 0610, 0487, 0163 |
| Ingersoll | 0009 |
| Inno Hit | 0009, 0282, 0247, 0072, 0516 |
| Innovation | 0519 |
| Interbuy | 0037, 0264, 0247 |
| Interfunk | 0037, 0361, 0512, 0200, 0012, 0163, 0327, 0087, 0247 |
| Internal | 0037 |
| Intervision | 0037, 0486, 0487, 0264, 0218, 0455, 0009, 0519, 0247, 0377, 0282 |
| IR | 0556, 0037, 0195, 0361, 0370, 0036, 0108, 0225, 0226, 0193, 0327, 0087, 0196, 0374, 0011, 0535, 0190, 0294, 0073, 0104, 0206, 0516, 0163, 0247, 0072, 0194, 0093, 0200, 0512, 0012, 0109, 0070 |
| Irradio | 0037, 0218, 0371, 0009, 0247 |

TV (Continued)

| Manufacturer | Setup Codes |
|----------------|--|
| Isukai | 0037, 0218, 0455, 0282 |
| ITS | 0037, 0264, 0218, 0282, 0371 |
| ITT | 0548, 0610, 0361, 0473, 0193, 0163, 0346, 0480, 0208 |
| ITT Nokia | 0548, 0610, 0606, 0361, 0346, 0480, 0208, 0473, 0163 |
| ITV | 0037, 0264, 0374, 0247 |
| Jean | 0036 |
| JMB | 0556, 0634, 0499, 0443 |
| Jocel | 0712 |
| Jubilee | 0556 |
| JVC | 0606, 0218, 0036, 0653, 0193, 0418, 0190, 0371, 0093 |
| Kaisui | 0037, 0218, 0455, 0009, 0282 |
| Kapsch | 0361, 0206, 0163, 0104 |
| Karcher | 0714, 0610, 0264, 0282 |
| Kathrein | 0556 |
| Kawa | 0371 |
| KB Aristocrat | 0163 |
| Kendo | 0037, 0610, 0247, 0519, 0294 |
| Kennedy | 0206, 0163 |
| Kiota | 0455 |
| Kioto | 0706 |
| Kiton | 0037, 0668 |
| Kneissel | 0556, 0037, 0610, 0499, 0374, 0259 |
| Kolster | 0247 |
| Konichi | 0009 |
| Konka | 0037, 0714, 0218, 0587, 0371, 0418 |
| Kontakt | 0487 |
| Korpel | 0037 |
| Korting | 0087 |
| Kotron | 0412 |
| Koyoda | 0009 |
| Kriesler | 0012 |
| Kyoshu | 0412, 0418 |
| Kyoto | 0163 |
| L&S Electronic | 0714, 0808 |
| LaSAT | 0486 |
| Leader | 0009 |
| Lecson | 0037 |
| Legend | 0009 |
| Lenco | 0037, 0374 |
| Lenoir | 0009 |
| Lesa | 0247 |
| Leyco | 0037, 0264, 0072, 0579, 0294 |
| LG | 0556, 0037, 0714, 0715, 0698, 0178, 0109 |
| Liesenk & Tter | 0037 |
| Liesenkotter | 0037, 0012, 0328, 0327 |
| Lifetec | 0037, 0714, 0668, 1037, 1137, 0218, 0519, 0009, 0374 |
| Lloyd's | 0009 |
| Loewe | 0037, 0087, 0633, 0516, 0512, 0655 |
| Logik | 0698, 0193, 0011, 0009, 0371 |
| Logix | 0668 |
| Luma | 0259, 0206 |
| Lumatron | 0037, 0264, 0259, 0206, 0163, 0073 |
| Lux May | 0037, 0009 |

TV (Continued)

| Manufacturer | Setup Codes |
|---------------------|--|
| Luxman | 0579 |
| Luxor | 0548, 1037, 0361, 0480, 0194, 0473, 0631, 0163, 0208 |
| M Electronic | 0037, 0109, 0374, 0104, 0346, 0163, 0480, 0009 |
| Madison | 0037 |
| Magnadyne | 0087, 0516, 0247 |
| Magnafon | 0516 |
| Magnavox | 0036, 0011, 0780 |
| Magnum | 0037, 0714, 0715, 0648 |
| Mandor | 0264 |
| Manesth | 0037, 0264, 0294 |
| Manhattan | 0037, 0668, 1037 |
| Marantz | 0556, 0037, 0412 |
| Marelli | 0087 |
| Mark | 0037, 0714, 0715, 0374, 0009 |
| Master's | 0499 |
| Masuda | 0037, 0264, 0218, 0371, 0009 |
| Matsui | 0556, 0037, 0714, 0195, 1037, 0487, 0036, 0455, 0433, 0294, 0579, 0011, 0371, 0072, 0208, 0009, 0355, 0443, 0516, 0335, 0629, 0163 |
| MCE | 0009 |
| Mediator | 0037, 0012 |
| Medion | 0556, 0037, 0714, 0668, 1037, 0698, 1137, 0808, 0512 |
| Megas | 0610 |
| MEI | 1037 |
| Meletronic | 0037, 0714, 0634, 0104, 0346, 0512, 0247, 0480, 0009, 0661, 0163, 0374 |
| Memorex | 1037, 0009, 0178 |
| Memphis | 0337 |
| Mercury | 0037, 0009 |
| Metronic | 0625 |
| Metz | 0037, 0668, 0587, 0746, 0447, 0367, 0087, 0535 |
| MGA | 0218, 0374, 0178 |
| Micromaxx | 0037, 0668, 1037, 0808 |
| Microstar | 0808 |
| Minato | 0037 |
| Minerva | 0487, 0108, 0070, 0516, 0535 |
| Minoka | 0037, 0412 |
| Mistral Electronics | 0193 |
| Mitsubishi | 0556, 0037, 1037, 0036, 0108, 0087, 0178, 0535, 0093, 0512 |
| Mivar | 0609, 0516 |
| Monaco | 0009 |
| Morgan's | 0037 |
| MTC | 0370, 0512 |
| MTlogic | 0714 |
| Multibroadcast | 0193 |
| Multitec | 0037, 0668, 1037, 0486 |
| Multitech | 0037, 0486, 0264, 0009, 0247 |
| Murphy | 0163 |
| Musikland | 0218, 0247 |
| Myryad | 0556 |
| NAD | 0361, 0178 |
| Naiko | 0037, 0606 |
| NAT | 0226 |
| National | 0226 |

TV (Continued)

| Manufacturer | Setup Codes |
|---------------|--|
| NEC | 0036, 0455, 0011, 0374, 0661, 0009, 0170, 0499 |
| Neckermann | 0556, 0037, 0370, 0087, 0327, 0247, 0418, 0200 |
| NEI | 0037, 0371, 0337 |
| Nesco | 0247 |
| Netsat | 0037 |
| Network | 0337 |
| Neufunk | 0556, 0037, 0714, 0610, 0218, 0009 |
| New Tech | 0556, 0037, 0009 |
| New World | 0218 |
| Nikkai | 0037, 0264, 0218, 0036, 0009, 0072, 0337 |
| Nikko | 0178 |
| Nobliko | 0070 |
| Nogamatic | 0196, 0109 |
| Nokia | 0548, 0610, 0606, 0361, 0480, 0346, 0473, 0208, 0374, 0163, 0631 |
| Nordmende | 0037, 0714, 0560, 0195, 0109, 0198, 0196 |
| Normerel | 0037 |
| Novak | 0012 |
| Novatronic | 0037, 0374 |
| NU-TEC | 0698, 0455 |
| Oceanic | 0548, 0361, 0208, 0163, 0473 |
| Odeon | 0264 |
| Okano | 0037, 0370, 0009 |
| Omega | 0264 |
| Omni | 0698, 0826, 0780 |
| Onimax | 0714 |
| Onwa | 0218, 0433, 0371, 0602 |
| Opera | 0037 |
| Orbit | 0037 |
| Orion | 0556, 0037, 0714, 0264, 0443, 0655, 0412, 1916, 0355, 0516, 0011, 0294 |
| Orline | 0037, 0218 |
| Ormond | 0668, 1037 |
| Orsowe | 0516 |
| Osaki | 0556, 0037, 0264, 0218, 0412, 0374, 0072, 0355 |
| Osio | 0037 |
| Oso | 0218 |
| Osume | 0037, 0218, 0036, 0072 |
| Otto Versand | 0556, 0037, 0361, 0036, 0226, 0093, 0247, 0512, 0109, 0294, 0535 |
| Pacific | 0556, 0714, 1037, 1137 |
| Palladium | 0037, 0714, 0370, 1137, 0519, 0418, 0655, 0247 |
| Palsonic | 0037, 0698, 0264, 0218, 0418, 0377 |
| Panama | 0037, 0264, 0247 |
| Panasonic | 0037, 0548, 0361, 0650, 0108, 0226, 0516, 0163, 0367 |
| Panavision | 0037 |
| Pathe Cinema | 0163 |
| Pathe Marconi | 0198, 0196 |
| Pausa | 0009 |
| Penney | 0178 |
| Perdio | 0037, 0163, 0072, 0282 |
| Perfekt | 0037 |
| Philco | 0037, 0370, 0247, 0087, 0418, 0084, 0074 |
| Philex | 0193 |
| Philips | 0556, 0037, 0361, 0200, 0012, 0193, 0374, 0009, 0087 |

TV (Continued)

| Manufacturer | Setup Codes |
|-----------------|--|
| Phoenix | 0037, 0486, 0087 |
| Phonola | 0037, 0012, 0193, 0087 |
| Pioneer | 0037, 0486, 0361, 0512, 0011, 0163, 0109, 0170 |
| Pionier | 0486, 0370 |
| Plantron | 0037, 0264, 0009 |
| Playsonic | 0037, 0714, 0715 |
| Polytron | 0697, 0282 |
| Poppy | 0009 |
| Portland | 0374 |
| Powerpoint | 0037, 0487 |
| Prandoni-Prince | 0361, 0516 |
| Premier | 0264, 0009 |
| Prima | 0264, 0009, 0412 |
| Prinston | 1037 |
| Prinz | 0361, 0072, 0194 |
| Profex | 0361, 0163, 0009 |
| Profi | 0009 |
| Profitronic | 0037 |
| Proline | 0037, 0625, 0634, 0072, 0012, 0621 |
| Prosonic | 0037, 0714, 0668, 0370, 0374, 0371, 0579 |
| Protech | 0037, 0668, 1037, 0486, 0264, 0247, 0418, 0337, 0009 |
| Proton | 0178 |
| ProVision | 0556, 0037, 0714 |
| Pye | 0556, 0037, 0412, 0012, 0374, 0087 |
| Pymi | 0009 |
| Quadral | 0218 |
| Quasar | 0009, 0247 |
| Quelle | 0037, 0668, 0361, 0104, 0328, 0535, 0084, 0327, 0011, 0512, 0074, 0200, 0070 |
| Questa | 0036 |
| R-Line | 0037 |
| Radialva | 0218, 0337 |
| Radiola | 0556, 0037, 0012 |
| Radiomarelli | 0037, 0516, 0087 |
| RadioShack | 0037, 0178 |
| Radiotone | 0037, 0668, 1037, 0264, 0009, 0412, 0648, 0579 |
| Rank | 0070 |
| Rank Arena | 0036, 0602 |
| RBM | 0070 |
| RCA | 0625, 0560, 0093 |
| Recor | 0037, 0418 |
| Rectiligne | 0037 |
| Rediffusion | 0548, 0361, 0036, 0346 |
| Reflex | 0037, 0668, 1037 |
| Reoc | 0714 |
| Revox | 0037 |
| Rex | 0264, 0163, 0259, 0206 |
| RFT | 0037, 0264, 0087, 0072 |
| Roadstar | 0037, 0668, 1037, 0264, 0218, 0418, 0282, 0009 |
| Robotron | 0087 |
| Rowa | 0698, 0712, 0264, 0587, 0009 |
| Royal Lux | 0370, 0335, 0412 |
| Saba | 0625, 0548, 0714, 0560, 0361, 0163, 0335, 0109, 0198, 0516, 0087, 0196 |
| Sagem | 0610, 0455 |
| Saisho | 0264, 0011, 0009, 0516 |
| Saivod | 0037, 0668, 1037, 0712 |
| Sakan | 0163 |

TV (Continued)

| Manufacturer | Setup Codes |
|-----------------|--|
| Sakyno | 0455 |
| Salora | 0548, 0361, 0516, 0631, 0194, 0480, 0621, 0163, 0208 |
| Salsa | 0335 |
| Sambers | 0516 |
| Samsung | 0556, 0037, 0264, 0370, 0587, 0618, 0163, 0718, 0009, 0093, 0644, 0208, 0519, 0072, 0178 |
| Sansui | 0037, 0706, 0455, 0371, 0655, 0602 |
| Santon | 0009 |
| Sanyo | 0370, 0036, 0108, 0072, 0208, 0011, 0104 |
| SBR | 0556, 0037, 0193, 0012 |
| Schaub Lorenz | 0548, 0714, 0486, 0606, 0361, 0374 |
| Schneider | 0556, 0037, 0714, 0668, 1037, 0361, 1137, 0218, 0519, 0070, 0247, 0371, 0648, 0012, 0163, 0259 |
| Scotch | 0178 |
| Scotland | 0163 |
| Sears | 0178 |
| Seaway | 0634 |
| Seelver | 1037 |
| SEG | 0037, 0668, 0634, 1037, 0264, 0218, 0036, 0009 |
| SEI | 0037, 0206, 0163, 0516, 0087, 0294 |
| Sei-Sinudyne | 0037, 0087, 0516, 0294, 0206 |
| Seleco | 0264, 0259, 0371, 0206, 0346, 0163 |
| Sencora | 0009 |
| Serino | 0610, 0455, 0093 |
| Sharp | 0036, 1193, 0193, 0516, 0093, 0294, 0200 |
| Shintoshi | 0037 |
| Shivaki | 0037, 0178, 0443 |
| Shorai | 0294 |
| Show | 0072, 0009, 0418 |
| Siarem | 0516, 0087 |
| Siemens | 0037, 0195, 0200, 0535, 0328, 0327 |
| Siera | 0012 |
| Siesta | 0370 |
| Silva | 0037, 0361, 0648 |
| Silva Schneider | 0037 |
| Silver | 0715, 0361, 0036, 0455 |
| Singer | 0037, 0433, 0009, 0335, 0087 |
| Sinudyne | 0037, 0361, 0163, 0087, 0294, 0206, 0516 |
| SKY | 0037 |
| Skysonic | 0696 |
| SLX | 0668 |
| Smaragd | 0487 |
| Solavox | 0037, 0548, 0361, 0072, 0163 |
| Sonawa | 0218 |
| Soniko | 0037 |
| Sonitron | 0370, 0208 |
| Sonneclair | 0037 |
| Sonoko | 0037, 0264, 0009, 0282 |
| Sonorol | 0548, 0361, 0163, 0282, 0208 |
| Sontec | 0037, 0370, 0294, 0009 |
| Sony | 0037, 1505, 0036, 1010, 0170, 1651, 0011, 0093 |
| Sound & Vision | 0218, 0374 |

TV (Continued)

| Manufacturer | Setup Codes |
|--------------|--|
| Soundesign | 0178 |
| Soundwave | 0037, 0715, 0418 |
| Spectra | 0009 |
| Ssangyong | 0009 |
| Staksonic | 0009 |
| Standard | 0037, 1037, 0218, 0009, 0374 |
| Starlite | 0037, 0264, 0009 |
| Stenway | 0218, 0282 |
| Stern | 0206, 0163, 0259 |
| Strato | 0037, 0264, 0009 |
| Sunkai | 0610, 0487, 0455, 0355, 0294 |
| Sunstar | 0037, 0264, 0579, 0009, 0371 |
| Sunwood | 0037 |
| Superla | 0516 |
| Supersonic | 0455, 0009, 0208 |
| SuperTech | 0556, 0037, 0218, 0009 |
| Supra | 0009, 0178 |
| Susumu | 0218, 0335 |
| Sutron | 0009 |
| SVA | 0587 |
| Swissline | 0247 |
| Sysline | 0037 |
| T + A | 0447 |
| T+A | 0447 |
| Tandberg | 0367 |
| Tandy | 0218, 0163, 0093, 0072 |
| Tashiko | 0036, 0163 |
| Tatung | 0037, 0011, 0516, 0072, 0629, 0621 |
| TCM | 0714, 0808 |
| Teac | 0037, 0714, 0668, 1909, 1037, 0698, 0706, 0712, 0264, 0455, 0170, 0282, 0418, 0009, 0178, 0412, 0512 |
| Tec | 0037, 0247, 0337, 0009, 0259 |
| Tech Line | 0037, 0668 |
| Techica | 0218 |
| Technics | 0556, 0650 |
| TechniSat | 0556, 0655 |
| Tecnimagen | 0556 |
| Tedex | 0606, 0418, 0208, 0009 |
| Tek | 0009 |
| Televia | 0196 |
| Telecor | 0037, 0218, 0259, 0163 |
| Telefunken | 0037, 0625, 0560, 0486, 0698, 0712, 0587, 0074, 0196, 0073, 0109, 0346, 0084, 0335 |
| Telefusion | 0037 |
| Telegazi | 0037, 0264, 0218, 0163, 0259 |
| Telesonic | 0037 |
| Telestar | 0556, 0037, 0009, 0579 |
| Teletech | 0037, 0668, 1037, 0009, 0337, 0247 |
| Teleton | 0036, 0206, 0259 |
| Televideon | 0163 |
| Television | 0037 |
| Temco | 0294 |
| Tempest | 0264, 0455, 0009 |
| Tennessee | 0037 |
| Tensai | 0037, 0715, 0218, 0104, 0294, 0377, 0247, 0374, 0009, 0371 |
| Tenson | 0009 |

TV (Continued)

| Manufacturer | Setup Codes |
|--------------------|--|
| Tevion | 0037, 0714, 0668, 1037, 1137, 0648 |
| Texet | 0218, 0009, 0374 |
| Thomson | 0037, 0625, 0560, 0196, 0109, 0335, 0198 |
| Thorn | 0037, 0361, 0036, 0499, 0084, 0190, 0074, 0535, 0109, 0335, 0073, 0512, 0104, 0193, 0072 |
| Thorn-Ferguson | 0073, 0499, 0193, 0190 |
| TMK | 0178 |
| Tobishi | 0218 |
| Tokai | 0037, 0668, 1037, 0337, 0009, 0163, 0072, 0374 |
| Tokaido | 1037 |
| Tomashi | 0218, 0282 |
| Tongtel | 0780 |
| Toshiba | 0714, 0195, 0036, 0618, 0650, 0508, 0718, 0070, 0009, 1508, 0109 |
| Toyoda | 0264, 0009, 0371 |
| Trakton | 0264, 0009 |
| Trans Continens | 0037, 0668, 1037 |
| TRANS-continents | 0621 |
| Trasonic | 0037, 0698, 0712, 0264, 0455, 0587, 0512, 0009, 0418 |
| Triad | 0556 |
| Trident | 0516 |
| Tristar | 0264, 0218, 0193 |
| Triumph | 0556, 0516, 0346 |
| Tsoschi | 0282 |
| TVTEXT 95 | 0556 |
| Uher | 0037, 0486, 0480, 0418, 0374, 0206 |
| Ultravox | 0037, 0087, 0247 |
| Unic Line | 0037, 0455 |
| United | 0037, 0714, 0715 |
| Universal | 0037 |
| Universum | 0037, 0668, 1037, 0361, 0264, 0370, 0036, 0618, 0200, 0473, 0294, 0535, 0074, 0346, 0170, 0418, 0011, 0512, 0070, 0328, 0631, 0104, 0009, 0247, 0480, 0327, 0084 |
| Univox | 0037, 0163, 0087, 0337 |
| Vestel | 0556, 0037, 0668, 1037 |
| Vexa | 0037, 0009 |
| Videologic | 0218 |
| Videologique | 0218 |
| Videomac | 0009 |
| Videosat | 0247 |
| VideoSystem | 0037 |
| Vidtech | 0178 |
| Vision | 0037, 0264 |
| Vistar | 0206 |
| Vortec | 0037 |
| Voxson | 0178, 0163, 0087, 0418 |
| Waltham | 0037, 0668, 1037, 0163, 0109, 0418 |
| Wards | 0178 |
| Watson | 0037, 0668, 1037, 0218, 0579, 0519, 0009, 0163 |
| Wega | 0037, 0036, 0087 |
| Wharfedale | 0556, 0037, 0519 |
| White Westinghouse | 0037, 0337 |
| Windsor | 0668, 1037 |
| Windstar | 0282, 0337 |
| Windy Sam | 0556 |
| Wintel | 0714 |

TV (Continued)

| Manufacturer | Setup Codes |
|--------------|------------------------------|
| Worldview | 0455 |
| Xenius | 0634, 0661 |
| XLogic | 0698 |
| XMS | 0698 |
| Xrypton | 0037 |
| Yamaha | 0650 |
| Yamishi | 0037, 0218, 0455, 0282 |
| Yokan | 0037 |
| Yoko | 0037, 0264, 0218, 0009, 0247 |
| Yorx | 0218 |
| Zanussi | 0264, 0206 |

TV/VCR Combination

| Manufacturer | Setup Codes |
|--------------|-------------|
| Aiwa | 1916 |
| Daewoo | 1909 |
| Emerson | 1909 |
| Goodmans | 1909 |
| Teac | 1909 |

TV/DVD Combination

| Manufacturer | Setup Codes |
|--------------|-------------|
| Bush | 1037, 0698 |

VCR

| Manufacturer | Setup Codes |
|----------------|--|
| Accent | 0072 |
| Adyson | 0072 |
| Aim | 0278, 0020 |
| Aiwa | 0037, 0348, 0000, 0307, 0352, 0734, 0687, 1137, 0742 |
| Akai | 0037, 0348, 0642, 0352, 0315, 0106, 0240, 0020, 0041 |
| Akiba | 0072 |
| Akura | 0072 |
| Alba | 0081, 0278, 0348, 0000, 0072, 0352, 0315, 0020 |
| Allorgan | 0240 |
| Allstar | 0081 |
| Ambassador | 0020 |
| America Action | 0278 |
| Amstrad | 0278, 0000, 0072, 1942 |
| Anam | 0037, 0226, 0240 |
| Anam National | 0226 |
| Anitech | 0072 |
| Ansonic | 0000 |
| Aristona | 0081 |
| ASA | 0081, 0037 |
| Asuka | 0037, 0038 |
| Audiosonic | 0278 |
| Audioton | 0020 |
| AVA Technology | 0615 |
| AVP | 0000, 0352 |
| Awa | 0278, 0037, 0642, 0043 |
| Baird | 0000, 0104, 0106, 0041 |
| Bang & Olufsen | 0499 |
| Basic Line | 0278, 0072, 0104, 0020 |
| Beko | 0104 |
| Bell & Howell | 0104 |
| Bestar | 0278, 0020 |
| Black Diamond | 0642 |
| Black Panther | 0278 |
| Blaupunkt | 0081, 0226, 0195 |

VCR (Continued)

| Manufacturer | Setup Codes |
|--------------------------|--|
| Blue Sky | 0278, 0037, 0348, 0642, 0072, 0352, 0480, 1137 |
| Bondstec | 0072, 0020 |
| Brand Unknown | 0348, 0104 |
| Brandt | 0320, 0041, 0493, 0321 |
| Brandt Electronic | 0041 |
| Brandt Electronique | 0041 |
| Brinkmann | 0348 |
| British Sky Broadcasting | 1942 |
| Bush | 0081, 0278, 0348, 0000, 0642, 0072, 0352, 0315 |
| Carena | 0081 |
| Carrefour | 0045 |
| Carver | 0081 |
| Casio | 0000 |
| Cathay | 0278 |
| Catron | 0020 |
| CGE | 0000, 0041 |
| Cimline | 0072 |
| Citizen | 0278, 0037 |
| Clatronic | 0000, 0072, 0020 |
| Comb | 0072 |
| Combitech | 0352 |
| Condor | 0278, 0020 |
| Craig | 0037, 0072, 0240 |
| Crown | 0278, 0037, 0072, 0480, 0020 |
| Cyrus | 0081 |
| Daewoo | 0278, 0637, 0642, 0352, 0045, 0020 |
| Dansai | 0278, 0072 |
| Dantax | 0352 |
| Daytron | 0278, 0020 |
| De Graaf | 0081, 0104, 0048, 0042, 0166 |
| Decca | 0081, 0000, 0352, 0067, 0041 |
| Deitron | 0278 |
| Denko | 0072 |
| Denon | 0042 |
| Diamant | 0037 |
| Diamond | 0348 |
| Dream Multimedia | 1968 |
| DREAM multimedia.TV | 1968 |
| Dual | 0081, 0278, 0348, 0000, 0041 |
| Dumont | 0081, 0000, 0104 |
| Elbe | 0278, 0038 |
| Elcatech | 0072 |
| Elin | 0240 |
| Elsay | 0072 |
| Elta | 0278, 0072 |
| Emerson | 0278, 0637, 0037, 0000, 0072, 0045, 0043, 0593 |
| ESC | 0278, 0240, 0020 |
| Etzuko | 0072 |
| Europhon | 0020 |
| Fenner | 0020 |
| Ferguson | 0278, 0000, 0320, 0493, 0041, 0321 |
| Fidelity | 0000, 0072, 0352, 0432, 0240 |
| Finlandia | 0081, 0037, 0000, 0384, 0104, 0048, 0043, 0042, 0106, 0226, 0166 |
| Finlux | 0081, 0000, 0104, 0042 |
| Firstline | 0278, 0037, 0348, 0072, 0045, 0043, 0480, 1137 |

VCR (Continued)

| Manufacturer | Setup Codes |
|---------------------|--|
| Fisher | 0104, 0020 |
| Flint | 0348 |
| Frontech | 0072, 0020 |
| Fujitsu | 0000 |
| Fujitsu General | 0037 |
| Funai | 0000 |
| Galaxi | 0000 |
| Galaxis | 0278 |
| Garrard | 0000 |
| GBC | 0020 |
| GE | 0320, 0048, 0240 |
| GEC | 0081 |
| General | 0020 |
| General Technic | 0348 |
| Genexxa | 0104 |
| Go Video | 0432, 0620 |
| GoldHand | 0072 |
| GoldStar | 0037, 0480 |
| Goodmans | 0081, 0278, 0637, 0037, 0348, 0000, 0642, 0072, 0352, 0020 |
| GPX | 0037 |
| Gradiente | 0000 |
| Graetz | 0104, 0240, 0041 |
| Granada | 0081, 0037, 0000, 0104, 0048, 0042, 0226, 0240 |
| Grandin | 0278, 0037, 0000, 0072, 0020 |
| Grundig | 0081, 0348, 0072, 0320, 0352, 0226, 0195, 0347, 0742 |
| Haaz | 0348 |
| Hanimex | 0352 |
| Hanseatic | 0081, 0037, 0038 |
| Hantor | 0020 |
| Harley Davidson | 0000 |
| Harman/Kardon | 0038 |
| Harwood | 0072 |
| HCM | 0072 |
| Hinari | 0278, 0072, 0352, 0041, 0240 |
| Hisawa | 0352 |
| Hischito | 0045 |
| Hitachi | 0081, 0000, 0042, 0240, 0041, 0166, 0593 |
| Hornlyphon | 0081 |
| Hughes Network Syst | 0042 |
| Hypson | 0278, 0037, 0000, 0072, 0352, 0480 |
| H_er | 0278, 0642 |
| Impego | 0020 |
| Imperial | 0000 |
| Ingersoll | 0240 |
| Inno Hit | 0072, 0020 |
| Interbuy | 0037, 0072 |
| Interfunk | 0081, 0104 |
| Internal | 0278, 0637 |
| International | 0278, 0037, 0642 |
| Intervision | 0278, 0000 |
| IR | 0081, 0348, 0072, 0104, 0045, 0042, 0106, 0226, 0240, 0041, 0020 |
| Irradio | 0081, 0037, 0072 |
| ITT | 0384, 0104, 0106, 0041, 0240 |
| ITV | 0278, 0037, 0020 |
| ITV Videomaster | 0020 |
| JBL | 0278 |

VCR (Continued)

| Manufacturer | Setup Codes |
|--------------|--|
| Jensen | 0041 |
| JMB | 0348, 0352, 0742 |
| Joyce | 0000 |
| JVC | 0081, 0384, 0067, 0041 |
| Kaisui | 0072 |
| Kambrook | 0037 |
| Karcher | 0081, 0278 |
| KEC | 0278, 0037 |
| Kendo | 0278, 0348, 0642, 0072, 0315, 0106 |
| Kenwood | 0067, 0041, 0038 |
| KIC | 0000 |
| Kneissel | 0278, 0037, 0348, 0352 |
| Korpel | 0072 |
| Kuwa | 0226 |
| Kyoto | 0072 |
| Lenco | 0278 |
| Leyco | 0072 |
| LG | 0037, 0480, 1137 |
| Lifetec | 0348 |
| Lloyd's | 0000 |
| Loewe | 0081, 1562, 0037 |
| Logik | 0072, 0106, 0240 |
| Lumatron | 0593 |
| Lux May | 0072 |
| Luxor | 0104, 0048, 0043, 0315, 0106 |
| LXI | 0037 |
| M Electronic | 0000, 0038 |
| Magnasonic | 0278, 0593 |
| Magnavox | 0081, 0000, 0642 |
| Magnin | 0240 |
| Magnum | 0642 |
| Manesth | 0081, 0072, 0045 |
| Marantz | 0081, 0038 |
| Mark | 0278, 0000, 0020 |
| Master's | 0278 |
| Matsui | 0278, 0348, 0352, 0742, 0687, 0240 |
| Mediator | 0081 |
| Medion | 0348, 0642, 0352 |
| Meletronic | 0037, 0000, 0038 |
| Memorex | 0037, 0348, 0000, 0104, 0048, 0240 |
| Memphis | 0072 |
| Mercury | 0020 |
| Metronic | 0081 |
| Metz | 0081, 1562, 0037, 0226, 0195, 0836, 0347 |
| MGA | 0043, 0240 |
| Micormay | 0348 |
| Migros | 0000 |
| Minerva | 0195 |
| Minolta | 0042 |
| Mitsubishi | 0081, 0000, 0642, 0067, 0048, 0043, 0480 |
| MTC | 0000, 0240 |
| Multitec | 0037 |
| Multitech | 0000, 0072, 0020 |
| Murphy | 0000 |
| Myryad | 0081 |
| NAD | 0104 |
| Naiko | 0642 |

VCR (Continued)

| Manufacturer | Setup Codes |
|---------------|--|
| National | 0226 |
| NEC | 0278, 0037, 0104, 0067, 0041, 0038 |
| Neckermann | 0081 |
| Nesco | 0000, 0072 |
| Nikkai | 0278, 0072, 0020 |
| Nikko | 0037 |
| Nokia | 0081, 0278, 0104, 0048, 0042, 0315, 0106, 0240, 0041 |
| Nordmende | 0320, 0384, 0067, 0041, 0321, 0493 |
| Oceanic | 0081, 0000, 0104, 0048, 0106, 0041 |
| Okano | 0278, 0348, 0072, 0315 |
| Onimax | 0642 |
| Optimus | 0037, 0104, 0048, 0432, 0593 |
| Orbit | 0072 |
| Orion | 0348, 0352, 0742, 0687 |
| Orson | 0000 |
| Osaki | 0037, 0000, 0072 |
| Osume | 0072 |
| Otto Versand | 0081 |
| Pace | 0352, 1942 |
| Pacific | 0348, 0000, 0642 |
| Palladium | 0037, 0348, 0072, 0041 |
| Palsonic | 0000, 0642, 0072 |
| Panasonic | 1562, 0226, 0836, 1662 |
| Pathe Cinema | 0043 |
| Pathe Marconi | 0041 |
| Penney | 0037, 0042, 0240, 0038 |
| Pentax | 0042 |
| Perdio | 0000 |
| Philco | 0072, 0038 |
| Philips | 0081, 0384, 0593 |
| Phoenix | 0278 |
| Phonola | 0081 |
| Pilot | 0037 |
| Pioneer | 0081, 0067, 0042 |
| Portland | 0278, 0637, 0020 |
| Prinz | 0000 |
| Profitronic | 0081, 0240 |
| Proline | 0278, 0000, 0642, 0320, 0615, 0321 |
| Proscopro | 0278 |
| Prosonic | 0278 |
| Protech | 0081 |
| ProVision | 0278 |
| Pye | 0081, 0000 |
| Quasar | 0278 |
| Quelle | 0081 |
| Radialva | 0081, 0037, 0072, 0048 |
| Radiola | 0081 |
| Radionette | 0037, 1137 |
| RadioShack | 0037, 0000 |
| Rank | 0041 |
| Rank Arena | 0041 |
| RCA | 0320, 0048, 0042, 0240 |
| Realistic | 0037, 0000, 0104, 0048 |
| Reoc | 0348 |
| Rex | 0384, 0041 |
| RFT | 0072, 0020 |

VCR (Continued)

| Manufacturer | Setup Codes |
|---------------|--|
| Roadstar | 0081, 0278, 0037, 0072, 0240, 0742 |
| Royal | 0072 |
| Saba | 0278, 0320, 0384, 0321, 0041 |
| Saisho | 0348 |
| Salora | 0104, 0043, 0106 |
| Samsung | 0045, 0432, 0620, 0240 |
| Samurai | 0020 |
| Sansei | 0048 |
| Sansui | 0348, 0000, 0072, 0067, 0106, 0041 |
| Sanyo | 0348, 0104, 0067, 0048, 0240 |
| Saville | 0278, 0352, 0240 |
| SBR | 0081 |
| Schaub Lorenz | 0348, 0000, 0104, 0315, 0106, 0041 |
| Schneider | 0081, 0278, 0037, 0348, 0000, 0642, 0072, 0352, 0042, 0240 |
| Scott | 0043 |
| Sears | 0037, 0000, 0104, 0042 |
| Seaway | 0278 |
| SEG | 0081, 0278, 0637, 0642, 0072, 0240 |
| SEI | 0081 |
| Sei-Sinudyne | 0081 |
| Seleco | 0037, 0384, 0020, 0041 |
| Semp | 0045 |
| Sentra | 0072, 0020 |
| Setron | 0072 |
| Sharp | 0037, 0048, 0569 |
| Shintom | 0072, 0104 |
| Shivaki | 0037 |
| Siemens | 0081, 0037, 0320, 0104, 0195, 0347 |
| Siera | 0081 |
| Silva | 0037 |
| Silver | 0278 |
| Singer | 0348, 0045 |
| Sinudyne | 0081, 0352 |
| SKY | 1942 |
| Smaragd | 0348 |
| Solavox | 0020 |
| Sonneclair | 0072 |
| Sontec | 0037 |
| Sony | 0000, 0032, 0106, 1032 |
| Soundwave | 0037, 0348 |
| Ssangyong | 0072 |
| Standard | 0278 |
| Stern | 0278 |
| Sunkai | 0278, 0348 |
| Sunstar | 0000 |
| Suntronic | 0000 |
| Sunwood | 0072 |
| Supra | 0278, 0037, 0348 |
| Sylvania | 0081, 0043 |
| Symphonic | 0000, 0593 |
| Tandberg | 0278 |
| Tandy | 0000, 0104 |
| Tashiko | 0081, 0037, 0000, 0048, 0240 |
| Tatung | 0081, 0348, 0000, 0352, 0048, 0043, 0041 |
| Tchibo | 0348 |
| TCM | 0348 |

VCR (Continued)

| Manufacturer | Setup Codes |
|--------------------|--|
| Teac | 0278, 0637, 0037, 0000, 0307, 0642, 0072, 0593, 0041 |
| Tec | 0072, 0020 |
| Tech Line | 0072 |
| Technics | 0081, 0226 |
| TechniSat | 0348 |
| Tedelex | 0037, 0348 |
| Teknika | 0037, 0000 |
| Teleavia | 0493, 0041 |
| Telefunken | 0278, 0642, 0320, 0384, 0041, 0321, 0493 |
| Telestar | 0037 |
| Teletech | 0278, 0000, 0072 |
| Tempest | 0020 |
| Tenosal | 0072 |
| Tensai | 0278, 0000, 0072 |
| Tevion | 0348, 0642 |
| Texet | 0278, 0020 |
| Thomas | 0000 |
| Thomson | 0278, 0320, 0384, 0067, 0041, 0493, 0321, 0722 |
| Thorn | 0037, 0104, 0041 |
| Tivo | 0722 |
| Tokai | 0037, 0072, 0104, 0041 |
| Topline | 0348 |
| Toshiba | 0081, 0384, 0352, 0045, 0043, 0432, 0742, 0041 |
| Totevision | 0037 |
| Towada | 0072 |
| Tradex | 0081 |
| Trakton | 0020 |
| Triad | 0278 |
| TVA | 0020 |
| Uher | 0240 |
| Ultravox | 0278 |
| Unitech | 0240 |
| United | 0348 |
| United Quick Star | 0278 |
| Universum | 0081, 0037, 0348, 0000, 0104, 0106, 0240, 0195, 1137 |
| Victor | 0067 |
| Video Concepts | 0045 |
| Video Pro | 0020 |
| Video Technic | 0000 |
| Videomagic | 0037 |
| VideoPro | 0020 |
| Videosonic | 0240 |
| Villain | 0000 |
| Wards | 0081, 0000, 0072, 0045, 0048, 0042, 0240, 0038 |
| Watson | 0081, 0642, 0352 |
| Weltblick | 0037 |
| Wewa | 0493 |
| Wharfedale | 0642, 0615, 0593 |
| White Westinghouse | 0278, 0072 |
| World | 0348 |
| Yamaha | 0038 |
| Yamishi | 0278, 0072 |
| Yokan | 0072 |
| Yoko | 0037, 0072, 0020, 0240 |
| Zenith | 0637, 0000 |
| ZX | 0348, 0352 |

PVR

| Manufacturer | Setup Codes |
|------------------|-------------|
| Dream Multimedia | 1968 |
| Pace | 1942 |
| SKY | 1942 |
| Thomson | 0722 |
| Tivo | 0722 |

DVD player

| Manufacturer | Setup Codes |
|--------------------|--|
| 3DLAB | 0539 |
| A-Trend | 0714 |
| Acoustic Solutions | 0730 |
| AEG | 0770, 0790, 0788 |
| Afreedy | 0698 |
| Aim | 0699 |
| Aiwa | 0533, 0641, 1912 |
| Akai | 0790, 1115, 0716, 0705, 0788, 0690, 0766 |
| Akira | 0699 |
| Akura | 1170, 0898 |
| Alba | 0539, 0695, 0730, 0717, 0672, 0713, 0783, 0699 |
| Alize | 1151 |
| Amitech | 0770, 0850 |
| Amstrad | 0713 |
| AMW | 0872 |
| Ansonic | 0831 |
| Apex Digital | 1004, 0672 |
| Audiosonic | 0690 |
| Audiovox | 0717 |
| Awa | 0730, 0872 |
| Axion | 0730 |
| Baze | 0672 |
| Beko | 1153 |
| Bellagio | 1004 |
| Black Diamond | 0766, 0713 |
| Blue Sky | 0695, 0651, 0713, 0672 |
| Boghe | 1004 |
| Boman | 0783 |
| Brainwave | 0770, 1115 |
| Brand Unknown | 0490, 0730, 0717 |
| Brandt | 0503, 0551, 0651 |
| Broksonic | 0695 |
| Bush | 0695, 0730, 0831, 0690, 0713, 0672, 0699, 0516, 0717 |
| C-Tech | 0768 |
| Cambridge Audio | 0751 |
| Cat | 0699 |
| CCE | 0730 |
| Centrex | 1004, 0672 |
| Centrum | 0713 |
| CGV | 1115, 0751 |
| Cinetec | 0872, 0713 |
| cineULTRA | 0699 |
| Classic | 0730 |
| Clatronic | 0672, 0788 |
| Clayton | 0713 |
| Coby | 0730 |
| Compacts | 0826 |
| Conia | 0852, 0672, 0516 |
| Contel | 0788 |
| Continental Edison | 0831, 0872 |
| Crown | 0770, 1115, 0690 |
| Cybercom | 0831 |
| CyberHome | 0714 |

DVD player (Continued)

| Manufacturer | Setup Codes |
|----------------------|--|
| Cytron | 0651, 0705, 0716 |
| D-Vision | 1115 |
| Daewoo | 0770, 0705, 0872, 0714 |
| Daewoo International | 0872 |
| Dansai | 0770, 1115, 0783 |
| Dantax | 0790, 0723 |
| Daytek | 0872 |
| Dayton | 0872 |
| DCE | 0831 |
| Decca | 0770, 1115 |
| Denon | 0490, 1634 |
| Denver | 0672, 0898, 0788, 0699 |
| Denzel | 0665 |
| Diamond | 0768, 0651, 0751 |
| Digihome | 0713 |
| digiRED | 0717 |
| Digitor | 0651 |
| Digitrex | 0672 |
| DIGIXmedia | 0826 |
| DiK | 0831 |
| Dinamic | 0788 |
| DiViDo | 0705 |
| DK digital | 0831 |
| DMTECH | 0783 |
| Dragon | 0831 |
| DreamX | 1151 |
| Dual | 0730, 0831, 0651, 0790, 0783, 0713, 0665 |
| Durabrand | 0713 |
| DVX | 0768 |
| Eclipse | 0751, 0723 |
| Elin | 0770 |
| Elion | 0850 |
| Elta | 0770, 0690, 0850, 0672, 0788, 1151, 1115 |
| Eltax | 0766 |
| Emerson | 0591, 0705 |
| Encore | 0698 |
| Enterprise | 0591 |
| Enzer | 0766 |
| EuroLine | 1115, 0788 |
| Fenner | 0651 |
| Ferguson | 0651 |
| Finlux | 0741, 0591, 0770, 0672, 0751, 0783 |
| Firstline | 0713 |
| Fisher | 0670 |
| Funai | 0695 |
| GE | 0717 |
| Global Solutions | 0768 |
| Global Sphere | 0768 |
| Go Video | 0783 |
| GoldStar | 0741, 0591 |
| Goodmans | 0730, 0651, 0790, 0713, 0783, 0690, 1004, 0723 |
| GPX | 0699 |
| Graetz | 0665 |
| Gran Prix | 0831, 0898 |
| Grandin | 0713, 0716 |
| Greenhill | 0717 |
| Grundig | 0539, 0551, 0695, 0651, 0790, 0775, 0723, 1004, 0670, 0713, 0705 |
| Grunkel | 0770 |

DVD player (Continued)

| Manufacturer | Setup Codes |
|------------------|--|
| H & B | 0850 |
| H&B | 0850, 0713 |
| Haaz | 0768, 0751 |
| Hanseatic | 0741, 0783, 1153 |
| Harman/Kardon | 0702 |
| HCM | 0788 |
| HDT | 0705 |
| HE | 0730 |
| HenØ | 0713 |
| Hitachi | 0573, 0664 |
| Hiteker | 0672 |
| Home Electronics | 0730 |
| Humax | 0646 |
| Hyundai | 0850, 0783 |
| H_er | 0831, 0651, 0826, 0713 |
| ICP | 1153 |
| Ingelen | 0788 |
| InterAct | 0697 |
| IRT | 0783 |
| ISP | 0695 |
| Jaton | 0665 |
| JDB | 0730 |
| Jeken | 0699 |
| JMB | 0695 |
| JVC | 0623, 0539, 0503, 0558, 1940, 1901, 1164, 1988 |
| Karcher | 0783 |
| Kendo | 0713, 0699 |
| Kennex | 0770 |
| Kenwood | 0490, 0534 |
| Kihiro | 0770 |
| Kiss | 0665 |
| Lawson | 0768, 0716 |
| Lenco | 0770, 0651, 0699, 0672, 0713 |
| Lenoxx | 0690 |
| Lexia | 0768, 0699 |
| LG | 0741, 0591, 1906 |
| Lifetec | 0831, 0651 |
| Limit | 0768, 0716 |
| Loewe | 0539, 0885 |
| Logix | 0783, 0705 |
| Lumatron | 0705 |
| Luxman | 0573 |
| Luxor | 1004 |
| Mad Catz | 1002, 1108 |
| Magnavox | 0503 |
| Magnex | 0723 |
| Manhattan | 0705, 0713 |
| Marantz | 0539 |
| Mark | 0713 |
| Marquant | 0770 |
| Matsui | 0695, 0651, 0672, 1004, 0713 |
| Maxdorf | 0788 |
| Maxim | 0713 |
| MBO | 0730, 0690 |
| Mecotek | 0770 |
| Medion | 0630, 0831, 0651, 0716, 0783 |
| Memorex | 0831 |
| Metronic | 0690 |
| Metz | 0571, 0525, 0713 |
| MiCO | 1179, 0751, 0723 |
| Micromedia | 0539, 0503 |

DVD player (Continued)

| Manufacturer | Setup Codes |
|------------------|--|
| Micromega | 0539 |
| Microsoft | 0522 |
| Microstar | 0831 |
| Minato | 0752 |
| Minax | 0713 |
| Minerva | 0705 |
| Minoka | 0770 |
| Mirror | 0752 |
| Mitsubishi | 0713 |
| Monyka | 0665 |
| Mustek | 0730 |
| Mx Onda | 0651, 1179, 0751 |
| NAD | 0741 |
| Naiko | 0770, 1004 |
| Neufunk | 0665 |
| Nevir | 0770, 0831 |
| Nordmende | 0831 |
| Noriko | 0752 |
| NU-TEC | 0516 |
| Okano | 0752 |
| Olidata | 0672 |
| Omni | 0698, 0690 |
| Onkyo | 0503, 0612, 1924, 0627 |
| Optimus | 0525 |
| Orion | 0695 |
| Oritron | 0651 |
| Ormond | 0713 |
| Otic | 0826 |
| Pacific | 0831, 0768, 0790, 0713 |
| Palladium | 0695 |
| Palsonic | 0672, 0852 |
| Panasonic | 0490, 1908, 1907, 1910, 1909 |
| Panda | 0717 |
| Pelican | 0731 |
| Philco | 0788, 0690 |
| Philips | 0539, 0503, 0646, 1914 |
| Phonotrend | 0699 |
| Pioneer | 0571, 0525, 0631, 1902, 1900, 0638, 1965 |
| Plu2 | 0850 |
| Powerpoint | 0872 |
| Prima | 0766 |
| Prima Electronic | 0766 |
| Prinz | 0831 |
| Prism | 0705 |
| Proline | 0651, 1004, 0672 |
| Proscan | 0522 |
| Prosonic | 0699 |
| ProVision | 0699 |
| Radionette | 0741 |
| Raite | 0665 |
| RCA | 0522 |
| REC | 0490, 0766 |
| Red Star | 0770, 0898, 0788 |
| Redstar | 0898 |
| Reoc | 0768, 0752 |
| Revoy | 0699 |
| Roadstar | 0730, 0690, 0672, 0713, 0699 |
| Ronin | 0872 |
| Rotel | 0623, 0558 |
| Rowa | 0516, 1004, 0872, 0717 |
| Saba | 0551, 0651 |
| Saitek | 0731 |

DVD player (Continued)

| Manufacturer | Setup Codes |
|-----------------|--|
| Saivod | 0831 |
| Salora | 0741 |
| Sampo | 0752, 0698 |
| Samsung | 0490, 0573, 1932, 0744 |
| Sansui | 0695, 0768, 0751, 0716, 1153 |
| Sanyo | 0670 |
| Scan | 0850, 0705 |
| ScanMagic | 0730 |
| Schaub Lorenz | 0770, 1151, 1115, 0788 |
| Schneider | 0539, 0831, 0651, 0790, 0705, 0788, 1153, 0783 |
| Schwaiger | 0752 |
| Scientific Labs | 0768 |
| Scott | 0651, 1036, 0672 |
| SEG | 0768, 0872, 0713, 0665 |
| Shanghai | 0672 |
| Sharp | 0630, 0752 |
| Sherwood | 0741, 0717 |
| Shinco | 0717 |
| Silva | 0788, 0898 |
| Silva Schneider | 0831, 0898 |
| Simaudio | 0885 |
| Singer | 0768, 0716, 0690, 0751 |
| Skymaster | 0730, 0768 |
| Skysonic | 0766 |
| Skyworth | 0766 |
| Slim Devices | 0533 |
| SM Electronic | 0730, 0768, 0690 |
| Smart | 0713, 0705 |
| Sonashi | 0831, 0716 |
| Sonic Blue | 0783 |
| Sony | 0573, 1633, 1981, 1070, 1934, 0864, 1903, 0772 |
| Soundmaster | 0768 |
| Soundmax | 0768 |
| Soundwave | 0783 |
| Spectra | 0872 |
| Standard | 0768, 0651, 0788 |
| Sunkai | 0770, 0850 |
| Sunwood | 0788, 0898 |
| Supervision | 0768 |
| SVA | 0672 |
| Synn | 0768 |
| Tandberg | 0713 |
| Tatung | 0770 |
| Teac | 0571, 0741, 0768, 0790, 0516, 0717 |
| Tec | 0898 |
| Technics | 0490, 1905 |
| Technika | 0770, 0831, 1115 |
| Technisson | 1115 |
| Technosonic | 1115 |
| Techwood | 0713 |
| Tedelex | 0690 |
| Telefunken | 0790 |
| Teletech | 0768, 0713 |
| Tensai | 0770, 0651, 0690 |
| Tevion | 0768, 0651, 1036 |
| Theta Digital | 0571 |
| Thomson | 0551, 0522 |
| Thrustmaster | 0498 |
| Tokai | 0790, 0698, 0898, 0665, 0788 |
| Tokaido | 0698 |
| Tokiwa | 0716 |

DVD player (Continued)

| Manufacturer | Setup Codes |
|------------------|------------------------------|
| Toshiba | 0503, 1045, 1988 |
| Trans Continens | 0826 |
| TRANS-continents | 0831, 0826, 0872 |
| Transonic | 0672 |
| Umax | 0690, 1151 |
| United | 0730, 1115, 0672, 0826, 0788 |
| Universum | 0741, 0591, 0713 |
| Venturer | 0790 |
| Vestel | 0713 |
| Vieta | 0705 |
| Voxson | 0730, 0831, 0690 |
| Waitec | 1151 |
| Walkvision | 0717 |
| Welkin | 0831 |
| Wellington | 0713 |
| Wesder | 0699 |
| Wharfedale | 0790, 0752, 0751, 0698 |
| Wilson | 0831 |
| Windy Sam | 0573 |
| WIZE | 1115 |
| Woxter | 1151 |
| Xenius | 0790 |
| XLogic | 0768 |
| XMS | 0788 |
| Yakumo | 1004 |
| Yamada | 1151, 1004, 0872 |
| Yamaha | 0490, 0539, 0646 |
| Yamakawa | 0665, 0872 |
| Yukai | 0730 |
| Zenith | 0503, 0591, 1135 |

Game Player

| Manufacturer | Setup Codes |
|-------------------|-------------|
| Xbox | 0522 |
| Sony PlayStation2 | 0533 |

DVD player, MD recorder CD player & TV operations

Refer to the following for the type of remote control operations available for each component.

- ❶ Select the input source.
- ❷ Press the keys corresponding to the operations you desire. Refer to the following sections for details.

- When pressing keys in succession, press each key firmly and be sure to wait at least 1 second before pressing the next key.
- Numeric keys function the same as the numeric keys on the original remote.

These keys can be used to perform the basic operations of KENWOOD and other manufacturers' components which the setup code for each component had been entered beforehand. - 41 - 44

DVD player operation keys

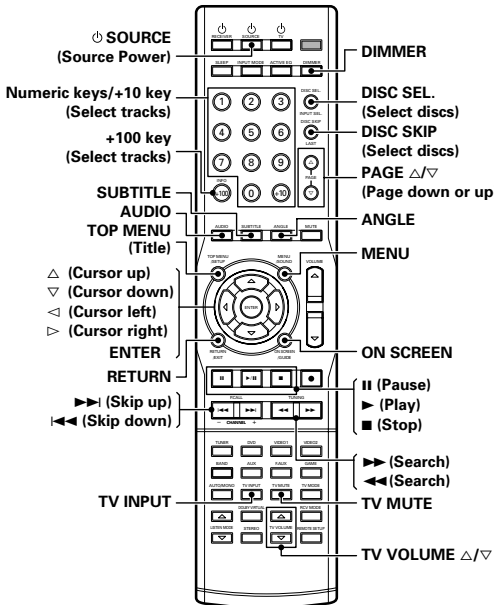

MD recorder operation keys (made by KENWOOD)

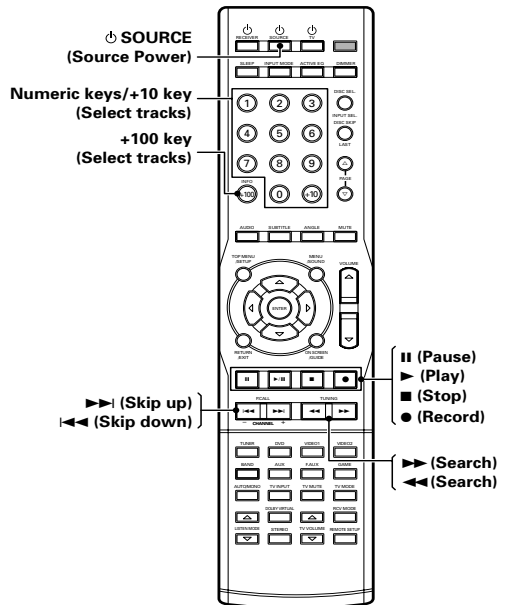

CD player operation keys

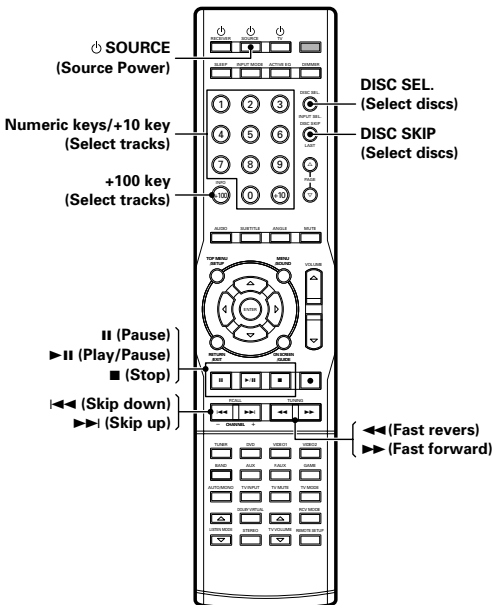

TV operation keys (including TVs incorporating VCR)

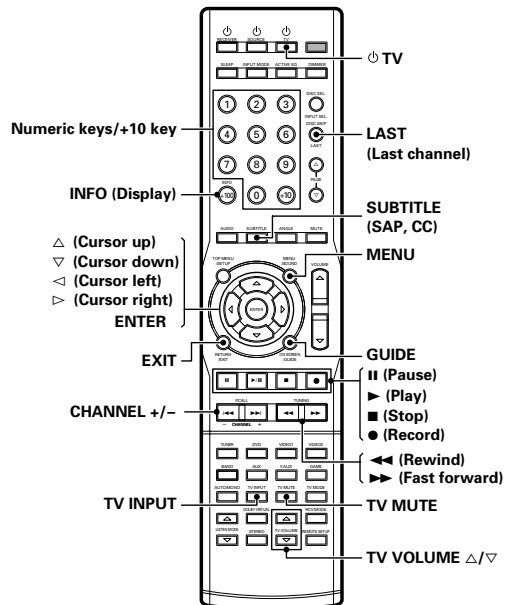

VCR, Satellite receiver & Cable converter operations

Refer to the following for the type of remote control operations available for each component.

- ❶ Select the input source.
- ❷ Press the keys corresponding to the operations you desire. Refer to the following sections for details.

- When pressing keys in succession, press each key firmly and be sure to wait at least 1 second before pressing the next key.
- Numeric keys function the same as the numeric keys on the original remote.

These keys can be used to perform the basic operations of KENWOOD and other manufacturers' components which the setup code for each component had been entered beforehand. → 41 → 44

VCR operation keys

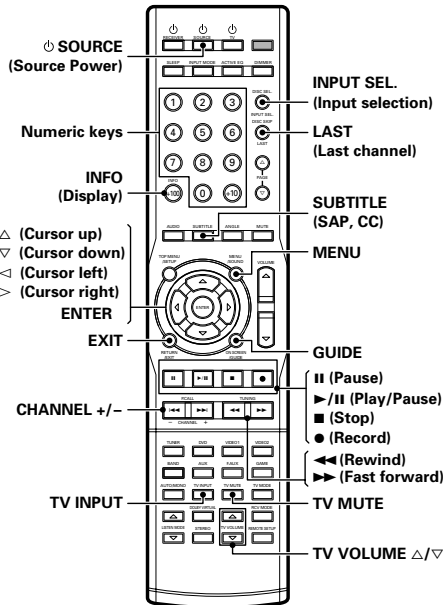

Satellite receiver operation keys

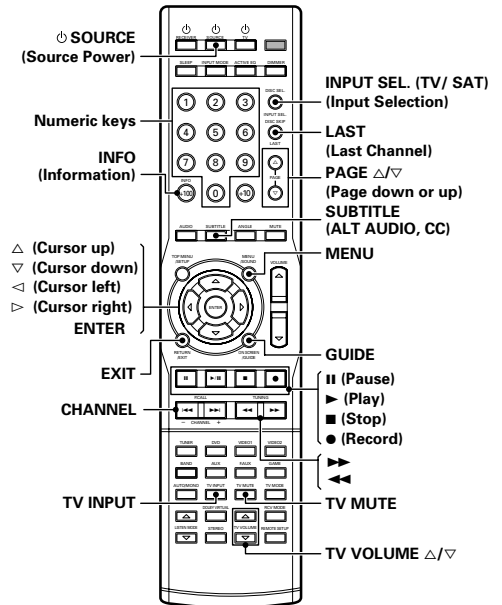

Cable converter operation keys

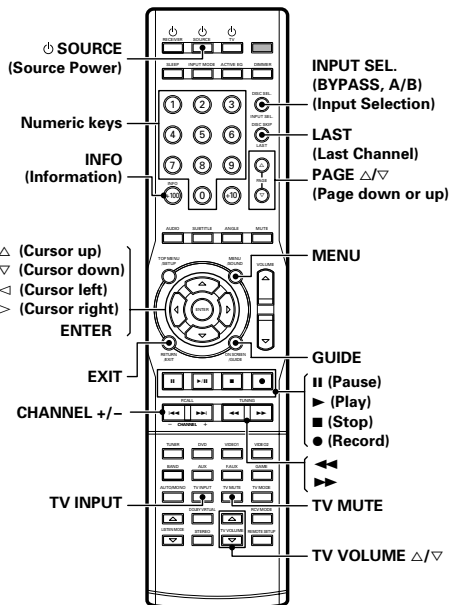

Sirius operation keys (made by KENWOOD)

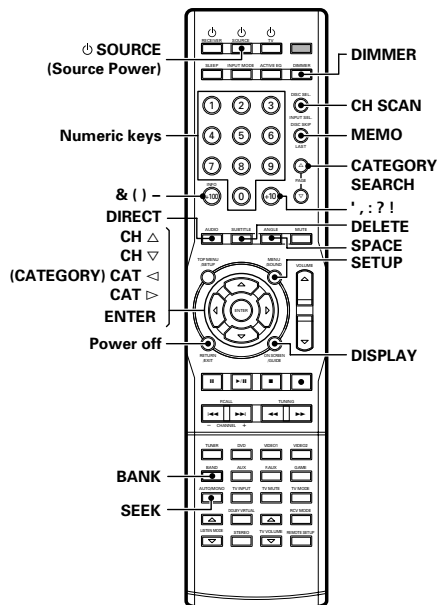

In case of difficulty

Resetting the Microcomputer

The microcomputer may malfunction (unit cannot be operated, or shows an erroneous display) if the power cord is unplugged while the power is ON, or due to some other external factor. If this happens, execute the following procedure to reset the microcomputer and return the unit to its normal operating condition.

Unplug the power cord from the wall outlet, then plug it back in while holding down the ON/STANDBY  key.

- Please note that resetting the microcomputer will clear the contents of the memory and returns the unit to the state it was in when it left the factory.

Amplifier

| Symptom | Remedy |
|--|---|
| No sound from the speakers. | <ul style="list-style-type: none"> ● Connect the components properly referring to "Connecting the speakers". -12 ● If muting is ON, release it. -25 ● If headphones are connected, disconnect them. -24 ● Press the INPUT MODE key to select to full auto mode. -8 ● Check if the assignment of digital audio input jacks is correct. -22 |
| Sound is not output from the speaker, or their sound is very small. | <ul style="list-style-type: none"> ● Connect the components properly referring to "Connecting the speakers". -12 ● See "Speaker settings" and check if the setting for all of the speakers is correct. -18 ● Select a surround mode. ● Adjust the speaker levels using the test tone. -20 |
| The standby indicator blinks and sound is not output. | <ul style="list-style-type: none"> ● The protection circuitry is activated because speaker cords are short-circuited. Disconnect the power cord from the AC wall outlet, switch the receiver OFF, remove the short-circuiting and turn the receiver ON again. ● The protection circuitry is activated because the output power is too high. Turn this unit OFF then ON again and reduce the output volume level. ● The protection circuitry activated due to extreme rise in temperature. Turn this unit OFF then ON again and reduce the output volume level. ● The protection circuitry is activated because the impedance of the speakers in use is lower than specified. Use speakers of the specified impedance. |
| The audio and video of a different channel are output. | <ul style="list-style-type: none"> ● Check if the assignment of digital audio input jacks and component video jacks is correct. -22 |
| The video is not output. | <ul style="list-style-type: none"> ● Connect the video source to be played to this unit and this unit to the monitor TV using the same type of cords (Component video cords, S VIDEO cords or yellow RCA video cords) correctly. -10 |
| Audio cannot be recorded. | <ul style="list-style-type: none"> ● Connect the equipment correctly by referring to "Connecting video components, audio components" and "Digital connections". -10 -11 ● If it is the digital audio that you attempt to record, set up the unit correctly by referring to "Recording music in REC mode". -26 |
| A video source cannot be recorded normally. | <ul style="list-style-type: none"> ● Copy-guarded video software cannot be recorded. ● The S VIDEO and component video inputs cannot be recorded. Connect the video source to the yellow RCA video jack. -10 |
| When playing a digital source signal, the sound is cut off soon after it starts. | <ul style="list-style-type: none"> ● There are many possible causes for this problem, depending on the type of player used. Switch the input mode to DIGITAL MANUAL during playback of the digital source, and restart the playback from the beginning. -8 |
| Dolby Digital or DTS audio software cannot be played in multi-channel audio. | <ul style="list-style-type: none"> ● Check if the digital output setting of the digital audio player is correct. |
| The audio of a satellite digital broadcasting cannot be switched. | <ul style="list-style-type: none"> ● With certain broadcasting, the audio cannot be switched on the receiver. In this case, switch the audio on your satellite digital tuner. |
| The input for the unit is set automatically to "GAME" when the unit is turned ON. | <ul style="list-style-type: none"> ● The GAME mode function is activated. -21 |

Tuner

| Symptom | Remedy |
|--|--|
| Radio stations cannot be received. | <ul style="list-style-type: none"> ● Connect an antenna properly. - [15] ● Set the broadcast band properly. - [27] ● Tune the frequency of the desired station. |
| Interference. | <ul style="list-style-type: none"> ● Install the outdoor antenna away from the road. ● Turn off the power to the appliance. ● Install the receiver farther away from the TV. |
| A station which was preset cannot be received by pressing the corresponding numeric key. | <ul style="list-style-type: none"> ● Preset a station with a receivable frequency. |

Remote control unit

| Symptom | Remedy |
|---|---|
| Control of other component is impossible. | <ul style="list-style-type: none"> ● Register its setup code correctly. - [39] |
| Remote control operation is not possible. | <ul style="list-style-type: none"> ● Press the input selector key and select the optimum control mode. ● Replace with new batteries. ● Point the remote control unit to the remote sensor of the receiver. - [15] ● Connect the components properly referring to "Setting up the system". ● The remote control has not been set to the operation mode for the component you wish to control. Press the source select keys or ϕ SORUCE key to activate the operation mode for the component you want to control before operation. - [40] |

Memory back-up function

If the power supply to the receiver is shut down for about a day or more, the following settings will be reset to the initial conditions. Please be careful.

- Power mode = OFF
- Volume level = - 66 dB
- Dimmer level = OFF (Brightest condition)
- Broadcast band = FM
- Frequency setting = 87.50 MHz
- Tuning mode = AUTO

For the U.S.A.

Note to CATV system installer

This reminder is provided to call the CATV system installer's attention to Article 820-40 of the NEC that provides guidelines for proper grounding and, in particular, specifies that the cable ground shall be connected to the grounding system of the building, as close to the point of cable entry as practical.

For the U.S.A.

FCC WARNING

This equipment may generate or use radio frequency energy. Changes or modifications to this equipment may cause harmful interference unless the modifications are expressly approved in the instruction manual. The user could lose the authority to operate this equipment if an unauthorized change or modification is made.

NOTE:

This equipment has been tested and found to comply with the limits for a Class B digital device, pursuant to Part 15 of the FCC Rules. These limits are designed to provide reasonable protection against harmful interference in a residential installation. This equipment may cause harmful interference to radio communications, if it is not installed and used in accordance with the instructions. However, there is no guarantee that interference will not occur in a particular installation. If this equipment does cause harmful interference to radio or television reception, which can be determined by turning the equipment off and on, the user is encouraged to try to correct the interference by one or more of the following measures:

- Reorient or relocate the receiving antenna.
- Increase the separation between the equipment and receiver.
- Connect the equipment into an outlet on a circuit different from that to which the receiver is connected.
- Consult the dealer or an experienced radio / TV technician for help.

For the U.S.A.



As an ENERGY STAR® Partner, Kenwood Corporation has determined that this products meets the ENERGY STAR® guidelines for energy efficiency. This product can save energy. Saving energy reduces air pollution and lowers utility bills.

Specifications (For U.S.A. and Canada)

AUDIO section

Rated power output during STEREO operation

70 watts per channel minimum RMS, both channels driven, at 8 Ω from 20 Hz to 20 kHz with no more than 0.7% total harmonic distortion. (FTC)

100 watts per channel minimum RMS, both channels driven, at 6 Ω from 20 Hz to 20 kHz with no more than 0.5% total harmonic distortion.

Effective power output during STEREO operation 130 W + 130 W
(1 kHz, 10% T.H.D. at 6 Ω)

Effective power output during SURROUND operation

FRONT 100 W + 100 W
(1 kHz, 0.5% T.H.D. at 6 Ω one channel driven)
130 W + 130 W
(1 kHz, 10% T.H.D. at 6 Ω one channel driven)
CENTER 100 W
(1 kHz, 0.5% T.H.D. at 6 Ω one channel driven)
130 W
(1 kHz, 10% T.H.D. at 6 Ω one channel driven)
SURROUND 100 W + 100 W
(1 kHz, 0.5% T.H.D. at 6 Ω one channel driven)
130 W + 130 W
(1 kHz, 10% T.H.D. at 6 Ω one channel driven)
SURROUND BACK/SUBWOOFER 100 W
(1 kHz, 0.5% T.H.D. at 6 Ω one channel driven)
130 W
(1 kHz, 10% T.H.D. at 6 Ω one channel driven)

Total harmonic distortion 0.09% (1 kHz, 50 W, 6 Ω)

Frequency response (IHF' 66)

DIGITAL IN (DVD, VIDEO 1, VIDEO 2, AUX, GAME)
..... 10 Hz ~ 44 kHz, Sampling frequency 96kHz, +0 dB ~ -3.0 dB

Signal to noise ratio (IHF' 66)

DIGITAL IN (DVD, VIDEO 1, VIDEO 2, AUX, GAME) 96 dB

Input sensitivity / impedance

LINE (DVD, VIDEO 1, VIDEO 2, AUX, FRONT AUX, GAME)
..... 200 mV / 47 k Ω

Output level / impedance

REC OUT 200 mV / 1 k Ω
PRE OUT (SURROUND BACK) 1 V / 1 k Ω
PRE OUT (SUBWOOFER) 1 V / 1 k Ω

Tone control

BASS ± 10 dB (at 100 Hz)
TREBLE ± 10 dB (at 10 kHz)

DIGITAL AUDIO section

Sampling frequency

..... 32 kHz, 44.1 kHz, 48 kHz, 64 kHz, 88.2 kHz, 96 kHz

Input level / impedance / wave length

Optical (VIDEO 1, AUX, GAME)
..... (-15 dBm ~ -24 dBm), 660 nm ± 30 nm
Coaxial (DVD, VIDEO 2) 0.5 Vp-p / 75 Ω

VIDEO section

Input sensitivity / impedance

Composite (DVD, VIDEO 1, VIDEO 2, FRONT AUX, GAME)
..... 1 Vp-p / 75 Ω
S VIDEO (DVD, VIDEO 2)
Luminance signal 1 Vp-p / 75 Ω
Chrominance signal 0.286 Vp-p / 75 Ω
COMPONENT VIDEO (DVD, VIDEO 2)
Luminance signal 1 Vp-p / 75 Ω
Cb/Cr-signal 0.64 Vp-p / 75 Ω

Output level / impedance

Composite (VIDEO 1, MONITOR OUT) 1 Vp-p / 75 Ω
S VIDEO (MONITOR OUT)
Luminance signal 1 Vp-p / 75 Ω
Chrominance signal 0.286 Vp-p / 75 Ω
COMPONENT VIDEO (MONITOR OUT)
Luminance signal 1 Vp-p / 75 Ω
Cb/Cr-signal 0.64 Vp-p / 75 Ω

FM tuner section

Tuning frequency range 87.5 MHz ~ 108 MHz

Usable sensitivity (MONO)

..... 1.3 μ V (75 Ω) / 13.2 dBf (75 kHz dev, SINAD 30 dB)

50 dB quieting sensitivity

STEREO 28 μ V (75 Ω) / 40.2 dBf (75 kHz dev)

Total harmonic distortion (1 kHz)

MONO 0.5% (71.2 dBf input)
STEREO 0.7% (71.2 dBf input)

Signal to noise ratio (1 kHz)

MONO 75 dB (71.2 dBf input)
STEREO 68 dB (71.2 dBf input)

Selectivity (± 400 kHz) 70 dB

Stereo separation (1 kHz) 40 dB

Frequency response (30 Hz ~ 15kHz) +0.5 dB, -3.0 dB

AM tuner section

Tuning frequency range 530 kHz ~ 1,700 kHz

Usable sensitivity (30% mod, S/N 20 dB) 16 μ V / (600 μ V/m)

Signal to noise ratio (30% mod, 400 Hz)
..... 50 dB (60 dB μ V EMF input)

GENERAL

Power consumption 85 W

Standby power consumption 0.2 W

Dimensions W: 440 mm (17-5/16")

H: 79 mm (3-1/8")

D: 364 mm (14-5/16")

Weight (Net) 4.4 kg (9.7 lb)

Notes

- 1.KENWOOD follows a policy of continuous advancements in development. For this reason specifications may be changed without notice.
- 2.The full performance may not be exhibited in an extremely cold location (under a water-freezing temperature).

Specifications (For Europe and Australia)

AUDIO section

For Europe

Rated power output during STEREO operation 100 W + 100 W
DIN/IEC (20 Hz ~ 20 kHz, 0.7% T.H.D. at 6 Ω)
Effective power output during STEREO operation ... 130 W + 130 W
(1 kHz, 10% T.H.D. at 6 Ω)

For Australia

Rated power output during STEREO operation

70 watts per channel minimum RMS, both channels driven,
at 8 Ω from 20 Hz to 20 kHz with no more than 0.7% total
harmonic distortion. (FTC)

Rated power output during STEREO operation .. 100 W + 100 W
DIN/IEC (20 Hz ~ 20 kHz, 0.7% T.H.D. at 6 Ω)
Effective power output during STEREO operation ... 130 W + 130 W
(1 kHz, 10% T.H.D. at 6 Ω)

Effective power output during SURROUND operation

FRONT 100 W + 100 W
(1 kHz, 0.5% T.H.D. at 6 Ω one channel driven)
130 W + 130 W
(1 kHz, 10% T.H.D. at 6 Ω one channel driven)
CENTER 100 W
(1 kHz, 0.5% T.H.D. at 6 Ω one channel driven)
130 W
(1 kHz, 10% T.H.D. at 6 Ω one channel driven)
SURROUND 100 W + 100 W
(1 kHz, 0.5% T.H.D. at 6 Ω one channel driven)
130 W + 130 W
(1 kHz, 10% T.H.D. at 6 Ω one channel driven)
SURROUND BACK/SUBWOOFER 100 W
(1 kHz, 0.5% T.H.D. at 6 Ω one channel driven)
130 W
(1 kHz, 10% T.H.D. at 6 Ω one channel driven)
Total harmonic distortion 0.09% (1 kHz, 50 W, 6 Ω)
Frequency response (IHF' 66)
DIGITAL IN (DVD, VIDEO 1, VIDEO 2, AUX, GAME)
..... 10 Hz ~ 44 kHz, Sampling frequency 96kHz, +0 dB ~ -3.0 dB
Signal to noise ratio (IHF' 66)
DIGITAL IN (DVD, VIDEO 1, VIDEO 2, AUX, GAME) 96 dB
Input sensitivity / impedance
LINE (DVD, VIDEO 1, VIDEO 2, AUX, FRONT AUX, GAME)
..... 200 mV / 47 kΩ
Output level / impedance
REC OUT 200 mV / 1 kΩ
PRE OUT (SURROUND BACK) 1 V / 1 kΩ
PRE OUT (SUBWOOFER) 1 V / 1 kΩ
Tone control
BASS ±10 dB (at 100 Hz)
TREBLE ±10 dB (at 10 kHz)

DIGITAL AUDIO section

Sampling frequency

..... 32 kHz, 44.1 kHz, 48 kHz, 64 kHz, 88.2 kHz, 96 kHz

Input level / impedance / wave length

Optical (VIDEO 1, AUX, GAME)
..... (-15 dBm ~ -24 dBm), 660 nm ±30 nm
Coaxial (DVD, VIDEO 2) 0.5 Vp-p / 75 Ω

VIDEO section

Input sensitivity / impedance

Composite (DVD, VIDEO 1, VIDEO 2, FRONT AUX, GAME)
..... 1 Vp-p / 75 Ω
S VIDEO (DVD, VIDEO 2)
Luminance signal 1 Vp-p / 75 Ω
Chrominance signal 0.286 Vp-p / 75 Ω
COMPONENT VIDEO (DVD, VIDEO 2)
Luminance signal 1 Vp-p / 75 Ω
Cb/Cr-signal 0.7 Vp-p / 75 Ω

Output level / impedance

Composite (VIDEO 1, MONITOR OUT)
..... 1 Vp-p / 75 Ω
S VIDEO (MONITOR OUT)
Luminance signal 1 Vp-p / 75 Ω
Chrominance signal 0.286 Vp-p / 75 Ω
COMPONENT VIDEO (MONITOR OUT)
Luminance signal 1 Vp-p / 75 Ω
Cb/Cr-signal 0.7 Vp-p / 75 Ω

FM tuner section

Tuning frequency range 87.5 MHz ~ 108 MHz
Usable sensitivity (DIN at 75 Ω)
MONO 1.3 μV / 13.2 dBf (40 kHz dev, S/N 26 dB)
STEREO 45 μV / 42.1 dBf (40 + 6 kHz dev, S/N 46 dB)
Total harmonic distortion (DIN at 1 kHz)
MONO 0.2% (71.2 dBf input)
STEREO 0.8% (71.2 dBf input)
Signal to noise ratio (DIN weighted at 1 kHz)
MONO 65 dB (71.2 dBf input)
STEREO 60 dB (71.2 dBf input)
Selectivity (DIN ±300 kHz) 64 dB
Stereo separation (1 kHz) 36 dB
Frequency response (30 Hz ~ 15kHz) +0.5 dB, -3.0 dB

AM tuner section

Tuning frequency range 531 kHz ~ 1,602 kHz
Usable sensitivity (30% mod, S/N 20 dB) 16 μV / (600 μV/m)
Signal to noise ratio (30% mod, 400 Hz)
..... 50 dB (60 dBμ V EMF input)

GENERAL

Power consumption 85 W
Standby power consumption 0.2 W
Dimensions W: 440 mm (17-5/16")
H : 79 mm (3-1/8")
D : 364 mm (14-5/16")
Weight (Net) 4.4 kg (9.7 lb)

Notes

1. KENWOOD follows a policy of continuous advancements in development. For this reason specifications may be changed without notice.
2. The full performance may not be exhibited in an extremely cold location (under a water-freezing temperature).

KENWOOD

For your records

Record the serial number, found on the back of the unit, in the spaces designated on the warranty card, and in the space provided below. Refer to the model and serial numbers whenever you call upon your dealer for information or service on this product.

Model _____ Serial Number _____

Free Manuals Download Website

<http://myh66.com>

<http://usermanuals.us>

<http://www.somanuals.com>

<http://www.4manuals.cc>

<http://www.manual-lib.com>

<http://www.404manual.com>

<http://www.luxmanual.com>

<http://aubethermostatmanual.com>

Golf course search by state

<http://golfingnear.com>

Email search by domain

<http://emailbydomain.com>

Auto manuals search

<http://auto.somanuals.com>

TV manuals search

<http://tv.somanuals.com>