

KENWOOD

COMPONENT SYSTEM/COMPACT HI-FI SYSTEM

XD-750

XD-700

XD-550

XD-500

INSTRUCTION MANUAL

KENWOOD CORPORATION

This instruction manual is used for four models.
Model availability and features (functions) may differ depending on the country and sales area.

COMPACT
disc
DIGITAL AUDIO

B60-2915-00 (S) (T) (MC)
98/12 11 10 9 8 7 6 5 4 3 2 1 97/12 11 10 9 8 7 6 5 4 3 2 1

Before applying power

 **Caution : Read this page carefully to ensure safe operation.**

XD-750/700/550/500 (En)

Units are designed for operation as follows.

Europe and U.K. AC 230 V only

For the United Kingdom

Factory fitted moulded mains plug

1. The mains plug contains a fuse. For replacement, use only a 13-Amp ASTA-approved (BS1362) fuse.
2. The fuse cover must be refitted when replacing the fuse in the moulded plug.
3. Do not cut off the mains plug from this equipment. If the plug fitted is not suitable for the power points in your home or the cable is too short to reach a power point, then obtain an appropriate safety approved extension lead or adapter, or consult your dealer. If nonetheless the mains plug is cut off, remove the fuse and dispose of the plug immediately, to avoid a possible shock hazard by inadvertent connection to the mains supply.

IMPORTANT: The wires in the mains lead are coloured in accordance with the following code:





Blue : Neutral
Brown : Live

Do not connect those leads to the earth terminal of a three-pin plug.

Preparation section

Safety precautions

WARNING : TO PREVENT FIRE OR ELECTRIC SHOCK, DO NOT EXPOSE THIS APPLIANCE TO RAIN OR MOISTURE.

	<p>CAUTION RISK OF ELECTRIC SHOCK DO NOT OPEN</p>		<p>CAUTION: TO REDUCE THE RISK OF ELECTRIC SHOCK, DO NOT REMOVE COVER (OR BACK). NO USER-SERVICEABLE PARTS INSIDE, REFER SERVICING TO QUALIFIED SERVICE PERSONNEL.</p>
	<p>THE LIGHTNING FLASH WITH ARROWHEAD SYMBOL, WITHIN AN EQUILATERAL TRIANGLE, IS INTENDED TO ALERT THE USER TO THE PRESENCE OF UNINSULATED "DANGEROUS VOLTAGE" WITHIN THE PRODUCT'S ENCLOSURE THAT MAY BE OF SUFFICIENT MAGNITUDE TO CONSTITUTE A RISK OF ELECTRIC SHOCK TO PERSONS.</p>		
	<p>THE EXCLAMATION POINT WITHIN AN EQUILATERAL TRIANGLE IS INTENDED TO ALERT THE USER TO THE PRESENCE OF IMPORTANT OPERATING AND MAINTENANCE (SERVICING) INSTRUCTIONS IN THE LITERATURE ACCOMPANYING THE APPLIANCE.</p>		

REQUIREMENT BY NEDERLAND GAZETTE

Batteries are supplied with this product. When they empty, you should not throw away. Instead, hand them in as small chemical waste.

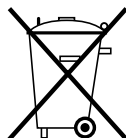



The marking of products using lasers (Except for some areas)



The marking is located on the rear panel and says that the component uses laser beams that have been classified as Class 1. It means that the unit is utilizing laser beams that are of a weaker class. There is no danger of hazardous radiation outside the unit.

Contents

Preparation section

 Before applying power	2
 Safety precautions	2
Contents	3
Special features	4
Handling of discs and tapes	5
System connection	6
Connection of the System Accessories	6
Connection of Options (Optional Parts)	8
Controls and indicators	10
Main Unit	10
Display	12
Remote control Unit	13
Operation of remote control unit	14

Basic section

Let's put out some sound	16
Basic use method	16
Playback of CD	18
Playback of tape	20
Searching for the desired music program (DPSS) ..	23
Receiving broadcast station	24
Let's record	26
Recording (Deck B only)	26
Copying tape (Tape dubbing)	29

Application section

Playback of CD	30
Listening in the desired sequence (program playback)	30
Repeated playback	32
Listening to an unexpected title sequence (random playback)	34
R.D.S. (Radio Data System)	35
Searching for a desired program type (PTY search)	36
To be able to listen to the desired information at any time	38
Convenient CD recording	40
Selection of the convenient CD recording type	40
Giving preference to the tape length over the title sequence (time edit recording)	41
Recording only desired titles (ONE TOUCH EDIT.....single title recording)	42
One-touch recording of an entire CD (ONE TOUCH EDIT.....recording of all titles)	43
Producing a tape collecting only the first titles (BEST HITS function)	44
Effective Sound Adjustment	45
Adjustment of balance and input level	45
Listening with the desired sound (equalizer function)	46
Enjoying Sound Field Effects	48
Enjoying Karaoke	49
Clock adjustment	50
Timer operation	51
Timer programming	52

Knowledge section

Important Items	55
Maintenance	55
Reference	55
In case of difficulty	56
Specifications	59



Special features

Easy operation

Playback, recording and input selection can be performed with simplified operations.

Dynamic rotary volume control

When adjusting the volume, fast turning of the volume control produces a larger volume change for the same angle of rotation of the **VOLUME (MULTI) CONTROL** knob. Slow turning produces a small volume change, thus permitting fine adjustment.

3-Disc carousel CD player

→ 18

Three discs can be set. There are various ways for enjoyment at the time of program playback, repeat playback, random playback, etc.

One-touch edit

→ 42 → 43

One-touch recording of only a single title or the entire CD is possible while listening to a CD.

R.D.S. (Radio Data System)

→ 35

The RDS data included in FM broadcasts can be used to search for the intended broadcasting contents and for automatic reception from standby.

Versatile tone and sound field adjustment

→ 45

Equalizer patterns can not only be selected from preset patterns, but patterns also can be created and registered. It is possible to recreate a feeling of presence and to recreate a sound field.

Karaoke also can be enjoyed.

→ 49

When the HIT MASTER function is used with mic mixing, normal CDs and tapes with voice recorded on them can be used as Karaoke software.

Simple operation timer

→ 51

Wake-up timer and sleep timer setting is simple. There are also two types of program timers operating every day.

Unpacking

Unpack the unit carefully and make sure that all accessories are put aside so they will not be lost.

Examine the unit for any possibility of shipping damage. If your unit is damaged or fails to operate, notify your dealer immediately. If your unit was shipped to you directly, notify the shipping company without delay. Only the consignee (the person or company receiving the unit) can file a claim against the carrier for shipping damage.

We recommend that you retain the original carton and packing materials for use should you transport or ship the unit in the future.

Accessories

FM indoor antenna (1)

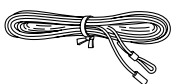

Speaker cords (2)

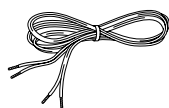

AM loop antenna (1)

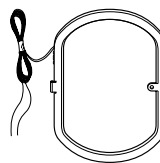

Loop antenna stand (1)

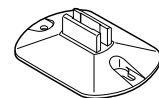

Remote control unit (1)



Batteries (R6/AA) (2)

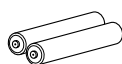

Handling of discs and tapes

Disc handling precautions

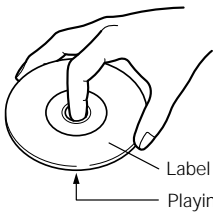

Handling

Hold compact discs so that you do not touch the playing surface.

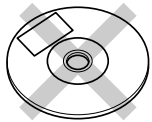

Do not attach paper or tape to either the playing side or the label side of compact discs.

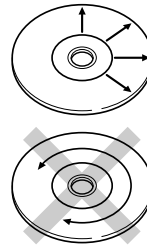

Cleaning

If fingerprints or foreign matter become attached to the disc, lightly wipe the disc with a soft cotton cloth (or similar) from the center of the disc outwards in a radial manner.

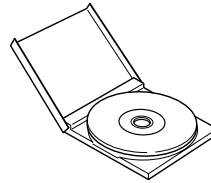

Storage

When a disc is not to be played for a long period of time, remove it from the CD player and store it in its case.

Caution on disc used

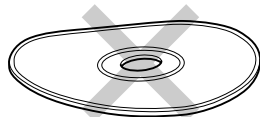
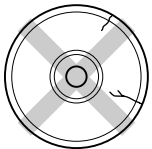

Never play cracked or warped disc.

During playback, the disc rotates at high speed in the player. Therefore, to avoid malfunction, never use a cracked or deformed disc or a disc repaired with tape or adhesive agent.

Discs which can be played with this unit

CD (12 cm, 8 cm), CDV (only the audio part)

± With CD-G (CD Graphics) discs, this unit can play only the audio.

Notes on cassette tape

Safety tab (accidental erasure prevention tab)

After an important recording has been finished, break the safety tab, to prevent the recorded contents from being erased or recorded on accidentally.

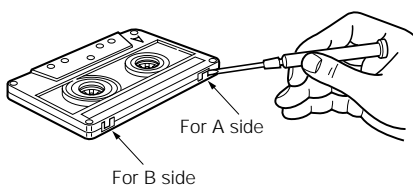

To store cassette tapes

Do not store the tapes in a place which is subject to direct sunlight, or near equipment that generates heat. Keep the cassette tapes away from any magnetic field.

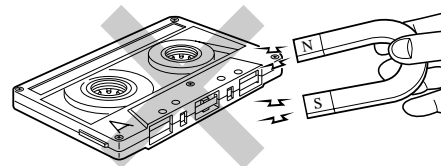

When there is slack in the tape

In such a case, insert a pencil into the reel hole and wind the reel hub to remove the slack.

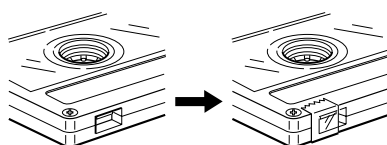
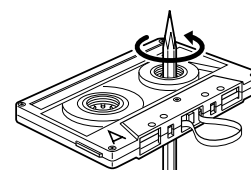

To re-record

Apply tape only to the position where the tab has been removed.



1. Longer tape than 110 minutes cassette tape

Since longer tape than 110 minutes cassette tape is very thin, the tape could adhere to the pinch roller or be easily cut. It is recommended that these tapes not be used with this unit to prevent possible damage.

2. Endless tapes

Do not use an endless tape, as this could damage the mechanism of the unit.

Connection of the System Accessories

Malfunction of microcomputer

If operation is not possible or erroneous display appears even though all connections have been made properly, reset the microcomputer referring to "In case of difficulty".



→ 56

This is the connection method for system and accessories. Please look carefully at the illustration and connect correctly in the order of the numbers.

AM loop antenna

The supplied antenna is for indoor use. Place it as far as possible from the main system, TV set, speaker cords and power cord, and set it to a direction which provides the best reception.

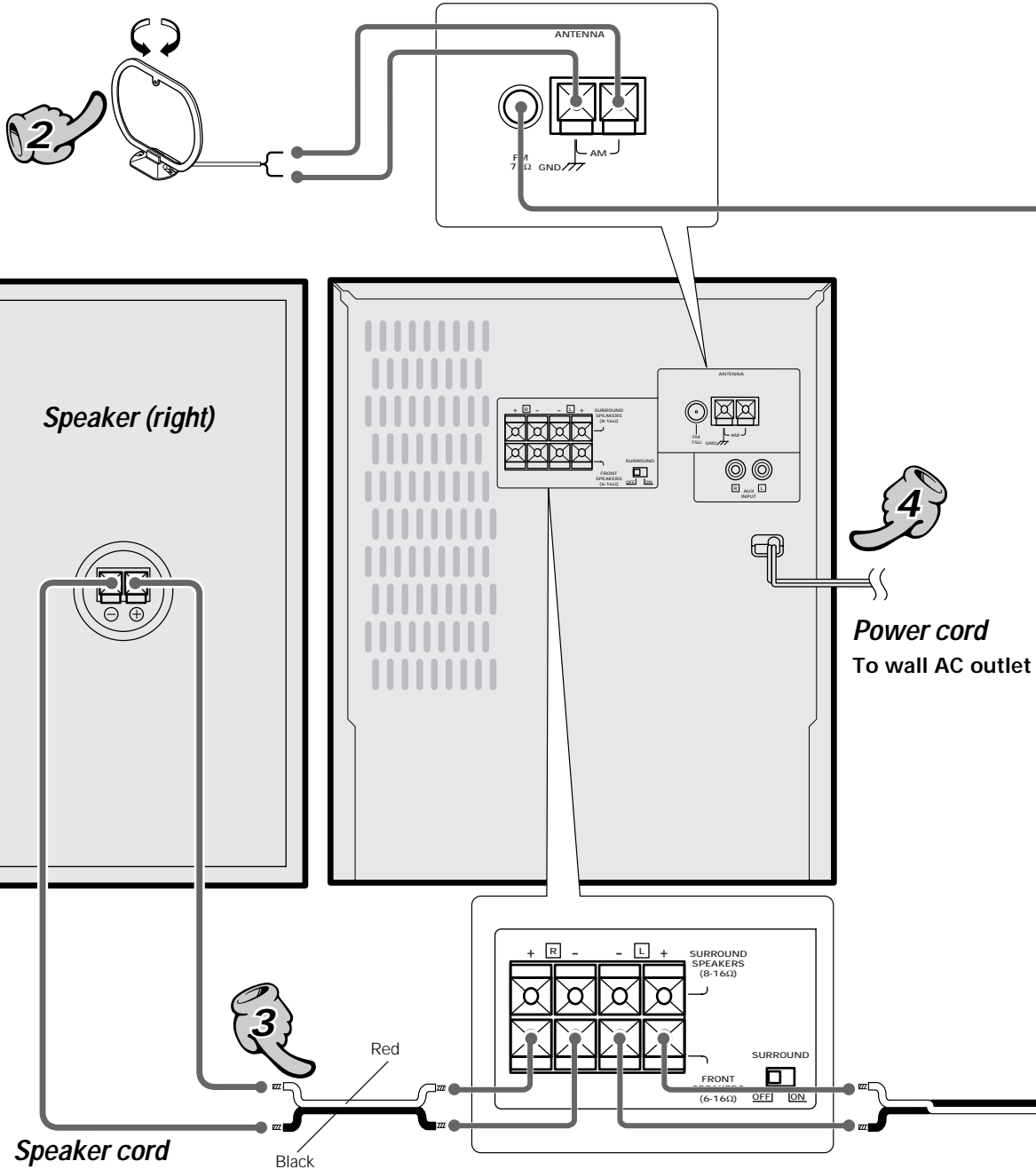

Main Unit

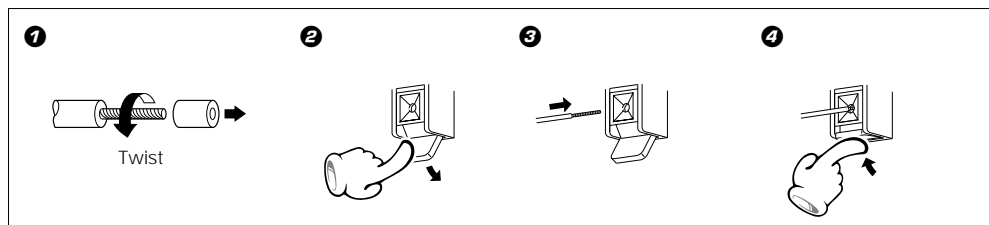

Caution regarding placement

To maintain proper ventilation, be sure to leave a space around the unit (from the largest outer dimensions including projections) equal to, or greater than, shown below.

left and right panels: 10 cm, rear panel: 10 cm, top panel: 50 cm

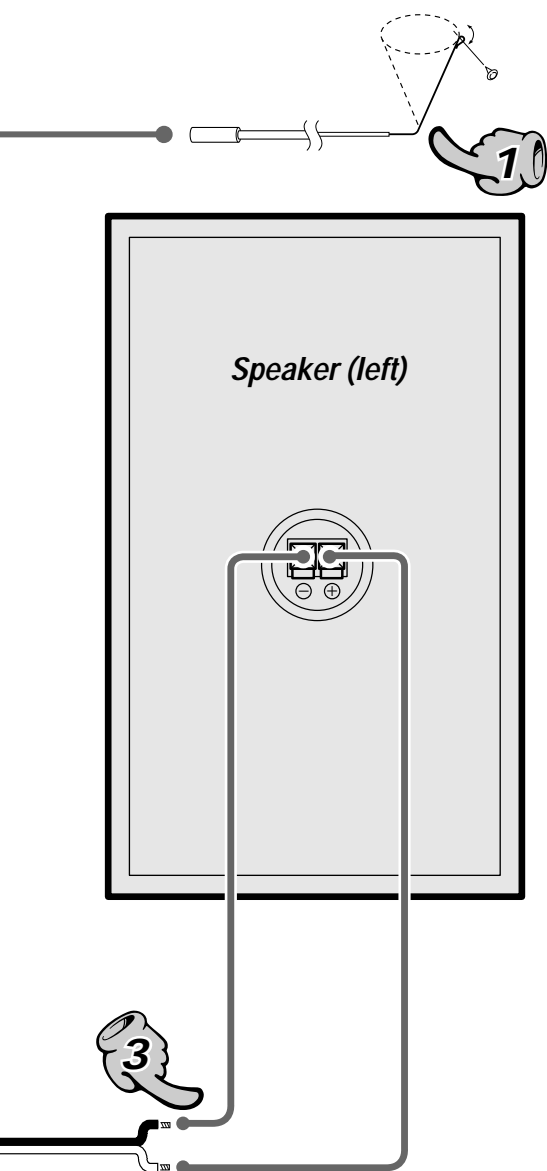

FM indoor antenna

The accessory antenna is for temporary indoor use only. For stable signal reception we recommend using an outdoor antenna. Remove the indoor antenna if you connect one outdoors.

- 1 Locate the position providing good reception condition.
- 2 Fix the antenna.

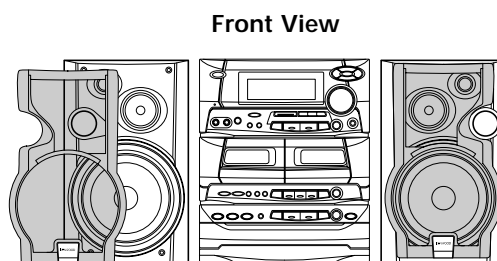

The external view is variable depending on the model and marketing destination type.

Speaker Unit

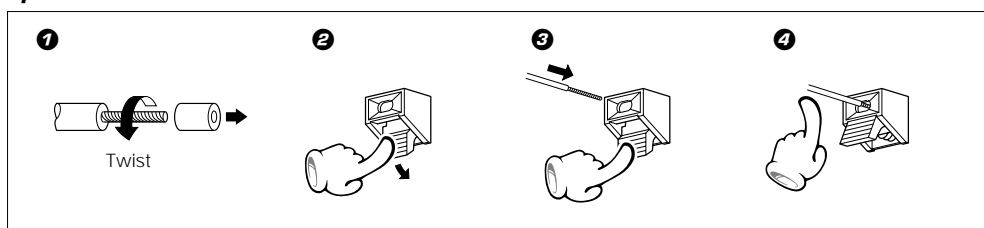

- 1. In case an associated system component is connected, also read the instruction manual of the component.
- 2. Never short-circuit the + and - speaker cords.
- 3. If the left and right speaker connections or the + and - polarity are inverted, the sound will be unnatural with unclear positioning of musical instruments, etc. Be sure to connect them without mistake.



- 1. Be sure to insert all connection cords securely. If their connections are imperfect, the sound may not be produced or noise may interfere.
- 2. Before plugging or unplugging a connection cord, be sure to unplug the power cord from the wall AC outlet. If connection cords are plugged or unplugged with the power cord left plugged in, malfunction or damage may result.

Connection of Options (Optional Parts)

Connect separately sold parts as shown in the figure.
Do not plug the power cord into the power outlet until all of the required connections have been made.

In regard to the SURROUND switch

This switch can be used only when the separately sold surround (rear) speakers are connected. When the switch is set to ON, surround playback can be enjoyed. When this switch is set to OFF, normal playback is executed.

- + Please operate this switch while the power is switched off.
- + We recommend to keep this switch set to OFF when no surround (rear) speakers are connected to obtain a better sound quality.
- + When the switch is set to OFF, no sound will come from the surround (rear) speakers.

Speaker Unit

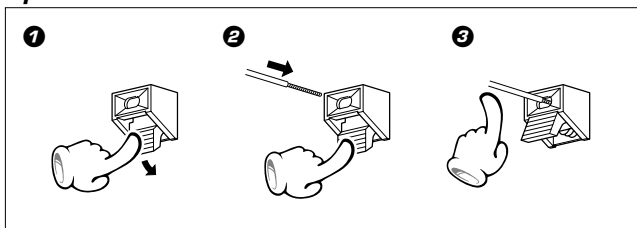

Surround (rear) speakers (RS-N700/N750)

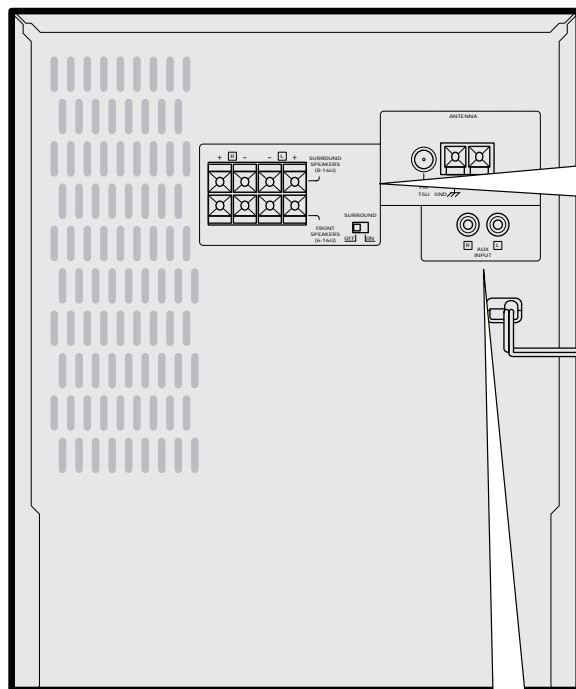
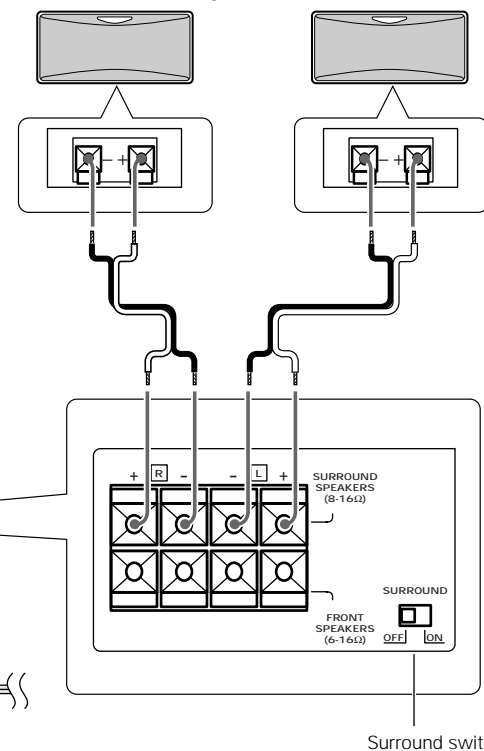

Monitor TV

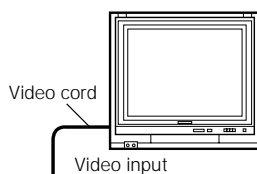

Video output

Video deck

Audio output

Main Unit

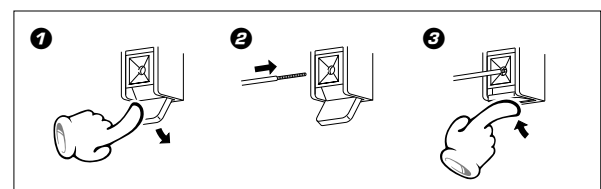

FM outdoor antenna

Lead the 75Ω coaxial cable connected to the FM outdoor antenna into the room and connect it to the FM 75Ω terminal.

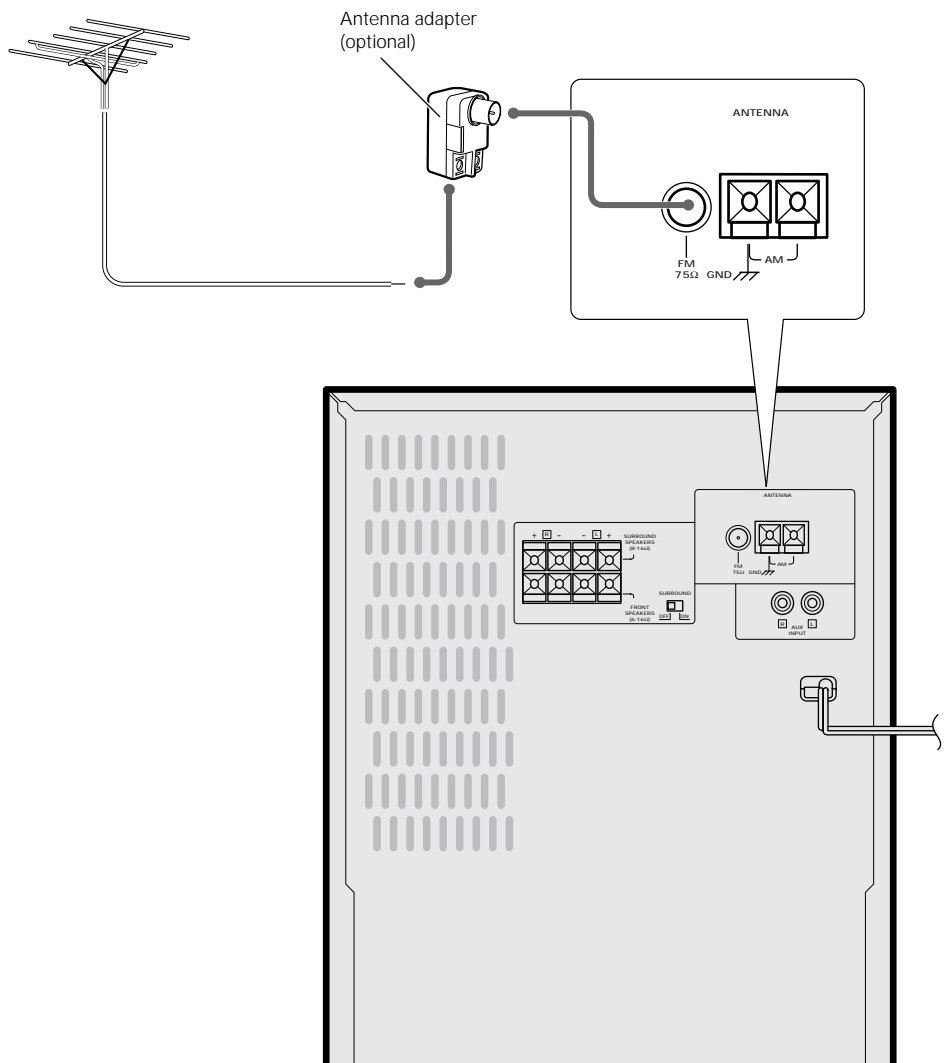

Main Unit

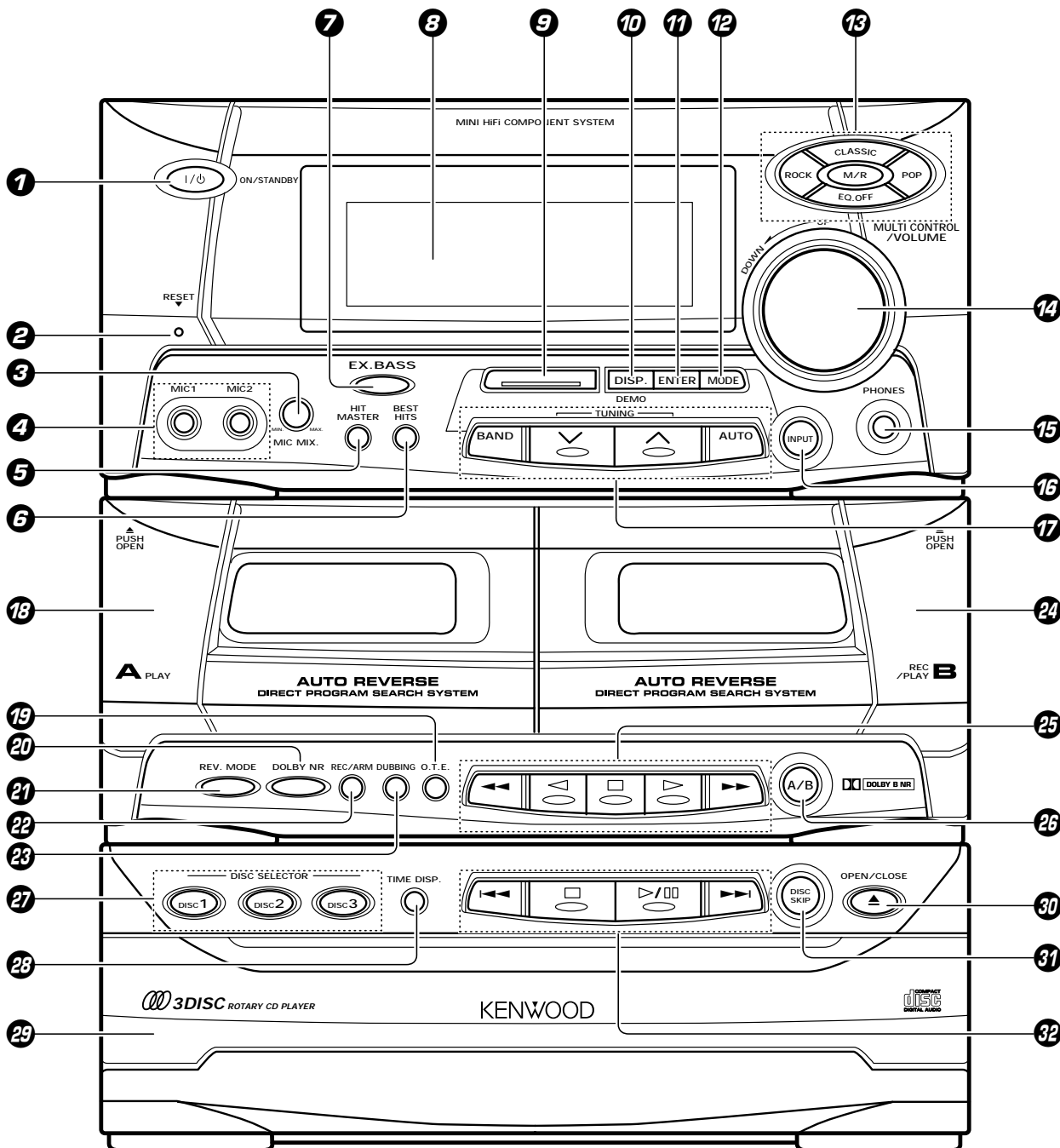

Preparation section

Receiver

- 1 ON/STANDBY (I / ⏻) key** → 16
Power ON/OFF switching is executed.
- 2 RESET key** → 56
Press to reset the microcomputer built in the system.
- 3 MIC MIX. knob** → 49
At the time of mic mixing, this knob controls the volumes of the microphones.
- 4 MIC 1, MIC 2 terminal** → 49
For connection of a microphone (optional).
- 5 HIT MASTER key** → 49
Used in karaoke singing, etc.
- 6 BEST HITS key** → 17 → 44
When power is ON: Records the first tracks of all of the CDs stored in the unit.
When power is STANDBY: Switches the auto power-save mode on and off.
- 7 EX. BASS (Extra bass) key** → 17 → 52
When power is ON: Switches the extra bass play on and off.
When power is STANDBY: Used in the timer setting operation.
- 8 DISPLAY** → 12
- 9 SRS 3D key/Indicator (XD-750/XD-700)** → 48 → 53
When power is ON: Switches the SRS 3D play on and off.
When power is STANDBY: Used in the timer setting operation.
SOURCE DIRECT key/Indicator (XD-550, XD-500) → 48 → 53
When power is ON: Press to turn the Source Direct play on and off.
When power is STANDBY: Used in timer setting operations.
- 10 DISP. / DEMO key** → 46
When power is ON: Switches the displayed information.
Switches the demonstration on and off.

When power is STANDBY: Switches the demonstration on and off.

- 11 ENTER key** ∞ → 50
Used for time setting, timer setting, etc.
- 12 MODE key** → 45 → 51
When power is ON: This key switches the function of the **MULTI CONTROL/VOLUME** knob. The items which can be selected differ according to the status at that time.
When power is STANDBY: This key is used in the OTT timer setting.
- 13 Equalizer operation keys** → 46 → 47
The equalizer effect is switched ON/OFF and the type of equalizer effect is selected.
- 14 MULTI CONTROL/VOLUME knob** → 16
Normally this is used for volume adjustment. Depending on the purpose, the function can be switched with the **MODE** key.
- 15 PHONES terminal** → 17
For connection of a headphone (optional).
- 16 INPUT key** → 16
Press to select the input source. When TAPE or CD is selected, playback starts automatically provided that a tape or disc has already been loaded.
- 17 Tuner operation keys** → 24
AUTO key
When power is ON: Switches the tuning mode.
When power is STANDBY: Used in the clock adjustment.
TUNING keys
Press to select a radio station.
BAND key
Press to switch the receiving band.

Cassette deck unit

- 18 A deck cassette holder**
Press the area marked **PUSH OPEN** to load or eject a tape.
- 19 O.T.E. key** → 40
When this key is pressed during CD playback, only the title being played at that time will be recorded on tape. When this key is pressed during stop, the CD selected at that time will be recorded on tape from the first title onward.
- 20 DOLBY NR key** → 21
Dolby noise reduction ON/OFF switching is executed.
- 21 REV. MODE key** → 21
The reverse mode of the deck (both sides, repeated, one side) is switched.
- 22 REC/ARM key** → 27
Press to start recording. Pressing the key during recording stops it after leaving a non-recorded space (blank) of about 4 seconds.
- 23 DUBBING key** → 29
The contents of the tape of the A deck are copied to the tape of the B deck.
- 24 B deck cassette holder**
Press the area marked **PUSH OPEN** to load or eject a tape.
- ∞ **Cassette deck operation keys**
Play (◀▶) keys
Stop (■) key
Fast forward and rewind (◀◀▶▶) keys
- 25 A/B key** → 20 → 28
Press to select the deck to be operated. Used as the beat cancel key during recording of AM broadcasting.

CD player unit

- 27 DISC SELECTOR key** → 19
The disc for playback (or recording) is selected.
- 28 TIME DISP. (Time display) key** → 18
Press to switch the CD time display information.
- 29 Disc tray** → 18
Three discs can be stored.
- 30 OPEN/CLOSE (▲) key** → 18
The disc tray is opened and closed.
- 31 DISC SKIP key** → 19
The disc for playback (or recording) is selected. This is also used for insertion of a CD to the inside of the disc tray.
- 32 CD operation keys** → 18
Play/pause (▶/||) key
Stop (■) key
Skip (◀◀▶▶) keys

Display

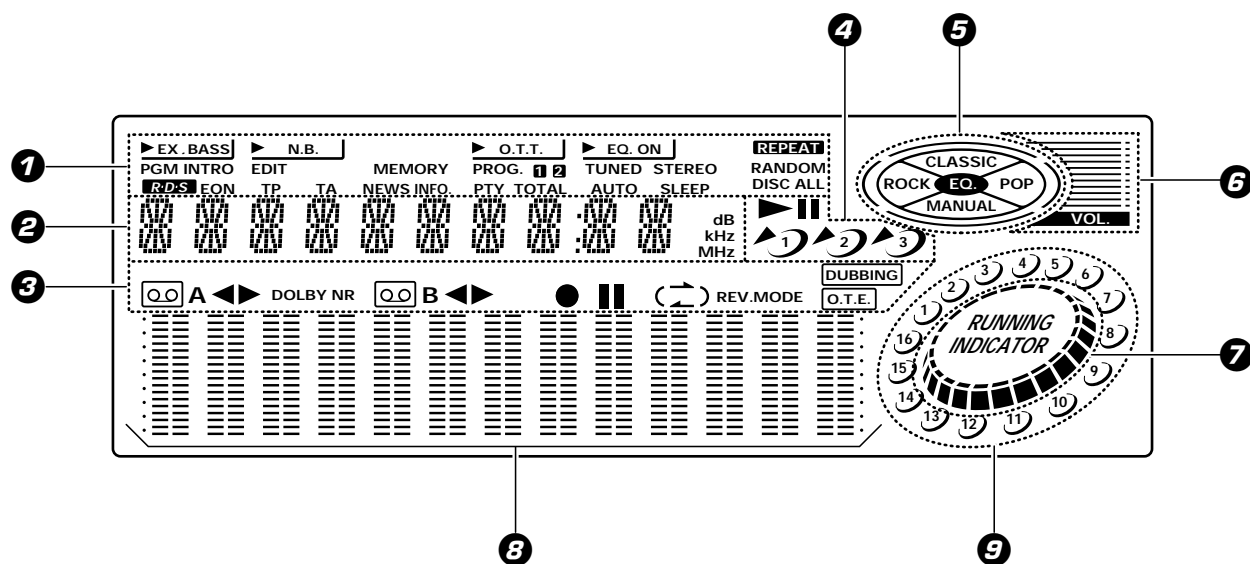

1 Tuner and applied operation indicators

This section contains the indicators of the tuner operations as well as applied CD operation and timer play information.

2 Character display

Displays the input selection, frequency, volume level, etc.

3 Cassette deck indicators

This section contains the cassette deck operation indicators. The indicated information includes the current selected deck (A or B), tape transport direction, etc.

4 CD player indicators

This section displays the CD playback and pause mode information as well as the disc number being played.

5 Equalizer indicators

This section shows the equalizer pattern in use.

6 Volume display

This section shows the currently set volume level.

7 RUNNING INDICATOR

This indicator blinks according to the operation modes during operation of the CD player, tape decks, etc.

8 Spectrum analyzer display

9 Track number indicator

Indicates the CD track number being played.

Remote control Unit

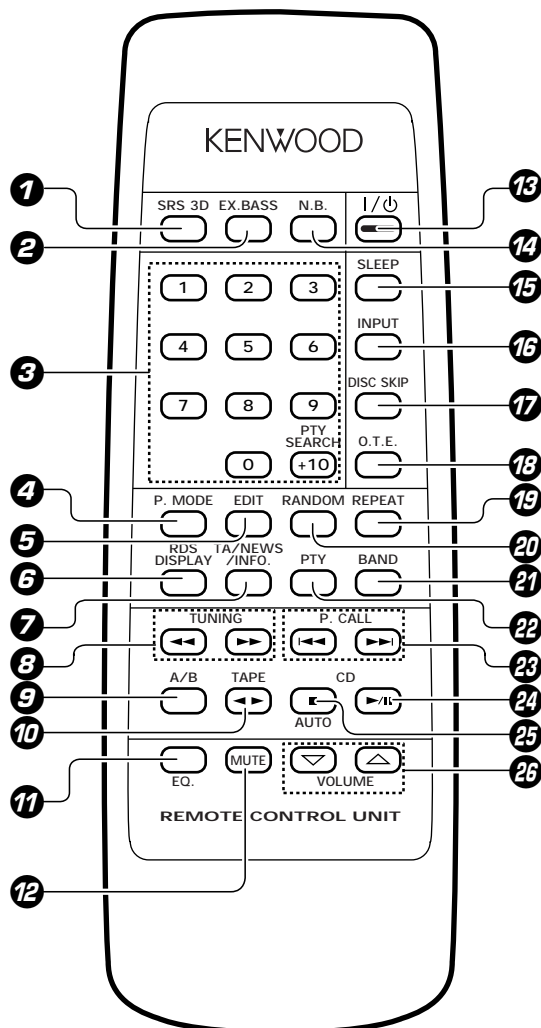

- ➊ **SRS 3D key (XD-750/XD-700 only)** → 48 → 53
Press to switch SRS 3D on and off.
- ➋ **EX.BASS (Extra bass) key** → 17 → 52
- ➌ **Numeric keys** → 19
Used as number keys when the input is switched to CD.
The **PTY SEARCH** key is used when searching the programme type of RDS broadcasting.
- ➍ **P.MODE key** → 30
Used to program the CD playback sequence.
- ➎ **EDIT key** → 41
Used for CD edit recording (time edit recording).
- ➏ **RDS DISPLAY key** → 35
The display contents are switched during reception of RDS broadcasts.
- ➐ **TA/NEWS/INFO. key** → 0
Used for automatic reception of transmissions of a certain content.
- ➑ **TUNING (◀▶) keys**
- ➒ **A/B key** → 20 → 28
- ➓ **Cassette deck operation key** → 20
- ➔ **EQ. (Equalizer) key** → 46
Press to switch the equalizer effect on and off or to select an equalizer pattern. Each press changes the selection in sequence.
- ➕ **MUTE key** → 17
This is used to mute the sound temporarily.
- ➖ **On/Standby (I / ⏻) key** → 16
- ➗ **N.B. key** → 17
Press to compensate for the heavy low frequencies.
- ➘ **SLEEP key** → 51
Use to set the sleep timer.
- ➙ **INPUT key** → 16
- ➚ **DISC SKIP key** → 19
- ➛ **O.T.E. key** → 40
- ➜ **REPEAT key** → 32
Used for repeated playback of a CD.
- ➝ **RANDOM key** → 34
For CD playback, switching is executed between introduction scanning, random playback, and normal playback.
- ➞ **BAND key** → 24
- ➟ **PTY key** → 36
This is used to specify the program type when searching for a station.
- ➠ **P.CALL (Preset Call) (◀◀▶▶) keys**
- ➡ **CD play/pause (▶/⏸) key**
- **AUTO (■) key**
- ➣ **VOLUME keys** → 16
This has the same function as the **MULTI CONTROL/VOLUME** knob on the main unit. However, the AI VOLUME function does not operate.

Loading batteries

❶ Remove the cover.

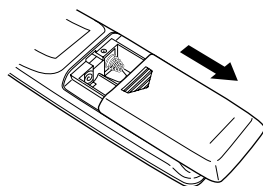

❷ Insert batteries.

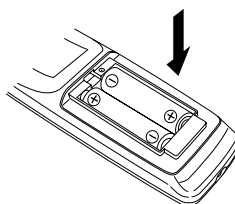

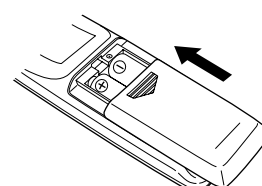

❸ Close the cover.



+ Insert two R6 ("AA"-size) batteries following the polarity indications.

Operation

Plug the power cord into the mains power outlet and press the  (on/standby) key of the remote control unit to turn power ON. After the power has been turned ON, press the desired key.

To turn power off, press the  (on/standby) key again. The system enters the standby mode in which only the time display is lit.

+ When pressing more than one remote control keys successively, press the keys securely by leaving an interval of 1 second or more between keys.

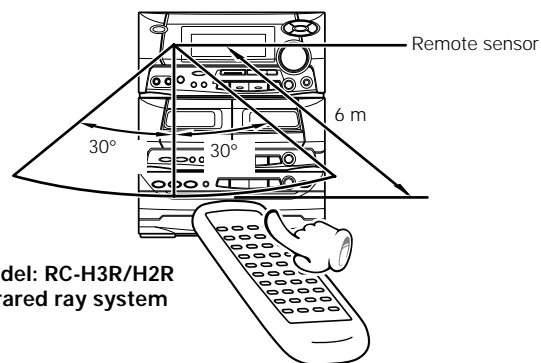

Model: RC-H3R/H2R
Infrared ray system

Operating range (approx.)



1. The provided batteries are intended for use in operation checking, and their service life may be short.
2. When the remote controllable distance becomes short, replace both of the batteries with new ones.
3. If direct sunlight or the light of a high-frequency fluorescent lamp (inverter type, etc.) is incident to the remote sensor, malfunction may occur. In such a case, change the installation position to avoid malfunction.



Basic use method

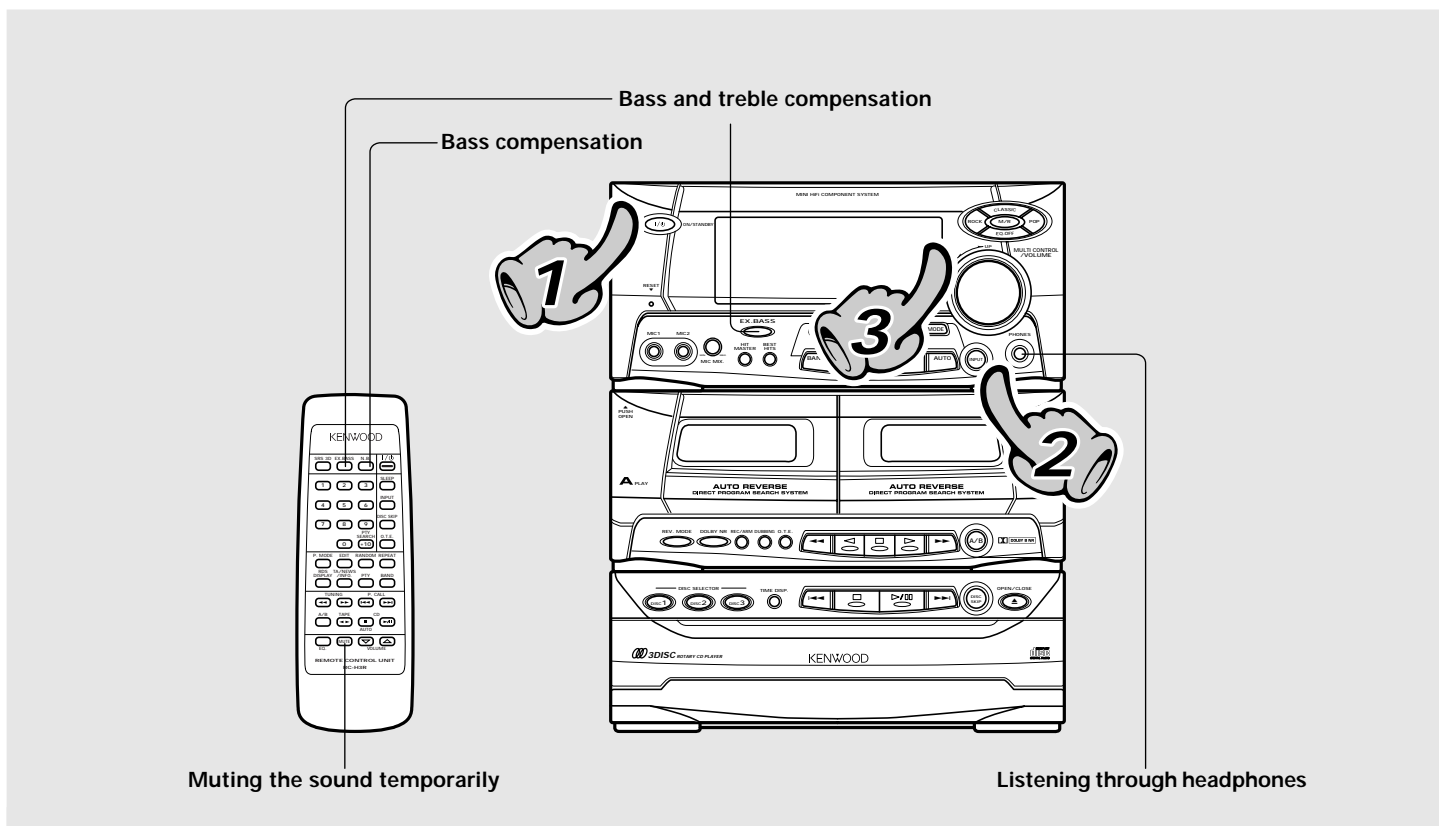

Basic section

Press the ON/STANDBY key.

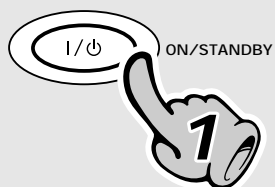

1. Switching the power ON (OFF)

The power can also be turned ON by pressing the play key of the CD player, the play key of the cassette deck or the BAND key of the tuner.
When the ON/STANDBY key is pressed while the power is ON, the power will be switched OFF.

+ The display part becomes dark when the power is switched OFF. (DIMMER function)

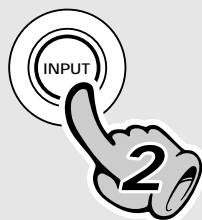

2. Selecting the desired output

- CD → 18
- Tape → 20
- Broadcasts → 24

+ When you select the AUX input, be also sure to read the instruction manual of the component connected to the AUX input jacks.
+ When CD or TAPE is selected, playback will start when a disc or a tape already has been inserted.

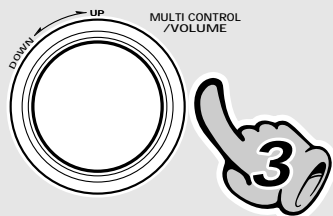

3. Volume adjustment

+ Quick turning produces a larger change amount.
(Dynamic rotary volume control function)
+ The display shows a reference value.

Muting the sound temporarily (Remote control unit only)

Remote control unit

Blinks

± Press again to resume the original volume.
± The sound muting is also canceled when the volume is controlled.

Bass compensation (N.B.: Natural Bass circuit) (Remote control unit only)

Remote control unit

Lights

Each press of the key switches the setting.

- ① NB The low frequencies are compensated according to the current volume level. (Effective for low-level listening)
- ② NB 2 The low frequencies are compensated regardless of the volume level.
- ③ NB OFF (N.B. deactivated)

Listening through headphones

① Insert the headphone plug into the PHONES jack.

± The sounds from all speakers are cut off.

② Adjust the volume.

Bass and treble compensation

The EX.BASS (Extra Bass) function compensates for the high and low frequencies and has been set to on before the system left the factory.

± Each press switches EX.BASS on and off alternately.

AUTO POWER SAVE function

When the power is ON and neither recording nor playback is executed for 30 minutes or more, the power is switched off automatically by this function. This function can be made active or not active by the following operation.

Press when the power is OFF.

Each press switches the modes as follows.

- ① ON..... Auto power save is used.
- ② OFF.... Auto power save is not used.

± This function is not available when the AUX input is selected. When the TUNER input is selected, it is available only when the volume is set to 0.

When CD has been selected.

Volume display

Playback of CD



If a disc has already been loaded in the CD player and the power is OFF, simply pressing the CD play key turns power automatically ON and starts playback.

Playback from desired track

Skipping tracks
To pause playback
To stop playback

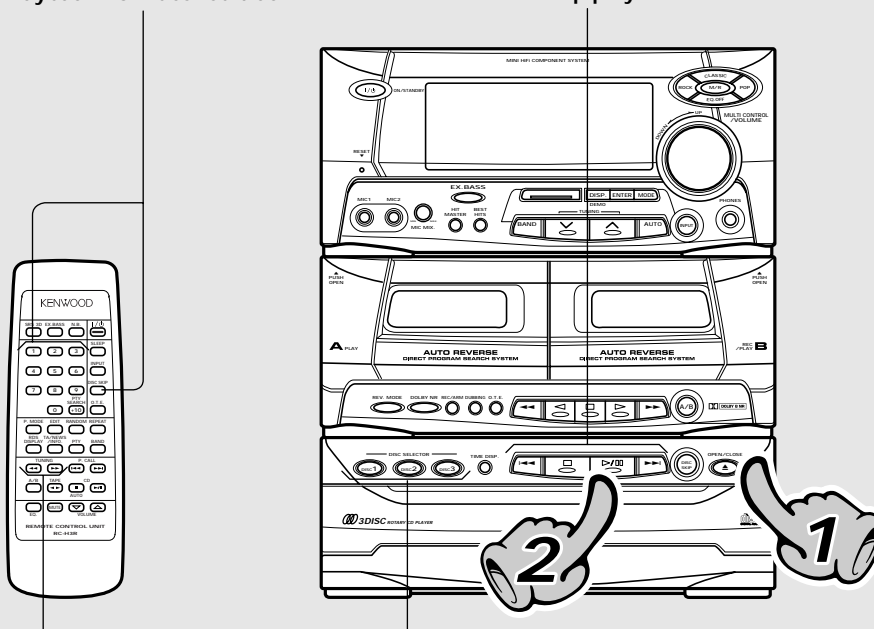

High-speed search in forward and reverse directions

Playback from desired track

Basic section

OPEN/CLOSE

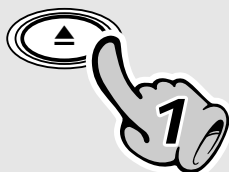

The tray opens when the key is pressed and closes when the key is pressed again.

1. Load a disc.

- ① Open the tray.
- ② Place a disc.
- ③ Select the disc to be played.
- ④ Close the tray.

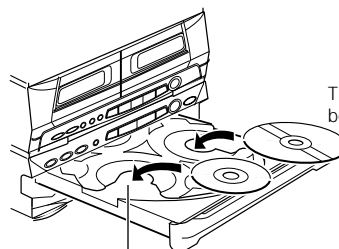

The label must be on top.

Disc played first when the ►/|| key is pressed.

2. Start playback.

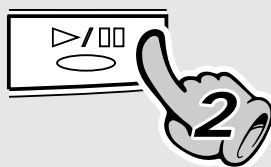

Time display on the CD player

Each press of the TIME DISP. key switches the time information.

+ Only the time information related to the track being played can be displayed in the program, edit and random modes.

- ① 1:23 Elapsed time of track being played
- ② - 2:37 Remaining time of track being played
- ③ TOTAL 23:45 Elapsed time of disc
- ③ - TOTAL 36:15 Remaining time of disc

Skipping tracks

To skip backward To skip forward

+ The track in the direction of the button pressed is skipped, and the selected track will be played from the beginning.
 + When the ◀◀ key is pressed once during playback, the track being played will be played from the beginning.

Playback from desired track

Select the disc.

DISC SELECTOR

DISC 1 DISC 2 DISC 3

Main unit

Select the desired track No.

1 2 3
4 5 6
7 8 9
0 +10

PTV SEARCH

Remote control unit

DISC SKIP Remote control unit

Press the numeric keys as shown below....

To enter track No. 23 : [+10] [+10] [3]

To select track No. 40 : [+10] [+10] [+10] [+10] [0]

- + Do not touch the played side of disc.
- + Rotate the tray with the **DISC SKIP** key to insert the third disc.
- + The tray of the disc to be played should come to the left position when the unit is seen from the front.

The selected disc is indicated.

Lights when a disc is inserted at the time of playback.
 The recorded track Nos. are shown.

+ After a few seconds, play starts from track No.1.

High-speed search in forward and reverse directions

Backward search Forward search

TUNING

Remote control unit

+ Playback starts from the position where the key is released.

To pause playback

+ Each press pauses and plays the CD alternately.

To stop playback

Introduction scanning

Each title is played back in sequence for about 10 seconds. This is convenient to find titles to be played back with a disc being listened to for the first time etc.

Light the "INTRO" indicator.

Remote control unit

Lights

Each press switches the modes as follows.

- ① "INTRO" lit Introduction scanning
- ② "DISC RANDOM" lit Random playback (1 disc)
- ③ "ALL RANDOM" lit Random playback (all discs)
- ④ "INTRO" and "RANDOM" not lit
Normal playback

- + Stop is executed after introduction scanning for all discs.
- + Combination with repeat playback is possible.
- + For cancellation, press the **RANDOM** key three times.

Playback of tape



If you load a tape(s) in a cassette deck(s) while the power is off, simply pressing the tape play key turns power automatically ON and starts playback with deck B.

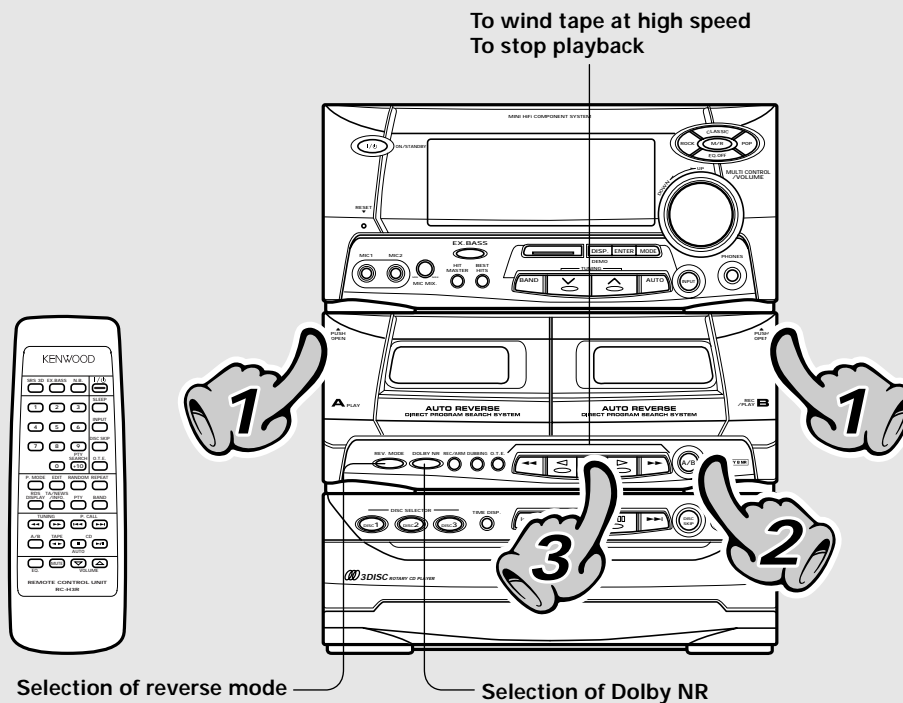

1. Load a cassette tape.

- ① Open the door.
- ② Insert a tape and close the door.

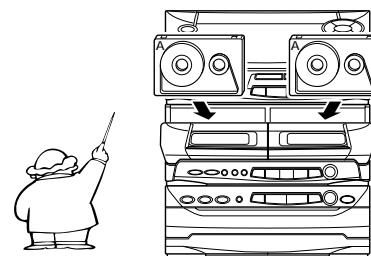
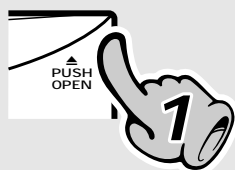

2. Select the deck to be used for playback.

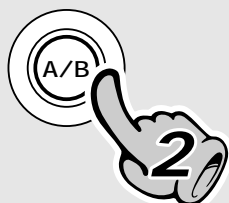

3. Start playback.

Press the play key of the desired direction.

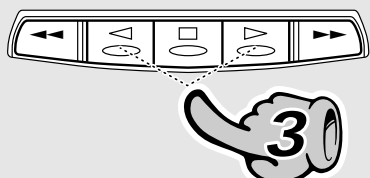

To wind tape at high speed

To fast wind in direction ← To fast wind in direction →

+ Press the ■ key to stop fast winding.

To stop playback

+ Do not take out the cassette tape until the tape transport has stopped completely.

Selection of reverse mode.

REV. MODE

Each press switches the modes as follows.

- ① "→" ... Both sides are played back (recorded), and then the tape stops.
- ② "↔" .. Both sides are played back endlessly. (The tape stops after recording onto both sides.)
- ③ "←" .. Only one side is played back (recorded), and then the tape stops.

Selection of DOLBY NR (Noise Reduction)

The Dolby NR system minimizes the hiss noise heard when playing tape. When playing a tape prerecorded with Dolby NR ON, be sure to set the DOLBY NR ON for playback.

Lit when "DOLBY NR" is ON.

Each press switches the modes as follows.

- ① "DOLBY NR" ON DOLBY NR is used.
- ② "DOLBY NR" OFF DOLBY NR is not used.

+ Select the Dolby NR mode according to the recording condition of the tape.

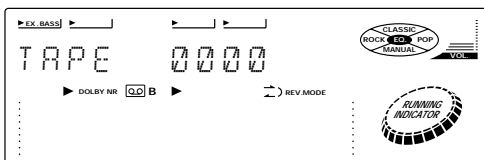

- + Normal (TYPE I), high (TYPE II), or metal (TYPE IV) tape selection is set automatically.
- + Remove tape slack before loading.
- + Close the door securely.

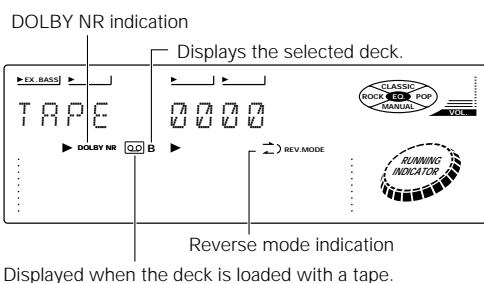

Transport direction indicators

The ◀ and ▶ indicators indicate the current direction in which the tape advances when playback or recording is started automatically by the easy operation function, etc. This direction is the direction stored in memory when the tape was last stopped. (To switch the tape transport direction, press the play key corresponding to the desired direction then press the stop (■) key.)

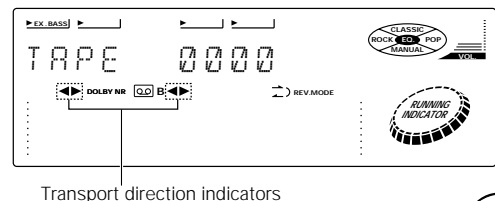

- + If the tape transport direction is opposite to the desired direction, press the play key corresponding to this.



Please play back tapes recorded with equalizer etc. without applying any effect.

Relay play

When tapes are set in the decks A and B and the reverse mode is set to "↔" (play of both sides), play of the second deck will be started automatically after play of the first deck has been completed. Tape play will be repeated alternately.

+Relay play is not possible in the reverse modes "↔" and "↔".

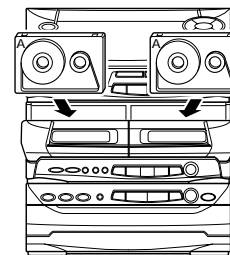

A tip for use of the tape counter

The tape counter is set to "0000" when a cassette tape is loaded. By writing down the counter reading in case you want to interrupt recording (playback) in the middle of the tape, the memo will be helpful as a reference for locating the same position when continuing the recording (playback) the next time. The tape counter figure decrements during recording or playback of the back side (while the ◀ tape transport indicator is lit).

To set the tape counter to "0000", open the cassette holder once. Then the counter will be reset.

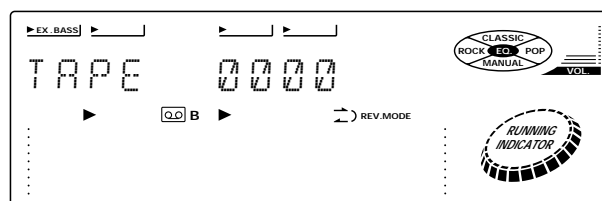

Searching for the desired music program (DPSS)

The DPSS (Direct Program Search System) is capable of detecting non-recorded spaces of more than 4 seconds as "blanks between programs" and, based on this information, can return to the beginning of the music program being played or the beginning of a desired program by skipping up to 16 other programs.

During play in direction ►

To play the next program : Press once.
 To play the 4th program after the current program : Press 4 times.

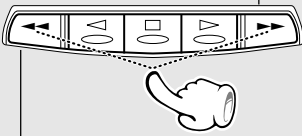

To return to the beginning of the current program : Press once.
 To play the 4th program before the current program : Press 5 times.

During play in direction ◀

To play the next program : Press once.
 To play the 4th program after the current program : Press 4 times.

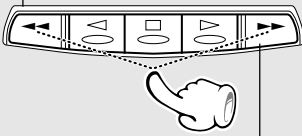

To return to the beginning of the current program : Press once.
 To play the 4th program before the current program : Press 5 times.



The DPSS may not function normally with the following kinds of tape.

- + Tapes containing several no-sound intervals of more than 4 seconds, such as conversation and talk tapes.
- + Tapes containing pianissimo sections, such as classical music tape.
- + Tapes in which large noise is recorded in blanks between programs.
- + Tapes containing blanks between programs that are shorter than 4 seconds.
- + Tapes recorded at low level.
- + Tapes recorded by cross-fade recording (in which the beginning of next program is overlapped on the end of previous program).

Receiving broadcast station

It is also possible to receive them by one-touch operations by storing up to 40 stations in the preset memory.



When the BAND key is pressed, this unit will be switched on automatically.

Collective presetting of stations
One-by-one presetting (manual preset)

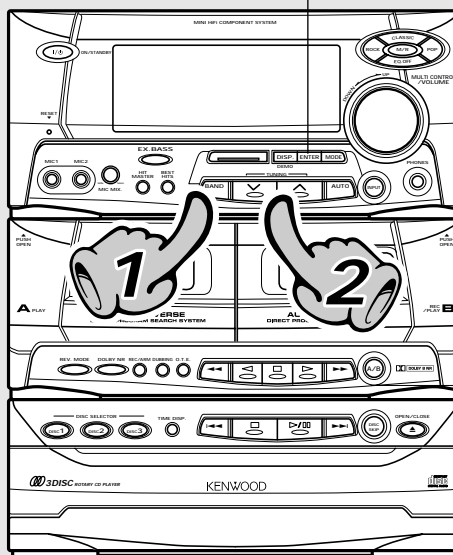
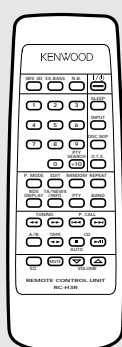

Basic section



1. Select the broadcast band.

Each press changes the band.

- ① FM
- ② MW
- ③ LW

To increase frequency

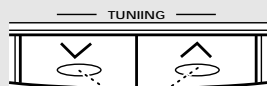

To decrease frequency



2. Select a station.

When no stations have been memorized

Auto tuning : Each press receives the next station.
Manual tuning : Press the key repeatedly or hold it depressed until a station is received.

When stations have been memorized (preset call)

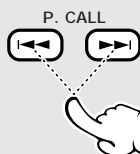

Remote control unit

Select a station.

Every time the key is pressed, the preset stations are switched over as follows.

- Press ►► for the order of 1→2→3 ... 38→39→40→1...
- Press ◀◀ for the order of 40→39→38 ... 3→2→1→40...



Collective presetting of stations (auto preset)

Keep the ENTER key depressed (about 2 seconds).

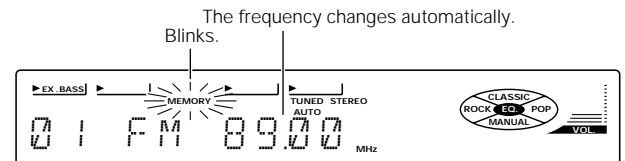

- +With priority for FM, a maximum of 40 stations is preset automatically.
- +When there are many stations and the intended station has not been preset, please also use "One-by-one presetting (manual preset)".

One-by-one presetting (manual preset)

1 Press the ENTER key during reception.

Presetting is cancelled when no operation is executed for 5 seconds or more.



2 Select one of the preset numbers from 1 to 40.

Presetting is cancelled when no operation is executed for 5 seconds or more.

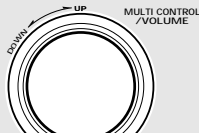

3 Press the ENTER key again.

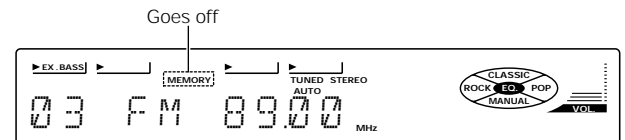
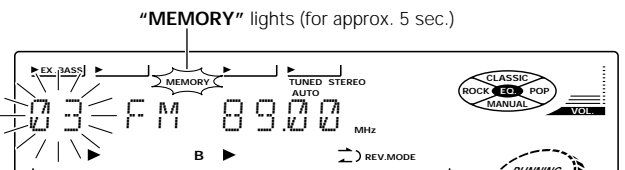

- + Repeat steps 1 2 3 to preset other stations.
- + If several stations are preset under the same number, the previous memory is replaced with the latest memory contents.

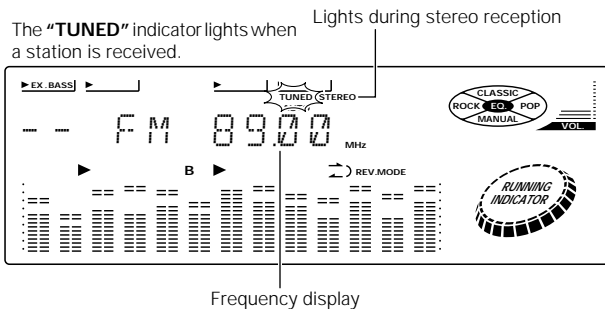
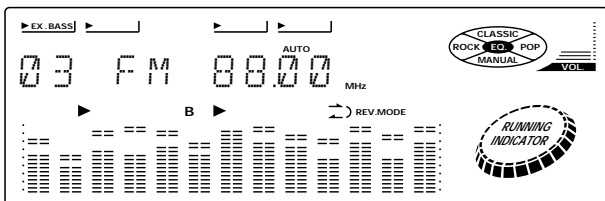

Select the tuning mode.

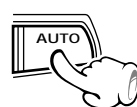

Each press alternates the mode.

- 1 "AUTO" lit (Auto tuning)
- 2 "AUTO" not lit (Manual tuning)

Use the manual tuning mode when reception is noisy due to weak reception. (In the manual mode, stereo broadcasts are received in monaural.)

+ Normally, use the **AUTO** (Auto tuning) mode.

+ When a key is held depressed, preset stations will be skipped at an interval of about 0.5 second.

Recording (Deck B only)



Note that this cassette deck cannot record onto Metal tapes.



When equalizer or another effect is applied to the sound, the sound with the applied effect can be recorded.

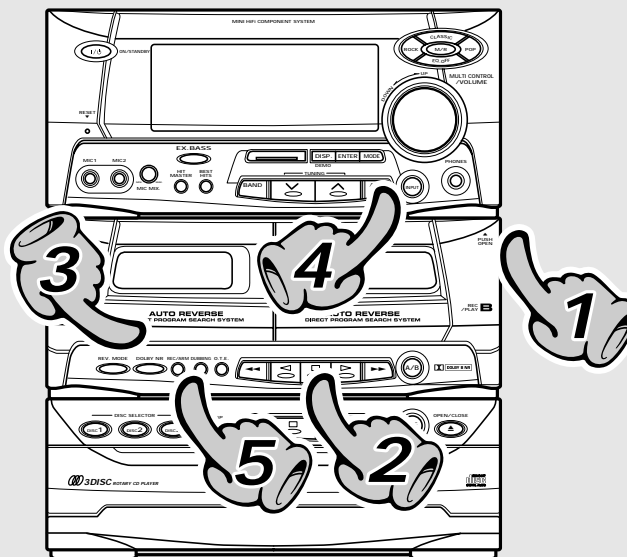
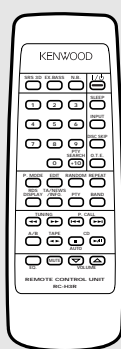

Basic section

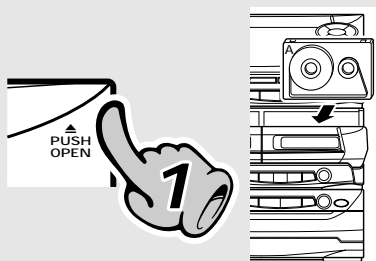

1. Load a tape in deck B.

- ① Open the door of deck B.
- ② Insert a tape.
- ③ Close the door.

+ Differentiation between normal (TYPE I) and high (TYPE II) tape is set automatically.
 + Remove tape slack before loading.
 + When the microphone is not used, set the **MIC MIX** control knob fully counterclockwise to the minimum position.

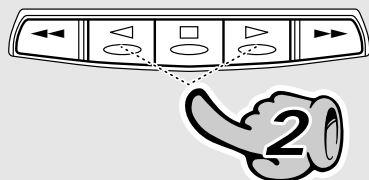

2. Select the tape transport direction.

To reverse the transport direction

- ① Press the play key corresponding to the desired direction.
- ② Stop playback.

Check the tape transport direction indicator.

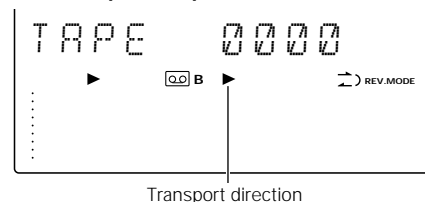

+ When recording is started, the tape is transported in the direction selected in this step.
 + Wind the tape to the position where recording is to be started.

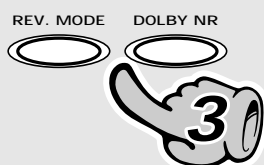

3. Set the recording condition.

- ① Select the reverse mode.
- ② Select the Dolby NR mode.

Selection of the reverse mode



Each press switches the modes as follows.

- ① "→" ... Both sides are played back (recorded), and then the tape stops.
- ② "↔" .. Both sides are played back endlessly. (The tape stops after recording onto both sides.)
- ③ "←" .. Only one side is played back (recorded), and then the tape stops.

To end recording



- + Pressing the key pauses recording after leaving a non-recorded space of about 4 seconds.
- + If the key is pressed again in less than 4 seconds after it has been pressed, recording resumes from that instant.

Selection of DOLBY NR (Noise Reduction)

The Dolby NR system minimizes the hiss noise heard when playing tape. When playing a tape prerecorded with Dolby NR ON, be sure to set the DOLBY NR ON for playback.



Lit when "DOLBY NR" is ON.

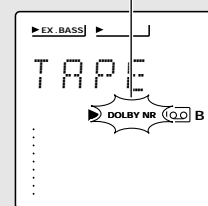

Each press switches the modes as follows.

- ① "DOLBY NR" ON. DOLBY NR is used.
- ② "DOLBY NR" OFF DOLBY NR is not used.

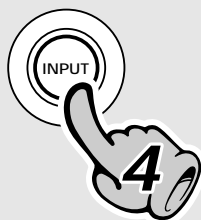

Select an input source other than "TAPE".

4. Select the source to be recorded.

The input source component to be recorded should be displayed.

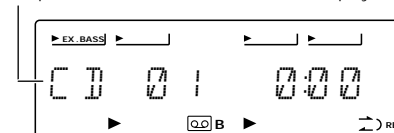

- + When the CD input is selected and if a disc has been set in the CD player, its playback starts immediately.

REC/ARM



5. Start recording.

- ① Play (or tune) the input source to be recorded.
- ② Start recording.

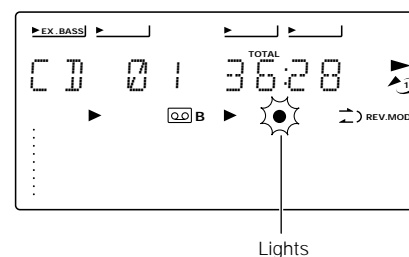

- + Recording stops automatically when the tape side(s) to be recorded have been fully recorded.
- + The beat cancel function can be used when recording MW broadcasts.

Beat cancel function

There may be cases in which beat noise interferes with recording of MW/LW broadcasting.

In such a case, press the A/B key during recording to reduce or suppress the beat noise. The A/B key acts as the demonstration key except during tuner recording.

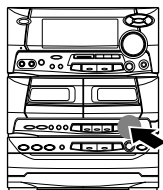

Points in CD recording

When recording CD tracks onto a tape, if you leave the cassette deck in record-pause mode beforehand, the cassette deck recording can be started at the same time as the CD starts to be played. (Synchro recording function)

- ① Put the CD player in pause mode.
- ② Select the track to be recorded with the skip (◀◀, ▶▶) keys.
(The CD player pauses at the beginning of the selected track.)
- ③ Put the cassette deck in Record-pause mode.
- ④ Start playing the CD.
(Synchro recording starts)



± Recording stops when the play key of the CD player is pressed.

Copying tape (Tape dubbing)

The contents of the tape in deck A can be copied onto the tape in deck B.

① Select the "TAPE" input.

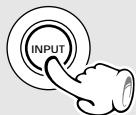
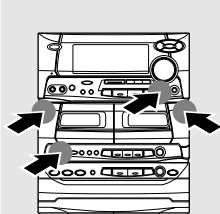

② Load tapes in the decks.

③ Select "↔" (double-side recording) or "→" (one-side recording).



④ Use the same tape transport directions.

(1) Select the deck to change the transport direction.

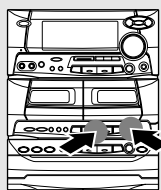

(2) Press the play key corresponding to the desired direction.

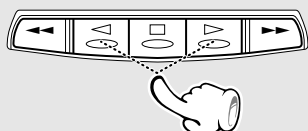

(3) Stop playback.

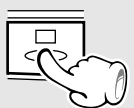

⑤ Start dubbing.

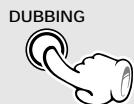
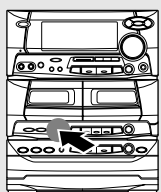

Press during stop.

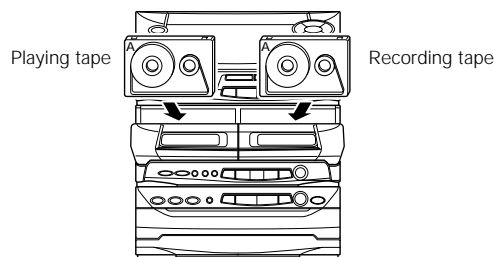

Check the tape transport direction indicators.

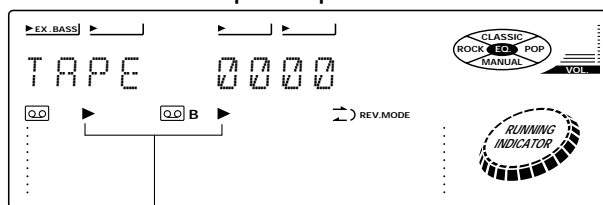

Running direction

÷ When recording is started, the tape will be transported in the direction selected in this step.

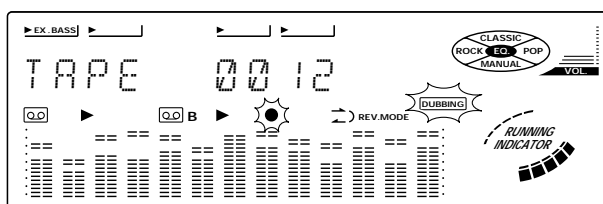

÷ Dubbing ends automatically when the side(s) to be dubbed has been completed.

To stop dubbing

DUBBING



÷ The deck B will stop after creating a non-recorded portion of about 4 sec, and then the deck A will stop.

÷ Dubbing can also be stopped by pressing the stop (■) key. Note that the non-recorded space is not created in this case.

Note The **DOLBY NR** key is not active in dubbing mode. The tape recorded on deck B assumes the same Dolby NR condition as the tape played on deck A.

Listening in the desired sequence (program playback)

Any titles on the discs in the tray can be listened to in the desired sequence. (Max. 32 titles)

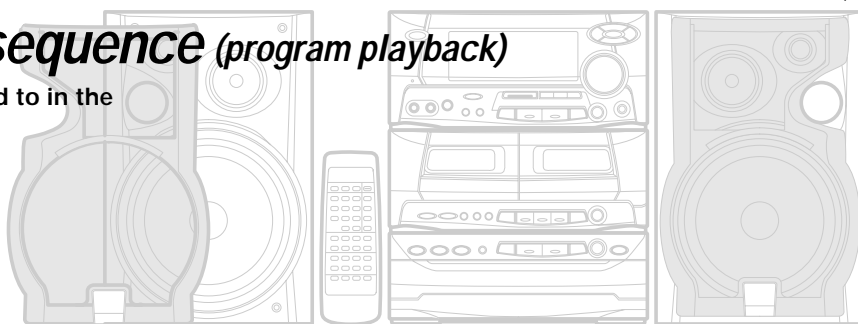

Select the "CD" input.

1 Check that the CD player is in the stop mode.

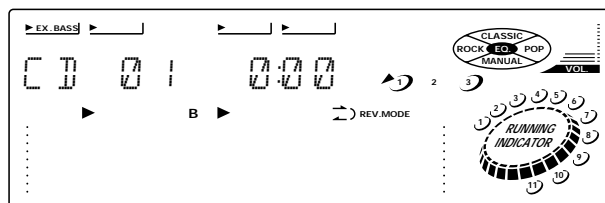

2 Light the "PGM" indicator.

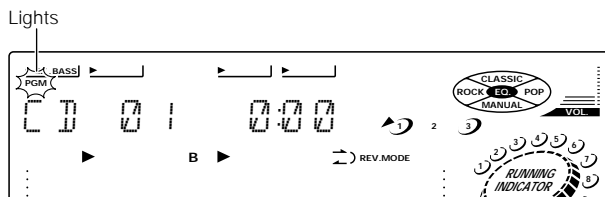
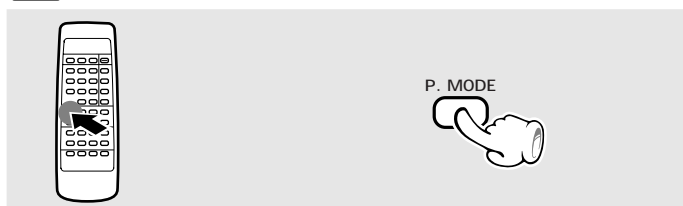

3 Enter track Nos. in the order you want to play them.

1 Select the disc.

2 Select the track.

1	2	3
4	5	6
7	8	9
0	PTY SEARCH +10	

3 Establish the selection.

To select tracks from more than one CD, repeat steps 1, 2 and 3.

- ÷ The disc can also be selected with the **DISC SELECTOR** key.
- ÷ Up to 32 tracks can be programmed. When "FULL" is displayed, no more tracks can be programmed.
- ÷ To program all tracks of a CD, select the disc and then press the **P.MODE** key without selecting any tracks.
- ÷ If you make a mistake, press the **P.MODE** key to quit the program mode and restart from step 2.

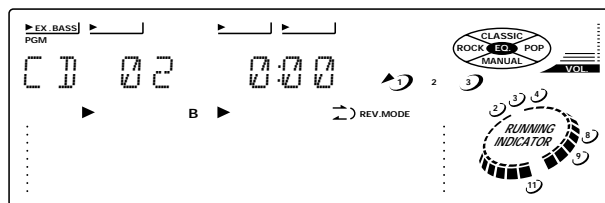
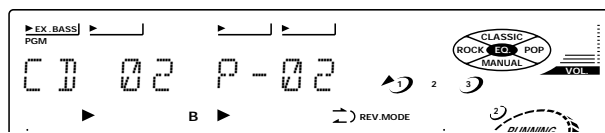

4 Start playback.

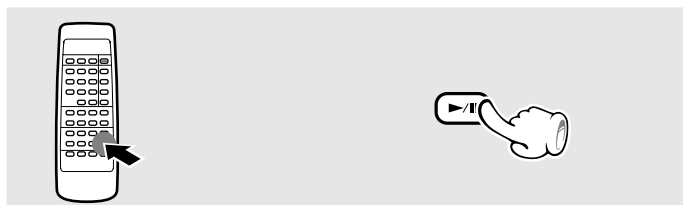

- ÷ Tracks will be played in the order they were programmed (in order of P Nos.).
- ÷ When the **⏮** or the **⏭** key is pressed during play, the program will jump to the preceding or the following track respectively.
- ÷ When the **⏮** key is pressed once during playback, the play position returns to the beginning of the current track being played.

Application section

XD-750/700/550/500 (En)

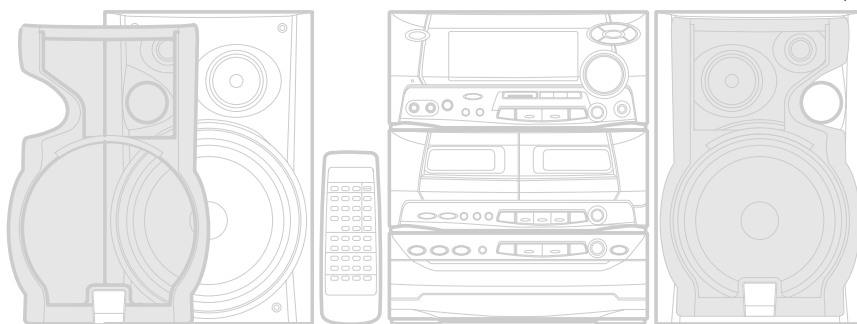

To stop playback



To add a track to the program

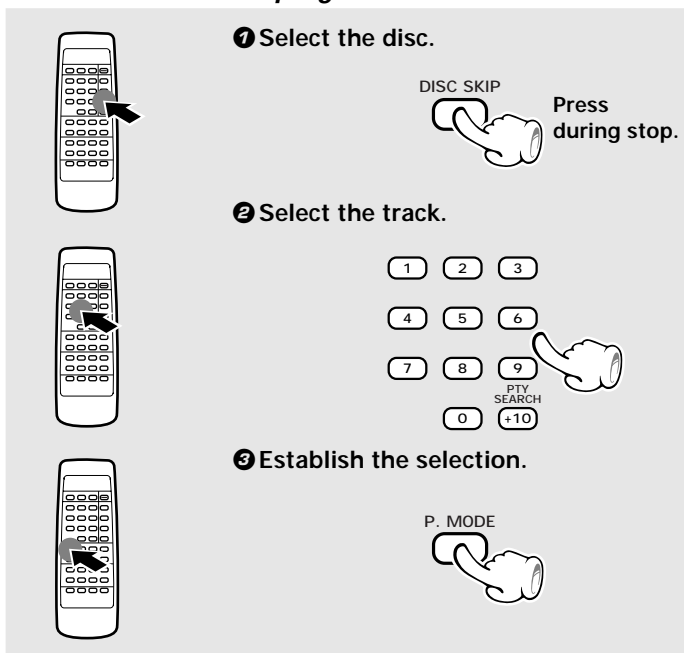

To quit the program mode



+ The added track number is added to the end of the existing program.

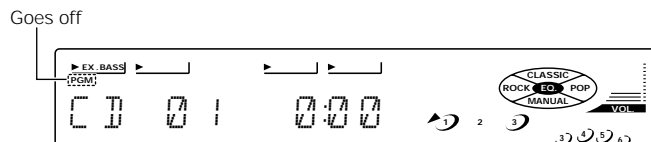

+ If the key is pressed during playback, normal playback in order of tracks resumes from the current track.

Application section

Repeated playback

Desired titles or discs can be played back repeatedly.

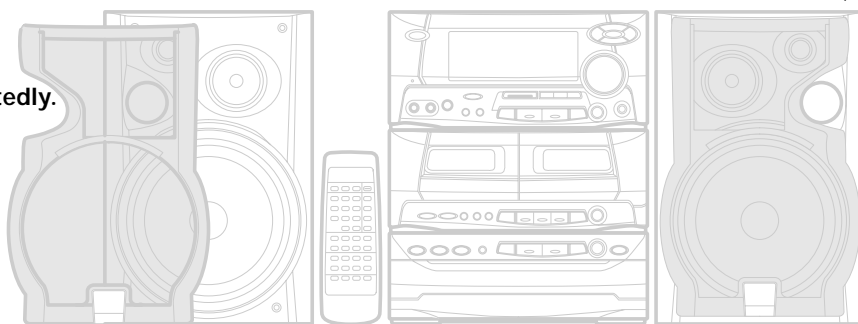

Select the "CD" input.

To repeat a disc

- 1 Confirm that the "PGM" indicator is not lit.
If the "PGM" indicator is lit, press the P.MODE key to turn it off.
- 2 Press to select "DISC REPEAT".
- 3 Select the disc.

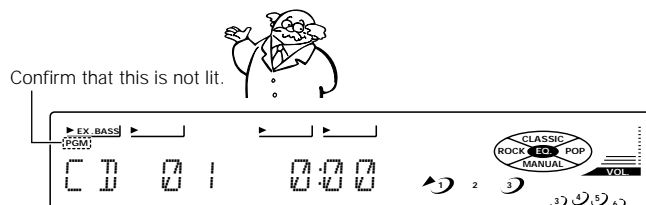

Each press switches the repeat mode.

- 1 REPEAT
- 2 DISC REPEAT
- 3 ALL REPEAT
- 4 Repeat OFF

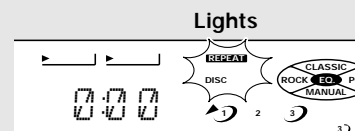

To stop repeated playback

Press the REPEAT key twice.

÷The "DISC" and "REPEAT" indicators go off and the playback following the current mode of the CD player starts.

To repeat all discs

- 1 Confirm that the "PGM" indicator is not lit.
If the "PGM" indicator is lit, press the P.MODE key to turn it off.
- 2 Press to select "ALL REPEAT".
- 3 Select the disc to be played first.

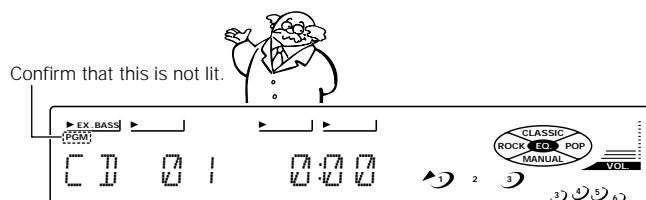

Each press switches the repeat mode.

- 1 REPEAT
- 2 DISC REPEAT
- 3 ALL REPEAT
- 4 Repeat OFF

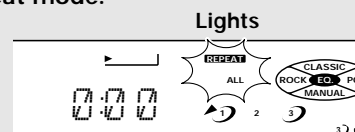

To stop repeated playback

Press the REPEAT key again.

÷The "ALL" and "REPEAT" indicators go off and the playback following the current mode of the CD player starts.

Application section

XD-750/700/550/500 (En)

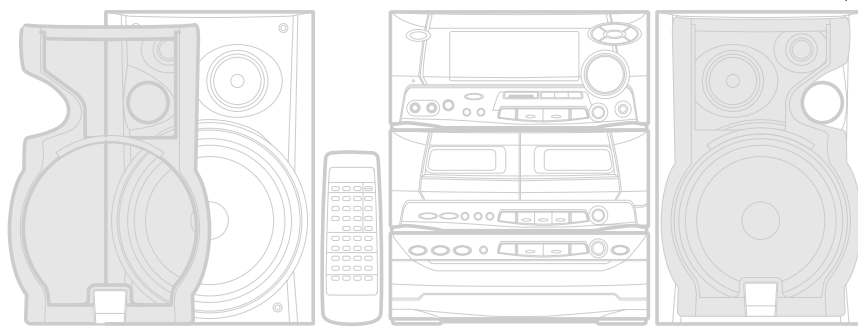

Select the "CD" input.

To repeat only one track

- 1 Confirm that the "PGM" indicator is not lit.
If the "PGM" indicator is lit, press the P.MODE key to turn it off.
- 2 Press to select "REPEAT".
- 3 Select the disc.
- 4 Select the track.

Each press switches the repeat mode.

- 1 REPEAT
- 2 DISC REPEAT
- 3 ALL REPEAT
- 4 Repeat OFF

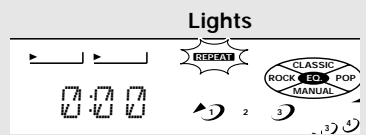

To stop repeated playback

Press the REPEAT key three times.
+The "REPEAT" indicator goes off and the playback following the current mode of the CD player starts.

To repeat only the programmed tracks

- 1 Perform the procedure in "Listening in the desired sequence (program playback)" till step 2 to program the desired CD tracks. - 30
- 2 Press to select "REPEAT".
- 3 Start playback.

+All of the programmed tracks will be played repeatedly.

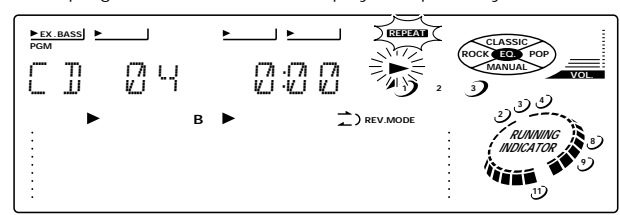

To stop repeated playback

Press the REPEAT key again.
+The "REPEAT" indicator goes off and the playback following the current mode (PGM) of the CD player starts.

Application section

Listening to an unexpected title sequence (random playback)

As the titles each time are selected randomly, the music can be enjoyed without getting tired of it.

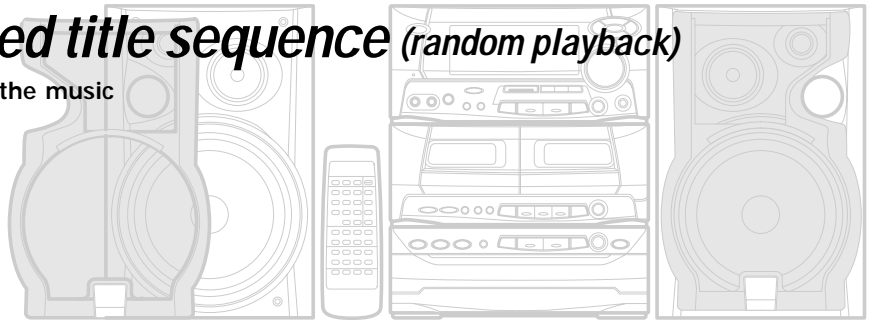

Select the "CD" input.

1 Confirm that the "PGM" indicator is not lit.

If the "PGM" indicator is lit, press the P.MODE key to turn it off.

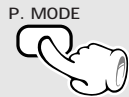

Confirm that this is not lit.

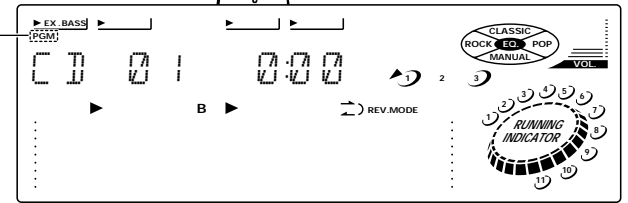

2 Select the RANDOM mode.

For "DISC RANDOM" playback, select the disc in advance.



Each press switches the modes as follows.

- ➔ ① INTRO No random playback in this case.
- ➔ ② DISC RANDOM Random play of one disc
- ➔ ③ ALL RANDOM Random play of all discs
- ➔ ④ Normal playback

Random play of one disc

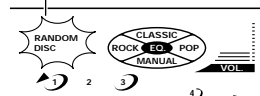

Random play of all discs

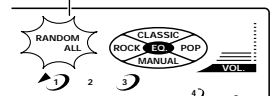

Application section



To select another track in the middle of playing one



+ Pressing the ◀◀ key once returns to the beginning of the track being played.

To cancel random playback

Press so that the "RANDOM" indicator goes off.



+ The "RANDOM" indicator goes off and the playback in order of the tracks starts from the track being played.

RDS is a system which transmits useful information (digital data) for FM broadcasts together with the broadcast signal. Tuners and receivers designed for RDS reception can extract the information from the broadcast signal for use with various functions such as automatic display of the station name.

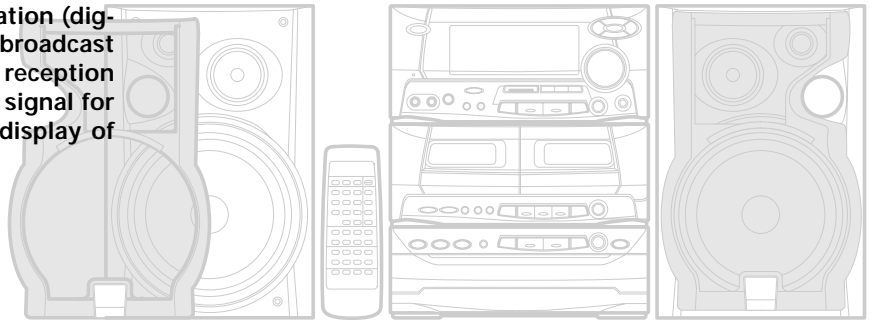

This unit is equipped with the following functions utilizing RDS data:

PTY (Program Type Identification) Search : → 36
The tuner automatically searches for a station which is currently broadcasting a specified program type (genre).

PS (Program Service Name) Display : (See below.)
When an RDS broadcast is received, the station name is automatically displayed.

EON (Enhanced Other Network) : ○
When the information to be received is set in advance and any RDS station in the same network starts broadcasting of such information, the reception automatically will be switched to that station.

The "RDS" indicator lights up when an RDS broadcast (signal) is received.

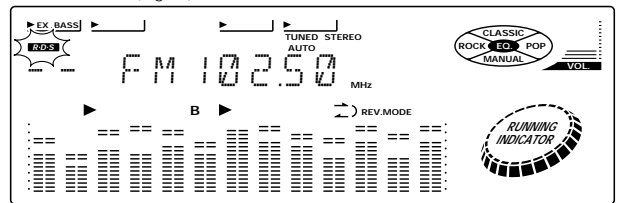

± Some functions may not be provided or be given different names depending on countries or areas.

Note before the use of RDS

To receive RDS stations, you have to preset RDS stations using the auto preset function. The auto preset function presets the RDS stations in priority. Flashing "NO DATA" will be displayed when no RDS station has been preset with this function.

Set the receiving band to FM and preset RDS stations with the auto preset function.

To switch the display contents

Pressing the RDS DISPLAY key changes the display contents.

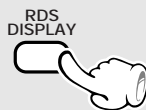

Display mode priority ranking

When an RDS broadcast is received :

- ① **PS (Program Service Name) Display :**
When an RDS broadcast is received, the station name is automatically displayed.
If no PS data was sent, "NO PS" is displayed.

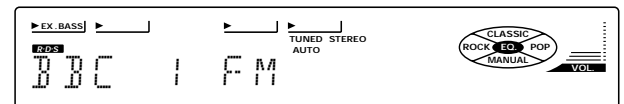

- ② **Frequency Display :**
The frequency of the current station is displayed.

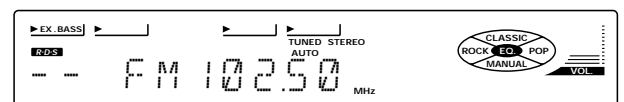

Searching for a desired program type (PTY search)

By specifying the type of program (genre) you want to listen to, the tuner automatically searches for a station which is currently broadcasting a program of the specified type.

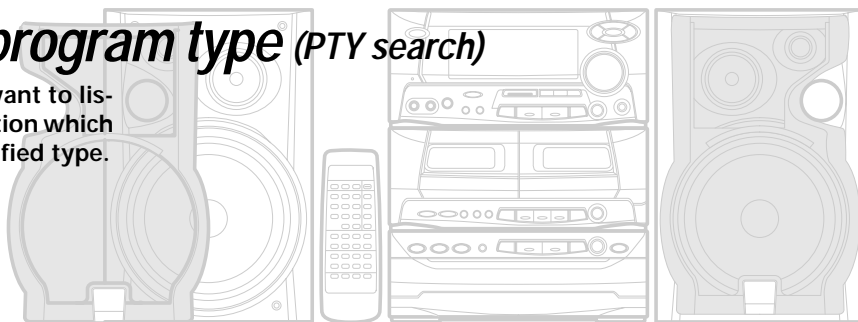

Set the reception band to FM. Preset RDS stations with the auto preset function.



1 Select the PTY search mode.

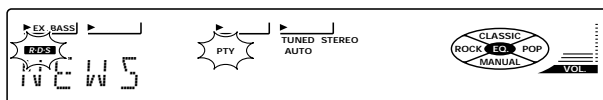

When an RDS broadcast is received, the program type is shown on the display. If no PTY data is available, or if the station is not an RDS station, "NONE" is displayed.

2 Select the desired program type.

Use program type table on the right for your convenience.

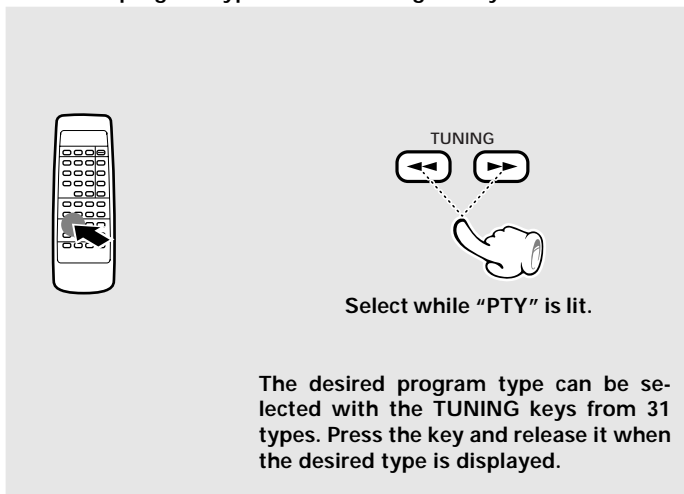

Program type table

TUNING keys	Program Type Name	Display
	Pop Music	POP M
	Rock Music	ROCK M
	* M.O.R. Music	M.O.R. M
	Light Classical	LIGHT M
	Serious Classical	CLASSICS
	Other Music	OTHER M
	News	NEWS
	Current Affairs	AFFAIRS
	Information	INFO
	Sport	SPORT
	Education	EDUCATE
	Drama	DRAMA
	Culture	CULTURE
	Science	SCIENCE
	Varied	VARIED
	Weather	WEATHER
	Finance	FINANCE
	Children's programmes	CHILDREN
	Social affairs	SOCIAL A
	Religion	RELIGION
	Phone in	PHONE IN
	Travel	TRAVEL
	Leisure	LEISURE
	Jazz music	JAZZ
	Country music	COUNTRY
	National music	NATION M
	Oldies music	OLDIES
	Folk music	FOLK M
	Documentary	DOCUMENT
	Alarm test	TEST
	Alarm	ALARM

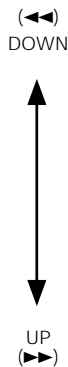

*M.O.R. Music (Middle of the Road Music)

Application section

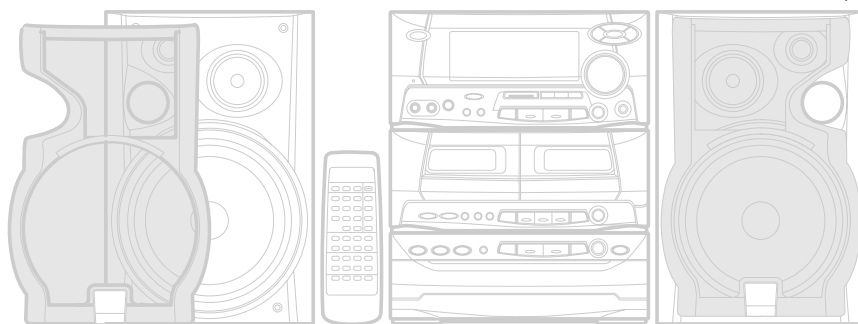

3 Start the search.

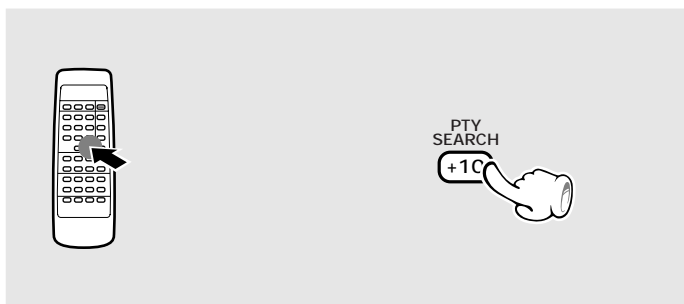

When searching for a Rock Music broadcast
Display while the tuner is searching.

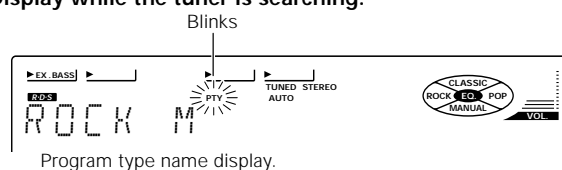

When a station is received.

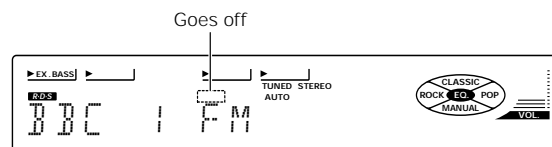

To change to a different program type :

Repeat steps 1, 2, 3.

- ÷ No sound is heard while "PTY" is blinking.
- ÷ If a program of the desired type cannot be found, "NO PROG" is displayed, then after several seconds the display returns to the original display.
- ÷ If a program of the desired type is found, that program is received and the program type name display changes temporarily to the frequency display, and then to the station name display.

To be able to listen to the desired information at any time

By using the EON function, which manages the information of other stations, listening to desired information like traffic information or news etc. can be reserved even when it is not being transmitted at the present. When listening to a station with the "EON" display lit and another station of the same network starts to broadcast an information program for which a reservation has been made, then that station will be selected automatically. When the desired information program ends, return is made to the original program.

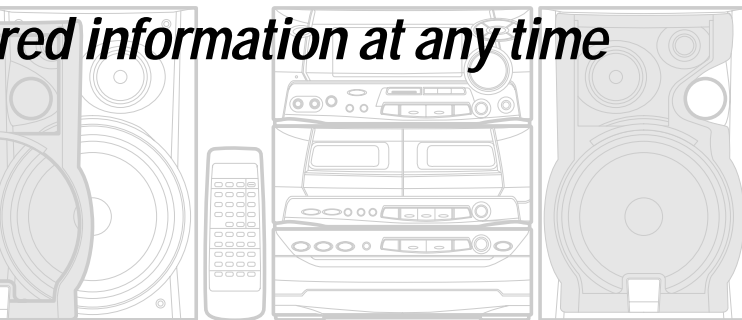



Set the reception band to FM.

1 Auto preset the stations.

1 Receive a broadcast.

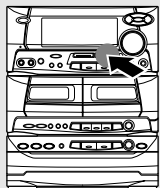
2 Keep the ENTER key pressed (2 sec or longer).



The EON data presently being broadcasted are taken in automatically.



This is not required when auto presetting has already been executed.

÷ When all 40 stations have already been preset by the procedure for "One-by-one presetting", the EON function will not operate. Auto presetting must be used.

2 Select the desired information.





TA/NEWS/INFO.

Each press switches the modes as follows.

- 1 TA Traffic Announcement
- 2 NEWS News
- 3 INFO Information
- 4 Display not lit EON cancelled

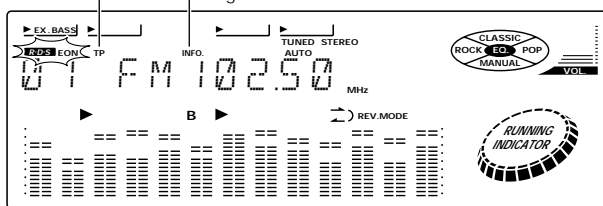
Lights with a station broadcasting traffic announcement programs. Lights when "INFO." is selected



÷ Please execute automatic presetting when TA, NEWS, and INFO can not be selected.

3 Receive an RDS station.

Select a station where "RDS" and "EON" are lit.

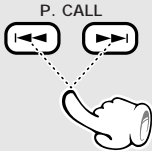
P. CALL

"RDS" and "EON" are lit

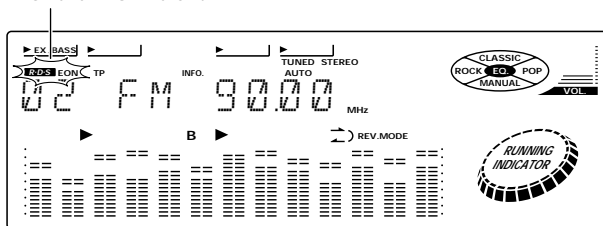

÷ When "EON" does not light although an RDS station is received, that station is not transmitting EON data. Please select a different station.

÷ If you want TA programs, select the stations with which the "TP" indicator lights.

Application section

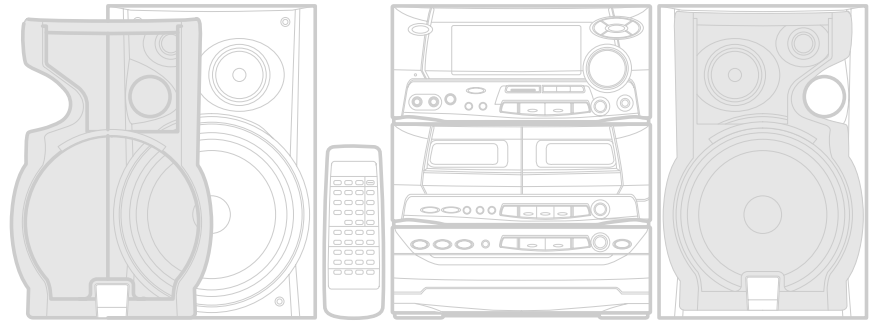

4 Wait for the desired information.

CD or tape playback may also be started.
As long as the unit is ON, the unit is always ready for the reception.

- + When one of the stations of the network of the station received in **3** starts broadcasting the program contents selected in **2**, that station will be received automatically. At this time, tape playback will stop and CD playback will pause. However, external equipment (AUX) will remain as it is.
- + When the power is OFF and during recording (including dubbing), the EON function does not operate.
- + When the transmission of the selected program contents ends in case of automatic reception with the EON function, return will be made to the status directly before operation of the EON function. When tape or CD playback has been interrupted, it will be continued from the point of interruption.

Waiting for information while a RDS station without EON function is tuned

If the EON indicator does not light with the RDS station in steps **3** and **4**, the tuner will wait for only the desired information broadcast from the tuned RDS station provided that the desired information has been selected in the previous step.

TP (Traffic Program) indicator

The lighting of the TP indicator indicates that the currently tuned station or a station in the same network as it broadcasts traffic announcement programs. If the TP indicator already lights with the current station, you can listen to the traffic announcement program through the station without making reservation with the EON function.

Selection of the convenient CD recording type

With this unit, the following edit recording is possible according to the purpose.

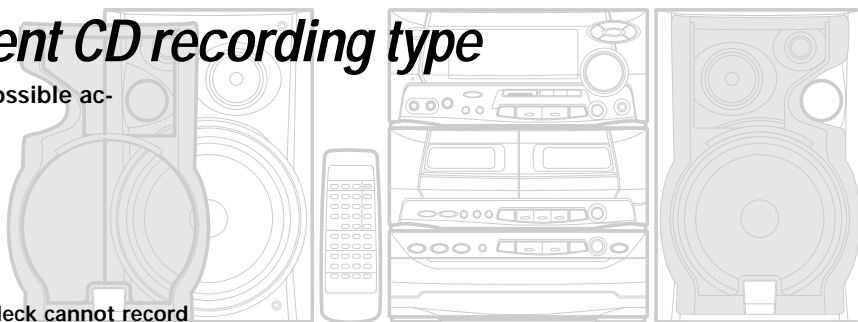

Note that this cassette deck cannot record onto Metal tapes.

If you want to avoid any tune being interrupted at the end of tape

Giving preference to the tape length over the title sequence (time edit recording) → 41

Edit recording of CD is possible by the simple operation of entering the recording length of the tape.

If you want to select the tracks to be recorded while playing a CD

Recording only desired titles
(ONE TOUCH EDIT.....single title recording) → 42

Play a CD and, if a track you want to record starts, press the O.T.E. key. The track will be recorded from the beginning.

If you want to record a CD in order of track numbers

One touch recording of an entire CD
(ONE TOUCH EDIT.....recording of all titles) → 43

Press the O.T.E. key when in the stop mode. The disc will start to be recorded.

For recording of only one title from several CDs

Producing a tape collecting only the first titles
(BEST HITS function) → 44

When the BEST HITS key is pressed, the first titles of all set CDs will be recorded in sequence on the tape. As already recorded CDs can be exchanged while recording, it is not necessary to interrupt the recording.

Giving preference to the tape length over the title sequence (time edit recording)

When the tape recording time is specified, recording is executed with changing the title sequence so that no title will be interrupted when the tape direction is changed at the end of one side.

 When equalizer or another effect is applied to the sound, the sound with the applied effect can be recorded. → 46

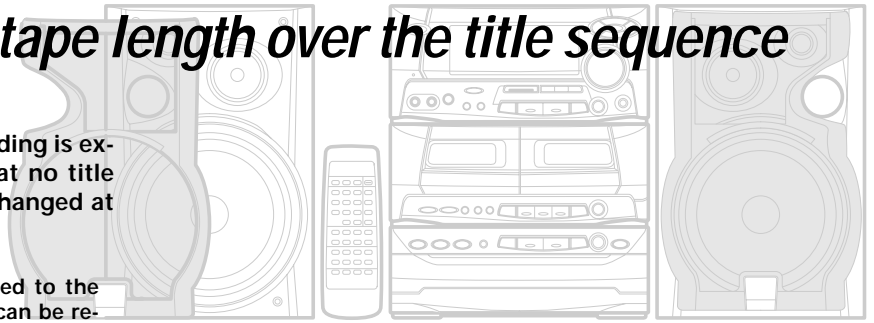

Recording preparations are required. → 26 (Steps 1 to 4) (For the reverse mode, select "↔" (two-way recording).)

1 Select the "EDIT" mode.

1 Confirm that the "PGM" indicator is not lit.

If the "PGM" indicator is lit, press the P.MODE key to turn it off.



2 Press the EDIT key.



The editing is ended when no operation is executed for 8 sec or more.

Confirm that this is not lit

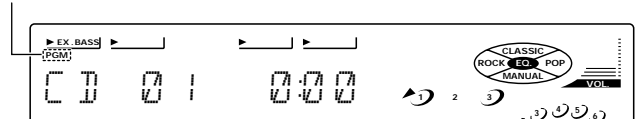

÷ To cancel the EDIT mode, press the P.MODE key of the remote control unit.

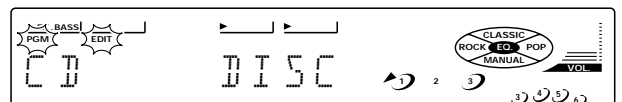

2 Select the disc.



÷ Even if the disc has already been selected, select the disc again.

3 Enter the recording length of the tape.



Press the numeric keys as shown below.

30-minute tape : **[+10] [+10] [+10] [0]**

46-minute tape : **[+10] [+10] [+10] [+10] [6]**

÷ If you commit an error in the time entry, restart the procedure from step 1.

÷ Up to 32 tracks can be edited.

÷ Every time the ►► key is pressed, the edited track numbers will be displayed in the changed order. Press the ■ key to return to the track number of the first track.

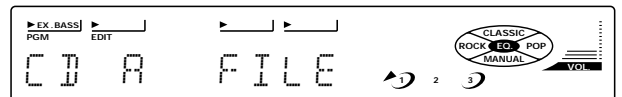

4 Start edit recording.

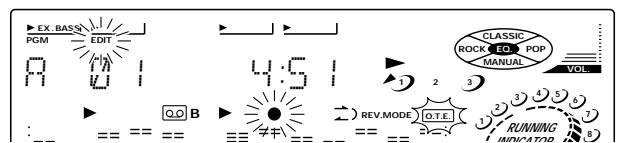

÷ The tape and CD stop automatically when recording has completed.



Depending on the combination of conditions from CD contents (number of titles and length of the titles) and tape recording time, interruption of a title may not be avoidable. In such a case, the respective title will not be recorded.

Recording only desired titles (ONE TOUCH EDIT....single title recording)

At the time of CD playback, any desired title can be selected immediately for recording.

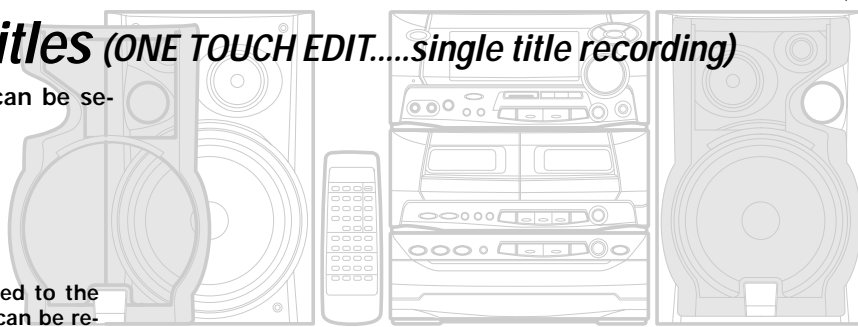

When equalizer or another effect is applied to the sound, the sound with the applied effect can be recorded.

→ 46

Recording preparations are required.

→ 26 (Steps 1 to 4)

1 Play a CD.

Select a mode other than random play.

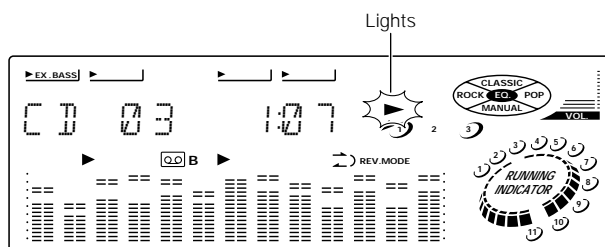
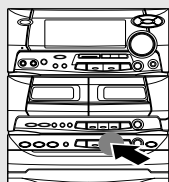

2 When you want to record a track being played, press the O.T.E. key.

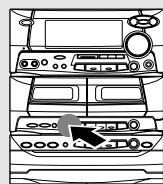

In case the key is pressed with track No.3

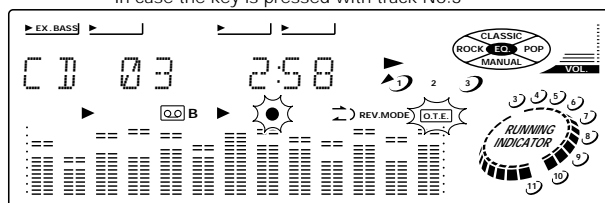

+ Playback restarts from the beginning of the track being played and recording starts at the same time.

When recording has been completed, a non-recorded portion of 4 seconds will be produced and the cassette deck part will stop. The CD player will enter temporary stop condition.

To record a different track, repeat the steps 1 and 2.



To end recording in the middle

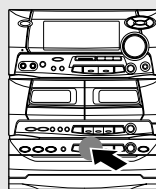



+ Both the cassette deck and CD player stop.

Application section

One-touch recording of an entire CD (ONE TOUCH EDIT....recording of all titles)

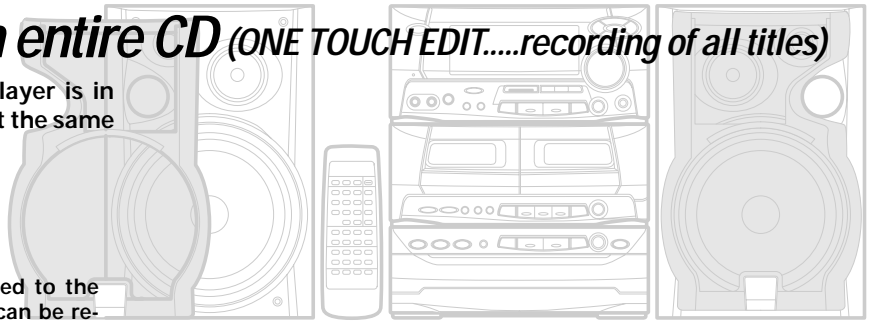
When the O.T.E. key is pressed while the CD player is in the stop mode, recording of a CD can be started at the same time as playback.



 When equalizer or another effect is applied to the sound, the sound with the applied effect can be recorded. → 46

Recording preparations are required. → 26 (Steps 1 to 4) (For the reverse mode, select "↔" (two-way recording).)

1 Select the disc.

1 Select the disc.

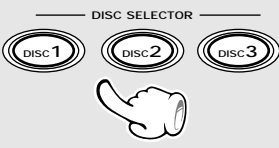
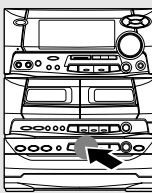



2 Stop the disc.

+ Select a mode other than random play.

Step 2 can also be executed after the order of the tracks has been programmed.

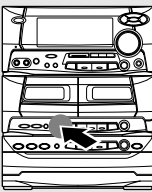
2 Press the O.T.E. key.



O.T.E.

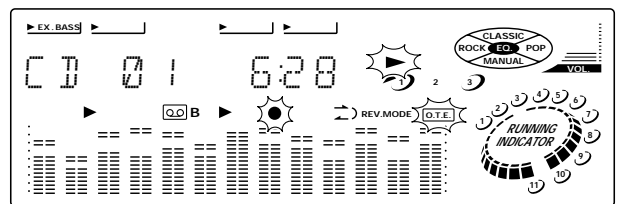

+ Recording of CD starts at the same time as playback.
 + At the end of tape, the music is not recorded on the leader tape portion. If you do not want any music to be interrupted in the middle, refer to "Recording" and start recording of side B with the interrupted track.

→ 26

To end recording in the middle





+ Both the cassette deck and CD player stop.

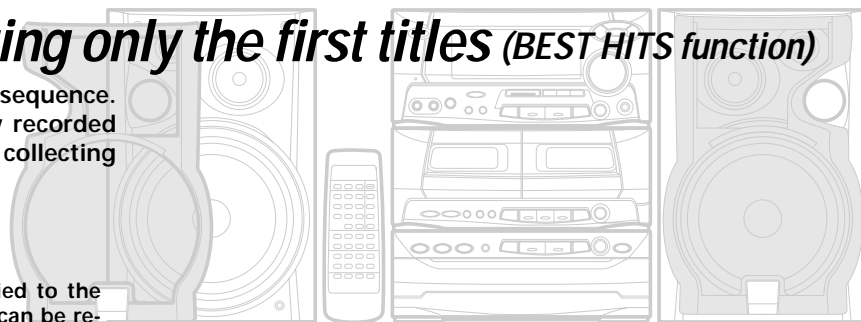

Producing a tape collecting only the first titles (BEST HITS function)

The first titles of the discs will be recorded in sequence. During recording of the third disc, the already recorded discs can be exchanged. This is convenient for collecting hits from a large number of single CDs.



 When equalizer or another effect is applied to the sound, the sound with the applied effect can be recorded. → 46

Recording preparations are required.

→ 26 (Steps 1 to 4)

1 Insert the discs.

2 Make the PGM (program) display go out.

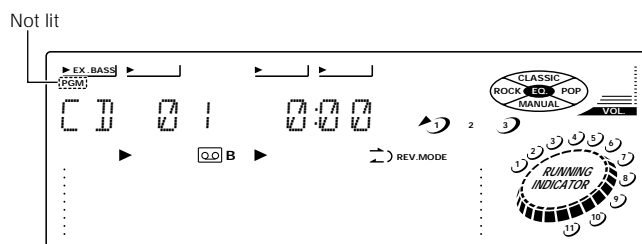

3 Start recording.

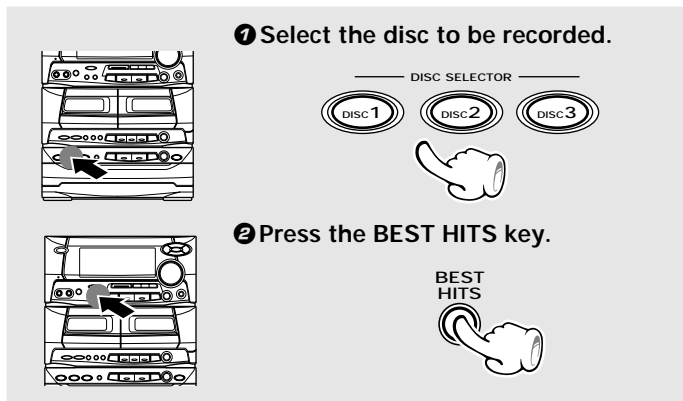

+ Playback will start, but when recording is started by 2, return will be made to the start of the first title.
+ Recording of the first titles will start from the selected disc.

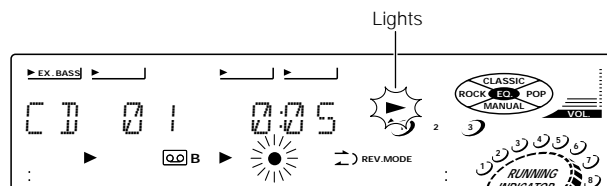

+ Recording starts. The CD player plays only the first title in sequence, starting from the disc selected in 1.

4 Replace the discs as required.

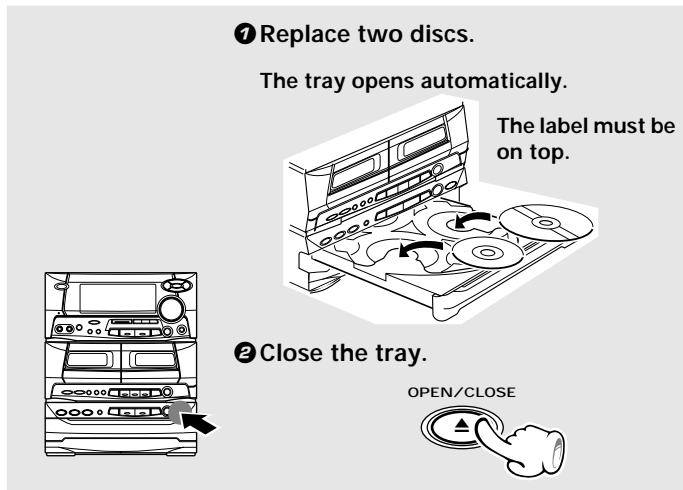

+ When recording of the third disc starts, the tray opens automatically. The two already recorded discs can be exchanged.
+ Recording stops at the tape end.

To end recording



+ Recording stops at the end of the present title.
+ When the ■ key is pressed, recording is stopped immediately.

When the discs are exchanged in sequence, the recording can be continued without interruptions.



Application section

This unit permits selection of equalizer and sound field playback. Please select the equalizer as desired according to the music genre. Select the sound field mode according to the desired atmosphere.

Adjustment of balance and input level

Balance..... Adjusts the balance of left and right volume.

Input level..... Adjusts the volume of external equipment (video deck etc.) connected to the AUX terminal. Please adjust as required when the volume from external equipment is too high etc.

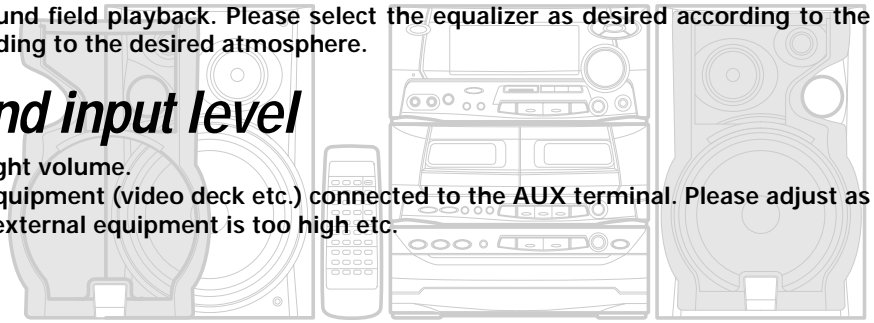

1 Select what to adjust.

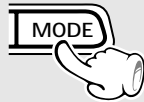

When no operation is executed for 5 seconds or more, the adjustment is ended automatically. (Return will be made to volume adjustment.)

Each press switches the modes as follows.

- ① Strength of the SRS 3D effect (LEVEL) (XD-750/XD-700 only)
- ② Left and right volume balance
- ③ Volume from the external equipment connect the AUX terminal (INPUT)
- ④ Normal volume adjustment (VOL)

+ "INPUT" is displayed only when the AUX input is selected.
 + When SRS 3D is ON, "LEVEL" (strength of the 3D effect) also is displayed.



2 Adjust.

BALANCE adjustment

The left volume is decreased.

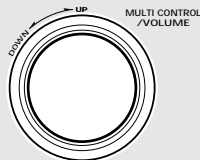

The right volume is decreased.

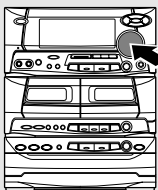

INPUT LEVEL adjustment

The level is decreased. The level is increased.

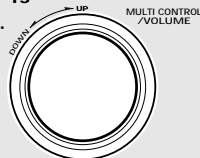

BALANCE adjustment

Indicates the center

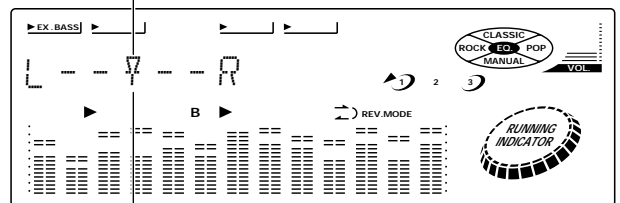

Indicates the balance setting

INPUT LEVEL adjustment

Set level

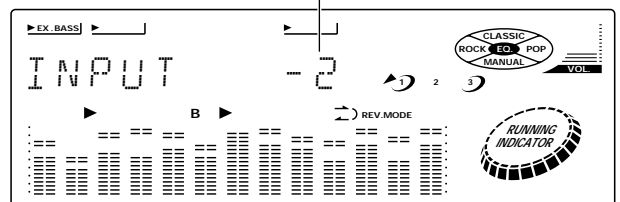

+ Adjustment is possible in the range from -12 to +3.

In regard to equalizer adjustment (LOW, MID, HIGH)

The setting items LOW, MID, and HIGH are displayed only when the equalizer is set to MANUAL (user memory). The result of adjustment of these items will be memorized automatically. → 47

Listening with the desired sound (equalizer function)

In addition to the three kinds of equalizer patterns which have been preset at the factory for use as reference, three equalizer patterns created manually by the user can be stored in memory and recalled any time.

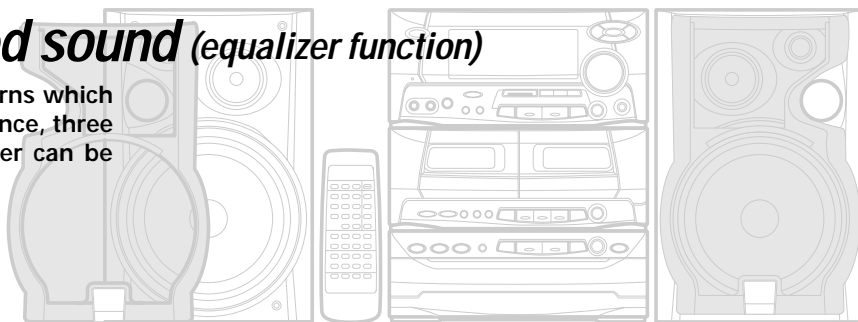

Selecting an equalizer pattern

It is possible to select the desired equalizer pattern according to the category of the played music. The graphic equalizer effect can be recorded together with the sound.

- 1 Play desired music.
- 2 Select the equalizer mode.

The equalizer mode includes the reference mode (R) (in which the MANUAL indicator is not lit) and the manual mode (M) (in which the MANUAL indicator is lit).

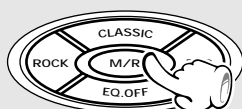
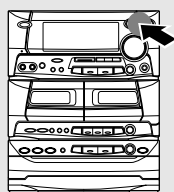

- 3 Select the desired equalizer pattern.

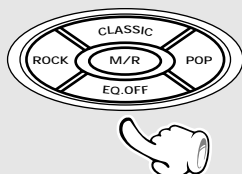
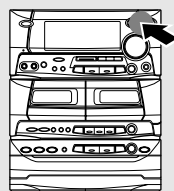

Example of reference mode display

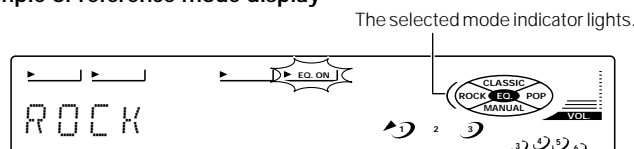

Example of manual mode display

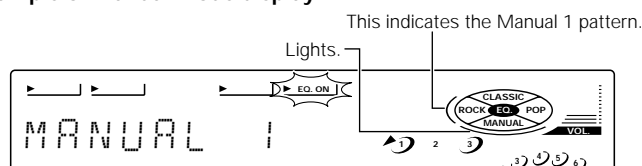

Equalizer patterns which can be recalled

In reference mode ("MANUAL" is not lit)
 ROCK key Rock music
 CLASSIC key Classic music
 POP key Pop music

In manual mode ("MANUAL" lit)
 ROCK key Manual 1
 CLASSIC key Manual 2
 POP key Manual 3

- + On the remote control unit, each press of the EQ key switches the equalizer patterns.
- + To cancel the equalizer effect, press the EQ OFF key or select "EQ OFF" with the EQ key of the remote control unit.
- + The equalizer effect cannot be switched on and off during recording.



Demonstration

When the demonstration function is activated, the equalizer and sound field effects change automatically as a CD, etc. is played.

When power is off (STANDBY):
 Each press switches the function alternately.



- 1 DEMO
- 2 OFF (Demonstration deactivated)

- + The demonstration of the display occurs while the power is off.
- + If the key is pressed while the power is ON, 5 kinds of spectrum analyzer display can be selected as well as the demonstration.

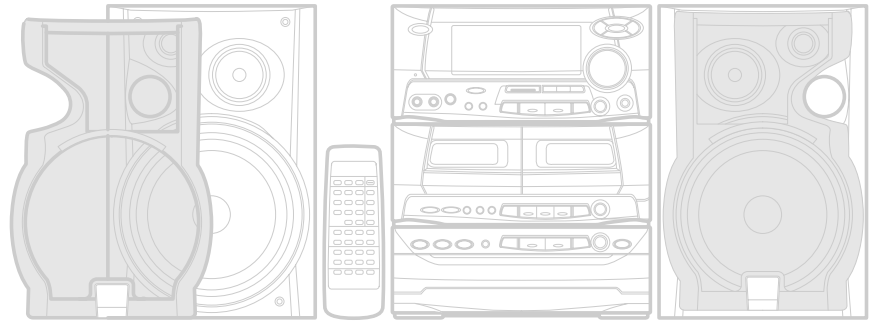

Creation and memorizing of an equalizer pattern

You can edit desired patterns manually and store them in memory.

- 1 Select the manual pattern number to store the created pattern.

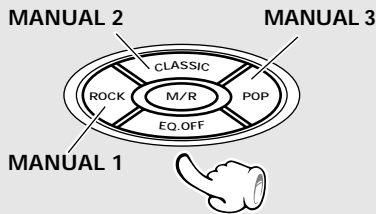
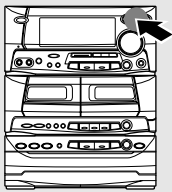

- 2 Display "MANUAL" (or make sure it is already displayed).

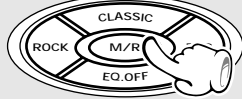
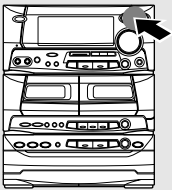

Go to step 3 within 3 sec.

- 3 Adjust the equalizer pattern.

Select the frequency band.



Adjust the level.

To decrease the level

To increase the level

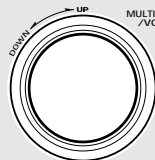

The LOW, MID and HIGH frequency bands can be adjusted independently.

- 4 Store the pattern in memory.

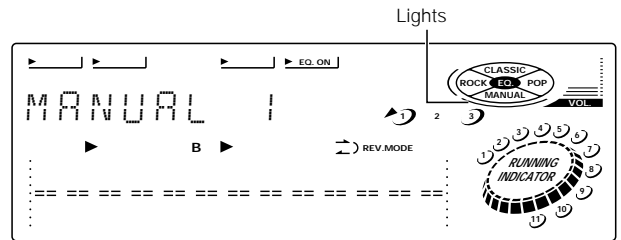
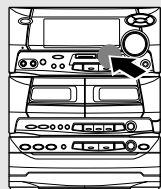

Each press of the key switches the frequency bands.

- 1 LOW Low frequencies (bass, bass drum, etc.)
- 2 MID Medium frequencies (vocals, guitars, etc.)
- 3 HIGH High frequencies (cymbals, etc.)

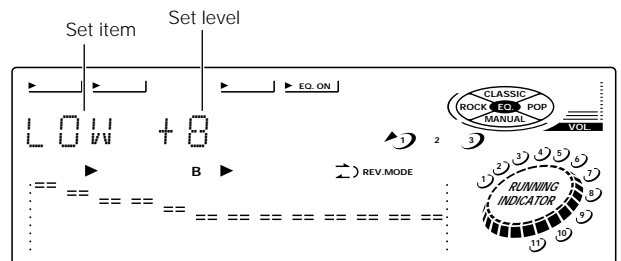

+ Each frequency band can be adjusted in the range between -8 and +8.

Enjoying Sound Field Effects

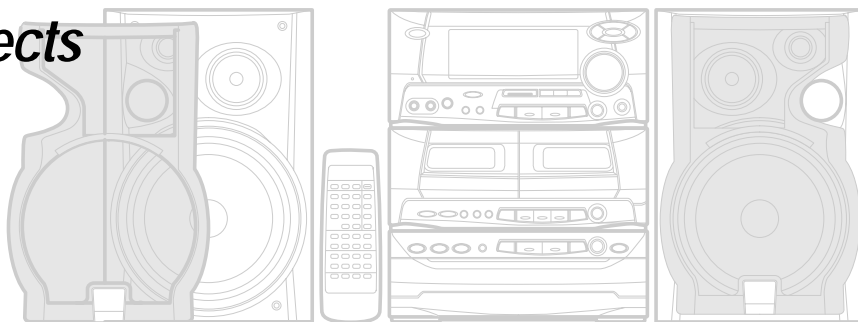

Experiencing SRS 3D (Sound Retrieval System) (XD-750/XD-700 only)

The Sound Retrieval System is an epochal system which produces a three-dimensional sound space by applying the most suitable processing to the sound signal on the basis of the human listening mechanism. This permits real depth and sound location, considered as difficult to realize with conventional 2-channel stereo (general stereo). A sufficient effect can be obtained for any source (CD, tape, broadcasts, etc.). Recording with applied SRS 3D also is possible.

① Set SRS 3D to ON.

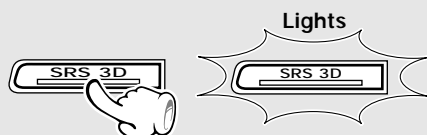
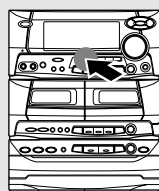

Each press of the key switches SRS 3D on and off alternately.

② Adjust the effect strength (level).

LEVEL will be displayed.

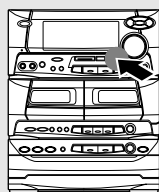

Adjust the strength of the effect.

The level increases.
The level decreases.

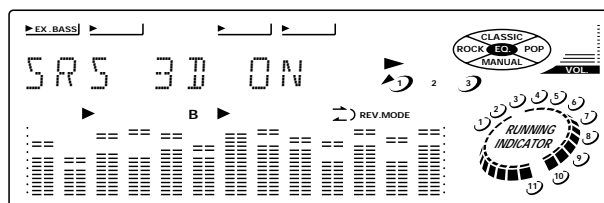
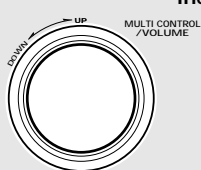

Each press switches the modes as follows.

- ① Strength of the SRS 3D effect (LEVEL)
- ② Left and right volume balance
- ③ Volume from the equipment connected to the AUX terminal (INPUT)
- ④ Normal volume adjustment (VOL)

+ SRS 3D ON/OFF switching is not possible during recording.

Level display

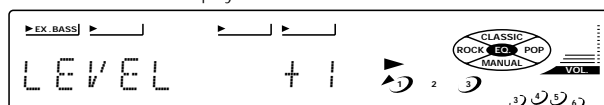

- + "INPUT" is displayed only when the AUX input is selected.
- + SRS 3D ON/OFF switching is not possible during recording.
- + Adjustment is possible in the range from -10 to +10.
- + Please set as desired according to the titles being played back etc.

SOURCE DIRECT for making the sound purer (XD-550/XD-500 only)

When SOURCE DIRECT is on, the signal path inside the system is simplified so that the sound can be reproduced with an improved purity.

① Play the desired music.

② Press the SOURCE DIRECT key.

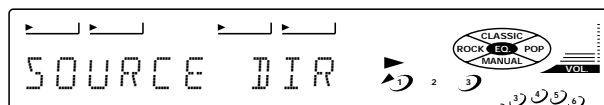
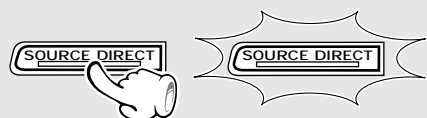
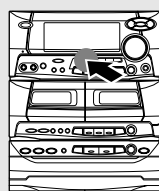

- + Other functions than the balance control cannot be used because the audio signals bypass the circuits.
- + Press the key again to switch SOURCE DIRECT off.

Enjoying Karaoke

When CDs or tapes with recorded voice and instrument music are played, it is possible to lower the volume only for the voice part. In combination with mic mixing, this permits easy enjoyment of Karaoke.

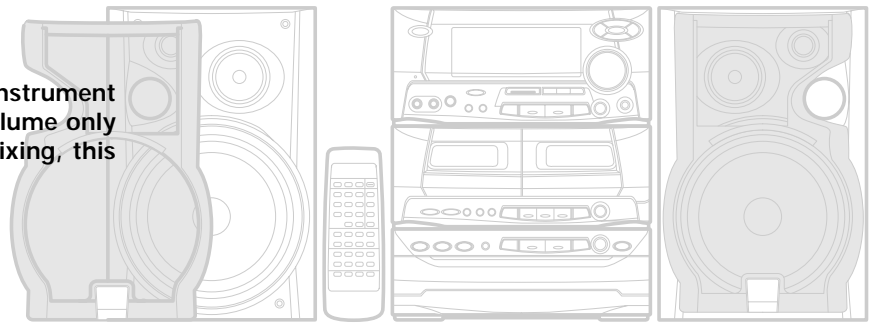

1 Connect a microphone.

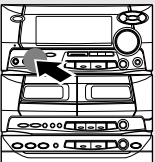

➊ Turn the MIC MIX. control fully counterclockwise.



MIN. MIC MIX. MAX.



➋ Plug the microphone into one of the MIC jacks.

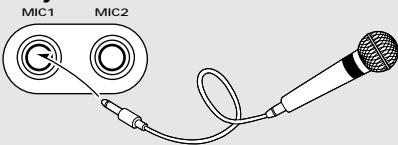

MIC1 MIC2



➌ Adjust the volume balance between the music input and microphone input.

To decrease microphone volume



To increase microphone volume

MIN. MIC MIX. MAX.

➤ The SOURCE DIRECT function should be off. (XD-550/XD-500 only)



➤ Set the MIC MIX. control knob to the fully counterclockwise position when the microphone is not used.

2 Play the music.

3 Sing along with the accompaniment.

After the above steps, you can record your karaoke singing onto a tape. However, note that the karaoke singing using a tape cannot be recorded onto a tape.

Enjoying Karaoke with software including the vocal part (HIT MASTER function)

This function makes it possible to enjoy music sources including vocal as pseudo Karaoke sources. This makes it possible to enjoy Karaoke even when no special Karaoke CDs or tapes are available.

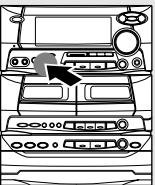

HIT MASTER



Each press switches HIT MASTER ON and OFF alternately.

- ➊ HIT MASTER ON
- ➋ HIT MASTER OFF



- The volume of the vocal parts of the song decreases. However, this effect may not be clear with some songs and discs.
- A Karaoke tape can be created by recording the performance while the MIC MIX. control is in the fully counterclockwise position.
- The HIT MASTER function is switched OFF when an equalizer effect is used.

This unit incorporates a clock function. Be sure to adjust the correct time before using the timer function. The time is displayed only while the power is off.

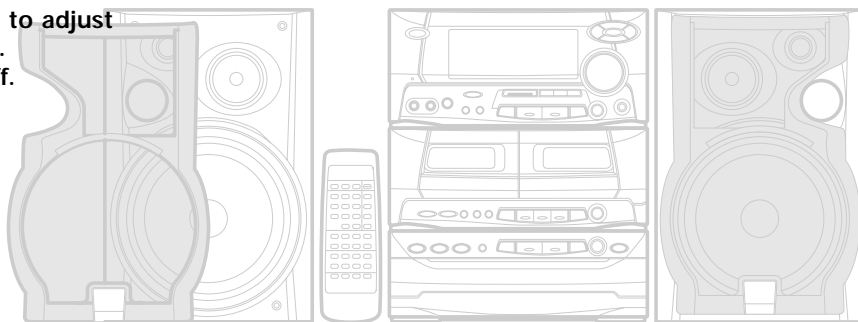

Ensure that the power is OFF.

1 Activate the clock adjustment mode.

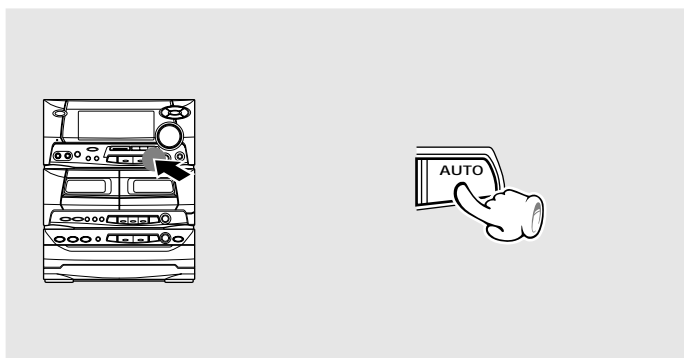

Example: Adjustment to 8:45

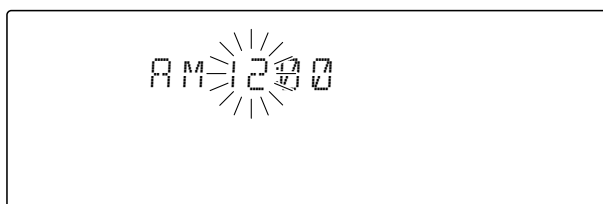

+ The time display starts to blink.

2 Enter the figure of hour.

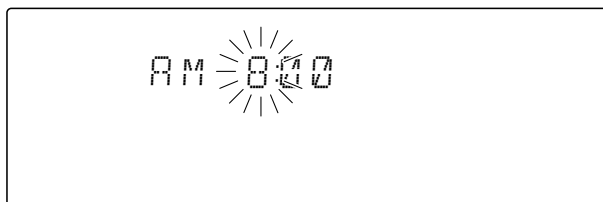
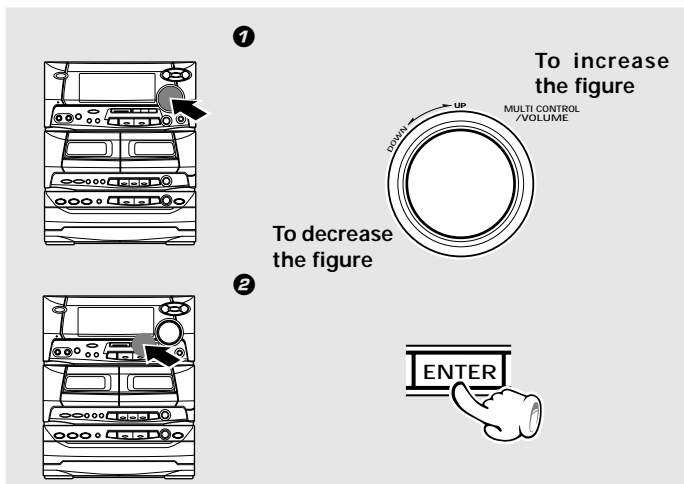

+ The time of the day is represented in 12-hour AM/PM method.
+ Press the **ENTER** key. The hour is entered and the minute display starts to blink.

3 Enter the figure of minute.

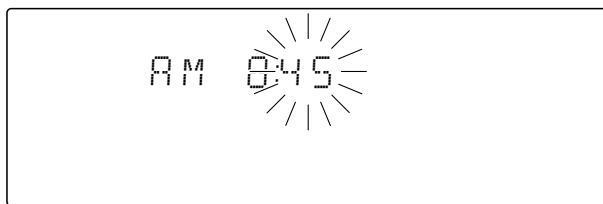
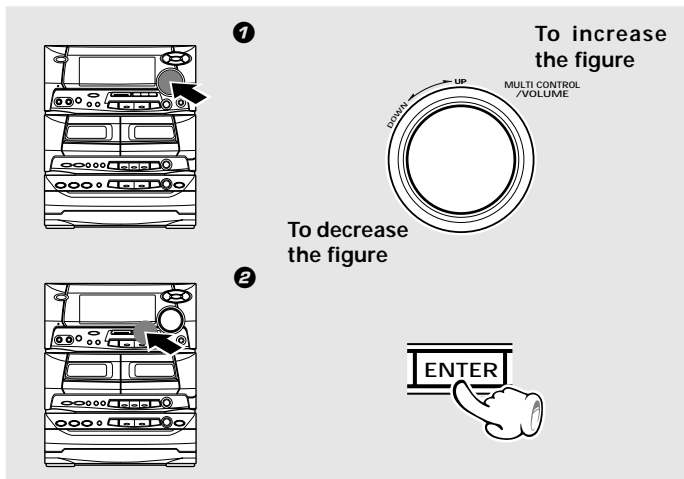

+ If you make a mistake, restart from the beginning.
+ To adjust correct time, press the **ENTER** key at the same moment as a time announcement.
+ The time display blinks after a power failure or when the power cord has been unplugged from the AC outlet and plugged again. In such a case, adjust the clock again.

Operate easy To use Timer (O.T.T.)

Playback of the selected input source starts at the specified time, and the power is switched off after one hour. This timer operates only once directly after setting.

Sleep timer (SLEEP)

The power is turned OFF automatically after the specified period has elapsed.

Timer playback, timer recording (PROG.1, PROG.2)

With each of the two timer programs, a selected source can be played (or radio broadcast can be recorded) in the previously set time period.

AI timer playback (PROG.1, PROG.2)

When timer playback starts, the volume increases gradually.

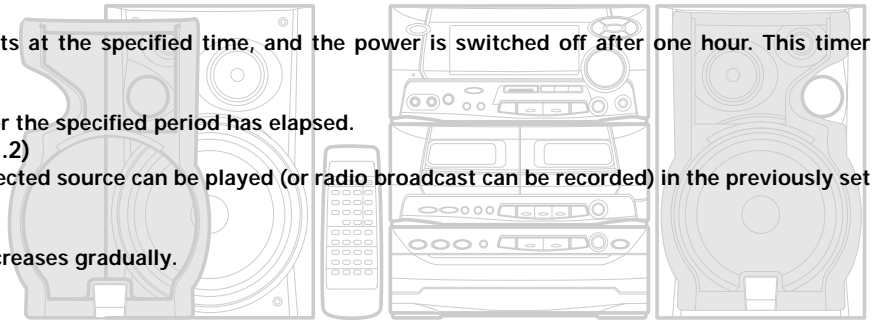

Adjust the clock before setting the timer.

Operate easy To use Timer (Operate easy To use Timer : O.T.T.)

Timer playback can be set with a simple operation of just setting the time. With this function, the last source selected before turning power off can be played by the timer. The power turned ON by the timer is switched off automatically in an hour after the timer playback starts.

- ❶ Select the desired source and adjust the volume.
- ❷ Switch OFF the power supply.
- ❸ Press the MODE key.

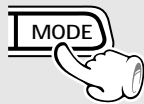

- ❹ Set the ON time.

The time is advanced.

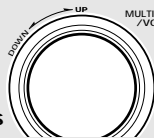

The time is returned.

- ❺ Press the ENTER key.



The program timer does not operate until O.T.T. operation has ended. At the time of tape playback by timer operation, the B deck has priority.

÷ When the **MODE** key is pressed, the input source will be displayed, and after a few seconds, the ON time will be displayed.

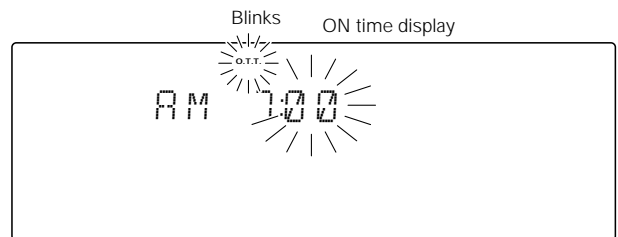

÷ The ON time can be set in steps of 5 minutes.

To cancel

Press the **MODE** key twice while the power is OFF.

Sleep timer (SLEEP)

Set the number of minutes after which the power is to be turned OFF.

- ❶ Turn the power ON.

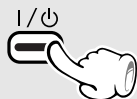
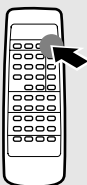

- ❷ Set the time.

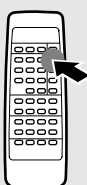

÷ The power is turned OFF automatically after the set time has elapsed.
 ÷ Each press decreases the time by 10 minutes. The maximum time that can be set is 90 minutes.

90→80→70...30→20→10→Cancel→90→80...

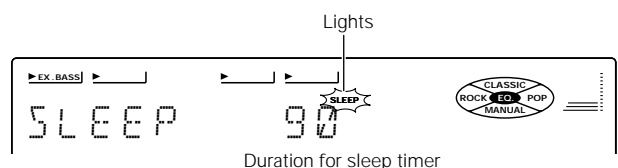

To cancel

Turn the power OFF or press the **SLEEP** key until the sleep time is cancelled.

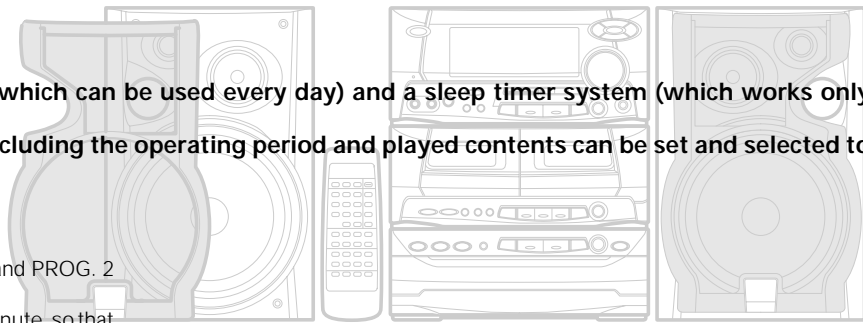

Timer programming

Two 24-hour timer systems (PROG.1, PROG.2) (which can be used every day) and a sleep timer system (which works only once) are available. In each of PROG.1 and PROG.2, the timer data including the operating period and played contents can be set and selected to be activated or not as required.

- + Timer reservation is possible for the two types PROG.1 and PROG. 2 at the same time.
- + Please make reservations with an interval of at least one minute, so that the operation times of PROG. 1 and PROG. 2 do not overlap.

Adjust the clock before setting the timer.

1 Make preparations for the play (recording).

+ To listen to radio

The station should be preset prior to the above. ∞

+ To listen to CD

Insert a disc. (Program playback is not possible.)

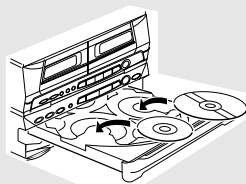

Select the disc to be played (1, 2 or 3).

+ To listen to tape

Set a tape into deck B.

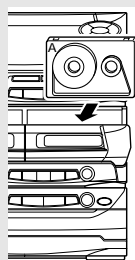

The B deck has priority at the time of timer playback.

+ Playing the auxiliary input source

Make timer setting of the component connected to the AUX jacks.

+ For recording

Make preparations for recording. → 26

2 Adjust the listening volume.

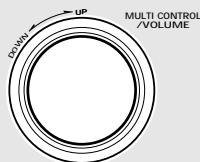
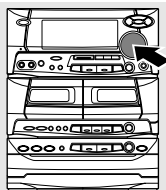

+ When recording radio, the listening volume is automatically set to the minimum volume at the moment the power is turned ON by the timer.

3 Set the POWER switch to OFF (STANDBY) position.

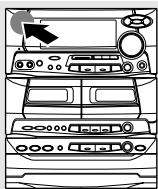

4 Select a program No.

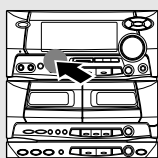

1



Within 8 seconds!



2



Each press of the key switches the program numbers as follows.

- ① PROG.1 Program 1
- ② PROG.2 Program 2
- ③ Normal operation

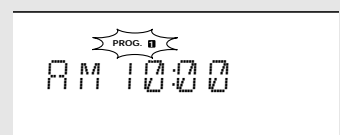

Application section

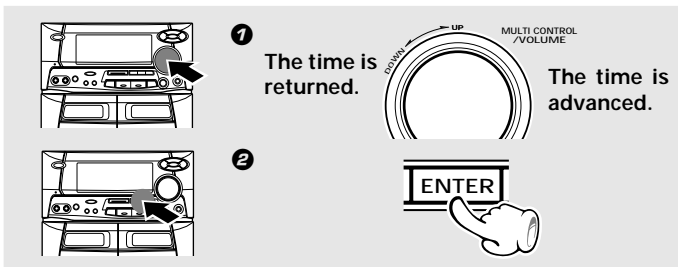
5 Enter the ON time.

→ After entering the figure of "hour" with the procedure in **1** and **2**, enter the figure of "minute" using the same procedure.

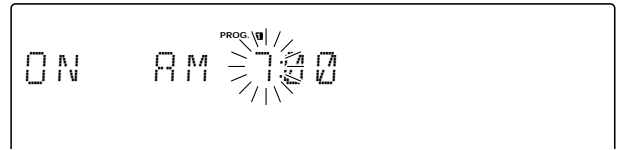

→ If you commit a mistake, restart from step **1**.

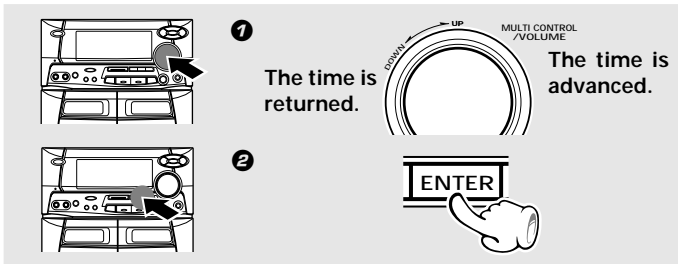
6 Enter the OFF time.

→ After entering the figure of "hour" with the procedure in **1** and **2**, enter the figure of "minute" using the same procedure.

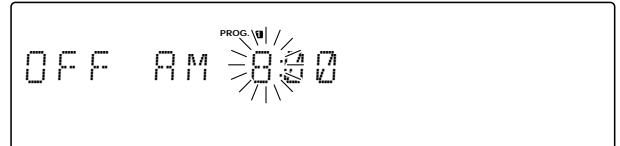

→ If you commit a mistake, restart from step **1**.

7 Make the desired reservation.

For timer playback or AI timer playback

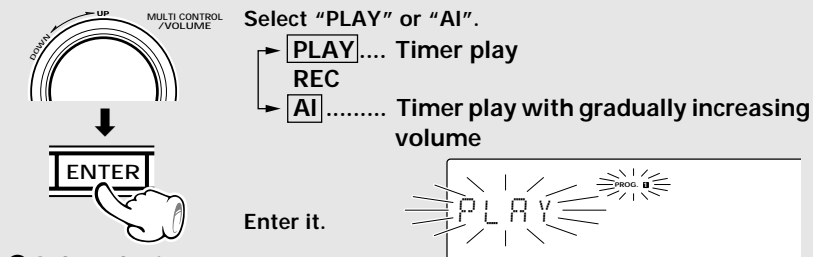
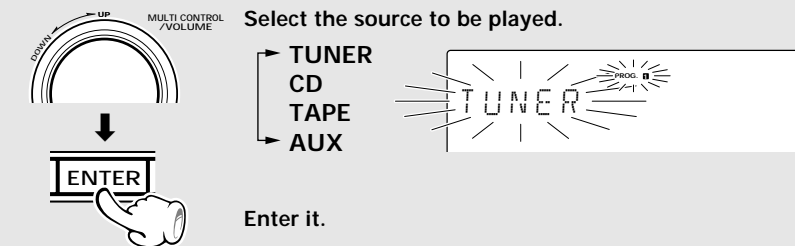
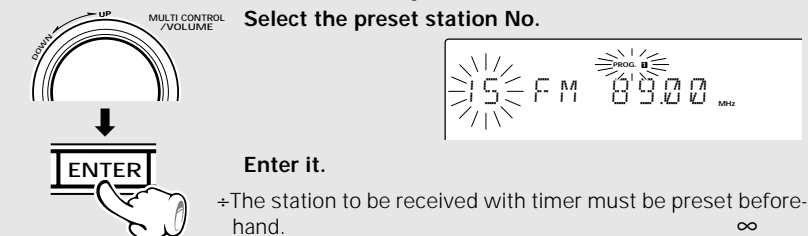
1 Select the mode.**2** Select the input source.**3** Select the broadcast station (only when TUNER is selected above).

Timer recording of radio broadcasts

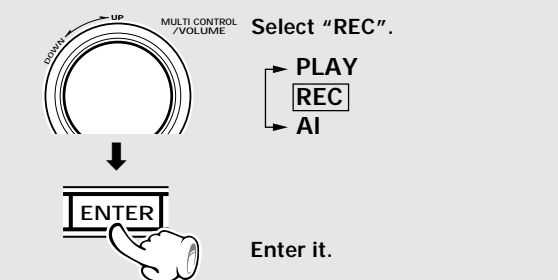
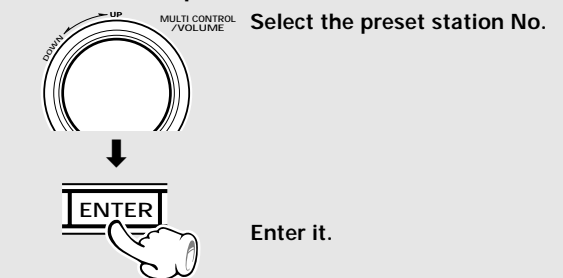
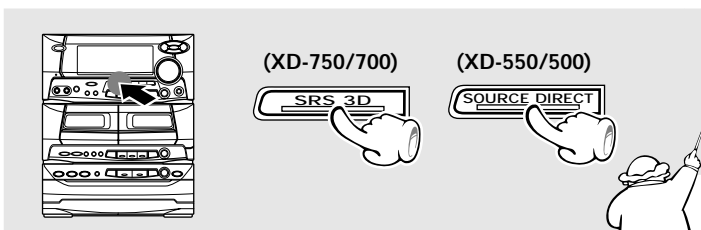
1 Select the mode.**2** Select the input source.**8** Select the timer program No. to be used.

Each press of the key switches the program numbers as follows.

- ① PROG.1 Execution of program 1 only.
- ② PROG.2 Execution of program 2 only.
- ③ PROG.1, 2 . Execution of programs 1 and 2.
- ④ Timer OFF

→ The selected program No. lights.

→ The timer will not function unless a program No. is selected.

Ensure that the power is OFF.



The reservation contents cannot be cleared. The contents are cleared only when they are changed.

Check the reservation content.

Select the program number to be checked.

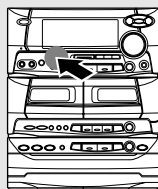

EX. BASS



Each press of the key switches the program numbers as follows.

→ PROG.1 Display of program 1
 → PROG.2 Display of program 2
 → Normal mode

± The reserved contents will be displayed for 3 seconds per item. After this, the previous display content appears again.

To change the reserved contents

Restart the procedure of "Timer programming" from the beginning.

When timer operation is not required

Press so that all PROG. indicators are OFF.

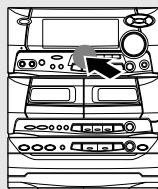

(XD-750/700)



(XD-550/500)



Each press of the key switches the program numbers as follows.

→ PROG.1 Program 1 operates.
 → PROG.2 Program 2 operates.
 → PROG.1, 2 Programs 1 and 2 operate.
 → Not lit No program operates.

± The reservation contents are held in memory.

To set the same timer program again

Press so that the desired PROG. indicators lights.

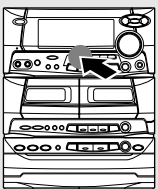

(XD-750/700)



(XD-550/500)



Each press of the key switches the program numbers as follows.

→ PROG.1 Program 1 operates.
 → PROG.2 Program 2 operates.
 → PROG.1, 2 Programs 1 and 2 operate.
 → Not lit No program operates.

± Also prepare the disc or tape and adjust the listening volume.

Maintenance

Cleaning the head section

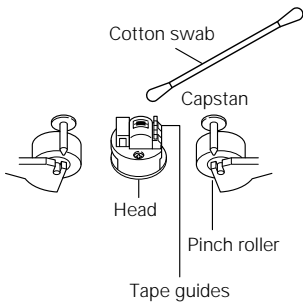

Cleaning the heads and peripheral components

For maintaining the best condition of the deck and for longer service life, always keep the heads (recording / playback / erase), capstan and pinch roller clean. To clean them, perform the following:

1. Open the cassette holder.
2. Using a cotton swab dipped in alcohol, clean the head (recording / playback / erase), capstan and pinch roller carefully.

Demagnetizing the head

When the recording / playback head is magnetized, the sound quality will deteriorate. In such a case, demagnetize the head using a commercially available demagnetizer (head eraser).



There are precisely aligned parts around the heads, including the tape guides. When cleaning, pay special attention so as not to apply shock to them.

Maintenance of the set

When the front panel or case becomes dirty, wipe with a soft, dry cloth. Do not use thinner, benzine, alcohol, etc. for these agents may cause discoloration.

In regard to contact cleaner

Do not use contact cleaners because it could cause a malfunction. Be specially careful not to use contact cleaners containing oil, for they may deform the plastic component.

Reference

Beware of condensation

When water vapor comes into contact with the surface of a cold material, condensation is produced.

If condensation occurs, correct operation may not be possible, or the unit may not function correctly.

This is not a malfunction, however, and the unit should be dried-out. (To do this, turn the ON/STANDBY switch ON and leave the unit as it is for several hours.)

Be especially careful in the following conditions:

- + When the unit is brought from a cold place to a warm place, and there is a large temperature difference.
- + When a heater starts operating.
- + When the unit is brought from an air-conditioned place to a place of high temperature with high humidity.
- + When there is a large difference between the internal temperature of the unit and the ambient temperature, or in conditions where condensation occurs easily.

Sound Retrieval System manufactured under licence from SRS Labs, Inc. "SOUND RETRIEVAL SYSTEM" and the SRS Symbol (●) are trademarks of SRS Labs, Inc. Purchase of this product does not convey the right to sell recordings made with the SOUND RETRIEVAL SYSTEM.

Dolby noise reduction manufactured under license from Dolby Laboratories Licensing Corporation. "DOLBY" and the double-D symbol are trademarks of Dolby Laboratories Licensing Corporation.

Note related to transportation and movement (CD player)

Before transporting or moving this unit, carry out the following operations.

1. Turn the power ON but do not load a disc.
2. Ensure that the display is as shown below.

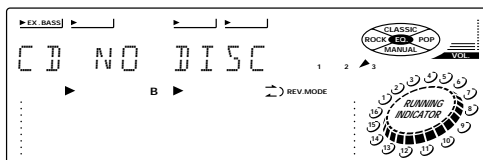

3. Wait for a few seconds then turn power off.

Memory backup function

Stored contents which are cleared immediately when power plug is unplugged from power outlet	Clock display
Stored contents which are cleared in at least a day after power plug is unplugged from power outlet	Amplifier POWER status (ON or OFF) Input selection Volume control value Equalizer's manual memory created by the user SRS 3D level Tuner unit Receiving band Frequency Preset stations Program timer setting contents Cassette deck unit Transport direction DOLBY NR Reverse mode

When your unit needs to be repaired, bring the entire set (Speakers excluded) to your dealer.

What seems to be a malfunction is not always so. Before calling for service, check the following table according to the symptom of your trouble.

Operation to reset

The microcomputer may fall into malfunction (impossibility to operate, erroneous display, etc.) when the power cord is unplugged while power is ON or due to an external factor. In this case, execute the following procedure to reset the microcomputer and return it to normal condition.

+ Please note that resetting the microcomputer clears the contents stored in and returns and to condition when it left the factory.

Reset using a sharp-tipped object.

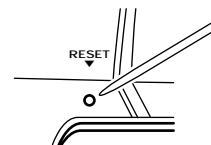
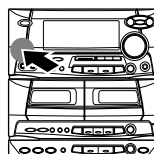

Remote control unit

Symptom	Cause	Remedy
Remote control operation is not possible.	<ul style="list-style-type: none"> + Batteries are exhausted. + The remote control is too far away from the system, the controlling angle is deviated or there is an obstacle in between. + There is no tape or CD set in the component to be played. + An attempt is made to play the cassette deck which is recording something. 	<ul style="list-style-type: none"> + Replace with new batteries. → 14 + Operate the unit inside the remote control-able range. → 14 + Set a tape or CD in the component to be played. + Wait until the recording ends.

















Receiver, speakers

Symptom	Cause	Remedy
Sound is not produced.	<ul style="list-style-type: none"> + The speaker cords are disconnected. + The volume control is set to the minimum position. + The MUTE switch of remote control unit is switched ON. + The headphone plug is inserted into the jack. 	<ul style="list-style-type: none"> + Connect properly referring to "System connection". → 6 + Adjust to an required volume. → 16 + Switch MUTE OFF. → 17 + Unplug the headphone plug. → 17
The character display blinks and sound is not produced.	<ul style="list-style-type: none"> + The speaker cords are short-circuited. 	<ul style="list-style-type: none"> + Turn the power OFF, remove the short-circuit and turn the power ON again. → 6
Sound is not produced from the left or right speakers.	<ul style="list-style-type: none"> + The speaker cords are disconnected. 	<ul style="list-style-type: none"> + Connect properly referring to "System connection". → 6
The clock display blinks without changing the figures.	<ul style="list-style-type: none"> + There was a power failure. + The power cord was unplugged from the outlet. 	<ul style="list-style-type: none"> + Adjust the present time again. → 50 + Adjust the present time again. → 50
Timer operation is not possible.	<ul style="list-style-type: none"> + The present time has not been adjusted or there was a power failure. + The timer ON time and OFF time have not been set. + The timer execution was not set up. 	<ul style="list-style-type: none"> + Adjust the present time referring to "Clock adjustment". → 50 + Set the timer ON time and OFF time. → 52 + Execute the timer program with the SRS 3D (SOURCE DIRECT)* key. → 53
Radio stations cannot be received.	<ul style="list-style-type: none"> + The antennas have not been connected. + A proper broadcasting band has not been selected. + The frequency of the station to be received is not tuned. 	<ul style="list-style-type: none"> + Connect antennas. → 6 + Select a band. → 24 + Tune to the frequency of the desired station. → 24
Noise interferes.	<ul style="list-style-type: none"> + Car ignition noise. + Influence of an electric appliance. + A TV set is installed near the system. 	<ul style="list-style-type: none"> + Install the outdoor antenna in an apart position from the road. → 9 + Switch the suspected electric appliance OFF. + Install the TV or the system at an increased distance between them.

* The key inside () is used only with the XD-550/XD-500.

A station has been preset but it cannot be received by pressing the P.CALL key.	<ul style="list-style-type: none"> ÷ The frequency of the preset station is not tunable. ÷ The preset memory has been cleared because the power cord has been unplugged for a long period. 	<ul style="list-style-type: none"> + Preset stations with tunable frequencies. ∞ + Preset stations again. ∞
Demonstration starts suddenly.	<ul style="list-style-type: none"> ÷ The power plug was unplugged from the outlet while the power switch was ON, or there was a power failure. 	<ul style="list-style-type: none"> + This is not malfunction. Press the DISP./ DEMO key to cancel the demonstration. →  46

Cassette deck

Symptom	Cause	Remedy
Sound cannot be produced by pressing the play key or no operation occurs even when an operation key is pressed.	<ul style="list-style-type: none"> ÷ The head is dirty. ÷ The tape is wound too tight due to irregular winding. ÷ A nonrecorded tape is played. 	<ul style="list-style-type: none"> + Clean the head referring to "Maintenance". →  55 + Try another tape. + Play a recorded tape.
No operation occurs even when an operation key is pressed.	<ul style="list-style-type: none"> ÷ The cassette holder is not closed completely. ÷ The operation key is pressed immediately after closing the cassette holder. ÷ The operation key is pressed in less than 4 seconds after turning the power ON. ÷ A tape is not inserted in the unit. ÷ The tape is wound too tight due to irregular winding. ÷ The tape is fully wound to one of the reels. 	<ul style="list-style-type: none"> + Close the holder completely. →  20 + Press operations keys in more than a few seconds after closing the holder. + Press operation keys after waiting for more than 4 seconds. + Insert a tape. →  20 + Try another tape. + Change the tape transport direction or reverse the tape insertion orientation. →  20
The DPSS malfunctions.	<ul style="list-style-type: none"> ÷ The tape used is not suitable for DPSS, for example the spaces between tunes may be too short. 	<ul style="list-style-type: none"> + Refer to "Searching for the desired music program (DPSS)". →  23
In dubbing, the tape stops at different moments in decks A and B.	<ul style="list-style-type: none"> ÷ This is due to the difference in the tape length or characteristics of the mechanisms of two cassette decks. 	<ul style="list-style-type: none"> + Small time difference does not mean a malfunction.
The cassette holders cannot be opened by pressing the PUSH OPEN area.	<ul style="list-style-type: none"> ÷ The key is pressed during recording or playback. ÷ The microcomputer is malfunctioning due to external noise. 	<ul style="list-style-type: none"> + Press in stop mode. + Reset the microcomputer. →  56
Sound is harsh or high frequencies are not reproduced.	<ul style="list-style-type: none"> ÷ The head is dirty. ÷ The tape is stretched or shrunk. 	<ul style="list-style-type: none"> + Clean the head referring to "Maintenance". →  55 + Try another tape.
Sound is distorted.	<ul style="list-style-type: none"> ÷ The tape being played was recorded with distorted sound. 	<ul style="list-style-type: none"> + Try another tape.
Noise is noticeable.	<ul style="list-style-type: none"> ÷ The tape head is magnetized. ÷ External noise is induced. ÷ A tape recorded with Dolby NR ON is played with Dolby NR OFF. 	<ul style="list-style-type: none"> + Demagnetize the head referring to "Maintenance". →  55 + Install the system at a distance from other electric appliances and TV. + Set the Dolby NR to on. →  21
Sound vibrates.	<ul style="list-style-type: none"> ÷ The capstans or pinch rollers are dirty. ÷ The tape is wound irregularly. 	<ul style="list-style-type: none"> + Clean the head referring to "Maintenance". →  55 + Wind the tape again by fast forwarding, rewinding or playing from an end to the other. →  21
Recording cannot be started by pressing the record key.	<ul style="list-style-type: none"> ÷ The recording protect tab of the cassette has been broken. ÷ The cassette holder is not closed completely. ÷ The TAPE input is selected. ÷ The tape is fully wound to one of the reels. 	<ul style="list-style-type: none"> + Use a cassette with an unbroken recording protect tab or block the hole. →  5 + Close the holder completely. →  20 + Select the source to be recorded with the input selector key. →  26 + Change the tape transport direction of deck B or reverse the tape insertion orientation. →  26
Volume of the recorded track changed.	<ul style="list-style-type: none"> ÷ MIC MIX. control knob is moved during recording. 	<ul style="list-style-type: none"> + Fully turn the MIC MIX. control knob to the left. →  49

CD player

Symptom	Cause	Remedy
A CD is placed in the player but it cannot be played.	<ul style="list-style-type: none"> ÷ The disc is placed upside down. ÷ The disc position is displaced. ÷ The disc is extremely dirty. ÷ The disc is scratched. ÷ Dew is condensed on the optics lens. 	<ul style="list-style-type: none"> ÷ Place the disc properly, with the label side facing upward. → 18 ÷ Place the disc properly. → 18 ÷ Clean the disc referring to "Disc handling precautions". → 5 ÷ Try another disc. ÷ Refer to "Beware of condensation" and remove the condensation by evaporation. → 55
Sound is not produced.	<ul style="list-style-type: none"> ÷ The disc has not been placed. ÷ The player is not put to the play mode. ÷ The disc is extremely dirty. ÷ The disc is scratched. 	<ul style="list-style-type: none"> ÷ Place a disc in the CD player. → 18 ÷ Press the play key. → 18 ÷ Clean the disc referring to "Disc handling precautions". → 5 ÷ Try another disc.
Sound skips.	<ul style="list-style-type: none"> ÷ The disc is dirty. ÷ The disc is scratched. ÷ The player is subject to vibration. 	<ul style="list-style-type: none"> ÷ Clean the disc referring to "Disc handling precautions". → 5 ÷ Try another disc. ÷ Install the unit in a place not subject to vibrations.



1. With some tapes, a squeaky noise is produced when the tape is stopped automatically. This is due to the tape protection function, and not a malfunction.
2. Do not use longer tape than 110 minutes tapes, for the tape is too thin and gets easily tangled.

WARNING NOTICE:

IN MOST CASES IT IS AN INFRINGEMENT OF COPYRIGHT TO MAKE COPIES OF TAPES OR DISCS WITHOUT THE PERMISSION OF THE COPYRIGHT OWNERS. ANYONE WISHING TO COPY COMMERCIALY AVAILABLE TAPES OR DISC SHOULD CONTACT THE MECHANICAL COPYRIGHT PROTECTION SOCIETY LIMITED OR THE PERFORMING RIGHTS SOCIETY LIMITED.

Main unit (RXD-750/700/550/500)

[Amplifier section]

Rated power output (RXD-750/700)

STEREO MODE

100 watts per channel minimum RMS, both channels driven, at 6 Ω, 1 kHz with no more than 10 % total harmonic distortion.

(DIN) 1 kHz at 6 Ω, 0.7 % T.H.D. 70 W + 70 W

Rated power output (RXD-550/500)

STEREO MODE

70 watts per channel minimum RMS, both channels driven, at 6 Ω, 1 kHz with no more than 10 % total harmonic distortion.

(DIN) 1 kHz at 6 Ω, 0.7 % T.H.D. 50 W + 50 W

Input sensitivity / Impedance

AUX 200 mV / 30 kΩ

MIC 3.0 mV / 20 kΩ

Signal to noise ratio

AUX 85 dB (IHF'66)

[FM Tuner section]

Tuning frequency range 87.5 MHz ~ 108 MHz

[MW (AM) Tuner section]

Tuning frequency range 531 kHz ~ 1,602 kHz

[LW Tuner section]

Tuning frequency range 153 kHz ~ 279 kHz

[Cassette deck section]

Track 4-track, 2-channel stereo

Recording system AC bias system
(Frequency: 105 kHz)

Heads

A deck Playback head 1

B deck Playback / recording head 1

Erasing head 1

Motors 2

Fast winding time Approx. 115 seconds
(C-60 tape)

[CD player section]

Laser Semiconductor laser

Playing rotation 200 rpm ~ 500 rpm (CLV)

Wow & Flutter Unmeasurable Limit

General

Power consumption

RXD-750/700 200 W

RXD-550/500 150 W

Dimensions W: 270 mm

H: 330 mm

D: 357 mm

Weight (net)

RXD-750/700 10.2kg

RXD-550/500 9.5 kg

Speakers (LS-N750/N700)

Enclosure Bass-reflex type

Speaker configuration 3-Way system

MAIN

Woofers 180 mm, cone type

Tweeter 65 mm, cone type

Super tweeter 25 mm, dome type

Impedance 6 Ω

Maximum input level 100 W

General

Dimensions W: 220 mm

H: 330 mm

D: 316 mm

Weight (net) 4.1 kg (1 piece)

Speakers (LS-N550/N500)

Enclosure Bass-reflex type

Speaker configuration 3-Way system

MAIN

Woofers 160 mm, cone type

Tweeter 65 mm, cone type

Super tweeter 25 mm, dome type

Impedance 6 Ω

Maximum input level 100 W

General

Dimensions W: 200 mm

H: 330 mm

D: 278 mm

Weight (net) 3.7 kg (1 piece)



1. KENWOOD follows a policy of continuous advancements in development. For this reason specifications may be changed without notice.
2. Sufficient performance may not be possible at very low temperatures (0°C or less).

KENWOOD

For your records

Record the serial number, found on the back of the unit, in the spaces designated on the warranty card, and in the space provided below. Refer to the model and serial numbers whenever you call upon your dealer for information or service on this product.

Model _____

Serial Number _____

Free Manuals Download Website

<http://myh66.com>

<http://usermanuals.us>

<http://www.somanuals.com>

<http://www.4manuals.cc>

<http://www.manual-lib.com>

<http://www.404manual.com>

<http://www.luxmanual.com>

<http://aubethermostatmanual.com>

Golf course search by state

<http://golfingnear.com>

Email search by domain

<http://emailbydomain.com>

Auto manuals search

<http://auto.somanuals.com>

TV manuals search

<http://tv.somanuals.com>