

KENWOOD

COMPONENT SYSTEM/COMPACT HI-FI SYSTEM

XD-980MD

INSTRUCTION MANUAL

KENWOOD CORPORATION



B60-3000-00 (SI) (AP) (T)

98/12 11 10 9 8 7 6 5 4 3 2 1 97/12 11 10 9 8 7 6 5 4 3 2 1

2 Before applying power

 **Caution : Read this page carefully to ensure safe operation.**

XD-980MD (En)

Units are designed for operation as follows.

Europe and U.K. AC 230 V only

For the United Kingdom

Factory fitted moulded mains plug

1. The mains plug contains a fuse. For replacement, use only a 13-Amp ASTA-approved (BS 1362) fuse.
2. The fuse cover must be refitted when replacing the fuse in the moulded plug.
3. Do not cut off the mains plug from this equipment. If the plug fitted is not suitable for the power points in your home or the cable is too short to reach.
A power point, then obtain an appropriate safety approved extension lead or adapter, or consult your dealer.
If nonetheless the mains plug is cut off, remove the fuse and dispose of the plug immediately, to avoid a possible shock hazard by inadvertent.
Connection to the mains supply.

IMPORTANT : The wires in the mains lead are coloured in accordance with the following code :





Blue : Neutral
Brown : Live

Do not connect those leads to the earth terminal of a three-pin plug.

Preparation section

Safety precautions

WARNING : TO PREVENT FIRE OR ELECTRIC SHOCK, DO NOT EXPOSE THIS APPLIANCE TO RAIN OR MOISTURE.

 	CAUTION RISK OF ELECTRIC SHOCK DO NOT OPEN	CAUTION: TO REDUCE THE RISK OF ELECTRIC SHOCK, DO NOT REMOVE COVER (OR BACK). NO USER-SERVICEABLE PARTS INSIDE, REFER SERVICING TO QUALIFIED SERVICE PERSONNEL.
	THE LIGHTNING FLASH WITH ARROWHEAD SYMBOL, WITHIN AN EQUILATERAL TRIANGLE, IS INTENDED TO ALERT THE USER TO THE PRESENCE OF UNINSULATED "DANGEROUS VOLTAGE" WITHIN THE PRODUCT'S ENCLOSURE THAT MAY BE OF SUFFICIENT MAGNITUDE TO CONSTITUTE A RISK OF ELECTRIC SHOCK TO PERSONS.	
	THE EXCLAMATION POINT WITHIN AN EQUILATERAL TRIANGLE IS INTENDED TO ALERT THE USER TO THE PRESENCE OF IMPORTANT OPERATING AND MAINTENANCE (SERVICING) INSTRUCTIONS IN THE LITERATURE ACCOMPANYING THE APPLIANCE.	

REQUIREMENT BY NEDERLAND GAZETTE

Batteries are supplied with this product. When they empty, you should not throw away. Instead, hand them in as small chemical waste.

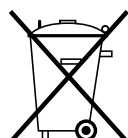



The marking of products using lasers (Except for some areas)

**CLASS 1
LASER PRODUCT**

The marking is located on the rear panel and says that the component uses laser beams that have been classified as Class 1. It means that the unit is utilizing laser beams that are of a weaker class. There is no danger of hazardous radiation outside the unit.

Contents

Preparation section

 Before applying power	2
 Safety precautions	2
Contents	3
Special features	4
Handling of discs	5
System connection	6
Connection of the System Accessories	6
Connection of Options (Optional Parts)	8
Controls and indicators	10
Main unit	10
Display	12
Remote control Unit	14
Operation of remote control unit	15

Basic section

Let's put out some sound	16
Basic use method	16
Playback of CD	18
Playback of Mini Disc	20
Receiving broadcast station	24
Let's record	26
Recording on MD	26

Application section

Playback of CD	29
Listening in the desired sequence (program playback)	29
Repeated playback	31
Listening to an unexpected title sequence (random playback)	33
Playback of MD	34
Listening in the desired sequence (program playback)	34
Repeated playback	36
R.D.S. (Radio Data System)	37
Searching for a desired program type (PTY search)	38
To be able to listen to the desired information at any time ...	40

Convenient Recording Methods	42
Selection of the Recording type	42
One-touch recording of one CD, MD (One-touch edit recording of all tracks)	44
When a desired track is found, only that track is recorded (One-touch edit recording of one track)	45
Producing a MD collecting only the first titles (BEST HITS function)	46
Producing a tape collecting only the first titles (BEST HITS function)	47
Recording of one CD or several CDs (CD→MD) (Program recording)	48
Recording of one CD or several CDs (CD→TAPE) (Program recording)	49
Change of the track sequence according to the tape length (CD→TAPE only) (Time edit recording)	50
Fade-out/Fade-in at the tape reversal (CD→TAPE only) (Fade edit recording)	52
MD Edit Functions	53
Selecting the editing function type	53
Assigning a title to a disc or track	54
Changing or deleting a title	55
Moving several tracks at a time (QUICK MOVE)	56
Moving a single track (TRACK MOVE)	57
Dividing a track (TRACK DIVIDE)	58
Combining two tracks (TRACK COMBINE)	59
Erasing a single track (TRACK ERASE) or erasing all tracks on a disc (ALL ERASE)	60
Effective Sound Field and Sound Quality Adjustment ...	62
Adjustment of balance and input level	62
Listening with the desired sound (equalizer function)	63
Enjoying Sound Field Effects	65
Enjoying Karaoke	66
Clock adjustment	68
Timer operation	69
Operate easy To use Timer (O.T.T.)	69
Sleep timer	69
Timer programming	70

Knowledge section

Important Items	73
Maintenance	73
Reference	73
MD system	74
Digital recording and SCMS	75
In case of difficulty	76
Specifications	80



Special features *An MD recorder is standard equipment*

→ 20

An MD recorder with high digital sound quality is standard equipment. Digital copying from a CD is also easy. This recorder has many functions like recording and display of names for discs and titles, changing the sequence of tracks, etc.

SRS 3D stereo system

→ 65

This is an epochal system called Sound Retrieval System, which creates a three-dimensional sound space. The feeling of depth, the width of the sound field, the sound image positioning, etc. all are clearly improved, and the listening area also is widened. (Retrieval is used in the meaning of recovery or restoration.)

Convenient Recording Methods

→ 42

Various versatile recording functions are provided according to the use purposes. When the cassette deck X-H9 (sold separately, not sold in some areas or countries) is connected, edit recording to tape is also possible from other sources.

- + One-touch edit : Recording of one CD or MD or one track by pressing a single key
- + BEST HITS function : Sequential recording of the first track of each CD onto MD or tape
- + Program recording : Any desired tracks can be recorded in the desired sequence
- + Time edit recording : Recording so that no track will be interrupted within the specified time (only from CD to tape)
- + Fade edit recording : Sequential recording from the first track (only from CD to tape)

Versatile tone and sound field adjustment

→ 62

The tone can be selected according to the genre of the music played:
POP, ROCK, CLASSIC.

Convenient timer functions

→ 69

In addition to the possibility of storing up to 2 timer programs in memory, the following functions are available.

- + AI timer : When the unit is turned ON by the timer, the sound level increases gradually.
- + O.T.T. : A timer with easy setting, which operates only once.
- + Sleep timer : Useful when you want to go asleep while listening to music.

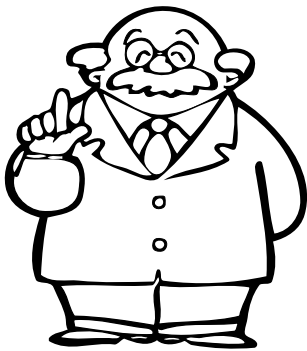

Unpacking

Unpack the unit carefully and make sure that all accessories are put aside so they will not be lost.

Examine the unit for any possibility of shipping damage. If your unit is damaged or fails to operate, notify your dealer immediately. If your unit was shipped to you directly, notify the shipping company without delay. Only the consignee (the person or company receiving the unit) can file a claim against the carrier for shipping damage.

We recommend that you retain the original carton and packing materials for use should you transport or ship the unit in the future.

Accessories

Please confirm that the following accessories are present.

FM indoor antenna (1)

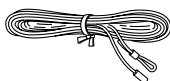

Loop antenna (1)

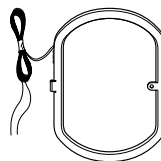

AM loop antenna stand (1)

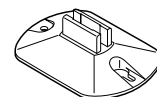

Speaker cords (2)



Remote control unit (1)



Batteries (R6/AA) (2)



Handling of discs

Disc handling precautions

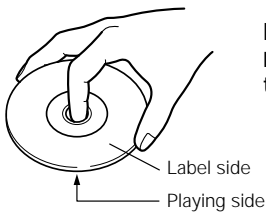

Handling

Hold compact discs so that you do not touch the playing surface.

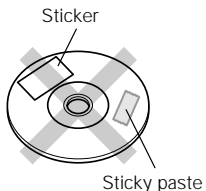

Do not attach paper or tape to either the playing side or the label side of compact discs.

The paste left on the label surface after a sticker has been peeled off is a factor which may cause malfunction. If the surface is sticky due to remaining paste, be sure to clean it with alcohol before use.

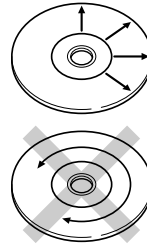

Cleaning

If fingerprints or foreign matter become attached to the disc, lightly wipe the disc with a soft cotton cloth (or similar) from the center of the disc outwards in a radial manner.

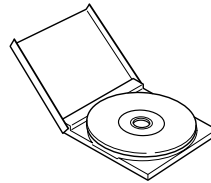

Storage

When a disc is not to be played for a long period of time, remove it from the CD player and store it in its case.

Discs which can be played with this unit

CD (12 cm, 8 cm), CDV (only the audio part)

+With CD-G (CD Graphics) discs, this unit can play only the audio.

Caution on disc used

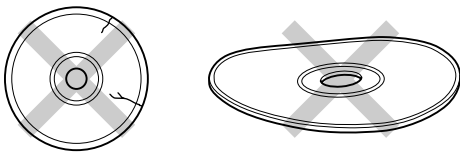

Never play cracked or warped disc.

During playback, the disc rotates at high speed in the player. Therefore, to avoid malfunction, never use a cracked or deformed disc or a disc repaired with tape or adhesive agent.

Handling of Mini Disc

As the Mini Disc is accommodated inside a cartridge, it can be handled without caring about dust or fingerprint. However, stained or soiled cartridge may cause malfunction. To enjoy beautiful sound for extended period of time, take care on the following points.

Do not touch the disc directly.

Do not touch the disc by opening the shutter with your hand. The cartridge will be damaged if it is forced open.

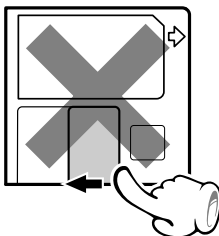

Storage position

Do not leave Mini Discs in place where the temperature and/or humidity are extremely high (for example, in a place subject to direct sunlight).

Dust countermeasure

The shutter of the disc cartridge is permanently open while the disc is loaded in the set. Therefore, to prevent dust from penetrating inside the disc, take the disc out of the unit immediately after completion of recording or playback.

Care

Wipe periodically dust and dirt attached on the cartridge with a dry cloth.

Write protect tab

To protect recorded contents against accidental erasure, set the write protect tab of the disc open. Return the tab to the original position when you want to record signals on the disc.

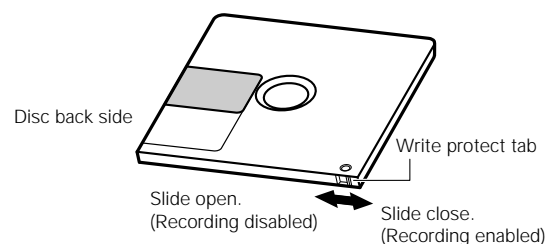

Connection of the System Accessories

This is the method for connection between the main unit and the accessories. Please connect correctly as shown in the figure.

AM loop antenna

The supplied antenna is for indoor use. Place it as far as possible from the main system, TV set, speaker cords and power cord, and set it to a direction which provides the best reception.

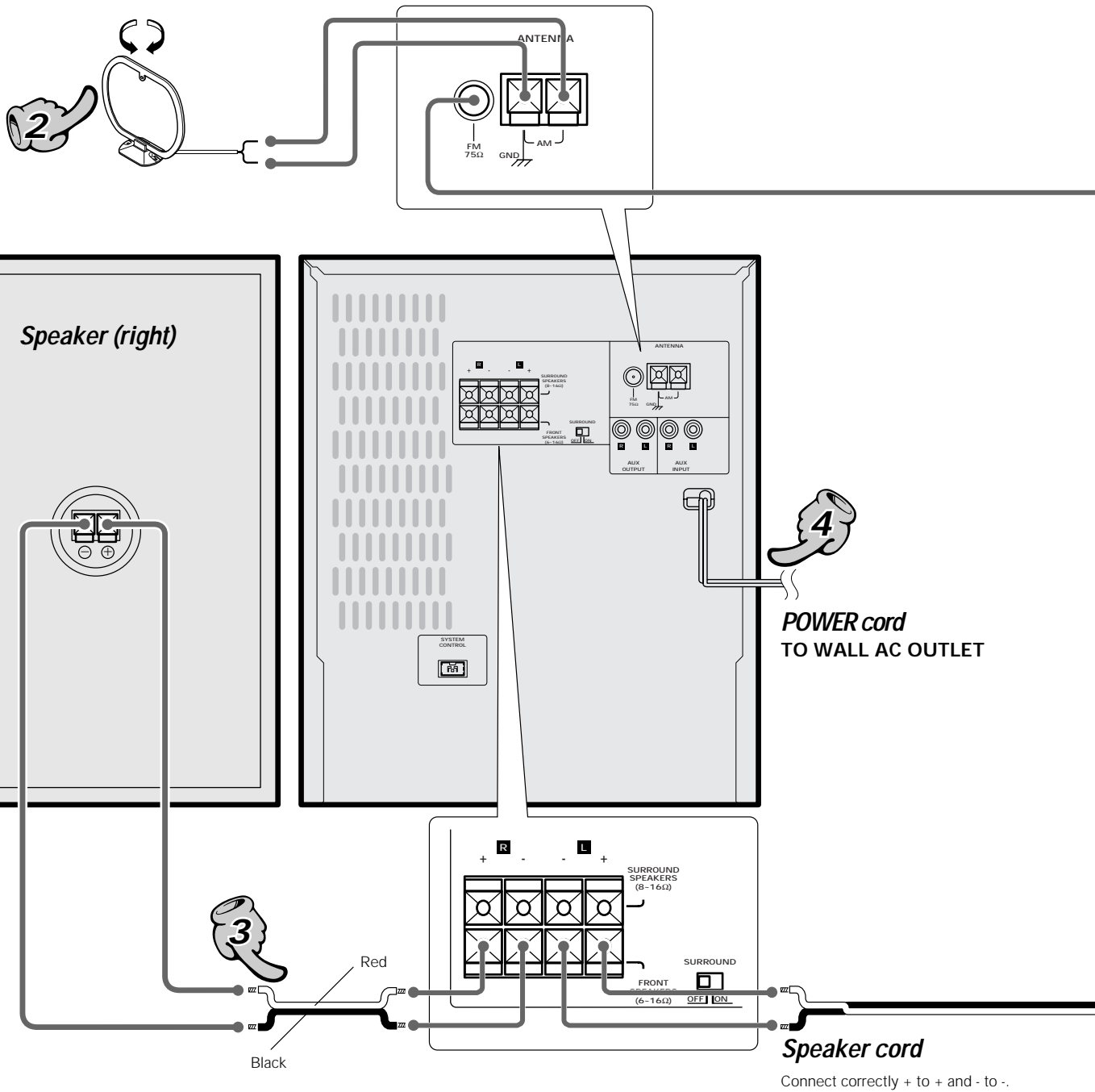

Main Unit

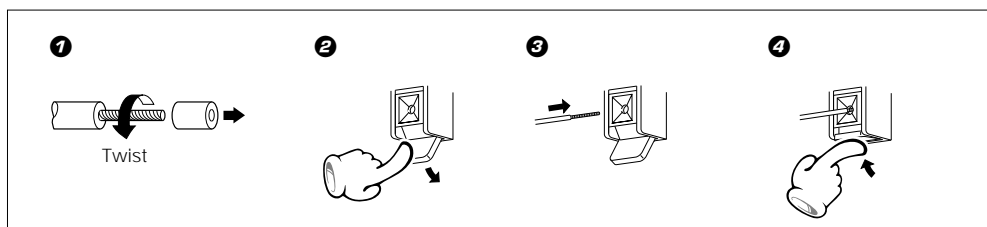

Malfunction of microcomputer

If operation is not possible or erroneous display appears even though all connections have been made properly, reset the microcomputer referring to "In case of difficulty".

→ 76



FM indoor antenna

The accessory antenna is for temporary indoor use only. For stable signal reception we recommend using an outdoor antenna. Remove the indoor antenna if you connect one outdoors.

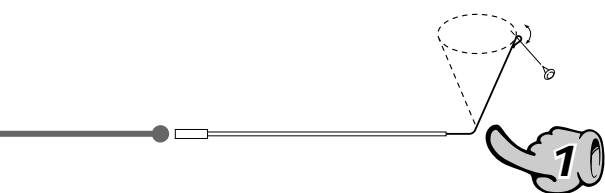

- 1 Locate the position providing good reception condition.
- 2 Fix the antenna.

Caution regarding placement

To maintain proper ventilation, be sure to leave a space around the unit (from the largest outer dimensions including projections) equal to, or greater than, shown below.

Top panel : 50 cm, Rear panel : 10 cm, Left and right panel : 10 cm

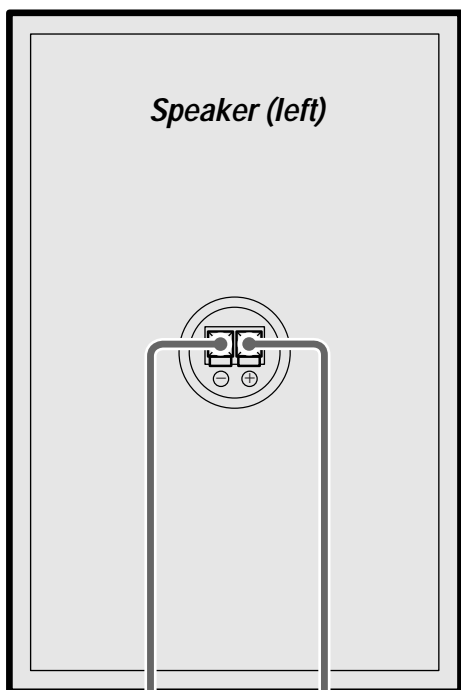

Front View

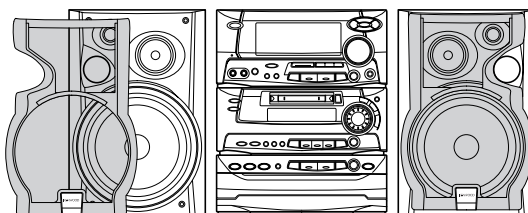

1. Be sure to insert all connection cords securely. If their connections are imperfect, the sound may not be produced or noise may interfere.
2. Before plugging or unplugging a connection cord, be sure to unplug the power cord from the wall AC outlet, if connection cords are plugged or unplugged with the power cord left plugged in, malfunction or damage may result.
3. Never short-circuit the + and - speaker cords.
4. If the left and right speaker connections or the + and - polarity are inverted, the sound will be unnatural with unclear positioning of musical instruments, etc. Be sure to connect them without mistake.

Speaker Unit

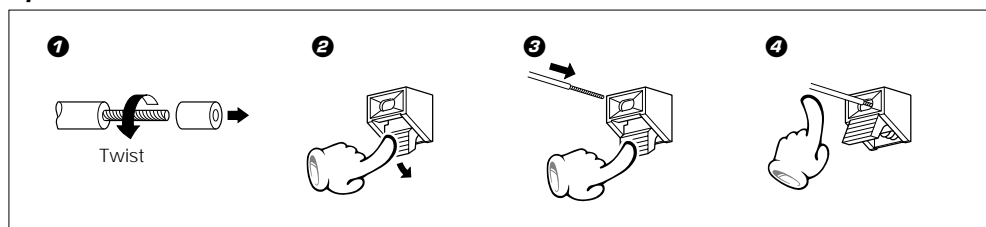

Connection of Options (Optional Parts)

Connect separately sold parts as shown in the figure.
Do not plug the power cord into the power outlet until all of the required connections have been made.

In regard to the SURROUND switch

This switch can be used only when the separately sold surround (rear) speakers are connected. When the switch is set to ON, surround playback can be enjoyed. When this switch is set to OFF, normal playback is executed.

- + Please operate this switch while the unit is turned off.
- + We recommend to keep this switch set to OFF when no surround (rear) speakers are connected to obtain a better sound quality.
- + When the switch is set to OFF, no sound will come from the surround (rear) speakers.

Speaker Unit

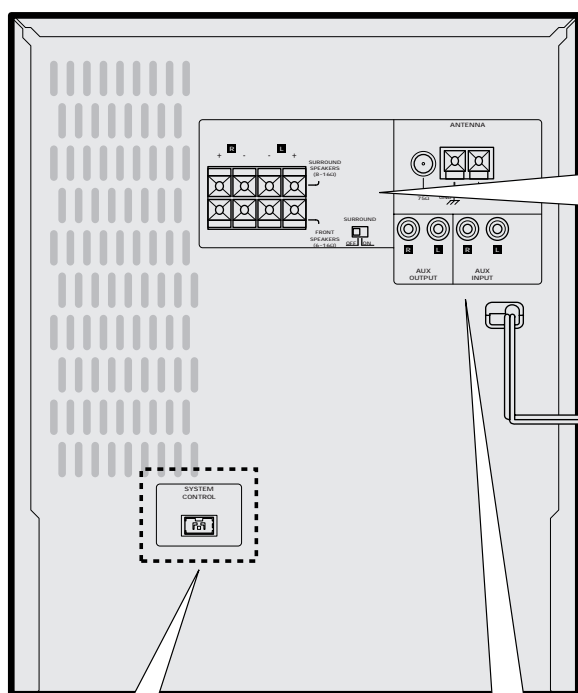
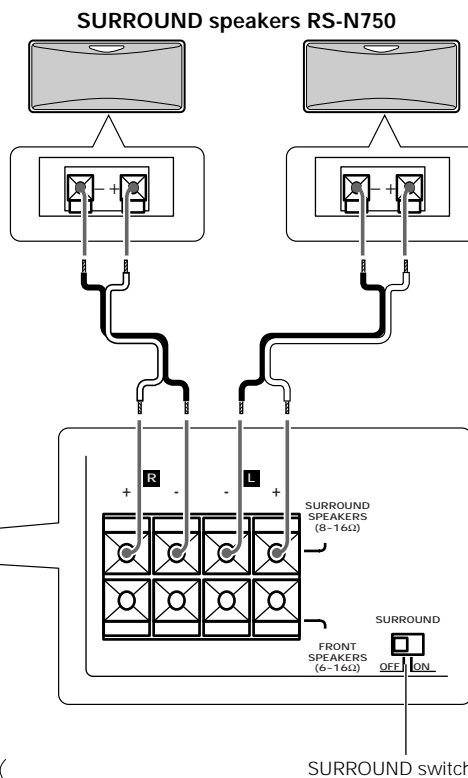
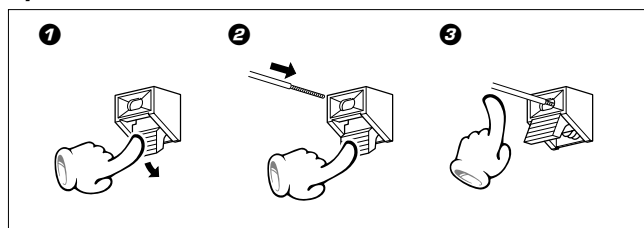

Main Unit

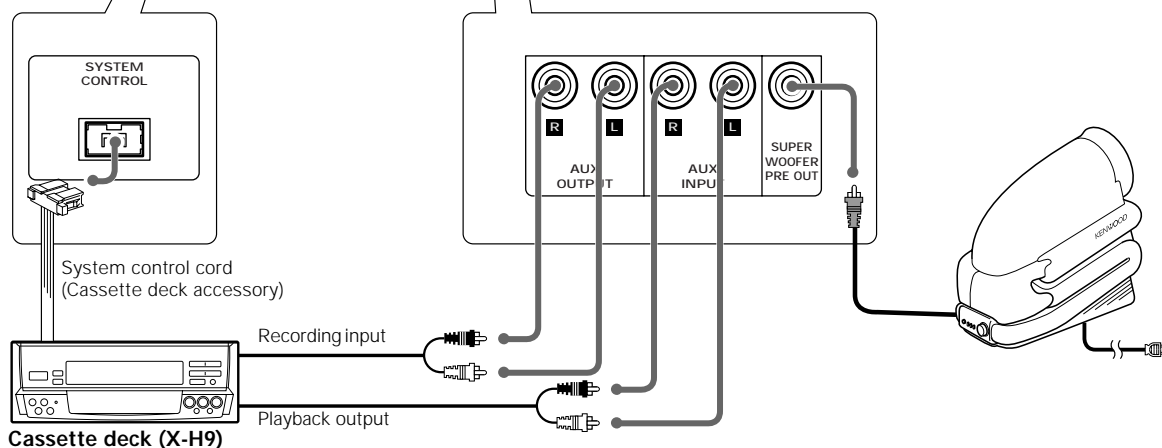
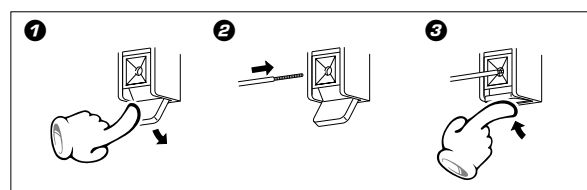

FM outdoor antenna

Lead the 75Ω coaxial cable connected to the FM outdoor antenna into the room and connect it to the FM 75Ω terminal. Please remove the indoor antenna after an outdoor antenna has been installed.

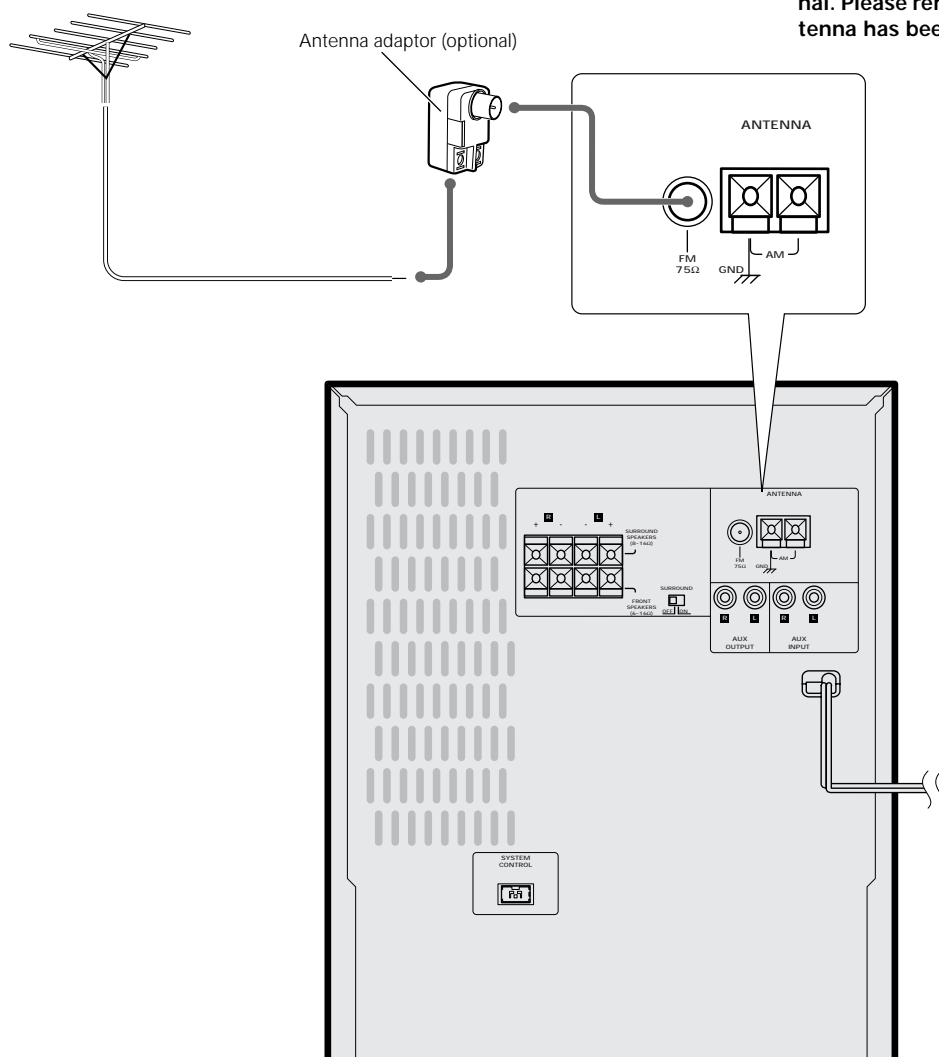

1. Be sure to insert all connection cords securely. If their connections are imperfect, the sound may not be produced or noise may interfere.
2. Before plugging or unplugging a connection cord, be sure to unplug the power cord from the wall AC outlet. If connection cords are plugged or unplugged with the power cord left plugged in, malfunction or damage may result.
3. In case an associated system component is connected, also read the instruction manual of the component.
4. Insert the plug straight into the connector unit it locks.
5. While pushing the two sides of connector in, pull it straight out.

Main unit

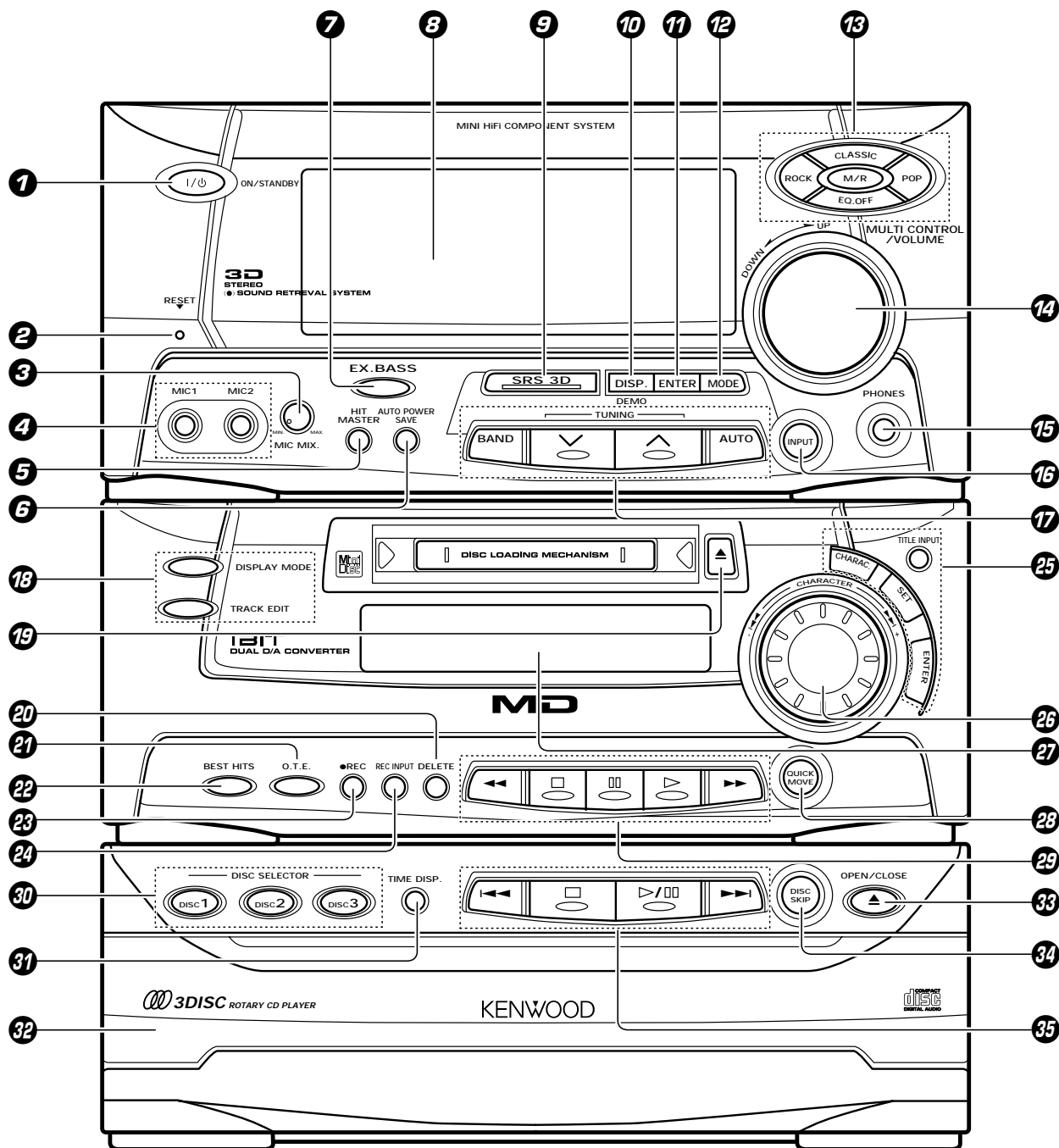

Preparation section

Amplifier/Tuner section

- 1 ON/STANDBY (I / ⏻) key** → 16
The system is switched ON and STANDBY.
- 2 RESET key** → 76
This is used in case of erroneous operation of the microcomputer.
- 3 MIC MIX. knob** → 66
Adjustment of the microphone volume at the time of microphone mixing.
- 4 MIC 1, MIC 2 jack** → 66
For connection of a microphone (sold separately).
- 5 HIT MASTER key** → 67
Used for karaoke etc.
- 6 AUTO POWER SAVE key** → 17
Used for AUTO POWER SAVE ON/OFF.
- 7 EX. BASS key** → 17
At the time of unit ON : Used for EX. BASS playback ON/OFF.
At the time of unit OFF : Used for timer setting.
- 8 Amplifier/Tuner display** → 12
- 9 SRS 3D key/indicator** → 65
This is used for SRS 3D ON/OFF switching.
- 10 DISP. key** → 63
At the time of unit ON : The indications contents of the display are switched. Used for demonstration ON/OFF.
At the time of unit OFF : Used for demonstration ON/OFF.
- 11 ENTER key** ∞
This is used for clock setting, timer setting, etc.

- 12 MODE key** → 27 → 62 → 65 → 69
At the time of unit ON : This switches the function of the **MULTI CONTROL/VOLUME** knob. The items which can be selected differ according to the status at that time.
At the time of unit OFF : Used for O.T.T. timer setting.
- 13 EQUALIZER operation key** → 63
The equalizer effect is switched ON and OFF. Also, the equalizer type can be selected.
- 14 MULTI CONTROL/VOLUME knob** → 16
Normally this is used for volume adjustment. Depending on the purpose, the function can be switched with the **MODE** key.
- 15 PHONES jack** → 17
Headphones (sold separately) can be connected.
- 16 INPUT key** → 16
The input source is selected. When CD, or MD is selected and a disc has already been set, playback will start automatically.
- 17 Tuner operation key** → 24
AUTO key
At the time of unit ON : This is used for switching between automatic reception (stereo) and manual reception (monaural).
At the time of unit OFF : Used for time setting.
TUNING key
This is used to tune a broadcasting station.
BAND key
The received broadcasting band is switched.

MD Recorder Section

- 18 Keys related to editing and title display key**
- TRACK EDIT key** → 57
Used for track editing and for erasing of tracks or the entire disc.
- DISPLAY MODE key** → 23
This is used to switch the title display mode etc.
- 19 Eject (▲) key** → 21
This key is pressed to remove discs.
- 20 DELETE key** → 55
This is used at the time of title input to delete one character.
- 21 O.T.E. key** → 44
When this key is pressed during MD playback, only the track being played at that time will be recorded to tape. When this key is pressed in stopped condition, the MD selected at that time will be recorded to tape from the first track on.
- 22 BEST HITS key** → 46
The first tracks of all CDs in the unit are recorded sequentially on MD.
- 23 REC (●) key** → 27 → 56
This is used at the time of recording.
Used for confirmation of selected tracks at the time of MD edit recording.
- 24 REC INPUT key** → 28
This is used to select digital or analog input.
(Switching is possible only when the amplifier/tuner input selector is set to "CD".)
- ∞ **Keys related to title input and editing**
- TITLE INPUT key** → 54
This is used for title input.

- CHARAC. key** → 54
This selects the character group at the time of title input.
- SET key** → 54
This is used for title input and editing.
- ENTER key** → 54
This is used for execution of edit processing, confirmation of entered titles, etc.
- 25 Jog dial (◀◀, ▶▶)** → 21
This is used as the skip key at the time of playback.
It is also used for track search and editing.
- 27 MD recorder display** → 13
- 28 QUICK MOVE key** → 56
This is used to change the track sequence.
- 29 MD operation keys**
- Play (▶) key (MD)** → 20 → 55
This is used at the time of title input to delete one character.
- Pause (⏸) key (MD)** → 21 → 56
This is used at the time of MD edit recording to delete a selected track.
- Stop (■) key (MD)** → 21 → 55
This is used at the time of title input to enter a blank space.
- Fast forward, fast reverse (◀◀, ▶▶) keys (MD)** → 21 → 54
At the time of playback, this is used for fast forward and fast backward.
At the time of title input, this is used for cursor movement.

CD player section

- 30 DISC SELECTOR keys** → 19
Selects the disc to be played (or recorded).
- 31 TIME DISP. key** → 19
The CD time display is switched.
- 32 Disc tray** → 18
Up to three CDs can be held.
- 33 OPEN/CLOSE (▲) key (CD)** → 18
These keys are used to insert and remove discs.

- 34 DISC SKIP key** → 19
Selection of the disc for playback or recording. Also used to set a CD at the rear of the tray.
- 35 CD operation keys** → 18
Play/pause (▶/⏸) key (CD)
Stop (■) key (CD)
Skip (◀◀, ▶▶) keys (CD)

Display (amplifier and tuner section)

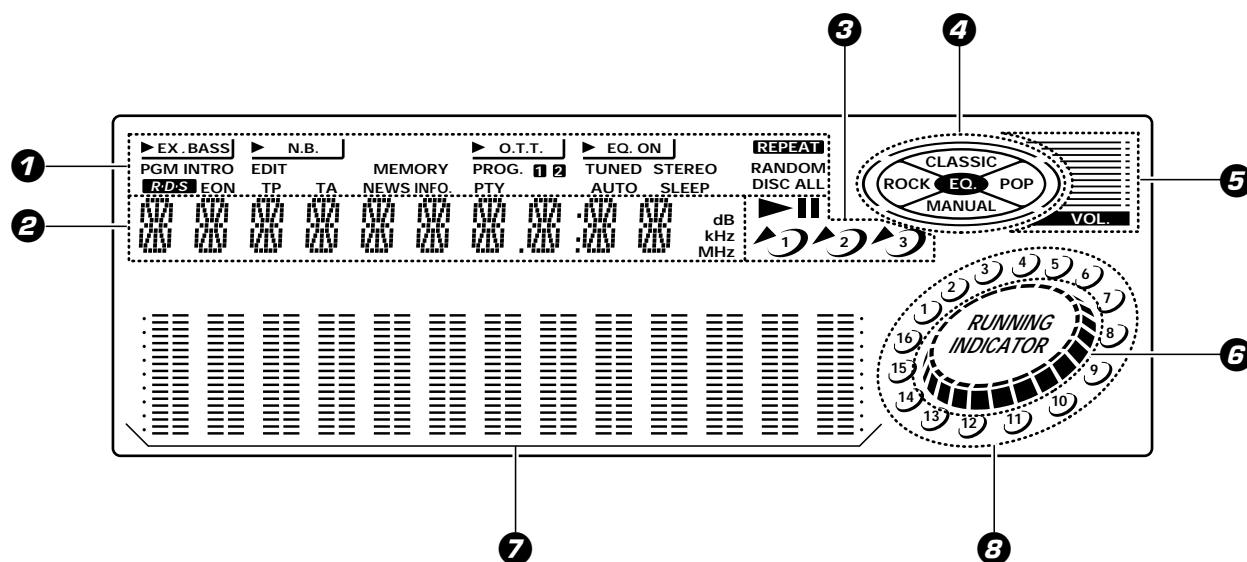

1 Display section for tuner, application operation, etc

In addition to tuner display, CD application operation, timer playback, etc. also is displayed.

2 Character information display section

Input switching, frequency display, volume level, etc. is displayed.

3 CD player display section

The CD play or pause status is displayed. The presently played disc number also is displayed.

4 Equalizer display section

The presently applied equalizer pattern is displayed.

5 Volume display section

The presently set volume is displayed.

6 RUNNING INDICATOR

With CD operation, MD operation, etc., the indicator lights according to the operation status.

7 Spectrum analyzer display

8 Track number display

The presently played CD track number is displayed.

Display (MD recorder section)

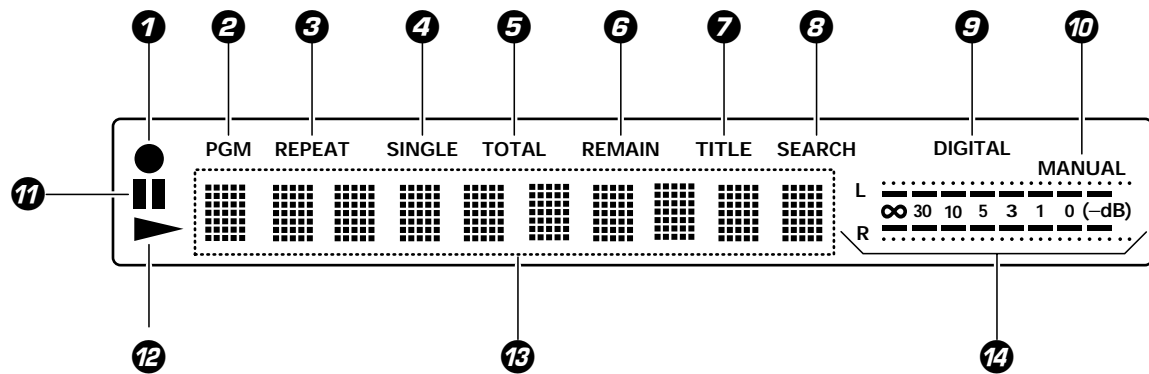

- ❶ Recording indication
- ❷ PGM (program) indication
- ❸ REPEAT indication
- ❹ SINGLE indication
- ❺ TOTAL indication
- ❻ REMAIN indication
- ❼ TITLE indication

- ❽ SEARCH indication
- ❾ DIGITAL indication
- ❿ MANUAL indication
- ⓫ Pause indication
- ⓬ Playback indication
- ⓭ Character information, time display section
- ⓮ Peak level indicator

Remote control Unit

Model : RC-H9R
Infrared ray system

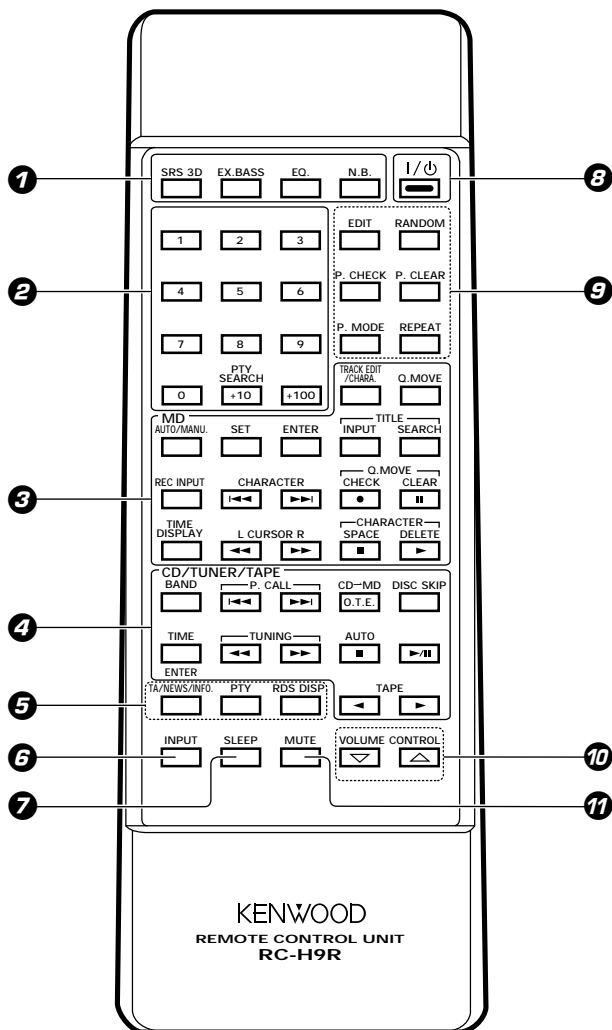

The keys on the remote control unit with the same names as on the main unit have the same function as the keys on the main unit.

① Keys related to sound quality and sound field

- SRS 3D key**
- EX.BASS key**
- EQ. key** : The equalizer effect is switched ON/OFF and the type of equalizer effect is selected. → [63](#)
- N.B. key** → [17](#)

② Numeric keys

These are used to select CD or MD tracks .
(The +100 key is used only for the MD recorder.)
The **PTY SEARCH (+10)** key is used to search for the program type with RDS broadcasts.

③ Keys related to the MD recorder

- TRACK EDIT/CHARA. key**
Used for track editing and for erasing of tracks or the entire disc.
- Q.MOVE key**
- AUTO/MANU. key**
This is used for selection of automatic (AUTO) or manual (MANU.) track number assignment at the time of recording.

- SET key**
- ENTER key**
- TITLE INPUT key**
- TITLE SEARCH key** → [22](#)
: This is used at the time of title search.

- REC INPUT key**
- CHARACTER/Skip (◀◀, ▶▶) keys**
- Q.MOVE CHECK/Record (●) key**
- Q.MOVE CLEAR/Pause (||) key**
- TIME DISPLAY key** → [23](#)
: The time display type is switched.

- L CURSOR R/Fast forward, fast reverse (◀◀, ▶▶) keys**
- CHARACTER SPACE/Stop (■) key**
- CHARACTER DELETE/Playback (▶) key**

④ Keys related to CD/tuner/tape deck

- BAND key (tuner) key**
- P.CALL (▽, △)/skip (◀◀, ▶▶) keys (tuner/CD)**
: These are used to receive memorized radio stations. → [19](#) → [24](#)
- CD→MD O.T.E. key (CD)** : Same operation as the O.T.E. key on the unit.
- DISC SKIP key (CD)** : This selects the disc to be played. → [19](#)
- TIME/ENTER key (CD)** : This switches the CD time display mode. → [19](#)
- TUNING (▽, △)/Fast forward, fast reverse (◀◀, ▶▶) keys (tuner/CD, tape deck (option))**
- AUTO/Stop (■) key (tuner/CD, tape deck (option))**
- Playback/pause (▶/||) key (CD)**
- Playback (◀, ▶) keys (tape deck (option))**

⑤ RDS-related keys

- TA/NEWS/INFO. key** : Used at the time of EON reservation. → [40](#)
- PTY key** : Used at the time of program type detection.
- RDS DISP. key** : Switches the contents of RDS-related display. → [37](#)

⑥ INPUT key

: This selects the input source for listening or recording.

⑦ SLEEP key

→ [69](#)
: This is used to set the sleep timer.

⑧ ON/STANDBY (I / ⏻) key

→ [16](#)

⑨ Keys related to special playback with CD and MD

- EDIT key (CD)** : This is used for edit recording of a CD onto tape. → [50](#)
- RANDOM key (CD)** : Playback of the CD tracks in random order. → [33](#)
- P.CHECK key (CD, MD)** : The programmed track sequence is displayed for confirmation. → [30](#) → [35](#)
- P.CLEAR key (CD, MD)** : The programmed track sequence is cleared. → [30](#) → [35](#)
- P.MODE key (CD, MD)** : This is used to program the track sequence. → [29](#) → [34](#)
- REPEAT key (CD, MD)** : This is used for repeated playback. → [31](#) → [36](#)

(Common keys for CD and MD function for CD or MD according to the input selection.)

⑩ VOLUME CONTROL (▽, △) keys

⑪ MUTE key

→ [17](#)

This is used to suppress the sound temporarily.

Loading batteries

➊ Remove the cover.

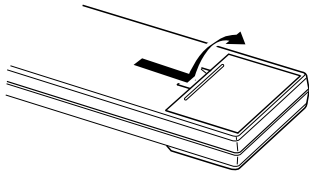

➋ Insert batteries.

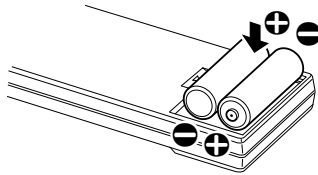

➌ Close the cover.

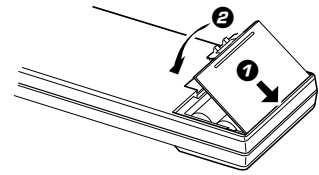

± Insert two R6 ("AA"-size) batteries following the polarity indications.

Operation

After plugging the power cord of this unit, press the ON/STANDBY (I / ⏻) key of the remote control unit to turn the system ON. When the system is turned ON, press the key of the function to be operated.

Press the ON/STANDBY (I / ⏻) key again for OFF. Only the time display will remain lit and standby status will be reached.

± When pressing more than one remote control keys successively, press the keys securely by leaving an interval of 1 second or more between keys.

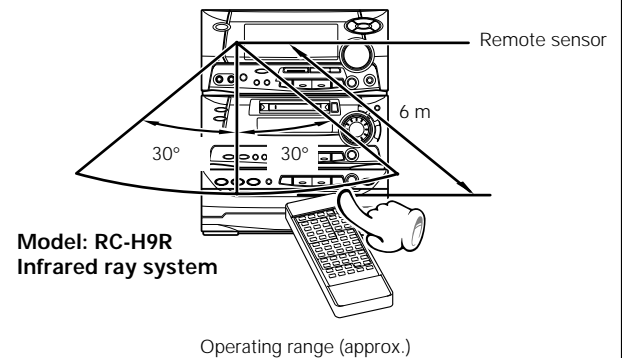

1. The provided batteries are intended for use in operation checking, and their service life may be short.
2. When the remote controllable distance becomes short, replace both of the batteries with new ones.
3. If direct sunlight or the light of a high-frequency fluorescent lamp (inverter type, etc.) is incident to the remote sensor, malfunction may occur. In such a case, change the installation position to avoid malfunction.

Basic use method

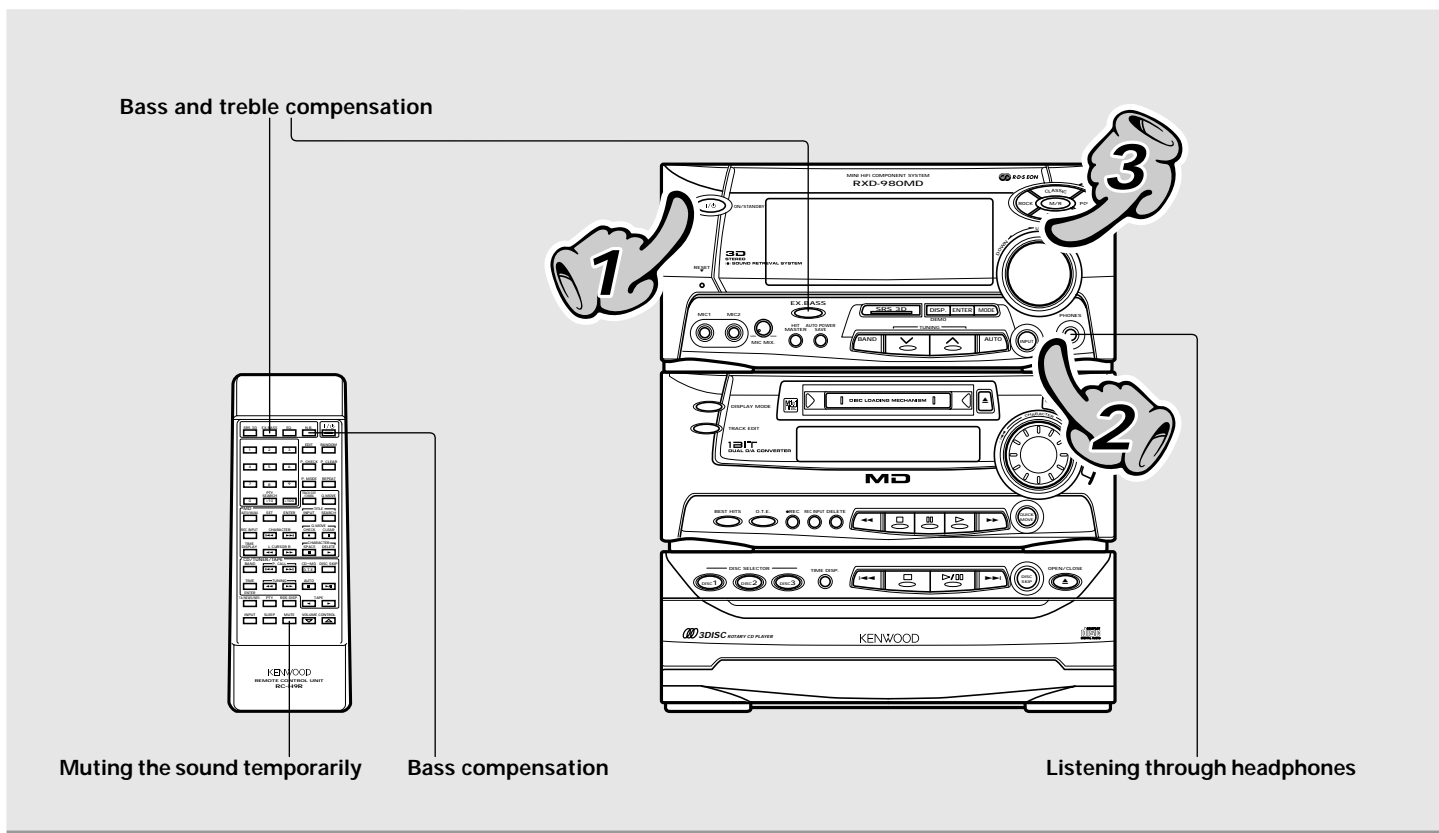

Basic section

Press the ON/STANDBY key of the unit.

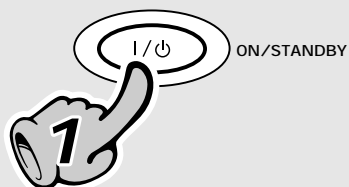

1. Set the ON/STANDBY key to ON (STANDBY).

The unit is switched on when the CD or MD playback key or the tuner BAND key is pressed.

When the ON/STANDBY key is pressed while the unit is ON, the unit will be switched OFF.

+ The ON/STANDBY key of the amplifier/tuner section can be used for ON/OFF for the entire system.

+ The display part becomes dark when the unit is switched OFF. (DIMMER function)

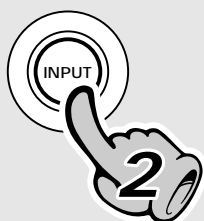

2. Selecting the desired output.

Sequential switching each time the key is pressed.

- ① CD → 18
- ② MD → 20
- ③ AUX (tape etc.) → 24
- ④ Broadcasts

+ When CD or MD is selected, playback will start when a disc already has been inserted.

+ For listening to tapes, read the section "Tape playback" in the operation manual of the cassette deck (option).

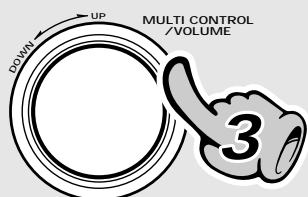

The volume decreases

The volume increases

3. Volume adjustment.

+ Quick turning produces a larger change amount. (Dynamic rotary volume control function)

+ The display shows a reference value.

Muting the sound temporarily (Remote control unit only)

Remote control unit

+ Press again to resume the original volume.
+ This is also cancelled when the volume is changed.

Bass compensation (N.B.CIRCUIT : Natural Bass circuit) (Remote control unit only)

Remote control unit

Each press switches the modes as follows.

- ① N.B.1 The bass range is compensated according to the volume (effective at low volume).
- ② N.B.2 Bass range compensation independent of the volume.
- ③ N.B.OFF N.B. cancellation.

Listening through headphones

➊ Insert the headphone plug into the PHONES jack.

+ The sounds from all speakers are cut off.

➋ Adjust the volume.

Bass and treble compensation (EX. BASS)

The factory default is ON.
Bass and treble range are compensated.

+ Switching between ON and OFF each time the key is pressed.

AUTO POWER SAVE function

When the unit is ON and neither recording nor playback is executed for 30 minutes or more, the unit is switched off automatically by this function. This function can be made active or not active by the following operation.

Each press switches the modes as follows.

- ① "ON" Auto power save is used.
- ② "OFF" ... Auto power save is not used.

+ Not operating when the input selection is set to AUX. At the time of TUNER, this operates only when the volume is set to zero.

STANDBY mode of ON/STANDBY key

When the power cord of this system is plugged into an AC outlet, the display lights up regardless of the ON/OFF setting of the ON/STANDBY key. This indicates that a small amount of current is being supplied to the unit to back up the memory contents. This mode is referred to as the standby mode. While the display is lit, the system can be switched ON/OFF from the remote control unit.

When CD has been selected.

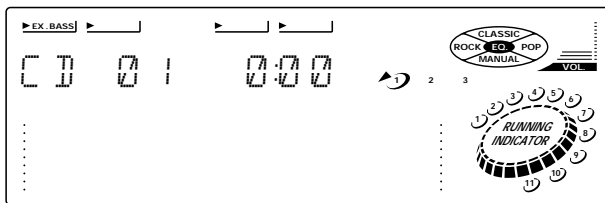

Volume display

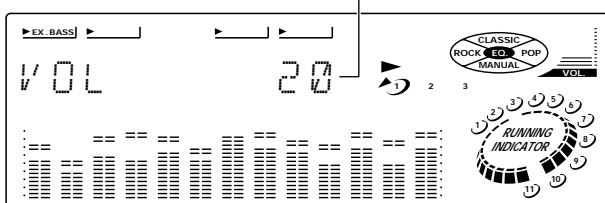

Playback of CD

 When a disc is placed into the CD player in advance, the unit will be switched on automatically by pressing the playback (▶/⏮) key, and playback will start.

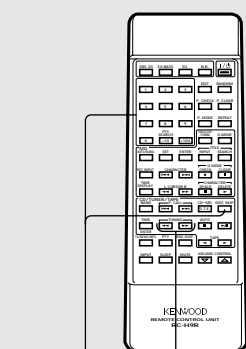

To fast forward and backward

Playback from desired track

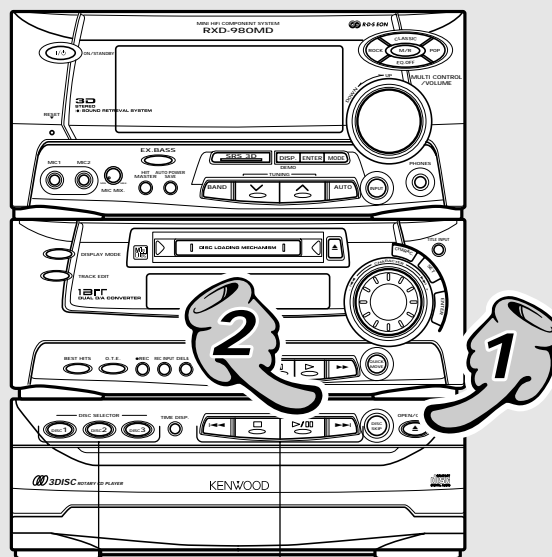

Playback from desired track

To stop playback
Skipping tracks
To pause playback

OPEN/CLOSE



When a key is pressed, the tray opens.
When the key is pressed again, the tray closes.

1. Load a disc.

- ① Open the tray.
- ② Place a disc.
- ③ Select the disc to be played.
- ④ Close the tray.

Disc played first when the ▶/⏮ key is pressed.

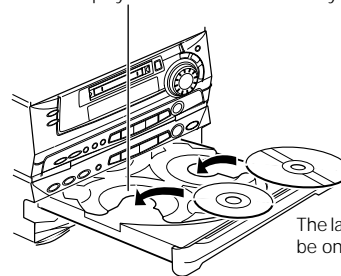

The label side must be on top.

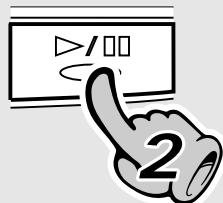

2. Start playback.

Skipping tracks

To skip backward To skip forward

- + The track in the direction of the button pressed is skipped, and the selected track will be played from the beginning.
- + When the ◀◀ key is pressed once during playback, the track being played will be played from the beginning.

Playback from desired track

Select the disc. Select the desired track No.

DISC SELECTOR

disc 1 disc 2 disc 3

Main unit

DISC SKIP

Remote control unit

1 2 3

4 5 6

7 8 9

0 +10

PTY SEARCH

Remote control unit

Press the numeric keys as shown below....

To enter track No. 23 : +10 +10 3

To select track No. 40 : +10 +10 +10 +10 0

- + Do not touch the played side of disc.
- + Place the disc properly along the groove on the tray. (If the disc is not placed horizontally, malfunction will result.)
- + Use the **DISC SKIP** key to turn the tray to insert the third disc.
- + The disc to be played should be in the left front tray.

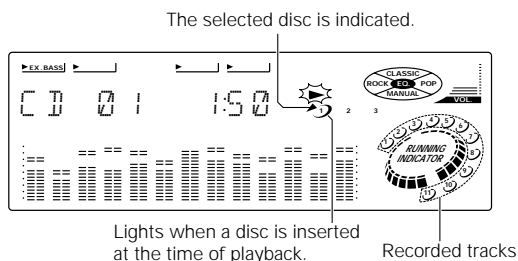

+ After a few seconds, play starts from track No.1.

The key names in brackets in the explanations are the names of the keys on the remote control unit.

To fast forward and backward (Remote control unit only)

Backward search Forward search

TUNING

- + Playback starts from the position where the key is released.

To pause playback

- + Each press pauses and plays the CD alternately.

To stop playback

Introduction scanning

Each title is played back in sequence for about 10 seconds. This is convenient to find titles to be played back with a disc being listened to for the first time etc.

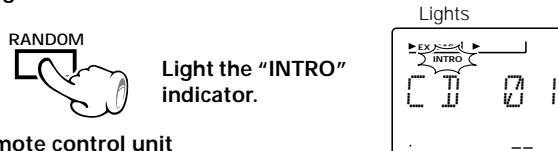

Each press switches the modes as follows.

- ① "INTRO" lit Introduction scanning
- ② "DISC RANDOM" lit Random playback (1 disc)
- ③ "ALL RANDOM" lit Random playback (all discs)
- ④ "INTRO" and "RANDOM" not lit Normal playback

- + Stop is executed after introduction scanning for all discs.
- + Combination with repeat playback is possible.
- + For cancellation, press the **RANDOM** key three times.

Time display on CD player

Each press of the **TIME DISP.(TIME/ENTER)** key changes the displayed contents.

- ① 1:23 : Elapsed time of track being played
- ② - 2:37 : Remaining time of track being played
- ③ ^{TOTAL} 23:45 : Elapsed time of entire disc
- ④ - ^{TOTAL} 36:15 : Remaining time on entire disc

+ There is no **TOTAL** indication in PROGRAM mode, in EDIT mode, and in RANDOM mode.

Playback of Mini Disc



When a disc is placed into the MD recorder in advance, the unit will be switched on automatically by pressing the playback (▶) key, and playback will start.

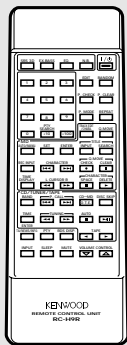
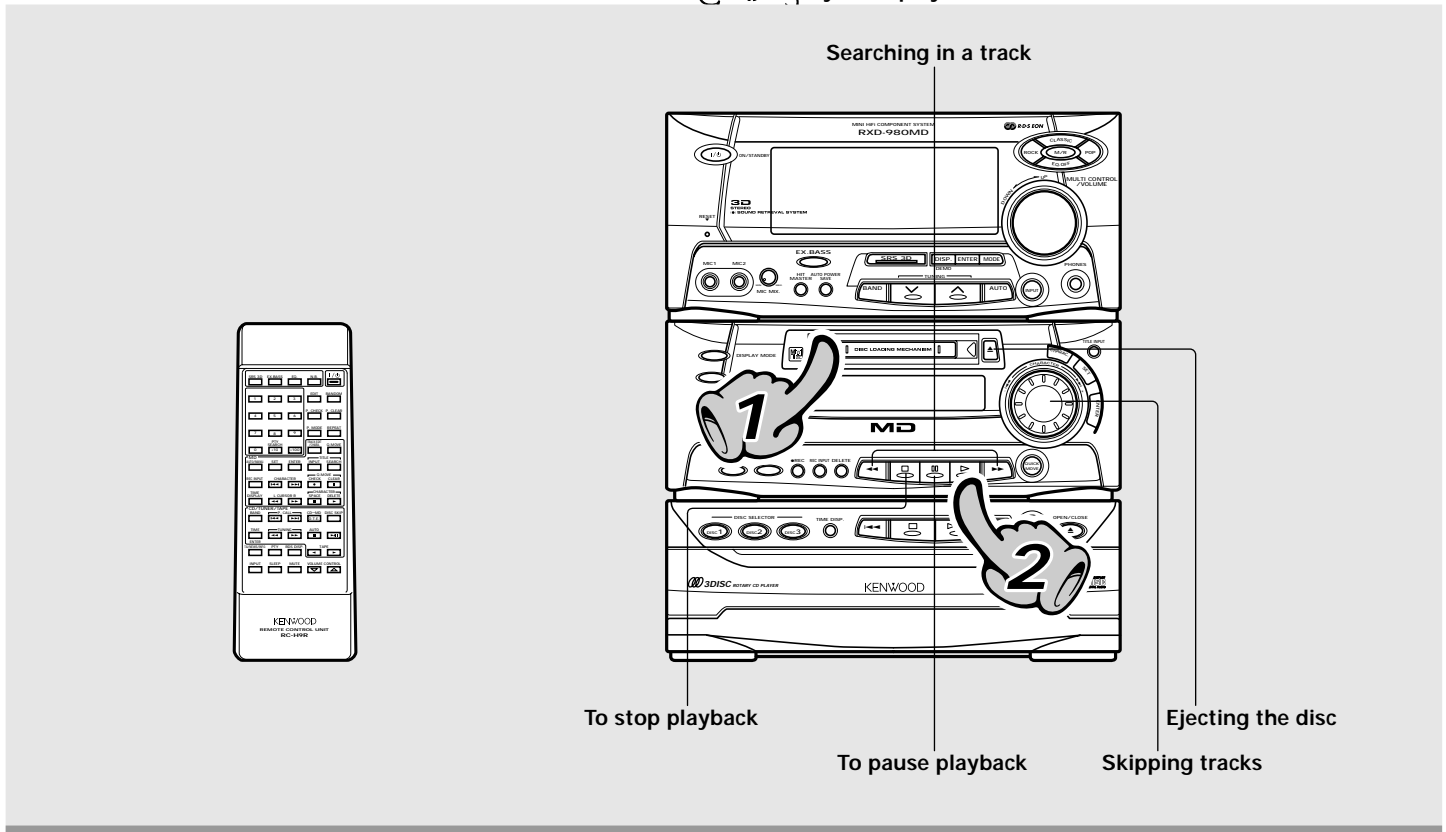

Basic section

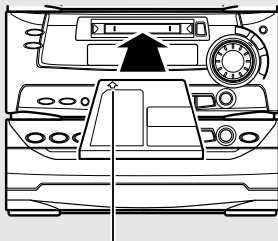

In the direction of the arrow

1. Load a Mini Disc.

Insert the disc a little, and it will be pulled in automatically.

+ When a title has been recorded for the disc or the track, the title is displayed.

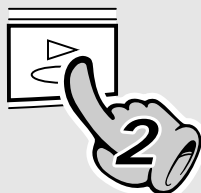

2. Start playback.

To listen from the track No. 1

- + In a few seconds, playback starts from track No. 1.
- + During playback, the track title is displayed at the beginning of each track.
- + When the playback time is 100 min. or more, the time display will become "-- :-- :--".

To select a track

Press the numeric keys as shown below....

To enter track No. 23:

..... **+10** **+10** **3**

To enter track No. 40:

..... **+10** **+10** **+10** **+10** **0**

- + If the "PGM" indicator is lit, press the **P.MODE** key of the remote control unit to not lit.
- + If a track NO. which does not exist on the disc is selected while "READING" is blinking, the last track on the disc will be played.

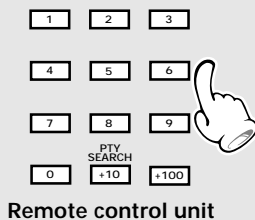

Remote control unit

Searching in a track

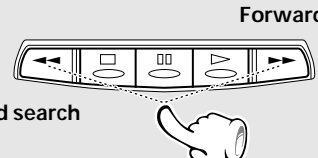

Forward search

Backward search

- + Playback restarts when the key is released. (When the key is pressed in pause mode, unit returns to the pause mode at the reached position.)
- + Sound is output when using forward or reverse search during playback.
- + If forward or reverse search is started during play-pause, the disc can be searched at a high speed but sound is not output.

Skipping tracks

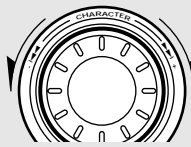

To skip backward

To skip forward

- + The track in the direction of rotating the jog dial is skipped, and the selected track will be played from the beginning.
- + When the jog dial is rotated a little in the direction of counter-clockwise once during playback, the track being played will be played from the beginning. (If it is rotated within 1 second from the start of a track, the previous track to the current track will be played from the beginning.)

Ejecting the disc



- + The minidisc comes out from the minidisc insertion slot.

To pause playback

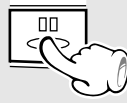

- + Each press pauses and plays the MD alternately.

To stop playback



The display changes.

READING		L	00	30	10	5	3	1	0 (-dB)
↓ Disc title		R	00	30	10	5	3	1	0 (-dB)
KENWOOD		L	00	30	10	5	3	1	0 (-dB)
↓ Recorded tracks		R	00	30	10	5	3	1	0 (-dB)
TOTAL	Total time	L	00	30	10	5	3	1	0 (-dB)
025	62:31	R	00	30	10	5	3	1	0 (-dB)
↓ SINGLE		L	00	30	10	5	3	1	0 (-dB)
001	0:00	R	00	30	10	5	3	1	0 (-dB)

Track No. being played	Elapsed time of track being played
SINGLE	
▶ 001	1:58
L	00 30 10 5 3 1 0 (-dB)
R	00 30 10 5 3 1 0 (-dB)



Discs with application of equalizer or SRS 3D effect to the recorded sound (analog input) should be played without sound effect application.

Disc recorded in monaural mode

This unit is capable of playing a disc recorded in the monaural mode. As the amount of data required to record information in the monaural mode is half the amount required in the stereo mode, the play (record) time of a disc recorded in the monaural mode is twice (max. 148 minutes) that of a disc recorded in the stereo mode.



Searching a desired track by its title (TITLE SEARCH)

- ❶** Confirm that the "PGM" indicator is not lit.



Press during stop.
- ❷** Press the TITLE SEARCH key.





To abort operation, press the TITLE SEARCH key again.
- ❸** Select the desired title.





To smaller track No. To larger track No.
- ❹** Start playback.

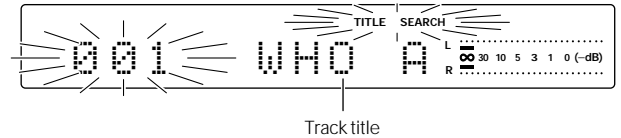
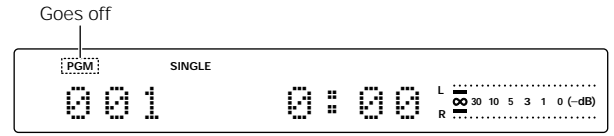

- + When the titles of the tracks recorded on a minidisc for recording are entered in advance, search by title is possible for the tracks to be played.
- + When the "PGM" display is lit, press the **P.MODE** key on the remote control unit to switch it off.



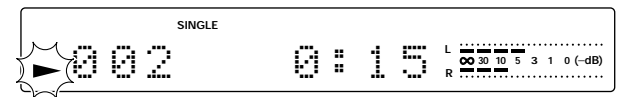
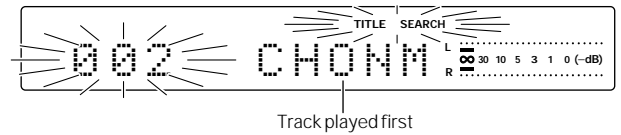

- + With a track to which no title has been assigned, the track number and "-----" are displayed.
- + Track selection is possible with the **CHARACTER/◀▶** keys on the remote control unit.



In regard to automatic title search

It is possible to play a track by displaying the track titles automatically and pressing the playback key while the desired title is being displayed.

- ❶** Execute step **❶** of "Searching a desired track by its title".
- ❷** Press the TITLE SEARCH key for at least 2 seconds.

All titles of the minidisc will be displayed sequentially.
To cancel, press the TITLE SEARCH key again.
- ❸** Press the playback key during display of the title to be played.

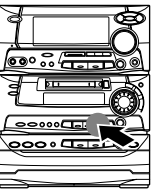
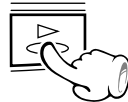

In Regard to the TIME DISPLAY key

This can be used to change the time display type at the MD recorder section.



Remote control unit

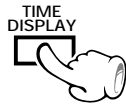

Each press switches the modes as follows.

During playback

- ① Elapsed time of track being played
- ② Remaining time of track being played
- ③ Recordable time for the entire minidisc

In stopped condition

- ① Elapsed time of track (0:00 indication)
- ② Remaining time of track (-0:00 indication)
- ③ Recordable time for the entire minidisc

During recording

- ① Elapsed time of the track being recorded
- ② Recordable time for the entire minidisc

Elapsed time of track being played

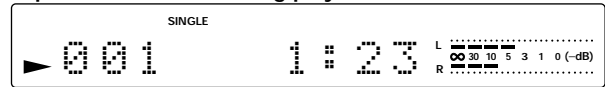

Remaining time of track being played

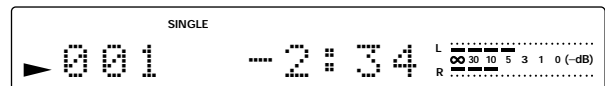

Recordable time for the entire minidisc

"REMAIN" lights

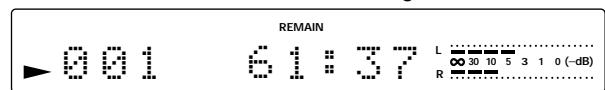

Recordable time for the entire minidisc

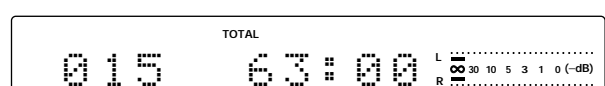

÷ "BLANK DISC" is displayed when not even one track has been recorded. (When there is a disc title, the disc title will be displayed.)

In Regard to DISPLAY MODE key

The MD title display type (minidisc name, track name) can be switched.

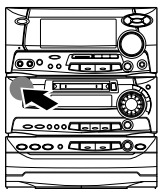

Main unit



DISPLAY MODE

Each press switches the modes as follows.

During playback, in stopped condition

- ① Time display
- ② Title display
- ③ Disc name display

Time display

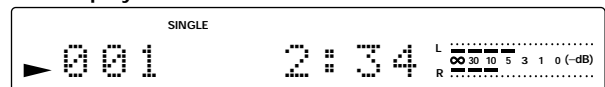

Title display

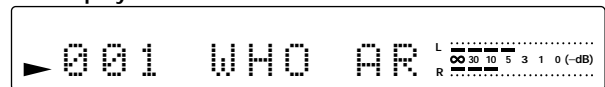

Disc name display

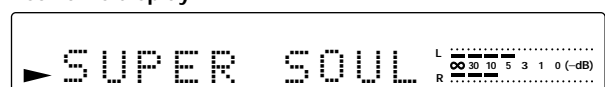

÷ Switching to ② Title display and ③ Disc name display is done by pressing the DISPLAY MODE key while the display is moving (during scroll).

÷ When no track name (track title) and no disc name (disc title) has been recorded, "-- -- -- --" or "NO TITLE" is displayed.

Receiving broadcast station

It is also possible to receive them by one-touch operations by storing up to 40 stations in the preset memory.



When the BAND key is pressed, the unit will automatically be switched on and reception status will be reached.

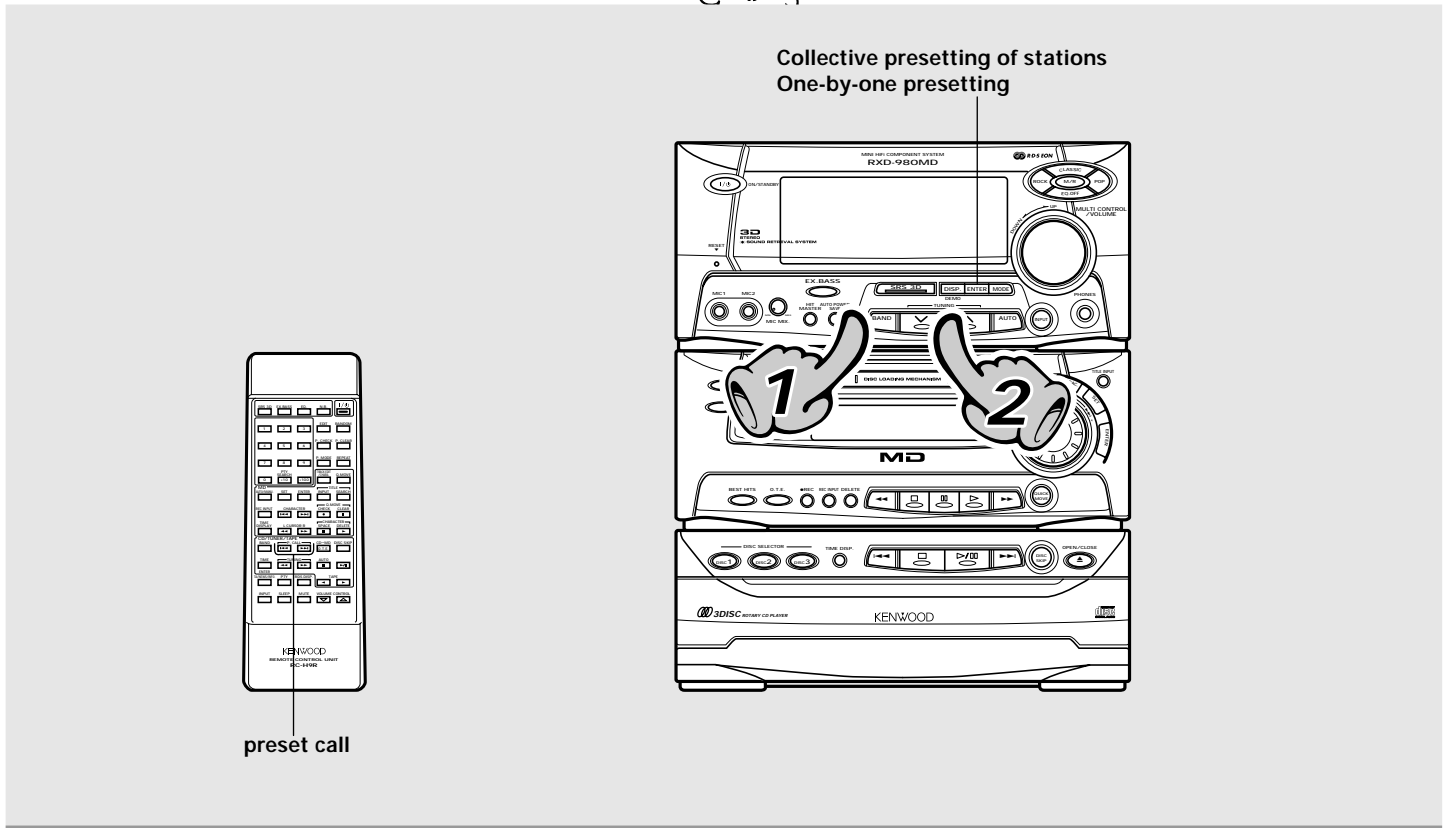

Basic section



1. Select the broadcast band.

Each press changes the band.

- ① FM
- ② MW
- ③ LW

To increase frequency

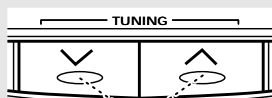

To decrease frequency



2. Select a station.

When no stations have been memorized

Auto tuning : The next broadcasting station will be received automatically each time this key is pressed.

Manual tuning : Press the key repeatedly or hold it depressed until a station is received.

When stations have been memorized (preset call)

Select a station.



Remote control unit

Every time the key is pressed, the preset stations are switched over as follows.

Press ►► for the order of 1→2→3 ... 38→39→40→1...

Press ◄◄ for the order of 40→39→38 ... 3→2→1→40...



Collective presetting of stations (auto preset)

Keep the ENTER key depressed (about 2 seconds).

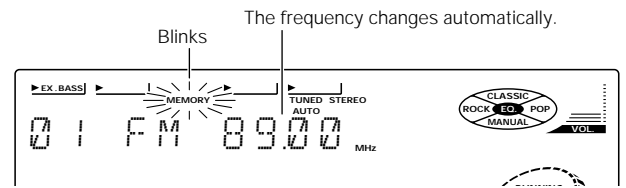

- + A maximum of 40 stations of the band presently being received will be preset.
- + When there are many stations and the intended station has not been preset, please also use "One-by-one presetting (manual preset)".

One-by-one presetting (manual preset)

1 Press the ENTER key during reception.



Presetting is cancelled when no operation is executed for 5 seconds or more.

2 Select one of the preset numbers from 1 to 40.

The numbers become smaller

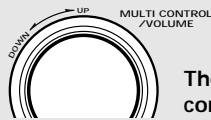

The numbers become larger

3 Press the ENTER key again.

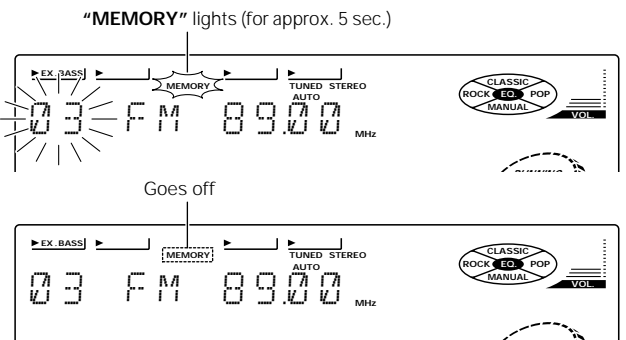

- + Repeat steps 1 2 3 to preset other stations.
- + If several stations are preset under the same number, the previous memory is replaced with the latest memory contents.

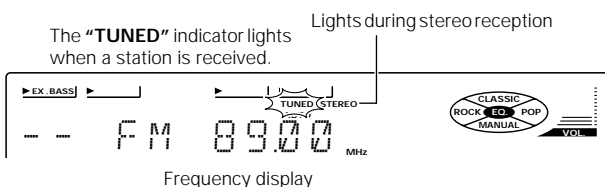
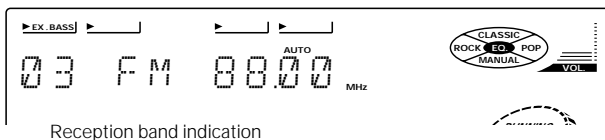

+ When a key is held depressed, preset stations will be skipped at an interval of about 0.5 second.

Select the tuning mode

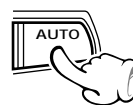

Each press alternates the mode.

- 1 "AUTO" lit (Auto tuning)
- 2 "AUTO" not lit (Manual tuning)

Use the manual tuning mode when reception is noisy due to weak reception. (In the manual mode, stereo broadcasts are received in monaural.)

+ Normally, use the **AUTO** (Auto tuning) mode.

This unit cannot record audio in monaural mode.

Recording on MD

MD recording is possible as "digital recording", where the digital signal of the CD is used as it is, and as "analog recording", where the analog signal of a broadcast etc. is converted to a digital signal.



When equalizer or SRS 3D is applied to the sound, the sound will be recorded with applied effect in the case of analog recording. → 63 → 65

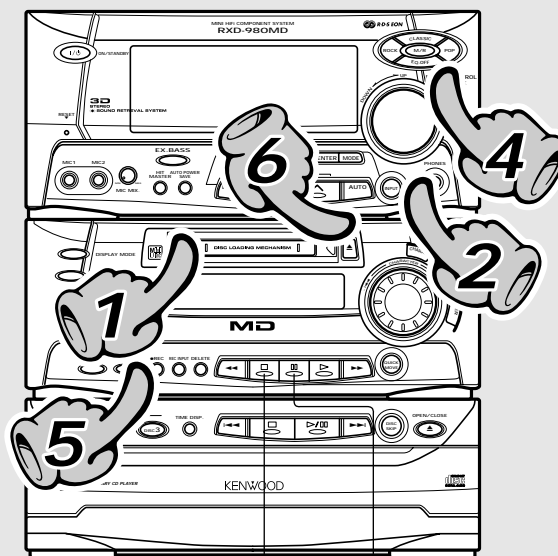
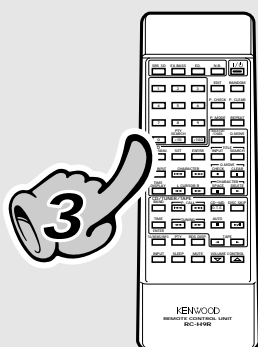

Pause the recording
Stop the recording

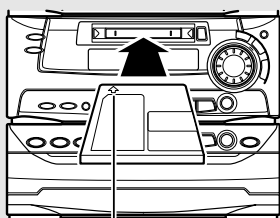

In the direction of the arrow

1. Make the preparations for recording.

- 1 Open the write protect tab of the Mini Disc to make it recordable. → 5
- 2 Load the Mini Disc.
- 3 Check the remaining recording time. → 23

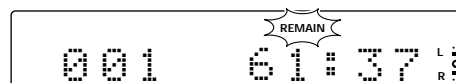

Remaining recording time (when "REMAIN" is lit)

Select an input source other than "MD".

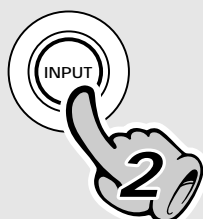

Go to step 5 for CD digital recording.

2. Select the source to be recorded.

Each press switches the modes as follows.

- 1 CD : Digital or analog recording
- 2 MD : Recording is not possible
- 3 AUX (tape etc.) : Only analog recording
- 4 Broadcasts : Only analog recording

Indication of the input source to be recorded.

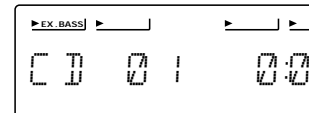

For CD analog recording, refer to "How to use the REC INPUT key". → 28

+ While a CD or MD is set, play will start, so that the STOP key must be pressed to stop the disc.
+ For recording from the cassette deck (option), please read "Listening to tapes" in the accessory operation manual.

AUTO/MANU.



3. Selecting how track numbers are assigned. (only analog recording)

The normal setting is to AUTO ("MANUAL" is not lit).
"How to use the AUTO/MANU. key." → 28

"MANUAL" goes off

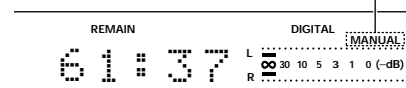

Pause the recording



- + Press the key again to resume recording. At this time, the track number is incremented by "1".
- + Recording can also be started by pressing the record (● REC) key.

Stop the recording

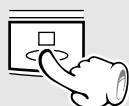

In regard to display messages

Recording is not possible when one of the following messages is displayed.

"DISC FULL"	: The minidisc is full.	
	➔ Erase unrequired tracks.	→ 60
"PROTECTED"	: The write protect tab is open.	
	➔ Close it.	→ 5
"PLAY ONLY"	: The minidisc is only for playback.	
	➔ Insert a recordable disc.	→ 74

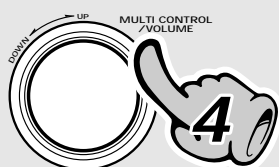

Level decreases Level increases
Display on the amplifier, tuner section Level value

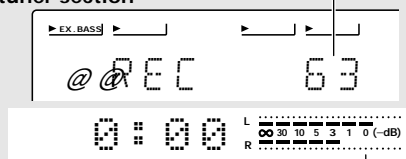

Display on the MD recorder section 0dB

4. Adjust the recording level (only analog recording).

- ① Play the source to be recorded.
- ② Set to recording pause.
Always press the record (● REC) key in stopped condition, and then press the pause (||) key.
- ③ Press the MODE key and select the MD recording level (REC).
- ④ Adjust the recording level.

- + Adjustment is possible in the range from 0 to 80.
- + Adjust so that 0 dB lights only once in a while.
- + Lower the level when the red part of the level meter lights.

Switching is done each time the MODE key is pressed.

- ① Strength of the SRS 3D effect (LEVEL)
- ② Left-right sound balance
- ③ MD recording level (REC)
- ④ Volume from external equipment connected to the AUX terminal (INPUT)
- ⑤ Normal volume adjustment (VOL)



5. Start recording.

- ① Press the record (● REC) key.
- ② Play the music source to be recorded.

- + During recording, the eject (▲) key will not be accepted.
- + To start recording simultaneously with CD playback, please read "Tips for recording from a CD".



6. Remove the minidisc after the end of recording.

Always remove the minidisc after recording.

"WRITING" displayed during the minidisc ejection operation indicates that the data associated with recording or editing is being written on the disc. Do not apply vibration or shock to the unit while this message is displayed.

How to use the REC INPUT key

When the input selection is CD and recording is started, digital recording is selected automatically and adjustment of the recording level is not required.

When the playback level of a digitally recorded MD is not suitable (too loud or too low), the recording level can be adjusted by using the REC INPUT key to switch to analog recording, and then recording can be repeated with adjustment to the most suitable level.

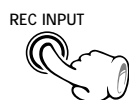
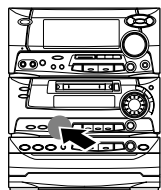

Each press switches the modes as follows.

- ① "DIGITAL" is lit : Digital recording
- ② Not lit : Analog recording

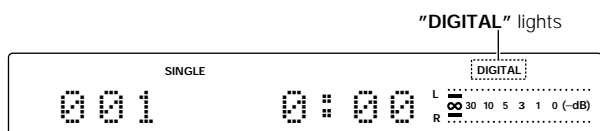

Tips for recording from a CD

When recording is started according to the following procedure, recording (MD) and playback (CD) will start at the same time and there is no worry of sound being skipped.

- ① Select the disc or the track to be recorded.

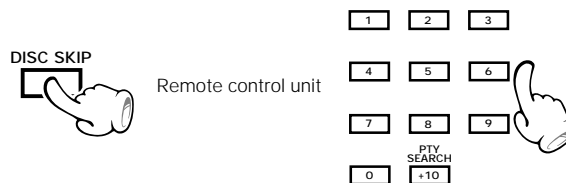

- ② Pause the CD.



- ③ Press the <<< key of the CD once.



The CD will pause at the beginning of the selected disc (track).

- ④ Bring the MD recorder to recording pause.

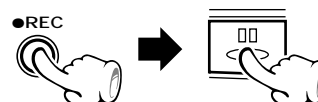

- ⑤ Start CD playback.



+ In case of analog recording, it may not be possible to record the sound at the beginning of the title. In such a case, use digital recording.

How to use the AUTO/MANU. key

This selects whether the track numbers are set automatically during analog recording or manually during or after recording. The track numbers are used at the time of playback to find the start of tracks, for programming, etc.

AUTO

When a part without sound continues for 2 sec. or more during recording, the track number is automatically increased by "1" when the next sound enters. Use this mode for normal recording. Use this mode to record all tracks of a CD. When classic music continues with low sound, the track number may be increased by "1". The erroneously set track number can be erased later. In case of such music, use MANUAL for recording.



Select before the start of recording



MANUAL

Recording is executed without automatically increasing the track number. Track numbers can be set during and after recording. This is convenient for recording of live performances or classic music with continuous sound at extremely low levels.

Each press switches the modes as follows.

- ① "MANUAL" not lit : AUTO mode
- ② "MANUAL" lit : MANUAL mode

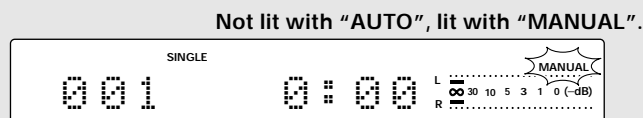

+ When the TRACK EDIT key is pressed during recording, a track number is assigned at that position.



1. At the time of recording from a CD, the track number may be incremented when CD playback starts. This occurs because of a signal included in the digital signal from the CD. Delete unwanted track numbers under reference to "TRACK ERASE or ALL ERASE".
2. When a track is extremely short, the track number may not be incremented correctly in AUTO mode.

Listening in the desired sequence (program playback)

Any titles on the discs in the tray can be listened to in the desired sequence. (Max. 32 titles)

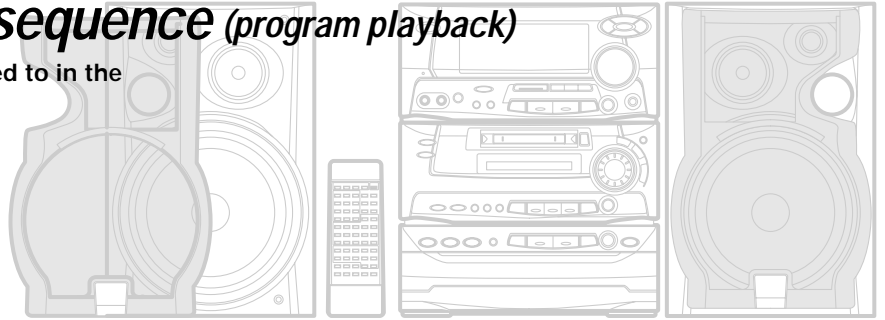

Select the "CD" input.

1 Check that the CD player is in the stop mode.

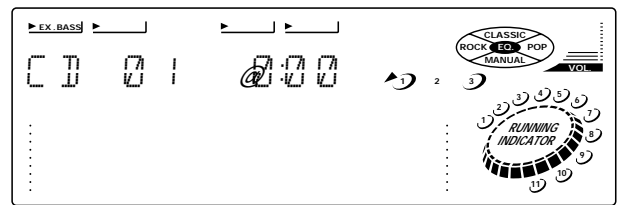
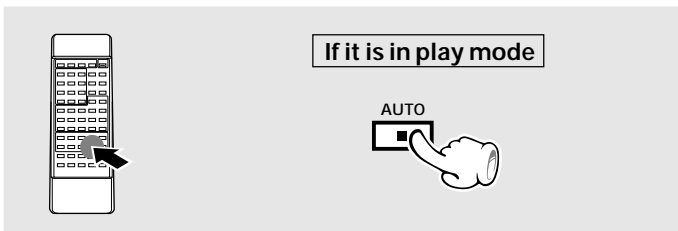

2 Light the "PGM" indicator.

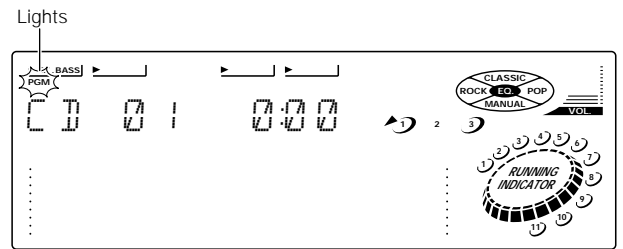
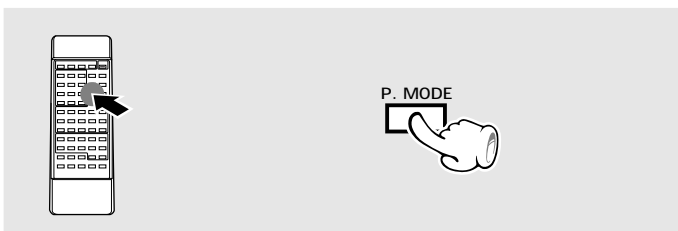

3 Enter track Nos. in the order you want to play them.

1 Select the disc.

DISC SKIP

Go to step 2 within 8 seconds.

2 Select the track.

1	2	3
4	5	6
7	8	9
0	PTY SEARCH +10	

3 Confirm the selection.

P. MODE

To select tracks from more than one disc, repeat 1, 2 and 3.

- + The disc can also be selected with the **DISC SELECTOR** key.
- + Up to 32 tracks can be programmed. When "FULL" is displayed, no more tracks can be programmed.
- + To program all tracks of a CD, select the disc and then press **P.MODE** key without selecting any tracks.
- + If you make a mistake, press the **P.MODE** key to quit the program mode and restart from step 2.

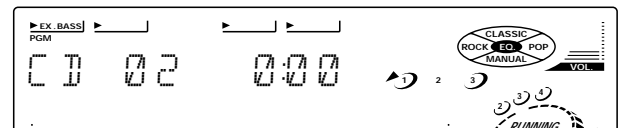
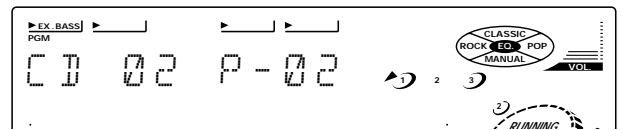

Press the numeric keys as shown below....

To enter track No. 23 : **+10 +10 3**

To select track No. 40 : **+10 +10 +10 +10 0**



4 Start playback.



- + Tracks will be played in the order they were programmed (in order of P Nos.).
- + When the **⏮** or the **⏭** key is pressed during play, the program will jump to the preceding or the following track respectively.
- + When the **⏮** key is pressed once during playback, the play position returns to the beginning of the current track being played.

To stop playback



To check the programmed tracks

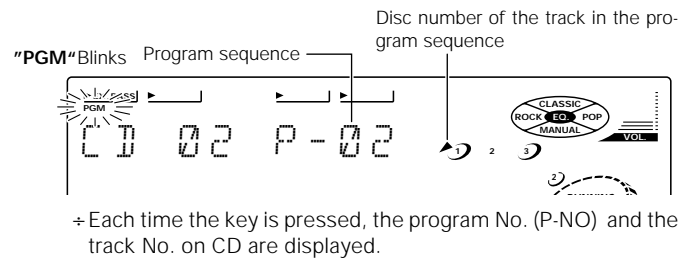

To add a track to the program

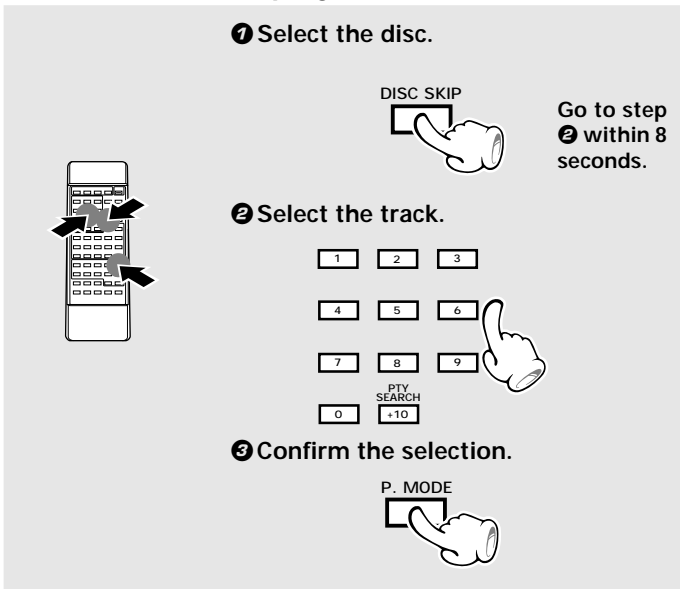

+ When a track No. is entered, the track will be added to the end of the existing program.

To quit the program mode

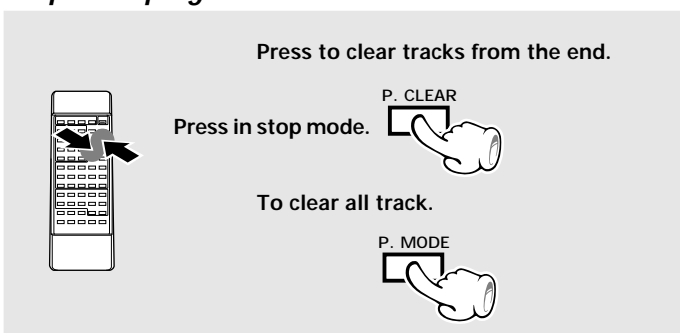

+ Each time the key is pressed, the last track in the program is cleared.

+ The track being played cannot be changed.

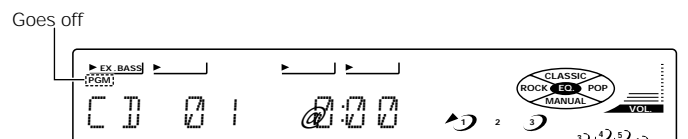

Application section

Repeated playback

You can repeatedly listen to a favorite track or disc.

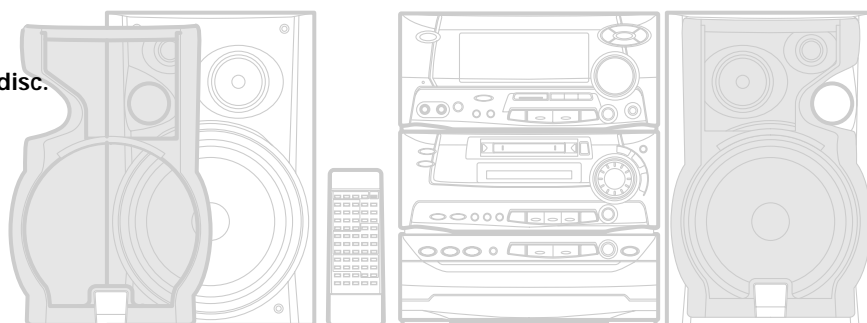

Select the "CD" input.

To repeat a disc



1 Confirm that the "PGM" indicator is not lit.

If the "PGM" indicator is lit, press the P.MODE key to turn it off.

Confirm that this is not lit.

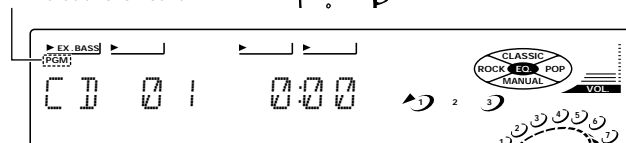

2 Specify "DISC REPEAT".



Each press switches the repeat mode.

- 1 REPEAT
- 2 DISC REPEAT
- 3 ALL REPEAT
- 4 Repeat OFF

Lights

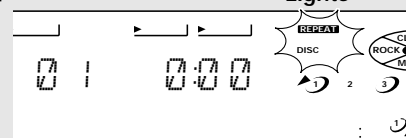

3 Select the disc.



To stop repeated playback

Press the REPEAT key twice.

+ The "DISC REPEAT" indicator goes off and the playback following the current mode of the CD player starts.

To repeat all discs



1 Confirm that the "PGM" indicator is not lit.

If the "PGM" indicator is lit, press the P.MODE key to turn it off.

Confirm that this is not lit.

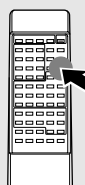
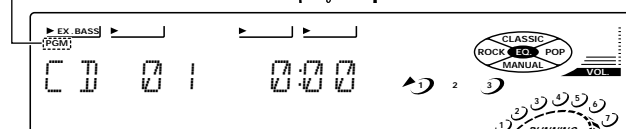

2 Specify "ALL REPEAT"



Each press switches the repeat mode.

- 1 REPEAT
- 2 DISC REPEAT
- 3 ALL REPEAT
- 4 Repeat OFF

Lights

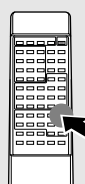
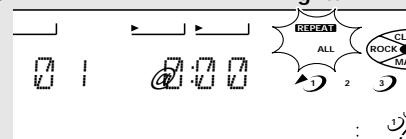

3 Select the disc to be played first.



To stop repeated playback

Press the REPEAT key again.

+ The "ALL REPEAT" indicator goes off and the playback following the current mode of the CD player starts.

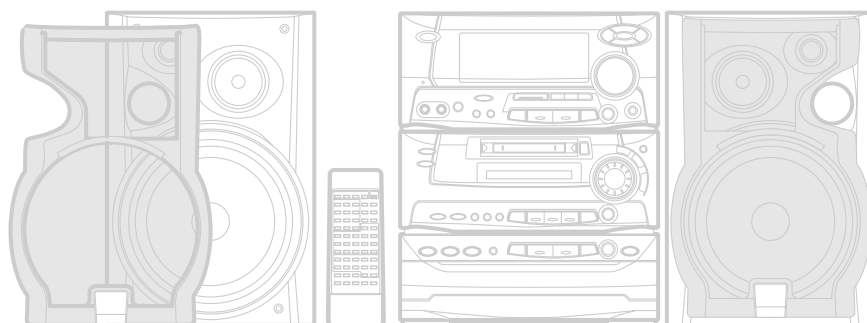

To repeat only one track



❶ Confirm that the "PGM" indicator is not lit.

If the "PGM" indicator is lit, press the P.MODE key to turn it off.

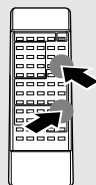

❷ Select "REPEAT".

❸ Select the disc.

❹ Select the track.



Each press switches the repeat mode.

- ❶ REPEAT
- ❷ DISC REPEAT
- ❸ ALL REPEAT
- ❹ Repeat OFF

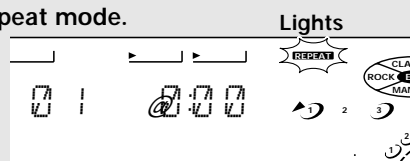

To stop repeated playback

Press the REPEAT key three times.

+ The "REPEAT" indicator goes off and the playback following the current mode of the CD player starts.

To repeat only the programmed tracks

❶ Program the track sequence according to steps ❶ to ❸ of "Listening in the desired sequence".



❷ Select "REPEAT".

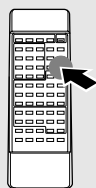

❸ Start playback.

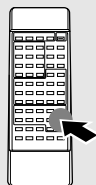

+ All selected tracks will be repeated.

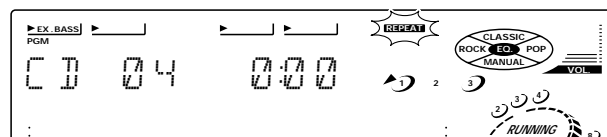

To stop repeated playback

Press the REPEAT key again.

+ The "REPEAT" indicator goes off and the playback following the current mode of the CD player starts.

Application section

Listening to an unexpected title sequence (random playback)

As the titles each time are selected randomly, the music can be enjoyed without getting tired of it.

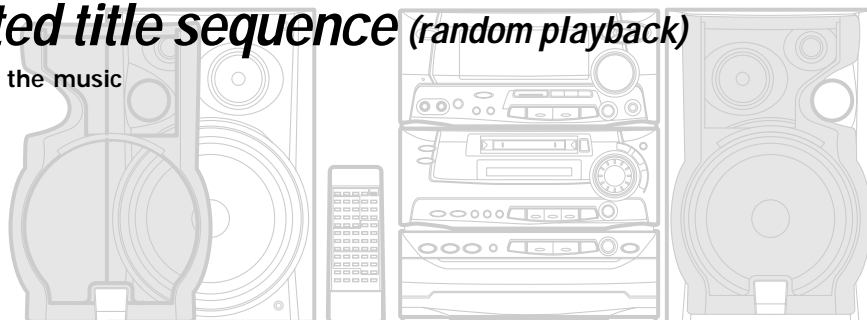

Select the "CD" input.

1 Confirm that the "PGM" indicator is not lit.

If the "PGM" indicator is lit, press the P.MODE key to turn it off.

Confirm that this is not lit.

2 Select the RANDOM mode.

Please select the disc before selecting "DISC RANDOM".

Each press switches the modes as follows.

- ① INTRO There is no random playback with this selection.
- ② DISC RANDOM Random play of one disc.
- ③ ALL RANDOM Random play of all discs.
- ④ Normal playback

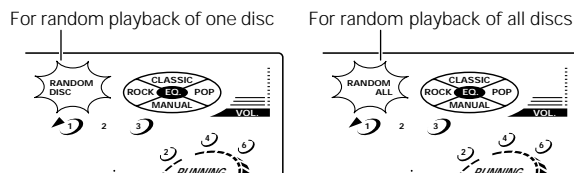

- + Playback stops after each title has been played once.
- + The random playback can also be repeated by pressing the REPEAT key.



To select another track in the middle of playing one

+ Pressing the P.CALL key once returns to the beginning of the track being played.

To cancel random playback

Press so that the "RANDOM" indicator goes off.

+ The "RANDOM" indicator goes off and the playback in order of the tracks starts from the track being played.

Listening in the desired sequence (program playback)

Use the following procedure to program desired tracks in a desired order. (up to 25 tracks)

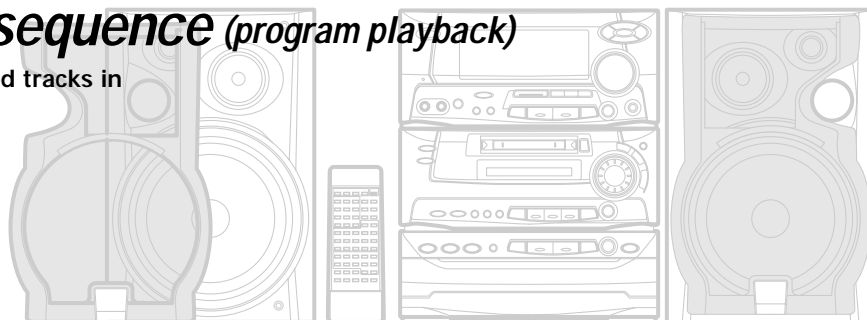

Select the "MD" input.

1 Let the "PGM" indicator light.

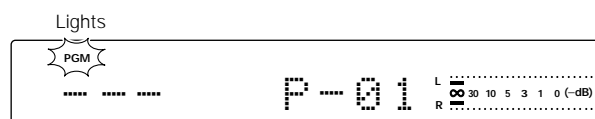
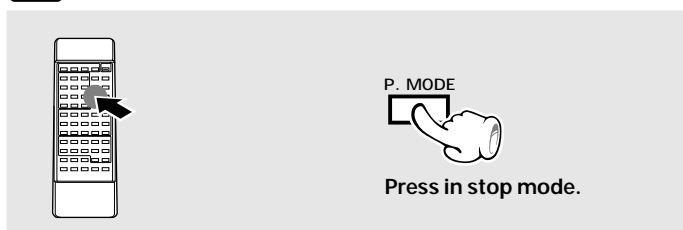

2 Select track numbers in the order you want to play them.

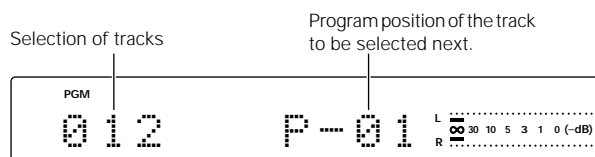
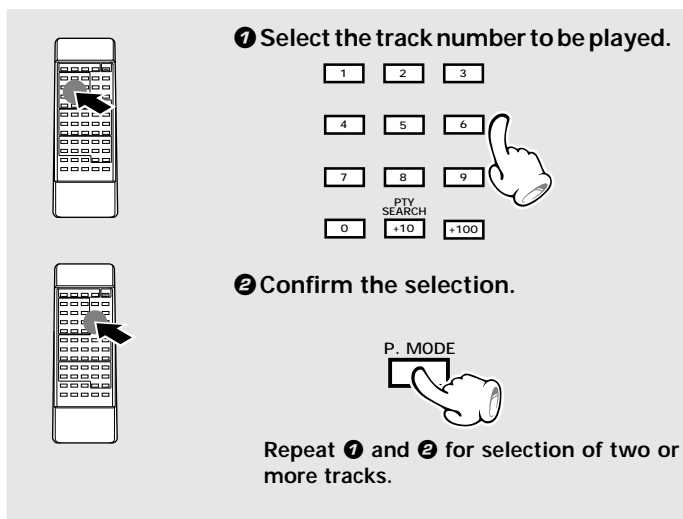

Press the numeric keys as shown below....

To enter track No. 23 : [+10] [+10] 3

To select track No. 40 : [+10] [+10] [+10] [+10] 0

- + Up to 25 tracks can be programmed. More than 25 tracks cannot be selected.
- + If you made a mistake, press the **P.CLEAR** key and enter the track No. again.
- + An extremely short track cannot be programmed.
- + "-- -- :-- --" is displayed when the total programmed period has attained 200 minutes or more.

3 Start playback.

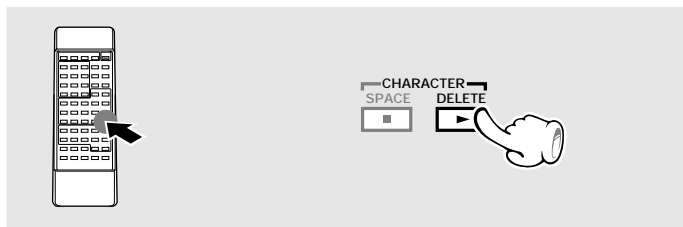

- + Tracks will be played in the order they are programmed.
- + When the ◀◀ or ▶▶ key is pressed during playback, tracks will be skipped in the direction of the pressed key.

To stop playback



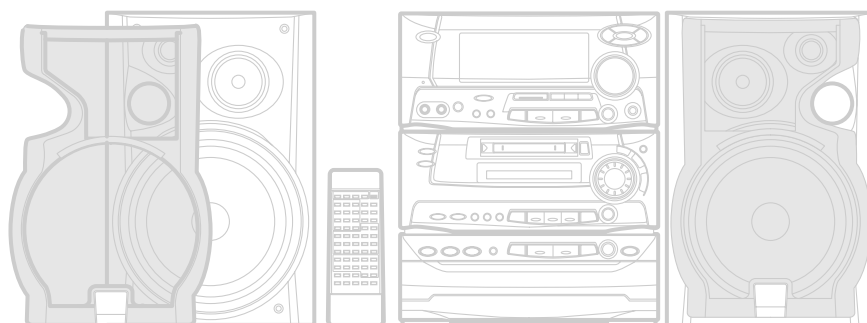

To add a track to the program

1 Sequentially select the track numbers to be added.

1 2 3
4 5 6
7 8 9
0 PTY SEARCH +10 +100

Press in stop mode.

2 Confirm the selection.

P. MODE

Repeat **1** and **2** for selection of two or more tracks.

+ When a track No. is entered, the track will be added to the end of the existing program.

Checking the order of tracks

P. CHECK

The "PGM" indicator blinks

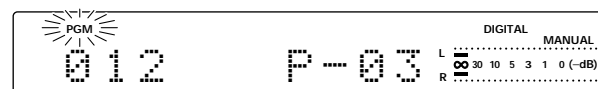

+ Each press displays the next track in the program.

To clear tracks from the program

Clearing tracks from the end

P. CLEAR

Press in stop mode.

Clearing all tracks

Remote control unit Main unit

P. MODE or P. MODE

Press in stop mode.

Last program display after deletion

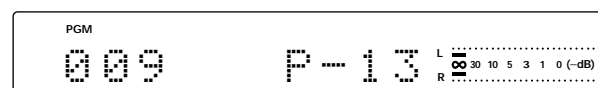

(P-14 has been deleted.)

+ Each time the key is pressed, the last track in the program is cleared.

+ The entire program is cleared.

Repeated playback

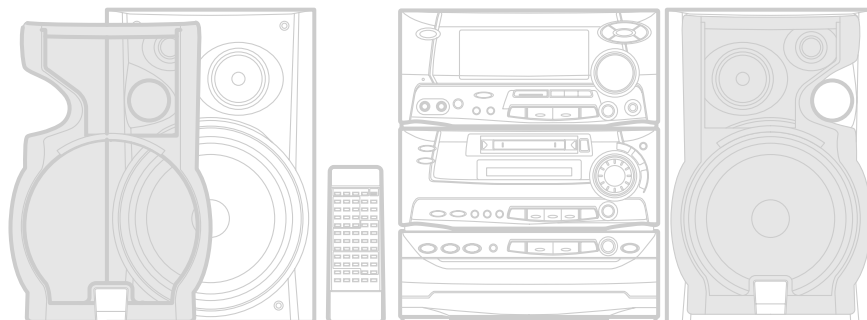

Select the "MD" input.

To repeat only the programmed tracks

1 Program the track sequence according to steps 1 to 2 of "Listening in the desired sequence".

→ 34

2 Let the "REPEAT" indicator light.



3 Start playback.

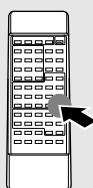

"REPEAT", "PGM" light.



- + All of the programmed tracks will be repeated.
- + In case only one track is programmed, only that track will be repeated.

To stop repeated playback

Press the REPEAT key again.

- + The "REPEAT" indication goes out and program playback is executed.

Application section

To repeat the entire disc

1 Make the PGM display go out.

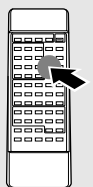

Press in stop mode.

2 Let the "REPEAT" indicator light.



3 Start playback.

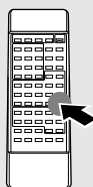

"PGM" goes off, "REPEAT" light.

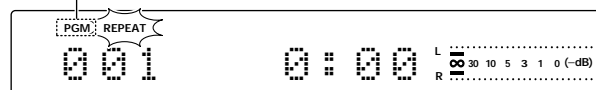

To stop repeated playback

Press the REPEAT key again.

- + The "REPEAT" indication goes out and program playback is executed.

RDS is a system which transmits useful information (digital data) for FM broadcasts together with the broadcast signal. Tuners and receivers designed for RDS reception can extract the information from the broadcast signal for use with various functions such as automatic display of the station name.

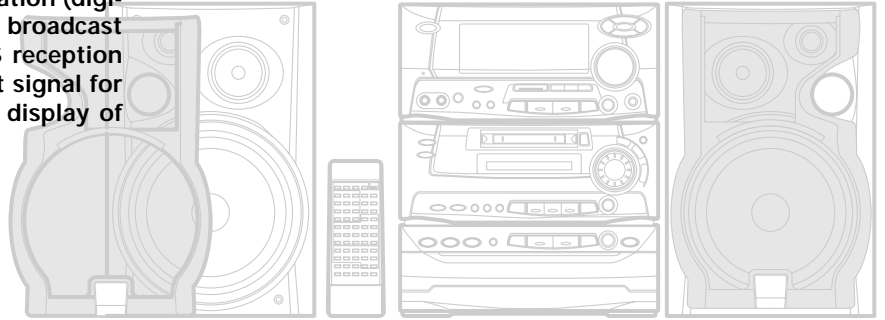

This unit is equipped with the following functions utilizing RDS data :

PTY (Program Type Identification) Search :

The tuner automatically searches for a station which is currently broadcasting a specified program type (genre).

PS (Program Service Name) Display : (See below.)

When an RDS broadcast is received, the station name is automatically displayed.

EON (Enhanced Other Network) :



When the information to be received is set in advance and any RDS station in the same network starts broadcasting of such information, the reception automatically will be switched to that station.

The "RDS" indicator lights up when an RDS broadcast (signal) is received.

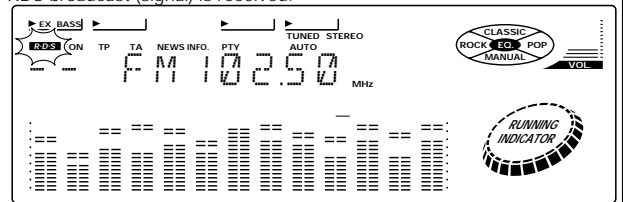

+ Some functions may not be provided or be given different names depending on countries or areas.

Before using RDS

For reception of RDS stations, the auto presetting function must be used to preset the stations. With the auto presetting function, RDS stations are preset with priority. "NO DATA" will be flashed when a station is not preset by auto presetting.

Set the reception band to FM. Preset RDS stations with the auto preset function.

To switch the display contents

Pressing the RDS DISP. key changes the display contents.

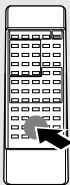

Display mode priority ranking

When an RDS broadcast is received

- ① **PS (Program Service Name) Display :**
When an RDS broadcast is received, the station name is automatically displayed. If no PS data was sent, "NO PS" is displayed.

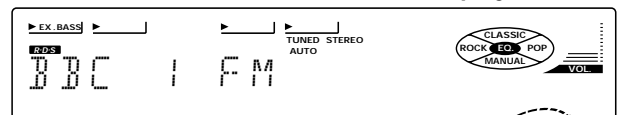

- ② **Frequency Display :**
The frequency of the current station is displayed.

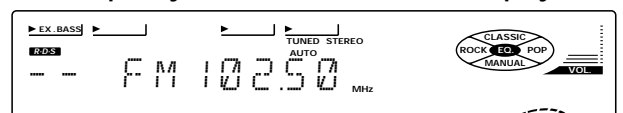

Searching for a desired program type (PTY search)

By specifying the type of program (genre) you want to listen to, the tuner automatically searches for a station which is currently broadcasting a program of the specified type.

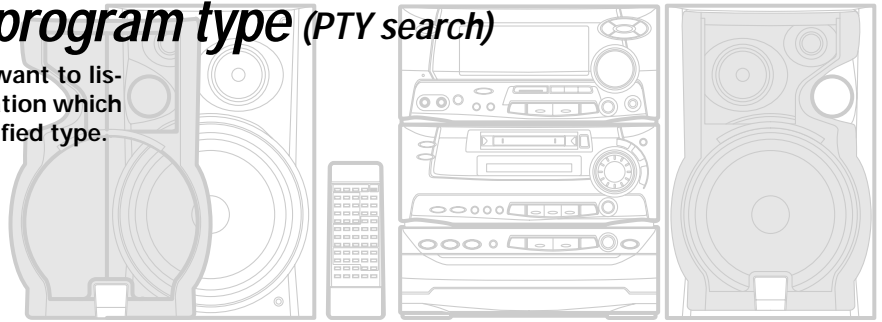

Set the reception band to FM. Preset RDS stations with the auto preset function.



1 Select the PTY search mode.

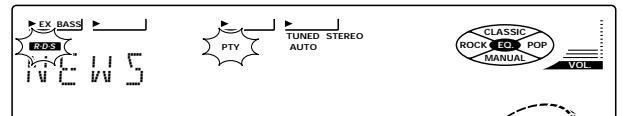
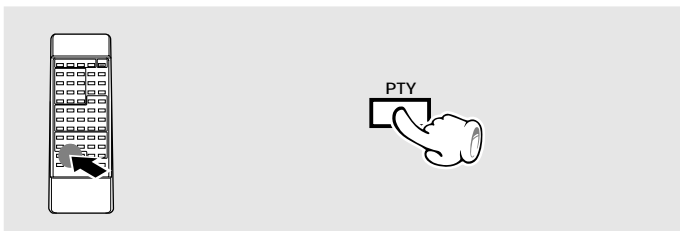

When an RDS broadcast is received, the program type is shown on the display. If no PTY data is available, or if the station is not an RDS station, "NONE" is displayed.

2 Select the desired program type.

Use program type table on the right for your convenience.

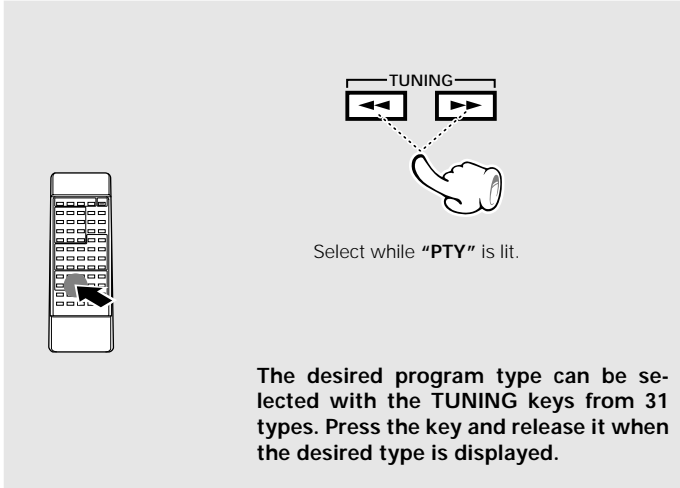

Program type table

TUNING keys	Program Type Name	Display
DOWN ↑ UP	Pop Music	POP M
	Rock Music	ROCK M
	*M.O.R. Music	M.O.R. M
	Light Classical	LIGHT M
	Serious Classical	CLASSICS
	Other Music	OTHER M
	News	NEWS
	Current Affairs	AFFAIRS
	Information	INFO
	Sport	SPORT
	Education	EDUCATE
	Drama	DRAMA
	Culture	CULTURE
	Science	SCIENCE
	Varied	VARIED
	Weather	WEATHER
	Finance	FINANCE
	Children's programs	CHILDREN
	Social affairs	SOCIAL A
	Religion	RELIGION
	Phone in	PHONE IN
	Travel	TRAVEL
	Leisure	LEISURE
	Jazz music	JAZZ
	Country music	COUNTRY
	National music	NATION M
	Oldies music	OLDIES
	Folk music	FOLK M
	Documentary	DOCUMENT
	Alarm test	TEST
	Alarm	ALARM

*M.O.R. Music (Middle of the Road Music)

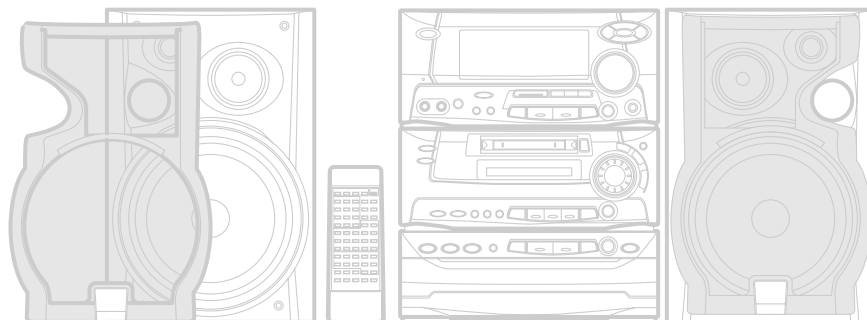

3 Start the search.

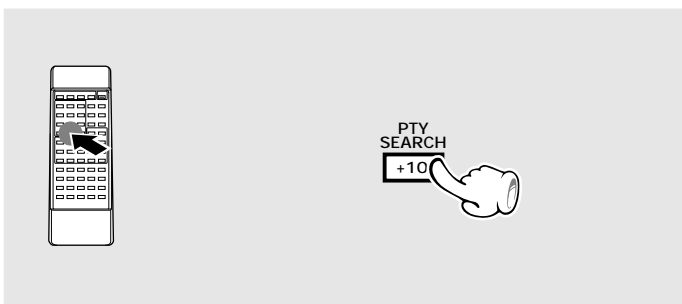

When searching for a Rock Music broadcast

Display while the tuner is searching.

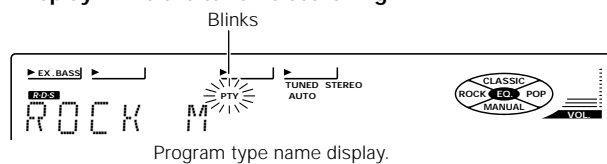

When a station is received.

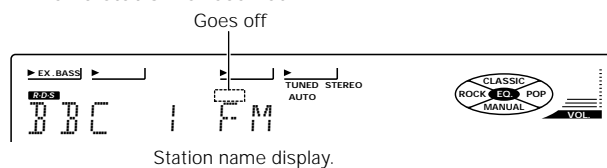

To change to a different program type :

Repeat steps 1, 2, 3.

- + No sound is heard while "PTY" is blinking.
- + If a program of the desired type cannot be found, "NO PROG" is displayed, then after several seconds the display returns to the original display.
- + If a program of the desired type is found, that program is received and the program type name display changes temporarily to the frequency display, and then to the station name display.

To be able to listen to the desired information at any time

By using the EON function, which manages the information of other stations, listening to desired information like traffic information or news etc. can be reserved even when it is not being transmitted at the present. When listening to a station with the "EON" display lit and another station of the same network starts to broadcast an information program for which a reservation has been made, then that station will be selected automatically. When the desired information program ends, return is made to the original program.

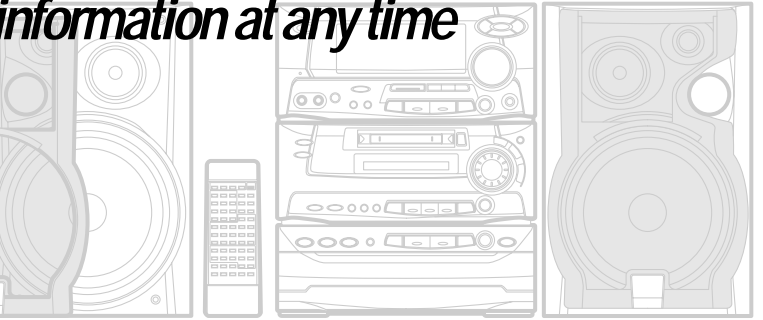



Set the reception band to FM.

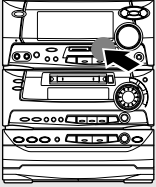

1 Auto preset the stations.

① Receive a broadcast.
 ② Keep the ENTER key pressed (2 sec or longer).



The EON data presently being broadcasted are taken in automatically.



This is not required when auto presetting has already been executed. ∞

+ When all 40 stations have already been preset by the procedure for "One-by-one presetting (manual preset)", the EON function will not operate. Auto presetting must be used.

2 Select the desired information.





TA/NEWS/INFO.

Each press switches the modes as follows.

- ① TA.....Traffic Announcement
- ② NEWS..... News
- ③ INFO.....Information
- ④ Display not lit.....EON cancelled

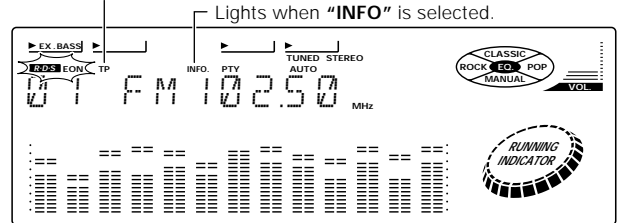
This lights when a station transmits traffic information.



+ Please execute automatic presetting when TA, NEWS, and INFO cannot be selected.

3 Receive an RDS station.

Select a station where "RDS" and "EON" are lit.

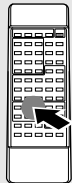
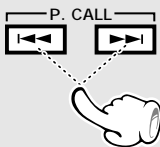
P. CALL

"RDS" and "EON" are lit.

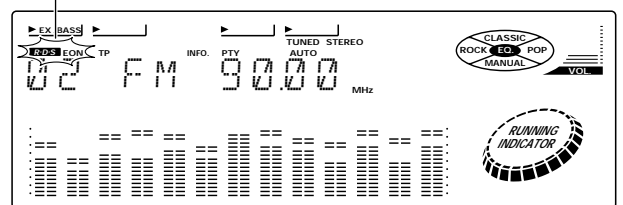

+ When "EON" does not light although an RDS station is received, that station is not transmitting EON data. Please select a different station.

+When TA is desired, select a station where the "TP" display lights.

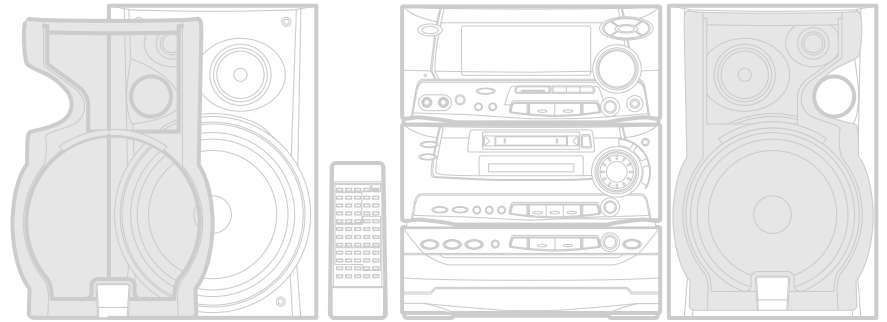

4 Wait for the desired information.

CD or MD playback may also be started. As long as the unit is ON, the unit is always ready for the reception.

- + When one of the stations of the network of the station received in **2** starts broadcasting the program contents selected in **2**, that station will be received automatically. At this time, MD playback and CD playback will pause. However, external equipment (AUX) will remain as it is.
- + When the unit is OFF and during recording (including dubbing), the EON function does not operate.
- + When the transmission of the selected program contents ends in case of automatic reception with the EON function, return will be made to the status directly before operation of the EON function. When MD or CD playback has been interrupted, it will be continued from the point of interruption.

In case of waiting for information with an RDS station without EON function

When there is no "EON" display with the operations of steps **2** and **4** and the desired information is selected in advance, waiting for the desired information will be done only with the presently received RDS station.

In regard to TP (Traffic Program) indicator

When the "TP" indicator is lit, this indicates that the station or another station in the same network is broadcasting traffic information. Even without an EON reservation, traffic information can be heard from the station when "TP" indicator is lit for the presently received station.

Selection of the Recording Type

This chapter explains also the cassette deck recording functions under consideration of combination with the cassette deck (option).

Many convenient recording functions have been provided. Please select them according to the application.

It is possible to record desired tracks in the desired sequence from two or more CDs. In this case, select "Program recording".

For recording to tape, please read "Let's record" in the operation manual of the cassette deck (option) carefully.

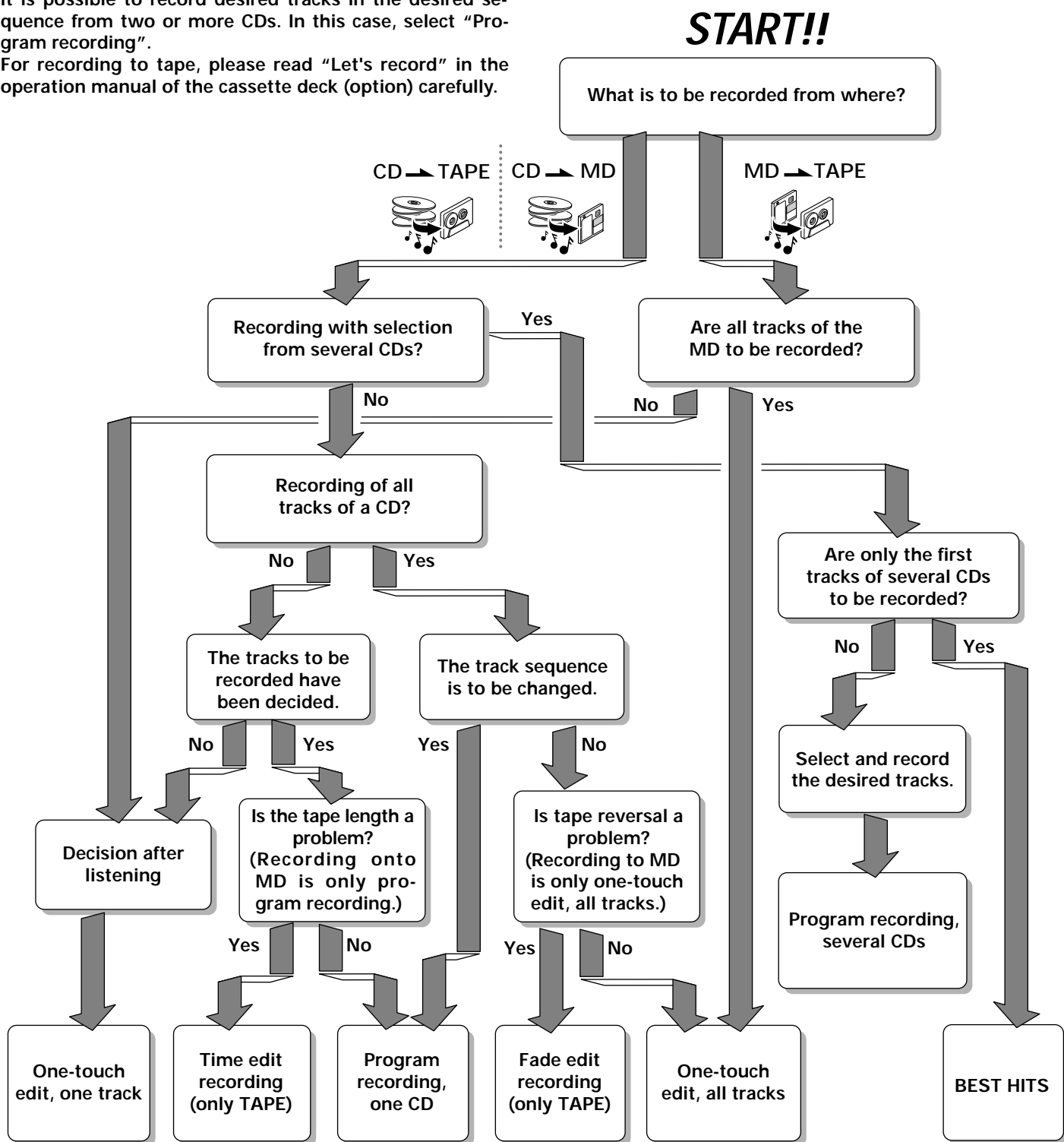

Application section

What is CCRS? (only cassette deck (option))

This is a function for one-touch recording of a CD onto tape. When the CCRS key is pressed, the CD contents and the characteristics of the tape to be used are checked for about 60 sec. (depending on the CD contents), the recording level is set automatically, and recording starts. At the end of the recording, stop is executed automatically. The setting is cancelled when the unit is switched OFF or the CD is stopped.



Fade-in/fade-out

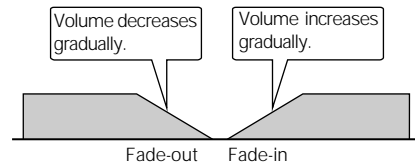

Fade-out : Ending a tune by gradually decreasing the volume.
 Fade-in : Starting a tune by gradually increasing the volume.

A One-touch recording of one CD, MD

(one-touch edit recording of all tracks)

→ 44

All tracks of one CD or MD are recorded. Recording is possible to tape or MD from CD and to tape from MD.

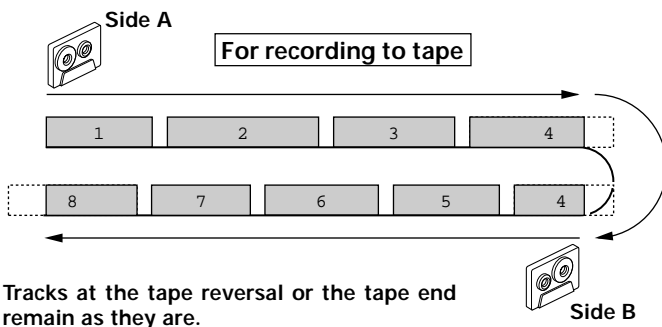

B When a desired track is found, only that track is recorded

(One-touch edit recording of one track)

→ 45

While listening to a CD or MD, it is possible to record only the track being heard at that time from the beginning of that track. Recording is possible to tape or MD from CD and to tape from MD. This is convenient for recording of desired tracks from a disc being heard for the first time.

C Producing a MD collecting only the first titles

(BEST HITS function)

→ 46

The first tracks of all set CDs are recorded in sequence on MD.

Producing a tape collecting only the first titles

(BEST HITS function)

→ 47

The first tracks of all set CDs are recorded in sequence on tape.

D Recording of one CD or several CDs

(CD → MD) (Program recording)

→ 48

From one CD Recording in the programmed sequence from CD to MD.

From 2 or more CDs Selected tracks are recorded from several CDs to MD.

Recording of one CD or several CDs

(CD → TAPE) (Program recording)

→ 49

From one CD Recording in the programmed sequence from CD to tape.

From 2 or more CDs Selected tracks are recorded from several CDs to tape.

E Change of the track sequence according to the tape length

(CD → TAPE only) (Time edit recording)

→ 50

The order of CD tracks are changed automatically so that no tune is interrupted at the end of tape sides A and B. (Up to 32 tracks)

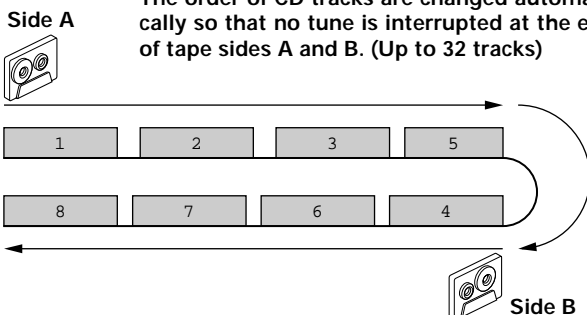

F Fade-out/Fade-in at the tape reversal

(CD → TAPE only) (Fade edit recording)

→ 52

CD tracks are recorded in the order they are recorded. The tune interrupted at the end of tape side A is faded out and side B starts with fading in from the middle of that tune.

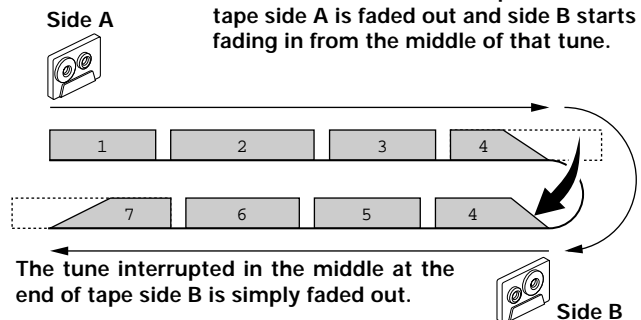

One-touch recording of one CD, MD (one-touch edit recording of all tracks)

All tracks of one CD or MD are recorded.

Recording is possible to tape or MD from CD and to tape from MD.

For recording to tape, please read "Let's record" in the operation manual of the cassette deck (option) carefully.



When equalizer, SRS 3D, or any other effect is applied to the sound, the sound with applied effect can be recorded (except for digital recording from CD to MD).

→ 63 → 65

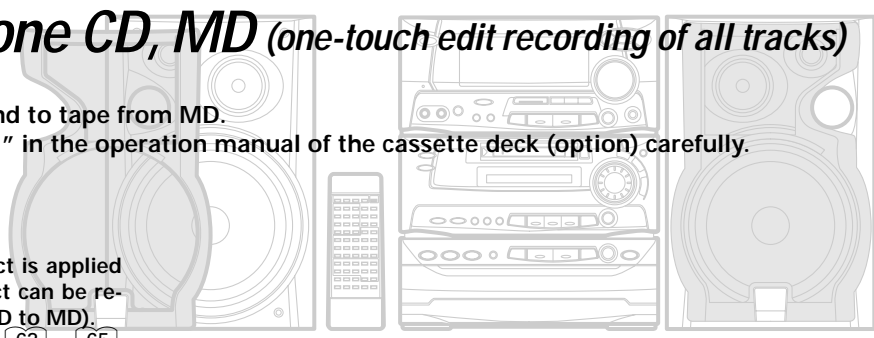

1 Make the preparations for recording.

CD → MD

- 1 Insert a recordable disc into the MD recorder.
- 2 Select CD with the INPUT key.
- 3 Insert disc(s) in the CD player.

→ 18

MD → TAPE

- 1 Load a tape.
- 2 Select the tape transport direction. (◀ or ▶)
- 3 Select "D". (two-side recording)
- 4 Select the Dolby NR mode.
- 5 Select MD with the INPUT key.
- 6 Insert disc(s) in the MD recorder.

→ 20

CD → TAPE

- 1 Load a tape.
- 2 Select the tape transport direction. (◀ or ▶)
- 3 Select "D". (two-side recording)
- 4 Select the Dolby NR mode.
- 5 Select CD with the INPUT key.
- 6 Insert disc(s) in the CD player.

→ 18

2 Start recording.



CD player and MD recorder must be brought to stopped condition.

CD → MD

- 1 Select the target disc.

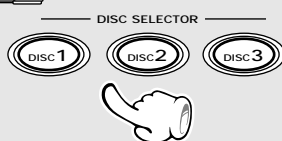
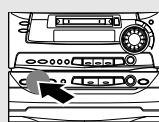

- 2 Start recording.

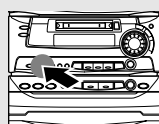

Press before playback of the CD starts.

MD → TAPE

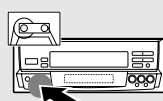

Press in stop mode.

CD → TAPE

- 1 Select the target disc.

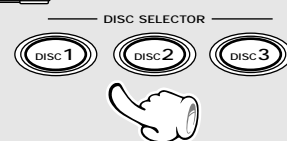
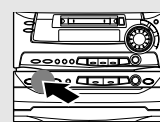

- 2 Start recording.

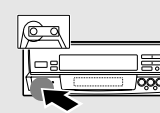

Press before playback of the CD starts.

Note When the O.T.E. key is pressed after playback has started, only the track being played at that time will be recorded. → 45

+ With recording onto tape, the track will be interrupted for the part of the guide tape at the tape reversal, where recording is not possible. Please use a different recording method if this is to be avoided.

To interrupt a recording

CD → MD

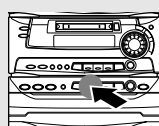

MD → TAPE

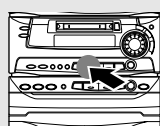

CD → TAPE

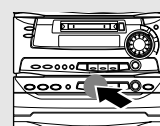

+ Recording and playback will be stopped.

Application section

When a desired track is found, only that track is recorded

(One-touch edit recording of one track)

While listening to a CD or MD, it is possible to record only the track being heard at that time from the beginning of that track. Recording is possible to tape or MD from CD and to tape from MD. For recording to tape, please read "Let's record" in the operation manual of the cassette deck (option) carefully.



When equalizer, SRS 3D, or any other effect is applied to the sound, the sound with applied effect can be recorded (except for digital recording from CD to MD).

→ 63 → 65

1 Make the preparations for recording.

CD → MD

- 1 Insert a recordable disc into the MD recorder.
- 2 Select CD with the INPUT key.
- 3 Insert disc(s) in the CD player.

→ 18

MD → TAPE

- 1 Load a tape.
- 2 Select the tape transport direction. (◀ or ▶)
- 3 Select "D". (two-side recording)
- 4 Select the Dolby NR mode.
- 5 Select MD with the INPUT key.
- 6 Insert disc(s) in the MD recorder.
- 7 Adjust the recording level.

→ 20

CD → TAPE

- 1 Load a tape.
- 2 Select the tape transport direction. (◀ or ▶)
- 3 Select "D". (two-side recording)
- 4 Select the Dolby NR mode.
- 5 Select CD with the INPUT key.
- 6 Insert disc(s) in the CD player.
- 7 Adjust the recording level.

→ 18

2 Playback of a CD or MD.

3 Press the O.T.E. key during playback of a track to be recorded.

CD → MD

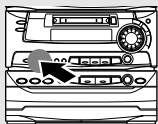

Press during playback.

MD → TAPE

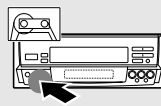

Press during playback.

CD → TAPE

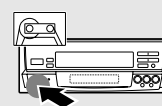

Press during playback.

+ Return is made to the beginning of the track being played and recording starts.

At the end of the recording

MD recorder : Stop.

Cassette deck : Stop is executed after an unrecorded portion of about 4 sec. has been produced.

To record another track ... repeat the steps 2 and 3.



To interrupt a recording

CD → MD

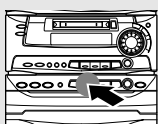

MD → TAPE

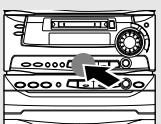

CD → TAPE

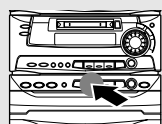

+ Recording and playback will be stopped.

Producing a MD collecting only the first titles (BEST HITS Function)

The first tracks of all set CDs will be recorded on MD in sequence. During recording of the third disc, the already recorded discs can be exchanged. This is convenient for collecting from a large number of single CDs.



When equalizer, SRS 3D, or any other effect is applied to the sound, the sound with applied effect can be recorded (except for digital recording from CD to MD).

→ 63 → 65

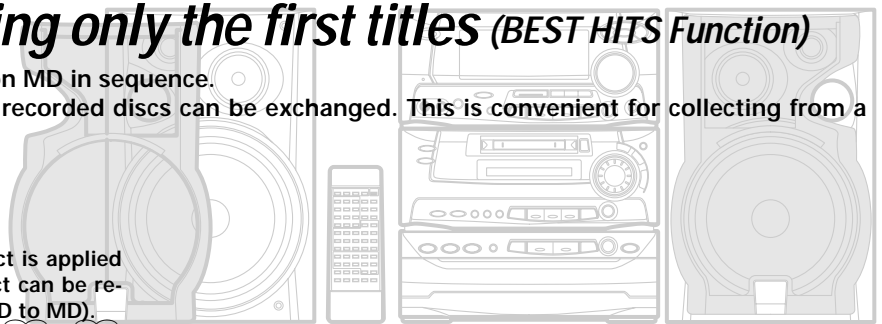

1 Make the preparations for recording.

- 1 Insert a recordable disc into the MD recorder.
- 2 Select CD with the INPUT key.
- 3 Insert disc(s) in the CD player.

→ 18

2 Confirm that the "PGM" indicator is not lit.

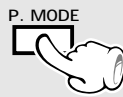

Goes off

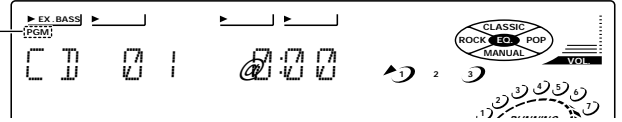

3 Press the BEST HITS key.

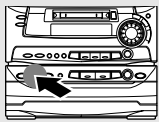

- 1 Select the disc for start of recording.



- 2 Press the BEST HITS key.



Press in stop mode.

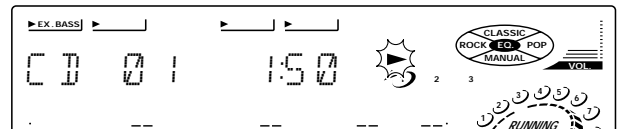

4 Exchange discs as required.

- 1 Exchange the (two) discs.

The tray opens automatically.

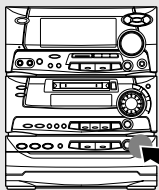

- 2 Close the tray.

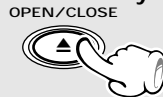

+When recording from the third disc starts, the tray opens automatically. The two already recorded discs can be exchanged.

To end recording

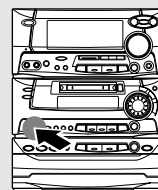

BEST HITS



- + Recording ends at the end of the track presently being recorded.
- + Recording and playback are also stopped when the ■ key of the CD player is pressed.

When the discs are exchanged sequentially, recording can be continued without interruptions.



Producing a tape collecting only the first titles (BEST HITS Function)

The first tracks of all set CDs will be recorded on tape in sequence. During recording of the third disc, the already recorded discs can be exchanged. This is convenient for collecting from a large number of single CDs.

Please read "Let's record" in the operation manual of the cassette deck (option) carefully.



When equalizer, SRS 3D, or any other effect is applied to the sound, the sound with applied effect can be recorded.

→ 63 → 65



1 Make the preparations for recording.

- 1 Load a tape.
- 2 Select the tape transport direction. (◀ or ▶)
- 3 Select "▷". (two-side recording)
- 4 Select the Dolby NR mode.
- 5 Select CD with the INPUT key.
- 6 Insert disc(s) in the CD player.
- 7 Adjust the recording level.

→ 18



With recording onto tape, the track will be interrupted for the part of the guide tape at the tape reversal, where recording is not possible. Please use a different recording method if this is to be avoided.

2 Confirm that the "PGM" indicator is not lit.

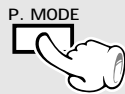

Goes off

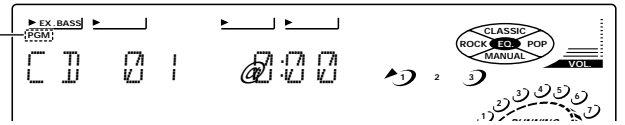

3 Press the BEST HITS key.

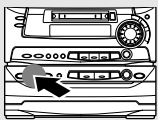

- 1 Select the disc for start of recording.



- 2 Press the BEST HITS key.

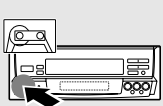

Press in stop mode.

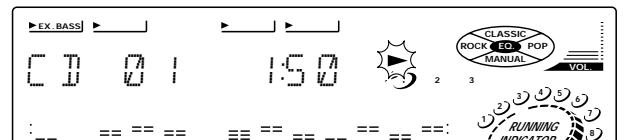

4 Exchange discs as required.

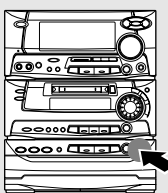

- 1 Exchange the (two) discs. The tray opens automatically.

- 2 Close the tray.



- + When recording from the third disc starts, the tray opens automatically. The two already recorded discs can be exchanged.
- + Recording ends when the tape end (one side or both sides) is reached.

To stop recording

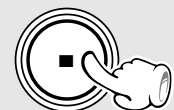
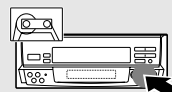

- + Recording and playback are stopped.
- + Recording and playback are also stopped when the ■ key of the CD player is pressed.

When the discs are exchanged sequentially, recording can be continued without interruptions.



Recording of one CD or several CDs (CD → MD) (Program recording)

The desired tracks from 3 CDs can be recorded in the programmed sequence on one MD.



When equalizer, SRS 3D, or any other effect is applied to the sound, the sound with applied effect can be recorded (except for digital recording from CD to MD).

→ 63 → 65

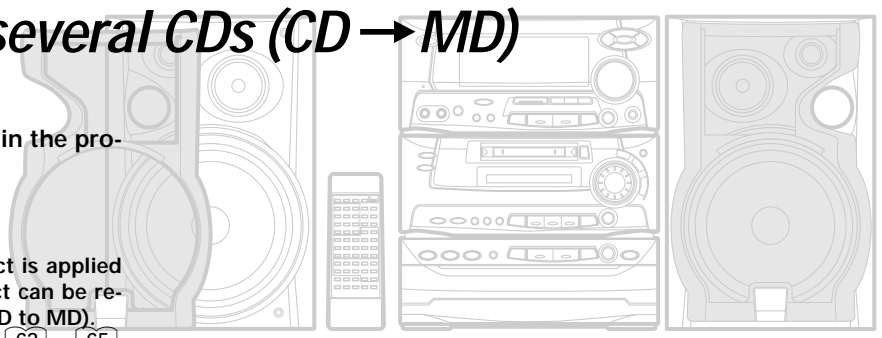

Recording preparation is required.

→ 44

1 Check that the CD player is in the stop mode.

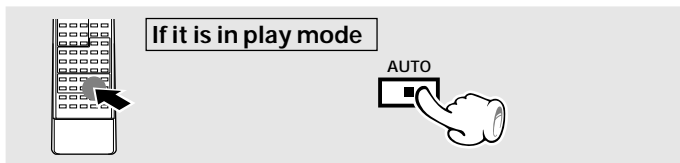

2 Light the "PGM" indicator.



3 Enter disc Nos. and track Nos. in the order you want to record them.

1 Select the disc.

DISC SKIP

Go to step 2 within 8 seconds.

2 Select the track.

1 2 3

4 5 6

7 8 9

0 P.TY SEARCH +10

3 Confirm the selection.

P. MODE

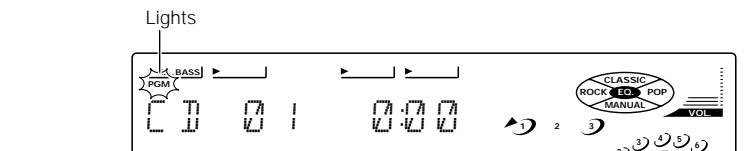

Displays the entered track No.

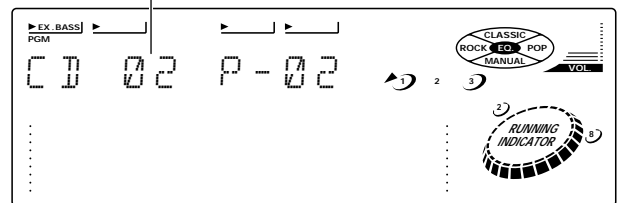

- + Select so that the usable recording time of the MD is not exceeded.
- + Up to 32 tracks can be programmed. When "FULL" is displayed, no more tracks can be programmed.
- + If you make a mistake, press the **P.CLEAR** key and enter the track No. from the beginning.
- + The **REPEAT** key is not effective.

To edit tracks from more than one CD, repeat 1, 2, 3 for each CD.

To check the edited contents → 51
To clear the edited contents → 51

4 Start edit recording.

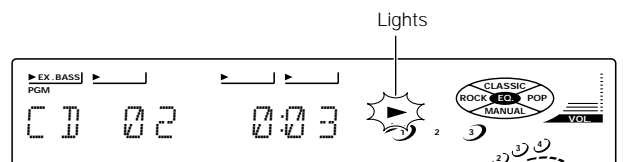
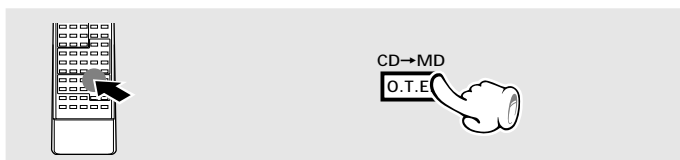

- + The MD recording is paused while the CD is exchanged in the tray.
- + Tracks programmed in excess of the MD recording time will be cut off.



Always remove the disc after recording.

Application section

Recording of one CD or several CDs (CD → TAPE) (Program recording)

The desired tracks from 3 CDs can be recorded in the programmed sequence on one tape.
Please read "Let's record" in the operation manual of the cassette deck (option) carefully.



When equalizer, SRS 3D, or any other effect is applied to the sound, the sound with applied effect can be recorded.

→ 63 → 65

Recording preparation is required.

→ 44

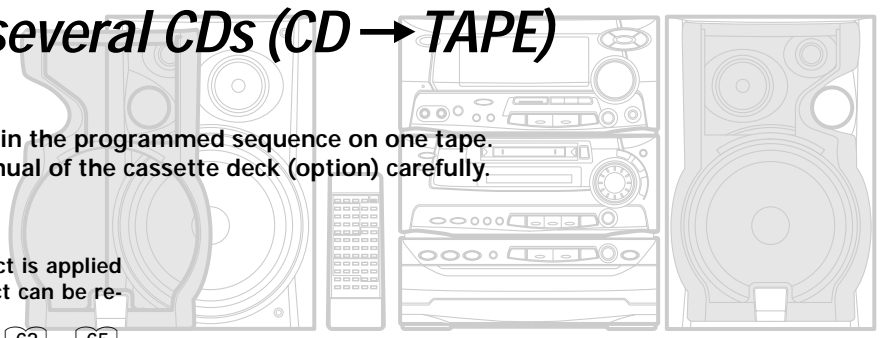

1 Check that the CD player is in the stop mode.

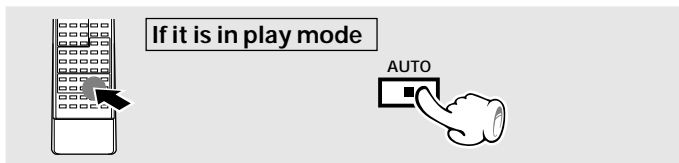

With recording onto tape, the track will be interrupted for the part of the guide tape at the tape reversal, where recording is not possible. Please use a different recording method if this is to be avoided.

2 Light the "PGM" indicator.

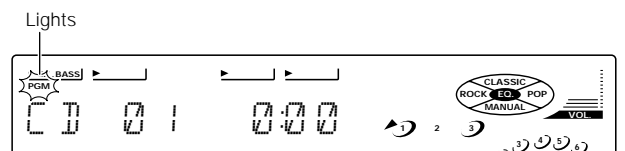
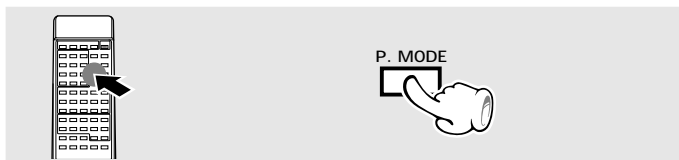

3 Enter disc Nos. and track Nos. in the order you want to record them.

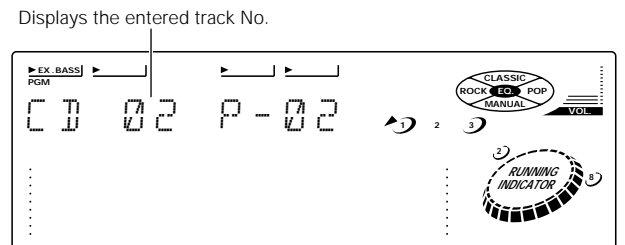
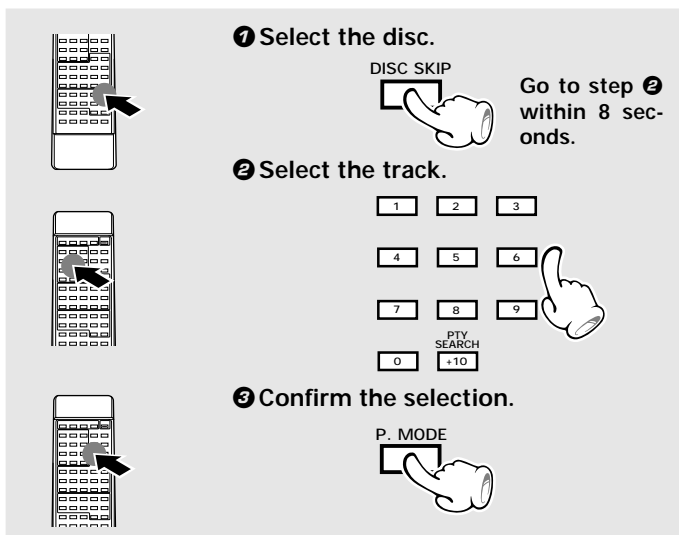

To edit tracks from more than one CD, repeat 1, 2, 3 for each CD.

To check the edited contents → 51
To clear the edited contents → 51

4 Start edit recording.

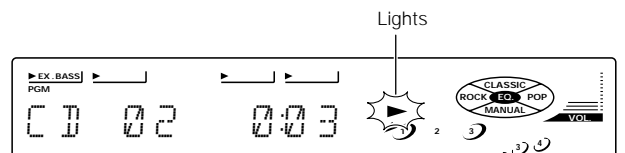

+ The tape recording is paused while the CD is exchanged in the tray.
+ Tracks programmed in excess of the tape recording time will be cut off.



Always remove the disc after recording.

Change of the track sequence according to the tape length (CD → TAPE only) (Time edit recording)

By specifying the recording time of the tape used, CD tracks can be recorded with their order automatically changed so that no tune is interrupted at the end of tape sides A and B. Please read "Let's record" in the operation manual of the cassette deck (option) carefully.



When equalizer or SRS 3D is applied to the sound, the sound will be recorded with applied effect.

→ 63 → 65

The key names in brackets in the explanations are the names of the keys on the remote control unit.

Recording preparation is required. → 44

1 Make sure that the "PGM" indicator is off.



- 1 Select CD with the INPUT key.
- 2 Make sure that the "PGM" indicator is off.



Goes off

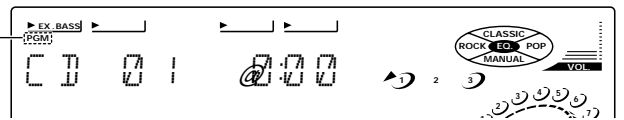

2 Light the "EDIT" indicator.



- 2 Light the "EDIT" indicator.
- Editing is cancelled in case of waiting for 8 sec. or more.



Lights

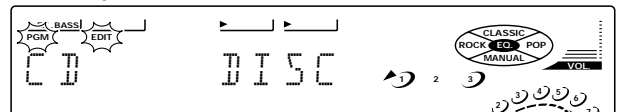

3 Enter the disc and tape conditions.



- 1 Select the disc.
- Go to step 2 within 8 seconds.
 - 2 Press the EDIT key.



- 2 Press the EDIT key.
- Go to step 3 within 8 seconds.



- 3 Enter the recording length of the tape.

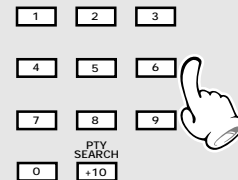

Press the numeric keys as shown below....

30-minute tape (C-30): [+10] [+10] [+10] [0]

46-minute tape (C-46): [+10] [+10] [+10] [+10] [6]

46-, 54-, 60- or 90-minute tapes can be selected simply by pressing the TIME DISP. (TIME/ENTER) key for the required number of times.

After entry, press the EDIT key then proceed to step 4.

- + The recording time can be set up to a maximum of 99 minutes.
- + Up to 32 tracks can be edited.
- + CD tracks will be edited automatically onto tape sides A and B. After editing, the "EDIT" indicator stops blinking and starts to light steadily.

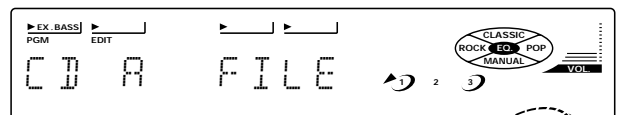

4 Start edit recording.

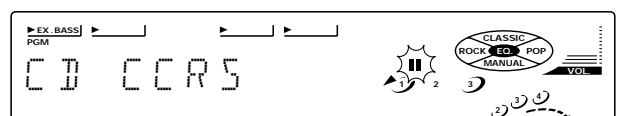
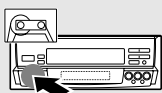

- + The recording level will be adjusted automatically in approx. 60 seconds (variable depending on CD contents), after which recording starts.
- + The tape and CD stop automatically when recording has completed.



Depending on the combination of conditions from CD contents (number of titles and length of the titles) and tape recording time, interruption of a title may not be avoidable. In such a case, the respective title will not be recorded.

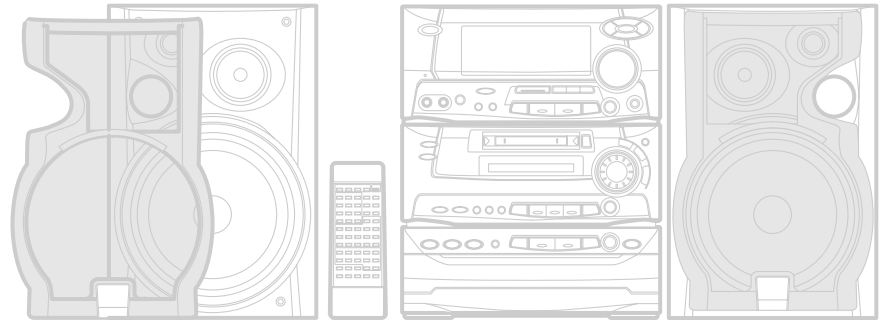

To check the edited contents
(Program recording, Time edit recording)

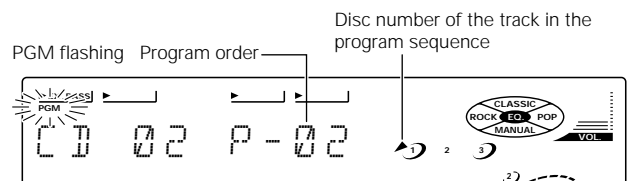
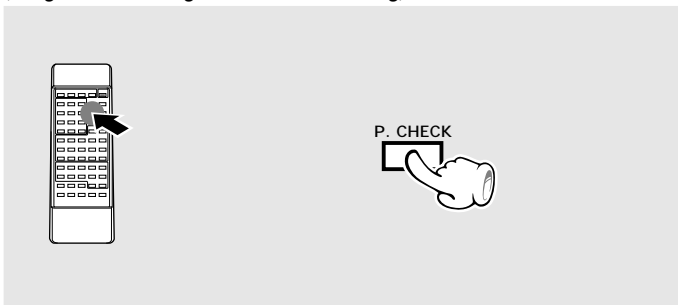

+ Each time the key is pressed, the program No. (P-NO) and the track No. on CD are displayed.

To clear the edited contents
(Program recording, Time edit recording)

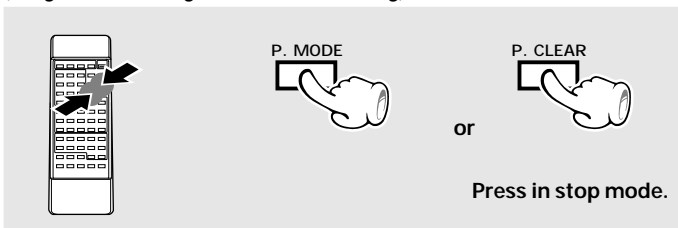

+ When the **P.MODE** key is pressed at the time of program recording, all editing contents are erased. When the **P.CLEAR** key is pressed, the tracks are deleted one by one from the end of the program.
+ When the **P.MODE** key or the **P.CLEAR** key is pressed at the time of time editing, the entire editing contents are deleted.

Fade-out/Fade-in at the tape reversal (CD → TAPE only) (Fade edit recording)

The tune interrupted at the end of tape side A is faded out and side B starts with fading in from the middle of that tune. The tune interrupted at the end of tape side B is simply faded out. Please read "Let's record" in the operation manual of the cassette deck (option) carefully.

 When equalizer or SRS 3D is applied to the sound, the sound will be recorded with applied effect. → 63 → 65

Recording preparation is required. → 44

1 Make sure that the "PGM" indicator is off.

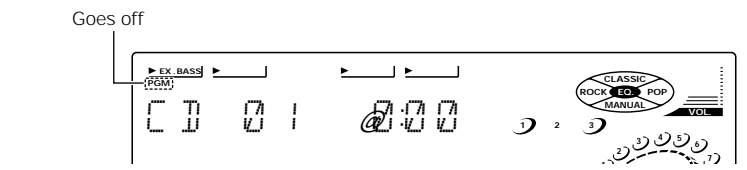
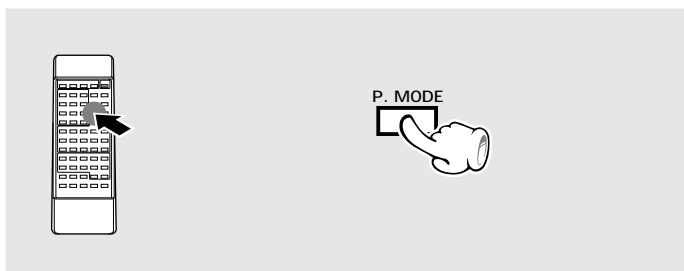

2 Select the disc.

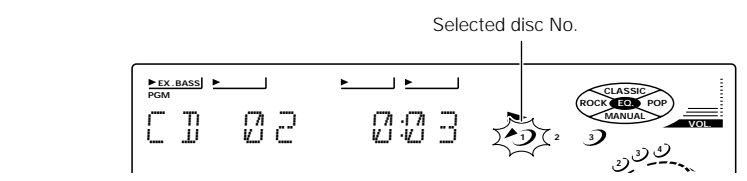
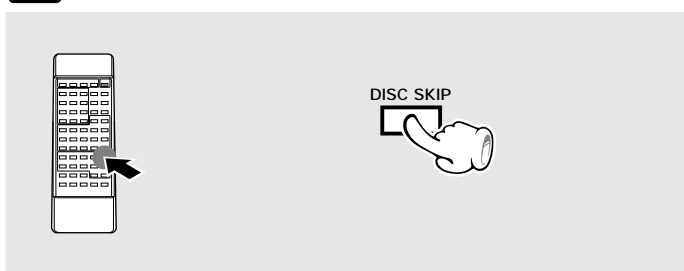

3 Start edit recording.

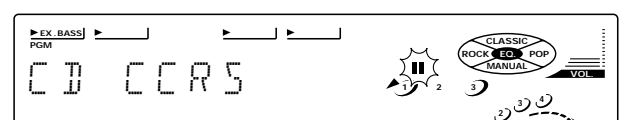
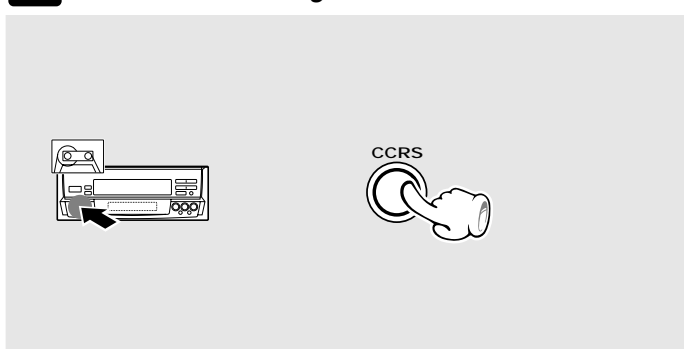

- + The recording level will be adjusted automatically in approx. 60 seconds (variable depending on CD contents), after which recording starts.
- + The CD tracks are recorded in the order they are recorded on the CD.
- + Automatic stop is executed when the recording ends.

Application section



1. When the **CCRS** key is pressed during playback of CD, the playback stops and the CCRS setting (preparing edited recording) starts.
2. Edit recording is not possible with CDs containing a track that is longer than one tape side, which may occur with classical music, etc.
3. If the deck is set for one-side recording (≡), the processing at the tape end is applied only on side A.
4. When the last tune of tape side B is faded out, the ending part of the last but one tune may sometimes be faded out if the space between it and the last tune is short.

Selecting the editing function type

When a commercially available Mini Disc fabricated for user recording is used, various editing operations can be applied after recording. Note that editing is not possible with commercially available prerecorded Mini Disc software designed for playback only.

For editing, set the write protect tab of the mini disc to "Write enable" side. → 5

Assigning a Title to a Disc or a Track → 54

Changing or deleting a title → 55

Reordering tracks by moving them → 56

Moving several tracks at a time (QUICK MOVE) → 56
 Moving a single track (TRACK MOVE) → 57

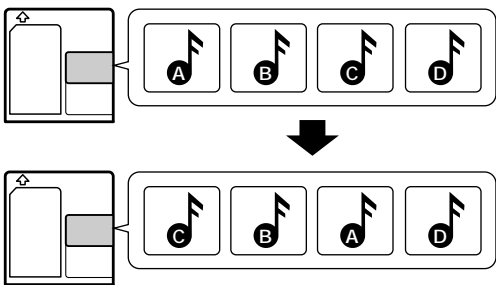

Erasing track(s)

Erasing a single track

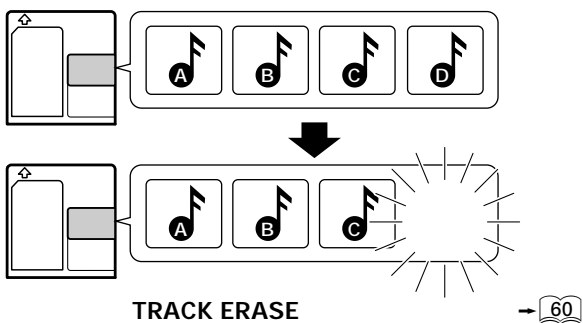

Erasing all tracks on a disc

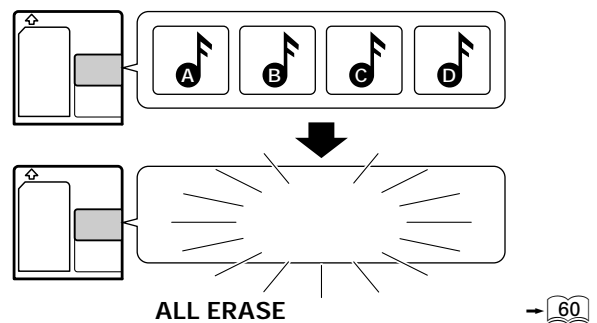

In regard to display scrolling

When the character information for the titles of mini discs or titles is too long, it cannot be displayed all at once. In such a case, the characters on the display scroll from the right to the left and the rest of the information can be seen. This is called scrolling.

Scrolling image

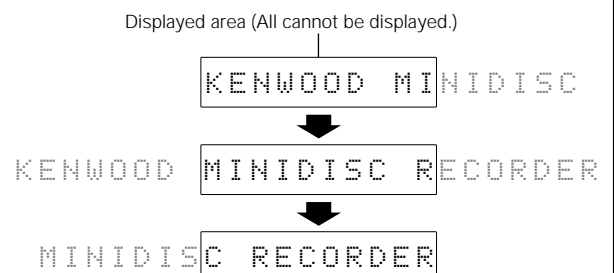

Function Limitations because of the MD Standard

Some of the functions are limited because of the MD standard. Please check this before assuming a malfunction. → 77

Title input is possible simply by selecting one character after another from the characters shown on the display. As the entered title is compatible between models, it will be displayed also when the disc is set into a different MD recorder (player). (The title compatibility is limited partly according to the character types which can be displayed, the number of characters, etc.)

Dividing a track, combining two tracks

Dividing a track into two

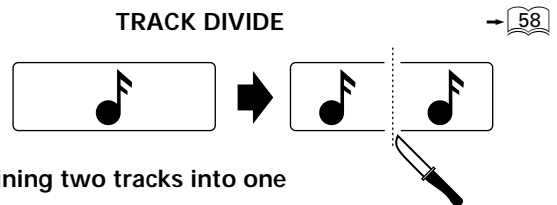

Combining two tracks into one

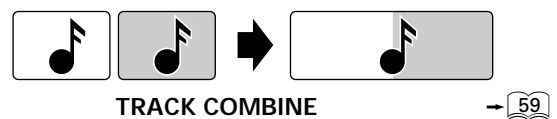

Assigning a title to a disc or track

When titles are assigned to a disc and its tracks, the titles cannot only be displayed during playback but title search (searching a track by the title) is also made possible. The assigned titles can be changed or deleted with the same procedure.

Always remove the minidisc after title input or editing. The names in brackets in the explanations are the names of the remote control keys.

Execute operation in stopped condition or during playback.

1 Activate the title input mode.

- 1 Press the TITLE INPUT key.
- 2 Select whether the disc title or track title input.
- 3 Set the selection.

To abort operation, press the TITLE INPUT key again.



When the ► (playback) key is pressed before step 3 while assigning a title to a track, the title can be entered while listening to that track. However, listening is not possible when assigning a disc title.

+ It takes a while because data should be read out of the disc.

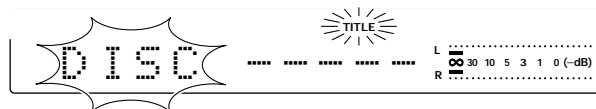

In case of disc title

In case of track title

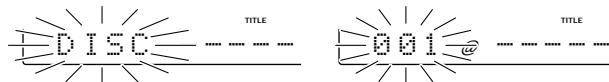

Select "DISC".

Select the desired track No.

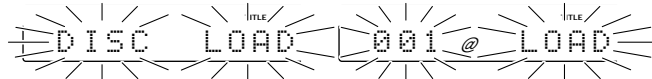

2 Input the title.

- 1 Select the group of the characters used in the title.
- 2 Select a desired character by placing the selection cursor on it.
- 3 Set the selected character.

Input the title characters by repeating 1 to 3 for each of them.

Each press of the CHARAC. (TRACK EDIT/CHARA.) key switches the group.

- 1 A-Z, space (1 blank character)
- 2 a-z, space
- 3 0-9, symbols, space



+ When the jog dial is turned, the display scrolls and all characters (in the same group) can be selected.

+ Pressing the DISPLAY MODE key allows to change the display characters on a per-screen (5 characters) basis.

Example of disc title



The cursor moves and waits for input of the next character.

+ The input cursor can be moved with the ◀◀, ▶▶ (L CURSOR R) keys.

3 Execute title assignment.

- 1 Enter the title in memory.
- 2 Complete the operation.



The title scrolls.

Application section

Changing or deleting a title

Total number of title characters

Up to 1792 characters can be input per disc and up to 80 characters can be input per track.

A space (blank character) also require the same amount of data as alphanumeric characters. When deleting a title, it is not recommended to overwrite spaces on previous characters but use the DELETE function.

Always remove the minidisc after title input or editing. The names in brackets in the explanations are the names of the remote control keys.

1 Perform step 1 of "Assigning a title to a disc or track".

→ 54

2 Change or delete characters one by one.

1 Move the cursor to the desired character (the character to be changed).

2 Select the character group.

1 ◀▶ (L CURSOR R) key

2 CHARAC. (TRACK EDIT/CHARA.) key

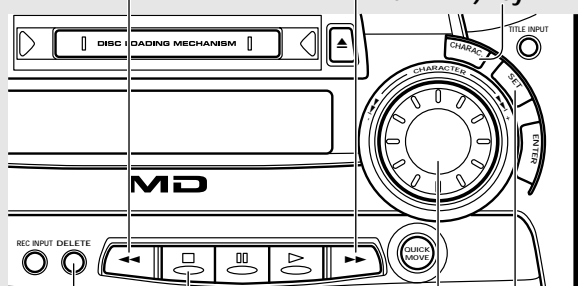

3 Jog dial

4 SET key

■ (CHARACTER SPACE) key
DELETED (CHARACTER DELETE) key

3 Select the correct character.

4 Confirm the character.

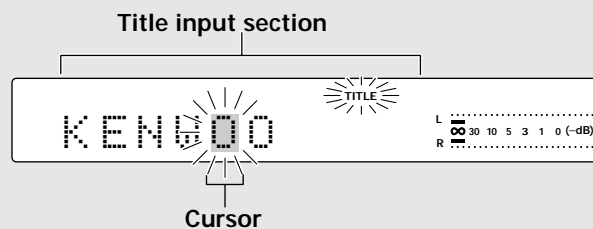

In regard to the key functions

DISPLAY MODE key :

The characters can be scrolled in units of five characters.

CHARAC. (TRACK EDIT/CHARA.) key :

The group of characters displayed at the character selection section is switched.

DELETE (CHARACTER DELETE) key :

The character at the cursor is deleted (erased) and the following characters move up by one character each. Titles can be erased easily by continuous pressing (or by holding the key down for repeated input).

■(CHARACTER SPACE) key :

A space (blank corresponding to one character) is entered (inserted) directly before the character at the cursor position, and the following characters all are moved back by one character. Continuous pressing (or repeated input by keeping the key pressed) also is possible. This is used mainly to provide space for adding characters to a title.

All characters of a title can be changed by repeating steps 1 to 4.

3 Execute title change or deletion.

1 Enter the title in memory.

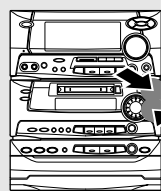

2 Complete the operation.

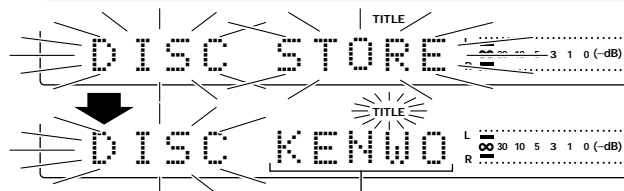

The title scrolls.

Moving several tracks at a time (QUICK MOVE)

Use the following procedure to change the current order of tracks by selecting a desired order and moving the tracks together.

20 continuous tracks within the specified range can be reordered at a time.

The names in brackets in the explanations are the names of the remote control keys.

Please execute operation in stopped condition.

1 Press the QUICK MOVE key.

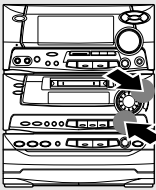

① Press the QUICK MOVE key.

② Set it.

To abort operation, press the QUICK MOVE key again.

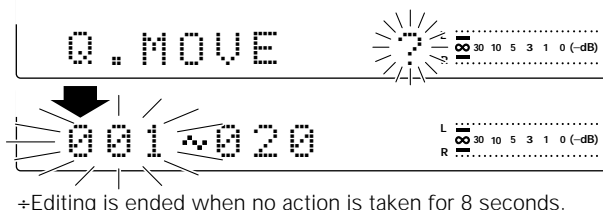

+Editing is ended when no action is taken for 8 seconds.

2 Select the range of tracks to be reordered.

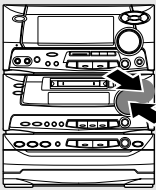

① Select the first track in the reordered range.

To decrease track No. To increase track No.

② Set the reordered range.

Selected track No.

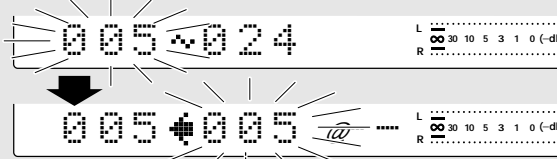

Select the first track in the 20-track range.



Track No. 20 tracks (changed range)

3 Select tracks numbers in the desired order.

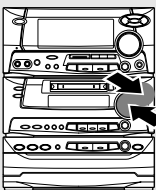

① Select a track number.

To decrease track No. To increase track No.

② Set it.

Repeat steps ① and ② until all tracks have been arranged in the desired order.

Moving the present track No. 7 to track No. 5

Target track No. Track No. to be moved Scrolling after flashing

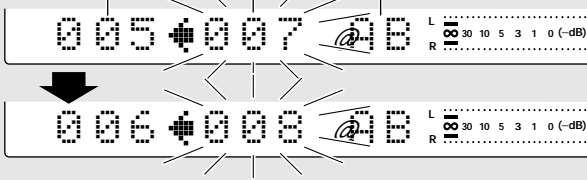

+ Pressing the **||** (Q.MOVE CLEAR) key allows to cancel the last selected track only. (To cancel other previously selected tracks, abort editing and restart from the beginning.)
 + Pressing the **●** REC (Q.MOVE CHECK) key allows to check the current order of tracks.

4 Execute the track move operation.

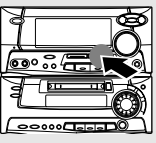
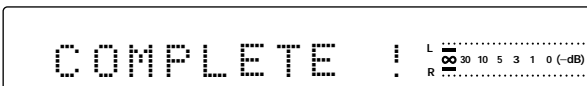
5 After editing, eject and remove the mini disc.

“WRITING” displayed during the minidisc ejection operation indicates that the data associated with recording or editing is being written on the disc. Do not apply vibration or shock to the unit while this message is displayed.

+ It takes a while until the execution completes.
 + If the **ENTER** key is pressed before reordering all tracks, the tracks which have not been selected are added to the end of the reordered range in the same order as before.
 + You can suspend track reordering by pressing the eject (**▲**) key or the **ON/STANDBY** key while “COMPLETE” is flashing.

Application section

Moving a single track (TRACK MOVE)

This procedure shows you how to select and move (insert) a track to the track number you desire. The surrounding tracks are renumbered automatically.

Repeating this procedure lets you arrange the tracks in the order you desire.

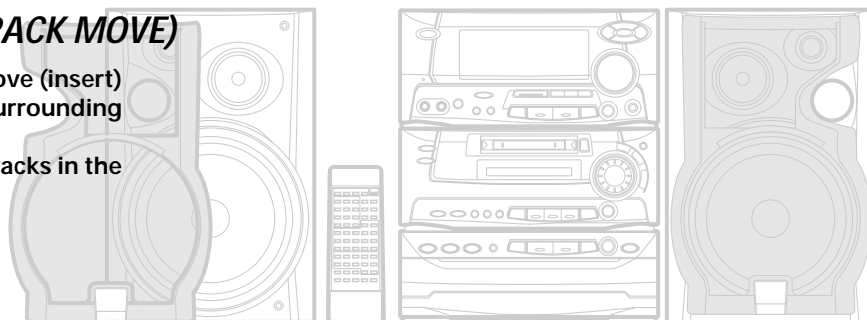

Please execute operation in stopped condition.

1 Select "MOVE".

① Select "MOVE".

② Set it.

- Each press switches the operation.
- ① MOVE ? (Moving a single track)
 - ② COMBINE ? (Combining tracks)
 - ③ ALL ERASE ? (Erasing of all tracks)
 - ④ Editing cancelled



+ Editing is aborted if no operation has been performed for 8 seconds.

2 Select the track to be moved.

① Select a track number.

To decrease track No. To increase track No.

② Set it.

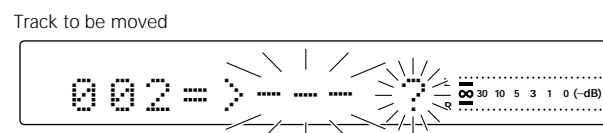

3 Select the moving destination track.

① Select a track number.

To decrease track No. To increase track No.

② Set it.

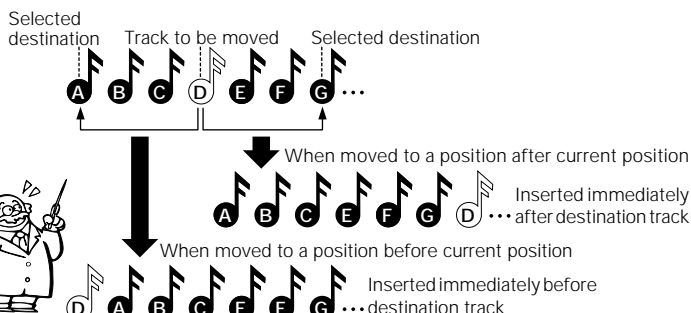
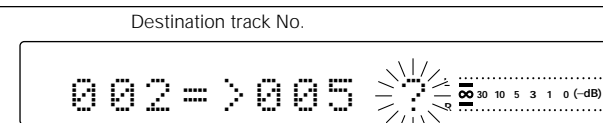

4 Execute the track move operation.

ENTER

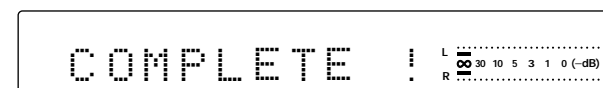

5 After editing, eject and remove the mini disc.

"WRITING" displayed during the mini disc ejection operation indicates that the data associated with recording or editing is being written on the disc. Do not apply vibration or shock to the unit while this message is displayed.

Application section

Dividing a track (TRACK DIVIDE)

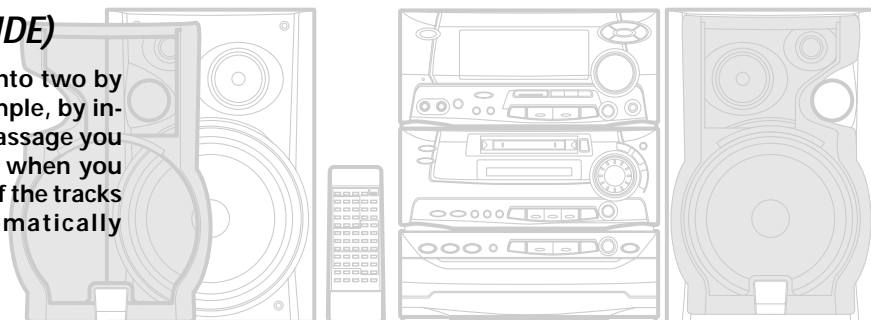

Use the following procedure to divide a track into two by inserting a track number in its middle. For example, by inserting an additional track number before the passage you are specially fond of, it is easy to skip to there when you play the disc later. Note that the track numbers of the tracks located after the divided track are automatically incremented.

1 Play the track to be divided.

+ This operation is also possible during play-pause.

2 Press the TRACK EDIT key at the desired position.

① Select "DIVIDE".

TRACK EDIT

② Set it.

SET

Each press switches the operation.

- ① DIVIDE ? (Dividing a track)
- ② COMBINE ? (Combining tracks)
- ③ ERASE ? (Erasing one track)
- ④ Editing cancelled

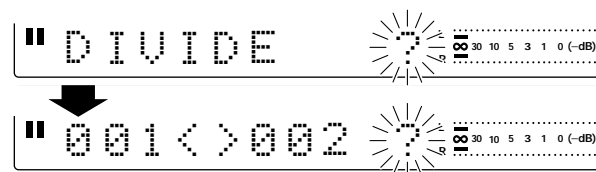

+ Editing is aborted if no operation has been performed for 8 seconds.

3 Execute the track divide operation.

ENTER

Up to 255 track numbers can be inserted additionally by repeating ① to ③ for each of them.

Should be approx. 2 sec. or longer.

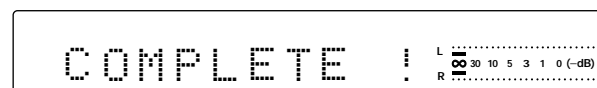
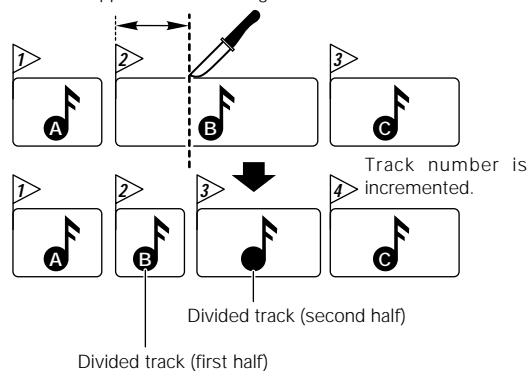

- + The track is divided into two tracks.
- + Playback starts from the track made from the second half of the divided track.
- + There is no blank space left between the two tracks.
- + When the track to be split has a title, the two tracks will have the same title.

"WRITING" displayed during the mini disc ejection operation indicates that the data associated with recording or editing is being written on the disc. Do not apply vibration or shock to the unit while this message is displayed.

Application section

Combining two tracks (TRACK COMBINE)

Use the following procedure to combine two tracks into one by deleting a track number. This operation allows to connect several tracks or a piece of music divided into several parts. After this operation, the track numbers of tracks located after the combined tracks are decreased automatically.

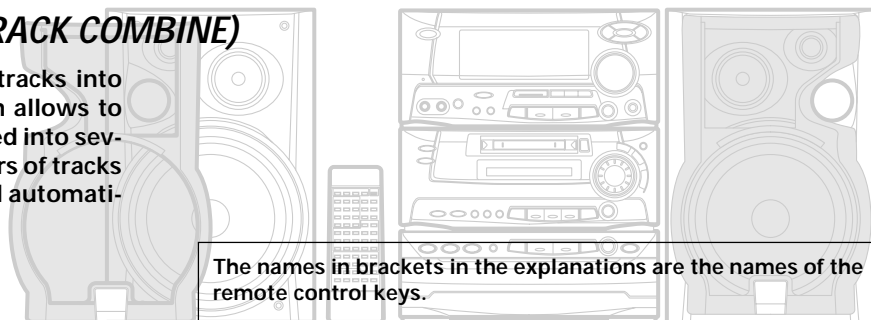

The names in brackets in the explanations are the names of the remote control keys.

1 Select "COMBINE".

① Select "COMBINE".

TRACK EDIT

② Set it.

SET

If you combine tracks during playback, go to step 2.

"COMBINE" cannot be selected if the track being played is the first track on the disc.

Each press switches the operation.

When pressed in stop mode:

- ① MOVE ? (Moving a single track)
- ② COMBINE ? (Combining tracks)
- ③ ALL ERASE ? (Erasing of all tracks)
- ④ Editing cancelled

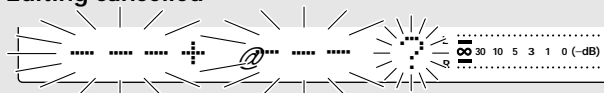

When pressed in play mode:

- ① DIVIDE ? (Dividing a track)
- ② COMBINE ? (Combining tracks)
- ③ ERASE ? (Erasing one track)
- ④ Editing cancelled



+ To combine two tracks during playback, press the **TRACK EDIT (TRACK EDIT/CHARA.)** key while the second track is being played. (The track being played and the track immediately before it will be combined.)

+ If the operation is started during playback, it pauses automatically.

+ Editing is aborted if no operation has been performed for 8 seconds.

2 Select the track to be combined.

① Select the track number.

To decrease track No. To increase track No.

② Set it.

SET

Should be approx. 2 sec. or longer.

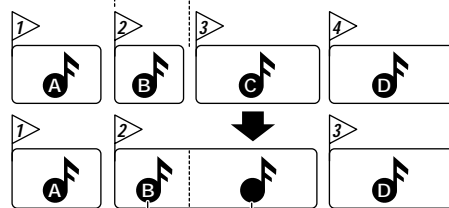

Track No. and title of the first track are left.

Track No. and title of the second track are cleared.

Connecting tracks 2 and 3.

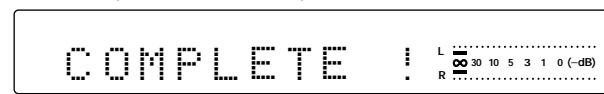

+ If editing has been started during playback, playback restarts automatically from the current track.

3 Execute the track combine operation.

② Set it.

ENTER

4 After editing, eject and remove the mini disc.

"WRITING" displayed during the mini disc ejection operation indicates that the data associated with recording or editing is being written on the disc. Do not apply vibration or shock to the unit while this message is displayed.

Erasing a single track (TRACK ERASE) or erasing all tracks on a disc (ALL ERASE)

TRACK ERASE

During playback, it is possible to erase only the track being played. The track numbers of the tracks after the erased track will be adjusted.

Be careful in using this operation because a track cannot be recovered once it has been erased.

ALL ERASE

During stop, all tracks can be erased. Be careful in using this operation because the tracks cannot be recovered once the entire minidisc has been erased.

1 Make the preparations.

To erase one track (TRACK ERASE)

① Start playback.

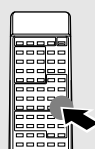

② Select the track to be erased.

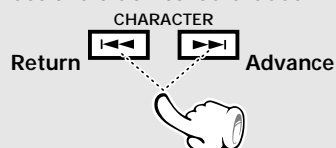

To erase all tracks (ALL ERASE)



Enter stop status.

2 Select the ERASE mode.

Select "ERASE".



Each press switches the operation.

- ① DIVIDE ? (Dividing a track)
- ② COMBINE ? (Combining tracks)
- ③ ERASE ? (Erase one track)
- ④ Editing cancelled



① Select "ALL ERASE".



Each press switches the operation.

- ① MOVE ? (Dividing a track)
- ② COMBINE ? (Combining tracks)
- ③ ALL ERASE ? (Erasing of all tracks)
- ④ Editing cancelled

② Set it.

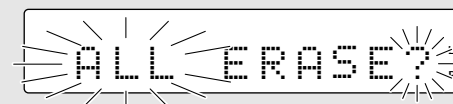

+ Editing is aborted if no operation has been performed for 8 seconds.

3 Execute the erase operation.



+ The track is erased (together with the track title).
+ If editing has been started during playback, playback restarts automatically from the track after the erased track.

+ All tracks on a disc are erased (together with the disc title).

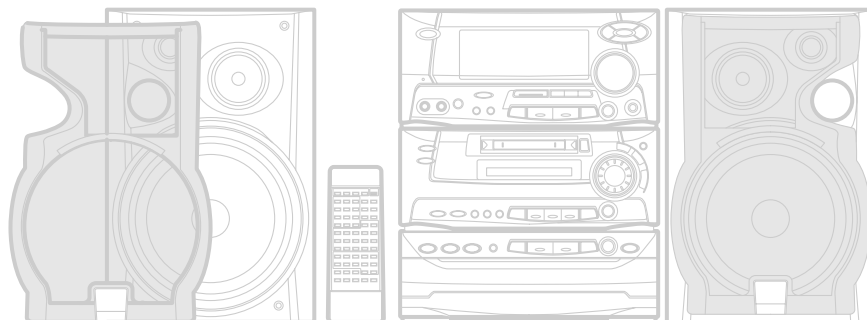

4 After editing, eject and remove the mini disc.

“WRITING” displayed during the mini disc ejection operation indicates that the data associated with recording or editing is being written on the disc. Do not apply vibration or shock to the unit while this message is displayed.

Image of erasing one track (TRACK ERASE)

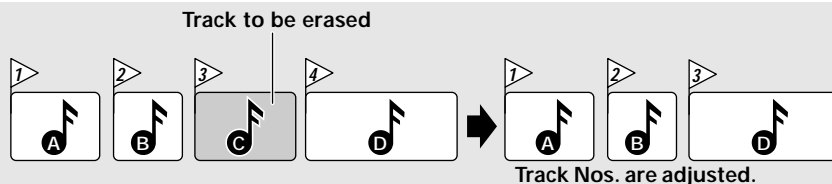

Erasing a part of a track

- ① Turn the part to be erased into one track by using the TRACK DIVIDE function.
- ② Erase it by using the TRACK ERASE function.

Use the following procedure to erase the desired part of a track.

- ① Turn the part to be erased into one track.

Use the TRACK DIVIDE function to turn the part you want to erase into one track.



- ② Erase the part to be erased.

Use the TRACK ERASE function to erase the “track” (part you want to erase) made in step ①.



- ③ After editing, eject and remove the mini disc.

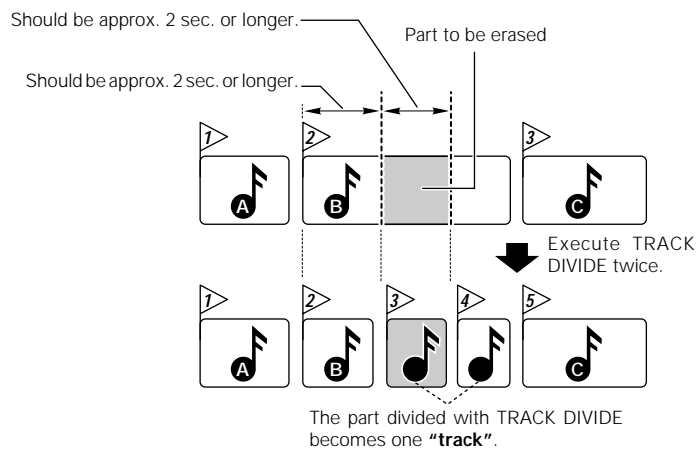

TRACK DIVIDE → 58

+ If it is required to erase only the first or second half of a track, only one TRACK DIVIDE operation is enough.

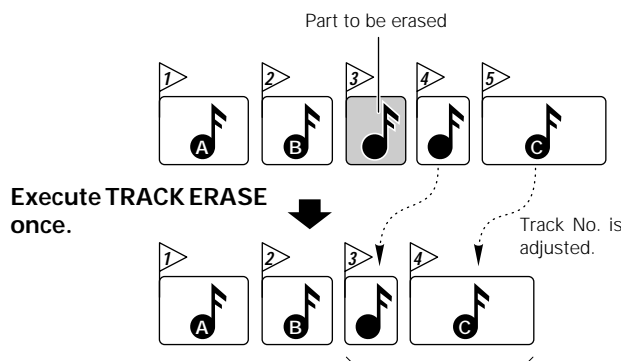

The space left after erasing is filled by subsequent tracks which move along.

TRACK ERASE → 60

“WRITING” displayed during the mini disc ejection operation indicates that the data associated with recording or editing is being written on the disc. Do not apply vibration or shock to the unit while this message is displayed.

This unit permits selection of equalizer and sound field playback. Please select the equalizer as desired according to the music genre. Select the sound field mode according to the desired atmosphere.

Adjustment of balance and input level

Balance Adjusts the balance of left and right volume.

Input level This adjusts the volume level for the external equipment (video deck etc.) connected to the AUX input terminal. Adjust as required when the volume from the external equipment is too high.

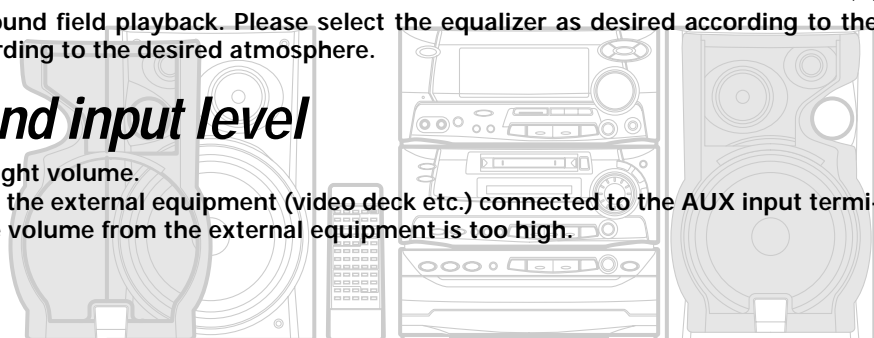

1 Select what to adjust.

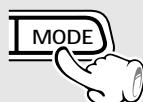
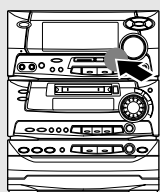

Return to volume adjustment is made when no input is made for 5 sec. or more.

Each press switches the modes as follows.

- ① Strength of the SRS 3D stereo effect (LEVEL)
- ② Left and right volume balance
- ③ MD recording level (REC)
- ④ Volume (INPUT) from the external equipment connected to the AUX terminal
- ⑤ Normal volume adjustment (VOL)

+ "REC" is displayed only when the REC INPUT is analog.

→ 28

+ "INPUT" is displayed only with AUX.

+ "LEVEL" is displayed only when SRS 3D is ON.

2 Adjust.

BALANCE adjustment

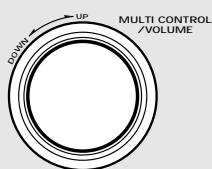

The right volume is decreased.

The left volume is decreased.

Input level adjustment

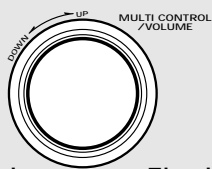
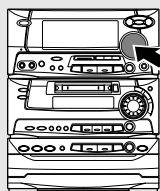

The level decreases.

The level increases.

At the time of BALANCE adjustment

Indicates the center.

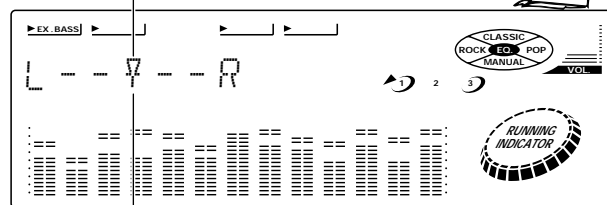

Indicates the balance setting.

At the time of input level adjustment

Set level

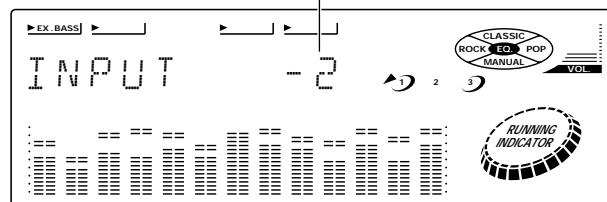

+ Adjustment is possible over the range from -12 to +3.



When the input level is adjusted, the recording level from the external equipment connected to the AUX input terminal also changes. "Recording on MD"

→ 26

In regard to equalizer adjustment (LOW, MID, HIGH)

The setting items LOW, MID, and HIGH are displayed only when the equalizer is set to MANUAL (user memory).

→ 64

Listening with the desired sound (equalizer function)

In addition to the three kinds of equalizer patterns which have been preset at the factory for use as reference, three equalizer patterns created manually by user can be stored in memory and recalled anytime.

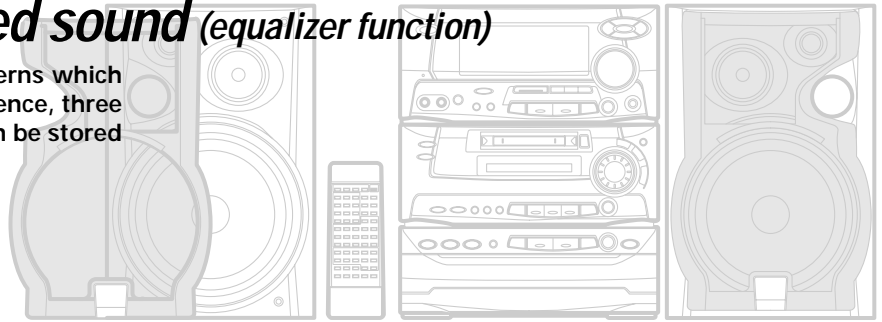

Selection of the equalizer pattern

The equalizer patterns can be selected according to the genre of music played. Recording with applied equalizer effect also is possible.

① Play the desired music.

② Select equalizer mode.

There are reference mode (R) ("MANUAL" not lit) and manual mode (M) ("MANUAL" lit).

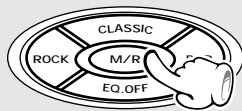
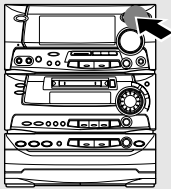

③ Select the desired equalizer pattern.

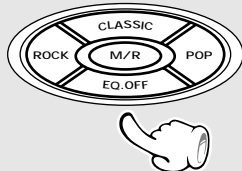
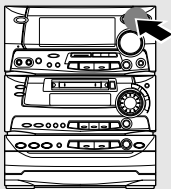

Example for reference mode



The display for the selected mode lights.

Example for manual mode



This lights at the time of manual mode.

Indication of manual 1

Called equalizer pattern

At the time of reference mode ("MANUAL" not lit)

- ROCK key Rock
- CLASSIC key Classic
- POP key Popular

At the time of manual mode ("MANUAL" lit)

- ROCK key MANUAL 1
- CLASSIC key MANUAL 2
- POP key MANUAL 3

- + Each time the EQ. key of the remote control is pressed, the equalizer pattern is switched.
- + For cancellation, press the EQ. OFF key or select "EQ. OFF" with the EQ. key of the remote control.
- + During recording, equalizer ON/OFF and equalizer mode switching can not be done.



In regard to demonstration

The equalizer and sound field effects are changed sequentially. This can be used to check the effects.



At the time of unit OFF :
The mode is switched each time the key is pressed.

- ① DEMO
- ② OFF (demonstration cancelled)

- + At the time of unit OFF, only the display is demonstrated.
- + At the time of unit ON, five types of spectrum analyzer displays can be obtained in addition to the demonstration.

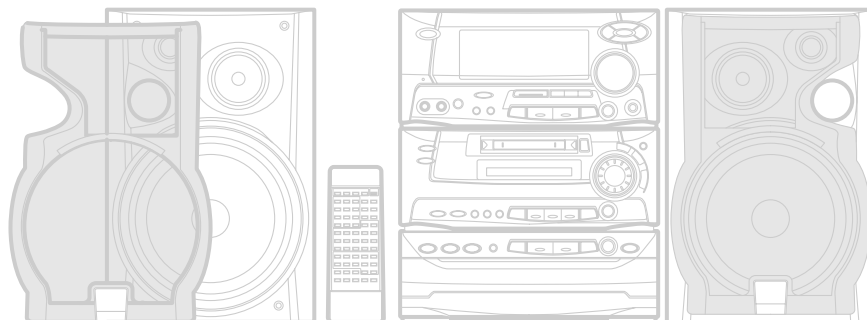

Creation and memorizing of an equalizer pattern

A desired equalizer pattern can be created and memorized.

❶ Select the number to be recorded.

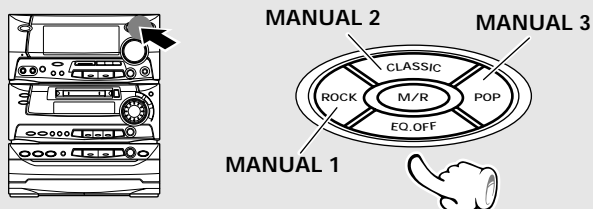

❷ Display "MANUAL" (Confirm.).

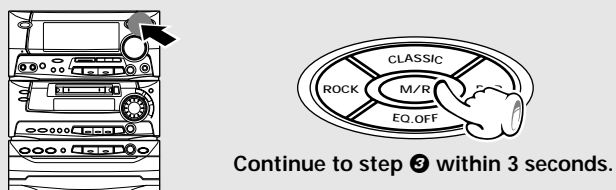

❸ Adjust the equalizer pattern.

Select the frequency band.

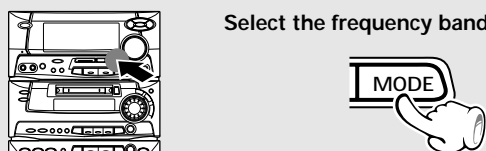

Adjust the level.

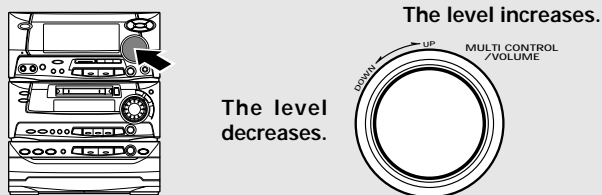

LOW, MID, and HIGH can be adjusted individually.

❹ Memorize the setting.

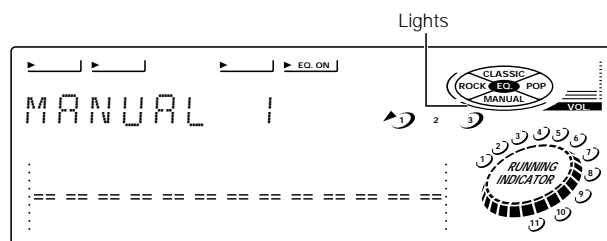
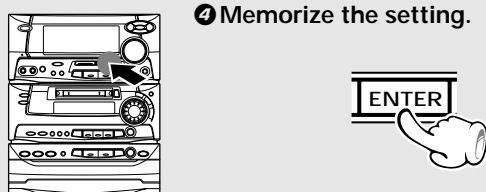

Each press switches the modes as follows.

- ❶ LOW Low range (bass, bass drum, etc.)
- ❷ MID Medium range (vocals, guitar, etc.)
- ❸ HIGH High range (cymbals etc.)

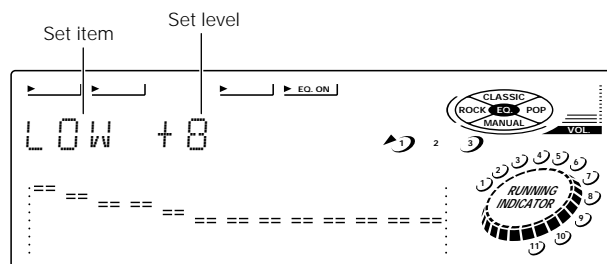

+ The individual frequency bands can be adjusted in the range from -8 to +8.

Enjoying Sound Field Effects

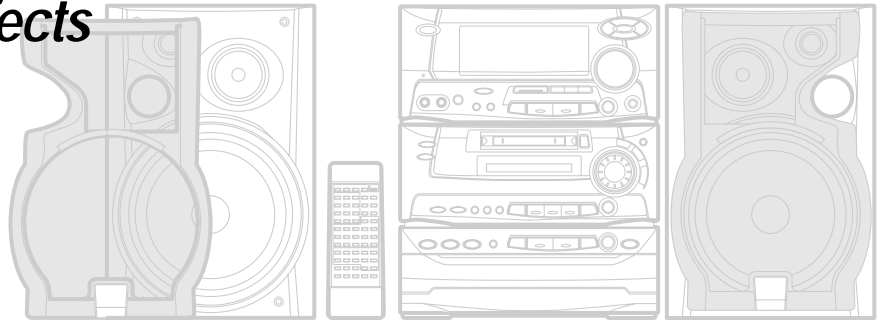

Experiencing SRS 3D Stereo (Sound Retrieval System)

The Sound Retrieval System is an epochal system which produces a three-dimensional sound space by applying the most suitable processing to the sound signal on the basis of the human listening mechanism. This permits real depth and sound location, considered as difficult to realize with conventional 2-channel stereo (general stereo). A sufficient effect can be obtained for any source (CD, MD, broadcasts, etc.). Recording with applied SRS 3D stereo also is possible.

1 Switch on SRS 3D.

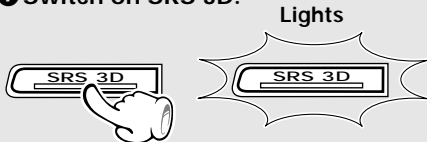
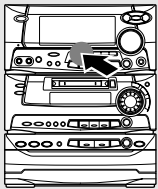

ON/OFF is switched each time the key is pressed.

2 Adjust the effect strength (level). "LEVEL" will be displayed.

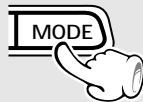
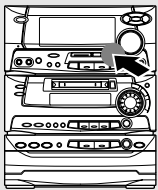

Adjust the strength of the effect.

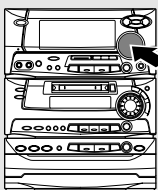

The level decreases.

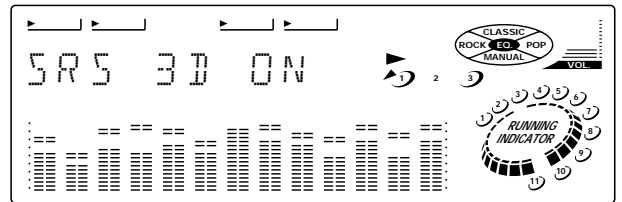
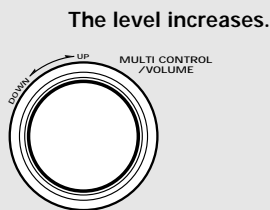

Each press switches the modes as follows.

- 1 Strength of the SRS 3D stereo effect (LEVEL)
- 2 Left and right volume balance
- 3 MD recording level (REC)
- 4 Volume (INPUT) from the external equipment connected to the AUX terminal
- 5 Normal volume adjustment (VOL)

+ "REC" is displayed only when the REC INPUT is analog.



+ "INPUT" is displayed only with AUX.

+ SRS 3D stereo ON/OFF switching is not possible during recording.

Level display

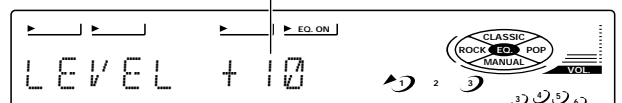

+ Adjustment is possible in the range from -10 to +10.

+ Please set as desired according to the titles being played back etc.

Enjoying Karaoke

When CDs or MDs with recorded voice and instrument music are played, it is possible to lower the volume only for the voice part. In combination with mic mixing, this permits easy enjoyment of Karaoke.

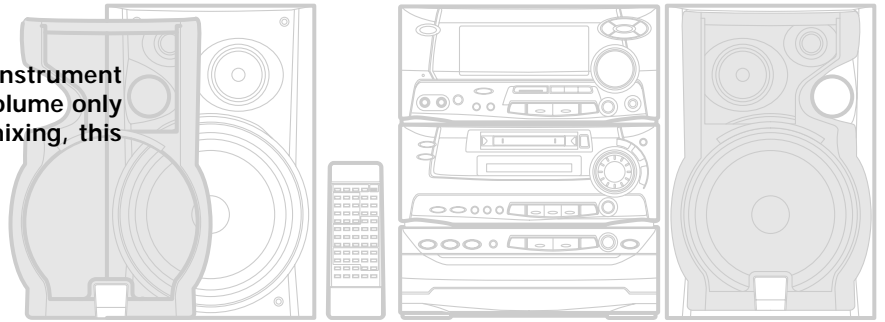

1 Connect a microphone.

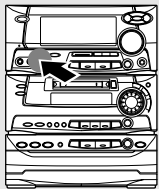

- ➊ Turn the MIC MIX. control fully counterclockwise.

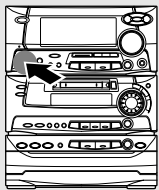

- ➋ Plug the microphone into the MIC jack.

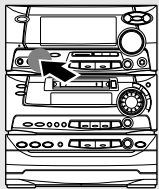

- ➌ Adjust the volume balance between the music input and microphone input.

To decrease
microphone
volume



To increase
microphone
volume



± Set the **MIC MIX.** control knob to the fully counterclockwise position when the microphone is not used.

2 Play the music.

3 Sing along with the accompaniment.

After execution of the above procedure, karaoke itself also can be recorded. (Analog recording only) However, the sound cannot be recorded for karaoke with sound from a minidisc.

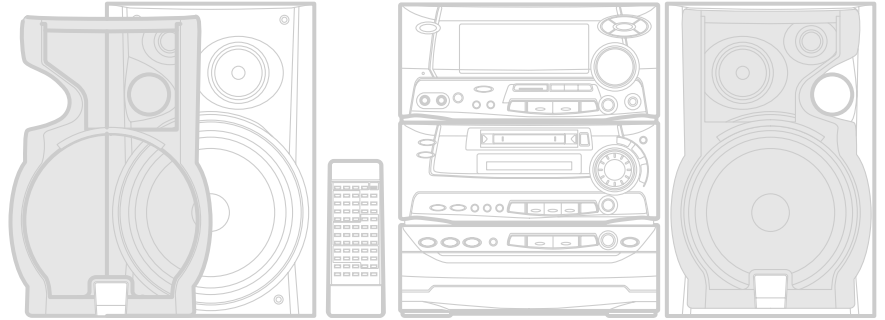

Enjoying Karaoke with software including the vocal part (HIT MASTER function)

This function makes it possible to enjoy music sources including vocal as pseudo Karaoke sources. This makes it possible to enjoy Karaoke even without special Karaoke CDs etc.

Each press switches ON and OFF alternately.

- ① HIT MASTER ON
- ② HIT MASTER OFF

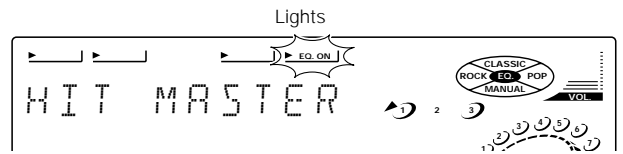
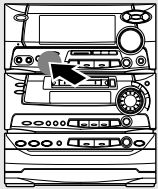

- + The volume of the vocal parts of the song decreases. However, this effect may not be clear with some songs and discs.
- + A Karaoke MD can be created by recording the performance while the **MIC MIX.** control is in the fully counterclockwise position. (Analog recording only)
- + The **HIT MASTER** function is cancelled when an equalizer effect is applied.

When the AC cord is connected to a receptacle, the clock display starts to flash. Set the correct time following the instructions.

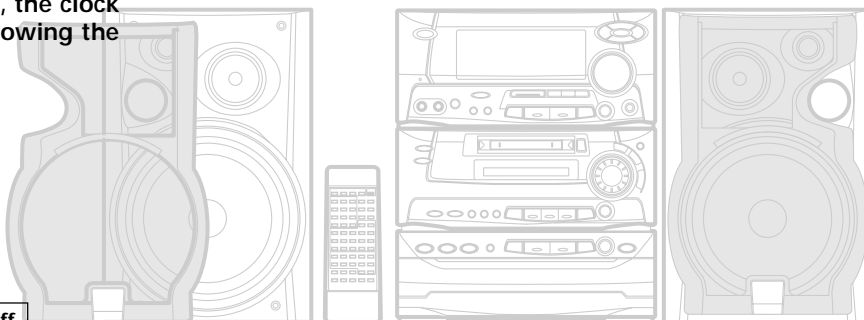

Time display is made only when the unit is switched off.

Ensure that the unit is OFF.

1 Activate the clock adjustment mode.

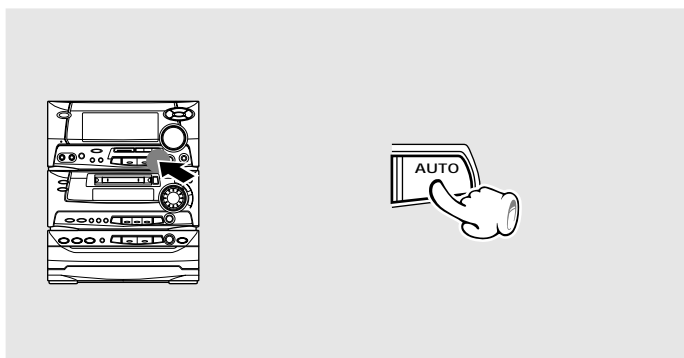

Example: Adjustment to 8:45

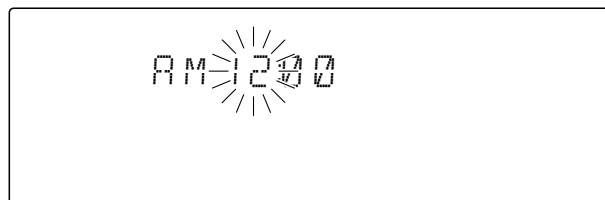

+ The time display starts to blink.

2 Enter the figure of hour.

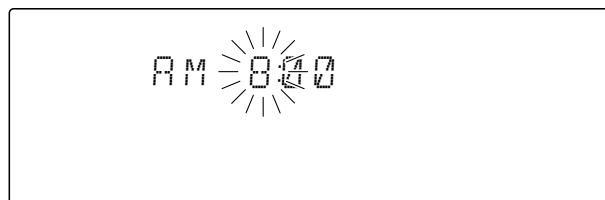
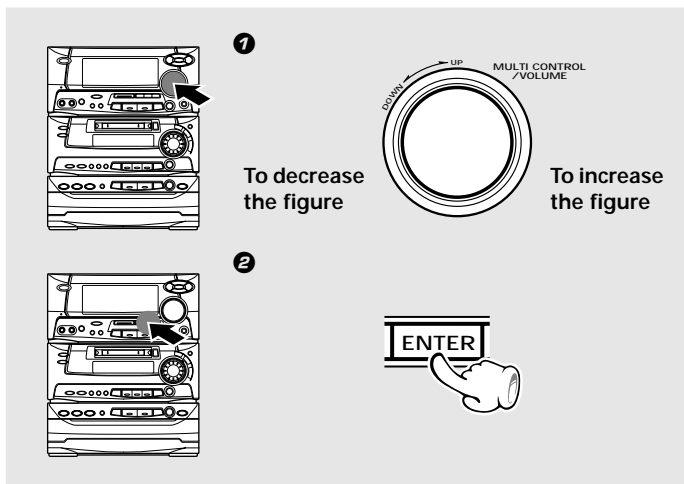

+ The time of the day is represented in 12-hour AM/PM method.
+ Press the **ENTER** key. The hour is entered and the minute display starts to blink.

3 Enter the figure of minute.

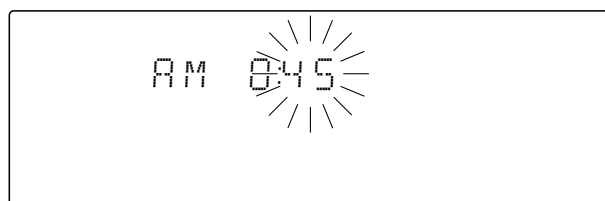
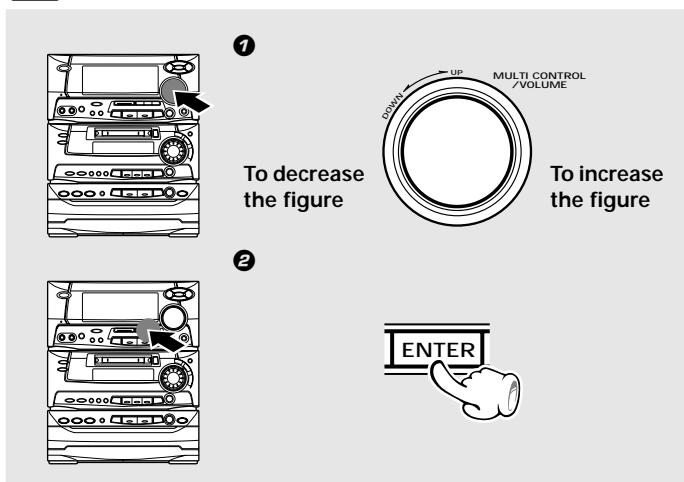

+ If you make a mistake, restart from the beginning.
+ To adjust correct time, press the **ENTER** key at the same moment as a time announcement.
+ The time display flashes when a power failure has occurred or when the power plug has been pulled and inserted again. In such a case, set the clock again.

Operate easy To use Timer (O.T.T.)

Playback of the selected input source starts at the specified time, and the unit is switched off after one hour. This timer operates only once directly after setting.

Sleep timer (SLEEP)

The unit is turned OFF automatically after the specified period has elapsed.

Timer playback, timer recording (PROG.1, PROG.2)

With each of the two timer programs, a selected source can be played (or radio broadcast can be recorded) in the previously set time period.

AI timer playback (PROG.1, PROG.2)

The volume increases gradually after start of timer playback.

The MD operates on the basis of the information read from the disk into memory.

Before timer setting with the MD, leave the unit ON for 10 min. or more to make the memory backup function effective. → 78

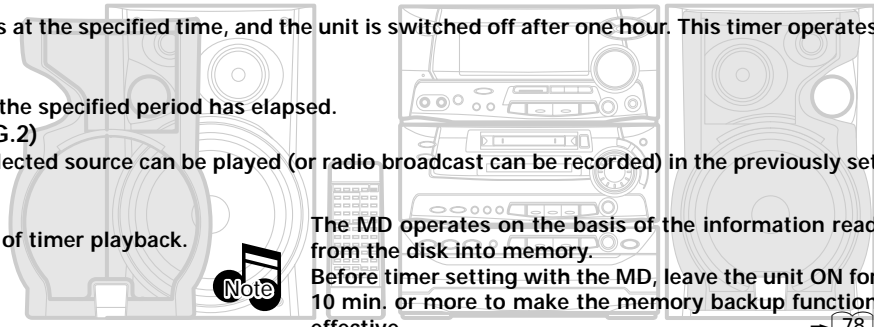

Operate easy To use Timer (O.T.T.)

Timer playback is possible simply by setting the time. The source selected last before the unit was switched off will be played. One hour after start of timer playback, the unit will be switched off automatically.



The program timer does not operate until the end of operation of the O.T.T. timer.

+ When the **MODE** key is pressed, the input source and the ON time are displayed.

➊ Select the source to be played.

➋ Switch OFF the unit supply.

➌ Press the **MODE** key.

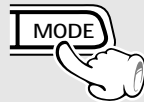
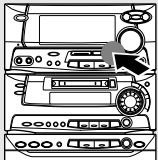

➍ Set the ON time.

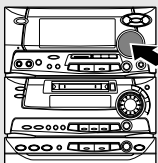

The time is returned.

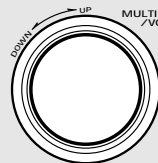

The time is advanced.

➎ Press the **ENTER** key.



Each press switches the modes as follows.

- ➊ "O.T.T." lit..... The timer is used.
- ➋ "O.T.T." not lit.... The timer is not used.

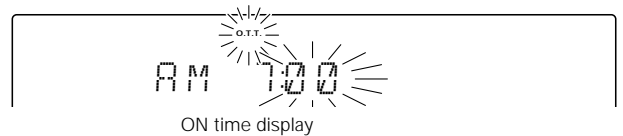

ON time display

+ The ON time can be set in steps of 5 minutes.

To cancel

Press the **MODE** key twice while the unit is OFF.

Sleep timer

Set the number of minutes after which the unit is to be turned OFF.

➊ Turn the unit ON.

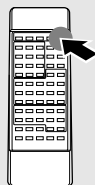

➋ Set the time.

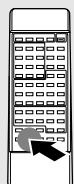

+ The unit is turned OFF automatically after the set time has elapsed.

+ Each press decreases the time by 10 minutes. The maximum time that can be set is 90 minutes.

90→80→70...30→20→10→Cancel→90→80...

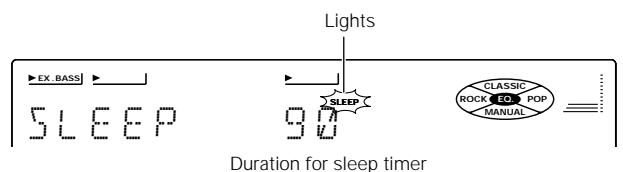

Duration for sleep timer

To cancel

Turn the unit OFF or press the **SLEEP** key until the sleep time is cancelled.

Timer programming

Two 24-hour timer systems (PROG.1, PROG.2) (which can be used every day) are available.

In each of PROG.1 and PROG.2, the timer data including the operating period and played contents can be set and selected to be activated or not as required.

For tape timer operation, please read the operation manual of the cassette deck (option) carefully.

- +Timer reservation is possible for the two types PROG.1 and PROG. 2 at the same time.
- + Please make reservations with an interval of at least one minute, so that the operation times of PROG. 1 and PROG. 2 do not overlap.



The MD operates on the basis of the information read from the disk into memory.

Before timer setting with the MD, leave the power ON for 10 min. or more to make the memory backup function effective.

→ 78

Connect the related equipment under reference to "System connection".

→ 6

1 Make preparations for the play (recording).

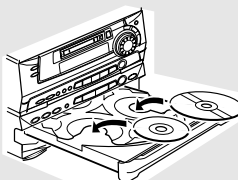
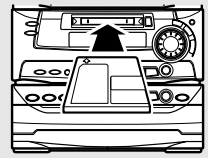
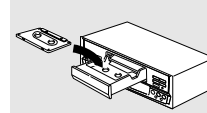
To listen to radio	To listen to CD	Playing the auxiliary input source	To listen to MD	To listen to tape	For recording
The station should be pre-set prior to the above. ∞	Insert a disc. (Program playback is not possible.)  Select the disc (1, 2, 3) to be played.	Make timer setting of the component connected to the AUX or VIDEO jacks.	Load a disc. 	Set a tape into. Cassette deck (option) 	Make preparations for recording. Cassette deck (option) MD → 26

2 Adjust the listening volume.

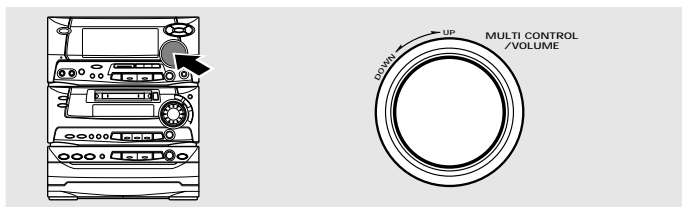

+For recording of broadcasts, the minimum volume is set automatically when the unit is switched on by the timer.

3 Set the ON/STANDBY key to STANDBY position.



4 Select a program No.

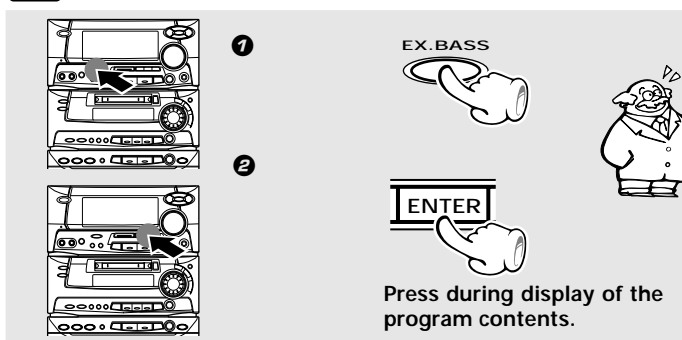

Each press of the key switches the program numbers as follows.

- ① PROG.1..... Program 1
- ② PROG.2..... Program 2
- ③ Normal operation

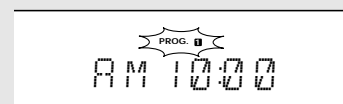

- + The selected program No. lights.
- + If a program No. under which a timer program has already been reserved, it is replaced by the new timer program.

Application section

5 Enter the ON time.

1 The time is returned. **2** The time is advanced.

↑ DOWN MULTI CONTROL / VOLUME

ENTER

+ After entering the figure of "hour" with the procedure in **1** and **2**, enter the figure of "minute" using the same procedure.

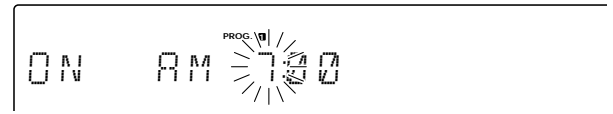

+ If you make a mistake, restart from step **4**.

6 Enter the OFF time.

1 The time is returned. **2** The time is advanced.

↑ DOWN MULTI CONTROL / VOLUME

ENTER

+ After entering the figure of "hour" with the procedure in **1** and **2**, enter the figure of "minute" using the same procedure.

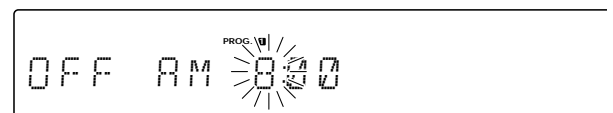

+ If you make a mistake, restart from step **4**.

7 Make the desired reservation.

For timer playback or AI timer playback

1 Select the mode.

↑ DOWN MULTI CONTROL / VOLUME

(1) Select "PLAY" or "AI".

- ① **PLAY** Timer play
- ② **REC**
- ③ **AI** Timer play with gradually increasing volume

ENTER

(2) Enter it.

2 Select the input source.

↑ DOWN MULTI CONTROL / VOLUME

(1) Select the source to be played.

- ① **TUNER** Broadcasts
- ② **CD** CD
- ③ **MD** MD
- ④ **AUX** External input (tape etc.)

ENTER

(2) Enter it.

3 Select the broadcast station (only when TUNER is selected above).

↑ DOWN MULTI CONTROL / VOLUME

(1) Select the preset station No.

ENTER

(2) Enter it.

+ The station to be received with timer must be preset beforehand.

Timer recording of radio broadcasts

1 Select the mode.

↑ DOWN MULTI CONTROL / VOLUME

(1) Select "REC".

- ① **PLAY**
- ② **REC**
- ③ **AI**

ENTER

(2) Enter it.

2 Select the input source.

↑ DOWN MULTI CONTROL / VOLUME

(1) Select the preset station No.

ENTER

(2) Enter it.

3 Select the recording equipment.

↑ DOWN MULTI CONTROL / VOLUME

(1) Select.

- ① **MD**
- ② **AUX** (optional cassette deck only)

ENTER

(2) Enter it.

8 Select the timer program No. to be used.

SRS 3D

Each press of the key switches the program numbers as follows.

- ① **PROG.1** Execution of program 1 only.
- ② **PROG.2** Execution of program 2 only.
- ③ **PROG.1, 2** Execution of programs 1 and 2.
- ④ **Timer OFF**

+ The selected program No. lights.
+ The timer will not function unless a program No. is selected.

Ensure that the unit is OFF.



The reservation contents cannot be cleared. The contents are cleared only when they are changed.

Check the reservation content.

Select the program number to be checked.

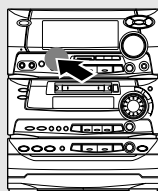

EX. BASS



Each press of the key switches the program numbers as follows.

- ① PROG.1..... Display of program 1
- ② PROG.2..... Display of program 2
- ③ Normal mode

+ The reserved contents will be displayed for 3 seconds per item. After this, the previous display content appears again.

To change the reserved contents

Restart the procedure of "Timer programming" from the beginning.

When timer operation is not required

Press so that all PROG. indicators are OFF.

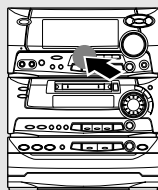

SRS 3D



Each press of the key switches the program numbers as follows.

- ① PROG.1..... Program 1 operates.
- ② PROG.2..... Program 2 operates.
- ③ PROG.1, 2... Programs 1 and 2 operate.
- ④ Not lit..... No program operates.

To set the same timer program again

Press so that the desired PROG. indicators lights.

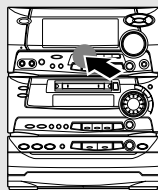

SRS 3D



Each press of the key switches the program numbers as follows.

- ① PROG.1..... Program 1 operates.
- ② PROG.2..... Program 2 operates.
- ③ PROG.1, 2... Programs 1 and 2 operate.
- ④ Not lit..... No program operates.

+ The reservation contents are held in memory.

+ Also prepare the disc or MD and adjust the listening volume.

Maintenance

Maintenance of the Set

When the front panel, the case, etc. becomes dirty, wipe with a soft, dry cloth. Do not use thinner, alcohol, etc., as these can cause discoloration.

In regard to contact cleaners

Do not use contact cleaners because it could cause a malfunction. Be specially careful not to use contact cleaners containing oil, for they may deform the plastic component.

Reference

Beware of condensation

When water vapor comes into contact with the surface of a cold material, condensation is produced. If condensation occurs, correct operation may not be possible, or the unit may not function correctly. This is not a malfunction, however, and the unit should be dried-out. (To do this, turn the ON/STANDBY key ON and leave the unit as it is for several hours.)

Be especially careful in the following conditions:

- +When the unit is brought from a cold place to a warm place, and there is a large temperature difference.
- +When a heater starts operating.
- +When the unit is brought from an air-conditioned place to a place of high temperature with high humidity.
- +When there is a large difference between the internal temperature of the unit and the ambient temperature, or in conditions where condensation occurs easily.

Memory backup function

Stored contents which are cleared immediately when power plug is unplugged from power outlet	Clock display
Stored contents which are cleared in at least a day after power plug is unplugged from power outlet	Amplifier section ON/STANDBY status (ON or STANDBY) Input selection Volume control value Balance setting Equalizer user memory SRS 3D level Tuner section Receiving band Frequency Preset stations Program settings
Memory contents which are lost after at least one day with power OFF or the power plug pulled from the outlet.	MD recorder section → 78

Sound Retrieval System manufactured under licence from SRS Labs, Inc. "SOUND RETRIEVAL SYSTEM" and the SRS Symbol (●) are trademarks of SRS Labs, Inc. Purchase of this product does not convey the right to sell recordings made with the SOUND RETRIEVAL SYSTEM.

Note related to transportation and movement

Before transporting or moving this unit, carry out the following operations.

1. Press the ▲ key and remove all CDs and MDs.
2. Verify that the display shown appears.

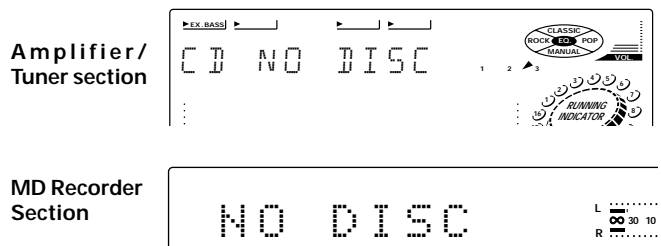

3. Wait a few seconds and turn the unit OFF.

WARNING NOTICE:

IN MOST CASES IT IS AN INFRINGEMENT OF COPYRIGHT TO MAKE COPIES OF TAPES OR DISCS WITHOUT THE PERMISSION OF THE COPYRIGHT OWNERS. ANYONE WISHING TO COPY COMMERCIALLY AVAILABLE TAPES OR DISC SHOULD CONTACT THE MECHANICAL COPYRIGHT PROTECTION SOCIETY LIMITED OR THE PERFORMING RIGHTS SOCIETY LIMITED.

MD system

The Mini Disc system has the features as summarized in the following.

- ① Like CD (Compact Disc), playback can be started from any position. (Random access)
- ② It uses a disc with a diameter of 64 mm that is accommodated in a cartridge.
- ③ Two types of discs can be used.
- ④ Up to 74 minutes of recording or playback is possible using high-efficiency coding technology.
- ⑤ Countermeasure against vibration is taken using semiconductor memory chip.

Two Mini Disc types

There are two types of Mini Disc, the one designed exclusively for playback and the other which is both recordable and playable.

Playback-only Mini Disc

This type of MD can be used only for playback, and is used by the commercially-available music MD software packages. The playback-only MD is an optical disc like the Compact Disc (CD). The signals are recorded as the presence or absence of small pits and read out by an optical, non-contact pickup.

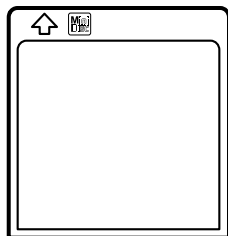

Recordable Mini Disc

This MD is a magneto-optical disc which can be recorded by magnetic field modulation. To record signals, laser light is irradiated from the bottom side of the magneto-optical disc and magnetic field is applied from the upper side of it.

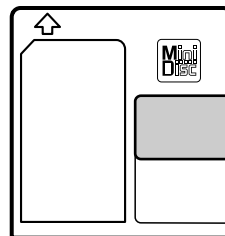

High-efficiency coding technology "ATRAC"

The Mini Disc has only a half the size of the Compact Disc but provides the same recording time. This is made possible by ATRAC*, a newly developed high-efficiency coding technology.

* ATRAC: Adaptive TRansform Acoustic Coding

The ATRAC compresses the music data to about 1/5 the amount of data which would be obtained with conventional technology, by cutting off the sound components which do not pose problem in audition even when they are not present. This has made it possible to record or play up to 74 minutes.

Sound does not affect the sensitivity of ears

Lowest and highest frequencies are not audible unless the sound has a certain level of volume.

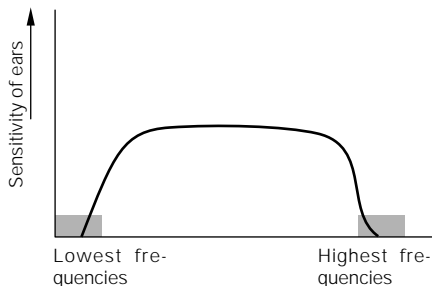

Small sound near large sound

A small sound is not audible to human ears if it is produced at the same time as a large sound. (Masking effect)



Sound-skip prevention memory

During playback, this unit always stores signals in memory temporarily to prevent sound from being skipped in case of vibration. As a result, even when the data from the optical pickup is interrupted due to vibration, etc., the music will not be interrupted because the memory holds the data for several seconds.

During normal playback

The sound data for several seconds is always stored during playback.

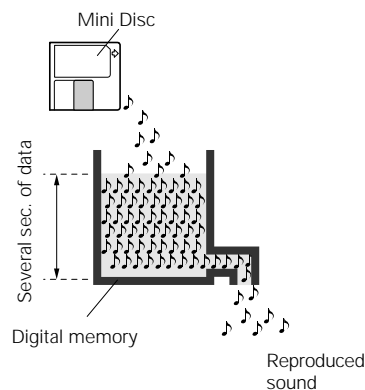

In case of vibration

Even when the read-out from disc is interrupted momentarily due to vibration or shock, the reproduced sound from the memory will not be interrupted.

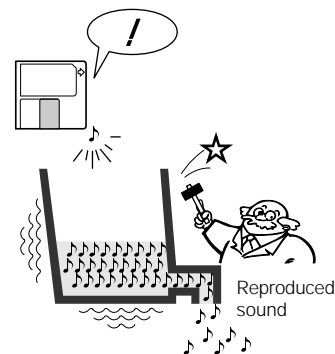

Digital recording and SCMS

The Mini Disc cannot record digital input signals from all sources. Note that digital recording is not possible with the following case.

In case the source contains the copy prohibit code (SCMS – Serial Copy Management System).

— “SCMS” is displayed and the unit enters the record-pause mode.

SCMS (Serial Copy Management System)

Designed for copyright protection, the SCMS is a prescription that copying of digital signals as they are in the digital form between digital audio equipment is allowable only for one generation.

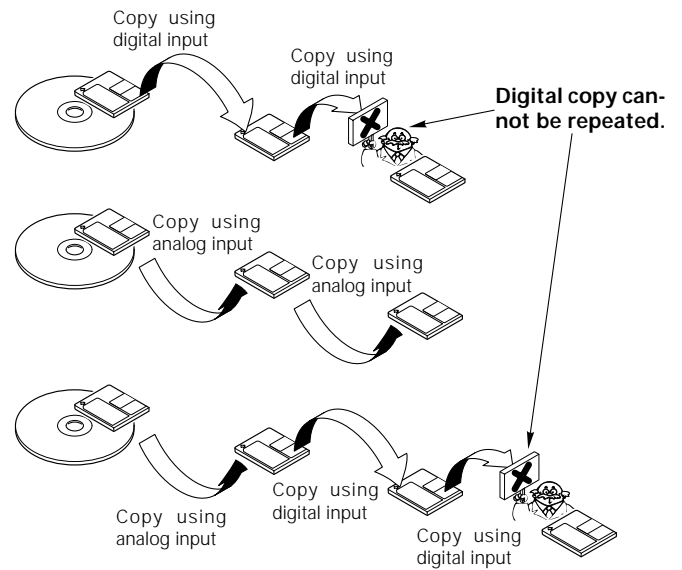

US and foreign patents licensed from Dolby Laboratories Licensing Corporation.

Operation to reset

The microcomputer may fall into malfunction (impossibility to operate, erroneous display, etc.) when the power cord is unplugged while unit is ON or due to an external factor. In this case, execute the following procedure to reset the microcomputer and return it to normal condition.

+ Please note that resetting the microcomputer clears the contents stored in and it returns to condition when it left the factory.

Use a pointed object to reset.

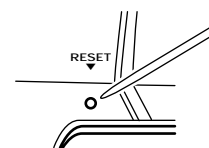
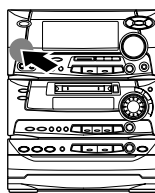

Amplifier section/Speakers

Symptom	Cause	Remedy
Sound is not produced.	<ul style="list-style-type: none"> + The speaker cords are disconnected. + The volume control is set to the minimum position. + The MUTE key of remote control unit is switched ON. + The headphone plug is inserted into the jack. + The system connection cord is disconnected. 	<ul style="list-style-type: none"> + Connect properly referring to "System connections". → 6 + Adjust to an required volume. → 16 + Switch MUTE OFF. + Unplug the headphone plug. + Check the connection of the system connection cord. → 8
"PROTECT" is displayed and no sound is put out.	<ul style="list-style-type: none"> + The speaker cords are short-circuited. 	<ul style="list-style-type: none"> + Turn the unit OFF, remove the short-circuit and turn the unit ON again.
No sound from the headphones.	<ul style="list-style-type: none"> + Imperfect insertion. 	<ul style="list-style-type: none"> + Insert correctly. → 17
Sound is not produced from the left or right speakers.	<ul style="list-style-type: none"> + The speaker cords are disconnected. + The BALANCE is set completely to the left or right channel. 	<ul style="list-style-type: none"> + Connect properly referring to "System connection". → 8 + Adjust the optimum left and right balance. → 62





Tuner section

Symptom	Cause	Remedy
The clock display blinks without changing the figures.	<ul style="list-style-type: none"> + There was a power failure. + The power cord was unplugged from the outlet. 	<ul style="list-style-type: none"> + Adjust the present time again. → 68 + Adjust the present time again.
Timer operation is not possible.	<ul style="list-style-type: none"> + The present time has not been adjusted or there was a power failure. + The timer ON time and OFF time have not been set. + The timer execution was not set up. 	<ul style="list-style-type: none"> + Adjust the present time referring to "Clock adjustment". + Set the timer ON time and OFF time. II + Press the SRS 3D key to set up the execution.
Radio stations cannot be received.	<ul style="list-style-type: none"> + The antennas have not been connected. + A proper broadcasting band has not been selected. + The frequency of the station to be received is not tuned. 	<ul style="list-style-type: none"> + Connect antennas. → 6 + Select a band. → 24 + Tune to the frequency of the desired station.
Noise interferes.	<ul style="list-style-type: none"> + Car ignition noise. + Influence of an electric appliance. + A TV set is installed near the system. 	<ul style="list-style-type: none"> + Install the outdoor antenna in an apart position from the road. + Switch the suspected electric appliance OFF. + Install the TV or the system at an increased distance between them.
A station has been preset but it cannot be received by pressing the P.CALL key.	<ul style="list-style-type: none"> + The frequency of the preset station is not tunable. + The preset memory has been cleared because the power cord has been unplugged for a long period. 	<ul style="list-style-type: none"> + Preset stations with tunable frequencies. + Preset stations again. ∞





Symptoms related to MD standard

Symptom	Cause
"DISC FULL" is displayed while the disc still has a remaining recordable time.	+ More than 255 tracks (track No. 256 or more) cannot be recorded. (There may be also cases in which recording is impossible while the track number is less than 256.) In such a case, the REMAIN time display shows "0:00".
The possible recording time does not increase even when a short track is erased.	+ When the remaining time of the entire disc is less than 12 sec, the remaining time indication on the display becomes "0:00". When the total time of the deleted tracks exceeds 12 sec, the display changes to the recordable time. + When a short track is deleted on a repeatedly edited disc, the remaining time may not increase.
Tracks can not be connected.	+ Connection of the track resulting from edit processing may not be possible.
The time which has been recorded on the MD and the remaining time do not add up to the maximum recording time (60 or 74 min.).	+ As recording is executed with 2 sec. as the minimum unit, the display time may not coincide.
When search is performed in a track which has been compiled by editing, the sound is sometimes interrupted.	+ This derives from the restriction in the MD system standard and not a malfunction.
The track numbers are not assigned correctly.	+ Depending on the contents of the recorded source (CD etc.), the track numbers may not be assigned correctly. + The track number may be increased in case of dirt or scratches on the CD.
"READING" is displayed for an abnormally long time.	+ When a new recordable MD (with nothing recorded) is inserted, "READING" is displayed longer than usual.
The time display becomes inaccurate with a monaurally recorded disc.	+ Monaural recording and stereo recording are executed according to different formats. This is not a malfunction.
Input of 1792 title characters is not possible.	+ The title recording area is used in units of 7 characters, so that input of 1792 characters may not be possible.

MD recorder section (other symptoms)

Symptom	Cause	Remedy
Sound is not output even when the play key is pressed.	+ The cords are connected erroneously. + No disc has been loaded. + A non-recorded disc has been loaded.	+ Connect the cords in accordance with "System connections" . →  + Load a disc. + Load a prerecorded disc or playback-only disc.
Recording is not possible	+ The disc is write-protected. + An attempt is made to record digital signal from a source while its digital copy has been prohibited by SCMS. + The recording level is too low. + A playback-only disc has been loaded. + The disc does not have a recordable area. + The input selector is set to MD.	+ Change the position of the write protect tab to the write position or use a recordable disc. →  + Recording is not possible. →  + Readjust the recording level. + Use a recordable disc. + Use another disc. + Set the input selector to the source to be recorded. → 
Sound is distorted.	+ The recording level has not been adjusted. + A disc in which distorted sound has been recorded is played.	+ Read "Recording on MD (Analog Recording)" + Record again.
Noise is noticeable.	+ An external noise is induced.	+ Install the unit at a position apart from an electric appliance or TV set.
The recorded volume changes during the recording.	+ The MULTI CONTROL/VOLUME knob or the MIC MIX. knob has been moved during analog recording.	+ Do not move the knobs during recording.
The display goes out for a moment after the unit has been turned ON.	+ Switching is operated too quickly.	+ This is not a malfunction.

MD recorder section (Displayed messages and actions to be taken against them)

Displayed Message	Meaning	Action
NO DISC	÷ No disc is placed on the tray.	÷ Load a disc.
001 SCMS	÷ An attempt is made to record digital signal from a source while its digital copy has been prohibited by SCMS.	÷ Switch to analog recording. →  26
DISC FULL	÷ There is no recordable area on the disc. ÷ An attempt is made to record a 256th track.	÷ Use another recordable disc. ÷ More than 256 tracks cannot be recorded per disc.
TITLE FULL	÷ An attempt is made to assign a title with more characters than usable.	÷ Refer to "Total number of title characters". →  55
BLANK DISC	÷ The disc does not contain any recordings.	÷ When playback is required, use a recorded disc.
NO TRACKS	÷ The disc does not contain any tracks but has a disc title.	÷ The disc can be used for recording without any problem.
READING	÷ The TOC ^{*1} data of the disc is being read.	÷ This is a normal operation.
WRITING	÷ The data related to editing or recording is being written in the disc.	÷ This is a normal operation.
DISC ERROR	÷ The contents of UTOC ^{*2} are abnormal.	÷ Perform " ALL ERASE " operation. If this is not possible, use another disc. →  60
CAN'T EDIT	÷ An attempt is made to perform editing beyond the restrictions, for example to erase a track which is too short.	÷ Perform editing following the restrictions.
ok?(blinking)	÷ This is a message for confirming if editing can really be executed.	÷ Press the ENTER key to execute editing.
PROTECTED	÷ The minidisc is write-protected.	÷ Cancel the write protection. →  5
PLAY ONLY	÷ The minidisc is only for playback.	÷ Insert a minidisc for recording. →  74
UNIT ERROR	÷ This indicates some trouble.	÷ Return to normal condition is made by switching the unit off and then on again.



*1 All minidiscs contain a Table of Contents (TOC) in addition to sound signals. The TOC is similar to the table of contents in a book and contains information, such as track numbers, track length, and character information, that cannot be rewritten.

*2 In addition to the TOC, minidiscs also contain a special User's Table of Contents (UTOC) that contains track number, track length, and character information, that can be rewritten.

Memory Backup for the MD Recorder Section

The memory contents are held for approximately one day with the power plug pulled from the receptacle. In case of long power failures or long times with the plug pulled from the receptacle, the information in regard to recording or editing (recorded when the minidisc is removed) may be erased or destroyed before recording on the minidisc. Once the information has disappeared, it can not be recovered. After recording or editing, always remove the minidisc to record the recording or editing information.



CD player section

Symptom	Cause	Remedy
A CD is placed in the player but it cannot be played.	<ul style="list-style-type: none"> ÷ The disc is placed upside down. ÷ The disc position is displaced. ÷ The disc is extremely dirty. ÷ The disc is scratched. ÷ Dew is condensed on the optics lens. 	<ul style="list-style-type: none"> ÷ Place the disc properly, with the label side facing upward. ÷ Place the disc properly. ÷ Clean the disc referring to "Disc handling precautions". →  ÷ Try another disc. ÷ Refer to "Beware of condensation" and remove the condensation by evaporation. → 
Sound is not produced.	<ul style="list-style-type: none"> ÷ The disc has not been placed. ÷ The player is not put to the play mode. ÷ The disc is extremely dirty. ÷ The disc is scratched. 	<ul style="list-style-type: none"> ÷ Place a disc in the CD player. ÷ Press the ►/ key. ÷ Clean the disc referring to "Disc handling precautions". →  ÷ Try another disc.
Sound skips.	<ul style="list-style-type: none"> ÷ The disc is dirty. ÷ The disc is scratched. ÷ The player is subject to vibration. 	<ul style="list-style-type: none"> ÷ Clean the disc referring to "Disc handling precautions". →  ÷ Try another disc. ÷ Install the unit in a place not subject to vibrations. → 

CD player section (in regard to message display)

Displayed Message	Meaning	Action
Err** (** indicates a number)	÷ This indicates some trouble. The number differs according to the trouble contents.	÷ Return to normal condition is made by switching the unit off and then on again.

Remote control unit

Symptom	Cause	Remedy
Remote control operation is not possible.	<ul style="list-style-type: none"> ÷ Batteries are exhausted. ÷ The remote control is too far away from the system, the controlling angle is deviated or there is an obstacle in between. ÷ There is no CD or MD set in the component to be played. 	<ul style="list-style-type: none"> ÷ Replace with new batteries. →  ÷ Operate the unit inside the remote control-able range. →  ÷ Set a CD or MD in the component to be played.

Main unit (RXD-980MD)

[Amplifier section]

Rated power output
STEREO MODE

50 watts per channel minimum RMS, both channels driven, at 6 Ω,
1 kHz with no more than 10 % total harmonic distortion.

(DIN) 1 kHz at 6 Ω, 0.7 % T.H.D. 40 W + 40 W
Signal to noise ratio
AUX 85 dB
Input sensitivity / impedance
AUX 200 mV / 30 kΩ
MIC 1, 2 3.0 mV / 22 kΩ
Output level / impedance
AUX 1.2 V / 3.3 kΩ (1kHz, 0 dB)

[Tuner section]

FM tuner section

Tuning frequency range 87.5 MHz ~ 108 MHz

MW (AM) tuner section

Tuning frequency range 531 kHz ~ 1,602 kHz

LW tuner section

Tuning frequency range 153 kHz ~ 279 kHz

[MD recorder section]

System Minidisc digital audio system
Recording method Field modulation overwrite method
Playing rotation Approx. 400 rpm ~ 900 rpm (CLV)
Wow & flutter Less than unmeasurable limit

[CD player section]

Laser Semiconductor laser
Playing rotation Approx. 200 rpm ~ 500 rpm (CLV)
Wow & flutter Less than unmeasurable limit

[General]

Power consumption 120 W
Dimensions W : 270 mm
 H : 330 mm
 D : 357 mm
Weight (net) 9.1 kg (20 lb)

Speakers (LS-N750)

Enclosure Bass-reflex type, magnetically shielded
Speaker configuration
Woofer 180 mm, cone type
Tweeter 65 mm, cone type
Super-tweeter 25 mm, dome type
Impedance 6 Ω
Maximum input level 100 W
Dimensions W : 220 mm
 H : 330 mm
 D : 316 mm
Weight (net) 4.1 kg (9.0 lb)



Notes

KENWOOD follows a policy of continuous advancements in development. For this reason specifications may be changed without notice.

÷ Sufficient performance may not be exhibited at extremely cold locations (where water freezes).

KENWOOD

For your records

Record the serial number, found on the back of the unit, in the spaces designated on the warranty card, and in the space provided below. Refer to the model and serial numbers whenever you call upon your dealer for information or service on this product.

Model _____ Serial Number _____

Free Manuals Download Website

<http://myh66.com>

<http://usermanuals.us>

<http://www.somanuals.com>

<http://www.4manuals.cc>

<http://www.manual-lib.com>

<http://www.404manual.com>

<http://www.luxmanual.com>

<http://aubethermostatmanual.com>

Golf course search by state

<http://golfingnear.com>

Email search by domain

<http://emailbydomain.com>

Auto manuals search

<http://auto.somanuals.com>

TV manuals search

<http://tv.somanuals.com>