A large, stylized, light gray letter 'M' is centered on a black background. The 'M' is composed of thick, solid lines. The words 'user guide' are written in a white, lowercase, sans-serif font, following the diagonal slope of the right-hand vertical stroke of the 'M'.

user guide

Meridian 562V.2 Multimedia Controller

Meridian 562V.2 Multimedia Controller User Guide

Sales and service in the UK

Meridian Audio Ltd
Stonehill
Stukeley Meadows
Cambs
PE18 6ED
England

Tel (01480) 52144
Fax (01480) 459934

World Wide Web
<http://www.meridian-audio.com>

Part no: 562V/2

Sales and service in the USA

Meridian America Inc
3800 Camp Creek Parkway
Building 2400
Suite 122
Atlanta
GA 30331

Tel (404) 344 7111
Fax (404) 346 7111

Designed and manufactured in the UK by

Digital Gramophone and Wireless Ltd
Stonehill
Stukeley Meadows
Cambs
PE18 6ED
England

Copyright © 1993–1999
Digital Gramophone and Wireless Ltd

This guide was produced by
Human-Computer Interface Ltd,
<http://www.interface.co.uk>

Contents

Introduction 1

Introduces the 562V Multimedia Controller, and provides an overview of the other products available in the Meridian 500 Series.

The Meridian 500 Series	2
Sample configurations	3
Specification and accessories	5

Using the multimedia controller 7

Provides step-by-step instructions on how to operate the multimedia controller, using either the front panel or the Meridian System Remote.

Front panel	8
Switching on and off	9
Selecting a source	10
Adjusting the volume and changing the display	12
Recording a source	13

Setting up the multimedia controller 15

Describes how to unpack and install the multimedia controller, and gives details of the audio and video connections.

Unpacking	16
Positioning the multimedia controller	17
Connecting the multimedia controller	18
Connecting outputs	22
Connecting sources	23
Connecting to other Meridian Equipment	25

Configuring the multimedia controller without a computer 27

Describes how to perform a basic configuration of the multimedia controller without requiring a computer.

Choosing standard settings 28
 Configuring the sources 30
 Programming levels 32
 Specifying information about your system 33

Configuring the multimedia controller using a computer 35

Describes how to configure the multimedia controller using the Meridian Configuration program.

The Meridian Configuration program 36
 Running the Meridian Configuration program 37
 Creating a new settings file 39
 Setting up sources 41
 Changing the setup options 44
 Completing the configuration 45

Troubleshooting 47

Provides suggested solutions to typical problems.
 Maintenance 50
 Service and guarantee 51
 Index 53

Introduction

The Meridian 562V Multimedia Controller is the ideal controller for use in a Meridian Digital Music System, or in conjunction with a Meridian 568 Digital Surround Processor. It combines high performance digital control with high-quality video routing in a single integrated unit.

It provides direct digital inputs for digital sources such as CD or DVD, together with precision Delta-Sigma Analogue-to-Digital Conversion for conventional analogue sources such as FM radio and video sound. It also provides video switching for both composite video and S-video sources, and video conversion from S-video to composite.

The optional 517 DAC Module provides precision Digital-to-Analogue Conversion for an analogue tape loop, or a second room system.

For instructions on setting up the unit turn to *Setting up the multimedia controller*, page 15. Once the multimedia controller has been set up refer to *Using the multimedia controller*, page 7, for information about getting the best results from all your audio and video sources.

The Meridian 500 Series

The Meridian 500 Series is a unique system of digital, analogue, and video components designed to meet the demand for absolute quality, ease of use, and lasting value.

The flexibility of the Meridian 500 Series is such that you can assemble a system as simple or as complex as you need, perfectly suited to your musical and environmental requirements, and with the ability to add to it or change it at a later date should your requirements change.

Each Meridian 500 Series component is housed in a matching slim line case. Front panel controls provide access to the most important functions, and a full range of functions is available from the Meridian System Remote using a simple and intuitive control interface.

500 Series communications

The 562V Multimedia Controller is part of the Meridian 500 series of advanced digital, analogue, and video components, and these incorporate a sophisticated communications link, to allow you to control any combination of units using a single remote, and ensure that they will work together as a fully integrated system.

The communications system also allows you to extend your hi-fi system into two or three rooms, with the ability to control the sources in one room from the controller in another room.

Professional features

The 500 Series also includes features for professional users, including RS232 computer control.

The following pages give examples of two suggested configurations incorporating the 562V Multimedia controller, to illustrate the flexibility of the Meridian 500 Series.

Sample configurations

Meridian Digital Music System

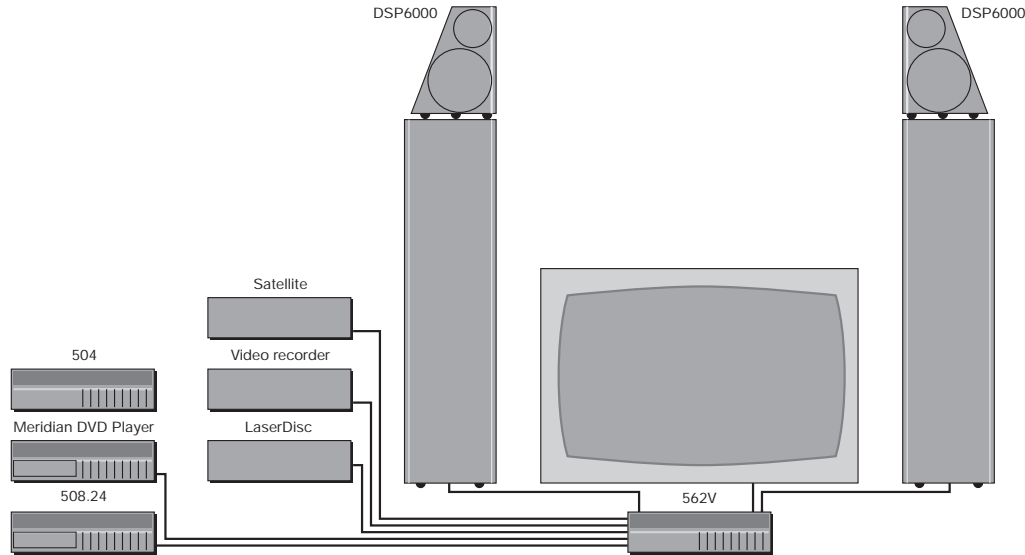

The 562V Multimedia Controller is the ideal control unit for use with the Meridian DSP6000 Digital Loudspeakers.

It provides direct digital inputs for digital sources, such as the Meridian DVD Player and LaserDisc sound, together with precision Delta-Sigma Analogue-to-Digital Conversion, for

conventional analogue sources such as the 504 FM Tuner and video sound.

It also includes video switching for composite video and S-video signals, such as from a satellite receiver, LaserDisc player, or video recorder.

Meridian Digital Theatre

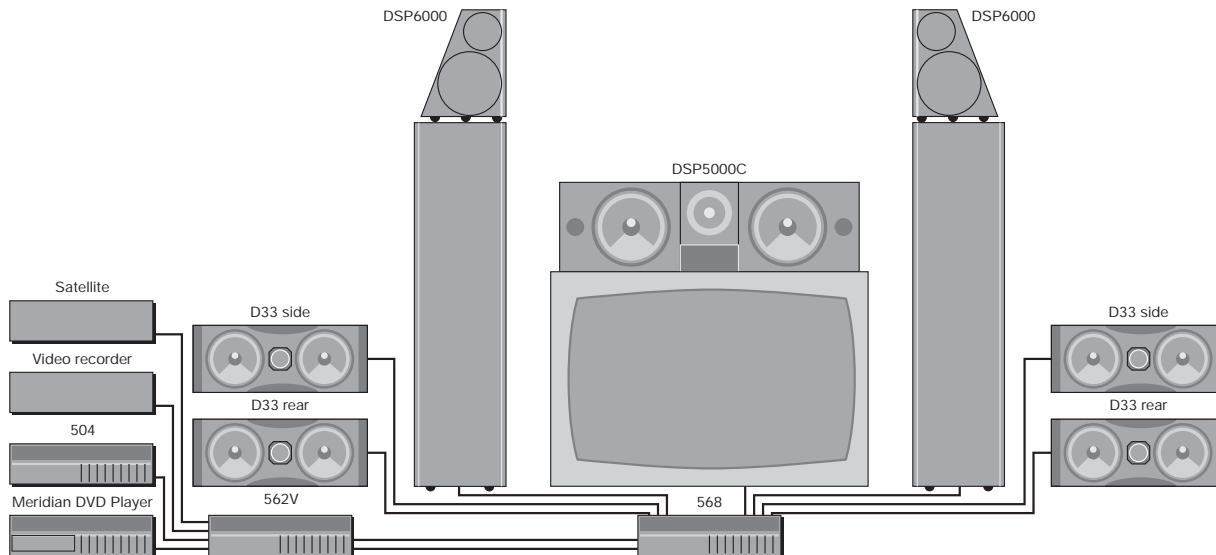

The 562V Multimedia Controller is ideal for use with the Meridian 568 Digital Surround Processor to create the ultimate surround system for all music and film sources.

The 568 Digital Surround Controller can connect directly up to eight Meridian active loudspeakers, such as the DSP6000

floor-standing speakers or the DSP33 compact loudspeakers.

The 562V provides video switching for composite video and S-video sources, and extends the range of inputs provided by the 568 to cater for up to five digital inputs, two optical inputs, and seven analogue inputs.

Specification and accessories

Specification

Digital inputs

5 x cable, 75 Ω , IEC958 and data compatible, up to 24 bits, 32-96kHz.

2 x optical, TOSlink (EIAJ), IEC958 and data compatible, up to 24 bits 32-96kHz.

Analogue inputs

7 x phono, 20k Ω input impedance.

1 x stereo Delta-Sigma ADC.

Analogue outputs

1 x main phono.

2 x tape phono.

Output 2V_{rms}, output impedance 47 Ω .

Distortion <0.01%.

Noise and hum <-95dB CCIR.

With optional 517 DAC module:

1 x stereo Delta-Sigma DAC.

Digital outputs

1 x main SPDIF cable, 75 Ω , up to 24-bit precision, 32-96kHz.

1 x tape SPDIF cable, 75 Ω , up to 24-bit precision, 32-96kHz.

1 x tape optical, TOSlink (EIAJ), up to 24-bit precision, 32-96kHz.

Video inputs

6 x composite unbalanced RCA phono 75 Ω , 0.5 – 1.5V_{p/p}.

4 x S-video 4-pin miniDIN.

Video outputs

1 x main composite unbalanced RCA phono 75 Ω , 1.5V_{p/p}.

2 x tape composite unbalanced phono 75 Ω , 1V_{p/p} to VCRs, identical signal via splitter.

1 x main S-video 4-pin miniDIN.

2 x tape S-video 4-pin miniDIN.

S-video to composite conversion on main or tape outputs.

Control	2 x Meridian Comms. 9-pin D connector for RS232 PC setup and control. 2 x trigger outputs for SCART or external switching, 3.5mm 2-pin jack socket, 8VDC at 100mA.
Dimensions	321mm x 88mm x 332mm (12.7" x 3.5" x 13.1") (W x H x D).
Weight	5kg (10lb).

Meridian Audio reserves the right to amend product specifications at any time.

Available accessories

The following accessories are available from your dealer.

Meridian 517 DAC Module

The Meridian 517 DAC Module adds a Digital-to-Analogue Converter to the 562V, to provide an analogue output from digital sources for a tape loop or a second room system. For more information contact your Meridian dealer.

Meridian 515/516 Phono Modules

The Meridian 515/516 Phono Modules convert the LP audio input (A1) for use with a moving magnet or moving coil pickup, respectively. For more information contact your Meridian dealer.

Meridian System Remote

The Meridian System Remote provides access to the facilities provided by the 562V Multimedia Controller, including those available from the front panel controls. In addition, it allows you to control any other 500 Series units in your system.

Rack mount kit

The Meridian 500 Shelf is a tray produced by Middle Atlantic Products which will allow the 562V, or any other 500 Series unit, to be fitted in a standard 19" rack. For more information please contact Middle Atlantic Products, Inc., Riverdale, NJ 07457, USA, (001) 973-839-1011, or their local distributor.

Using the multimedia controller

This chapter provides a summary of the functions of the multimedia controller to identify the controls which you use to operate the unit.

It also provides step-by-step instructions for operating the multimedia controller, using either the front panel or the Meridian System Remote.

Front panel

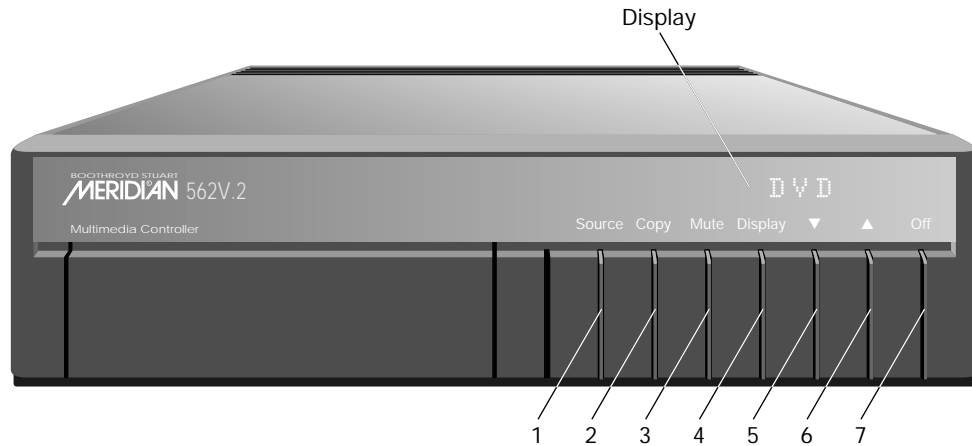

- 1 Source**
Selects the source.
- 2 Copy**
Copies a selected source to the audio and video tape outputs.
- 3 Mute**
Mutes the sound.
- 4 Display**
Changes the information displayed on the front panel.
- 5 ▼ (Decrease)**
Decreases the system volume.
- 6 ▲ (Increase)**
Increases the system volume.
- 7 Off**
Switches to standby.

Switching on and off

When not being used, the multimedia controller should be left in the standby state. This uses a negligible amount of electricity, but ensures that the components of the multimedia controller operate at maximum efficiency from the moment you start.

If you are not going to use the multimedia controller for several days you should switch the unit completely off at the back panel, and disconnect it from the AC power supply.

To switch on from standby

- Press **Source** (front panel), or select a source by pressing the appropriate source key on the remote: eg **CD**.

If the 562V Multimedia Controller is part of a Meridian system it will automatically switch on any other unit in the system, such as the CD player and Meridian DSP loudspeakers.

To switch to standby

- Press **Off** (front panel) or **Standby** (remote).

The display will show:



If you have other Meridian 500 Series equipment or Meridian DSP loudspeakers connected to the multimedia controller, these units will also switch to standby.

Selecting a source

Each source can be associated with both an audio input, and a video input.

For example, by default the TV source selects audio input A5 (for TV sound), and video input V5 (for the TV picture).

By default, the 12 sources shown opposite are available.

The audio and video input associated with each source can be configured from the front-panel controls, or using the Meridian Configuration program; for more information see *Configuring the multimedia controller without a computer*, page 27, or *Configuring the multimedia controller using a computer*, page 35.

<i>Source</i>	<i>Label</i>	<i>Audio input</i>	<i>Input</i>
CD	CD	D1/A2	*
Radio	RD	A3	*
LP	LP	A1	*
TV	TV	A4	V5
Tape1	T1	A5	*
Tape2	T2	D2	*
CDR	CR	D3	*
Cable	Cb	A4	V4
DVD	DV	D4	S3
VCR1	V1	A7	S1/V1
VCR2	V2	A6	S2/V2
LD	LD	O1	V3

* Last Valid

To select a source

- Press **Source** (front panel) until the display shows the source you want.

For example:



Alternatively, press the appropriate source key on the remote; eg **CD**.

After a short delay the display shows the currently selected source and volume setting.

For example:



Last Valid option

The audio or video input for a source can be defined as Last Valid, in which case selecting the source will leave the audio or video input unchanged.

For example, by default the CD source has the video input defined as Last Valid. This allows you to select **TV** followed by **CD** to watch the TV picture while listening to a compact disc, instead of the TV sound.

Adjusting the volume and changing the display

The 562V Multimedia Controller is not normally configured to provide an internal volume control. However, you can control the system volume from the front panel as described in this section.

To change the volume

- Press ▲ or ▼ (front panel), or the red ▲ or ▼ keys on the remote.

As you adjust the volume setting the display will show the current volume level.

For example:



To mute the sound

- Press **Mute**.

The display will show:



To restore the sound

- Press **Mute** again.

Alternatively the sound will be restored if you adjust the volume.

To change the display

- Press **Display**.

Each time you press **Display** the display will step between the following options:

Display option

Example

Source and volume.
This is the usual display.



Source only (full label).



Blank.







Recording a source

You can copy the audio and video components of a source to the audio and video tape outputs, independently of the source you are listening to.

To copy a source

- Press **Copy**.

Each time you press **Copy** the multimedia controller will step between the following options:

<i>Display</i>	<i>Option</i>
	Copy Source. The current source is fed to the audio/video tape outputs.
	Copy Attenuate. The audio outputs are muted.
	Copies the first source to the audio and video tape outputs.
	Steps through each source in turn, etc.

For example, to record a TV programme press **Copy** until the display shows:



The TV sound and picture will now be fed to the audio and video tape outputs respectively.

You can then select another source, such as **CD**, without affecting the recording.

Setting up the multimedia controller

This chapter explains how to install the 562V Multimedia Controller. It describes what you should find when you unpack the unit, how you should connect it to your other audio equipment, and the siting constraints.

Before you begin installation you should ensure that your multimedia controller is the correct voltage for your local AC supply. If it is not, do not try to install the multimedia controller, and contact your dealer.

You should not make any connections to the multimedia controller, or to any other component in your system, while the AC power supply is connected and switched on.

Unpacking

The 562V Multimedia Controller comes in a box containing the following components:

- Meridian 562V Multimedia Controller.
- Power cord.
- 500 Series communications lead.
- Meridian Configuration program on two floppy disks.
- RS232 computer serial lead.
- This manual.

If any of these items are missing please contact your dealer. You are advised to retain the packing in case you need to transport the unit.

Radio interference

FCC Warning: This equipment generates and can radiate radio frequency energy and if not installed and used correctly in accordance with our instructions may cause interference to radio communications or radio and television reception. It has been type-tested and complies with the limits set out in Subpart J, Part 15 of FCC rules for a Class B computing device. These limits are intended to provide reasonable protection against such interference in home installations.

EEC: This product has been designed and type-tested to comply with the limits set out in EN55013 and EN55020C.



Positioning the multimedia controller

Safety warnings

- Do not expose the unit to dripping or splashing.
- Do not place any object filled with liquid, such as a vase, on the unit.
- Do not place naked flame sources, such as lighted candles, on the unit.

To avoid overheating

Do not position the multimedia controller:

- In direct sunlight.
- Near heat sources, such as a radiator.
- Directly on top of heat producing equipment, such as a power amplifier.

Ensure that air can flow through the cooling slots on the base and top cover.

To avoid interference

Do not position the multimedia controller:

- Near strong magnetic radiation, such as near a power amplifier.
- Near to a television, or where connecting cables may be subject to or cause interference.

Connecting the multimedia controller

Rear panel

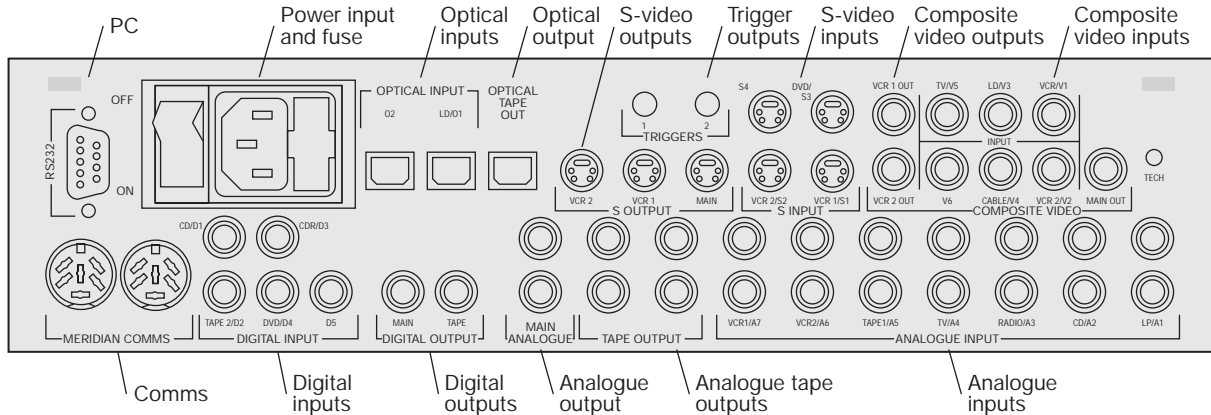

Digital audio inputs

The following table gives details of the digital audio inputs:

<i>Use this input</i>	<i>To connect to this</i>
CD/D1, TAPE2/D2, CDR/D3, DVD/D4, D5	A digital source, such as a CD player, DVD player, digital tape recorder, or digital television tuner.

Use this input

LD/O1, O2

To connect to this

A digital-optical source, such as a LaserDisc player, the 519 Demodulator, or a CD player with no digital-cable output.

Digital audio outputs

The following table gives details of the digital audio outputs:

<i>Use this output</i>	<i>To connect to this</i>
MAIN DIGITAL OUTPUT	A digital surround processor or Meridian DSP loudspeakers.
TAPE DIGITAL OUTPUT	A digital tape recorder, computer sound card, or digital second-room system.
OPTICAL TAPE OUT	A digital recorder with optical input, such as a MiniDisc recorder.

Digital connections

The digital connections should be made with high-quality 75Ω screened cable. Suitable cables are available from Meridian. We do not recommend using audio cables, which do not have adequate shielding or the correct impedance, or cables intended for UHF applications, as these do not provide adequate shielding in the 1–30MHz region.

Optical connections should be made using a suitable optical fibre supplied by your dealer.

Analogue audio inputs

The following table gives details of the analogue audio inputs:

<i>Use this output</i>	<i>To connect to this</i>
LP/A1, CD/A2, RADIO/A3, TV/A4, TAPE1/A5, VCR2/A6, VCR1/A7	An analogue source such as a radio tuner, tape recorder, TV tuner, or cable television.

Analogue audio outputs

The following table gives details of the analogue audio outputs:

<i>Use this output</i>	<i>To connect to this</i>
MAIN ANALOGUE	The Meridian 568 Digital Surround Processor analogue input, to take advantage of its 24-bit ADC precision.
TAPE OUTPUTS	An analogue tape recorder or analogue second-room system.

Analogue connections

The analogue connections should be made using high-quality screened cable, taking care to connect the left and right channels correctly.

Video inputs

The following table gives details of the video inputs:

<i>Use this input</i>	<i>To connect to this</i>
VCR1/V1, VCR2/V2, LD/V3, CABLE/V4, TV/V5, V6	Composite video signals, using phono connectors.
S1/VCR1, S2/VCR2, S3/DVD, S4	S-video signals, using miniDIN connectors.

Video outputs

The following table gives details of the video outputs:

<i>Use this output</i>	<i>To connect to this</i>
MAIN OUT	Compositor video input on a TV or monitor, using a phono connector.
VCR1 OUT, VCR2 OUT	Composite video recorder inputs, using phono connectors.
MAIN S OUTPUT	S-video input on a TV or monitor, using a miniDIN connector.
VCR1 or VCR2 S OUTPUTS	S-video video recorder inputs, using miniDIN connectors.

Video connections

The composite video connections should be made with high-quality 75Ω screened cable. We do not recommend the use of audio cables, which do not have adequate shielding or the correct impedance, or cables intended for UHF applications, as these do not provide adequate shielding in the 1-30MHz region.

The S-video connections should be made using S-video cables with miniDIN plugs.

Communications connections

The following table gives details of the communications connections:

<i>Use this connection</i>	<i>To connect to this</i>
COMMS	Other Meridian 500 Series equipment, and the master digital speaker.
RS232	The serial port of a PC, to configure the 562V. See <i>Configuring the multimedia controller using a computer</i> , page 35.
TRIGGERS 1,2	Trigger outputs, which can be used to switch external equipment. They may also be used to provide function-select for SCART; for more information please refer to your dealer.

Connecting outputs

To connect to a 568 Digital Surround Processor

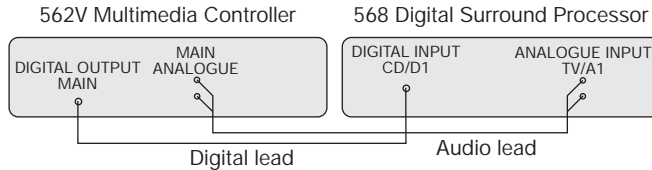

- Connect the MAIN digital output of the 562V to the CD/D1 digital input socket of the 568, using high-quality 75 Ω screened cable.
- Connect the MAIN analogue output of the 562V to the TV/A1 analogue input socket of the 568, using screened audio cable.

This takes advantage of the high-quality 24-bit analogue-to-digital converter in the 568 to perform the conversion of analogue sources.

- Route the video through the 568 to take advantage of the on-screen display.
- Configure the 562V to Type 1; see *Choosing standard settings*, page 28.

- Configure each 562V source as required; see *Setting up sources*, page 41.
- Configure the 568 to a 562 Type option; see the *568 Digital Surround Processor User Guide* for more information.

To connect to Meridian DSP loudspeakers

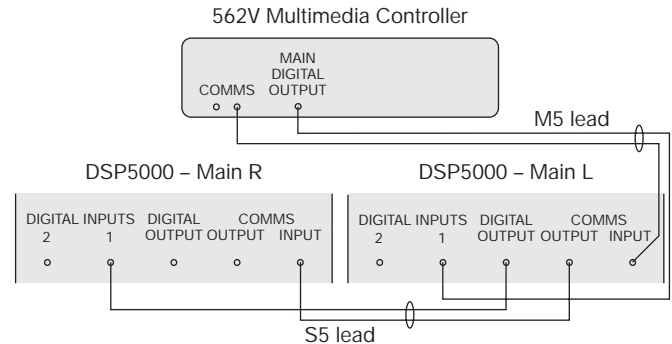

- Connect one of the COMMS sockets on the 562V, and the MAIN digital output, to one of the digital speakers using an M5 lead.
- Link the two digital speakers together using an S5 lead as shown in the illustration.

Connecting sources

To connect to a digital source (eg Meridian 508.24 24-Bit CD Player)

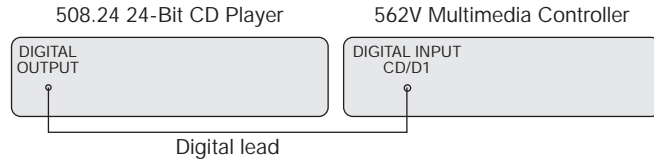

You can connect up to five digital and two optical sources to the 562V Multimedia Controller.

- Connect the digital source to one of the digital input sockets of the 562V, using a high-quality digital or optical lead.
- Connect the 508.24 to the 562V using the comms lead provided; see *To connect to other Meridian 500 Series equipment*, page 25.

To connect to an analogue source (eg Meridian 504 FM Tuner)

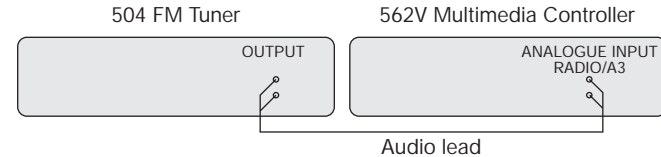

You can connect up to seven analogue sources to the 562V Multimedia Controller.

- Connect the analogue source to one of the analogue input sockets of the 562V, using a standard phono lead.
- Connect the 504 to the 562V using the comms lead provided; see *To connect to other Meridian 500 Series equipment*, page 25.

To connect to a DVD player (eg Meridian DVD Player)

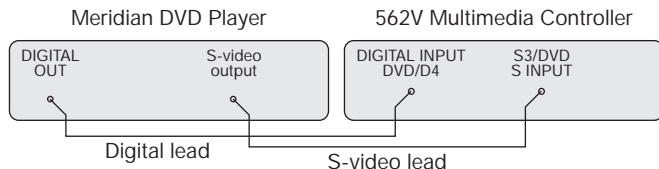

- Connect the S-video output from the DVD player to the S3/DVD S INPUT socket of the 562V, using an S-video lead.
- Connect the digital output from the DVD player to the DVD/D4 digital input of the 562V, using a digital lead.
- Connect the DVD player to the 562 using the comms lead provided; see *To connect to other Meridian 500 Series equipment*, page 25.

To connect to a LaserDisc player

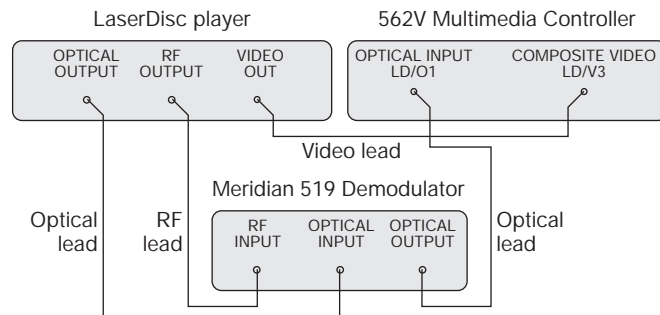

- Connect the video output from the LaserDisc player to the LD/V3 COMPOSITE VIDEO input socket of the 562V, using a video lead.
- Connect the RF output from the LaserDisc player to the 519 RF input.
- Connect the optical output from the LaserDisc player to the 519 optical input, and the 519 optical output to the LD/O1 OPTICAL input socket on the 562V, using optical leads.

Connecting to other Meridian Equipment

To connect to other Meridian 500 Series equipment

- Connect one of the COMMS sockets on the rear panel of the multimedia controller to one of the COMMS sockets on another 500 Series unit, using the 500 comms lead provided with the other unit.

The sequence in which you connect the units is not important.

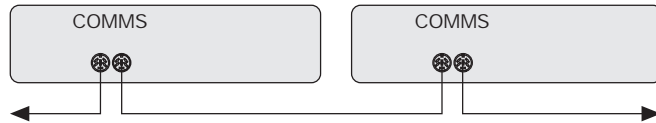

Then configure the units with the following automatic setup procedure:

- Switch all the units to standby.
- Press **Clear** on the remote.

Each unit will display:



One unit will then be designated as the controller, and display:



This is the unit that will respond to the remote.

All the other units will be configured as non-controllers, and display:



Your system is now set up and ready for use.

- If, for any reason, the automatic setup does not give the configuration you want, restore the default operation by selecting Type 1 as described in *To select a standard setting*, page 28.

Note: Do not, under any circumstances, connect any equipment other than Meridian 500, 600, or 200 Series to the socket marked COMMS on the rear of the multimedia controller.

Configuring the multimedia controller without a computer

The 562V Multimedia Controller can be set up for most applications using just the front-panel controls.

This chapter explains how to choose one of the standard settings, which are designed to cater for the six most common configurations of sources and outputs.

Alternatively, for complete control over all aspects of the multimedia controller's configuration you can set up the unit from a computer using the Meridian Configuration program. For full information refer to the next chapter.

Choosing standard settings

The 562V.2 Multimedia Controller provides the following six alternative standard settings, called Types, which configure all aspects of the multimedia controller into the six most commonly needed configurations:

Type	Description
1	Main room 500-Series operation with no DAC module (default).
2	200-Series operation for a system with a 200-Series CD player.
6	200-Series operation for a system without a 200-Series CD player.
7	Second-room system using a digital feed into D1.
8	Second-room system using an analogue feed into A5.
9	Main room 500-Series operation using a DAC module for analogue tape.

The Types are numbered for consistency with the original 562V.

Choosing one of the six standard settings overrides any other configuration you may have performed, and so can be used to reset the configuration of the multimedia controller.

To select a standard setting

- Switch off any power amplifiers that are connected to the multimedia controller.
- Turn off the multimedia controller, using the power switch on the back panel.
- Turn on the power again while holding down the **Off** key on the front panel.

The display will show:



It will then show:



- Press ▼ or ▲ to change the type number.

For example, to select Type 9 the display shows:



- Turn off the multimedia controller using the power switch on the back panel.
- Turn on again to use the standard settings you have selected.

562V Multimedia Controller standard settings

The following table shows the options configured by the six standard Type settings on the 562V Multimedia Controller:

<i>Source</i>	<i>Label</i>	<i>Input</i>	<i>Sensitivity</i>	<i>Comms</i>	<i>Composite input</i>	<i>S-video input</i>	<i>Triggers</i>
CD	CD	D1/A2	n/a	1	*	*	1
Radio	RD	A3	2.0V	2	v2	*	1
LP	LP	A1	1.0V	-	*	*	1
TV	TV	A4	1.0V	-	v5	*	1+2
Tape1	T1	A5	2.0V	-	*	*	1
Tape2	T2	D2	n/a	-	*	*	1
CDR	CR	D3	n/a	-	*	*	1
Cable	Cb	A4	1.0V	-	v4	*	1+2
DVD	DV	D4	n/a	3	SC	S3	1+2
VCR1	V1	A7	1.0V	-	v1	S1	1+2
VCR2	V2	A6	1.0V	-	v2	S2	1+2
LD	LD	O1	n/a	-	v3	*	1+2

* Last valid input, displayed as LV (audio), Nv (video), NS (S-video), or t0 (Triggers).

Configuring the sources

When the multimedia controller is set to one of the standard settings the 12 source selection keys on the remote select the standard labels and inputs, as shown in the table on page 29.

If the configuration you want is not catered for by one of the standard settings, you can configure each source individually.

The 562V Multimedia Controller provides 12 sources corresponding to the 12 source selection keys on the remote:

CD, Radio, LP, TV, Tape1, Tape2, CDR, Cable, DVD, VCR1, VCR2, and LD.

For each source you can configure:

- The label used for it on the front panel display, from a range of alternative labels.
- The audio input it selects.
- The comms type and address, to identify other Meridian 500 Series equipment.
- The composite video and S-video inputs it selects.

The options are summarised in the table shown on page 31.

To configure a source

- Turn off the multimedia controller, using the power switch on the back panel.
- Turn on the power again while holding down the **Display** key on the front panel until the display shows **Conf**.
- Press **Source** until the left-hand pair of characters identifies the source you want to configure.

For example, to configure the CD source the display initially shows:











- Press **Copy** (front panel), or **▶** and **◀** (remote), to step between options.

The right-hand pair of characters shows the current value of the option.

- Press **▲** or **▼** to change the value of the option.

When you have finished programming sources:

- Switch off at the back panel, and then switch on again to restore normal operation.

<i>Option</i>	<i>Initial value</i>	<i>Alternative values</i>	<i>Explanation</i>
Label		CD, RD, LP, etc.	The label used to identify the source on the front-panel display.
Audio input		A1 – A6, or LV.	Choose A1 to A6 to specify the input, or LV to use the last valid input.
Extra analogue input		E1 - E3, or NE	Choose E1 to E3 to use A1 to A3 as extra inputs for making analogue recordings, or NE for no input.
Comms type		1C – 8C, or NC.	Choose 1C for a Meridian CD player, 2C for a Meridian FM Tuner, or NC otherwise.
Address		1A – 8A.	Allows you to have up to eight of each source type.
Composite video input		v1 – v6, Nv, SC, or BL.	Choose v1 – v6, Nv for last valid, SC to convert from the specified S-video input, or BL for blank.
S-video input		S1 – S4, or NS.	Choose S1 – S4 to specify an input, or NS to use the last valid input.
Trigger output		t1, t2, tB, or t0.	Choose t1 or t2 for the corresponding trigger output, tB for both, or t0 for neither.

Programming levels

The 562V Multimedia Controller allows you to program the level of each analogue source independently, to suit your other equipment, so that when you switch between sources the volume stays the same.

You can increase the sensitivity of any source by up to four steps. The loudest source, usually CD, should therefore be chosen as the reference.

The following table shows the correspondence between the gain and sensitivity on the audio inputs:

Gain	0dB	2dB	8dB	14dB
Sensitivity	2.5V	2.0V	1.0V	0.5V

To balance input levels

- Switch off any power amplifiers that are connected to the multimedia controller.
- Turn off the multimedia controller, using the power switch on the back panel.
- Turn on the power again while holding down the **Mute** key on the front panel.



The display will show:

- Release the **Mute** key.

The multimedia controller will switch to standby.

- Select the source that sounds loudest and make it your reference.
- Switch to another source in the usual way.
- Use the ▲ and ▼ keys to change the sensitivity.



For example, the display will show:

The front-panel indicator (above the **Copy** key) will flash if clipping occurs, in which case reduce the sensitivity.

- Switch between the source you are changing and the reference source until they sound equally loud.
- Repeat the procedure for your other sources.
- When you have finished programming levels, switch the power off and on again to restore normal operation.

Specifying information about your system

You can configure the operation of the 562V Multimedia Controller to suit the way your system is set up, and the way in which you want to use it. For more information about these options see *Changing the setup options*, page 44.

These settings are configured automatically to appropriate values when you choose one of the standard Type settings, and you should not normally need to alter them; see *Choosing standard settings*, page 28.

To configure the multimedia controller

- Turn off the multimedia controller, using the power switch on the back panel.
- Turn on the power again while holding down the **Display** key on the front panel.

The display will show:

A rectangular LCD display showing the word "Conf" in a simple, pixelated font.

It will then show the first configuration option:

A rectangular LCD display showing the number "500" in a simple, pixelated font.

- Press **Display** to move between the options.

- Press ▲ or ▼ to change the value of the current option.

The table below shows the options you can configure.

<i>Option</i>	<i>Initial Value</i>
Communications mode (500 or 200)	500
Controller mode (Auto, Con, or NCon)	Auto
System address (1-8)	SA=1
Product address (1-8)	PA=1
DAC mode (NDAC or DACT)	DACT
Volume mode (VoIM, VoIS, or VoIN)	VoIM
Video version (562 or 562V)	562V
200 Series CD player (N or Y)	CD?N

Configuring the multimedia controller using a computer

The 562V Multimedia Controller provides a flexible range of customisation options which you can change to suit your own preferences and the other equipment in your system. To configure the 562V you use the Meridian Configuration program, an intelligent Windows-based application that is supplied with the 562V.

This chapter explains how to install the Meridian Configuration program, and then how to use it to create your own configuration of the 562V.

The Meridian Configuration program

The Meridian Configuration program is a stand-alone Windows-based application that lets you design your own configuration of the 562V Multimedia Controller to suit your own personal preferences and the particular configuration of equipment in your system.

The Meridian Configuration program provides the following sections to allow you to control the corresponding aspects of the multimedia controller's operation:

Setup



Setup

Lets you specify general features of the multimedia controller's operation, including the operation of the volume control and menus, and settings affecting its operation in multi-room systems.

Sources



Sources

Lets you customise the operation of each of the sources, including the name of the source on the front-panel display, the audio and video inputs used for the source, and additional information about the type of each source.

Requirements

To use the Meridian Configuration program you need:

- A computer running Windows 95, Windows 98, or Windows NT 4.00.
- A 100MHz or faster Pentium-class processor.
- At least 16 Mbytes of RAM.
- 5 Mbytes of free disk space.
- A vacant 9-pin serial port assigned to one of COM1 to 4.

The software requires a mouse or similar pointing device – it cannot be operated solely from the keyboard.

To install the Meridian Configuration program

- Insert the first Meridian Configuration program installation disk.
- Choose **Run...** from the **Start** menu.
- Type A: setup and press .
- Follow the on-screen instructions, inserting the second installation disk when prompted.

Running the Meridian Configuration program







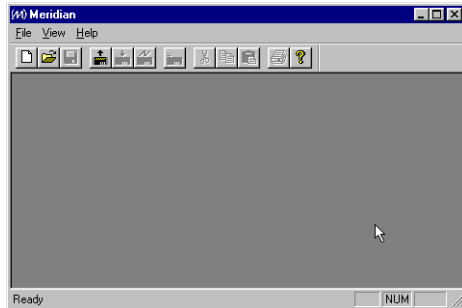



To run the Meridian Configuration program

- Click **Start**, point at **Programs, Meridian** then click **Product Configuration**.

The **Meridian** window will be displayed:



The toolbar provides a convenient way of accessing the most important menu options:

<i>Button</i>	<i>Option</i>	<i>Function</i>
	New	Creates a new settings file.
	Open	Opens an existing settings file.
	Save	Saves the current settings file to disk.
	Fetch	Fetches the current configuration of the attached product(s).
	Store	Stores the current settings to attached products.
	Disconnect	Disconnects the program from attached products.
	Add Product	Adds a product to the current settings.
	Copy	Copies text or settings onto the clipboard.
	Paste	Pastes text or settings from the clipboard.
	About	Displays program information.

To connect the serial cable

The serial cable is symmetrical, and can be connected either way round.

- Connect one end to the RS232 connector on the back panel of the 562V Multimedia Controller.
- Connect the other end to one of the serial ports on the PC or PC notebook computer.

Then specify the serial port you are using as follows:

- Choose **Options...** from the **View** menu to display the **Options** dialogue box:

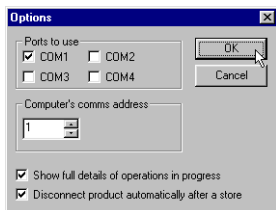

- Select the port you want to use and click the **OK** button.

Creating a new settings file

This section explains how to create a new settings file, using the Meridian Configuration program, and how to enter personal information to identify the settings in your product.

The first step is to fetch the initial settings from the multimedia controller, to use as a starting point for your configuration.

- Click the **Fetch** button in the toolbar.



The **Progress** dialogue box will show you the progress as the settings are fetched:

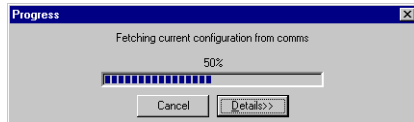

A new settings file will be created for you, with the initial name **MSF1**, and the **Meridian** window will show a **Multimedia controller** icon to identify the product you are configuring.



- Choose **Save As** from the **File** menu, enter an appropriate name for the file, such as your name, and click the **Save** button.

To display the settings

- Double-click the **Multimedia controller** icon, to open it and display the settings it contains.

The left-hand panel of the **Meridian** window will change to show the following two icons:

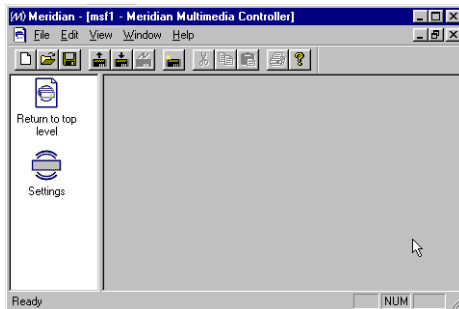

Settings is the initial configuration in the settings file.

Double-clicking **Return to top level** takes you back to the previous level.

To display or edit the settings

- Double-click the **Settings** icon.

The **Meridian** window will change to show the two categories of settings contained in the settings file: **Sources** and **Setup**.

The options available in each case are explained in the following sections.

At this stage you may find it useful to maximise the Meridian Configuration program window so you can see all the options on each screen.

Setting up sources

This section describes how to use the Meridian Configuration program to configure the sources provided by the multimedia controller.

To set up sources

- Click the **Sources** icon in the left-hand panel of the **Meridian** window.

The right-hand panel shows a list of the 12 sources that are available. For each source you can configure its audio, video, and advanced settings.

To configure the source options

- Select the source in the list of sources.

The settings for the source are shown in a panel to the right:

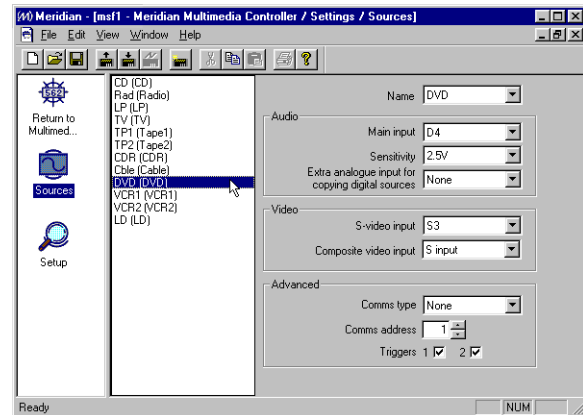

To change the name used to identify the source on the front-panel display:

- Choose a name from the **Name** drop-down menu.

Choosing **Unused** prevents the source from appearing when you press the **Source** key, or the corresponding source key on the Meridian System Remote.

The name used to identify each source is shown in the list of sources, followed by the Meridian System Remote key used to select the source in brackets.

Audio

Use the **Audio** drop-down menus to specify the audio settings for the source.

- From the **Main input** drop-down menu specify the digital or analogue audio input you want to use for the source.

The **Main input** option can be set to **Last valid** to leave the input unchanged when you select the source. This allows you to create a source that changes some other aspect of the current source, such as the associated video input, without changing the selected audio input.

If you have specified an analogue input for the **Main input**:

- Specify the sensitivity for the source by choosing an option from the **Sensitivity** drop-down menu.

If you have specified a digital input for the **Main input**, you can use the **Extra analogue input** drop-down menu to specify one of the analogue inputs A1 to A3 to be copied to the analogue tape output when you select the source. This allows you to connect a source to both digital and analogue inputs, to make either digital or analogue recordings.

Video

Use the **Video** drop-down menus to specify the video settings for the source.

- From the **S-video input** drop-down menu specify the S-video input to loop to the MAIN S output when the source is selected.
- From the **Composite video input** drop-down menu specify the composite video input to loop to the MAIN composite video output when the source is selected. Alternatively, specify **S input** to convert the **S-video input** you specified to the composite output, or **Blank** to blank the output.

Each video input option can be set to **Last valid** to leave the video loop unchanged when you select the source. You would usually do this for audio-only sources, such as **CD**:

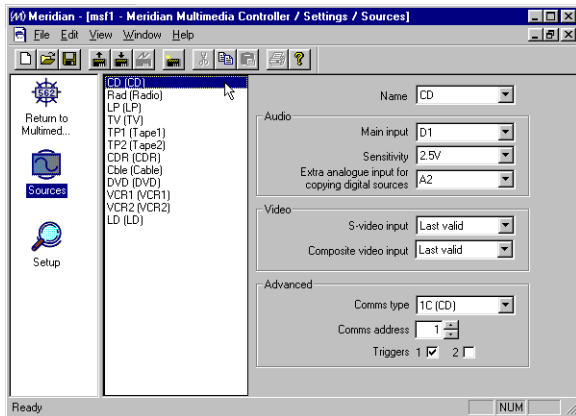

Advanced

Specify the **Advanced** options as follows:

- If the source is connected to another Meridian unit, set **Comms type** to **1C** for a Meridian CD player, **2C** for a Meridian FM tuner, and **3C** for a Meridian DVD player. Otherwise set it to **None**.
- If you have two Meridian source units of the same type you can configure them to have different Comms addresses. You can then select the appropriate source by specifying its Comms address in the **Comms address** field.
- Select **Triggers 1** and/or **2** to switch the corresponding trigger output on when the source is selected.

Trigger 1 is usually selected for all sources, to switch on a power amplifier, and **Trigger 2** is usually selected for video sources, to switch a TV.

Changing the setup options

The final stage in editing the settings is to configure the general **Setup** options.

To change the setup options

- Click the **Setup** icon in the left-hand panel of the **Meridian** window.

The **Setup** options will be displayed:

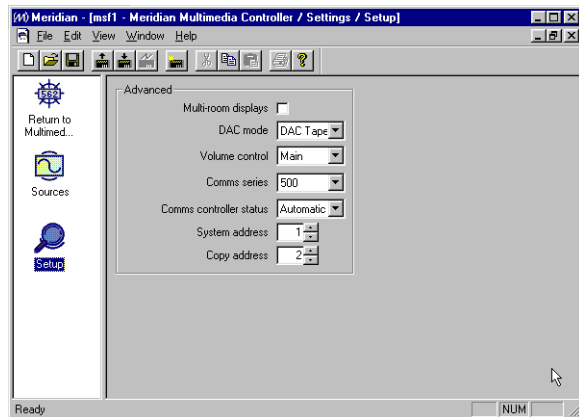

The options are described in the table opposite:

<i>Option</i>	<i>What it means</i>
Multi-room displays	Includes displays of information from Meridian sources; eg CD track number or FM tuner frequency.
DAC mode	Specifies the operation of the optional 517 DAC Module. Choose No DAC if there is no DAC module, or DAC Tape to use the DAC for a tape loop or second room system. DAC Variable/DAC Fixed are provided for the original 562V unit.
Volume control	Specifies the system controlled by the 562V front-panel volume keys. Choose Main for the main system, Secondary if the 562V is used in a second room, and None if the 562V is in the second or third room of a three-room system.
Comms controller status	Specifies whether the 562V is controller, not controller, or set by auto setup; see <i>Connecting to other Meridian Equipment</i> , page 25.
System and Copy address	For two-room systems.

Completing the configuration

The final stage in creating a settings file is to save it, and then store it to the multimedia controller.

To save the current settings

- Choose **Save** from the **File** menu or click the Save toolbar button, to save the changes you have made to the settings file to your PC hard disk.



If the download was successful the 562V will switch itself to standby.

To store the settings to the 562V Multimedia Controller

- Click the **Store** button.



The settings will then be downloaded to the 562V. The 562V will display:



As the download proceeds the following dialogue box shows its progress:

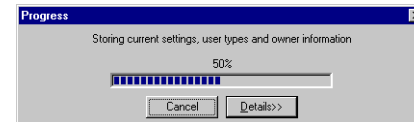

Troubleshooting

This chapter provides suggested solutions to typical problems that may occur when setting up the multimedia controller

If you are still not able to resolve a difficulty with the help of this guide and the suggestions in the following pages, please contact your Meridian dealer or Meridian Audio Ltd.

No lights are displayed when switching on

- Check that your AC power supply is connected correctly.
- Check that the **ON OFF** switch on the rear panel is in the ON position.
- Check that the fuse on the multimedia controller rear panel and the fuse in the unit's power plug have not blown; see *To change the mains fuse*, page 50.

There is hum on the LP input

The LP input is the most sensitive input on the multimedia controller.

- Check that the tone arm is connected to the technical ground of the multimedia controller.
- Check that the tone arm is connected to the power ground in the turntable.
- If you are using a magnetic pickup, check that there is not another piece of equipment too near to the turntable or the left-hand side of the multimedia controller. If so, re-position the equipment to cure the problem.

There is hum on other inputs

- Check your other equipment.
- Consult your dealer.

There is interference on the radio and/or television when the multimedia controller is switched on

Before following the steps below, ensure all units are switched off.

If this equipment does cause or suffer from interference to/from radio or television reception then the following measures should be tried:

- Reorient the receiving aerial (or antenna) or route the antenna cable of the receiver as far as possible from the 562V Multimedia Controller and its cabling.
- Ensure that the receiver uses well-screened antenna cable.
- Relocate the receiver with respect to the multimedia controller.
- Connect the receiver and this product to different AC outlets.

Communication is not working between the 562V Multimedia Controller and other Meridian products

- Check that all products are interconnected using the correct comms leads.
- If the installation includes 200 Series or 600 Series units, check that all 500 Series units are set to 200 mode.

Meridian Configuration program repeatedly fails to talk to the product

- Check that you have selected a COM port.
- Check that no other program currently running is using the COM port.
- Check that it is connected correctly.
- Turn off the 562V for a few seconds and turn back on, then retry.
- Quit from all other programs and retry.
- Reboot the computer and retry.
- Ensure you are using the serial lead supplied with the product, or a null modem cable.
- If you are using a laptop try turning off the screensaver or power management software.

Maintenance

Cleaning

When cleaning the multimedia controller bear in mind that the front of the multimedia controller is plastic, and the display panel and lid are glass.

Disconnect the power cord before cleaning the unit.

Note: Do not use abrasive cleaners on any part of the multimedia controller.

To clean the case, display panel, and keypad

- Use a slightly damp cloth.

Ensure that no water is allowed to get inside the case, and do not reconnect the power until you are certain that the multimedia controller is completely dry.

To clean the audio and video connections

The audio and video sockets on the rear of the multimedia controller are gold-plated and need no cleaning if gold-plated phono plugs are used. Otherwise, it is recommended that you unplug and reconnect the plugs at least once a year. A proprietary contact cleaner can be used to some advantage.

To change the mains fuse

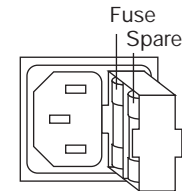

- Remove the mains connector, and pull out the drawer next to the power input to access the fuses.

Before replacing a blown fuse, if possible ascertain the cause of the failure.

The fuse drawer includes a spare fuse. This should be replaced by one of the same rating.

Service and guarantee

Service

The Meridian 500 Series of hi-fi components have been carefully designed to give years of untroubled service. There are no user-serviceable parts inside the case, nor do the units require any form of maintenance.

In the unlikely event that your multimedia controller fails to function correctly, it should be returned, in its original packaging, to your Meridian dealer.

In case of difficulty within the UK or USA please contact the appropriate sales and service address shown on page ii.

In case of difficulty outside the UK or USA, contact the importing agent for the territory. A list of Meridian agents abroad is available from Meridian Audio.

No responsibility can be accepted for the multimedia controller whilst in transit to the factory or an agent, and customers are therefore advised to insure the unit.

When seeking service under guarantee, proof of the date of purchase will be required.

Guarantee

The 562V Multimedia Controller is guaranteed against defects in material and workmanship for two years from the date of purchase.

The guarantee is void if the 562V Multimedia Controller has been subject to misuse, accident, or negligence, or has been tampered with or modified in any way without the written authorisation of Meridian Audio Limited. Note that connecting anything other than the correct network lead to the COMMS sockets may cause damage to the 562V Multimedia Controller which will not be covered by this guarantee. Attempted servicing by unauthorised people may also invalidate this guarantee. Labour and carriage charges are not covered unless by local agreement.

Outside the UK, local warranty liability is restricted to equipment purchased within the territory. Our agents abroad are only under contractual obligation to service under guarantee equipment sold through them. They are entitled to make a non-refundable charge for any service carried out on other equipment.

This guarantee does not limit your statutory rights within the United Kingdom.

Index

- A**
 - Accessories** 6
 - Analogue audio inputs** 19
 - Analogue connections** 20
 - Analogue sources, connecting** 23
 - Audio inputs**
 - analogue 19
 - digital 18
 - Audio outputs**
 - analogue 19
 - digital 19
 - Automatic setup** 25
- B**
 - Balancing input levels** 32
- C**
 - Changing the display** 12
 - Cleaning** 50
 - the audio and video connections 50
 - the case 50
 - Clipping indicator** 32
 - Communications connections** 21
 - Components** 16
 - Computer, configuring using** 35
 - Configuration options** 33
 - 200 Series CD player 33
 - communications mode 33
 - Configuration options** (*continued*)
 - controller mode 33
 - product address 33
 - system address 33
 - video version 33
 - volume mode 33
 - Configuring sources** 30
 - address 31
 - audio input 31
 - comms type 31
 - extra analogue input 31
 - label 31
 - trigger output 31
 - video input 31
 - Configuring the multimedia controller**
 - using a computer 35
 - without a computer 27, 33
 - Connecting, to Meridian 500 Series equipment** 25
 - Connections**
 - analogue 20
 - communications 21
 - digital 19
 - Connections** (*continued*)
 - optical 19
 - video 21
 - Controller** 25
 - Copy Attenuate option** 13
 - Copy Source option** 13
 - Copying, a source** 13
 - D**
 - DAC Module** 1
 - Digital audio inputs** 18
 - Digital audio outputs** 19
 - Digital connections** 19
 - Digital source, connecting** 23
 - Display** 12
 - DVD player, connecting** 24
 - F**
 - Front panel controls** 8
 - Fuse, replacing** 50
 - G**
 - Guarantee** 51
 - H**
 - Hum problems** 48

I Inputs

- audio 18, 19
- video 20

Installing the Meridian

- Configuration program 36
- Introduction 1

L LaserDisc player, connecting 24

- Last Valid 29
- Last valid option 11
- Levels, programming 32

M Maintenance 50

- Meridian 500 Series 2
 - communications 2
- Meridian 504 FM Tuner,
 - connecting 23
- Meridian 508.24 24-Bit CD Player,
 - connecting 23
- Meridian 517 DAC Module 1, 6
- Meridian 568 Digital Surround Processor 4
 - connecting 22

Meridian Configuration program 36

- installation 36
- requirements 36
- running 37
- toolbar buttons 37
- Meridian Digital Music System 3
- Meridian Digital Theatre 4
- Meridian DSP loudspeakers,
 - connecting 22
- Meridian DSP6000 Digital Loudspeakers 3
- Meridian DVD Player 3
 - connecting 24
- Muting the sound 12

O Optical connections 19

- Options (View menu) 38
- Options dialogue box 38
- Outputs
 - audio 19
 - connecting 22
 - video 20

P PC, using to configure the 562V 35

R Rack mount kit 6

- Radio interference 16
- Rear panel 18
- Record a radio broadcast 13
- Recording, a source 13
- Return to top level icon 40

S Safety warnings 17

- Save (File menu) 45
- Save As (File menu) 39
- Selecting a source 10
- Serial cable, connecting 38
- Serial port, specifying 38
- Service 51
- Setting up the multimedia controller 15
- Settings file, creating 39
- Settings icon 40
- Setup icon 36, 44
- Setup options, using a PC 44

Sound
muting 12
restoring 12

Sources
audio inputs 10
configuring 30
configuring options using a PC 41
copying 13
default 11
programming levels 32
recording 13
selecting 10
setting up using a PC 41
video inputs 10

Sources icon 36, 41

Specification 5

Standard settings, selecting 28

Standby mode 9

Storing settings 45

Switching on from standby 9

Switching to standby 9

T

Toolbar buttons 37

Troubleshooting 47

Types, standard 29

U

Unpacking 16

Using the multimedia controller 7

V

Ventilation 17

Video connections 21

Video inputs 20

Video outputs 20

Volume
changing 12
muting 12
restoring 12



Free Manuals Download Website

<http://myh66.com>

<http://usermanuals.us>

<http://www.somanuals.com>

<http://www.4manuals.cc>

<http://www.manual-lib.com>

<http://www.404manual.com>

<http://www.luxmanual.com>

<http://aubethermostatmanual.com>

Golf course search by state

<http://golfingnear.com>

Email search by domain

<http://emailbydomain.com>

Auto manuals search

<http://auto.somanuals.com>

TV manuals search

<http://tv.somanuals.com>