

WORK MADE PLANE EASY.

Whether you are a professional or an ambitious do-it-yourself enthusiast, Metabo provides you with the right planer for your requirements. You can use Metabo planers for low-dust dressing and planing without harmful vibrations. Even thick boards cause no pro-

blems due to the anti planer cut patent. There is even more great technology such as the safety switch, the automatic workpiece feed and the conversion from surface planing to thickness planing without tools.

e.g. HC 300

Coated, solid aluminium die cast dressing plate with 1200 mm length

Therefore even long timbers can be guided well.

Automatic, even workpiece feed during thickness planing due to high quality steel rollers.

Precise thickness planing by bench thicknesser table on 8 bearings.

Built-in socket for connecting a suction unit.

Simple conversion from planer to bench thicknesser without tools.



Suction hood for dust-free trimming and thickness planing.

Sturdy substructure for safe working at ideal operating height.



Anti-planer cut (snipe) patent for ideal planing results. Minimal planer cut on the workpiece by patented special suspension of the rollers.



Planing of inclined surfaces
The stop can be inclined by up to 45°.



Precise thickness planing by bench thicknesser table on 8 bearings. Automatic, even workpiece feed.

EQUIPMENT FEATURES

- Ideal for mobile use due to low weight
- Lateral depth stop adjustment
- Large table length
- Powerful universal motor for powerful lugging drive and even planing result
- Precise thickness adjustment for quick and exact planing
- Large supply and delivery tables support the conveyance of long materials; for ideal planing results
- Planing locking mechanism prevents unintentional adjustment of the chip removal setting and guarantees precise work results
- For single phase alternating current



DH 330



Bench Thicknesser DH 330	
Comparative device characteristics	
Dimensions L x W x H	579 x 857 x 574 mm
Chip removal	
- Thickness planing	0 - 3 mm
Material	
- Thickness table	Cast aluminium / special steel aluminium
Thickness table L x W	840 x 330 mm
Passage height/width	152 mm/330 mm
Feed rate	7 m/min
Diameter of blade shaft	47 mm
Number of blades	2
Blade shaft speed	9.800 /min
Rated input power	1,8 kW
Weight	35 kg
Standard equipment	2 integrated HSS reversible planer blades, push stick, extraction nozzle
Type	DH 330
Order no.	0200033000 0200033038 (GB) 230 V 0200033039 (GB) 110 V

SAWS

SPECIAL-PURPOSE MACHINES

SYSTEMATIC ORGANISATION

GARDEN

WOOD-PROCESSING TECHNOLOGY

WATER-/PUMP TECHNOLOGY

WELDING TECHNOLOGY

COMPRESSED AIR SYSTEMS

COMMON FEATURES

- For precise angular trimming of raw wood
- Sturdy feedgear mechanism
- Thickness table made of solid, non-abrasive grey cast iron
- Convenient height adjustment with crank handle
- Dressing plate made of cast aluminium
- Planer blade with double edge
- Trimming fence, swivelling 90°-45°
- Extensive range of accessories



HC 260 C -
2,2 WNB

HC 260 C -
2,8 DNB

	Planing Machine HC 260 C - 2,2 WNB	Planing Machine HC 260 C - 2,8 DNB
Special advantages		
■ Dustproof according to TRGS 553 by FPH		•
■ For single phase alternating current	•	
■ For three phase current		•
Comparative device characteristics		
Dimensions L x W x H	1.110 x 620 x 960 mm	1.110 x 620 x 960 mm
Dressing plates L x W	1.040 x 260 mm	1.090 x 260 mm
Chip removal		
- Planing	0 - 3 mm	0 - 3 mm
- Thickness planing	0 - 3 mm	0 - 3 mm
Material		
- Dressing plates	Cast aluminium	Cast aluminium
- Thickness table	Grey cast iron	Grey cast iron
Thickness table L x W	400 x 260 mm	400 x 260 mm
Passage height/width	160 mm/260 mm	160 mm/260 mm
Feed rate	5 m/min	5 m/min
Diameter of blade shaft	63 mm	63 mm
Number of blades	2	2
Blade shaft speed	6.500 /min	6.500 /min
Rated input power	2,2 kW	2,8 kW
Output power	1,6 kW	2 kW
Weight	71 kg	71 kg
Standard equipment	Integrated disposable reversible planer blades, short, swivelling jointing fence, chip ejection hood, push stick, extraction nozzle	Integrated disposable reversible planer blades, short, swivelling jointing fence, chip ejection hood, push stick, extraction nozzle
Type	HC 260 C - 2,2 WNB	HC 260 C - 2,8 DNB
Order no.	0114026000 0114026038 ^{GB} 230 V	0114026100

COMMON FEATURES

- High stability due to the powder-coated, closed machine stand
- Slot boring machine can be attached to the side (accessory)
- For precise angular trimming of raw wood
- Sturdy feedgear mechanism
- Thickness table with special steel support
- Convenient height adjustment with crank handle
- Dressing plate made of cast aluminium
- Trimming fence, swivelling 90°-45°
- Dustproof according to TRGS 553 by FPH
- Extensive range of accessories



HC 260 K - 3,1 WNB

HC 260 K - 4,2 DNB

	Planing Machine HC 260 K - 3,1 WNB	Planing Machine HC 260 K - 4,2 DNB
Special advantages	•	•
■ For single phase alternating current		
■ For three phase current		
Comparative device characteristics		
Dimensions L x W x H	1.090 x 540 x 410 mm	1.090 x 540 x 410 mm
Dressing plates L x W	1.090 x 260 mm	1.090 x 260 mm
Chip removal		
- Planing	0 - 3 mm	0 - 3 mm
- Thickness planing	0 - 4 mm	0 - 4 mm
Material		
- Dressing plates	Cast aluminium, hardened	Cast aluminium, hardened
- Thickness table	Cast aluminium / special steel aluminium	Cast aluminium / special steel aluminium
Thickness table L x W	400 x 260 mm	400 x 260 mm
Passage height/width	160 mm/260 mm	160 mm/260 mm
Feed rate	5 m/min	5 m/min
Diameter of blade shaft	63 mm	63 mm
Number of blades	2	2
Blade shaft speed	6.500 /min	6.500 /min
Rated input power	3,1 kW	4,2 kW
Output power	2 kW	2 kW
Weight	72 kg	72 kg
Standard equipment	2 integrated HSS reversible planer blades, short, swivelling jointing fence, chip ejection hood, push stick, extraction nozzle	2 integrated HSS reversible planer blades, short, swivelling jointing fence, chip ejection hood, push stick, extraction nozzle
Type	HC 260 K - 3,1 WNB	HC 260 K - 4,2 DNB
Order no.	0112026053	0112026061 0112026096 (mounted)

SAWS

SPECIAL-PURPOSE
MACHINES

SYSTEMATIC
ORGANISATION

GARDEN

WOOD-PROCESSING
TECHNOLOGY

WATER-/PUMP
TECHNOLOGY

WELDING
TECHNOLOGY

COMPRESSED
AIR SYSTEMS

COMMON FEATURES

- Anti-planer cut patent for ideal planing results (minimum feed and extraction levels on the workpiece)
- Robust machine housing for high stability and extensive vibration-free work
- Simple conversion from surface planer to bench thicknesser without tools
- Automatic, even workpiece feed
- Thickness table on four ball bearings
- Dressing plate made of coated, solid aluminium die cast for good guidance of long wood
- With lockable switch
- Sturdy support for safe work at ideal operating height
- For precise angular trimming of raw wood
- Thickness table made of solid, non-abrasive grey cast iron
- Convenient height adjustment with crank handle
- Planer blade with double edge
- Trimming fence, swivelling 90°-45°
- Dustproof according to TRGS 553 by FPH
- Extensive range of accessories



HC 300 W - 1,85 W

HC 300 D - 2,8 D

	Planing Machine HC 300 W - 1,85 W	Planing Machine HC 300 D - 2,8 D
Special advantages		
■ For single phase alternating current	•	
■ For three phase current		•
Comparative device characteristics		
Dimensions L x W x H	1.200 x 580 x 1.010 mm	1.200 x 580 x 1.010 mm
Working height	850 mm	850 mm
Dressing plates L x W	1.200 x 300 mm	1.200 x 300 mm
Chip removal		
- Planing	0 - 3 mm	0 - 3 mm
- Thickness planing	0 - 3 mm	0 - 3 mm
Material		
- Dressing plates	Cast aluminium	Cast aluminium
- Thickness table	Grey cast iron	Grey cast iron
Thickness table L x W	500 x 300 mm	500 x 300 mm
Passage height/width	165 mm/300 mm	165 mm/300 mm
Feed rate	5 m/min	5 m/min
Diameter of blade shaft	60 mm	60 mm
Number of blades	2	2
Blade shaft speed	6.000 /min	6.000 /min
Rated input power	1,85 kW	2,8 kW
Output power	1,3 kW	2,2 kW
Weight	85 kg	85 kg
Standard equipment	2 integrated HSS planer blades, gauge for setting the planer blades, large, swivelling jointing fence, chip ejection hood, push stick, extraction nozzle	2 integrated HSS planer blades, gauge for setting the planer blades, large, swivelling jointing fence, chip ejection hood, push stick, extraction nozzle
Type	HC 300 W - 1,85 W	HC 300 D - 2,8 D
Order no.	0113030000	0113030100

COMMON FEATURES

- Optimum draw-in rollers, rubber-coated extraction rollers for best contact pressure
- Four chrome-plated self-cleaning transport columns, on 8 ball bearings
- High own weight for excellent stability
- Dressing plate made of solid, non-abrasive grey cast iron
- Robust machine housing for high stability and extensive vibration-free work
- Simple conversion from surface planer to bench thicknesser without tools
- Automatic, even workpiece feed
- Thickness table on four ball bearings
- Sturdy support for safe work at ideal operating height
- Slot boring machine can be attached to the side (accessory)
- For precise angular trimming of raw wood
- Thickness table made of solid, non-abrasive grey cast iron
- Convenient height adjustment with crank handle
- Planer blade with double edge
- Trimming fence, swivelling 90°-45°
- Dustproof according to TRGS 553 by FPH
- Extensive range of accessories



HC 333 G - 2,5 WNB

HC 333 G - 2,8 DNB

	Planing Machine HC 333 G - 2,5 WNB	Planing Machine HC 333 G - 2,8 DNB
Special advantages	•	•
■ For single phase alternating current		
■ For three phase current		
Comparative device characteristics		
Dimensions L x W x H	1.240 x 560 x 1.010 mm	1.240 x 560 x 1.010 mm
Working height	850 mm	850 mm
Dressing plates L x W	1.240 x 340 mm	1.240 x 340 mm
Chip removal		
- Planing	0 - 3 mm	0 - 3 mm
- Thickness planing	0 - 3 mm	0 - 3 mm
Material		
- Dressing plates	Grey cast iron	Grey cast iron
- Thickness table	Grey cast iron	Grey cast iron
Thickness table L x W	550 x 310 mm	550 x 310 mm
Passage height/width	180 mm/307 mm	180 mm/307 mm
Feed rate	5 m/min	5 m/min
Diameter of blade shaft	64,5 mm	64,5 mm
Number of blades	2	2
Blade shaft speed	6.300 /min	6.300 /min
Rated input power	2,5 kW	2,8 kW
Output power	1,9 kW	2,2 kW
Weight	140 kg	140 kg
Standard equipment	2 integrated HSS reversible planer blades, large, swivelling jointing fence, gauge for setting the planer blades, chip ejection hood, push stick, extraction nozzle	2 integrated HSS reversible planer blades, large, swivelling jointing fence, gauge for setting the planer blades, chip ejection hood, push stick, extraction nozzle
Type	HC 333 G - 2,5 WNB	HC 333 G - 2,8 DNB
Order no.	0113033355 0113033363 (®) 230 V	0113033380

SAWS

SPECIAL-PURPOSE
MACHINES

SYSTEMATIC
ORGANISATION

GARDEN

WOOD-PROCESSING
TECHNOLOGY

WATER-/PUMP
TECHNOLOGY

WELDING
TECHNOLOGY

COMPRESSED
AIR SYSTEMS

EQUIPMENT FEATURES

- Powder-coated, sturdy and torsion-free welded construction
- Sturdy feedgear mechanism that can be shut off
- Swivelling switch terminal
- Guide shafts, drive shafts and screwed joints are protected against corrosion permanently by galvanised coating
- Thickness table made of grey cast iron; guided by central spindle
- Optimum draw-in rollers, rubber-coated extraction rollers for best contact pressure
- High own weight for excellent stability
- Dressing plate made of solid, non-abrasive grey cast iron
- Robust machine housing for high stability and extensive vibration-free work
- Simple conversion from surface planer to bench thicknesser without tools
- With lockable switch
- Sturdy support for safe work at ideal operating height
- Slot boring machine can be attached to the side (accessory)
- For precise angular trimming of raw wood
- Convenient height adjustment with crank handle
- Planer blade with double edge
- Trimming fence, swivelling 90°-45°
- Dustproof according to TRGS 553 by FPH
- Extensive range of accessories
- For three phase current



HC 410 G -
5,5 DNB

Planing Machine
HC 410 G - 5,5 DNB

Comparative device characteristics

Dimensions L x W x H	1.700 x 820 x 1.070 mm
Working height	850 mm
Dressing plates L x W	1.700 x 410 mm
Chip removal	
- Planing	0 - 5 mm
- Thickness planing	0 - 5 mm
Material	
- Dressing plates	Grey cast iron
- Thickness table	Grey cast iron
Thickness table L x W	670 x 405 mm
Passage height/width	230 mm/405 mm
Feed rate	7 m/min
Diameter of blade shaft	82 mm
Number of blades	3
Blade shaft speed	5.500 /min
Rated input power	5,5 kW
Output power	3,2 kW
Weight	250 kg

Standard equipment

3 integrated planer blades, gauge for setting the planer blades, phase inverter, large, swivelling jointing fence, chip ejection hood, push stick, extraction nozzle

Type
Bestell-Nr.

HC 410 G - 5,5 DNB
0113041013

Planer blades				
Dimensions mm	Reversible planer blades	Suitable for	Packing unit	Order no.
HSS planer blade				
<ul style="list-style-type: none"> For all soft woods and hard woods Regrindable 18% tungsten = increased tool life 				
332 x 12 x 1,5	•	DH 330, DH 316		0911063549
334 x 16 x 2	•	DH 330	2	0911062119
260 x 20 x 3		HC 260 C ²⁾ , HC 260 M ²⁾ , HC 260 K ¹⁾	2	0911030721
304 x 25 x 3		HC 300	2	0911060167 ¹⁾
310 x 20 x 3		HC 333 G	2	0911053179 ¹⁾
410 x 25 x 3		HC 410 G	3	0911050390 ¹⁾
410 x 14 x 2,55	•	HC 410 G	3	0911051150
Disposable reversible planer blades				
<ul style="list-style-type: none"> For all soft woods 				
260 x 18,6 x 1	•	HC 260 C ¹⁾ , HC 260 M ¹⁾ , HC 260 K	2	0911030713
Carbide planer blade				
<ul style="list-style-type: none"> For all hard woods, especially exotic woods, laminated wood, hard paper, fabric reinforced laminates Panel materials and plastics Regrindable, long tool life 				
260 x 20 x 3		HC 260 C ²⁾ , HC 260 M ²⁾ , HC 260 K ¹⁾	2	0911030730
304 x 25 x 3		HC 300	2	0911060175
310 x 20 x 3		HC 333 G	2	0911053160
410 x 25 x 3		HC 410 G	3	0911050366
Planer blade and retaining strip conversion set				
260		HC 260 C, HC 260 M	2	0911030845

¹⁾ Standard equipment of the planing machines



²⁾ Also requires planer blade and retaining strip conversion set 0911030845

Planer blade adjusting devices		Order no.
	Planer blade adjusting device <ul style="list-style-type: none"> Suitable for all blade shafts Simple handling and exact cutter projection In wooden case Scope of delivery: 2 magnet planer blade adjusting devices, 3 setting plates for blade excess length Not suitable for: HC 310	0911016397

ACCESSORIES FOR DH 330

	Order no.	
	Universal machine stand <ul style="list-style-type: none"> For ideal working height and secure base Can also be used on uneven surfaces Collapsible, with height compensation 	0910057529

ACCESSORIES FOR HC 260 C, HC 260 K, HC 260 M

	Order no.	
	Wheel set <ul style="list-style-type: none"> For easy transportation Suitable for: HC 260 C, HC 260 M	0911003783
	Wheel set <ul style="list-style-type: none"> For easy transportation Suitable for: HC 260 K	0911007100

	Order no.	
	Slot boring machine <ul style="list-style-type: none"> For the moulding/routing of peg holes and oblong holes For oblong holes up to 60 mm deep and 125 mm long With 2 hand lever operation for longitudinal and transverse motion Including geared chuck, extraction nozzle and 1 clamping device Clamping table: 400 x 130 mm Working height: 800 mm Length adjustment: 125 mm Drilling depth: 60 mm Height adjustment: 130 mm Chuck capacity: 1 - 10 mm Extraction nozzle Ø: 100 mm Suitable for: HC 260 M, HC 260 K	0911003791
	Eccentric clamping device without stand <ul style="list-style-type: none"> For clamping the workpiece 	0910009680
	Clamping stand for slot boring machine Required for mounting the eccentric clamping device Ø 20x200mm thread M 20x1.5mm Suitable for: HC 260 M, HC 260 K	0911009811
	Mortising bit set <ul style="list-style-type: none"> All mortising bits can be clamped in the geared chuck With two straight cutters and chip breaker grooves Right-hand cutting Ø 6, 8, 10 and 12 mm Packing unit: 4 Suitable for: HC 260 M, HC 260 K	0911030497

ACCESSORY FOR HC 300

	Order no.	
	Wheel set <ul style="list-style-type: none"> For easy transportation 	0911060205

ACCESSORIES FOR HC 333 G

	Order no.	
	Wheel set <ul style="list-style-type: none"> For easy transportation 	0911053195
	Table length extension <ul style="list-style-type: none"> For the secure supporting of long workpieces With height adjustable support leg and auxiliary fence rail Eccentric clamp - easy to mount and dismount Front/rear mounting on the base support system HC 333: Mounting possible on both sides of the dressing plates Length: 1.000 mm Width: 200 mm	0910018469
	Auxiliary fence/stop <ul style="list-style-type: none"> For precise guiding with narrow workpieces Collapsible	0911053594

SAWS

SPECIAL-PURPOSE MACHINES

SYSTEMATIC ORGANISATION

GARDEN

WOOD-PROCESSING TECHNOLOGY

WATER-/PUMP TECHNOLOGY

WELDING TECHNOLOGY

COMPRESSED AIR SYSTEMS

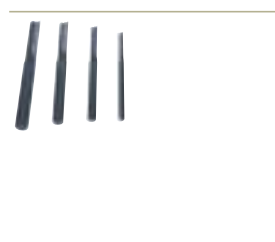





	<p>Order no. 0911053187</p> <p>Slot boring machine</p> <ul style="list-style-type: none"> For the moulding/routing of peg holes and oblong holes With 1 hand lever operation for longitudinal and transverse motion Rapid mounting and dismounting via two eccentric levers Separate height adjustment <p>Including geared chuck, clamping device and mounting set Clamping table: 300 x 150 mm Working height: 810 mm Length adjustment: 110 mm Drilling depth: 110 mm Height adjustment: 110 mm Chuck capacity: 1 - 14 mm Extraction nozzle Ø: 100 mm Suitable for: HC 333 G</p>
	<p>Order no. 0911030497</p> <p>Mortising bit set</p> <ul style="list-style-type: none"> All mortising bits can be clamped in the geared chuck With two straight cutters and chip breaker grooves Right-hand cutting <p>Ø 6, 8, 10 and 12 mm Packing unit: 4</p>

ACCESSORIES FOR HC 410 G

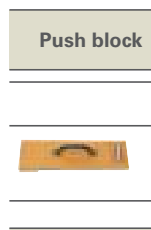
	<p>Order no. 0911014203</p> <p>wheel set</p> <ul style="list-style-type: none"> For easy transportation <p>With 2 steering rollers and 2 support rollers</p>
	<p>Order no. 0911013983</p> <p>Digital display</p> <ul style="list-style-type: none"> The display clock enables you to set and read the height with a precision up to a tenth of a millimetre when thickness planing <p>Suitable for: HC 320 up to model year 99, HC 410 G</p>
	<p>Order no. 0911014211</p> <p>Slot boring machine</p> <ul style="list-style-type: none"> For the moulding /routing of peg holes and oblong holes For oblong holes up to 120 mm deep and 200 mm long With 1 hand lever operation for longitudinal and transverse motion Separate height adjustment <p>Including geared chuck, clamping device and mounting set Clamping table: 400 x 190 mm Working height: 870 mm Length adjustment: 200 mm Drilling depth: 120 mm Height adjustment: 120 mm Chuck capacity: 2,5 - 16 mm Extraction nozzle Ø: 100 mm Suitable for: HC 314 up to model year 99, HC 320 up to model year 99, HC 410 G</p>

<p>Mortising bits</p>  <ul style="list-style-type: none"> All mortising bits can be clamped in the geared chuck With two straight cutters and chip breaker grooves Right-hand cutting 		
<p>Length mm</p> <p>130 140 150 150 170</p>	<p>Diameter mm</p> <p>8 10 12 14 16</p>	<p>Order no.</p> <p>0911014394 0911014408 0911014416 0911014424 0911014432</p>

OTHER ACCESSORIES FOR THE PLANING MACHINES

<p>Push block</p>  <p>Order no. 0911060213</p> <p>Push block</p> <ul style="list-style-type: none"> For the safe feed of short workpieces while planing 		
<p>Roller stands</p> <ul style="list-style-type: none"> For supporting long workpieces when sawing, moulding/routing, planing and drilling Sturdy, height-adjustable and foldable 		
	<p>Order no. 0910053353</p> <p>RS 420</p> <p>With smooth-rolling special steel rollers with a high load capacity Width: 400 mm Base weight: 100 kg Height: 640 - 1.015 mm</p>	
	<p>Order no. 0910053345</p> <p>RS 420 G</p> <p>With smooth-rolling chromium-plated ball bearings Also permits lateral movements Ideal for panel material Width: 520 mm Base weight: 100 kg Height: 640 - 1.015 mm</p>	
	<p>Order no. 0910053361</p> <p>RS 420 W</p> <p>With smooth-rolling chromium-plated ball bearings Adjustable ball bearing gib Also permits lateral movements Ideal for panel material, round or square workpieces Width: 420 mm Base weight: 100 kg Height: 640 - 1.015 mm</p>	
<p>Anti seize paste</p> <ul style="list-style-type: none"> To help the wood slide well on the dressing plate and the thickness table 		
	<p>Order no. 0911001071</p> <p>Waxilit 70 g Weight: 70 g</p>	
	<p>Order no. 4313062258</p> <p>Waxilit 1,000 g Weight: 1 kg</p>	
<p>Spray for maintenance and care</p> <p>Order no. 0911018691</p>		

ALL IN ONE.

Metabo combo-machines can do just everything. You can use them as table saw, surface planer, bench thicknesser, spindle moulder or for mortising. But best of all: conversion from one function to the next is possible quickly without any tools. Is there anything else you need?

e.g. Multi 260 S

Large spindle moulder fence
fence with aluminium die cast pressing fixture.

Sturdy table-top
made of sheet steel.

Infinitely variable height adjustment
during thickness planing.

Lockable main switch.

Trimming slide on ball bearings;
ideal for cutting head boards.

Large rip or planer fence
with aluminium die cast pressing fixture.

Welded machine stand
for maximum precision and stability.



Multi 260 S as table saw with standard carbide-tipped saw blade and trimming slide.



Multi 260 S as surface planing and thickness planing device or as spindle moulder with mortising device.



The fence with clamp for firm grip.

SAWS

SPECIAL-PURPOSE MACHINES

SYSTEMATIC ORGANISATION

GARDEN

WOOD-PROCESSING TECHNOLOGY

WATER-/PUMP TECHNOLOGY

WELDING TECHNOLOGY

COMPRESSED AIR SYSTEMS

COMMON FEATURES

- Five-in-one combo-machines: can be used as table saw, surface planer, bench thicknesser, as bench milling cutter and for mortising (with accessory)
- Easy conversion of various units without special tool
- Infinitely variable height adjustment while thickness planing, steel-corrugated extraction roller
- Lockable main switch
- Large adjustable fence with pressure appliance made of sturdy aluminium die cast.
- Sturdy sheet steel table-top, grey cast iron thickness table
- Max. tool diameter in the adjustable fence 180 mm, in the table 150 mm
- Trimming slide on ball bearing - ideal for moulding/routing head boards
- Slot boring machine can be attached to the side (accessory)
- With extensive range of accessories for versatile use



MULTI 260 S - D

MULTI 260 S - D

	Combo-Machine MULTI 260 S - W	Combo-Machine MULTI 260 S - D
Special advantages		
■ For single phase alternating current	•	
■ For three phase current		•
Comparative device characteristics		
As table saw		
Table size	1.040 x 400 mm	1.040 x 400 mm
Cutting height 90/45°	90 mm/58 mm	90 mm/58 mm
Saw blade swivel range	0 - 45 °	0 - 45 °
Maximum cutting width	420 mm	420 mm
Speed	4.600 /min	4.600 /min
Cutting speed	60 m/s	60 m/s
Sliding table	1.080 x 140 mm	1.080 x 140 mm
- Cross-cut guide, length	800 mm	800 mm
- Swivel range, cross-cut guide (right/left)	45 °/45 °	45 °/45 °
- Cutting width in front of/behind saw blade	720/1.250 mm	720/1.250 mm
As surface planer		
Table length	1.040 mm	1.040 mm
Planing width	260 mm	260 mm
Max. chip removal	4 mm	4 mm
Shaft diameter	62 mm	62 mm
Shaft speed	6.300 /min	6.300 /min
As bench thicknesser		
Thickness table L x W	590 x 260 mm	590 x 260 mm
Passage height/width	150 mm/260 mm	150 mm/260 mm
Max. chip removal	4 mm	4 mm
Feed rate	7 m/min	7 m/min
As spindle moulder		
Spindle speed	4.300/8.500 /min	4.300/8.500 /min
Diameter of spindle	30 mm	30 mm
Spindle height adjustment (maximum)	125 mm	125 mm
Dimensions L x W x H	1.080 x 880 x 850 mm	1.080 x 880 x 850 mm
Rated input power	2,2 kW	2,2 kW
Output power	1,5 kW	1,5 kW
Weight	166 kg	166 kg
Standard equipment	HSS planer blade (regrindable), carbide saw blade Ø 250 mm, trimming slide on ball bearing, extraction nozzle Ø 100 mm, wheel set	HSS planer blade (regrindable), carbide saw blade Ø 250 mm, trimming slide on ball bearing, extraction nozzle Ø 100 mm, wheel set
Type	MULTI 260 S - W	MULTI 260 S - D
Order no.	0290026008	0290026016

COMMON FEATURES

- Five-in-one combo-machines: can be used as table saw, surface planer, bench thicknesser, as bench milling cutter and for mortising (with accessory)
- Easy conversion of various units without special tool
- Infinitely variable height adjustment while thickness planing, steel-corrugated extraction roller
- Three motors with powerful lugging capacity
- Lockable selector switch for all three motors
- Maximum work safety by additional safety end switch
- Heavy die cast iron table-tops
- Max. tool diameter in the adjustable fence 180 mm, in the table 150 mm
- Trimming slide on ball bearing - ideal for moulding/routing head boards
- Trimming slides with sturdy swivel arm base
- Slot boring machine can be attached to the side (accessory)
- With extensive range of accessories for versatile use



MULTI 310 G - W

MULTI 310 G - D

	Combo-Machine MULTI 310 G - W	Combo-Machine MULTI 310 G - D
Special advantages		
■ For single phase alternating current	•	
■ For three phase current		•
Comparative device characteristics		
As table saw		
Table size	1.080 x 435 mm	1.080 x 435 mm
Cutting height 90/45°	82 mm/56 mm	82 mm/56 mm
Saw blade swivel range	0 - 45 °	0 - 45 °
Maximum cutting width	450 mm	450 mm
Speed	4.200 /min	4.200 /min
Cutting speed	54 m/s	54 m/s
Sliding table	1.080 x 140 mm	1.080 x 140 mm
- Cross-cut guide, length	800 mm	800 mm
- Swivel range, cross-cut guide (right/left)	45 °/45 °	45 °/45 °
- Cutting width in front of/behind saw blade	680/1.250 mm	680/1.250 mm
As surface planer		
Table length	1.400 mm	1.400 mm
Planing width	310 mm	310 mm
Max. chip removal	4 mm	4 mm
Shaft diameter	62 mm	62 mm
Shaft speed	6.200 /min	6.200 /min
As bench thicknesser		
Thickness table L x W	550 x 310 mm	550 x 310 mm
Passage height/width	200 mm/310 mm	200 mm/310 mm
Max. chip removal	5 mm	5 mm
Feed rate	7,5 m/min	7,5 m/min
As spindle moulder		
Spindle speed	4.300/6.750/8.500 /min	4.300/6.750/8.500 /min
Diameter of spindle	30 mm	30 mm
Spindle height adjustment (maximum)	130 mm	130 mm
Dimensions L x W x H	1.400 x 890 x 890 mm	1.400 x 890 x 890 mm
Rated input power	2,6 kW	2,8 kW
Output power	1,8 kW	2,2 kW
Weight	355 kg	355 kg
Standard equipment	HSS planer blade (regrindable), carbide saw blade Ø 250 mm, trimming slide on ball bearing, extraction nozzle Ø 100 mm	HSS planer blade (regrindable), carbide saw blade Ø 250 mm, trimming slide on ball bearing, extraction nozzle Ø 100 mm
Type	MULTI 310 G - W	MULTI 310 G - D
Order no.	0290031001	0290031010

SAWS

SPECIAL-PURPOSE
MACHINESSYSTEMATIC
ORGANISATION

GARDEN

WOOD-PROCESSING
TECHNOLOGYWATER-/PUMP
TECHNOLOGYWELDING
TECHNOLOGYCOMPRESSED
AIR SYSTEMS

ACCESSORIES FOR THE COMBO-MACHINES





Wheel sets		Order no.
	Wheel set <ul style="list-style-type: none"> For easy transportation Suitable for: Multi 310 	0920054102

Table length extensions		Order no.
	Table length extension <ul style="list-style-type: none"> For the secure supporting of long workpieces With height-adjustable support leg Eccentric clamp: easy to mount and dismount Can be mounted at the front or the rear Suitable for: Multi 260 Length: 1.000 mm Width: 150 mm	0920053947

FOR SAWING

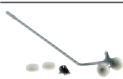
Sliding table width extensions		Order no.
	Sliding table width extension <ul style="list-style-type: none"> For enlarging the supporting surface Mounted and dismounted without tools Length: 350 mm Width: 262 mm	0920054072

Length guides		Order no.
	Length guide <ul style="list-style-type: none"> For use with the cross-cut guide of the sliding table Enables the cutting to length of workpieces of up to 1,700 mm Extractable Length 1,100 mm 	0920054110

Circular saw blades

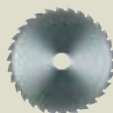

- Top cutting results thanks to teeth ground on all sides and high accuracy of flatness and concentric running
- Tungsten carbide blades: long tool life thanks to use of unmixed carbide
- Can be reground repeatedly
- Made in Germany

Material	Dimensions mm	Tooth pitch	Version	Order no.
Tungsten carbide	250 x 2,8 x 30	24	Alternately bevel-ground tips	6.28012
Tungsten carbide	250 x 2,8 x 30	34	Alternately bevel-ground tips, Combo secondary hole holder	6.28045
Tungsten carbide	250 x 2,8 x 30	42	Alternately bevel-ground tips, Combo secondary hole holder	6.28046
Tungsten carbide	250 x 2,8 x 30	60	Alternately bevel-ground tips, Combo secondary hole holder	6.28049
Tungsten carbide	250 x 3,2 x 30	60	Alternately bevel-ground tips, Combo secondary hole holder	6.28050
Tungsten carbide	250 x 2,8 x 30	80	Alternately bevel-ground tips, Combo secondary hole holder	6.28087
Tungsten carbide	250 x 2,8 x 30	80	Flat tooth/ trapezoidal tooth, 5° negative	6.28088

FOR PLANING

HSS planer blade

- For all soft woods and hard woods
- Regrindable
- 18% tungsten = increased tool life

Dimensions mm	Suitable for	Packing unit	Order no.
260 x 20 x 2,5	Multi 260	2	0920054030
310 x 20 x 2,5	Multi 310	2	0920054048

Planer blade adjusting devices

Order no.
0911016397



Planer blade adjusting device

- Suitable for all blade shafts
- Simple handling and exact cutter projection
- In wooden case

Scope of delivery:
 2 magnet planer blade adjusting devices,
 3 setting plates for blade excess length

Order no.
0911060213





Push block

- For the safe feed of short workpieces while planing

Anti seize paste <ul style="list-style-type: none"> To help the wood slide well on the dressing plate and the thickness table 		
		Order no.
	Waxilit - anti seize paste <ul style="list-style-type: none"> To help the wood slide well on the dressing plate and the thickness table Weight: 70 g	0911001071
	Waxilit - anti seize paste <ul style="list-style-type: none"> To help the wood slide well on the dressing plate and the thickness table Weight: 1 kg	4313062258

FOR MOULDING/ROUTING

Tenon benches		
		Order no.
	Tenon bench <ul style="list-style-type: none"> Prevents the workpiece from being pulled from the router bit into the housing Particularly when moulding/routing short chocks Support surface: 440 x 150 mm	0920054080
Arc milling fences		
		Order no.
	Arc moulding guide <ul style="list-style-type: none"> Enables the moulding/routing of curved and similarly shaped workpieces Suction connection Ø 100 mm Including arc milling fence	0920054099

Carbide straight bit		
	<ul style="list-style-type: none"> For grooving all kinds of wood and panel materials Carbide-tipped straight bit Groove depth max. 25 mm PA-wood tested 	

Groove width mm	Diameter mm	Bore mm	Order no.
4	100	30	0914031095
6	100	30	0914031117
8	100	30	0914031125
10	100	30	0914031133
12	100	30	0914031141
14	100	30	0914031150
16	100	30	0914031168
18	100	30	0914031176
20	100	30	0914031184

FOR MORTISING

Slot boring machines		
		Order no.
	Slot boring machine <ul style="list-style-type: none"> For the moulding/routing of peg holes and oblong holes With one-hand lever operation for longitudinal and transverse motion Including geared chuck and clamping device Clamping table: 300 x 150 mm Working height: 830 mm Length adjustment: 110 mm Drilling depth: 110 mm Height adjustment: 80 mm Chuck capacity: 2 - 14 mm Extraction nozzle Ø: 100 mm Suitable for: Multi 260	0920054056
	Slot boring machine <ul style="list-style-type: none"> For the moulding/routing of peg holes and oblong holes With one-hand lever operation for longitudinal and transverse motion Rapid attachment and removal via two eccentric levers Separate height adjustment Including geared chuck, clamping device and mounting set Clamping table: 300 x 150 mm Working height: 810 mm Length adjustment: 110 mm Drilling depth: 110 mm Height adjustment: 110 mm Chuck capacity: 2 - 14 mm Extraction nozzle Ø: 100 mm Suitable for: Multi 310	0920054064

Mortising bits		
<ul style="list-style-type: none"> All mortising bits can be clamped in the geared chuck With two straight cutters and chip breaker grooves Left-hand cutting 		

Length mm	Diameter mm	Packing unit	Order no.
150	14	1	0911055830
160	16	1	0911055848

Mortising bit sets		
<ul style="list-style-type: none"> All mortising bits can be clamped in the geared chuck With two straight cutters and chip breaker grooves Left-hand cutting 		

	Mortising bit set Consisting of mortising bits Ø 6, 8, 10 and 12 mm (1 each)	Order no. 0911055821
--	--	--------------------------------

SAWS

SPECIAL-PURPOSE MACHINES

SYSTEMATIC ORGANISATION

GARDEN

WOOD-PROCESSING TECHNOLOGY

WATER-/PUMP TECHNOLOGY

WELDING TECHNOLOGY

COMPRESSED AIR SYSTEMS

CUTTING EDGE PRECISION.

A Metabo band saw provides you with top features that nobody else can offer. Whether you make models, small pieces of furniture or whether you are interested in professional applications, a Metabo band saw is always the right choice. All of our band saws are equipped with precision three-pulley guides, have sturdy, low-vibration

grey cast iron tables and high quality length stops that enable clean and precise working, whatever you are doing. Safety limit switches, blade clamp indicators and quick-release levers offer more safety but also more comfortable working.

e.g. BAS 317 Precision

Safety cut out switch
Immediate shut down when a door is opened.

Professional parallel stop
With eccentric clamping and exact scale with built-in magnifying glass. Can be used on both sides of the saw blade.



"Sawdust-tested"
in compliance with TRGS 553 by FPH



Quick-action lever
Simple adjustment of the blade tension by hand wheel. Indicator for the fast reading of the blade tension.

Precision three-pulley guide
For optimum guidance and long service life of the band saw blade.

Torsion-resistant grey cast iron saw table
For more precision and at the same time less vibrations. Convenient angle adjustment from -2° to 45° by soft handle and patented toothed ring guide.



High precision operation
with maximum operating comfort. Best cutting results are no coincidence. Metabo. Work. Don't play.



By shifting the V-belts to the lower roller box, four different speeds can be preset for ideal adjustment to the material to be cut.



High stability
The combination of torsion-resistant grey cast iron table and professional belt guide is the basis for ideal cutting results in wood, plastic or nonferrous metal for the professional.

EQUIPMENT FEATURES

- Door opening without tools; protection by safety end switches
- Light saw blade guard stop via hand wheel
- Precision three-pulley guide with HPHSS rollers and brass counter nuts; adjustable without tools
- Parallel guide/ripping fence with long profile, clamped at the front. Can be used on both sides, with built-in magnifier
- Mitre guide with soft handle and improved T-slot guide, for optimum grip while working
- Radius cutting with circle sawing attachment (accessory)
- Large cutting height with height indicator

- Sturdy design due to steel sheet construction
- Large swivelling grey cast iron saw table
- Simple and easy-to-use table fixing via large thumb screw
- Suction adapter for all conventional Metabo suction hose diameters
- Support base for optimum stability
- Large range of accessories
- For single phase alternating current



BAS 260 Swift

ACCESSORIES FOR BAS 260 SWIFT

Circle cutting attachments		Order no.
	Circle cutting attachment <ul style="list-style-type: none"> ■ For circular cuts or tapered cuts (with inclined table) ■ Diameter from 120 to 280 mm 	0909031249
	Band saw blade 6 mm required for curve sawing	

	Band Saw BAS 260 Swift
Comparative device characteristics	
Dimensions L x W x H	525 x 425 x 840 mm
Support surface	340 x 335 mm
Working height without stand	374 mm
Working height with stand	
Saw tabel swivel range	0 - 45 °
Cutting height	100 mm
Passage width	245 mm
Cutting speed	690 m/min
Saw belt length	1.712 mm
Saw belt width	6,4 - 12,7 mm
Rated input power	0,35 kW
Output power	0,26 kW
Weight	32,5 kg
Standard equipment	A6 universal band saw blade, support base, parallel guide/ripping fence, mitre guide, precision three-pulley guide, suction adapter (suitable for Ø 44, 58, 100 mm)
Type	BAS 260 Swift
Order no.	0090025100 0090025138 (GB) 230 V



SAWS

SPECIAL-PURPOSE MACHINES

SYSTEMATIC ORGANISATION

GARDEN

WOOD-PROCESSING TECHNOLOGY

WATER-/PUMP TECHNOLOGY

WELDING TECHNOLOGY

COMPRESSED AIR SYSTEMS

COMMON FEATURES

- High precision and cutting output
- Two cutting speeds for various applications and materials
- Quick-release lever for quick saw blade change and easy conversion to belt grinder
- Door opening without tools; protection by safety end switches
- Light saw blade guard stop via hand wheel
- Blade clamp indicator with scale for easy reading of actual blade tension
- Precision three-pulley guide with HPHSS rollers and brass counter nuts; adjustable without tools
- Parallel guide/ripping fence with long profile, clamped at the back and front. Can be used on both sides, with built-in magnifier
- Mitre guide with soft handle and improved T-slot guide, for optimum grip while working
- Radius cutting with circle sawing attachment (accessory)
- GS dustproof
- Large cutting height with height indicator
- Sturdy design due to steel sheet construction
- Comfortable and precise angle adjustment of saw table from -2° to 45° due to soft handle and patented toothed ring guide
- Suction adapter for all conventional Metabo suction hose diameters
- Large range of accessories



**BAS 317
Precision WNB**



**BAS 317
Precision DNB**

	Band Saw BAS 317 Precision WNB	Band Saw BAS 317 Precision DNB
Special advantages	•	•
<ul style="list-style-type: none"> ■ For single phase alternating current ■ For three phase current 		
Comparative device characteristics		
Dimensions L x W x H	665 x 795 x 1.600 mm	665 x 795 x 1.600 mm
Support surface	548 x 400 mm	548 x 400 mm
Working height		
Working height without stand	510 mm	510 mm
Working height with stand	985 mm	985 mm
Saw tabel swivel range	-2 - 45 °	-2 - 45 °
Cutting height	165 mm	165 mm
Passage width	305 mm	305 mm
Cutting speed	370/800 m/min	370/800 m/min
Saw belt length	2.240 mm	2.240 mm
Saw belt width	6 - 20 mm	6 - 20 mm
Rated input power	0,9 kW	0,9 kW
Output power	0,57 kW	0,64 kW
Weight	70,5 kg	72 kg
Standard equipment	A6 universal band saw blade, stand, parallel guide/ripping fence, mitre guide, precision three-pulley guide, suction adapter (suitable for Ø 44, 58, 100 mm)	A6 universal band saw blade, stand, parallel guide/ripping fence, mitre guide, precision three-pulley guide, suction adapter (suitable for Ø 44, 58, 100 mm)
Type	BAS 317 Precision WNB	BAS 317 Precision DNB
Order no.	0090317000 0090317038 (GB) 230 V	0090317100

COMMON FEATURES

- High precision and cutting output
- Asynchronous motor - sturdy, durable and low-noise
- Integrated disc sanding function; ideal for regrinding
- Sanding disc bench can be inclined up to 45°
- Quick sandpaper change due to Velcro-faced surface
- Sturdy parallel guide/ripping fence
- Radius cutting with circle sawing attachment (accessory)
- GS dustproof
- Large capacity for wide workpieces but still with compact machine dimensions
- Grey cast iron base for high stability and quiet running, with levelling option and assembly bores for stand
- Sturdy construction due to heavily ribbed aluminium die cast housing
- Sturdy saw table made of die cast aluminium, swivelling
- Large range of accessories



BAS 380 W

BAS 380 D

	Band Saw BAS 380 W	Band Saw BAS 380 D
Special advantages		
■ For single phase alternating current	•	
■ For three phase current		•
Comparative device characteristics		
Dimensions L x W x H	510 x 900 x 920 mm	510 x 900 x 920 mm
Support surface	600 x 400 mm	600 x 400 mm
Working height		
Working height without stand	360 mm	360 mm
Working height with stand	988 mm	988 mm
Saw table swivel range	-2 - 45°	-2 - 45°
Cutting height	160 mm	160 mm
Passage width	380 mm	380 mm
Cutting speed	910 m/min	910 m/min
Saw belt length	2.225 mm	2.225 mm
Saw belt width	3 - 13 mm	3 - 13 mm
Speed of grinding plate	1.450 /min	1.450 /min
Dimensions of the grinding table-top	168 x 413 mm	168 x 413 mm
Grinding plate Ø	200 mm	200 mm
Grinding table swivel range	-2 - 45°	-2 - 45°
Rated input power	0,74 kW	0,74 kW
Output power	0,5 kW	0,5 kW
Weight	45 kg	45 kg
Standard equipment	A6 universal band saw blade, parallel guide/ripping fence, mitre guide, extraction nozzle (Ø 100 mm)	A6 universal band saw blade, parallel guide/ripping fence, mitre guide, extraction nozzle (Ø 100 mm)
Type	BAS 380 W	BAS 380 D
Order no.	0090380000	0090380100

SAWS

SPECIAL-PURPOSE
MACHINES

SYSTEMATIC
ORGANISATION

GARDEN

WOOD-PROCESSING
TECHNOLOGY

WATER-/PUMP
TECHNOLOGY

WELDING
TECHNOLOGY

COMPRESSED
AIR SYSTEMS

COMMON FEATURES

- High precision and stability for professional applications
- High precision and cutting output
- Four cutting speeds for various applications and materials
- Door opening without tools; protection by safety end switches
- Light saw blade guard stop via hand wheel
- Blade clamp indicator with scale for easy reading of actual blade tension
- Precision three-pulley guide with HPHSS rollers and brass counter nuts; adjustable without tools
- Large counterbalanced band saw rollers, rubber coated
- Sturdy parallel guide/ripping fence
- Radius cutting with circle sawing attachment (accessory)
- GS dustproof
- Large cutting height with height indicator
- Sturdy design due to steel sheet construction
- Grey cast iron saw table according to DIN EN 1807, infinitely swivellable by up to 20°
- Large swivelling grey cast iron saw table
- Large range of accessories



BAS 505 G WNB



BAS 505 G DNB

	Band Saw BAS 505 G WNB	Band Saw BAS 505 G DNB
Special advantages		
▪ For single phase alternating current	•	
▪ For three phase current		•
Comparative device characteristics		
Dimensions L x W x H	834 x 639 x 1.860 mm	834 x 639 x 1.860 mm
Support surface	536 x 640 mm	536 x 640 mm
Working height without stand	925 mm	925 mm
Saw tabel swivel range	0 - 20 °	0 - 20 °
Cutting height	280 mm	280 mm
Passage width	440 mm	440 mm
Cutting speed	68/176/375/967 m/min	68/176/375/967 m/min
Saw belt length	3.380 mm	3.380 mm
Saw belt width	6 - 25 mm	6 - 25 mm
Rated input power	1,5 kW	1,9 kW
Output power	1,1 kW	1,5 kW
Weight	146 kg	146 kg
Standard equipment	A6 universal band saw blade, parallel guide/ ripping fence, precision three-pulley guide, extraction nozzle (Ø 100 mm)	A6 universal band saw blade, parallel guide/ ripping fence, precision three-pulley guide, extraction nozzle (Ø 100 mm)
Type	BAS 505 G WNB	BAS 505 G DNB
Order no.	0090505000 0090505038 (GB) 230 V	0090505100

ACCESSORIES FOR BAS 317 PRECISION

Wheel Sets



Wheel set

- For easy transportation

Suitable for:
BAS 317 Precision

Order no. 0910063570

Circle cutting attachments



Circle cutting attachment

- For circular cuts or tapered cuts (with inclined table)
- Diameter from 120 to 280 mm

Band saw blade 6 mm required for curve sawing

Order no. 0909031249

Belt sanding attachment



Belt sanding attachment

- For regrounding surfaces and curved sawing cuts

Comes with two sanding belts

Order no. 0909031230

Cloth sanding belts

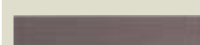

Grit	Dimensions mm	Packing unit	Order no.
P 80	20 x 2.240	3	0909030528
P 120	20 x 2.240	3	0909030536

ACCESSORIES FOR BAS 380

Stands



Stand

- For ideal working height and secure base
- With rollers and level compensation

Working height: 988 mm

Order no. 0909060222

Fine sawing attachments



Fine sawing attachment

- For the sawing of small radii

3 mm band saw blade required (order no. 0909060257)

Order no. 0909060230

Circle cutting attachments



Circle saw attachment

- For circular cuts or tapered cuts (with inclined table)
- Diameter from 80 to 240 mm

Band saw blade required for curve sawing

Order no. 0909060249

Cloth sanding belts

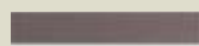

Grit	Dimensions mm	Packing unit	Order no.
P 60	20 x 2.205	3	0909060290
P 80	20 x 2.205	3	0909060303
P 100	20 x 2.205	3	0909060311
P 150	20 x 2.205	3	0909060320

Cling-fit sanding sheets



Grit	Diameter mm	Packing unit	Order no.
P 60	200	5	0909060338
P 80	200	5	0909060346
P 100	200	5	0909060354

ACCESSORIES FOR BAS 505 G

Wheel Sets



Wheel set

- For easy transportation

Consisting of:
2 wheels, fastening elements and handle bar

Order no. 0909000505

Mitre guides



Mitre guide

- For precise cross cuts and angular cuts
- With workpiece bearing made of aluminium
- Infinitely variable, both sides adjustable, 90°-45°

Order no. 0910008048

SAWS

SPECIAL-PURPOSE MACHINES

SYSTEMATIC ORGANISATION

GARDEN

WOOD-PROCESSING TECHNOLOGY

WATER-/PUMP TECHNOLOGY

WELDING TECHNOLOGY

COMPRESSED AIR SYSTEMS

Circle cutting attachments



Circle cutting attachment

- For circular cuts or tapered cuts (with inclined table)
 - Diameter from 120 to 280 mm
- Band saw blade 6 mm required for curve sawing

Order no.

0909031249

Belt sanding attachment



Belt sanding attachment

- For regrinding surfaces and curved sawing cuts
- Comes with two sanding belts

Order no.

0909031087

Cloth sanding belts



Grit	Dimensions mm	Packing unit	Order no.
P 80	25 x 3.380	3	0909030544
P 120	25 x 3.380	3	0909030552

Band saw blades

- Carbon steel with inductively hardened teeth points
- Very economical due to its long useful life

Dimensions mm	Tooth pitch	Material suitability	Order no.
For BAS 260 Swift			
1.712 x 6 x 0,36	A4 helical tooth	Wood, plastic – curve cuts	0909057175
1.712 x 12 x 0,36	A6 peg tooth	Wood, plastic – universal cuts	0909057183
1.712 x 12 x 0,36	A2 rake tooth	Non-ferrous metal, foamed materials	0909057191
For BAS 317 Precision			
2.240 x 6 x 0,5	A4 helical tooth	Wood, plastic – curve cuts	0909029252
2.240 x 12 x 0,5	A6 peg tooth	Wood, plastic – universal cuts	0909029244
2.240 x 15 x 0,5	A6 peg tooth	Wood, plastic – straight cuts	0909029260
2.240 x 15 x 0,5	A2 rake tooth	Metal, foamed materials	0909029279
For BAS 380			
2.225 x 3 x 0,5	A2 helical tooth	Wood, plastic – small radii, For circular cuts using the fine sawing attachment	0909060257
2.225 x 6 x 0,36	A4 helical tooth	Wood, plastic – curve cuts	0909060265
2.225 x 9 x 0,36	A6 peg tooth	Wood, plastic – universal cuts	0909060273
2.225 x 13 x 0,36	A6 peg tooth	Wood, plastic – straight cuts	0909060281
For BAS 505 G			
3.380 x 6 x 0,5	A4 helical tooth	Wood, plastic – curve cuts	0909029180
3.380 x 13 x 0,65	A2 rake tooth	Non-ferrous metal, steel frames	0909029228
3.380 x 15 x 0,5	A2 rake tooth	Wood, nailproof, foamed materials	0909029210
3.380 x 15 x 0,5	A6 peg tooth	Wood, plastic – universal cuts	0909029171
3.380 x 25 x 0,5	A6 peg tooth	Wood, plastic – straight cuts	0909000416
3.380 x 25 x 0,5	A18 peg tooth	Wood, firewood	0909000424

DESIGNATION OF THE BAND SAW BLADES

Example:

T. tip ind. hard. 2240 x 6 x 0,5/A – 4 (14/1")

T. tip ind. hard. = Tooth tip induction hardened
Carbon steel with inductively hardened tooth tips; very economical due to its long service life

2240 = band length mm

6 = band width mm







0,5 = band thickness mm

A – 4 = clearance of tooth tips mm

14/1" = A2 = number of teeth per inch unit

1,3/1" = A18 = number of teeth per inch unit

DESIGNATION OF BAND SAW BLADES

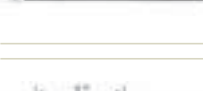
	Helical tooth for small radius Wood, plastic, fine sawing attachment required	(A2)
	Helical tooth for curved cuts Wood, plastic	(A4)
	Peg tooth for universal cuts Wood, plastic	(A6)
	Peg tooth for straight cuts Wood, plastic	(A6)
	Peg tooth for straight cuts Wood, plastic	(A6)
	Peg tooth for straight cuts Firewood	(A18)
	Rake tooth for universal cuts Aluminium, copper, brass, foams	(A2)
	Rake tooth for universal cuts Aluminium, copper, brass, steel	(14/1")

Free Manuals Download Website

<http://myh66.com>

<http://usermanuals.us>

<http://www.somanuals.com>

<http://www.4manuals.cc>

<http://www.manual-lib.com>

<http://www.404manual.com>

<http://www.luxmanual.com>

<http://aubethermostatmanual.com>

Golf course search by state

<http://golfingnear.com>

Email search by domain

<http://emailbydomain.com>

Auto manuals search

<http://auto.somanuals.com>

TV manuals search

<http://tv.somanuals.com>