

Penta Scanner Product Family User Guide



A Guide to Using the Microtest PentaScanner Product Family to install, manage and troubleshoot Category 5 and ISO Class C/D Cabling Systems

The PentaScanner Product Family verifies installed links against Category 5 (TSB-67 and 568A Annex E) and ISO Class C/D requirements.

Copyright © 1993, 1996 Microtest, Inc. All rights reserved

Chapter 1: Introduction

The Complete Category 5 Solution

The ***PentaScanner Product Family*** is the hand-held certification and diagnostic tool for Category 5 and ISO Class C and D links. ***PentaScanner*** products also provide full software compliance with TIA TSB-67 requirements for measurement reporting and analysis (including TSB-67 NEXT sweep and swept Attenuation). These tools are designed to be the complete solution for professional cable installers, service providers, and network administrators.

Scanners in the ***PentaScanner*** product family incorporate a graphical user interface, backlit display menus, arrow keys, on-line help and descriptive menu options that guide you quickly and easily through certifying or troubleshooting cabling systems.

Most of the information in this user guide applies to all ***PentaScanner*** products. Some information applies only to ***PentaScanner+*** units — this information is noted as such. ***PentaScanner+*** units (with 36-pin connectors) are differentiated from ***PentaScanner*** and ***PentaScanner*** Cable Admin units (with Modular 8 connectors), where applicable.

2-Way Injector +/-2-Way Injector

The 2-Way Injector+ and 2-Way Injector perform wire map, signal generation for Attenuation, and end of link termination for other measurements. In addition, each measures NEXT at the Injector end of the link and reports the results to the Scanner. As part of the Autotest, NEXT results are stored for both ends of the link. Data from the Injector end of the link can be displayed in any of the Autotest view modes and printed as part of Autotest reports.

Super Injector +/-Super Injector

The Super Injector+ and the Super Injector are single direction active injectors and remote test coordinators that work with Scanners to verify twisted-pair cable transmission quality. By using the Injector, the Scanner can test Attenuation, NEXT, Loop Resistance, and provide a Wire Map for any twisted-pair cable.

Scanner Display Conventions

Scanner Display	Meaning
←→↑↓	The up and down arrows in the display indicate that more information is available by pressing the ←or→ arrow key. Use the ↑ and ↓ arrow keys for page up and page down navigation.
12-36 or 12/36	The paired numbers in the display indicate wire pairs. For example, 12 indicates the wire pair on pins 1 and 2. 12-36 indicates two wire pairs tested, the first on pins 1 and 2, and the second on pins 3 and 6.

On-Line Help for Instant Answers

The Scanners include on-line context sensitive help. Just press the **HELP** key at any time for information about the test that you are performing. By pressing function keys (**F1, F2, F3, F4**) and arrow keys (←→↑↓), you can move easily through the help text.

Chapter 2: Getting Started

Charging the Scanner's Battery

In order to operate the Scanner and the 2-Way Injector from battery power, the battery must first be charged. You can run the units from the AC adapter until the charging cycle is complete.

Ready Screen

This screen is displayed after you press the **ON/OFF** key. **Ready!** should display in the center of the screen. If not, contact your Microtest distributor for assistance.

The date and time are displayed at the top of the screen. The currently selected Autotest is displayed below the time. The currently selected cable type is displayed on the bottom left of the screen.

Press **Cable (F1)** to view a list of available cable types, to create a new cable type, or to edit an existing cable type. You can test cables using both modular and BNC connector types.



Press **Jack (F4)** to toggle the jack selection between twisted-pair (**TWP**) and **Coax**.

Scanner Information

To display software, hardware and serial number information, press and hold .

The Software and Hardware Version Numbers are displayed in the right center of the screen. Check the Microtest Web page at <http://www.microtest.com/>, or the Microtest Bulletin Board System (BBS) at **(602) 957-7716 (U.S.)** or **+44 1293 894031 (Europe)** to be sure you are working with the most recent software version.

The Scanner's Serial Number is displayed in the lower center area of the screen. You may need to provide the Serial Number when having repairs or refurbishments done, or when you call for Technical Support. The Serial Number can also be found on the label on the back of the unit.

The left area of the screen is a contrast indicator for the display. Press the  or  arrow key to increase or decrease the contrast.

Ni-Cd Battery (Scanner and 2-Way Injectors)

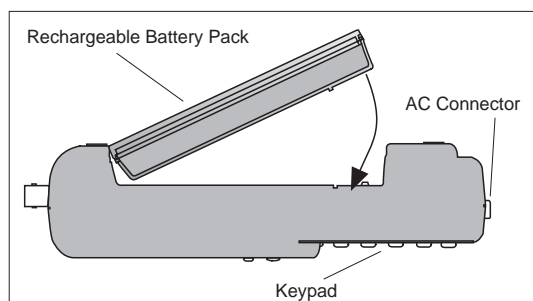

The Scanners and the **2-Way Injector+2-Way Injector** are powered by a rechargeable, recyclable Nickel Cadmium (Ni-Cd) battery pack. Under various state and local laws, it may be illegal to dispose of this battery pack into the municipal waste stream. Check with your local solid waste officials for details in your area for recycling options or proper disposal.

To remove the Ni-Cd battery pack, place the Scanner or Injector face down and slide the arrow-shaped tab downward. Then lift the battery pack up towards you. To install the battery pack, insert the two tabs on the top of the battery in the Scanner and press down on the battery pack until it clicks into place.

2-Way Injector+/2-Way Injector Battery

The Injector is powered on by the Scanner. When active, the Injector's Status Indicator will indicate the current mode of operation. After 15 seconds of inactivity, the Injector will automatically shut itself off to preserve battery life.

When operating with the AC adapter plugged in, the Injector is always on. If it is inactive (i.e. not performing measurements), the Injector recharges its battery pack. The Charging LED will indicate the state of the battery. (See the section titled **CHARGING Indicator** for details). Battery charging is disabled while the Injector is performing a measurement function. After 15 seconds of inactivity, the Injector automatically returns to charging mode.

Ni-Cd Battery Tips

- Power off the unit before changing the Ni-Cd battery pack.
- The **PentaScanner** and **PentaScanner Cable Admin** Ni-Cd battery pack must be replaced within five minutes to avoid memory loss.
- If the display goes blank while the AC adapter is plugged in to the Scanner, it indicates that the Ni-Cd battery pack is on maintenance ("trickle") charge.
- The Ni-Cd battery pack is NOT being recharged while the Scanner is powered ON.
- The Ni-Cd battery pack is recharged by powering OFF the Scanner and plugging the AC adapter in to the Scanner or by using the optional external Quick Charger.
- The average time to recharge the Ni-Cd battery pack is about 15 hours with the AC adapter, and 2 to 3 hours with the Quick Battery Charger.
- To further maximize Ni-Cd battery pack life, Microtest recommends that approximately every 7 - 10 charging cycles, you refresh your battery using **Battery Refresh Mode** (see below).
- To maximize Ni-Cd battery pack life, avoid extreme temperatures.
- Backlighting the display causes increased battery drain.
- Average daily life of the Ni-Cd battery is about 8 hours.
- Contact your Microtest distributor for details on the external Quick Charger, Microtest Part Number 8003-01.

Battery Refresh Mode

You can refresh your **PentaScanner+**, **2-Way Injector+**, and **2-Way Injector** battery using the Scanner's **Battery Refresh Mode**. When you set the Refresh Mode, the unit's battery will fully discharge and then recharge, which should increase your battery's life. The Refresh Mode is executed via the PENTA reflash program.

To put your Scanner into Refresh Mode, attach it to your PC with a DB-9 serial cable. Attach the AC Adapter to the Scanner, and power the unit on. At the PC's DOS prompt, type: PENTA -REFRESH -C1 (for COM1, or -C2 for COM2) and press Enter.

The Scanner's display will read:

The PentaScanner+ is in battery refresh mode.

When finished discharging, the Scanner will turn itself off and proceed to recharge via the AC adapter.

To put your **2-Way Injector** or **2-Way Injector+** into Refresh Mode, first attach the Injector to your Scanner with a RJ-45 or 36-pin cable, whichever is appropriate for your equipment (you may need to use an adapter if your units have different connector types). Attach the Scanner to the PC with a DB 9 serial cable. Attach AC Adapters to both the Injector and the Scanner, and power both units on. At the PC's DOS prompt, type:

PENTA -2REFRESH -C1 (for COM1, or -C2 for COM2) and press Enter. The Injector is now in discharge mode, indicated by the alternate flashing of the Pass and Fail LED indicators. When the battery has discharged, the Injector will switch to recharge mode (indicated by the Charging light). To refresh the Scanner and the Injector batteries at the same time, follow the instructions above for connecting the Injector to the Scanner, and the Scanner to the PC. Attach AC Adapters to both the Injector and the Scanner, and power both units on. Put the Injector into refresh mode first, by typing:

PENTA -2REFRESH -C1 (for COM1, or -C2 for COM2) and press Enter.

Now, put the Scanner into refresh mode by typing:

PENTA -REFRESH -C1 (for COM1, or -C2 for COM2) and press Enter.

Both units will discharge and recharge as described above.

Once the units are in Refresh Mode, you can disconnect the DB-9 serial cable. Keep the units plugged in to the AC adapters. The units will discharge and recharge in approximately 15-20 hours. For best results, do not remove the AC adapter until the battery is fully charged. On the **PentaScanner+**, the battery is fully charged when the "Charging Battery" message is no longer displayed on the screen. On the **2-Way Injector+/2-Way Injector**, the battery is fully charged when the Charging Indicator LED is flashing.

Super Injector+/Super Injector Battery

The **Super Injector+** and **Super Injector** are powered by three AA alkaline batteries. (Be sure to use only AA alkaline batteries in the Injector. Other battery types are not supported.) To remove the batteries, move the battery door latch forward and remove the battery door.

The Injector battery life varies depending on usage and battery quality. On average, the batteries will withstand testing of more than 500 cables. Low battery detection is reported in several ways:

- The Injector Status Indicator blinks slowly (approximately once per second) instead of normal rapid blinking.
- Press the **Extended Functions** key and select **Injector Info** to display the battery status.
- The Scanner checks the Injector batteries before running selected tests and before calibrating the Injector, and displays a warning message if the Injector batteries are low.

Test Connectors

The **PentaScanner+**, **2-Way Injector+** and **Super Injector+** have 36-pin connectors. The **PentaScanner**, **PentaScanner Cable Admin**, **2-Way Injector** and **Super Injector** have Modular 8 (RJ-45) connectors:

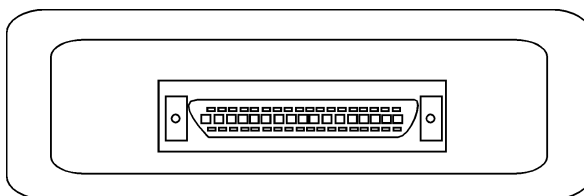

36-pin connector
on the **2-Way Injector+**
and the **Super Injector+**

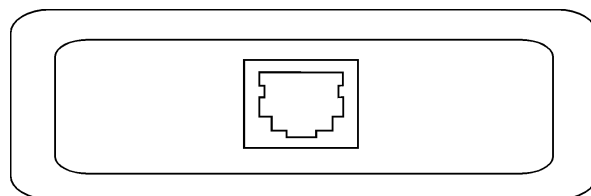

Modular 8 (RJ-45) connector
on the **2-Way Injector+** and
the **Super Injector**

High Voltage Protection

The **PentaScanner+ / PentaScanner / PentaScanner Cable Admin, 2-Way Injector+ / 2-Way Injector** and **Super Injector+ / Super Injector** are designed to withstand input hazard voltage conditions that arise from normal telephony applications such as 48 VDC at less than 80 ma or 24 VAC used to power many keysets. The unit detects when a voltage of greater than ± 15 volts is applied on the inputs and sounds a warning to alert the user to remove the hazard condition immediately to prevent possible damage to the input circuits. Tests cannot be performed when hazard conditions are detected on the inputs.

2-Way Injector+ / 2-Way Injector LED Indicators



Indicator	State	Description
Pass	Steady Light	Overall Autotest result is PASS
Fail	Steady Light	Overall Autotest result is FAIL
Status	Steady Light	The Injector is powered ON and waiting for communication with the Scanner.
Status	Off	The Injector is powered OFF (or charging battery if AC adapter is attached).
Status	Rapid Blink	Executing command or measurement in progress

Status	Slow Blink	Battery is low
Charging	Steady Light	The Injector is inactive, the AC adapter is present and the battery pack is being charged at the maximum rate.
Charging	Off	The Injector is inactive and the battery or AC adapter is not present; or the Injector is active.
Charging	Blinking (once every 10 seconds)	The Injector is inactive and the AC adapter is present; the battery pack is fully charged and the Injector is in trickle charge mode.
Circuit Guard, Pass, Fail, plus steady tone	Blinking	Overvoltage condition

Super Injector+/Super Injector LED Indicators

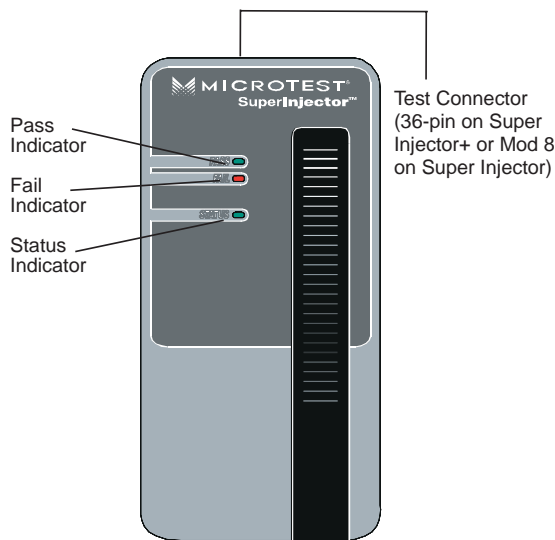

Indicator	State	Description
Status	Rapid blink	Test in progress
Status	Steady light	Injector waiting for signal from Scanner
Status	Slow blink	Injector battery low
Pass	Steady light	Test has passed
Fail	Steady light	Test has failed
Fail, plus tone condition	Steady light	Overvoltage steady tone condition

When to Use the Injector

Some measurements require the use of the Injector at the far end of the cable. For other measurements, the Injector can be connected but its use is optional. The Scanner automatically detects the presence of and configures the Injector for the measurement to be performed. The following table outlines when to use the Injector:

Measurement	Injector Required?	Description
Attenuation	Yes	The Injector generates the frequencies and the Scanner measures the signal to determine the signal loss.
Autotest	Yes	The Injector is required for Attenuation, NEXT measurements, Resistance and Wire Map during Autotest.
Capacitance	No	If connected, the Injector provides an "OPEN" for the duration of the measurement.
Length	No	If connected, the injector provides an "OPEN" for the duration of the measurement.
Impedance	No	If connected, the injector provides an "OPEN" for the duration of the measurement.
NEXT - Scanner End	Yes	The Injector provides a 100 ohm termination while the Scanner measures NEXT.
NEXT - Injector End (2-Way Injector+ / 2-Way Injector only)	Yes	The Scanner provides a 100 ohm termination for the duration of the measurement.
Loop Resistance	Yes	If connected, the Injector is used to "SHORT" the wire pair under test and the Scanner measures Loop Resistance. If the 2-Way Injector is not connected, the Scanner will display "OVR" (Over Range).
Wire Map (Find Cable Faults)	Yes	The Scanner communicates with the Injector across the link under test to determine the wire connection from the Scanner end to the Injector end.
Noise	No	The Injector is not required to measure impulse noise or peak-to-peak noise.

Note: The Injector is not used when testing coaxial cable. **See Appendix D: Working with Coaxial Cable** for more information.

Using Multiple Injectors

One Scanner can store calibration data for up to five Injectors. To determine which Injector is attached to the Scanner, press the **Extended Functions** key, then select **Injector Info**. The Scanner will display the serial number and other information for the attached Injector.

Injector Calibration

Calibration of the Injector's signal amplitude is required for accurate Attenuation measurements and requires user intervention. To maintain accurate Attenuation measurements, the Injector must

be calibrated each calendar day that it is used. Expiration of calibration data is automatically detected by the Scanner.

The Scanner and Injector are connected through their respective test connector ports using the patch cable provided with each instrument. The amplitude of each frequency generated by the Injector is measured by the Scanner. The resulting calibration values are stored in the Scanner according to the Injector's serial number. The Scanner maintains five sets of Injector calibration data simultaneously.

1. Connect the Scanner and the Injector using the patch cable supplied with the Scanner (see following diagrams). If you have a Scanner with a 36-pin connector, you may also need to use the Mod 8 Adapter (included).
2. Power on the Scanner.
3. Press the **Extended Functions** key.
4. Select **Calibrate Injector**. The Scanner will display:
Searching for Injector . . .
5. On finding the Injector, the Scanner displays:
Calibrating . . .
6. When the calibration is complete, the Scanner displays:
The Injector has been calibrated
7. Press **OK (F1)** to return to the **Extended Functions** menu.

Mod 8 Adapter Note

Use of the mating connectors not in conformance with FCC Part 68, Sub-Part F may result in damage not covered by Microtest warranty.

Calibration Connections

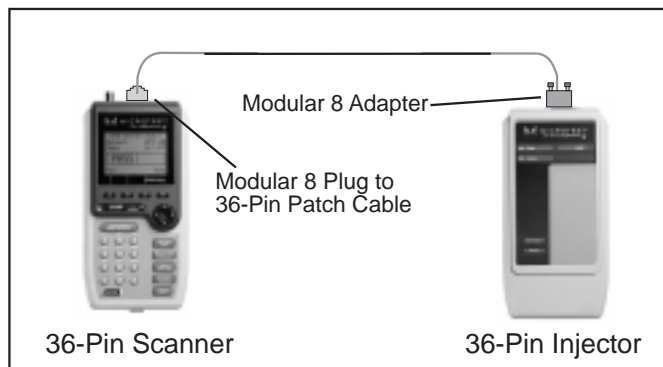

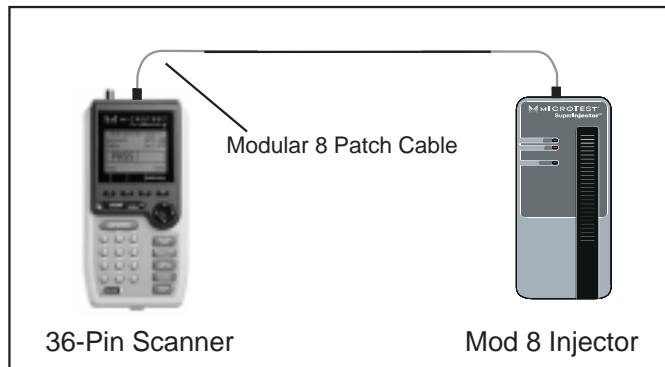
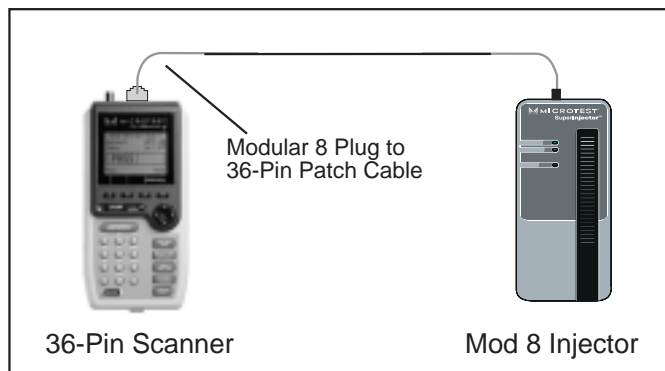

Injector Internal Calibration (2-Way Injector+/2-Way Injector only)

Periodically, the **2-Way Injector+/2-Way Injector** and the Scanner require calibration of their internal measurement circuitry. The Scanner will determine when internal calibration is required for itself and the Injector. If required, the Scanner directs the Injector to perform the calibration. At the same time, the Scanner performs its own internal calibration, synchronizing the calibration times of both devices. Internal calibration is performed automatically and is required to account for temperature changes. The only effect you may notice is an occasional slight increase in test times while internal calibration is being performed.

Connections

The Scanner and the Injector are used together to perform measurements that allow the Scanner to verify installed links or assist in the diagnosis of network problems at the physical layer. To accomplish these measurements, the Scanner and the Injector are connected at both ends of a network cabling link. The end at which the Scanner is connected is referred to as the “PentaScanner end”. The end at which the Injector is connected is referred to as the “Injector end”.

When the **2-Way Injector+** or **2-Way Injector** is used for testing, the Scanner screens will display test results for both ends of the link. Press the **F4** key to toggle the display between Scanner (**Penta**) and Injector (**Inj**) test results.

Refer to the diagrams on the following pages for instructions on connecting the Scanner and the Injector for both basic link and full channel tests.

Basic Link with Modular 8 Jacks

The diagram below shows the connection of a *PentaScanner+* to a Modular 8 jack in the wiring closet and a *2-Way Injector+* or *Super Injector+* to a Modular 8 jack in the work area. Use the Modular 8 plug to 36-pin patch cable to attach the *PentaScanner+* to the Modular 8 jack. At the other end of the link, use the Modular 8 plug to 36-pin patch cable to attach the Injector to the Modular 8 jack.

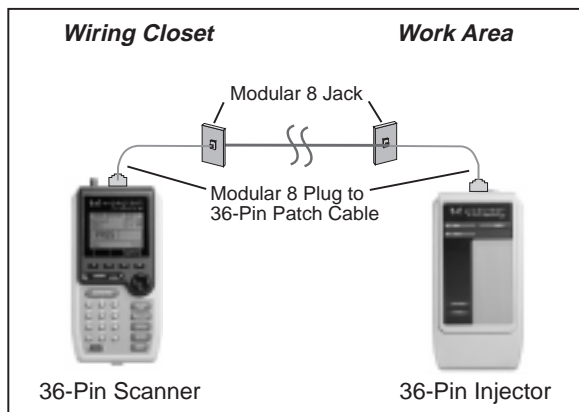

If you are using a *Super Injector*, use the Modular 8 patch cable to connect the Injector to the Modular 8 jack as shown:

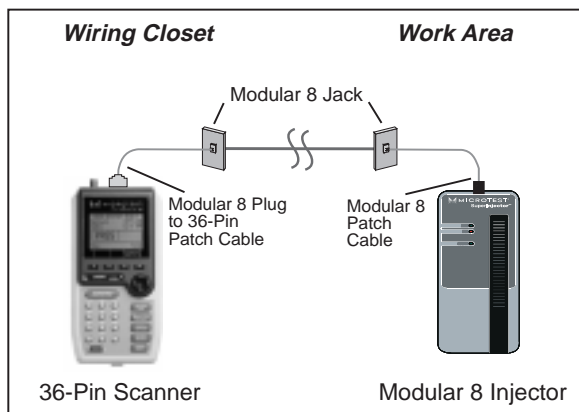

Basic Link with IDC Block and Modular 8 Jack

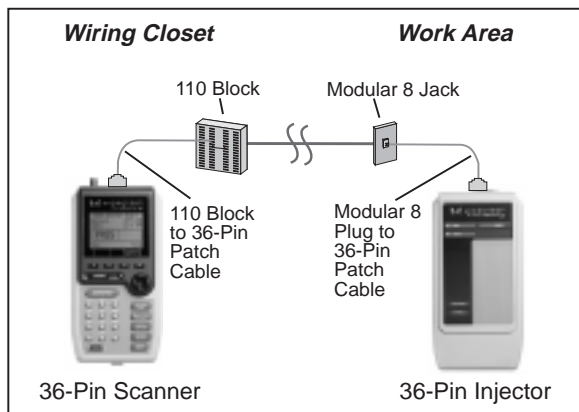

The diagram shows the connection of a *PentaScanner+* to an IDC (110) block in the wiring closet and a *2-Way Injector+* or *Super Injector+* to a Modular 8 jack in the work area.

Punch Down Block Adapter kits are available (as optional accessories) to interface the Scanners with IDC (110) punch-down blocks. For the *PentaScanner+*, order kit #8123-01. For the *PentaScanner* and *PentaScanner Cable Admin*, order kit #8051-13.

Use the 110 Block to 36-pin patch cable to attach the Scanner to the 110 Punch down block. At the other end of the link, use the Modular 8 plug to 36-pin patch cable to attach the Injector to the Modular 8 jack.

If you are using a *2-Way Injector* or *Super Injector*, use the Modular 8 patch cable to connect the Injector to the Modular 8 jack, as shown:

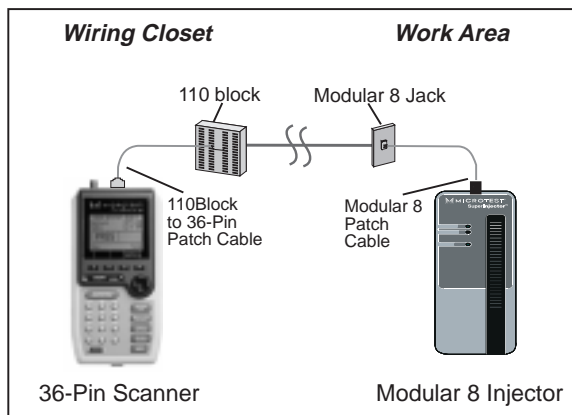

Full Channel Modular 8 Link

A full channel consists of the different link elements from the hub to the wallplate. For cables terminated with a Modular 8 plug, use the Modular 8 Adapter to interface the *PentaScanner+* with these cables. This diagram shows the connection of a *PentaScanner+* to a cross connect in the wiring closet and a *2-Way Injector+* or *Super Injector+* to a Modular 8 jack in the work area.

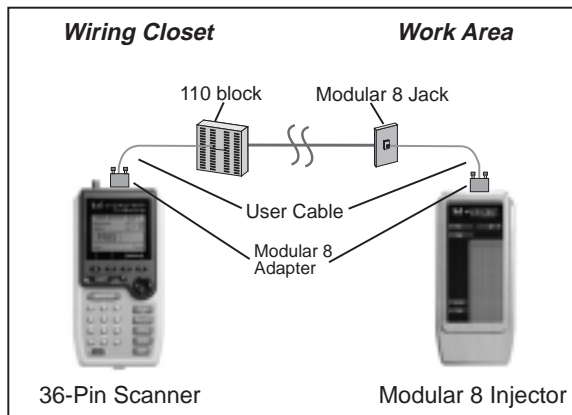

Use the Modular 8 Adapter to attach the *PentaScanner+* to the user cable attached to the cross connect. At the other end of the link, use an additional Modular 8 Adapter to attach the *2-Way Injector+* or *Super Injector+* to the user cable attached to the Modular 8 jack.

If you are using a *2-Way Injector* or *Super Injector* with a Modular 8 connector, attach the user cable directly to the Modular 8 jack, as shown:

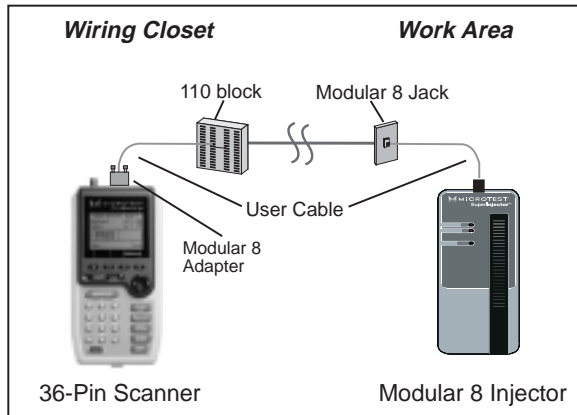

If you are using a *PentaScanner* or *PentaScanner Cable Admin* and *2-Way Injector* or *Super Injector* with Modular 8 connectors, attach the user cables directly to the Modular 8 jacks, as shown below:

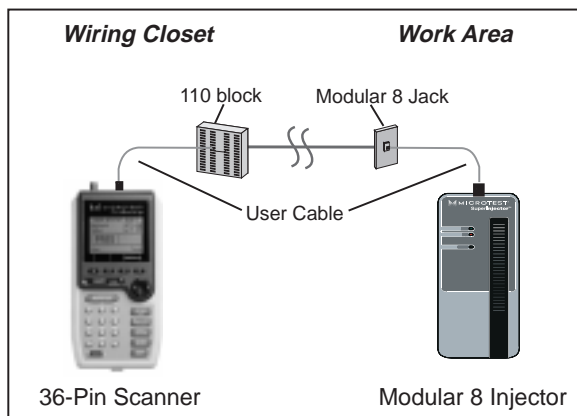

Chapter 3: Autotest

Autotest lets you run cable tests, check test results against standards, and get a PASS/FAIL indication — without having to know which tests to select or how to interpret results. Autotest can be customized depending on your site or system requirements. For example, your system may require the use of two wire pairs (instead of four) or you may not need to perform all of the tests that Autotest can run. By customizing Autotest to meet your specific needs, you save time and money!

Autotest varies depending on your network type. Autotest supports many network types, including ARCNET, 10BASE-T, Category 5, Category 4 and Category 3 LINK, ISO Class C and D, Token Ring 4/16 Mbps. See **Appendix A: Specifications** for a list of supported network types.

This chapter explains how to run Autotest, including selecting the cable types and Autotest specifications. It also explains how to customize an Autotest so you can select the pairs that are tested, the PASS/FAIL criteria, and select which tests to run during Autotest. Each test, such as NEXT, Impedance, Capacitance, etc. is explained, including how to customize the limits for each test and how to troubleshoot test results.

Steps for Running Autotest

1. From the **Ready** screen, verify that the cable type matches the cable type you will be testing. If it matches, proceed to step 2. Otherwise, see **Selecting the Cable Type** for instructions.
2. Also from the **Ready** screen, verify that the default Autotest is the Autotest that you want to run. If it is, proceed to step 3. Otherwise, see **Customizing Autotest** for instructions.
3. Connect the Scanner to the near end of the twisted pair cable you are testing and connect the Injector to the far end. During Autotest, the Injector provides the far end termination for measurements made by the Scanner. In addition, it generates signals of programmable frequency for measurement by the Scanner to determine one-way Attenuation. The **2-Way Injector+/2-Way Injector** also generates swept frequency signals and measures the Near End Crosstalk at its end of the installed link. The Scanner acts as the termination device while NEXT is being measured by the **2-Way Injector+/2-Way Injector**.
4. If you have not used the Injector in the last 24 hours, you will need to calibrate. Press the **Extended Functions** key and select **Calibrate Injector**.
5. Press the **AUTOTEST** key. If you are testing twisted pair cable, the Scanner will immediately verify that the Injector is attached. If the Injector is not attached, the Scanner will wait until it is attached before running the Autotest.
6. When the Autotest completes, a PASS or FAIL tone will sound. You can then view the results of individual tests. (See **Autotest Results Screen** for instructions.) Or, you can view a summary of test results. (See Viewing Autotest Results Summary for instructions.)
7. You can also save Autotest results — see **Saving Autotest Results** for details.
8. You can also print Autotest results — see **Printing Autotest Results** for details. A sample Autotest report is shown at the end of this chapter.

Press the **ESCAPE** key at any time to cancel the Autotest.

Selecting the Cable Type

To display the **CABLE SETUP** screen, press **Cable (F1)** from the **Ready** screen. This screen displays the cable types available for testing.

Before running an Autotest, verify that the cable type you are testing matches the cable type in the Scanner. Press the **↑** or **↓** arrow key to scroll through the list one line at a time. Press the **←** or **→** arrow key to scroll through the list one page at a time.

If the cable type you are using is not in the list, press **Edit (F2)** to define a new cable type (see **Editing the Cable Type** for further instructions). You can also press **Edit (F2)** to review the current settings for the selected cable type or to make changes.

Press **Default (F1)** to choose the highlighted cable type for the test you run. Choosing the correct cable type will ensure accurate Length measurements.

Press **Delete (F3)** to delete user-defined cable types. Note: Factory-supplied cable types cannot be deleted.

Press the **ESCAPE** key to exit.

Editing the Cable Type

To display the **EDIT CABLE** screen, press **Cable (F1)** from the **Ready** screen, then press **Edit (F2)**. This screen displays the characteristics of the cable you will be testing.

Press the **↑** or **↓** arrow key to highlight the (cable) Name or NVP (Nominal Velocity of Propagation) field. The Impedance field is for reference only and does not affect test results. The highlighted field will be enclosed in a box. Use the Scanner keypad to enter the Cable Name or the NVP value.

Press **Del (F2)** to delete the character at the cursor.

If your Scanner has an alphanumeric overlay on the keypad, use the keypad to enter the cable name. If your Scanner does not have an alphanumeric overlay, press **Edit (F2)** to edit the name. See **Chapter 4: Editing, Printing & Updating** for more information on editing.

Note: If you change the information for a factory supplied cable type and do not edit the cable name, an asterisk (*) will appear before the cable name.

If you are not sure of the NVP value, press **GetNVP (F4)** to calculate it. See **Calculating NVP** for more information.

Press **Save (F1)** to store the new settings and exit. If you have changed the cable information, press **Default (F1)** from the **CABLE SETUP** screen to select it as the cable type to use during testing.

Press the **ESCAPE** key to exit without saving.

Calculating NVP

To display the **CABLE NVP** screen, press **Cable (F1)** from the **Ready** screen, then press **Edit (F2)**; then press **GetNVP (F4)**.

For an accurate Length test, the NVP (Nominal Velocity of Propagation) must be set correctly. NVP is a measure of how fast a signal travels down a cable compared to the speed of light. It is usually between 60% and 90% and is specified by the cable vendor. The Scanner has a large library of cables with the manufacturer's specified NVP.

This screen lets you calculate the NVP for cables over 50 feet (15.24 meters) long. The **PentaScanner** and **PentaScanner Cable Admin** calculate the NVP based on the longest wire pair in the cable. The **PentaScanner+** calculates the NVP based on the shortest wire pair in the cable.

You can use the **CABLE NVP** feature to create a custom cable type when the cable type is not known.

If your Scanner has an alphanumeric overlay on the keypad, use the keypad to enter the cable length. If your Scanner does not have an alphanumeric overlay, press **Edit (F2)** to edit the length. See **Chapter 4: Editing, Printing & Updating** for more information on editing.

Press **Del (F2)** if you wish to delete the character at the cursor. After you have entered the cable length, press **Calc (F4)** to calculate the NVP.

After calculating the NVP, press **Save (F1)** from the **EDIT CABLE** screen to store the new settings. Then, press **Default (F1)** from the **CABLE SETUP** screen to select the cable as the default cable type.

Customizing Autotest

To display the **AUTOTEST SETUP** screen, press the **Extended Functions** key, then **select Setup Autotest**. This screen lets you set the default Autotest, edit Autotest settings and delete user-defined Autotests.

Press the **↑** or **↓** arrow key to scroll through the list. Or, press the **←** or **→** arrow key to scroll up or down one screen at a time. When the Autotest you want to use is highlighted, press **Default (F1)** to select it as the Autotest to run.

If your Scanner has an alphanumeric overlay on the keypad, use the keypad to change the Autotest name. If your Scanner does not have an alphanumeric overlay, press **Edit (F2)** to edit the name. See **Chapter 4: Editing, Printing & Updating** for more information on editing. Press **Change (F2)** to set the Margin Display.

Press **Delete (F3)** to delete user-defined Autotests.

Press the **ESCAPE** key to exit.

Editing Autotest Information

To display the **EDIT AUTOTEST** screen, press the **Extended Functions** key, then **select Setup Autotest**, then highlight the Autotest to edit, then press **Edit (F2)**. This screen lets you customize Autotest settings.

Press the **↑** or **↓** arrow key to scroll through the available options and press **Select (F1)** to choose the highlighted option. Or, press the number on the keypad that corresponds to the option you want.

Select **Name/Options** to edit the Autotest name and to change the **MARGIN OPTION**. Select **Pairs** to choose the pairs to be used in the Autotest, and to indicate which pairs have PASS/FAIL criteria applied to them during Autotest. Select **Tests to Run** to choose which tests to run during Autotest. Select **Limits** to edit test limits.

Press the **ESCAPE** key to exit.

Editing the Autotest Name

To display the **EDIT AUTOTEST NAME** screen, press the **Extended Functions** key, then select **Setup Autotests**, then highlight the Autotest to edit, then press **Edit (F2)**, then select **Name/Options**. This screen lets you edit the Autotest name and change the **MARGIN OPTION**.

If your Scanner has an alphanumeric overlay on the keypad, use the keypad to enter up to 14 characters for the Autotest name. If your Scanner does not have an alphanumeric overlay, press **Edit (F2)** to display the edit screen. See **Chapter 4: Editing, Printing & Updating** for more information on editing.

When Margin Display is set to **TIA Margin Display**, marginally passing test results (those for which the passing value falls within the Scanner's accuracy range) are marked with "*PASS". When Margin Display is set to **ACR Margin Check**, a cable will pass if a failing NEXT test result is within the Scanner's accuracy range AND if the ACR result is within an acceptable range. When Margin Display is set to **None**, the only possible Autotest results are "PASS" or "FAIL".

In the Autotest memory list screen, the test status can be "P" (PASS) or "F" (FAIL), or if the Autotest was run with Margin Display set to **TIA**, "*" (MARGINAL PASS).

After editing, press **Save (F1)** to store the new Autotest name and exit or press the **ESCAPE** key to exit.

Selecting Pairs for Autotest

To display the **EDIT AUTOTEST PAIRS** screen, press the **Extended Functions** key, then select **Setup Autotest**, then highlight the Autotest to edit, then press **Edit (F2)**; then select **Pairs**. This screen lets you select which pairs to test and which pairs to use as PASS/FAIL criteria.

The top row indicates the pairs to be tested during Autotest. The bottom row indicates the pairs that will determine the PASS/FAIL criteria for the cable. Press the ← or → arrow key to move left or right within the rows. Or, press the ↑ or ↓ arrow key to move between rows.

Press **Select (F2)** (or **Unsel**) to select (or deselect) the pair. Selected tests are marked with an 'x'.

Press **Save (F1)** to store the pair selections and exit or press the **ESCAPE** key to exit without saving.

Note: If a pair is selected for PASS/FAIL criteria, but is not selected for testing, all tests will fail. If a pair is selected for testing but is not selected for PASS/FAIL criteria, the Autotest will not be marked as FAIL if that pair fails.

Selecting Tests to Run During Autotest

To display the **EDIT TESTS TO RUN** screen, press the **Extended Functions** key, then select **Setup Autotest**, then highlight the Autotest to edit, then press **Edit (F2)**, then select **Tests to Run**. This screen lets you enable or disable the tests to run during Autotest. When using the **2-Way Injector+** or **2-Way Injector**, you can run tests at the Scanner or Injector end of the link.

Press the ↓ or ↑ arrow key to highlight the test(s) to enable or disable.

Press **Select (F2)** (or **Unsel**) to enable (or disable) the highlighted test. Enabled tests are marked with an 'x'.

After all test selections have been made, press **Save (F1)** to save the list of selected tests for this Autotest.

Press the **ESCAPE** key to exit the screen without saving.

Note: ACR will not be computed unless the NEXT and Attenuation tests are enabled (since ACR computations are based on NEXT and Attenuation measurements). The Scanner will automatically disable ACR if NEXT or Attenuation is not enabled.

Editing Test Limits

To display the **EDIT LIMITS** screen, press the **Extended Functions** key, then **select Setup Autotest**, then highlight the Autotest to edit, then press **Edit (F2)**, then select Limits. This screen lets you specify the PASS/FAIL limits used in tests.

Press the **↑** or **↓** arrow key to highlight the test for which you want to edit the limits.

Press **Select (F1)** to display the limits screen for the highlighted test. Or, press the number on the keypad that corresponds to the test for which you want to change the limits.

After editing the selected limits, press **Save (F1)** to save these changes and to return to the **EDIT LIMITS** screen.

If you have created a new Autotest by editing the Autotest name or by editing a factory-programmed Autotest, and if you want the new test to be the default Autotest, press **ESCAPE** until you return to the **AUTOTEST SETUP** screen, then press **Default (F1)**.

Note: See the individual test sections for information on customizing specific test limits.

Running Autotest

To display the **AUTOTEST:** screen, press the **AUTOTEST** key. This screen is displayed while Autotest is running. The Autotest name is displayed at the top of the screen and the cable type is shown in the top center of the screen. Each pair being tested is displayed in the lower left corner of the screen. The name of each test being run is displayed in the lower right corner of the screen. A status bar at the bottom of the screen indicates the progress of the Autotest.

Press the **ESCAPE** key at any time to cancel the Autotest.

Note: The Injector must be attached to the far end of the cable during Autotest. If it is not, the Scanner screen will display the following:

Searching for Injector . . . (Injector Not Found)

Autotest Results Screen

To display the **AUTOTEST RESULTS** screen, press the **AUTOTEST** key, or press the **Extended Functions** key and select **Memory**. This screen is displayed when Autotest completes or when saved Autotest results are selected for viewing.

The Autotest name is at the top right of the display and the PASS/FAIL indicator is in the center. The number of failed tests, if any, is displayed next to the PASS/FAIL indicator. An Autotest will PASS if all the selected tests meet the specified criteria. An Autotest will FAIL if one or more selected tests fail. When the Margin Display is set to **TIA Margin Display** an Autotest will marginally PASS (*PASS) if one or more NEXT, Attenuation or Length measurements marginally passes. A marginal PASS is defined as a PASS result that is closer to the PASS/FAIL threshold than the accuracy of the Scanner.

Press **View (F1)** to display Autotest results, then use the **↑** or **↓** arrow keys to scroll through the tests. The tests you view depend on the tests you have selected to run in **AUTOTEST SETUP**. See **Selecting Tests to Run During Autotest** for more information.

Press **Save (F2)** to save test results and exit. See **Saving Autotest Results** for more information.

Note: The **Save (F2)** key is unavailable when viewing the **AUTOTEST RESULTS** screen via the **Extended Functions/Memory** feature.

Press **Print (F3)** to print test results. See **Printing Autotest Results** for more information. Note: The **Print (F3)** key is unavailable when viewing the **AUTOTEST RESULTS** screen via the **Extended Functions/Memory** feature.

Press **Tests (F4)** to view a PASS/FAIL summary of test results and to view results for selected tests. See **Viewing Autotest Results Summary** for more information.

Viewing Autotest Results

WIRE MAP, LENGTH, PROPAGATION DELAY, NEXT, ATTENUATION, ACR, IMPEDANCE, LOOP RESISTANCE, CAPACITANCE

You can view Autotest results by pressing **View (F1)** from the **AUTOTEST RESULTS** screen and pressing the **↑** or **↓** arrow key to scroll through test results. Press the **ESCAPE** key to exit.

The next section describes each test, including how to set test limits, how to read results screen and how to troubleshoot test results.

Wire Map

Wire Map easily diagnoses your communications link for crossed pairs, shorts, split pairs and opens.

Crossed pairs occur when two or more wires are reversed from end to end, thus resulting in a communication failure.

Split pairs occur when physical continuity is maintained but wires from logical pairs are split up. This error is more difficult to detect because there is still a pin-to-pin correspondence. Wire Map finds split pairs, and you can also suspect split pairs if the cable's NEXT test result is less than 22 dB. For more information, refer to Microtest's *Category 5 Cable Testing Handbook*.

Wire Map Test Results

To display this screen, press **View (F1)** from the **AUTOTEST RESULTS** screen, then press the **↓** key until the **WIRE MAP TEST RESULTS** screen is displayed.

The wire map screen displays a graphical representation of the wiring in your cable. Near end wiring displays on the left side of the screen and far end wiring displays on the right side of the screen.

- A >< between wire pairs indicates a crossed pair.
- No line between wire pairs indicates an open.
- A] between wire pairs indicates a short.
- A straight line between pairs indicates a good pair.
- "PASS" or "FAIL" indicates if wiring is correct or incorrect.

Press **Splits (F1)** to display the **SPLIT PAIRS** screen, with the split status displayed to the right of the wire pair.

Press the **↓** arrow key to display the next test result screen or press the **ESCAPE** key to exit. Note: You can also generate a wire map by attaching the Injector to the far end of the twisted pair cable and pressing the **Find Cable Faults** key.

Length

Length can find opens, shorts, and breaks in a cable. The **PentaScanner Product Family** uses Time Domain Reflectometry (TDR) to find the location of faults in cables. TDR is similar to 'cable radar'. The Scanner generates a pulse down the wire, and when the pulse encounters an impedance change (such as an open, short, or poor connection), all or part of the pulse energy is reflected back to the Scanner. The Scanner then measures the delay between when the pulse was sent and when the reflection was received. Knowing the speed that the pulse travels down the cable (Nominal Velocity of Propagation, or NVP), the Scanner can then calculate the distance to the fault.

The Length measurement is most accurate when the NVP setting you use is set correctly.

Customizing Length Limits

To display the **LENGTH LIMITS** screen, press the **Extended Functions** key, then select **Setup Autotest**, then highlight the Autotest to edit, then press **Edit (F2)**, then select **Limits**, then select **Length**. This screen lets you change the minimum and maximum Length limits.

Press the **↑** or **↓** arrow key to select the minimum or maximum Length limit. The selected limit will be enclosed in a box.

If your Scanner has an alphanumeric overlay on the keypad, use the keypad to enter the limits. If your Scanner does not have an alphanumeric overlay, press **Edit (F2)** to display the edit screen.

After editing, press **Save (F1)** to store the new Length limits and exit or press the **ESCAPE** key to exit without saving.

Length Test Results

To display the **LENGTH** screen, press **View (F1)** from the **AUTOTEST RESULTS** screen, then press the **↓** key until the **LENGTH** screen is displayed.

Autotest Length test results provide information for the shortest pair, displayed at the top of the screen. The PASS/FAIL bar across the screen compares the measured Length value to the Length limit value. Below the PASS/FAIL bar, the Length limit value is displayed. The Autotest name is displayed after **Spec:** at the lower left of the screen.

Press **Table (F1)** to display the Length and Delay of all pairs, and the Skew between pairs (if Propagation Delay has been selected as part of the Autotest). The Skew value is the worst-case value of the difference in propagation delay between the wire pairs.

Press the **↑** or **↓** arrow key to display the previous or next test results screen.

Press the **ESCAPE** key to return to the **AUTOTEST RESULTS** screen.

Note: For diagnostic purposes, you can run Length and Delay continuously by pressing the **Measure Cable Performance** key and selecting **Length/Delay**.

Propagation Delay

Customizing Delay Limits

To display the **DELAY LIMITS** screen, press the **Extended Functions** key, then **select Setup Autotest**, then highlight the Autotest to edit, then press **Edit (F2)**, then select **Limits**, then select **Delay**. The Delay Limits screen lets you change the minimum and maximum Delay limits.

Press the **↓** or **↑** arrow key to select the minimum or maximum Delay limit. The selected limit will be enclosed in a box.

If your Scanner has an alphanumeric overlay on the keypad, use the keypad to enter the limits. If your Scanner does not have an alphanumeric overlay, press **Edit (F2)** to display the edit screen.

After editing, press **Save (F1)** to store the new Delay limits and exit or press the **ESCAPE** key to exit without saving.

Propagation Delay Test Results

To display the **PROPAGATION DELAY** screen, press **View (F1)** from the **AUTOTEST RESULTS** screen, then press the **↓** arrow key until the **DELAY** screen is displayed.

At the upper left of the screen, the pair corresponding to the test result is shown. The measured Delay is shown to the right of the pair. The PASS/FAIL bar across the screen compares the measured Delay value to the Delay limit value. Below the PASS/FAIL bar, the Delay limit value is displayed. The Autotest name is displayed after **Spec:** at the lower left of the screen.

Press **Table (F1)** to display the Length and Delay of all pairs, and the Skew. The Skew value is the worst-case value of the difference in propagation delay between the wire pairs.

Press **Pair (F3)** to toggle through the Delay results for each pair.

Press the **↑** or **↓** arrow key to display the previous or next test results screen.

Press the **ESCAPE** key to return to the **AUTOTEST RESULTS** screen.

Note: For diagnostic purposes, you can run Length and Delay continuously by pressing the **Measure Cable Performance** key and selecting **Length/Delay**.

Near End Crosstalk (NEXT)

As current flows in a wire, an electromagnetic field is created which interferes with signals on adjacent wires. As the frequency increases, this effect generally intensifies. Each pair is twisted to allow opposing fields in the wire pair to cancel each other. The tighter the twist, the more effective the cancellation and the higher the data rate supported by the cable. Maintaining this pair twist is the single most important factor in any single Unshielded Twisted Pair (UTP) installation. If wires are not tightly twisted, the result is excessive Near End Crosstalk (NEXT).

Measuring NEXT at Both Ends of the Link

The **2-Way Injector+** (and **2-Way Injector**) allow NEXT to be measured at both ends of the link without having to swap the Scanner and the Injector end devices. When the Scanner is measuring NEXT, the Injector provides a 100 ohm termination at the Injector end. The Scanner transmits a signal which is varied (or swept) through a frequency range. The signal is monitored on the receive pair through a narrow band receiver. The received signal amplitude is compared to the transmitted

signal and the difference is reported as the NEXT value (in dB). When measuring Injector end NEXT, the roles of the devices are reversed. The Scanner provides the 100 ohm termination for the Injector measurements and the Injector transmits a signal which is varied (or swept) through a frequency range. The signal is monitored by the Injector on the receive pair through a narrow band receiver and the difference in the transmitted and received signal levels is reported as the Injector end NEXT (in dB).

Customizing NEXT Limits

To display the **NEXT LIMITS** screen, press the **Extended Functions** key, then select **Setup Autotest**, then highlight the Autotest to edit, then press **Edit (F2)**, then select **Limits**, then select **NEXT**.

The **NEXT LIMITS** screen lets you specify the PASS/FAIL limits, frequency range and step size used in testing NEXT. Press the **↑** or **↓** arrow key to select the NEXT limit to be changed. The selected limit will be enclosed in a box.

If your Scanner has an alphanumeric overlay on the keypad, use the keypad to enter the limit. If your Scanner does not have an alphanumeric overlay, press **Edit (F2)** to display the edit screen. Note: **Limit** only applies when **Criteria** is set to **Fixed**. When **Criteria** is set to **Fixed**, the decibel value entered in the Limit field will be used as the PASS/FAIL criteria across all frequencies.

The **PentaScanner+** allows you to set a limit based on an **Offset** value. When **Criteria** is set at something other than **Fixed**, the **Offset** field replaces the **Limit** field. The value entered in the **Offset** field will be added to the NEXT criteria calculations, allowing you to set tighter NEXT limits in your Autotests. For example, if you enter a dB offset of 5.0 dB, the criteria calculations for Cat 5 Link, Cat 5 Channel, etc. will be increased by 5.0 dB. You can enter offset values from 0.0 — 60.0 dB.

When **Step** or **Criteria** is selected, **Change (F2)** lets you toggle through the available settings. After editing, press **Save (F1)** to store the new NEXT limit settings and exit or press the **ESCAPE** key to exit without saving.

NEXT Test Results

To display the **NEXT** screen, press **View (F1)** from the **AUTOTEST RESULTS** screen, then press the **↓** key until the **NEXT** screen is displayed. This screen displays Near End Crosstalk (NEXT) test results.

When using the **2-Way Injector+** (or the **2-Way Injector**), the top line of the screen indicates if NEXT is being reported for the Scanner (**Penta**) or Injector (**Inj**) end of the link.

At the upper left of the screen, the pair combination is shown. The PASS/FAIL bar across the screen compares the measured NEXT value to the NEXT limit value. The Autotest name is displayed after **Spec:** at the lower left of the screen.

Press **Detail (F1)** to display the Frequency Sweep range and test results for all pairs.

Press **Pair (F3)** to toggle through the NEXT results for each pair combination.

When using the **2-Way Injector+** (or the **2-Way Injector**), press F4 to toggle between NEXT results for the Scanner (**Penta**) or Injector (**Inj**) end of the link.

Press the **↑** or **↓** arrow key to view the previous or next test results screen.

Press the **ESCAPE** key to return to the **AUTOTEST RESULTS** screen.

Note: For diagnostic purposes, you can run NEXT continuously by pressing the **Measure Cable Performance** key and selecting **NEXT**.

NEXT Detail

To display this screen, press **Detail (F1)** from the **NEXT** screen. This screen displays the frequency sweep range and the worst case NEXT for each pair.

Press **Graph (F1)** to enter graphing mode. **Graph (F1)** is available when **Save Sweep Data** has been selected in the **AUTOTEST SETUP**, or when NEXT results are viewed immediately after running the test.

Press **Pair (F3)** to toggle through the available pair combinations.

When using the **2-Way Injector+** (or the **2-Way Injector**), press **F4** to toggle between NEXT results for the Scanner (**Penta**) or Injector (**Inj**) end of the link.

Press the **ESCAPE** key to return to the **NEXT** screen.

NEXT Graph

To display this screen, press **Detail (F1)** from the **NEXT** screen, then press **Graph (F1)**. This screen displays the NEXT graph for the indicated pair combination.

The top line of the screen displays the worst case NEXT and the frequency at which it occurred.

When using the **2-Way Injector+** (or the **2-Way Injector**), the second line of the screen indicates if NEXT is being reported for the Scanner (**Penta**) or Injector (**Inj**) end of the link.

Press **Zoom (F1)** to magnify the area of the graph around the cursor. The Zoom key can display 1x, 2x, 5x or 10x magnification.

Press **Print (F2)** to print the NEXT graph.

Press the **ESCAPE** key to return to the **NEXT DETAIL** screen.

Attenuation

The Attenuation function measures signal loss in a cable as a function of frequency. This measurement is a very important cable certification parameter. Your Scanner measures cable attenuation using the one way method as specified by IEEE and EIA.

The one way Attenuation measurement requires that a signal be injected at one end of the cable and measured at the other end to determine cable loss. The Injector acts as the far end signal generator and the Scanner NEXT receiver measures the received signal.

Customizing Attenuation Limits

To display the **ATTENUATION LIMITS** screen, press the **Extended Functions** key, then select **Setup Autotest**, then highlight the Autotest to edit, then press **Edit (F2)**, then press **Limits (F4)**, then select **Attenuation**. This screen displays the Attenuation frequency range and the criteria used to determine the range.

Press the **↓** or **↑** arrow key to highlight the field to change.

If your Scanner has an alphanumeric overlay on the keypad, use the keypad to enter the limit. If your Scanner does not have an alphanumeric overlay, press **Edit (F2)** to display the edit screen.

If the **Criteria** in the **ATTENUATION LIMITS** screen is set to **Fixed Points**, you can press **Limits (F4)** to display the **ATTENUATION LIMITS AND FREQUENCY** screen.

After editing, press **Save (F1)** to store the new limits and exit or press the **ESCAPE** key to exit without saving.

Attenuation Limits and Frequency

If the **Criteria** in the **ATTENUATION LIMITS** screen is set to **Fixed Points**, you can display the **ATTENUATION LIMITS AND FREQUENCY** screen. To display this screen, press the **Extended Functions** key, then select **Setup Autotest**, then highlight the Autotest to edit, then press **Edit (F2)**, then select **Limits**, then select **Attenuation**, then press **Limits (F4)**. This screen displays Attenuation limits for each frequency and lets you specify the frequencies to be included in the Autotest.

Press the **↑** or **↓** arrow key to highlight the Attenuation frequency to be included in the Autotest.

Press **Select (F2)** (or **Unsel**) to include (or skip) the Attenuation frequency during the Autotest.

Press **Edit (F3)** to change the Attenuation limit for the highlighted frequency.

After editing, press **Save (F1)** to store the new limits and exit or press the **ESCAPE** key to exit without saving.

Editing Attenuation Limits

To display the **ATTENUATION LIMITS FOR FREQUENCY** screen, press the **Extended Functions** key, then select **Setup Autotest**, then highlight the Autotest to edit, then press **Edit (F2)**, then select **Limits**, then select **Attenuation**, then press **Limits (F4)**, then press **Edit (F3)**. This screen displays the maximum Attenuation limit for the selected frequency and lets you change it.

If your Scanner has an alphanumeric overlay on the keypad, use the keypad to enter the limit. If your Scanner does not have an alphanumeric overlay, press **Edit (F2)** to display the edit screen.

After editing, press **Save (F1)** to store the new maximum Attenuation limit and exit or press the **ESCAPE** key to exit without saving.

Attenuation Test Results

To display the **ATTENUATION** screen, press **View (F1)** from the **AUTOTEST RESULTS** screen, then press the **→** arrow key until the **ATTENUATION** screen is displayed.

At the upper left of the screen, the pair corresponding to the displayed result is shown. The Attenuation, in decibels (dB), is shown centered and the frequency is shown to the right. The PASS/FAIL bar across the screen compares the measured Attenuation value to the Attenuation limit value. The Autotest name is displayed after **Spec:** at the lower left of the screen.

Press **Detail (F1)** to display the frequency sweep range and the test results for all pairs.

Press **Pair (F3)** to toggle through the Attenuation results for each pair combination.

Press the **←** or **→** arrow key to display the previous or next test results screen.

Press the **ESCAPE** key to return to the **AUTOTEST RESULTS** screen.

Note: For diagnostic purposes, you can run Attenuation continuously by pressing the Measure Cable Performance key and selecting Attenuation.

Attenuation Detail

To display this screen, press **Detail (F1)** from the **ATTENUATION** screen. This screen displays the frequency sweep range and the worst case Attenuation for each pair.

Press **Graph (F1)** to enter graphing mode. **Graph (F1)** is available when **Save Sweep Data: Attn** has been selected in the **SAVE AUTOTEST** screen or when viewing results immediately after running the Autotest.

Press **Pair (F3)** to toggle through the available pair combinations.

Press the **ESCAPE** key to return to the Attenuation screen.

Attenuation Graph

To display this screen, press **Detail (F1)** from the **ATTENUATION** screen, then press **Graph (F1)**. This screen displays the Attenuation graph for the indicated pair combination.

Press **Zoom (F1)** to magnify the area of the graph around the cursor. The Zoom key can select 1x, 2x, 5x or 10x magnification.

Press **Print (F2)** to print the Attenuation graph.

Press the **ESCAPE** key to return to the Attenuation Detail screen.

Attenuation-to-Crosstalk Ratio (ACR)

Attenuation-to-Crosstalk Ratio (ACR) is an indication of how much larger the received signal is compared to the noise (NEXT) on the same pair. ACR reports the difference between NEXT and Attenuation on the cable. Both Attenuation and NEXT are measured and the ACR value is computed at each measured Attenuation frequency. The worst case ACR is reported for each pair combination.

Customizing ACR Limits

To display the **ACR LIMITS** screen, press the **Extended Functions** key, then **select Setup Auto-test**, then highlight the Autotest to edit, then press **Edit (F2)**, then select **Limits**, then select **ACR**.

This screen lets you set the Limit Function and edit the Fixed Minimum ACR limit. Use the or arrow keys to select the field to change. The selected field will be enclosed in a box.

If your Scanner has an alphanumeric overlay on the keypad, use the keypad to enter the limit. If your Scanner does not have an alphanumeric overlay, press **Edit (F2)** to display the edit screen.

When **Limit Function** is selected, press **Change (F2)** to toggle between **Fixed**, **Derived** and **(ISO) Class D**:

- When **Fixed** is selected, the minimum ACR limit that you specify is applied across the full frequency range measured.
- When **Derived** is selected, the ACR limit applied is derived from the equation:
NEXT limit - Attenuation limit.
- When **Class D** is selected, the ACR limit applied is as specified for ISO Class D links.
- When **Fixed Minimum** is selected, the value you enter can range from 0 to 60 dB.

ACR Test Results

When using the **2-Way Injector+** (or the **2-Way Injector**), the top line of the screen indicates if ACR is being reported for the Scanner (**Penta**) or Injector (**Inj**) end of the link.

At the upper left of the screen, the pair combination is shown. The ACR, in decibels (dB), is shown to the right of the pair combination. The PASS/FAIL bar across the screen compares the measured ACR value to the ACR limit value. Below the PASS/FAIL bar, the ACR limit value is displayed. The Autotest name is displayed after **Spec:** at the lower left of the screen.

Press **Pair (F3)** to toggle through the ACR test results for each pair combination.

When using the **2-Way Injector+** (or **2-Way Injector**), press **F4** to toggle between NEXT results for the Scanner or Injector end of the link.

Press the **↓** or **↑** arrow key to display the previous or next test results screen.

Press the **ESCAPE** key to return to the **AUTOTEST RESULTS** screen.

Impedance

Impedance is a measure of the opposition to the flow of current in a cable. Unshielded Twisted Pair (UTP) is commonly rated at either 100 or 120 ohms. This value must be constant over the operating bandwidth of the cable.

Impedance measurements, useful for finding mismatches, include the effects of resistance, inductance and capacitance. An Impedance mismatch will cause a signal reflection in the cable, which in turn absorbs signal energy. This creates excessive loss, shorter distances that data can travel reliably, and data errors. The **PentaScanner Product Family** uses Time Domain Reflectometry (TDR) to measure Impedance.

The Impedance function measures the characteristic impedance of the cable at a fixed propagation delay down the cable. Depending on the NVP of the cable, this sample point is between 25 and 40

feet down the cable. The sampling of the voltage is delayed long enough to allow the incident step to propagate past near end patch cables, cross connects block, etc. that could disrupt the impedance measurement. The length of the cable must be long enough to produce a round trip delay, which is longer than the sample time delay. For short cables, the impedance function measures the termination value.

Note: To measure Impedance correctly, the cable length must be 40 feet or greater. If the cable is not at least 40 feet long, the Impedance test result will be **OVR** (Over range) or **UND** (Under range).

Customizing Impedance Limits

To display the **IMPEDANCE LIMITS** screen, press the **Extended Functions** key, then **select Setup Autotest**, then highlight the Autotest to edit, then press **Edit (F2)**, then select **Limits**, then select **Impedance**.

This screen lets you change the minimum and maximum Impedance limits. Press the **↑** or **↓** arrow key to select the minimum or maximum Impedance limit. The selected limit will be enclosed in a box.

If your Scanner has an alphanumeric overlay on the keypad, use the keypad to enter the limits. If your Scanner does not have an alphanumeric overlay, press **Edit (F2)** to display the edit screen.

After editing, press **Save (F1)** to store the new Impedance limits and exit or press the **ESCAPE** key to exit without saving.

Impedance Test Results

To display the Impedance screen, press **View (F1)** from the **AUTOTEST RESULTS** screen, then press the **↓** key until the **IMPEDANCE** screen is displayed.

At the upper left of the screen, the pair combination is shown. The Impedance, in ohms (Ω), is shown to the right of the pair. The PASS/FAIL bar across the screen compares the measured Impedance value to the Impedance limit value. Below the PASS/FAIL bar, the Impedance limit value is displayed. The Autotest name is displayed after **Spec:** at the lower left of the screen.

Press **Table (F1)** to display the Impedance test results for all pairs or press **Pair (F3)** to toggle through the Impedance results for each pair.

Press the **←** or **→** arrow key to display the previous or next test results screen.

Press the **ESCAPE** key to return to the **AUTOTEST RESULTS** screen.

Note: For diagnostic purposes, you can run Impedance continuously by pressing the **Measure Cable Performance** key and selecting **Impedance**.

Loop Resistance

Loop Resistance is the combined resistance of two conductors in a twisted pair cable, or the coaxial shield and center conductor in coaxial cable. In twisted pair cable, Loop Resistance is measured by using the Injector to short the far end of the pair being tested. In coaxial cable, a shorting plug is required to measure Loop Resistance. The Loop Resistance range is 0 to 10,000 ohms.

Resistance is said to fail if measured values on pairs used by the selected network type are greater than the resistance for a maximum length loop (100 meters for most networks).

Customizing Loop Resistance Limits

To display the **LOOP RESISTANCE LIMITS** screen, press the **Extended Functions** key, then select **Setup Autotest**, then highlight the Autotest to edit, then press **Edit (F2)**, then select **Limits**, then select **Loop Resistance**. This screen lets you change the maximum Loop Resistance limit.

If your Scanner has an alphanumeric overlay on the keypad, use the keypad to enter the limit. If your Scanner does not have an alphanumeric overlay, press **Edit (F2)** to display the edit screen.

After editing, press **Save (F1)** to store the new maximum Loop Resistance limit and exit or press the **ESCAPE** key to exit without saving.

Loop Resistance Test Results

To display the **LOOP RESISTANCE** screen, press **View (F1)** from the **AUTOTEST RESULTS** screen, then press the **Ä** key until the **LOOP RESISTANCE** screen is displayed.

At the upper left of the screen, the pair corresponding to the test result is shown. The Loop Resistance, in ohms (Ω), is shown to the right of the pair. The PASS/FAIL bar across the screen compares the measured Loop Resistance value to the Loop Resistance limit value. Below the PASS/FAIL bar, the Loop Resistance limit value is displayed. The Autotest name is displayed after **Spec:** at the lower left of the screen.

Press **Table (F1)** to display the Loop Resistance test results for all pairs or press **Pair (F3)** to toggle through the Loop Resistance results for each pair.

Press the **←** or **→** arrow key to display the previous or next test results screen.

Press the **ESCAPE** key to return to the **AUTOTEST RESULTS** screen.

Note: For diagnostic purposes, you can run Loop Resistance continuously by pressing the **Measure Cable Performance** key and selecting **Loop Resistance**.

Capacitance

Capacitance is the amount of electric field energy that can be stored between two conductors at a given voltage. For twisted pair cable, Capacitance is measured between conductors in a pair. For coaxial cable, Capacitance is measured between the conductor and the shield.

The Capacitance measurement is made by measuring the effective charging and discharging time constant that is formed by the capacitance of the cable. This is done at low frequency to eliminate any transmission line effects of the cable under test.

Customizing Capacitance Limits

To display this screen, press the **Extended Functions** key, then select **Setup Autotest**, then highlight the Autotest to edit, then press **Edit (F2)**, then select **Limits**, then select **Capacitance**.

Press the **↑** or **↓** arrow key to select the minimum or maximum Capacitance limit. The selected limit will be enclosed in a box.

If your Scanner has an alphanumeric overlay on the keypad, use the keypad to enter the limits. If your Scanner does not have an alphanumeric overlay, press **Edit (F2)** to display the edit screen.

After editing, press **Save (F1)** to store the new Capacitance limits and exit or press the **ESCAPE** key to exit without saving.

Capacitance Test Results

To display the **CAPACITANCE** screen, press **View (F1)** from the **AUTOTEST RESULTS** screen, then press the **↓** key until the **CAPACITANCE** screen is displayed.

At the upper left of the screen, the pair corresponding to the displayed result is shown. The capacitance, in picofarads (pF), is shown to the right of the pair. The PASS/FAIL bar across the screen compares the measured Capacitance value to the Capacitance limit value. Below the PASS/FAIL bar, the Capacitance limit value is displayed. The Autotest name is displayed after **Spec:** at the lower left of the screen.

Press **Table (F1)** to display the Capacitance test results for all pairs or press **Pair (F3)** to toggle through the Capacitance test results for each pair.

Press the **↑** or **↓** arrow key to display the previous or next test results screen.

Press the **ESCAPE** key to return to the **AUTOTEST RESULTS** screen.

Note: For diagnostic purposes, you can run Capacitance continuously by pressing the Measure Cable Performance key and selecting Capacitance.

Saving Autotest Results

This screen lets you store Autotest results in the Scanner's memory. To display the **SAVE TEST** screen, press **Save (F2)** from the **AUTOTEST RESULTS** screen. Press the **↑** or **↓** arrow key to highlight the field to update.

If your Scanner has an alphanumeric overlay on the keypad, use the keypad to enter field values.

When editing the Circuit ID, press F3 to change editing modes (**CAPS**, **caps**, **NUM** or **Inc**).

Increment (**Inc**) mode automatically increments the last character position, and lets you manually increment or decrement any character using the **↑** or **↓** arrow key.

To start the Automatic Increment function:

1. Run the initial Autotest.
2. Enter the initial Circuit ID.
3. Set F3 to Inc mode.
4. Press F1 to save the Autotest.

After performing the next Autotest, enter the **SAVE TEST** screen. The Scanner will automatically increment the last field in the Circuit ID. Press **F1** to save the Autotest.

When you enter the initial Circuit ID, you can divide the fields by using non-alphanumeric characters. The non-alphanumeric characters are considered field separators. For example, the Circuit ID BLDG-001 is divided into two fields by the '-' character. In Automatic Increment mode, the Scanner will automatically increment the last field, "001", from "001" to "999" and then roll back to "000". Both alphabetic and numeric characters (A-Z, a-z, 0-9) will be incremented if the circuit ID contains both types of characters.

While in Automatic Increment mode, you can manually increment the last character by pressing the Scanner's **ENTER** key. In addition, you can use the **←** and **→** keys to move to any character in the Circuit ID, and you can use the **↑** key to manually increment (or the **↓** key to decrement) the character at the cursor.

Note: When in **Inc** mode, pressing **F3** will allow you use the arrow keys to move the cursor from the **Circuit ID** field to the **Save Sweep Data** field.

If your Scanner does not have an alphanumeric overlay, press **Edit (F2)** to display the edit screen. After editing, press **Save (F1)** to store your changes and exit or press the **ESCAPE** key to return to the **AUTOTEST RESULTS** screen.

Save Sweep Data

When the **Save Sweep Data** field is selected in the **SAVE TEST** screen, several choices are available:

- When **None** is selected, Sweep data is not saved
- When **Attn** is selected, all measured Attenuation points are saved with the Autotest
- When **NEXT** is selected, all measured NEXT points are saved with the Autotest
- When **Both** is selected, both Attenuation and NEXT are saved with the Autotest

When **None** is selected, no sweep data is saved. The worst case NEXT data point for each pair is preserved in the saved Autotest. If you choose to save the NEXT sweep data, then every measured next point is preserved. This permits you to view and print the graphs while viewing an Autotest from memory. If this data is not saved, then the graphical information is not available except immediately after the Autotest has been run, or in **Measure Cable Performance**.

Normally, 500 Autotests can be saved. However, saving full NEXT sweep and Attenuation sweep data drastically reduces the number of Autotests, which can be saved. When saving Attenuation data and both near and far end NEXT sweep data, perhaps only 40 tests can be saved. The specific number of tests that can be saved is indeterminate, since the information is highly compressed prior to saving. A cable, which has a smooth NEXT reading, will compress better than a cable with jumpy NEXT. Also, some Autotests (such as a Category 3) specify the NEXT sweep range to be smaller than a Category 5 Autotest; and fewer Autotests may be stored if the Autotest uses 100 kHz NEXT step size rather than TIA or 200 or 500 kHz steps.

Printing Autotest Results

PRINT FORMAT

To display this screen, press **Print (F3)** from the **AUTOTEST RESULTS** screen. This screen provides a selection of formats for printing Autotest Results.

Press **Change (F2)** to view the available printing formats.

Press **Print (F3)** to select a report format and begin printing.

Press the **ESCAPE** key to return to the **AUTOTEST RESULTS** screen.

Viewing Autotest Results Summary

To display the **TESTS** screen, press **Tests (F4)** from the **AUTOTEST RESULTS** screen.

When using the **2-Way Injector+** (or **2-Way Injector**), the screen indicates if NEXT and ACR test results are from the Scanner or Injector end of the link.

Press the **↓** or **↑** arrow key to scroll through the list of tests and their PASS/FAIL results.

Press **View (F1)** to view the test results for the highlighted test.

Press the **ESCAPE** key to return to the **AUTOTEST RESULTS** screen.

Sample Autotest Report

Company Name		PENTASCANNER+ CABLE CERTIFICATION REPORT		CAT5 Channel Autotest			
Circuit ID:	A001	Date:	15 Jan 96				
Test Result:	PASS	Cable Type:	Cat 5 UTP				
Cable Skew (nS):	3	NVP:	78				
Owner:	PentaScanner	Gauge:					
Serial Number:	38P95EA0032	Manufacturer:					
Inj. Ser. Num:	38T95E00032	Connector:					
SW Version:	V04.30	User:					
Building:		Floor:					
Closest:		Hub:					
Rack:		Port:					
Slot:							
Test	Expected Results	Actual Test Results					
Wire Map	Near: 12345678 Far: 12345678	Near: 12345678S Far: 12345678S					
		Pr 12	Pr 36	Pr 45	Pr 78		
Length	ft 0 - 328	104	105	106	104		
Prop. Delay	nS 0 - 32767	135	137	138	135		
Impedance	ohms 80 - 125	116	115	112	114		
Resistance	ohms 0.0 - 18.8	5.4	5.8	5.4	5.2		
Capacitance	pF 10 - 5600	1232	1257	1311	1240		
Attenuation	dB	5.2	5.1	5.4	5.5		
@Freq	MHz	99.0	92.0	99.0	97.0		
Limit:	dB Cat 5 Channel	23.8	23.0	23.8	23.6		
PENTA Pair Combinations	12/36	12/45	12/78	36/45	36/78	45/78	
NEXT Loss	dB 39.2	38.3	38.1	33.6	32.8	41.7	
Freq(1.0-100.0)	MHz 89.7	81.5	97.1	95.9	99.9	74.3	
Limit: Cat 5 Channel+0.0	dB 27.9	28.6	27.3	27.4	27.1	29.3	
Active ACR	dB 34.5	33.8	32.7	28.4	27.4	37.5	
Frequency	MHz 90.0	82.0	97.0	96.0	100.0	74.0	
Limit: Derived	dB 5.1	7.3	3.7	3.9	3.1	9.3	
INJ Pair Combinations	12/36	12/45	12/78	36/45	36/78	45/78	
NEXT Loss	dB 39.9	38.6	38.4	33.4	35.6	41.8	
Freq(1.0-100.0)	MHz 82.2	81.4	96.6	96.4	78.0	84.0	
Limit: Cat 5 Channel+0.0	dB 28.6	28.6	27.3	27.3	29.0	28.4	
Active ACR	dB 35.6	34.2	33.0	28.4	30.9	36.9	
Frequency	MHz 82.0	81.0	97.0	97.0	78.0	84.0	
Limit: Derived	dB 7.3	7.6	3.7	3.7	8.3	6.7	
Signature:	_____					Date:	_____

1. Heading provides information on the circuit. The Circuit ID is filled in as you save each test result. Some fields in the heading can only be entered using Microtest's Cable Management System (CMS) For Windows.
2. Expected results (factory or user-defined).
3. Actual test results for this cable.
4. An '!' preceding a test result indicates that the test result is outside of the test limits; an asterisk (*) indicates a marginal pass condition.
5. Results for each pair combination.

Chapter 4: Editing, Printing & Updating

Several screens allow editing. For example, you can edit the owner and company names that appear on the opening logo screen and on printed reports. Different Scanners in the **PentaScanner Product Family** have different editing procedures. This chapter explains in more detail the two different editing methods.

Editing with the Alphanumeric Keypad

Use this editing method if your Scanner has an alphanumeric overlay on the keypad. Each character is edited individually; that is, the character being edited is at the cursor position. Alphabetic and special characters are printed above each numbered key on the keypad. For example, **ABC** is printed above the 2 key. With the keypad in **CAPS** mode, press and hold the 2 key to display an A, B, or C. Release the key to place the displayed character in the field that is being edited. The 1 key allows entry of special characters:

-	hyphen
_	underscore
.	period
,	comma
*	asterisk
(left parentheses
)	right parentheses
/	slash
#	pound sign

Press **Del (F2)** to delete the character at the cursor.

Press **CAPS (F3)** (or **caps** or **NUM**) to toggle the keypad between uppercase letters (**CAPS**), lowercase letters (**caps**), or numerals (**NUM**).

Press the **←** or **→** arrow key to move left or right within the string of characters.

Press **Save (F1)** to save the new entries.

Press **Clear (F4)**, when available, to clear the field that is highlighted.

Editing with the Arrow Keys

Use this method if your Scanner does not have an alphanumeric overlay on the keypad. To edit a field, highlight the field and press **Edit (F2)**.

Each character is edited individually; i.e. the character being edited is at the cursor position. Press the **A-Z** key to enter an alphabetic character and press the **↓** or **↑** arrow key to change it. You can hold down the **↓** or **↑** arrow key to scroll through the available characters. Or, press a number key to enter a numeric value.

Press the **←** or **→** arrow key to move left or right within the string of characters.

Press **Del (F1)** to delete the character at the cursor.

Press **Clear (F4)** to erase the contents of the field.

Press **Done (F2)** to exit the editing screen.

Printing or Downloading Test Results

To send test results directly from the Scanner to a printer or PC:

1. Configure the Printer Port settings in the **PRINTER PORT SETUP** screen. To display this screen on the *PentaScanner* or *PentaScanner Cable Admin*, press **Extended Functions** key, then select **Printer Port**. To display this screen on the *PentaScanner+*, press the **Extended Functions** key, then select **User Preferences**, then select **Printer Port**.
1. Press the **↓** or **↑** arrow key to highlight a setting to modify — **Baud rate** or **Handshaking**. The default settings for Baud rate and Handshaking are 9600 and XON/XOFF. The settings for **Data Bits**, **Stop Bits** and **Parity** are fixed at 8, 1 and None and cannot be changed. After highlighting the Baud rate or Handshaking setting, press **Change (F2)** to toggle through the available settings.

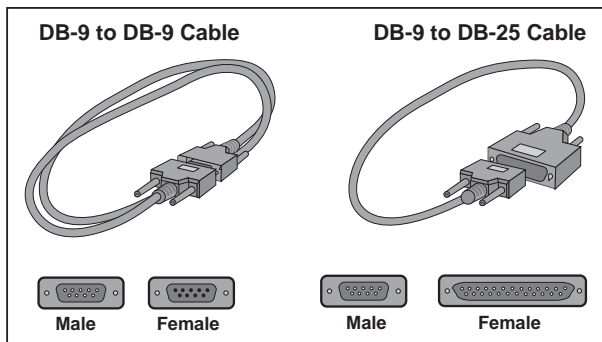

2. Press **Printer (F3)** to display the graphics printer screen. Press **Save (F1)** to store the new settings and exit or press the **ESCAPE** key to exit without saving.
3. Choose the appropriate serial communications cable. A DB-9 to DB-9 serial cable is included in the kit, or you can use a DB-9 to DB-25 cable. Note: The cable must be wired as in **Appendix C: Pin-outs**.

1. Attach the DB-9 end of the cable to the Scanner and the other end to the serial port on the back of the printer or to COM 1 or COM 2 on the back of the PC:

Connection for Printing Test Results

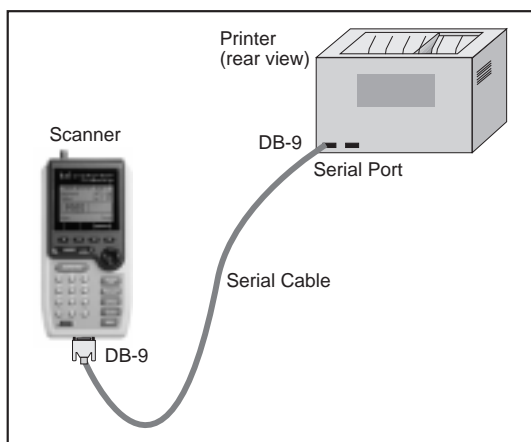

Connection for Downloading Test Results

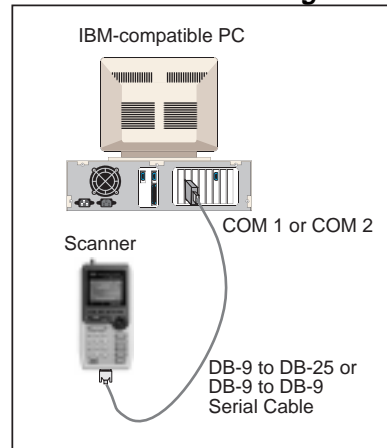

1. Use the **PRINT OPTIONS** screen to set the criteria to determine which Autotests to print. To display the **PRINT OPTIONS** screen, press the **Extended Functions** key, then select **Memory**, then press **Print (F3)**.
2. To display the **PRINT FORMAT** screen, press **Print (F3)** from the **AUTOTEST RESULTS** screen, or press **Print (F3)** from the **PRINT OPTIONS** screen. Press **Change (F2)** from the

PRINT FORMAT screen to select the **PRINT FORMAT** (text or CSV); then press **Print (F3)** to begin printing.

3. If you are sending results to a PC, you can use Microtest's **Cable Management System (CMS) For Windows** (a Microtest accessory available from your distributor) to download Autotest records in Comma Separated Variable (CSV) format. Make sure that the baud rate, parity, handshaking (protocol) and data and stop bit settings in **CMS For Windows** are the same as the Scanner's Printer Port Settings. Refer to the CMS For Windows User Guide for instructions. You can also send results to the PC using Windows™ Terminal Emulation or Procomm Plus® (see below).

Printing Tips

- When printing from the **Extended Functions** menu, you can print all tests that passed or failed by selecting All Pass or All Fail from the **PRINT OPTIONS** screen.
- For best results, print NEXT and Attenuation graphs to a LaserJet printer. The LaserJet printer will print the graph on one page, whereas the Epson format requires two pages to print the same graph.

Uploading Autotest Reports to Windows Terminal

1. With Windows loaded, click on the Accessories window, and select Terminal. If Terminal is not an icon, click on Files, choose Run, and type "TERMINAL.EXE".
2. Select Settings | Communications from the Menu Bar.
3. In the Communications screen, verify that the settings are 9600 Baud, Xon/Xoff, 8 data bits, 1 stop bit and No parity. Choose the appropriate Communications (serial) port. Click OK to save these settings.
4. Select Transfers | Receive Text File from the Menu Bar. In the Receive Text File screen, name the file with a .txt extension. Note the drive and path to which the file will be saved.
5. The screen will now show "Receiving [file.txt]" on the bottom right and "Bytes: 0" on the bottom left.
6. Begin the transfer from the Scanner (see step 7 in **Printing or Downloading Test Results**, above). Select "text" as the Print Format.
7. When the transfer is complete, close Windows Terminal.

You can now use the DOS 'COPY' command to print the text file to a printer; i.e., "COPY filename.txt LPT1".

Uploading Autotest Reports to a PC with Procomm Plus

Procomm Plus for DOS

To send reports to a PC using Procomm Plus for DOS, open Procomm Plus and perform these steps:

1. Press **ALT + P** to enter port parameters. Set the port to be used (COM1 or COM2), the baud rate (default is 9600), the data bits (8), stop bits (1) and parity (None). Make sure that the settings are the same as the Scanner's Printer Port Settings. Press Alt + S to save settings.
2. Press **ALT + S** to select terminal options. Ensure that the handshake method selected is XON/XOFF to match the Scanner's Printer Port Settings.
3. Press **ALT + F1** to open a log file. Type the desired file name. Give the filename a ".TXT" extension to make it easy to locate.

4. Begin the transfer from the Scanner (see step 7 in **Printing or Downloading Test Results**, above). Select “text” as the Print Format. You should see the information scrolling on the Procomm Plus window while the transfer is in progress.
5. When the transfer is complete, press **ALT + F1** again to close the log file. The file will be saved under the current directory.
6. Press **ALT + X** to exit the Procomm Plus package.

You can now use the DOS ‘COPY’ command to print the log file to a printer; i.e., “COPY filename.txt LPT1”.

Procomm Plus for Windows

To send reports to a PC using Procomm Plus for Windows, open Procomm Plus and perform these steps:

1. Press **ALT + S** to select terminal options. Ensure that the handshake method selected is SOFTWARE, set the port to be used (COM1 or COM2). Set the data bits (8), stop bits (1) and parity (None), and set the baud rate to the highest speed that your system will support. Set the terminal setting to VT100. Set the protocol to ASCII. Save the new settings.
2. On the Scanner, press the **Extended Functions** key, then select **Printer Port**. Set the baud rate to match the baud rate set in Procomm Plus and set the handshake to XON/XOFF.
3. Select the download folder. Type the desired file name. Give the filename a “.TXT” extension to make it easy to locate.
4. Begin the transfer from the Scanner (see step 7 in **Printing or Downloading Test Results**, above). Select “text” as the Print Format. You should see the information scrolling on the Procomm Plus window while the transfer is in progress.
5. When the transfer is complete, click OK.
6. Exit Procomm Plus.

You can now use the DOS ‘COPY’ command to print the report file to a printer; i.e., “COPY filename.txt LPT1”.

Uploading NEXT and Attenuation Graphs to a PC with Procomm Plus

Procomm Plus for DOS

1. Open the Procomm Plus application.
2. Press **ALT + P** to enter port parameters. Set the port to be used (COM1 or COM2), the baud rate (default is 9600), the data bits (8), stop bits (1) and parity (None). Press **Alt + S** to save settings.
3. On the Scanner, press the **Extended Functions** key, then select **Printer Port**. Set the baud rate to match the baud rate set in Procomm Plus and set the handshake to RTS/CTS. Press **F3 (Printer)** to display and change the Graphics Printer options. Save these changes.
4. In Procomm Plus, press **Alt + S** to get to the Procomm Plus setup utility.
5. On the Procomm Plus setup utility menu select **FILE/PATH OPTIONS**. On the FILE/PATH OPTIONS menu **select C- Default path for downloaded files (PgDn) x:directory path**. Make sure the path specified is the one to which you would like to save the files.
6. Press **ESC** to return to the Procomm Plus Setup Utility menu. **Select TERMINAL OPTIONS**. On the **TERMINAL OPTIONS** menu, set **C-Soft flow ctrl (XON/XOFF)** to

- OFF.** Set **D-Hard flow ctrl (RTS/CTS)** to **ON**. Press **ESC** to return to the Procomm Plus Setup Utility menu.
7. Press **ESC** to go to the Procomm Plus main screen. Press **PageDown** on the PC keyboard. The **Download Protocols** menu will be displayed.
 8. Select **R** for **R) RAW ASCII** and press **ENTER**. **RAW ASCII DOWNLOAD** will be displayed, with a **Please enter filename:** prompt. Type the file name desired and press **ENTER**. A blank screen with the message **DOWNLOAD IN PROGRESS - PRESS ESC TO END** will display. If you get an **Error Opening File** message, check the path name in item **C** on the **FILE/PATH OPTIONS** screen. Correct this item if necessary and try again.
 9. From the Scanner, start the download of the graph information by pressing **Print (F2)** from the **NEXT GRAPH** or **ATTENUATION GRAPH** screen. When the download is complete, press **ESC** to close the Procomm Plus file.
 10. The **NEXT** and **Attenuation** graph file will be located in the path specified in step 3 above.
 11. Use the DOS copy command to send the **NEXT** graph information to the printer. For example, to print a file named **NXTFILE.ASC**, type **COPY /B NXTFILE.ASC LPT1**.

Procomm Plus for Windows

1. Open the Procomm Plus application.
2. Press **ALT + S** to select terminal options. Ensure that the handshake method selected is **HARDWARE**, set the port to be used (**COM1** or **COM2**). Set the data bits (**8**), stop bits (**1**) and parity (**None**), and set the baud rate to the highest speed that your system will support. Set the terminal setting to **VT100**. Set the protocol to **RAW ASCII**.
3. On the Scanner, press the **Extended Functions** key, then select **Printer Port**. Set the baud rate to match the baud rate set in Procomm Plus and set the handshake to **RTS/CTS**. Press **F3 (Printer)** to display and change the Graphics Printer options. Save these changes.
4. Select the download folder and enter a file name to which you want to save the graph data. For example, you might name the file **TEST.GPH**.
5. From the Scanner, start the download of the graph information by pressing **Print (F2)** from the **NEXT GRAPH** or **ATTENUATION GRAPH** screen.
6. Exit to DOS, and use the DOS copy command to send the **NEXT** or **Attenuation** graph information to the printer. For example, to print the file named **TEST.GPH**, type **COPY /B TEST.GPH LPT1**.

Troubleshooting Printing Problems

Problem: I get a blank page between each test result. How can this be corrected?

Solution: Change the lines per page setting on the printer to 66 lines per page.

Problem: My printout is garbled. Why?

Possible Solution: The Handshaking setting for the printer may not be set correctly. Press the **Extended Functions** key; then select **Printer Port**. Handshaking should be set to **XON/XOFF** on both the Scanner and the printer. Also, make sure the baud rate setting matches that of the printer (9600 baud is the most common baud rate). If you experience problems at this setting, change to a lower baud rate setting. The serial port on the printer cannot always keep up with the flow of data from the Scanner, so if you experience printing problems, **ALWAYS** change to a slower baud rate, rather than a faster baud rate.

Problem: The screen displays Printing . . . but nothing is printing on the printer.

Possible Solution: You must use a “straight through” serial cable. Refer to **Appendix C: Pin-outs** for the cable pin-out specifications. Also, make sure that XON/XOFF handshaking is supported.

Downloading Software Updates

If you are connected to the Internet, our World Wide Web page can be accessed by entering <http://www.microtest.com> in the URL address field. Files are available in the Support Download area after online registration.

You can also download the latest **PentaScanner** files from Microtest's BBS:

1. Use a communications package* for your computer and set the following parameters:
 - Modem speed between 1200 and 57,700 (1200 to 28.8 baud)
 - Data Bits, 1 Stop Bit, No Parity
 - ANSI Terminal Emulation

*Windows “Terminal,” the program that is packaged with Windows 3.x, will not work with Microtest's BBS. Most commercially available communications programs will perform successfully.

2. Dial in to the Microtest BBS:

(602) 957-7716 (U.S.) +44-1293-894031 (U.K.)

3. You will be asked for your name and password. If you are a new user, enter your name and make up a password. Remember to keep a record of the password you used.

4. If you plan to use our BBS more than one time, it may be convenient to first set up a default download protocol:

- From the Main Menu, select Y for Your Settings. Enter 14 between the brackets, and press Enter.
- Select the letter representing the download protocol you will use, e.g., Z for Zmodem. Press Enter.
- Type Q to Quit. Then press Enter.

(Note: You can change your default at any time by following the above procedure and reselecting a protocol.)

5. Press F for Files, D for Download.

6. Type in the name of the file you want, e.g. PS421.EXE, and press Enter.

Note: The file you download will have a **.EXE** extension. This is a “self-extracting archive” program that you will need to run to decompress the update program, Flash image and “README” files.

7. You will be prompted for another file name. Press Enter again to continue.

8. Press D for Download.

Depending upon your communications software, your download may begin immediately or you may need to start it manually. If you did not select a default protocol, you will be prompted to select a download protocol at this time.

9. Press **Q** to Quit back to the Main Menu, and **G** to log off (Goodbye).

Updating Scanner Software from the PC

At this point, you have downloaded the required software update files from the BBS to the PC. Or, you may have been given a diskette containing software update files and have copied them to the PC.

NOTE: The update process will erase all test results stored in memory. If you have any Autotest results stored in memory, print or download the results before updating the software.

1. Connect the DB-9 end of the communications cable to the serial port on the Scanner and the other end (DB-9 or DB-25) to the serial port on the PC.
2. Turn off the Scanner and plug the AC adapter in to the Scanner.
3. Hold down the **AUTOTEST** key and the **Find Cable Faults** key and press the **On/Off** key. The Scanner will turn on and the screen will display:
Waiting for REFLASH

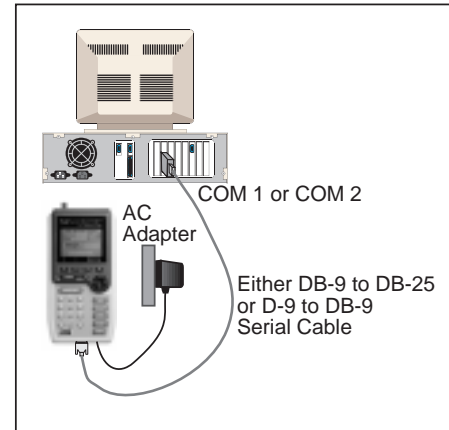

You are now ready to download the new flash update from the PC.

4. From the DOS prompt, type **PENTA -?** and press the **<ENTER>** key on the PC keyboard. The options and default screen will display.
5. Type **PENTA** followed by the COM 1 or COM 2 option (**-C1** or **-C2**), and press the **<ENTER>** key on the PC keyboard.

Examples:

English:	Penta -C1
English (Int'l):	Penta -C1 -E
French:	Penta -C1 -F
German:	Penta -C1 -G
Spanish:	Penta -C1 -S
Italian:	Penta -C1 -I
Japanese:	Penta -C1 -K

These commands update the Scanner with the information stored in the file using COM 1 with the Scanner in “**Waiting for REFLASH**” mode. While the flash is being updated, the PC screen will show a progress graph. This process will take approximately two minutes.

Note: The international Scanners require an international version of software. Attempts to update a non-international version of the Scanner with international versions of software will fail!

6. When the update is complete, the PC will display the DOS prompt. Upon completion, the screen may display:

ERROR
One or more stored
Autotest results have
been lost.

7. If so, press **OK (F1)** to display the **Ready** screen. The software is now updated!
8. To place the real-time clock in 24 hour mode, press the **Extended Functions** key, select **User Preferences** (if you have a **PentaScanner+**), select **Date/Time**, and press **Save (F1)** to store the new settings

To verify the software update, press and hold the Backlight button (located to the right of the **ESCAPE** button). The software version number will be displayed.

Updating the 2-Way Injector+/2-Way Injector

If you have any Autotest results stored in the Scanner, be sure to print or download them to a PC before updating the Injector. The update process will erase ALL Autotest results stored in memory.

1. Connect the DB-9 end of the communications cable to the serial port on the Scanner and the other end (DB-9 or DB-25) to the serial port on the PC.
2. Turn off the Scanner and plug the AC adapter into the Scanner.
3. Hold down the **AUTOTEST** and **Find Cable Faults** keys and press the **ON/OFF** key on the Scanner. The Scanner will turn on and the screen will display:
Waiting for REFLASH
4. Connect the Scanner to the Injector using the Category 5 patch cable provided.
5. Plug the AC adapter into the **2-Way Injector+** (or the **2-Way Injector**).
6. You are now ready to download the new flash update from the PC.
7. From the DOS prompt, type **PENTA -?** and press the Enter key on the PC keyboard. The options and default screen will display.
8. Type **PENTA** followed by the COM 1 or COM 2 option (**-C1** or **-C2**), followed by **-2**, and press the **<ENTER>** key on the PC keyboard. Example:

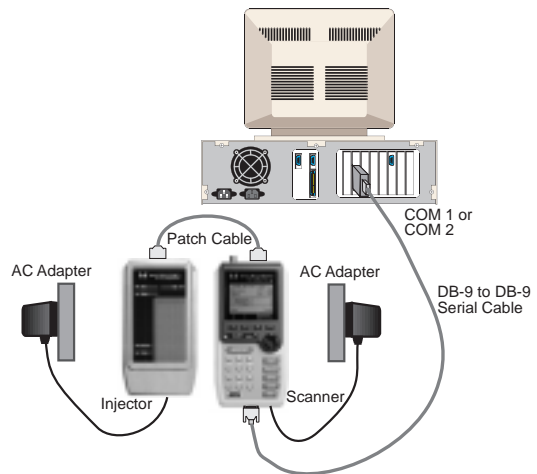

PENTA -C1 -2

- This command updates the 2-Way Injector+ (or the 2-Way Injector) from the flash image downloaded from the BBS. The updated software is downloaded from the PC through the PC COM port to the Scanner. While the software is being downloaded, the PC screen will show a progress graph. This process will take approximately one minute.
9. When the download is complete, the PC displays:

Download of FLASH image file complete.

10. Watch the Scanner screen for REFLASH progress. The Scanner display will show the progress of the update and the **2-Way Injector+** (or the **2-Way Injector**) Status and Pass LEDs will blink during the update. This step will take approximately one minute. When complete, the **2-Way Injector+** (or the **2-Way Injector**) is updated with the new software.
11. To verify the update, press the **Extended Functions** key on the Scanner, then select **Injector Info**. The Scanner will display the new software version.

Technical Support

If you are having problems with the Scanner and cannot find help for your problem in this user guide, you can contact Microtest Technical Support by phone, fax, via the Internet, the Microtest BBS, or CompuServe:

U.S.A. and Canada	1-800-NET-FIXR (1-800-638-3497) (voice)
	1-800-419-8991 (fax)
Europe, Middle East and Africa	+44 1 293 894025 (voice)
	+44 1 293 894008 (fax)

World Wide Web

You can download files and send mail to Microtest via the Internet:

<http://www.microtest.com/>

Microtest Bulletin Board System (BBS)

You can contact Microtest Technical Support and download product update files from the Microtest BBS. To access the BBS, set your communications software to 1200 to 14400 baud; 8 data bits, 1 stop bit, no parity; ANSI terminal emulation, and dial:

(602) 957-7716 (U.S.) or
+44 1 293 894031 (Europe)

FaxFacts

You can request additional information from FaxFacts, Microtest's telephone-operated fax request line. FaxFacts is an on-demand system that allows you to dial in on any touch tone phone and have product information and technical tips faxed to you. To access FaxFacts, dial:

U.S. (602) 952-6450

Follow the voice prompts to request the appropriate document.

Chapter 5: Find Cable Faults

Find Cable Faults traces your cable runs and locates intermittent faults. It also incorporates Time Domain Reflectometry so you can find faults in cables less than 10 feet long. (The **PentaScanner Product Family** has zero dead zone for detecting cable faults.)

Wire Map determines how the cable and connectors are wired, from one end to the other. It is usually run before any other measurements, to pinpoint cabling problems caused by opens, shorts, split pairs or miswires.

Find Cable Faults draws a graphical representation of the cable, showing opens, shorts and miswires. When Wire Map is run, **Find Cable Faults** continuously repeats its testing so the operator can wiggle connectors and wires to locate intermittent faults. **Find Cable Faults** repeatedly runs Length and Wire Map and displays the length and continuity of the entire cable.

Wire Map

The Wire Map screen is displayed when you press the **Find Cable Faults** key. There are primarily four things that can go wrong with a cable or connector:

- A short between wires
- An open on any single wire
- An open across all wires (break)
- An impedance mismatch

If a short or open exists in the cable, isolate the segment you suspect, connect the Scanner to it and run the Length test by pressing the **Measure Cable Performance** key; then selecting **Length**.

An Impedance mismatch is caused by irregularities in the cable and can show up as an open or a short at an unexpected length.

When troubleshooting wiring problems, look for improperly crimped cables — make sure that the outer insulation fits into the end of the connector.

Press **Splits (F1)** to display the wire splits screen. The split status is shown to the right of each wire pair.

Wire Map for Both Ends of the Link

The Injector plays an integral part in determining the wire map for a given link. With the Scanner and the Injector connected at opposite ends of a link or cable, the wire map can be determined. When running Find Cable Faults or Autotest, the Scanner and the Injector communicate to determine how the link is wired. With the wire map on display, press Splits (F1) to display the wire splits screen. The Scanner/Injector combination identifies the following wiring configurations:

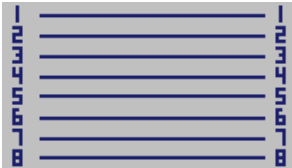

Straight Through Wiring

Straight through wiring (the expected case) is displayed as shown:

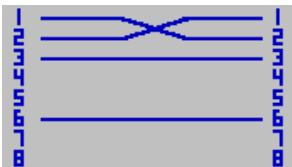

Cross Wiring

Cross wiring is displayed as shown:

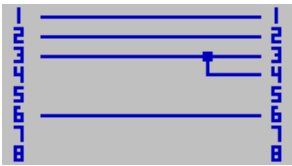

Short at the Injector End

A short at the Injector end is displayed as:

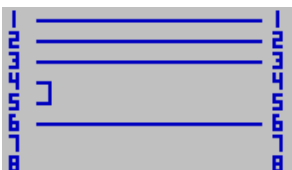

Short at the Scanner End

A short at the Scanner end is displayed as:

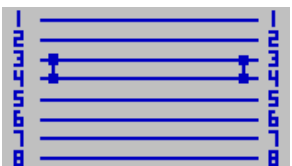

Short on the Link

A short in the link (where wires can be seen at both ends) is displayed as:

Chapter 6: Measure Cable Performance

Measure Cable Performance lets you run individual tests such as NEXT, Attenuation, Length/Delay, Impedance, Loop Resistance, Capacitance, Impulse Noise and Peak to Peak Noise.

Press the **Measure Cable Performance** key to display a list of the tests to run.

Press the **↑** or **↓** arrow key to highlight the test you want to run, then press **Select (F1)** to run the highlighted test.

Press the **ESCAPE** key to return to the Ready screen.

See **Chapter 3: Autotest** for more information on test results for UTP cable.

See **Appendix D: Working with Coaxial Cable** for information on test results for coaxial cable.

NEXT

To display this screen, press the **Measure Cable Performance** key, then select **NEXT**.

This screen displays the frequency sweep range and the worst case NEXT for each pair. When using the **2-Way Injector+** or **2Way Injector**, the top line of the screen indicates if NEXT is being reported from the Scanner end (**Penta**) or the Injector end (**Inj**) of the link.

Press **Graph (F1)** to enter graphing mode.

Press **Sweep (F2)** to display the NEXT Sweep range and step criteria.

Press **Pair (F3)** to toggle through the available pair combinations.

When using the **2-Way Injector+** or **2Way Injector**, press **F4** to toggle between the NEXT results for the Injector end or the Scanner end of the link.

Press the **ESCAPE** key to return to the **MEASURE CABLE PERFORMANCE** screen.

NEXT Graph

To display this screen, press the **Measure Cable Performance** key, then select **NEXT**, then press **Graph (F1)**.

The top line of the screen displays the worst case NEXT and the frequency at which it occurred.

When using the **2-Way Injector+** or **2Way Injector**, the second line of the screen indicates if NEXT is being reported for the Scanner (**Penta**) or Injector (**Inj**) end of the link.

Press **Zoom (F1)** to magnify the area of the graph around the cursor. The Zoom key can display 1x, 2x, 5x or 10x magnification.

Press **Print (F2)** to print the NEXT graph.

Press **Test (F3)** to rerun the NEXT test and display new data.

Press the **ESCAPE** key to return to the **NEXT** results screen.

Note: See **Chapter 3: Autotest** for more information on NEXT testing.

NEXT Sweep

To display this screen, press the **Measure Cable Performance** key, then select **NEXT**, then press **Sweep (F2)**. This screen allows you to select the sweep range and step method for NEXT tests.

If your Scanner has an alphanumeric overlay on the keypad, use the keypad to enter the new sweep limits. If your Scanner does not have an alphanumeric overlay, press **Edit (F2)** to display the edit screen.

Press the **ESCAPE** key to return to the **NEXT** results screen.

Attenuation

To display the **ATTENUATION** screen, press the **Measure Cable Performance** key, then select **Attenuation**.

Press **Graph (F1)** to enter graphing mode.

Press **Sweep (F2)** to display the Attenuation results at different frequencies.

Press **Pair (F3)** to toggle through the available pair combinations.

Press the **ESCAPE** key to return to the **MEASURE CABLE PERFORMANCE** screen.

Attenuation Graph

To display this screen, press the **Measure Cable Performance** key, then select **Attenuation**, then press **Graph (F1)**. This screen displays the Attenuation graph for the indicated pair combination.

Press **Zoom (F1)** to magnify the area of the graph around the cursor. The Zoom key can display 1x, 2x, 5x or 10x magnification.

Press **Print (F2)** to print the Attenuation graph.

Press **Test (F3)** to rerun the Attenuation test and display new data.

Press the **ESCAPE** key to return to the Attenuation screen.

Note: See **Chapter 4: Editing, Printing & Updating** for more information on printing.

Attenuation Limits

To display this screen, press the **Measure Cable Performance** key, then select **Attenuation**, then press **Sweep (F2)**.

This screen allows you to change the Attenuation Sweep range and step criteria.

Press the **↑** or **↓** key to highlight the field to change. Use the Scanner keypad to enter the range values, or press **Change (F2)** to toggle through the Criteria values.

When entering range values, press **Del (F2)** to delete the number at the cursor. On the **PentaScanner+**, there is also a numeric mode, indicated by **NUM (F3)**.

Press **Limits (F4)** to display and change Attenuation limits at various frequencies.

Press **Save (F1)** to store the new values.

Press the **ESCAPE** key to return to the Attenuation screen.

Note: See **Customizing Attenuation Limits in Chapter 3** for more information on Attenuation limits.

Length/Delay

To display the **LENGTH/DELAY** screen, press the **Measure Cable Performance** key, then select **Length/Delay**.

The pairs are shown on the left and the length for each pair is shown in the second column. The third column shows the propagation delay values in nanoseconds (nS) and the fourth column indicates the condition of the wire pair (open or short). The Skew value is the worst-case value of the difference in propagation delay between the wire pairs.

Press the **ESCAPE** key to return to the **MEASURE CABLE PERFORMANCE** screen.

Impedance

To display the **IMPEDANCE** screen, press the **Measure Cable Performance** key, then select **Impedance**.

The pairs are shown on the left and the impedance values in ohms (Ω) are shown on the right.

Press the **ESCAPE** key to return to the Measure Cable Performance screen.

Loop Resistance

To display the **LOOP RESISTANCE** screen, press the **Measure Cable Performance** key, then select **Loop Resistance**.

The pairs are shown on the left and the loop resistance values in ohms (Ω) are shown on the right. Press the **ESCAPE** key to return to the **MEASURE CABLE PERFORMANCE** screen.

Capacitance

To display the **CAPACITANCE** screen, press the **Measure Cable Performance** key, then select **Capacitance**.

The pairs are shown on the left and the capacitance values in picofarads (pF) are shown on the right.

Press the **ESCAPE** key to return to the Measure Cable Performance screen.

Noise

Noise is undesirable electrical activity that interferes with a network's ability to transmit data reliably. Noise sources in networks may include AC transmission lines, fluorescent light fixtures, industrial equipment, elevators, etc. Noise problems also occur when other wire pairs in the same sheath are used for non-LAN applications.

Testing for noise involves turning off all LAN devices and measuring for background electrical activity in the cable. Often, noise problems can be corrected by moving the cable away from the source or removing the source, if possible. Different noise sources radiate at different frequencies. By knowing the frequency of the noise source, you are better able to pinpoint the cause of the noise. Two Noise measurements are provided: Impulse Noise and Peak-to-Peak Noise.

Impulse Noise counts the impulses detected between wires in a pair, or the center conductor and shield (when using a Coax jack). Impulse Noise measurements are used for long term monitoring of the network. They indicate spikes of electrical activity that occur at random on the network.

Peak-to-Peak Noise measures continuous noise signals, in the range of 0 to 3,000 millivolts (mV), between the wires in a pair or the center conductor and shield in the case of coax cable (when using the Coax jack).

Impulse Noise

To display the **IMPULSE NOISE** screen, press the **Measure Cable Performance** key, then select **Impulse Noise**.

A noise impulse is detected when it crosses the selected voltage level. When the selected voltage level is positive, impulses rising above that level are counted. When the selected voltage level is negative, impulses falling below that level are counted.

The wire pair being monitored is indicated in the upper left corner of the display.

The current time of day is displayed below the wire pair.

The box below the current time displays a graph of the impulses detected since the measurement started. The graph can span a 25-hour period with each dot across the graph representing the highest peak impulse in the last 15-minute interval.

The bar graph on the right displays the impulses per second, averaged over the last 10 seconds. **E.T.** indicates the Elapsed Time since the start of the test.

Count indicates the cumulative count of impulses detected since the start of the measurement. When the Count exceeds 65535, **OVR** (Over Range) is displayed. In an Over Range condition, the last average **CPS** (Counts Per Second) recorded is displayed.

CPS indicates the average counts per second since the measurement started. The maximum average counts per second is 200.0.

Press **Pair (F1)** to select a new pair to test. The results from the previously displayed pair are cleared from the screen.

Press **Clear (F2)** to restart the test and clear all history data.

Press **Level (F4)** to change the voltage level for detecting impulses. The results from the previously displayed pair are cleared from the screen.

Press the **ESCAPE** key to return to the Measure Cable Performance screen.

Peak-to-Peak Noise

To display the **PEAK-TO-PEAK-NOISE** screen, press the **Measure Cable Performance** key, then select **P-P Noise**.

The pairs are shown on the left and the Peak-to-Peak Noise values are shown on the right.

If the Peak-to-Peak noise level exceeds 3,000 mV, **OVR** (Overrange) is displayed.

The measurement's bandwidth covers a range of 40 KHz to 30 MHz.

Press the **ESCAPE** key to return to the **Measure Cable Performance** screen.

Chapter 7: Analyze LAN Traffic

Analyze LAN Traffic is a built-in network monitor that shows the current level of LAN traffic activity and monitors network traffic for up to eight hours with the interval set to 5 minutes (using the AC adapter as a power source).

The **Analyze LAN Traffic** feature is useful for tracking down intermittent faults. It can also help you decide if your network needs a bridge or a router because of excessive LAN traffic. It provides even greater flexibility in locating problems, by letting you change the traffic sampling interval simply by pressing **Setup (F4)**.

Note: Analyze LAN Traffic does not monitor Token Ring network traffic.

LAN Traffic Display

To display the **TRAFFIC** screen, press the **Analyze LAN Traffic** key. The **ANALYZE LAN TRAFFIC** screen displays two graphs. The large graph on the left shows a historical "skyline" of activity; representing the percent utilization of the total network. The small bar graph on the right indicates the current level of activity. This indicator should change frequently because of the volatile nature of most network activity. If it is always off or always fully on, you may have a serious problem with your cabling system or LAN hardware.

Press **Clear (F2)** to reset the graph.

Press **Scale (F3)** to toggle between linear and logarithmic scale.

Press **Setup (F4)** to configure the monitor.

Press the **ESCAPE** key to exit.

The Traffic level indicator shows relative activity as follows:

- 0** **No network activity**
- 1-10** **Typical network traffic**
- 11-20** **heavy network traffic**
- 21-40** **Very heavy traffic**
- 41-60** **Overloaded network**
- 61-99** **Probable defective component**

Setting Up the Traffic Monitor

To display this screen, press the **Analyze LAN Traffic** key, then **Setup (F4)**.

This screen lets you change the traffic-sampling interval for the network activity monitor.

Press **Change (F2)** to toggle through the available interval options.

Press **Save (F1)** to store the new setting and exit or press the **ESCAPE** key to exit without saving.

Chapter 8: Extended Functions

Extended Functions Menu

This screen displays the **Extended Functions** available for the Scanner. Press the **↑** or **↓** key to scroll through the available options. Or, press the **←** or **→** key to scroll up and down one screen at a time. Press **Select (F1)** to choose the highlighted option, or press the number on the keypad that corresponds to the option you want.

- Select **Autotest Memory** to manage, view, print and clear saved test results.
- Select **Setup Autotest** to set the default Autotest, edit Autotest names, select pairs to test and/or to include in PASS/FAIL criteria, select the tests to run and customize test limits.
- Select **Calibrate Injector** to calibrate the Injector.
- Select **User Preferences** to edit the owner or company name, specify backlight and auto shutoff time limits, set length units, configure the printer port, or set the date and time. Note: The **PentaScanner** and **PentaScanner Cable Admin** display the units, printer port, and date/time items on the main **EXTENDED FUNCTIONS** menu.
- Select **Injector Info** to display Injector software, hardware and calibration information.
- Select **Cable Trace** to send a traceable signal down a length of attached cable. (**PentaScanner+** only.)
- Select **Office Locator** to determine the room and wall outlet to which a length of cable leads. (**PentaScanner+** only.)

Note: The **PentaScanner** and **PentaScanner Cable Admin** **EXTENDED FUNCTIONS** menu contains an additional item, **LAN Monitor**. This item is identical to the LAN Monitor Setup function under the **Analyze LAN Traffic** key. The **PentaScanner** and **PentaScanner Cable Admin** also displays units, printer port, and date/time setups under the main **EXTENDED FUNCTIONS** menu, not under the **USER PREFERENCE** menu.

Autotest Memory

To display the **MEMORY** screen, press the **Extended Functions** key, then **select Autotest Memory**. This screen lets you view, print or delete the Autotest results you have stored in memory.

Press the **↑** or **↓** arrow key to scroll through the list of stored tests (or **←** to page up and **→** to page down) then press **Select (F2)** to choose the highlighted test.

Press **View (F1)** to display the selected test.

Press **Print (F3)** to print all or selected test results.

Press **Clear (F4)** to erase all or selected test results.

Press the **ESCAPE** key to return to the **EXTENDED FUNCTIONS** screen.
See **Chapter 3: Autotest** for more information.

Autotest Setup

To display the **AUTOTEST SETUP** screen, press the **Extended Functions** key, then select **Setup Autotest**. This screen lets you select the default Autotest, edit Autotest settings and delete user-defined Autotests.

Press the **↑** or **↓** arrow key to scroll through the list of Autotests (or to page up and **→** to page down). When the Autotest you want is highlighted, press **Default (F1)** to select it as the default Autotest.

Note: An Autotest name preceded by an asterisk (*) indicates that the original Autotest has been modified and the Autotest name has not been changed.

Press **Edit (F2)** to change the Autotest name, to select pairs to be used, to select the tests to run, and to set test limits.

Press **Delete (F3)** to delete the highlighted user-defined Autotest.

Press the **ESCAPE** key to return to the **SETUP** screen.
See **Chapter 3: Autotest** for more information.

Editing Autotest Information

To display the **EDIT AUTOTEST** screen, press the **Extended Functions** key, then select **Setup Autotest**, then press **Edit (F2)**. This screen lets you customize Autotest settings.

Press the **↑** or **↓** arrow key to scroll through the available options and press **Select (F1)** to choose the highlighted option. Or, press the number on the keypad that corresponds to the option you want.

- Select **Name/Options** to edit the Autotest name and to change the Margin Options.
- Select **Pairs** to choose the pairs to be tested during Autotest, and to indicate which pairs have PASS/FAIL criteria applied to them during the Autotest.
- Select **Tests to Run** to choose the tests to run during Autotest.
- Select **Limits** to edit test limits.
-

Press the **ESCAPE** key to return to the **AUTOTEST SETUP** screen.

Calibrating the Injector

The Injector must be calibrated each calendar day that you use it to ensure accurate measurements. To calibrate the Injector, connect the Scanner and the Injector with the patch cable supplied with the Scanner. Press the **Extended Functions** key; then select **Calibrate Injector**.

Press **Cancel (F1)** or the **ESCAPE** key to stop the calibration.
See **Chapter 2: Getting Started** for more information on the Injector.

Setting Up User Preferences

To display the **USER PREFERENCE SETUP** screen, press the **Extended Functions** key, then select **User Preferences**. This screen displays the User Preferences options.

Press the **↑** or **↓** arrow key to scroll through the available options and press **Select (F1)** to choose the highlighted option. Or, press the number on the keypad that corresponds to the option you want.

- Select **Owner/Company Name** to edit the owner and company name used on the opening screen and on printed reports.
- Select **Backlight/AutoShutoff** to set the backlight “on time” and to set the automatic shutoff time limits.
- Select **Units** to display the Scanner’s Language and Date Style, and to set Length units. (This item appears in the Extended Functions menu in the *PentaScanner* and *PentaScanner Cable Admin.*)
- Select **Printer Port** to configure the Scanner’s printer port settings. (This item appears in the **Extended Functions** menu in the *PentaScanner* and *PentaScanner Cable Admin.*)
- Select **Date/Time** to set the Scanner’s date and time. (This item appears in the **Extended Functions** menu in the *PentaScanner* and *PentaScanner Cable Admin.*)
-

Press the **ESCAPE** key to return to the **SETUP** screen.

Editing Owner/Company Name

To display the **OWNER/COMPANY NAME** screen, press the **Extended Functions** key, then select **User Preferences**, then select **Owner/Company Name**. This screen lets you select the Owner or Company Name for editing. Use the **↑** or **↓** arrow key to highlight the name to edit, then enter new names with the keypad (if your Scanner’s keypad has an alphanumeric overlay) or **press Edit (F2)** to display the edit screen (if your Scanner’s keypad does not have an alphanumeric overlay). You can enter up to 19 characters for the Owner and Company Names. The names that you enter will appear on printed reports and on the Scanner boot screen.

After editing, press **Save (F1)** to store your changes and exit or press the **ESCAPE** key to exit without saving.

See **Chapter 4: Editing, Printing & Updating** for more information on editing.

Setting Backlight and Auto Shutoff Times

To display the **BACKLIGHT/AUTOSHUTOFF** screen, press the **Extended Functions** key, then select **User Preferences**, then select **Backlight/Auto Shutoff**. This screen lets you specify how long the backlight stays on and lets you specify a time limit for the Scanner to automatically shut off. Press the **↑** or **↓** arrow key to select the Backlight or Auto Shutoff setting. The selected setting will be enclosed in a box. Press **Change (F2)** to view the available settings.

Press **Save (F1)** to store your changes and exit or press the **ESCAPE** key to exit without saving.

Setting Up Units

To display the **UNITS SETUP** screen, press the **Extended Functions** key, select **User Preferences** (if you have a *PentaScanner+*), then select **Units**. This screen displays the current settings for Units (feet or meters), Language and Date Style.

The Language and Date Style fields are preprogrammed. Neither of these fields can be changed. Press **Change (F2)** to toggle the Units setting between feet and meters.

After editing, press **Save (F1)** to store the new Units setting and exit or press the **ESCAPE** key to exit without saving.

Setting Up the Printer Port

To display the **PRINTER PORT SETUP** screen, press the **Extended Functions** key, **select User Preferences** (if you have a **PentaScanner+**), then select **Printer Port**. This screen lets you configure serial printer port settings.

Press the **↓** or **↑** arrow key to highlight a setting to modify — Baud rate or Handshaking.

The default settings for Baud rate and Handshaking are 9600 and XON/XOFF. The settings for Data Bits, Stop Bits and Parity are fixed at 8, 1 and None. Their values cannot be changed.

After highlighting the Baud rate or Handshaking setting, press **Change (F2)** to toggle through the available settings.

Press **Printer (F3)** to display the graphics printer screen.

Press **Save (F1)** to store the new settings and exit or press the **ESCAPE** key to exit without saving. See **Chapter 4: Editing, Printing & Updating** for more information on printing and downloading.

Selecting a Graphics Printer

To display the **GRAPHICS PRINTER** screen, press the **Extended Functions** key, **select User Preferences** (if you have a **PentaScanner+**), then select **Printer Port**, then press **Printer (F3)**. This screen lets you specify the type of printer used for printing NEXT and Attenuation graphs.

Press **Change (F2)** to toggle through the available printer settings.

Press **Save (F1)** to store the new settings and exit or press the **ESCAPE** key to exit without saving.

Setting the Date and Time

To display the **DATE/TIME SETUP** screen, press the **Extended Functions** key, **select User Preferences** (if you have a **PentaScanner+**), then select **Date/Time**.

Press the **↑** or **↓** or **←** or **→** arrow key to select the portion of the date or time field to change. The selected portion of the field will be enclosed in a box.

Press **Change (F2)** to toggle through the available date and time settings.

After editing press **Save (F1)** to store the new date and time settings and exit or press the **ESCAPE** key to exit.

Displaying Injector Information

To display the **INJECTOR INFO** screen, press the **Extended Functions** key, then select **Injector Info**.

The calibration date is shown at the top of the screen, followed by the battery status. The software and hardware versions are displayed below the battery status. The serial number is displayed at the bottom of the screen.

Press the **ESCAPE** key to return to the **EXTENDED FUNCTIONS** screen.

Tracing a Cable

(PentaScanner+ only)

To display the **TRACE CABLE** screen, press the **Extended Functions** key, then **select Cable Trace**.

To trace a cable, use **Microtest's Cable Tracer II** (sold separately) or any other audio amplifier, along with this Scanner. Attach the end of the cable you want to trace to the Scanner's twisted pair or BNC connector. A multi-tone trace signal will begin transmitting. Make sure the cable you are tracing is not grounded. A grounded cable will cause the signal generated by this unit to be very weak. As long as the antenna of the **Cable Tracer II** or similar device is within one foot of the cable, you will hear a multi-tone sound. Trace along the cable where the sound is loudest to determine the cable's path. For more information, refer to the **Microtest Cable Tracer II** Operator Manual or the operator manual for the audio amplification device you are using.

Press **ESCAPE** to exit the Cable Trace function.

Locating an Office Cable Drop

(PentaScanner+ only)

To display the **OFFICE LOCATOR** screen, press the **Extended Functions** key, then **select Office Locator**. Use this function with **Microtest's Office Locator Kit** to find the termination of an office cable drop. Insert the RJ-45 Office Locator plugs into the wall outlets in the offices you wish to locate. At the hub, run the Office Locator function at each connection. The Scanner will display the ID of the Office Locator plug at the far end of the attached cable.

Press **ESCAPE** to exit the Office Locator function.

Appendix A: Specifications

PentaScanner+/PentaScanner/PentaScanner Cable Admin

Physical Characteristics

- Dimensions: 10.2 cm x 20.3 cm x 5.5 cm (4" x 8" x 2.15")
- Weight: 0.79 kg (1lb 12 oz)

Power

- Rechargeable, replaceable battery pack
- Volts @ 1200 mA-Hr
- Built in charger using AC adapter

- Battery life: 8+ hours operation
- AC: 9V DC - 1 amp AC adapter for continuous operation or charging

User Interface

- x 64 Graphic LCD with backlight
- cm x 3.8 cm (2.25" x 1.5") display area
- Elastomeric keypad with tactile feedback, numeric input, dedicated functions, 4 soft functions and cursor pad
- Context-sensitive help and operating instructions
- Tone generation audio for warning or other user feedback
- Date stamp of all tests

Environmental

- Operating Temperature: 0 to 50° C (32 to 122° F)
- Storage Temperature: -10 to 55° C (14 to 131° F)
- Operating Humidity (non-condensing): 10 to 90%
- Storage Humidity: 5 to 95%

Measurement Ports

- ***PentaScanner+***: BNC and 36-pin connector that withstands in excess of 20,000 mating cycles
- ***PentaScanner/PentaScanner Cable Admin***: BNC and shielded Modular 8 (RJ-45) connector
- Testing of all four pairs on RJ-45 is fully supported

Serial Port

- Connector, Cable: DB-9
- Baud rate: 300 to 38,400 baud
- Parity: NONE
- Length: 8 Bits
- Handshaking: None, RTS/CTS, and XON/XOFF

Memory

- Control: Flash memory allows electronic upgrading in remote locations
- Test Storage: Up to 500 complete Autotest results can be stored in permanent flash memory (***PentaScanner+***). Up to 500 complete Autotests results can be stored in battery-backed memory (***PentaScanner, PentaScanner Cable Admin***)

Autotest Functions

- Full suite of tests to determine if cable meets generic cabling or network type requirements (TIA/EIA TSB-67, ISO Class C, D, 10-BASE-T, Token Ring, Fast Ethernet, ATM 155 etc.)
- Up to 20 user definable Autotest programs

Wire Map

- Uses Injector for complete mapping of wiring at both ends of the cable
- Finds miswires, opens, shorts, split pairs
- Includes test of shield if connected

Length

- TDR method determines length and distance to cable faults
- Range: 0 to maximum distance
- where maximum distance = 915 meters (3000 ft) for twisted pair cable
= 1220 meters (4000 ft) for coaxial cable
- Accuracy: $\pm K \pm \text{Length Resolution} \pm \text{NVP uncertainty}$
where $K = \pm 4\%$ of length or 0.6 meters (2 ft), whichever is greater
- Length Resolution: 0.3 meters (1 ft)

PentaScanner+ NEXT and Attenuation Measurement Performance Specifications

PentaScanner+ NEXT and Attenuation Performance Parameters @ 100MHz	Testing through 36-Pin Connector		Testing through Mod 8 Adapter
	Typical	Max	Typical
Dynamic Accuracy (dB)	0.3	0.5	0.3
Residual NEXT (dB)	67	62	45
Output Signal Balance (dB)	50	43	40
Common Mode Rejection (dB)	45	38	34
Random Noise (dB)	78	75	78
Transmit Return Loss (dB)	26	23	20
Receive Return Loss (dB)	22	17	17
NEXT Accuracy (dB) @ 100 MHz	0.5 (*1)	0.9 (*1)	1.5 (*2,3)
Atten. Accuracy (dB) @ 100 MHz	0.3 (*4)	0.6 (*4)	0.6 (*3,4)

*Notes:

- (1) NEXT accuracy is calculated at the Basic Link Limit (29.3 dB) per error model in TSB-67 A.3
- (2) NEXT accuracy is calculated at the Channel Limit (27.1 dB) per error model in TSB-67 A.3
- (3) Performance assumes a high performance modular 8 plug
- (4) Attenuation accuracy calculated per error model in TSB-67 A.3

Near-End Crosstalk (NEXT)

- Tests all six pair combinations
- Frequency range 0.7 to 100 MHz
- Sweep Mode 0.1 MHz, 0.2 MHz, 0.5 MHz linear or TIA (user selectable)
- Dynamic Range:
 - PentaScanner+:** Measurement dynamic range > 75 dB
 - PentaScanner/ PentaScanner Cable Admin:** At least 15 dB > 568A
- Measurement Accuracy:
 - PentaScanner+:** Calculated per TIA TSB-67 error model (see NEXT and Attenuation Specifications table)
 - PentaScanner/ PentaScanner Cable Admin:** 1.5 dB when measured ± 1.5 dB when measured using fixed attenuators
- Measurement resolution: 0.1 dB

Attenuation

- Tests all four pairs using far end active signal injection

- Frequency range
PentaScanner+: 1.0 to 100 MHz
PentaScanner/PentaScanner Cable Admin: 1.0 to 100 MHz
- Sweep mode: Swept 1- 100 MHz using 1 MHz step or fixed points (1.0, 2.0, 4.0,5.0, 8.0, 10, 16.0, 20, 25, 31.25, 62.5, and 100 MHz)
- Dynamic Range: 0 - 50 dB
- Measurement Accuracy:
PentaScanner+: Calculated per TIA TSB-67 error model (see NEXT and Attenuation Specifications table)
PentaScanner/PentaScanner Cable Admin: 1.5 dB
- Measurement resolution: 0.1 dB

Impedance

- Range: 40 to 200 ohms
- Accuracy: ± 5 ohms
- Resolution: 2 ohms

Loop Resistance

- Range: 0 to 10000 ohms
- Accuracy: ± 0.3 ohms @ 0 to 15 ohms
 $\pm 2\%$ @ 15 to 109 ohms (**PentaScanner+**)
 $\pm 2\%$ @ 15 to 200 ohms (**PentaScanner/PentaScanner Cable Admin**)
 $\pm 5\%$ @ 109 to 5000 ohms (**PentaScanner+**)
 $\pm 5\%$ @ 200 to 5000 ohms (**PentaScanner/PentaScanner Cable Admin**)
 $\pm 10\%$ @ 5000 to 10000 ohms
- Resolution: 0.1 ohms 0 to 200 ohms
1.0 ohms 200 to 9.999K ohms

Capacitance

- Range: 0 to 100,000 pF
- Accuracy: ± 20 pF 0 to 200 pF
 $\pm 10\%$ 200 to 100,000 pF
- Resolution: 5 pF 20 to 1000 pF
50 pF 1000 to 100,000 pF

Impulse Noise

- Detects the occurrence of narrow impulse type events exceeding an adjustable threshold of $\pm 0.262, 0.524, 1.0, 2.0$ or 2.5 volts. Instantly displays up to 200 impulse noise events per second. Graphically logs and displays impulse events for up to 25 hours. Termination impedance: 200 ohms.

Peak to Peak Noise

- Measures the peak to peak voltage of steady state noise signals.
- Range: 0 to 3,000 mVpp into 100 ohms.
- Bandwidth: 3dB from 40 kHz to 30 MHz

High Voltage Input/Protection

- The test interface withstands input hazard conditions that arise from normal telephone interfaces (48 VDC at less than 80 mA) or 24 VAC power used to power many telephone keysets.

2-Way Injector+/2-Way Injector

Environmental, Physical Characteristics, User Interface, Measurement Port

Refer to specifications for ***PentaScanner+ / PentaScanner / PentaScanner Cable Admin***

LED Displays

- Pass Indicator (GREEN) for test result
- Fail Indicator (RED) for test result
- Status Indicator (GREEN) for 2-Way Injector status
- Charging Indicator (RED) for battery status
- Hazard Indicator (RED) for high voltage input protection warning

Audible Feedback

- Programmable tone generation through a piezo-electric transducer to signal test is complete or overvoltage conditions

Rechargeable Battery

- Removable, rechargeable Nickel Cadmium (Ni-Cd)
- Capacity: 1200 mAh
- Battery Life: 8+ hours daily operation
- Charging Time: 14 hours (via AC Adapter)
2-3 hours (via Battery Charger)

High Voltage Input/Protection

- The test interface withstands input hazard conditions that arise from normal telephone interfaces (48 VDC at less than 80 mA) or 24 VAC power used to power many telephone keysets.

FLASH Memory

- 128K FLASH memory is provided to allow for software updates in the field

Power Control

- AC Adapter or Battery
- Auto-shutoff when operating on battery
- Power on under Scanner control

Injector End Termination to Support Scanner Measurements

- OPEN (during Impedance, Capacitance, and Length measurements and during Communication)
- SHORT (during Loop Resistance measurements)
- 100 Ohm Termination (during NEXT measurements)
- Swept signal injections during Autotest

2-Way Injector+ NEXT Measurement Performance Specifications

20Way Injector+ NEXT Performance Parameters @ 100MHz	Testing through 36-Pin Connector		Testing through Mod 8 Adapter
	Typical	Max	Typical
Dynamic Accuracy (dB)	0.3	0.5	0.3
Residual NEXT (dB)	67	62	45
Output Signal Balance (dB)	50	43	40
Common Mode Rejection (dB)	45	38	34
Random Noise (dB)	78	75	78
Transmit Return Loss (dB)	26	23	20
Receive Return Loss (dB)	22	17	17
NEXT Accuracy (dB) @ 100 MHz	0.5 (*1)	0.9 (*1)	1.5 (*2,3)

*Notes:

- (1) NEXT accuracy is calculated at the Basic Link Limit (29.3 dB) per error model in TSB-67 A.3
- (2) NEXT accuracy is calculated at the Channel Limit (27.1 dB) per error model in TSB-67 A.3
- (3) Performance assumes a high performance modular 8 plug

Near-End Crosstalk (NEXT)

- Tests all six pair combinations
- Frequency range 0.7 to 100 MHz
- Sweep Mode 0.1 MHz, 0.2 MHz, 0.5 MHz linear or TIA (user selectable)
- Dynamic Range:
 - 2-Way Injector+:** Measurement dynamic range > 75 dB
 - 2-Way Injector:** At least 15 dB greater than required by EIA/TIA 568A Annex E for Category 5 link and ISO 11801 Class D performance or 60 dB, whichever is less
- Measurement Accuracy:
 - 2-Way Injector+:** Calculated per TIA TSB-67 error model (see 2-Way Injector+ NEXT Injector Specifications table)
 - 2-Way Injector:** ±1.5 dB when measured using fixed attenuators
- Measurement resolution: 0.1 dB

Super Injector+/Super Injector

Physical Characteristics

- Dimensions: 7.62 cm x 16.5 cm x 3.25 cm (3.0" x 6.5" x 1.28")
- Weight: 0.255 kg (9 oz)

Power

- AA Alkaline batteries
- Battery Life: Varies depending on usage and battery quality. On average, the batteries will withstand testing of well over 500 cables.

Features

- Automatic power control from Scanner
- Status indicators: Active, Test Passed, Test Failed

- Built in protection from normal telephone circuit power voltages
- Audio alert to signal test complete and overvoltage line conditions
- Active signal generator (up to 100 MHz) to measure one-way cable attenuation
- Supports testing of all 4 pairs

Environment

- Refer to specifications for ***PentaScanner+ / PentaScanner / PentaScanner Cable Admin***

Supported Cabling/Network Types

- Arcnet
 - Apple local talk
 - ATM 51 Mbps
 - ATM 155 Mbps
 - Cat 3 Channel & Basic Link
 - Cat 4 Channel & Basic Link
 - Cat 5 Channel & Basic Link
 - CDDI
 - ISDN
 - ISO Class C
 - ISO Class D
 - Multimedia 802.9
 - Token Ring 4 MHz
 - Token Ring 16 MHz
 - TPPMD
 - TPDDI
 - T1/E1
 - 10BASE-T
 - 100 BaseX
 - 100 VG Any LAN
- User-defined network types are also supported. See Microtest's Category 5 Cable Testing Handbook for more information on network types.

Appendix B: 150 ohm Cables

Working with 150 Ohm Cables

If you are using 150 ohm cable, adjust the minimum and maximum Impedance limits $\pm 10\%$ to 135 and 165 ohms.

First, make sure that the cable type for which you are changing the Impedance limits has been selected as the default cable type. To select the default cable type, press **Cable (F1)** from the **Ready** screen, highlight the desired cable type, and press **Default (F1)**.

To display the **IMPEDANCE LIMITS** screen, press the **Extended Functions** key, then **select Setup Autotest**, then highlight the Autotest to edit, then press **Edit (F2)**, then select **Limits**, then select **Impedance**.

Press the **↑** or **↓** arrow keys to highlight the field to edit. If your Scanner has an alphanumeric overlay on the keypad, use the keypad to enter the limits. If your Scanner does not have an alphanumeric overlay, press **Edit (F2)** to display the edit screen. Change the Minimum limit to 135 and the Maximum limit to 165. See **Chapter 4: Editing, Printing & Updating** for more information on editing.

After editing, press **Save (F1)** to store the new limits and press the **ESCAPE** key to exit.

Creating a Cat 5 Test for Token Ring

1. At the **Ready** screen, press the **Extended Functions** key and select **Setup Autotest**.
2. Highlight the **Cat 5 Link** Autotest and press **Edit (F2)**.
3. Select **Pairs**.

4. Use the arrow keys and the **Unsel/Sel (F2)** key so that the only pairs selected (marked with a x) are 36 and 45.
5. Press **Save (F1)**.
6. Select **Limits**.
7. Select **Impedance**. Change the Minimum limit from 80 to 135. Change the Maximum limit from 125 to 165. Press **Save (F1)** to save the new limits.
8. Press the **ESCAPE** key twice.
9. Press **Default (F1)** to select “***Cat 5 Link**” as the default Autotest. The “*” indicates that this is a user-defined Autotest.
10. If the length of cable that you are testing is near 328 feet, you may need to change the maximum Length limit from 328 to 361 feet. Other limits such as the Loop Resistance and Capacitance may also need to be changed proportionately to the increase in Length limit if these tests are failing marginally.
11. You are now ready to press the **AUTOTEST** key to run the Token Ring Cat 5 Autotest.

Appendix C: Cable Pin-outs

Cable Pin-outs

B-9 Female	DB-9 Male
1	1
2	2
3	3
4	4
5	5
6	6
7	7
8	8
9	9

Serial Cable DB-9 Female to DB-9 Male Pin-outs

B-9 Female	DB-25 Male
1	8
2	3
3	2
4	20
5	7
6	6
7	4
8	5
9	22

Serial Cable DB-9 Female to DB-25 Male Pin-outs

Serial Cable DB-25 Female to DB-25 Male Pin-outs

B-9 Female	DB-9 Male
2	2
3	3
4	20
5	5
6	6
7	7
8	8
20	4
22	22

Cable Pin-Out Signals

The signals for the cable pin-outs are as follows:

DB-9 Male Pin	DB-25 Male Pin	Signal	DB-25 Female Pin	DB-9 Female Pin	Signal Description
5	7	GND	7	5	Protective Ground
3	2	TXD	2	3	Transmitted Data
2	3	RXD	3	2	Received Data
7	4	RTS	4	7	Request to Send
8	5	CTS	5	8	Clear to Send
4	20	DTR	20	4	Data Term Ready
6	6	DSR	6	6	Data Set Ready
1	8	RLSD	8	1	Received Line Signal Detector
9	22	RI	22	9	Ring Indicator

Appendix D: Working with Coaxial Cable

Coaxial cable is a common type of cable used for network data transmission. In coaxial cable, an insulated wire runs through the middle of the cable and a second wire, called the shield, surrounds the insulation of the inner wire like a sheath. The outer insulation jacket wraps around the second wire.

By pressing the **Measure Cable Performance** key, you can test Length/Delay, Impedance, Loop Resistance, Capacitance, Impulse Noise and Peak-to-Peak Noise for coaxial cable. NEXT and Attenuation are not supported for coaxial cable.

NOTE: The Injector is not used when testing coaxial cable.

Length/Delay Test Results

To display the **LENGTH/DELAY** screen, from the **Ready** screen, press **Jack (F4)** and set the Jack to Coax. Then press the **Measure Cable Performance** key, then select **Length/Delay**.

During the Length/Delay test, the cable should be open or shorted.

If **NEF** (No End Found) is displayed next to the Length, it indicates that the cable is properly terminated or the cable is too long.

The IEEE Length specification is 600 feet.

Press the **ESCAPE** key to exit.

Impedance Test Results

To display the **IMPEDANCE** screen, from the **Ready** screen, press **Jack (F4)** and set the Jack to Coax. Then press the **Measure Cable Performance** key, then select **Impedance**.

During the Impedance test, the cable can be open, shorted or terminated. There is no preference.

If **UND** (Under range) is displayed, the cable is less than 40 feet long or the Impedance is less than 40 ohms.

If **OVR** (Over range) is displayed, the Impedance is greater than 200 ohms, the cable is less than 40 feet long, or the cable/pair is not connected.

The IEEE Impedance specification is 50 ohms, ± 2 ohms.

Press the **ESCAPE** key to exit.

Loop Resistance Test Results

To display the **LOOP RESISTANCE** screen, from the **Ready** screen, press **Jack (F4)** and set the Jack to Coax. Then press the **Measure Cable Performance** key, then select **Loop Resistance**.

During the Loop Resistance test, the cable should be terminated or shorted.

If **OVR** (Over range) is displayed, the Loop Resistance is greater than 10K ohms.

The IEEE Loop Resistance specification is 14.6 ohms.

Press the **ESCAPE** key to exit.

Capacitance Test Results

To display the **CAPACITANCE** screen, from the **Ready** screen, press **Jack (F4)** and set the Jack to Coax. Then press the **Measure Cable Performance** key, then select **Capacitance**.

During the Capacitance test, the cable should be open.

If **OVR** (Overrange) is displayed, the Capacitance is greater than can be measured or the cable is properly connected.

Press the **ESCAPE** key to exit.

Impulse Noise Test Results

To display the **IMPULSE NOISE** screen, from the **Ready** screen, press **Jack (F4)** and set the Jack to Coax. Then press the **Measure Cable Performance** key, then select **Impulse Noise**.

During the Noise test, the cable can be open, shorted or terminated. There is no preference.

Press **Clear (F2)** to clear the graph.

Press **Level (F4)** to change the voltage level for detecting impulses.

Press the **ESCAPE** key to exit.

Peak-to-Peak Noise Test Results

To display the **PEAK-TO-PEAK NOISE** screen, from the **Ready** screen, press **Jack (F4)** and set the Jack to Coax. Then press the **Measure Cable Performance** key, then select **P-P Noise**.

During the Noise test, the cable can be open, shorted or terminated. There is no preference.

Press the **ESCAPE** key to exit.



MICROTEST®

4747 North 22nd Street Phoenix, AZ 85016-4708
(602) 952-6400 FAX (602) 952-6401

Microtest Europe
2A Kingfisher House, Northwood Park, Gatwick Road
Crawley, West Sussex, RH102XN, United Kingdom
+44 1293 894000, FAX +44 1293 894008

<http://www.microtest.com>

Part Number 2938-4509-03E Rev 1 3/96

Free Manuals Download Website

<http://myh66.com>

<http://usermanuals.us>

<http://www.somanuals.com>

<http://www.4manuals.cc>

<http://www.manual-lib.com>

<http://www.404manual.com>

<http://www.luxmanual.com>

<http://aubethermostatmanual.com>

Golf course search by state

<http://golfingnear.com>

Email search by domain

<http://emailbydomain.com>

Auto manuals search

<http://auto.somanuals.com>

TV manuals search

<http://tv.somanuals.com>