

LightSPEED™



DELTA X10/X12
Wireless
Sound
System

User's Manual



LightSPEED

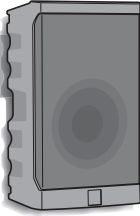

Table of Contents

System Overview	1
System Controls and Functions:	
Base Unit	2
Wireless Receivers	4
Wireless Transmitter - <i>handheld microphone</i>	5
Wireless Transmitter - <i>belt-pack</i>	6
CD Player	7
System Installation:	
Power/Charging	8
Speaker Stand - <i>tripod</i>	9
Speaker/System Placement	10
Operating Instructions:	
Base Unit	11
Wireless Microphones	12
Wired Microphones	13
CD Player	14
Active Link	15
External Speakers	16
External Audio IN/OUT	17
Wireless Receivers	18
Installing or Replacing a Receiver Module	19
Wireless Transmitter - <i>handheld microphone</i>	20
Wireless Transmitter - <i>belt-pack</i>	23
CD-Player	26
Trouble Shooting Guide	28
Specifications:	
Base Unit/Transmitters	29
Channel/Frequency Assignments	30
Components & Accessories	30
Warranty Information/Equipment Log	31
User Notes	32



LightSPEED is a trademark of LightSPEED Technologies, Inc. Other names and brands may be claimed as the property of others. Copyright © 2005 LightSPEED Technologies, Inc., All rights reserved. Printed in USA.



The DELTA X10 and X12 Wireless Sound Systems are powerful, rugged, and durable amplification systems designed for medium to large-sized groups both indoors and out. The systems contain inputs for up to two UHF wireless microphone receivers, optional integrated CD Player, two inputs for wired microphones, and an input for a line level audio source coming from a DVD player, TV/VCR, Computer, etc. There is also a line output to connect to an external source such as a mixing console, an assistive listening system or a recording device. Users can also connect to a passive speaker or a powered speaker in order to cover a larger area. The systems operate on rechargeable battery power for up to 10 hours, and can also be plugged into AC power if longer run-time is desired. An optional 12VDC cigarette lighter adaptor provides the ability to operate the systems using the battery in your car in situations where there is no AC power available.

The wireless receivers contain 100 user-selectable frequencies ranging from 620 MHz to 745MHz. Each receiver contains a Clear Channel Scan feature (a touch of a button automatically selects a clear frequency), low battery indicator (for the transmitter), and adjustable squelch control. The systems are available with a variety of handheld, lapel, and headset microphones.

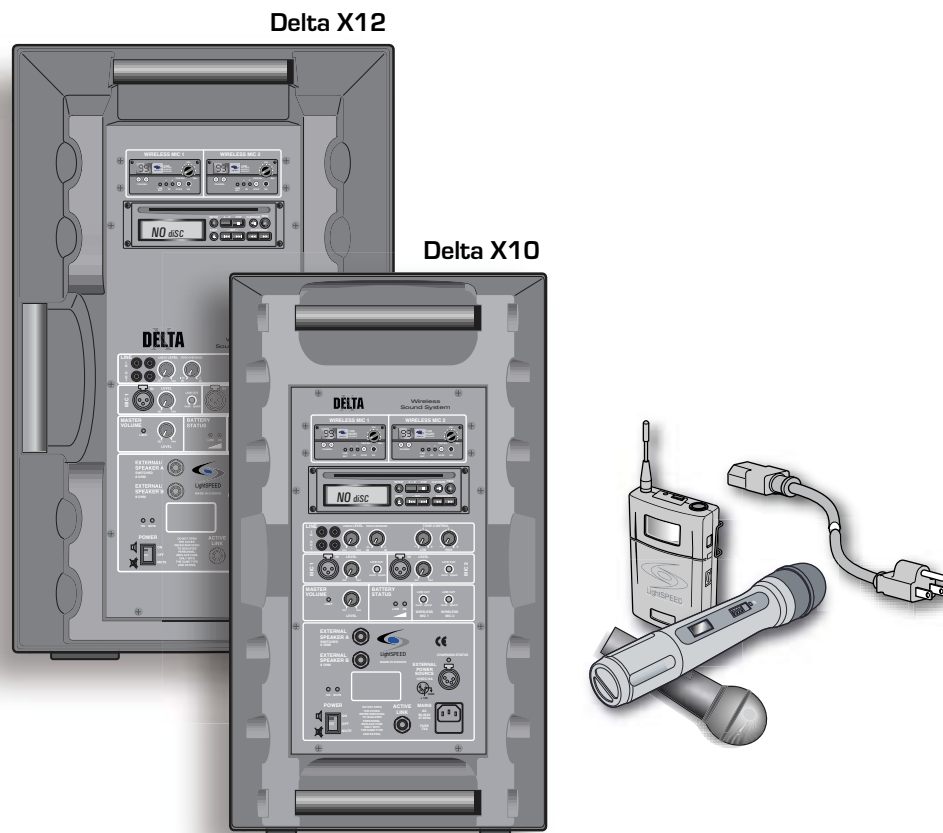

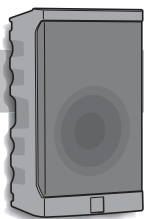

System Base Unit

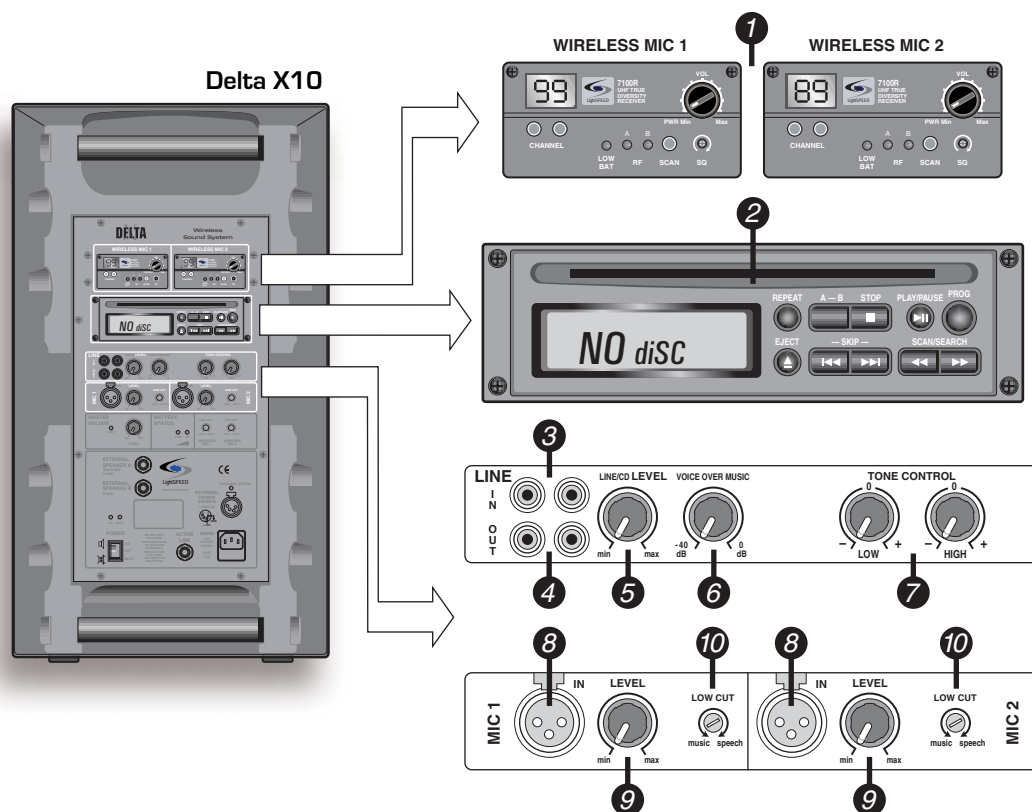

SYSTEM CONTROLS and FUNCTIONS

1. **WIRELESS MIC 1/WIRELESS MIC 2:** These may be wireless receivers or blank filler panels depending on your system configuration.
2. **CD PLAYER:** This may be a CD player or a blank filler panel depending on your system configuration.
3. **LINE IN:** RCA input jacks from an external audio device such as a TV, DVD, Computer, or MP3 player.
4. **LINE OUT:** RCA output jacks to send a line level audio signal to an external device such as a mixing console, recording device, or assistive listening transmitter.
5. **LINE/CD LEVEL:** Controls the level of the Line In jacks and the CD player.
6. **VOICE OVER MUSIC:** Automatically lowers the volume of the audio from the Line In jacks and the CD player when any sounds are produced at the microphone inputs. Turn the VOICE OVER MUSIC control down for less Line In/CD signal when microphones are in use.
7. **TONE CONTROL:** These control the levels of the LOW and HIGH frequencies (bass and treble) for the CD player and Line In jacks. These controls DO NOT affect the microphone inputs.
8. **MIC 1 IN/MIC 2 IN:** These XLR connectors provide balanced inputs with phantom power for wired microphones or external wireless systems.
9. **MIC 1 LEVEL/MIC 2 LEVEL:** These control the levels of the wired microphone inputs.
10. **MIC 1 LOW CUT/MIC 2 LOW CUT:** These controls allow users to cut out the low frequency sound of the wired microphones, making the speech more intelligible.

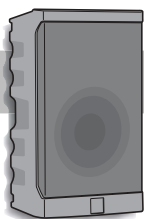

Controls and Functions

System Base Unit ... continued

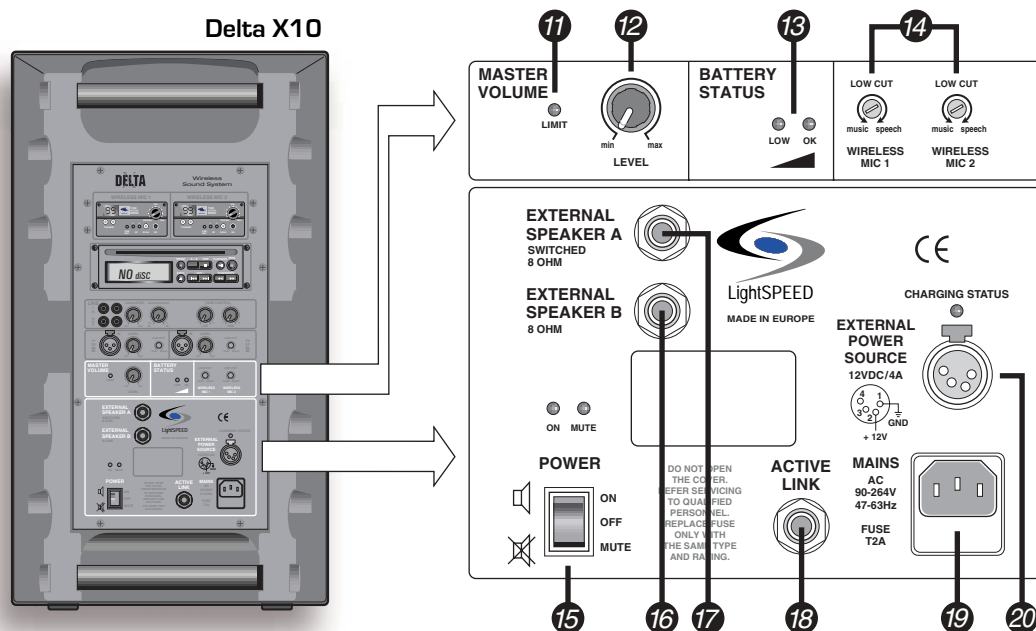

11. **LIMIT:** This LED lights up when the limiter is active, meaning that the power amplifiers are at maximum output.
12. **MASTER VOLUME:** Controls the overall volume level of the sound reaching the speaker(s).
13. **BATTERY STATUS:** Indicates charge level of the internal batteries.
14. **LOW CUT WIRELESS MIC 1/LOW CUT WIRELESS MIC 2:** These controls allow users to cut out the low frequency sound of the wireless microphones, making the speech more intelligible.
15. **POWER:** This switch turns the system ON and OFF. MUTE turns the system on while muting the internal and/or external speaker(s).
16. **EXTERNAL SPEAKER B:** This ¼" phone connector provides a powered output for an external passive speaker (*provides full sound to both the DELTA X internal speaker and the external speaker*).
17. **EXTERNAL SPEAKER A SWITCHED:** This ¼" phone connector provides a powered output for an external passive speaker (*mutes the DELTA X internal speaker and provides full sound to the external speaker*).
18. **ACTIVE LINK:** This balanced ¼" phone connector provides an audio link to another Delta X10 or Delta X12 system. When connected properly, the sound from both Delta X systems is 'shared' between them. *Using ACTIVE LINK, you can double the available inputs and sound level.*
19. **MAINS:** This IEC connector is used for operating the system and charging the internal batteries from an AC source.
20. **EXTERNAL POWER SOURCE:** Provides a secondary power input for operation from 12VDC when the batteries are discharged.



Controls and Functions

Wireless Receiver(s)

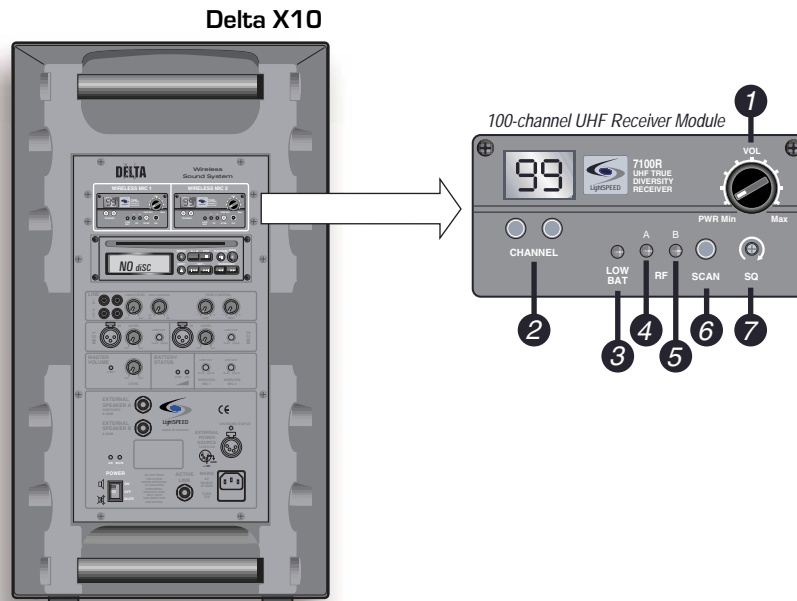

7100R WIRELESS RECEIVER CONTROLS and FUNCTIONS

1. **Wireless Receiver Power/Volume Adjustment:** Turn this knob clockwise to power up the receiver. Rotate to adjust the audio output level.
2. **Channel Control:** Manually select the desired channel (00-99) by pressing these two buttons.
3. **Transmitter Low Battery Indicator:** This LED lights to indicate a low battery level in the transmitter (*handheld or belt-pack*) that is set to the same channel.
4. **RF Channel "A" Indicator:** The "A" LED lights up indicating the "A" channel tuner is receiving the strongest RF signal.
5. **RF Channel "B" Indicator:** The "B" LED lights up indicating the "B" channel tuner is receiving the strongest RF signal.
6. **Scan Button:** Press this button to automatically select a channel that is free from interference.
7. **Squelch Adjustment:** Adjusts the squelch level for elimination of RF interference.

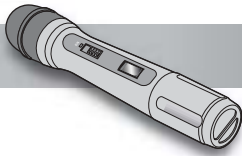

Wireless Transmitter Handheld Microphone

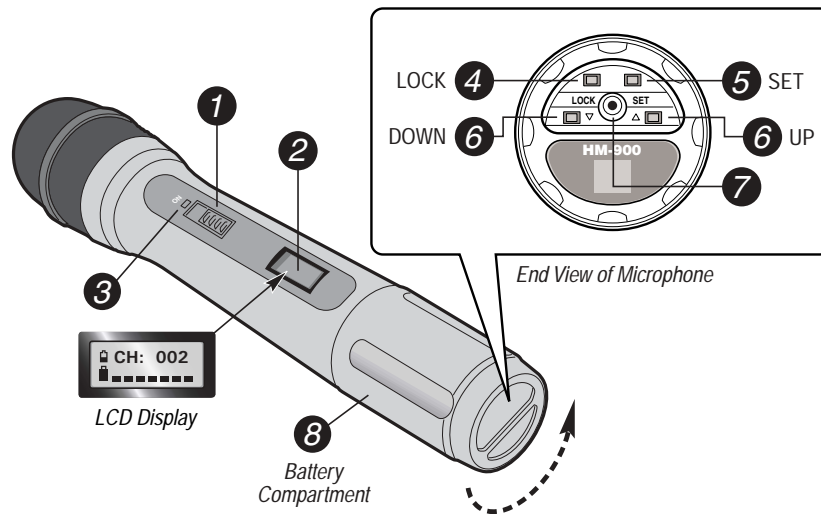

HM-900 HANDHELD MICROPHONE CONTROLS and FUNCTIONS

1. **Power Switch:** Turns the transmitter ON.
2. **LCD Display:** Information screen appears when the power is switched on.
3. **Red LED:** Lights up briefly when power is switched on.
4. **Lock Button:** Locks all microphone controls.
5. **Set Button:** This button is used to enter and save changes to the transmitter settings.
6. **Up and Down Buttons:** These buttons scroll up and down between setup screens on the LCD display. They are also used to enter changes in each setup screen.
7. **Battery Charge Jack:** Optional battery charger plugs in here (for NiMH batteries only).
8. **Battery Compartment:** Bottom section of microphone barrel unscrews to reveal battery compartment.



Wireless Transmitter Belt-pack

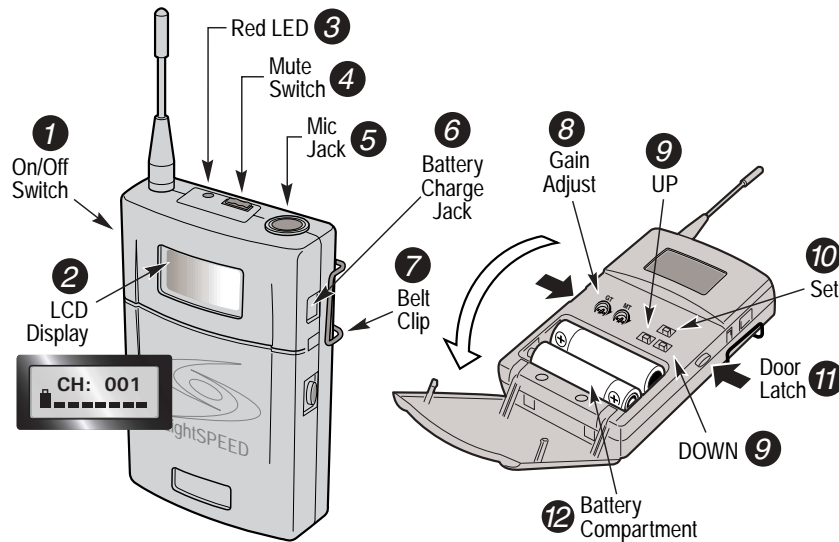

BP-900 BELT-PACK TRANSMITTER CONTROLS and FUNCTIONS

1. **Power Button:** Turns the transmitter ON. (*Hold for two seconds.*)
2. **LCD Display:** Information screen appears when the power is switched on.
3. **Red LED:** Lights up briefly when power is switched on, flashes continuously when audio signal is muted.
4. **Mute Switch:** Turns the audio signal on or off. *The red LED will flash when MUTE is engaged.*
5. **Microphone Jack:** Microphone connects to transmitter here.
6. **Battery Charge Jack:** Optional battery charger plugs in here (*for NiMH batteries only*).
7. **Belt Clip**
8. **Gain:** Provides adjustment for differing voice levels and microphone sensitivities.
9. **UP and Down Buttons:** These buttons scroll up and down between setup screens on the LCD display. They are also used to enter changes in each setup screen.
10. **Set Button:** This button is used to enter and save changes to the transmitter settings.
11. **Door Latch:** A door latch button is located on each side. Press both to open the battery compartment door.
12. **Battery Compartment**

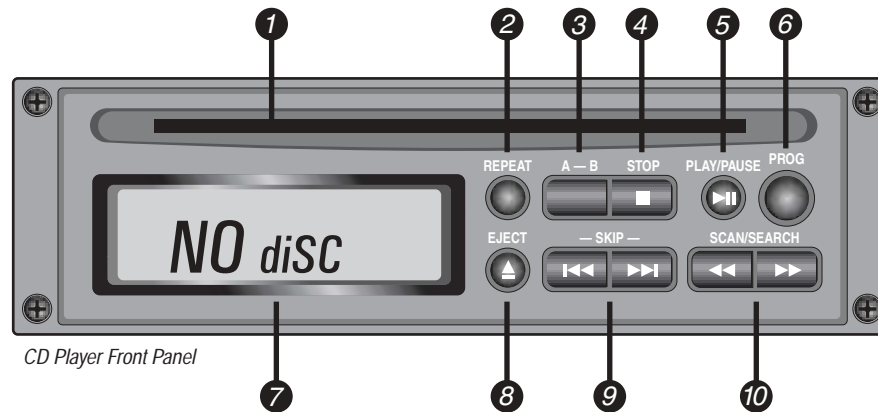

CD PLAYER CONTROLS and FUNCTIONS

1. **CD Slot:** Insert CD here.
2. **REPEAT Button:** Press once to repeat a track, press twice to repeat an entire disc or playlist.
3. **A-B Button:** Sets start and end points for a playback loop.
4. **STOP Button:** Stops playback.
5. **PLAY/PAUSE Button:** Starts playback or pauses playback.
6. **PROG Button:** Used to create playlists.
7. **LCD Display:** Shows information about the disc and current mode of operation.
8. **EJECT Button:** Ejects the disc.
9. **SKIP Buttons:** Skips to the beginning of the next or previous track.
10. **SCAN/SEARCH Buttons:** Similar to fast forward and rewind. Moves quickly forward or backward through the disc while playing 'snippets' to allow searching.

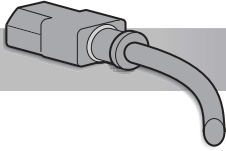

Power/Charging

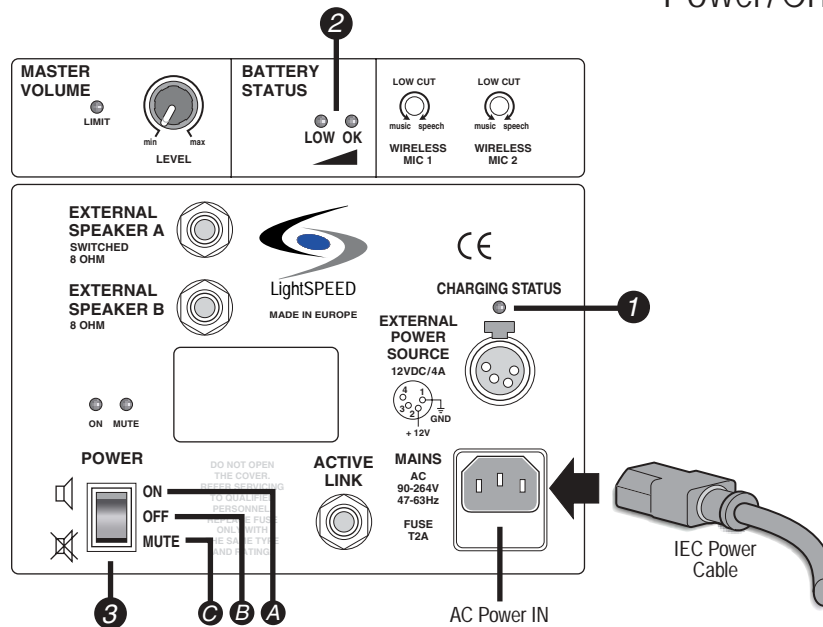

CHARGING THE BATTERY

After unpacking the unit for the first time, please charge the batteries for at least 10 hours before operation. The battery charger is built in as an integral part of the system. To charge the batteries, plug one end of the IEC power cable into the MAINS connector and plug the other end into an AC outlet (90-264VAC, 47-63Hz).

1. **CHARGING STATUS LED:** The Charging Status LED will light up when external power is supplied. The color of the LED indicates the charging status as follows:

- **RED** means fast-charge mode. *The batteries are very low or completely discharged.*
- **ORANGE** means trickle-charge mode. *The batteries are not yet fully charged.*
- **GREEN** means no charging. *The batteries are fully charged.*



NOTE: If the batteries are low and there is an AC outlet available, you can connect the AC mains and operate the system as normal while the batteries are charging. However, to fully charge the system, it should be switched OFF until the CHARGING STATUS LED turns green.

DETERMINING BATTERY STATUS

2. **BATTERY STATUS LEDs:** The Battery Status LEDs indicate the amount of charge available even when the AC mains are disconnected. Whenever the batteries have enough charge to operate the system, the green OK LED will light. As the batteries discharge, the red LOW LED will begin to glow, and the green OK LED will stay lit. When the red LOW LED is glowing brightly, the battery is very low. Once the batteries discharge to an unusable level, the system will shut off and you will need to connect to an external power source.



NOTE: It is possible to operate the system from a 12VDC external source when the batteries are fully discharged and no AC power source is available. A special adaptor cable allows connection directly to a car cigarette lighter. Contact LightSPEED for more information.

SYSTEM POWER

3. The POWER switch has three positions as follows:

- A. ON Position:** The green ON LED will light and the power amps will be active. This is the normal mode of operation with the internal and external speakers producing sound.
- B. OFF Position:** No LEDs will light and the system is off.
- C. MUTE Position:** The green ON LED and the amber MUTE LED will light and the power amps will be disabled. This is a special mode of operation in which all of the controls and functions work as normal, but no sound is produced by the internal or external speakers.

Speaker Stand (tripod)

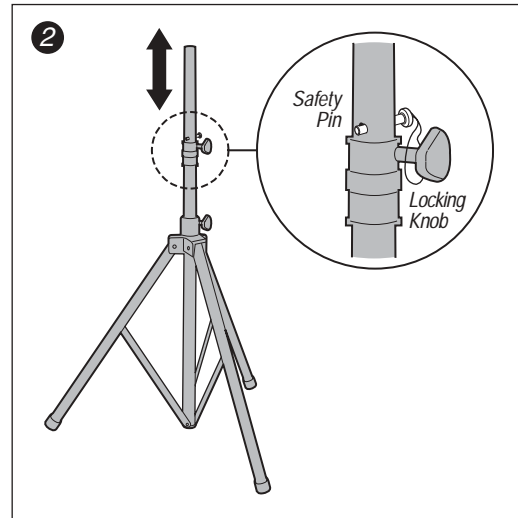
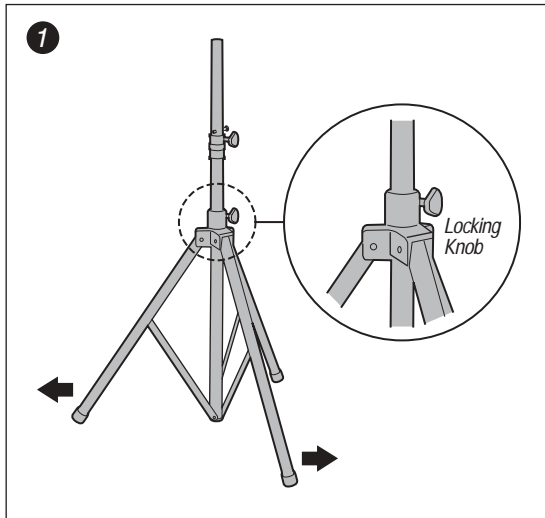
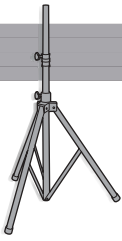
**SPEAKER STAND (TRIPOD)**

1. **Extending the Legs:** Loosen the lower knob and pull outward on two legs of the tripod. Extend the legs until the center post is just above the floor. The center post should NOT touch the floor. *Tighten the lower knob.*
2. **Extending the Center Post:** Loosen the upper knob and pull the center post up to the desired height. There are eight thru-holes in the center post. Locate the thru-hole nearest to the collar and insert the safety pin in that hole. Lower the center post until the safety pin sits on the collar. *Tighten the upper knob.*
3. **Mounting the Delta X:**



WARNING: Safe handling of this system requires two people.

For safety, two people are required to mount the Delta X system on the tripod. Lift the Delta X system above the top of the center post. Align the mounting hole with the center post of the tripod and carefully lower the Delta X system onto it.

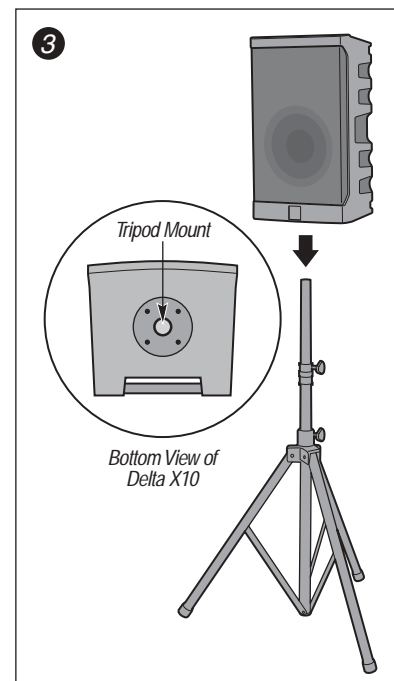

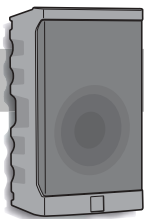

Speaker/System Placement

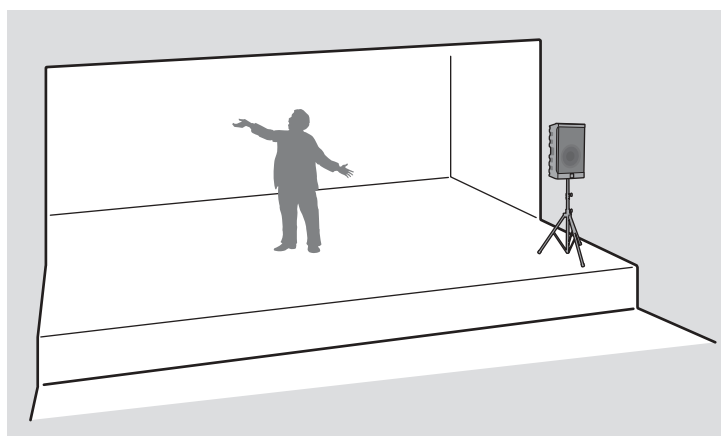

Typical stage placement for ONE Delta X system.

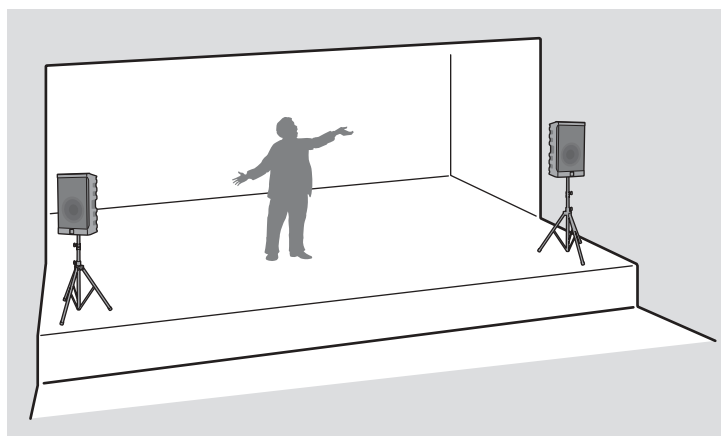

Typical stage placement for TWO Delta X systems.

SPEAKER PLACEMENT

The Delta X system(s) should be placed in a location that is slightly in front of the area in which microphones will be used, typically at the front edge of a stage. (SEE ILLUSTRATIONS)

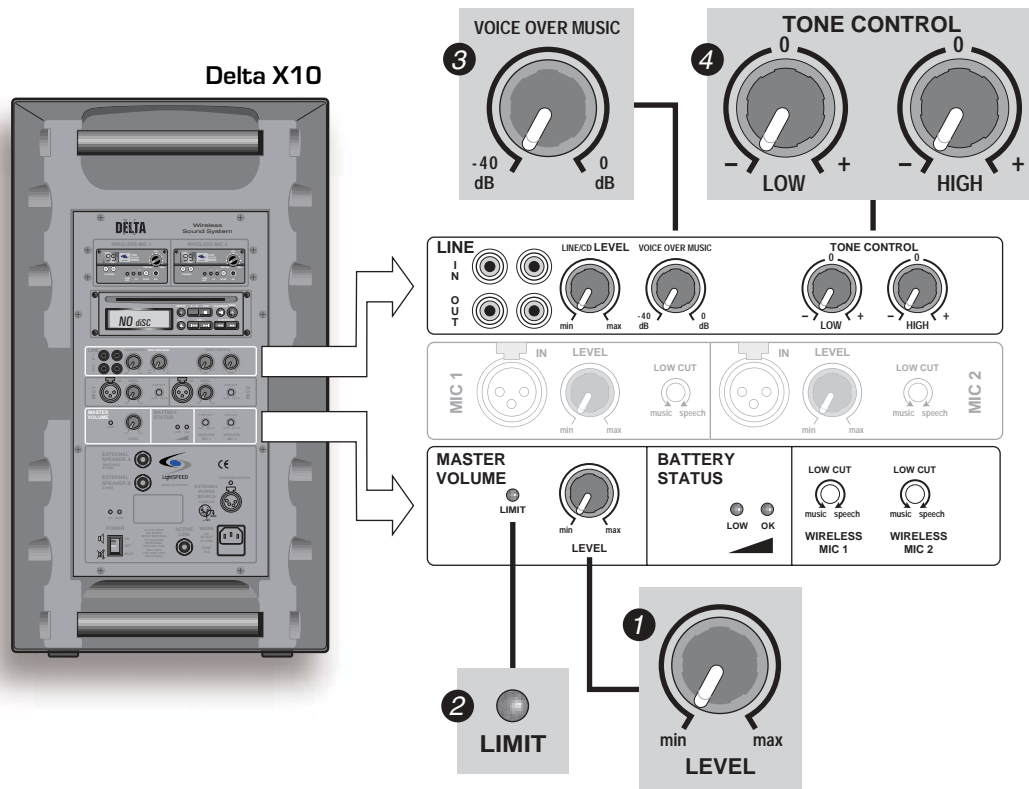
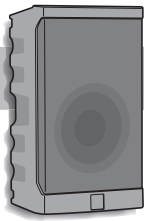

1. **MASTER VOLUME:** The MASTER VOLUME control is used to set the overall level of the audio going to the speaker(s). Each individual input has its own level control, and all of these input signals are combined (mixed) into one signal that flows through the MASTER VOLUME control.
2. **LIMIT:** The LIMIT LED lights up to indicate when the limiter is active. The limiter helps to prevent distortion which can cause damage to the speaker system. The level of the signals coming from the inputs (microphones, CD player, LINE IN) is 'watched' by the limiter circuit. The limiter instantly reduces the signal to a safe level if it becomes too large. When the limiter light is on, the power amplifier has reached maximum power.
3. **VOICE OVER MUSIC:** This is a special feature that automatically reduces the level of the LINE/CD inputs whenever sounds are produced at any of the four microphone inputs (WIRELESS MIC 1, WIRELESS MIC 2, MIC 1 IN, and MIC 2 IN). After a few seconds of silence on the microphones, the LINE/CD signal will slowly return to its original volume level. This is handy for events that require background music with occasional announcements.

The VOICE OVER MUSIC control sets the amount of reduction in level that occurs when the circuit is triggered by a microphone signal. For less reduction of the LINE/CD signal, turn the VOICE OVER MUSIC control clockwise. To disable VOICE OVER MUSIC, turn the control fully clockwise.

4. **TONE CONTROLS:** The LOW and HIGH controls provide the ability to cut or boost the corresponding frequencies in the LINE/CD signal. These controls do not affect the microphone signals.

Wireless Microphones

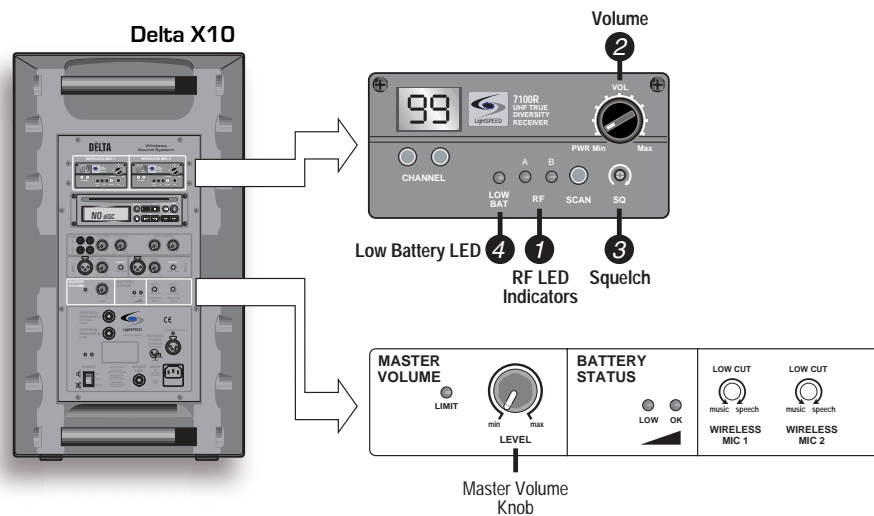
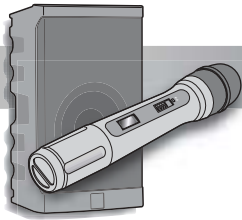

WIRELESS MICROPHONE OPERATION ... detailed operating instructions for receivers and transmitters are provided later in this manual.

1. **RF Indicator Lights:** When both the system and the transmitter are on and operating on the same channel you will see an RF Indicator Light (either A or B) on the receiver.
2. **Volume Adjustment:** While speaking into the microphone, slowly turn the up the volume on the receiver (while paying attention to the MASTER VOLUME). Remember that if the MASTER VOLUME is turned all the way down, no sound will come from the system regardless of the setting on the receiver volume.



NOTE: Do not stand directly in front of the DELTA X speaker with the microphone on. This will result in feedback ('squealing' or 'howling'). It is best to stand behind or off to the side of the unit when setting volume level. Detailed information about setting up wireless receivers and transmitters is provided later in this manual.

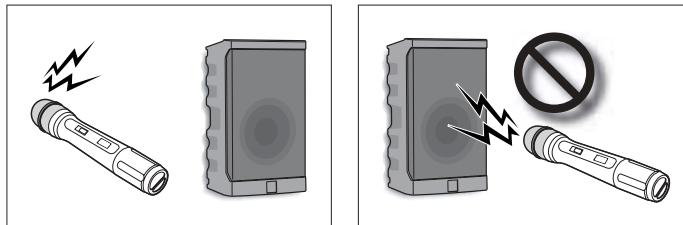

3. **Squelch Adjustment:** In areas that may have very high radio frequency traffic, it may be necessary to adjust the squelch level to block out potential interference.
 - Maximum squelch (full clockwise) reduces system reception range, but also reduces the potential for system interference.
 - Minimum squelch (full counterclockwise) increases reception range, but also increases the potential for system interference.



NOTE: In most cases it will not be necessary to adjust the squelch level. The Clear Channel Scan function will take care of most interference problems.

4. **Transmitter Low Battery Indicator:** This LED will light to indicate the batteries in the corresponding transmitter are low and need to be replaced or recharged.



Wired Microphone

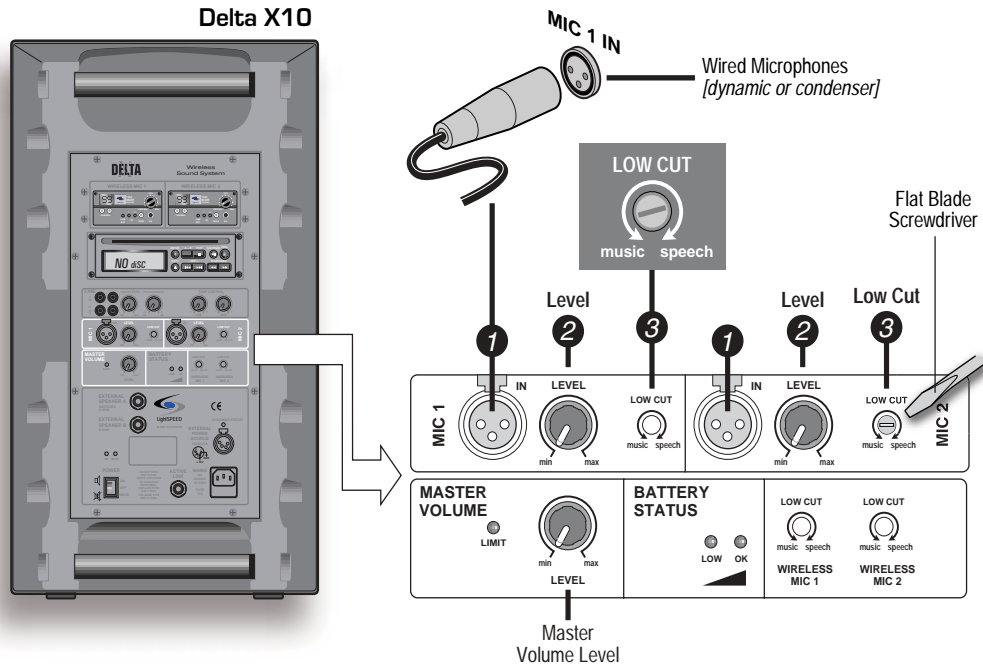

WIRED MICROPHONE OPERATION

1. **MIC IN:** Connect the wired microphone into one of the XLR input jacks labeled MIC 1 IN and MIC 2 IN.
2. **LEVEL:** Rotate the level control clockwise to increase the volume (while paying attention to the MASTER VOLUME). Remember that if the Master Volume is turned all the way down, no sound will come from the system regardless of the setting on the MIC IN LEVEL.
3. **LOW CUT Filters:** These adjustments allow you to reduce the level of the low frequencies on each wired microphone input, making for a crisp and clear voice replication. The low cut filters affect only the associated wired microphone input. They do not affect the overall tone of the Delta X system.
 - To reduce the low frequency sounds (increase the low cut) turn the dial clockwise (towards "speech") with a flat blade screwdriver.
 - If you desire a fuller sound for instruments or otherwise, turn the dial counterclockwise (towards "music").



NOTE: Do not stand directly in front of the DELTA X speaker with the microphone on. This will result in feedback ('squealing' or 'howling'). It is best to stand behind or off to the side of the unit when setting volume level. Detailed information about setting up wireless receivers and transmitters is provided later in this manual.

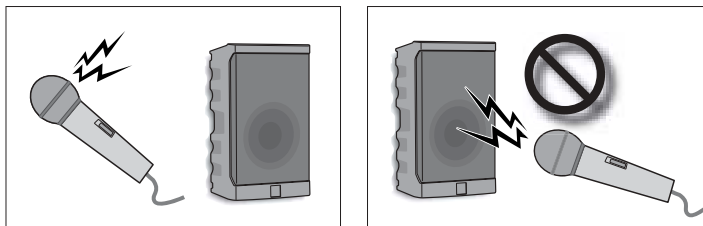

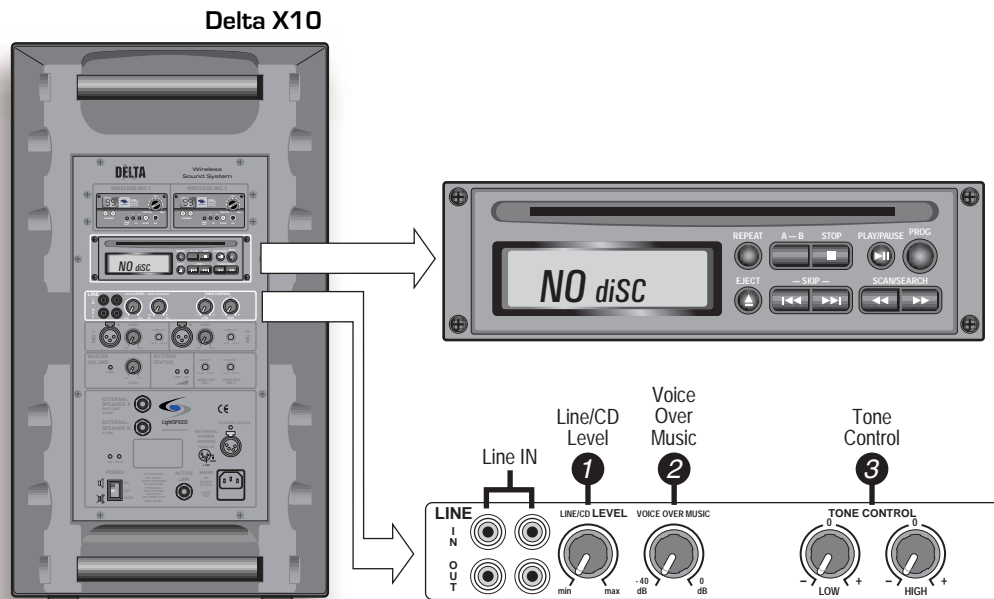

CD PLAYER OPERATION

Note: Detailed information about using the CD player is provided later in this manual.

- 1. Volume Adjustment (LINE/CD LEVEL):** While playing a disc, slowly turn up the LINE/CD LEVEL control until you reach the desired volume. Remember that if the MASTER VOLUME is turned all the way down, no sound will come from the system regardless of the setting on the LINE/CD LEVEL control.
- 2. Voice Priority (VOICE OVER MUSIC):** Audio coming from the CD player and the LINE IN jacks will automatically drop in level when sound is produced at any of the microphone inputs. When there is no more sound at the mic input(s), the audio from the CD player and/or the LINE IN jacks will come back to its original level. Adjusting the VOICE OVER MUSIC control changes the amount of drop in level that occurs when there is sound at the mic input(s).
- 3. Tone Controls:** The LOW and HIGH tone controls can be used to cut or boost the lows and highs in the audio coming from the CD player and the LINE IN jacks. These controls do not affect the audio coming from the microphone inputs.

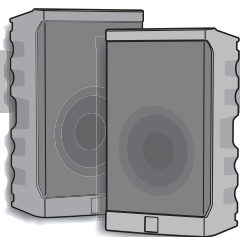

Operating Instructions

Active Link Operation

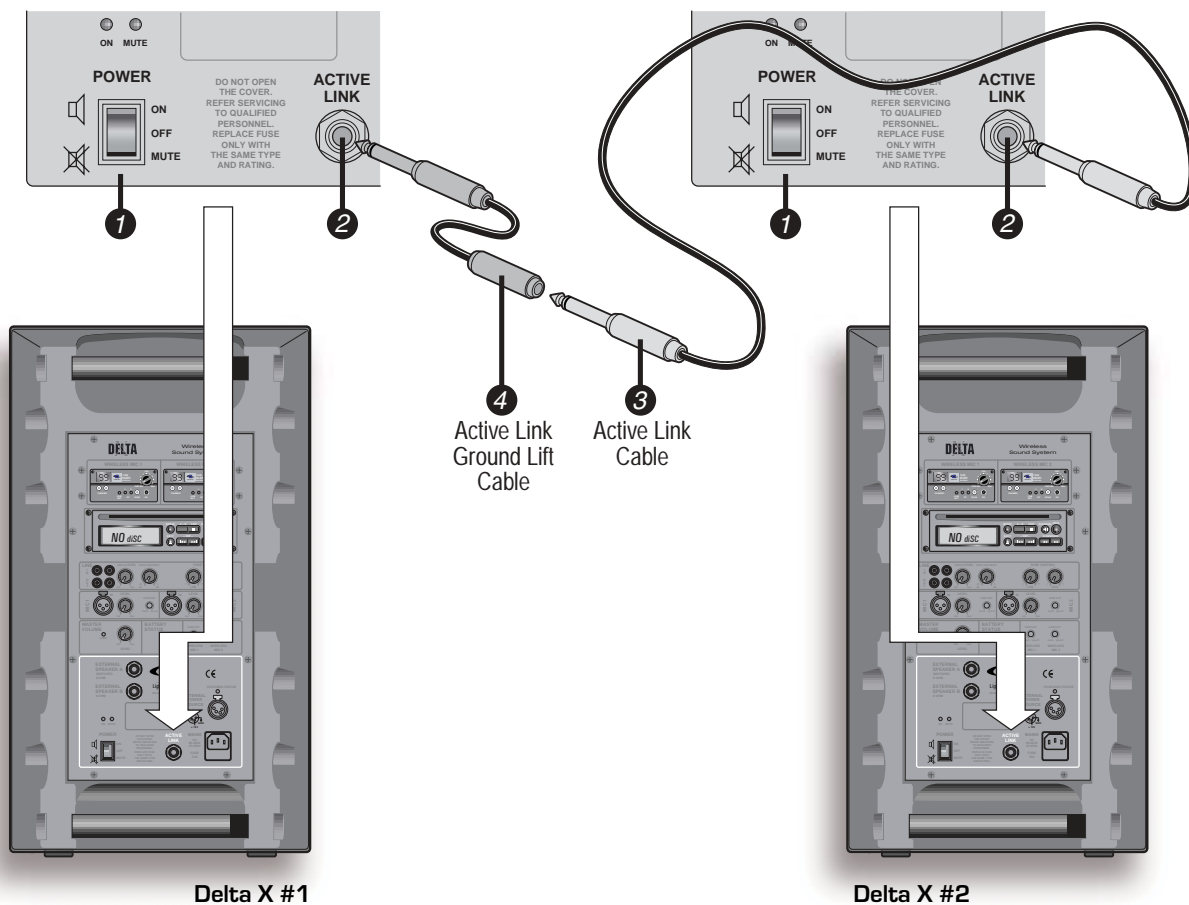

CONNECTING TO ANOTHER DELTA X10 OR DELTA X12

Using ACTIVE LINK, you can double the available inputs and double the sound level by connecting two Delta X10 or Delta X12 units together. When connected properly, the sound from both Delta X systems is 'shared' between them.

1. **System Power Switch**
2. **Control panel Active Link jack**
3. **Active Link Cable**
4. **Active Link Ground Lift Cable**

ACTIVE LINK cables are available from LightSPEED Technologies in various lengths. Before connecting the ACTIVE LINK cable, make sure the power to both Delta X systems is OFF. Put the Delta X systems in the locations that you have chosen, then connect the ACTIVE LINK cable between them.



Note: If both Delta X systems are connected to AC mains power during operation, there may be an audible hum in the audio. If this happens, you will need to connect an ACTIVE LINK GROUND LIFT cable (provided) to one of the two Delta X units.



Connecting External Speakers

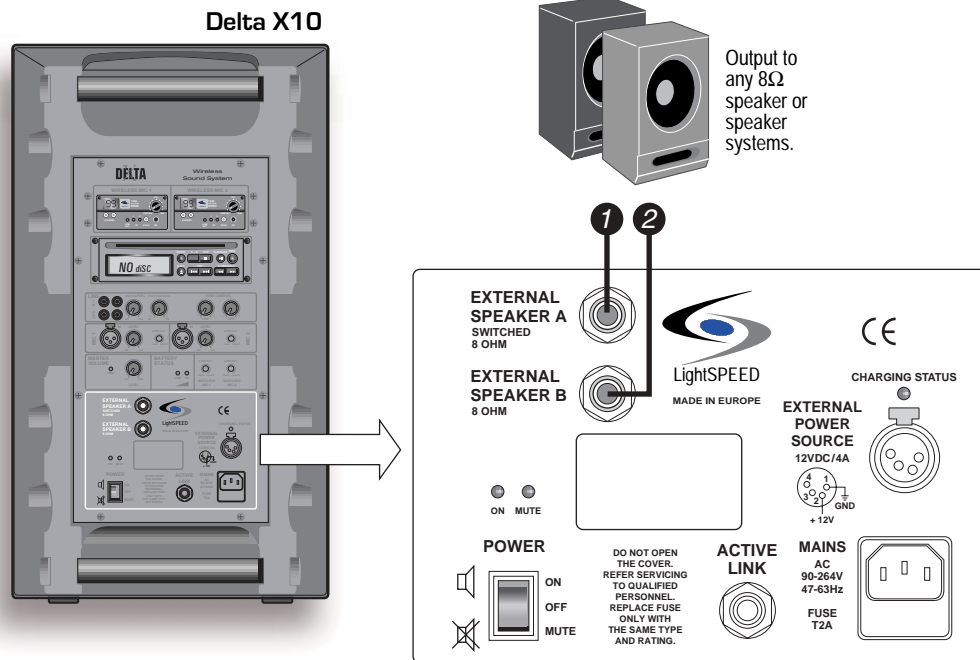

CONNECTING EXTERNAL SPEAKERS

The Delta X10 and Delta X12 systems have two internal power amplifiers to drive loudspeakers. One amplifier normally drives the internal speaker and the other amplifier is dedicated for external passive speaker(s).

1. **EXTERNAL SPEAKER A SWITCHED:** When you connect an external speaker to this amplifier, the internal speaker will be bypassed and only the external speaker will have sound.
2. **EXTERNAL SPEAKER B:** When you connect an external speaker to this amplifier, the internal speaker will continue to produce sound along with the external speaker.

Each external speaker connection will handle a load impedance of 8 Ohms or higher. You can connect a single 8 Ohm speaker or two 16 Ohm speakers in parallel to each external speaker output.



Note: If the amplifier output cuts out on loud sounds, check the impedance of the external speaker(s). Loads of less than 8 Ohms will cause the amplifiers to shut down in order to prevent damage.

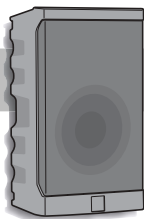

External Audio IN/OUT

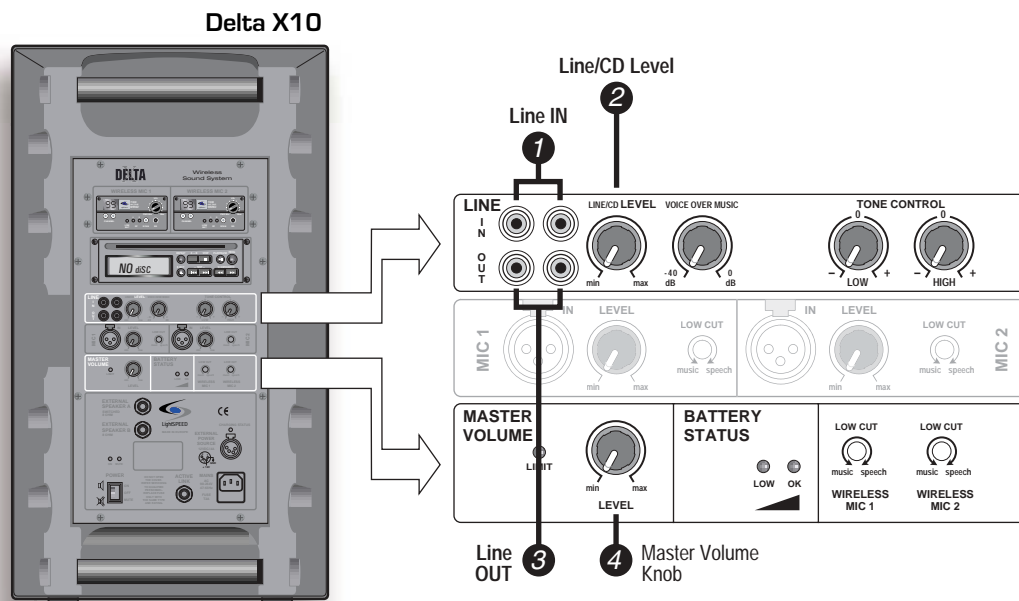

CONNECTING EXTERNAL AUDIO SOURCES

To connect an external audio source such as an MP3 Player, CD/DVD, TV/VCR, or computer to the Delta X system:

1. **LINE IN:** Connect a cable from an audio source to the RCA jack(s) labeled LINE IN. Stereo sources will be summed into a mono signal within the Delta X system.
2. **LINE/CD LEVEL:** With the unit turned ON, adjust the LINE/CD Level volume knob to a desired level.



NOTE: When hooking up auxiliary equipment, you may need an adaptor depending on the connections available.

CONNECTING AUDIO OUTPUT TO EXTERNAL DEVICES

To output the mixed audio signal of the Delta X system to an external device such as a recording device, mixing console, or assistive listening transmitter:

3. **LINE OUT:** Connect a cable from the RCA jack(s) labeled LINE OUT to the external device. Both RCA jacks contain the same mono signal.
4. **MASTER VOLUME:** The RCA jacks provide a line-level output signal that does not change volume regardless of the setting on the MASTER VOLUME control.

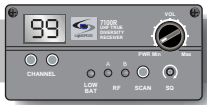

Wireless Receiver(s)

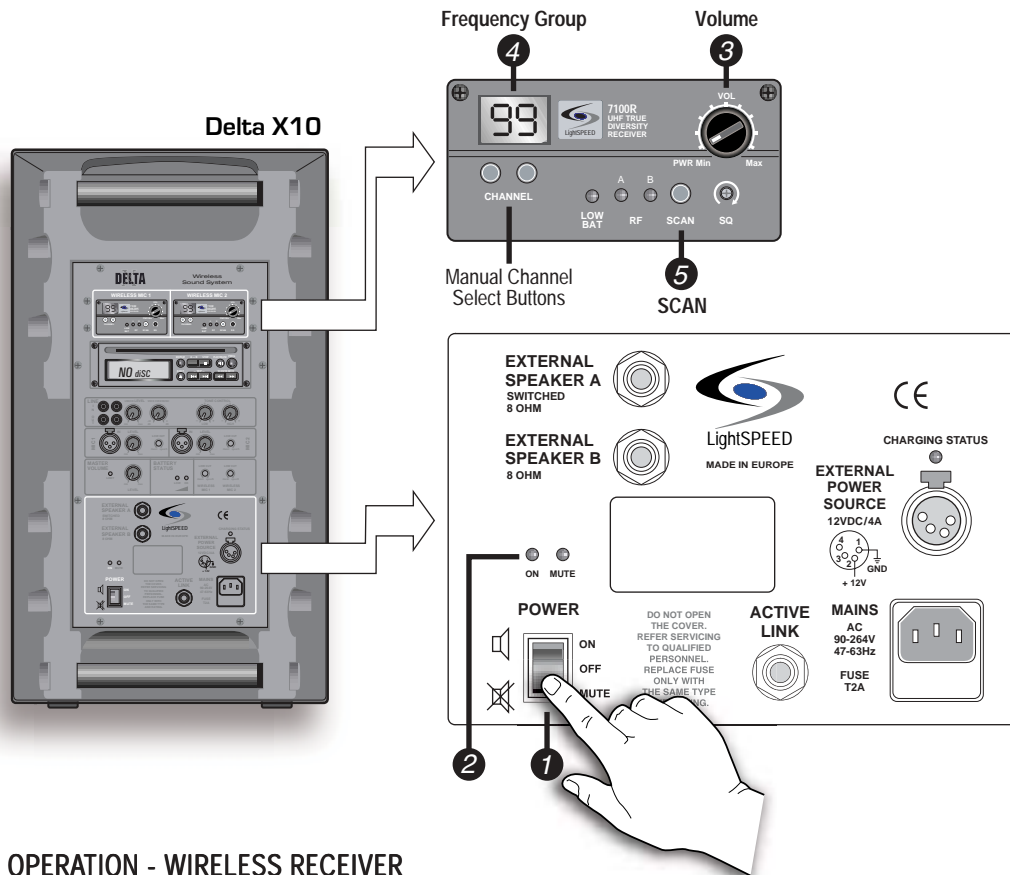

DETAILED OPERATION - WIRELESS RECEIVER

Power up the Delta X system and wireless receiver(s)

1. **POWER:** Push the POWER switch on the base unit back panel to the ON (or MUTE) position.
2. **ON LED:** The ON LED will light.
3. **Receiver Volume:** Rotate the Power/Volume knob on the receiver module clockwise to turn on. *Leave the volume at a low level for now.*
4. **Frequency Group:** When the receiver power is first switched on, the frequency group of the receiver will be shown briefly as letters on the LED display. (*See frequency group chart on page 30*)

Channel Selection - Wireless Receiver

Each receiver has 100 user-selectable channels to choose from. You can select a channel either manually or by pressing the SCAN button which will automatically select a clear channel.

5. **Clear Channel Scan (Recommended):** Make sure the transmitter(s) is OFF before pressing this button. When this button is pressed, the receiver will cycle through all 100 channels and select a clear frequency (this process takes about 20 seconds). Once the receiver selects the clear channel, you will need to select the same channel on the corresponding transmitter (handheld or belt-pack).

If You Have a Second Receiver (WIRELESS MIC 2): Verify that WIRELESS MIC 1 is operating on a clear channel, and the transmitter for WIRELESS MIC 1 is turned ON. Make sure the transmitter for WIRELESS MIC 2 is turned OFF, and then press the "SCAN" button on the WIRELESS MIC 2 receiver. After the WIRELESS MIC 2 receiver selects a clear channel, set the WIRELESS MIC 2 transmitter (handheld or belt-pack) to the selected channel.



Operating Instructions

Wireless Receiver(s)

MANUAL CHANNEL SELECTION:

- 6. Left Channel Button:** Pressing the Left Channel button changes the first number (0-9).
- 7. Right Channel Button:** Pressing the Right Channel button changes the second number (0-9). Once a frequency is selected, you will need to select the same channel on the corresponding transmitter (handheld or belt-pack).



NOTE: There are 5 different groupings of 100 channels available, which are sent out to maximize clear channels in a specific geography. When the system is powered on, the two letters that initially blink in the Channel window on the receiver indicate the frequency group (see chart on page 30 for further details).

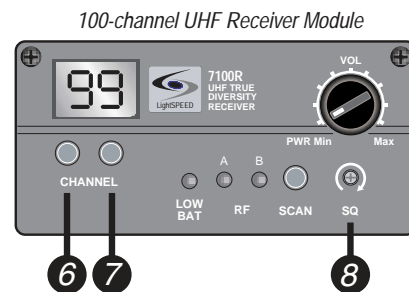

- 8. SQUELCH ADJUSTMENT:** In areas that have very high radio frequency traffic, it may be necessary to adjust the squelch level to block out potential interference.
 - **MAXIMUM SQUELCH:** (full clockwise) reduces the system reception range, but also reduces the potential for radio frequency interference.
 - **MINIMUM SQUELCH:** (full counterclockwise) maximizes reception range, but also increases the potential for radio frequency interference.

Installing or Replacing a Receiver Module: Make sure the power to the Delta X system is turned OFF. Remove the two screws securing the module or filler panel using a small Phillips screwdriver. To remove the module, use a small flat-blade screwdriver. Carefully insert the blade under the face plate edge and nudge it outward. Grasp the edges with both hands and slide outward. Install the new module by aligning it with the guide rails and sliding all the way in to engage the connector at the rear of the module. Replace the two screws.

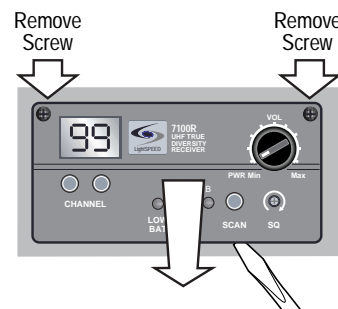



Wireless Transmitter Handheld Microphone

Channel Selection – Handheld Transmitter

Once a channel has been selected on the receiver, you now need to select that same channel on the handheld transmitter. *If you have a belt-pack transmitter, go to page 23 for channel selection instructions.*

- Turn the microphone on by sliding the switch on the barrel to the ON position. The red LED will flash once.
- Use the “up” and “down” buttons to select a screen that shows the current channel.
- To change the channel, press and hold the “SET” button on the bottom of the microphone until there is a blinking cursor on the LCD display window (*approximately 3 seconds*).
- Use the “UP” and “DOWN” buttons to set the channel to match the receiver.
- Press and hold the “SET” button again until the blinking cursor disappears and the red LED flashes (*approximately 3 seconds*).

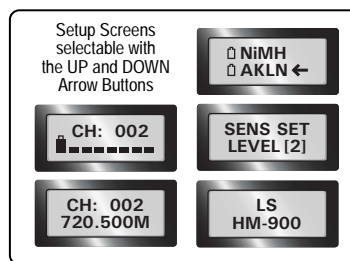

NOTE: Transmitters and receivers are available in 5 different frequency groups. Verify that the letter code that blinks on the receiver (when powered ON) matches the letter code on the frequency sticker in the battery compartment of the transmitter.

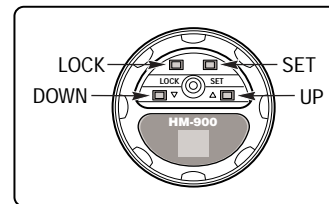
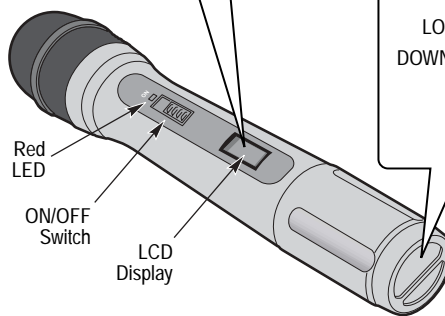

Transmission Frequency in MHz: Press the “UP” button once to view the transmission frequency in MHz of the currently selected channel.



Lock Function

This allows users to lock out all the controls on the microphone so that it is not accidentally switched off or the channels aren't accidentally changed in the middle of a performance.

To lock all the controls:

- Press the “LOCK” button on the bottom of the microphone. A lock icon will appear on the LCD screen next to the channel number.

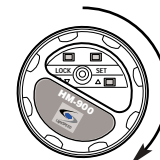

Rotate Disc to Secure Controls

- The black (*or colored*) disc on the bottom can be rotated around to completely cover the controls so that the buttons cannot be accidentally pressed again.

To unlock all the controls:

- Rotate the black (*or colored*) disc back around to reveal the buttons on the bottom of the microphone.
- Press the “LOCK” button again to unlock. The lock icon will disappear.

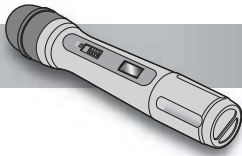

Wireless Transmitter Handheld Microphone

Sensitivity Level

This function allows the user to set the gain structure of the microphone to best fit the voice level of the person speaking into it. A person with a very loud, booming voice may want the microphone set to a sensitivity level of 1 or 2. A person with a very soft voice will be better off with the microphone set to a sensitivity of 3 or 4.

To change the sensitivity setting:

- Press the "UP" button 3 times to get to the Sensitivity Level screen.



- Press and hold the "SET" button until a blinking cursor appears.
- Use the "UP" and "DOWN" arrows to make a selection (1-4).
- Press and hold the "SET" button again until the blinking cursor disappears.

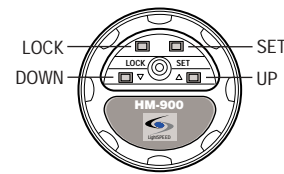

Handheld Microphone
End View

Battery Life Indicator

The battery life is shown on the primary screen of the LCD. The 7-step fuel gauge acts as a detailed guide to show the actual life of the battery.



Battery Type

The transmitter will operate with either standard Alkaline Batteries or Nickel Metal Hydride (NiMH) Rechargeable Batteries. Since these types of batteries have different characteristics, it is important to set the transmitter to the appropriate type of battery being used so that the battery life indicator will operate properly.

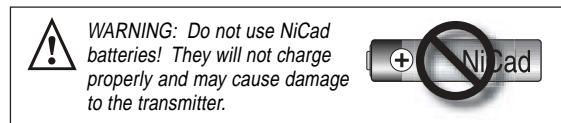
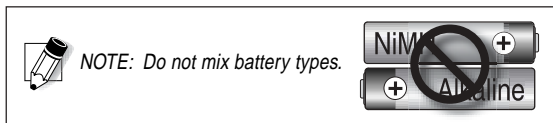

To Change the Battery Type Setting:

- Press the "UP" button twice to get to the battery-type screen.
- Press and hold the "SET" button until a blinking cursor appears.
- Use the "UP" and "DOWN" arrows to make a selection.
- Press and hold the "SET" button again until the blinking cursor disappears.

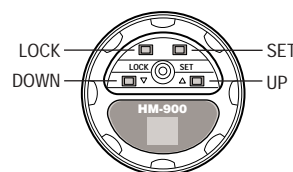

Handheld Microphone
End View

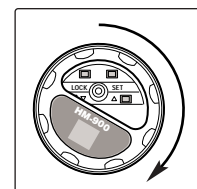

Rotate Disc to Secure
Controls

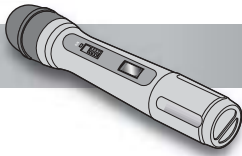

Operating Instructions

Wireless Transmitter Handheld Microphone

REPLACING THE BATTERIES

1. To replace the batteries, unscrew the end cap to reveal the battery compartment.
2. Remove or replace the batteries as shown. The microphone requires two AA sized batteries stacked end to end.
3. Note the polarity in the battery compartment. *Typical battery life is about 8 hours.*

IMPORTANT! Replace batteries with the same type, (alkaline or NiMH), that were installed in your handheld microphone.

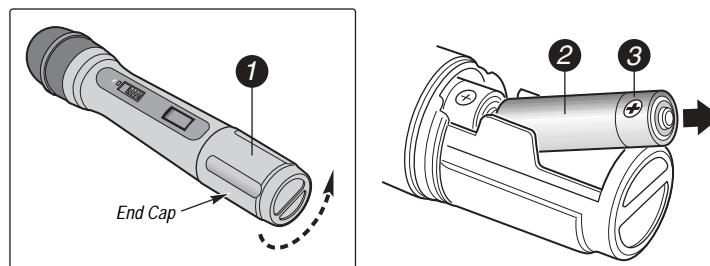

CHARGING THE BATTERIES (NiMH Rechargeable Batteries ONLY)

Make sure there are NiMH Rechargeable Batteries in the transmitter before plugging in the charger.

WARNING: Do not attempt to charge alkaline batteries. They can overheat and expand, creating a significant hazard and damaging the transmitter. *(This is not covered by warranty.)*

- Switch the transmitter power off.
- Insert the small DC plug into the jack on the bottom of the transmitter.
- Plug the other end of the charger into any standard 110 VAC outlet.
- The Red LED on the charger will light indicating that charging is in progress.
- When the batteries are fully charged, the light on the charger will turn green. *A full charge can take up to 8 hours.*

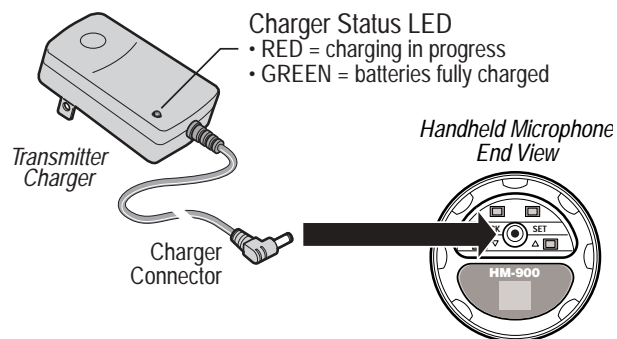



Wireless Transmitter Belt-pack

Channel Selection – Belt-pack Transmitter

Once a channel has been selected on the receiver, you now need to select that same channel on the belt pack transmitter.

 **NOTE:** Transmitters and receivers are available in 5 different frequency groups. Verify that the letter code that blinks on the receiver (when powered ON) matches the letter code on the frequency sticker in the battery compartment of the transmitter.

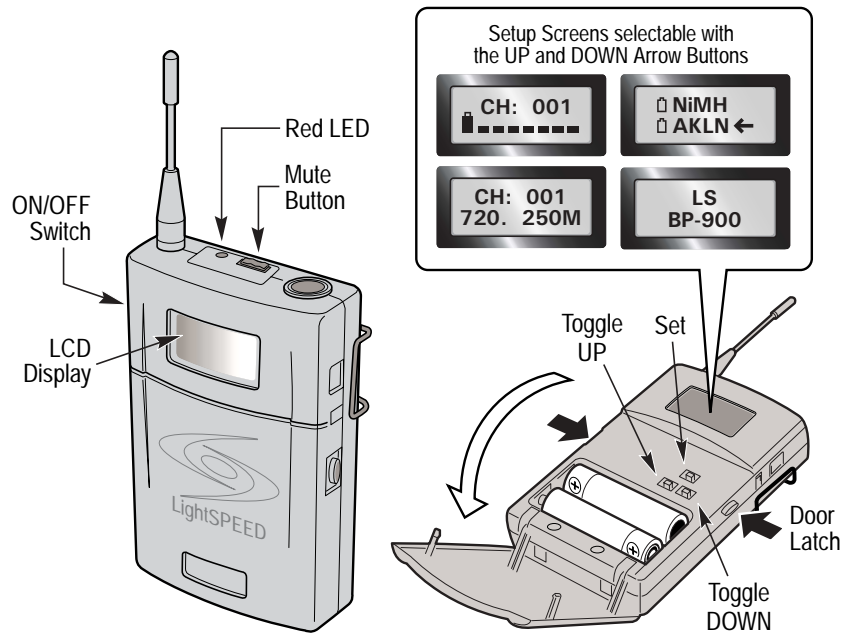

- Turn the transmitter ON by pressing and holding the Power button on the side (*approximately 2 seconds*). The LCD display will appear.
- Open the plastic door by depressing the latches on each side.
- Use the “up” and “down” buttons to select a screen that shows the current channel.
- To change the channel press and hold the “SET” button until there is a blinking cursor on the LCD display window (*approximately 3 seconds*).
- Use the “Up” and “Down” buttons to set the channel to match the receiver.
- Press and hold the “SET” button again until the blinking cursor disappears (*approximately 3 seconds*).

Transmission Frequency in MHz: Press the “UP” button once to view the transmission frequency in MHz of the currently selected channel.

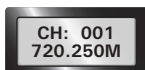



Operating Instructions

Wireless Transmitter Belt-pack

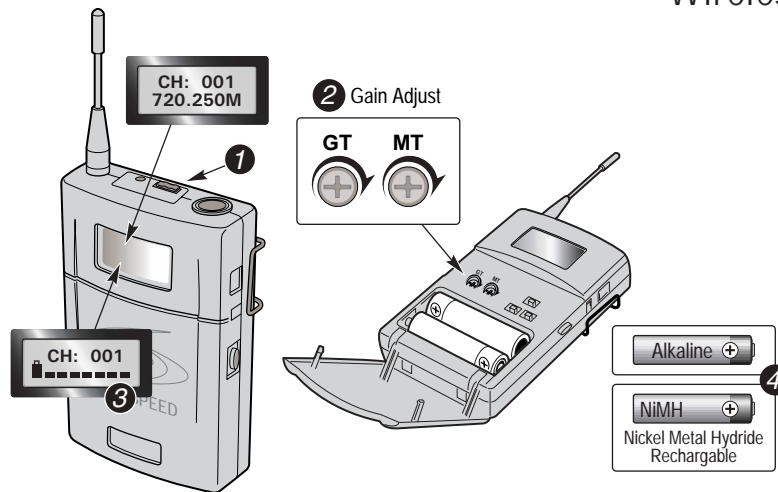

- 1. Transmitter Mute:** The MUTE switch turns the transmitter's audio signal on or off. The audio is off when the red LED is flashing.
- 2. Gain Adjust:** When changing microphones or users, it may be necessary to adjust the transmitter gain based on differing microphone sensitivities and voice levels.
 - To adjust the microphone gain, turn the MT dial clockwise to increase the gain and counterclockwise to decrease the gain.
 - If you are using a high impedance source, such as a guitar, it will be necessary to adjust the GT dial. Using a high impedance source requires a special cable. *Contact LightSPEED Technologies for more information.*
- 3. Battery Life Indicator:** The battery life is shown on the primary screen of the LCD. The 7-step fuel gauge acts as a detailed guide to show the actual life of the battery.
- 4. Battery Type:** The transmitter will operate with either standard Alkaline Batteries or Nickel Metal Hydride (NiMH) Rechargeable Batteries. Since these types of batteries have different characteristics, it is important to set the transmitter to the appropriate type of battery being used so that the battery life indicator will operate properly.

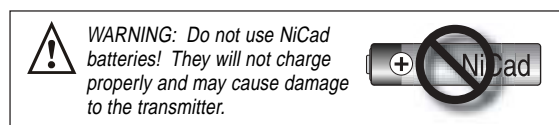
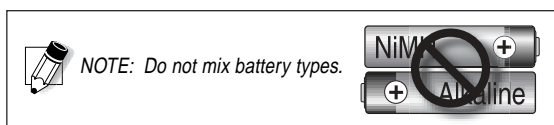

5. To Change the Battery Type Setting:

- Press the "UP" button twice to get to the battery type screen.
- Press and hold the "SET" button until a blinking cursor appears.
- Use the UP and DOWN buttons to make a selection.
- Press and hold the "SET" button again until the blinking cursor disappears.

6. Replacing the Batteries:

- Open the plastic door by depressing the latches on each side.
- Insert two AA batteries and snap the door closed. Note the polarity in the battery compartment.

Typical battery life is about 8 hours.

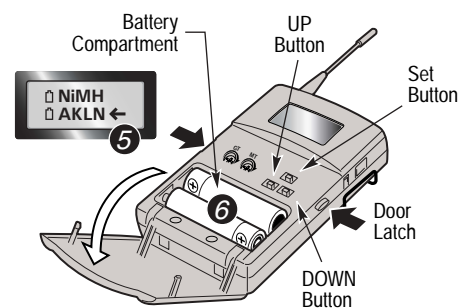



Wireless Transmitter Belt-pack

Charging the Batteries (NiMH Rechargeable Batteries ONLY):

Make sure there are NiMH Rechargeable Batteries in the transmitter before plugging in the charger.



WARNING: Do not attempt to charge alkaline batteries. They can overheat and expand, creating a significant hazard and damaging the transmitter. *(This is not covered by warranty.)*

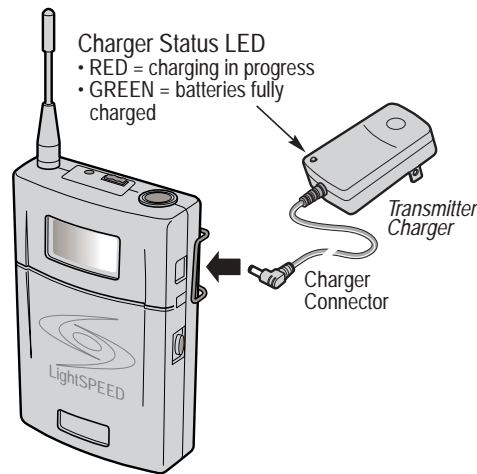

- Switch the transmitter power off.
- Insert the small DC plug into the jack on the side of the transmitter labeled "CHG".
- Plug the other end of the charger into any standard 110 VAC outlet.
- The Red LED on the charger will light indicating charge is in process.
- When the batteries are fully charged, the light on the charger will turn green. *A full charge can take up to 8 hours.*

CONNECTING THE MICROPHONE

LightSPEED offers various types of microphones that can be used with this system. To connect the microphone, simply insert the microphone connector into the TA4F connector on top of the transmitter. To remove, press the black button on the microphone connector and pull out.

MICROPHONE OPTIONS

The BP-900 Transmitter can be used with either a lapel style microphone or a headset microphone. Both plug into the top of the transmitter as shown.

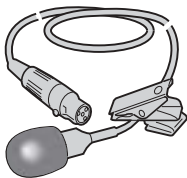
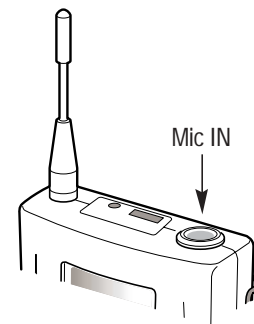

Lapel Microphone

Several varieties of lapel microphones are available (*pictured is the Audio Technica 831*). Simply connect the microphone cord directly into the jack on top of the transmitter and clip the microphone to lapel or collar. *For optimal sound, position the microphone as close to the mouth as possible.*

Headset Microphone

Several varieties of headset microphones are available (*pictured is the LightSPEED TK-250*). Simply connect the microphone cord directly into the jack on top of the transmitter and place the headset around the back of the head. *For optimal sound, position the microphone just beside the mouth.*

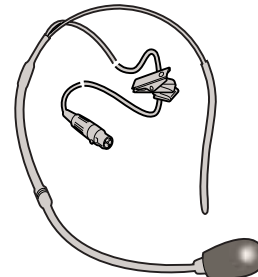



CD Player



Playing a Compact Disc

When a CD is not loaded in the CD player, the LCD screen will display the text 'no disc'.



To play a disc, gently insert it into the CD slot. The CD player will 'grab' the CD and load it automatically. While the CD player 'reads' the track and time information, the display shows dashes.



After a few seconds, the LCD screen will change to a display showing the number of tracks, the total playing time of the disc, and a grid showing up to 16 tracks that will be played. The grid is very useful when programming playlists.

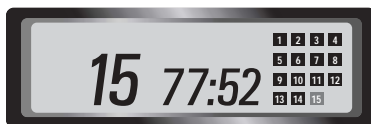

Once the disc has been 'read' by the CD player, you can either start playback from the first track on the disc, or use the SKIP buttons to select a different track for playback.

To start playback, press the PLAY/PAUSE button once. The PLAY symbol appears on the display.

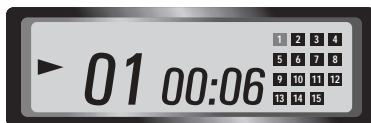

To stop playback, press the PLAY/PAUSE button once again or press the STOP button. When paused, the PAUSE symbol appears on the display.

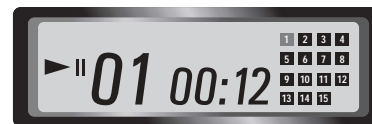

Note: Use PAUSE instead of STOP to maintain the playback position. Once STOP has been pressed, the playback will resume at the beginning of the currently displayed track.

During playback, you can 'fast forward' or 'rewind' using the SCAN/SEARCH buttons. You will see the time index move quickly and hear 'snippets' of audio that you can use to listen for the desired position.

To remove the disc from the CD player, press the EJECT button.

Repeating

The CD player can repeat the current track, the entire disc, or an arbitrary section of the disc (called a 'loop').

Press the REPEAT button once to repeat the current track. REPEAT 1 will appear on the display.

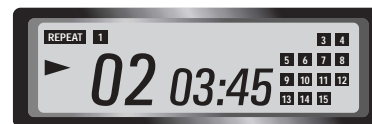

Press the REPEAT button a second time to repeat the entire disc. *REPEAT ALL will appear on the display.* Press the REPEAT button a third time to cancel the repeat operation.





CD Player ... continued

To create a loop, press the A->B button during playback at the time index you have chosen as the beginning of the loop.



Press the A->B button again when the time index reaches the chosen end point of the loop.



During loop playback, you can use the PLAY/PAUSE button and the SCAN/SEARCH buttons as normal. Press the A->B button again to cancel the loop without affecting playback. Press the STOP, SKIP, or EJECT buttons to cancel the loop and perform the corresponding action.

Programming a Playlist

A playlist is a temporary, user programmable selection of tracks that will play in the order that you select them. The tracks selected will be shown in the grid on the right side of the display.

Press the PROG button to start recording the track sequence. The PROGRAM symbol appears on the display.



The first set of digits on the display indicates the track selection, and the second set of digits indicates the program sequence number (starting at 01). When you select a track for sequence number 01, the track number appears in the first set of digits.

Note: The grid can only display the first 16 tracks on a disc. If the disc has more than 16 tracks, you can still select them during programming but you will not get visual confirmation of the selection on the grid.



To save the selection, press the PROG button again. The track number will appear in the grid.



Select another track for sequence number 02 and press the PROG button again. The second track number will appear in the grid.



Once you have selected all of the tracks to be included in your playlist, press the PLAY button to begin playback. Your selections will be played in the order that you selected them.

While a playlist is playing, you can use many of the same controls that are available during normal playback. PLAY/PAUSE, SKIP, and SCAN/SEARCH all work as normal. REPEAT also works as normal, repeating a single track or repeating the entire playlist.

Once you reach the end of the playlist, the program will be forgotten by the CD player unless you have REPEAT ALL selected.

Installing a CD Player: *Make sure the power to the Delta X system is turned OFF.* Remove the four screws securing the filler panel using a small Phillips screwdriver. Locate the header cable inside the control panel and connect it to the CD player, observing proper polarity. Insert the CD player into the control panel. *Replace the four screws.*

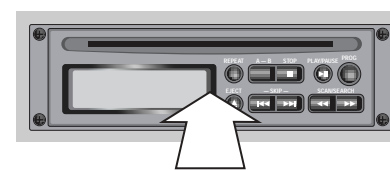
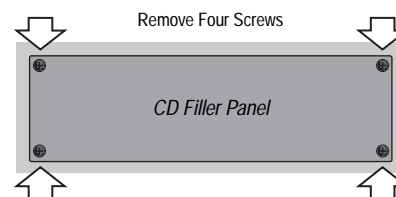

Install CD Player and Replace Four Screws

No sound when using any input (CD player, Line In, Wired Microphones, Wireless Microphones):

1. *DELTA X main power should be turned ON.* The green ON LED should be lit. If it does not light when the system is switched on, the battery is most likely too weak and needs to be plugged into the charger.
2. *Make sure the main power switch is set to ON and not MUTE.*
3. Check the setting of the MASTER VOLUME control. This control sets the amount of audio coming out of the speakers. If it is set to minimum, no sound will be produced.

No sound when someone speaks into the wireless microphone:

3. *Microphone/transmitter power should be turned on.* If the LCD display does not show, the batteries are most likely too weak. Plug the microphone/transmitter into the charger (if the batteries are rechargeable) or replace with alkaline batteries.



NOTE: Do not attempt to charge alkaline batteries! This can result in severe damage to the transmitter that will NOT be covered under warranty!

4. *The transmitter and receiver should be set to the same channel* and the blue RF LED (A or B) on the receiver should be lit.
5. *Verify that the receiver and transmitter are in the same frequency group.*
 - Turn the receiver off and then on again. The letter code for the frequency group will be shown briefly on the LED display.
 - Open the battery compartment of the transmitter and find the frequency group sticker. The letter on the frequency group sticker must match the letter code shown on the receiver display.
6. *Make sure the red LED (on the belt-pack transmitter) is not flashing.*

The wireless microphone is experiencing drop-out or interference:

1. *The wireless frequency being used may not be a clear channel.* Turn the transmitter off and press the SCAN button on the receiver to find a clear frequency. Then make sure to select the same channel on the transmitter.
2. *Squelch adjust on the receiver is set too high.* If this squelch is set too high (fully clockwise), this can drastically reduce the range of the transmitter, resulting in more frequent dropout.
3. *Squelch adjust is set too low.* In areas of severe interference (large downtown urban areas, airports, military bases, etc) it may be necessary to turn the squelch up slightly to avoid outside interference.
4. *Transmitter is out of range of receiver.* The transmitters do have a maximum range of about 300-350 feet in an open field environment. This range can be dramatically reduced indoors and when large objects (such as a wall) may be obstructing the path directly between transmitter and receiver. If this is the case, it may be necessary to position the two closer together.
5. *Batteries are very weak.* Just before the batteries are about to die, the overall performance of the system can degrade dramatically. Make sure to check the battery status of both the transmitter and DELTA X system.

System Specifications

Delta X10/12 Base Unit

	DELTA X10	DELTA X12
Nominal SPL (1W/1M)	97 dB	100 dB
Maximum SPL	116 dB	120 dB
System Power (RMS)	50 W at 8 W	50 W at 8 W
Music Power	65 W at 8 W	65 W at 8 W
Amplifier Type	Analog Class H	Analog Class H
Frequency Response of amplifier	70 Hz – 20 kHz	70 Hz – 20 kHz
Speaker System	2-Way with Passive Crossover	2-Way with Passive Crossover
Woofer	10" 8 W	12" 8 W
Tweeter	Foxtex FH15	Foxtex FH300
Internal Battery	2 x 12V / 4.5AH	2 x 12V / 7.2AH
Operating Time	5-10 Hours	7-12 Hours
Battery Charger	Internal 3-step Automatic Charger	Internal 3-step Automatic Charger
AC Power	96 VAC – 240 VAC	96 VAC – 240 VAC
Microphone Inputs	2 XLR Jacks with Phantom Power	2 XLR Jacks with Phantom Power
Wireless Microphones	Up to two 100-Channel UHF True Diversity	Up to two 100-Channel UHF True Diversity
Line Input	RCA	RCA
Line Output	RCA	RCA
Tone Controls	Individual Shelving Low-cut Filter for Each Mic-input, Independent Bass and Treble Control for Music Sources	Individual Shelving Low-cut Filter for Each Mic-input, Independent Bass and Treble Control for Music Sources
Speaker Outputs	1 Switched 8 Ohm / 1 Non-switched 8 Ohm	1 Switched 8 Ohm / 1 Non-switched 8 Ohm
Dimensions (H x W x D inches)	23.25 x 13.25 x 11.25	25.5 x 16 x 14.5
Weight (with battery)	41Lbs	54Lbs

Note: Specifications are subject to change without notice.

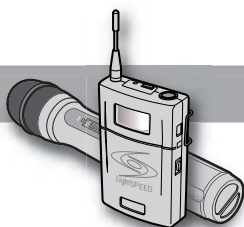

System Specifications

BP-900 and HM-900 Transmitters

RF Power Output	50 mW Maximum
Spurious Emission	>60 dB below the carrier
Macro Frequency Range	620 MHz to 745 MHz [5 Macro-Groups]
Micro Frequency Range	25 Mhz each Macro-group
Tone-code Frequency	32.768 KHz
Pre-emphasis	50 µsec
Limiter Range	>30dB of audio overload
Battery Type	2 AA
Battery Life [Alkaline]	Approx. 8 Hours
BP Microphone Connector	TA4F
BP Weight w/o Batteries	3 oz / 85g
HM Weight w/o Batteries	4.2 oz / 120g

Note: Specifications are subject to change without notice.

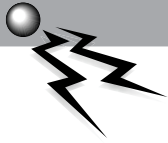

Wireless Channel Assignments	
LightSPEED Channel	Frequency Range
E	620.000 – 644.750
H	645.000 – 669.750
L	670.000 – 694.750
P	695.000 – 719.750
U	720.000 – 744.750



Components & Accessories

Delta X10/12 Individual Components and Accessories

Order Code	Product Description
AMP-DELTA-X10	Delta Series Amp w/10" Speaker
AMP-DELTA-X12	Delta Series Amp w/12" Speaker
RX-7100R	100 Channel UHF Receiver
TX-HM900	100 Channel UHF Handheld Transmitter
TX-BP900	100 Channel UHF Belt-pack Transmitter
AC-DELTACD	CD Player for Delta X Systems
AC-SS1	Tripod Speaker Stand
AC-HCDELTA	Hard Case for Delta X10 and X12
AC-SCDELTA	Soft Side Trolley Case for Delta X10 and X12
MC-H10	Wired Dynamic Microphone
MC-831S	Audio Technica AT831 Lapel Mic
MC-TK250S	LightSPEED Noise-canceling Headset Mic
MC-E6TS	Countryman E6 Earset Mic - Tan Color
CA-AL50	50 Foot Active Link Cable
CA-AL100	100 Foot Active Link Cable
CA-ALGL	Active Link Ground Lift Cable
BA-LA12-5	12V/5AH Lead Acid Battery (Delta X10)
BA-LA12-7	12V/7AH Lead Acid Battery (Delta X12)

*Contact your LightSPEED representative for details, pricing and availability.
For additional accessories, please visit our website.*



The LightSPEED Technologies Delta X10 and Delta X12 are warranted to be free from defects in materials and workmanship for the period of SIX (6) YEARS from the date of original purchase, subject to the following conditions:

1. The product must have been purchased from LightSPEED, an authorized LightSPEED Technologies Dealer, or LightSPEED representative.
2. LightSPEED Technologies must perform all warranty service. Any service performed without the authorization of LightSPEED Technologies will void the entire warranty.
3. This warranty does not cover any product that has been subjected to negligent use, connection to improper power source, misuse, or operated beyond its manufactured specifications and limits, or has not been reasonably maintained.
4. Lead-Acid Batteries installed in the DELTA X Wireless Sound Systems shall be warranted for a TWO (2) YEAR period from date of purchase.
5. Rechargeable AA Nickel Metal Hydride (*NiMH*) batteries sold with some systems shall be warranted for ONE (1) YEAR from date of purchase.
6. Warranty shall not apply to batteries (*other than those mentioned in items 4 and 5 above*), exterior finish, AC power cords, bulbs, or any other failings due to normal wear.
7. Warranty is void when equipment is subjected to adverse temperature, humidity, moisture, or other conditions that are not considered normal environmental conditions.
8. LightSPEED lapel, lavalier, and headset microphones shall be warranted for ONE (1) year from date of purchase.
9. Third party microphones and accessories shall be under the original manufacturer's warranty.
10. Warranty for wireless receivers and transmitters shall be three (3) years from date of purchase.
11. This warranty excludes all damages or defects caused by shipping, transporting, or inadequate packaging for shipment.
12. Customers are responsible for freight charges to LightSPEED Technologies for service. LightSPEED Technologies will pay for return freight to the end user by most reasonable method.

For warranty service, please contact LightSPEED Technologies customer service department at (800.732.8999, 7:00AM – 5:00PM PST) to obtain Return Authorization approval and RA (Return Authorization) number.

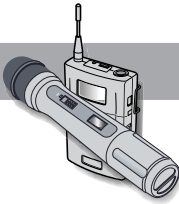

Equipment Log

Record your system serial numbers and purchase information. This is helpful when ordering additional components, accessories, and/or warranty service.

Component	Serial Number
<i>Delta X10/X12</i>	
<i>Receiver[s]</i>	
<i>Transmitter[s]</i>	
<i>Microphone[s]</i>	

Purchase Information	
<i>Your Name/Company</i>	
<i>Purchase Date</i>	
<i>Dealer Name/Location</i>	
<i>Invoice #</i>	



LightSPEED Technologies, Inc.
Tualatin, OR U.S.A.
1.800.732.8999
503.684.5538 fax: 503.684.3197
www.lightspeed-tek.com

Free Manuals Download Website

<http://myh66.com>

<http://usermanuals.us>

<http://www.somanuals.com>

<http://www.4manuals.cc>

<http://www.manual-lib.com>

<http://www.404manual.com>

<http://www.luxmanual.com>

<http://aubethermostatmanual.com>

Golf course search by state

<http://golfingnear.com>

Email search by domain

<http://emailbydomain.com>

Auto manuals search

<http://auto.somanuals.com>

TV manuals search

<http://tv.somanuals.com>