

POWER-ARC™ 5500

For Machines with Code Number 11182, 11187, 11215, 11403, 11404

Safety Depends on You

Lincoln arc welding and cutting equipment is designed and built with safety in mind. However, your overall safety can be increased by proper installation ... and thoughtful operation on your part. **DO NOT INSTALL, OPERATE OR REPAIR THIS EQUIPMENT WITHOUT READING THIS MANUAL AND THE SAFETY PRECAUTIONS CONTAINED THROUGHOUT.** And, most importantly, think before you act and be careful.

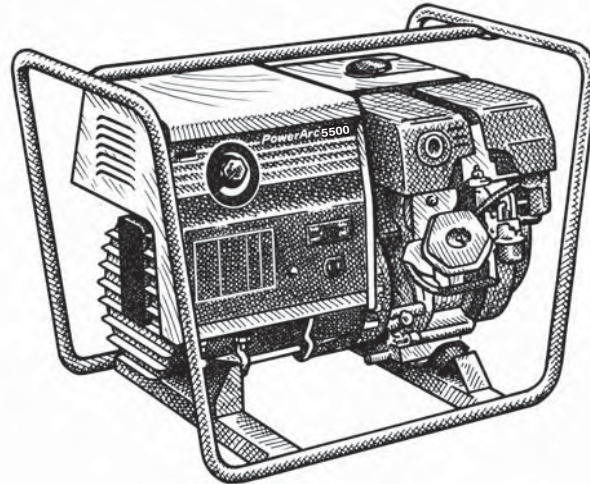

Various engine configurations are available and machine appearance will vary accordingly.

OPERATOR'S MANUAL



LINCOLN®
ELECTRIC

Copyright © 2007 Lincoln Global Inc.

• World's Leader in Welding and Cutting Products •

• Sales and Service through Subsidiaries and Distributors Worldwide •

Cleveland, Ohio 44117-1199 U.S.A. TEL: 216.481.8100 FAX: 216.486.1751 WEB SITE: www.lincolnelectric.com

Download from Www.Somanuals.com. All Manuals Search And Download.

⚠ WARNING

⚠ CALIFORNIA PROPOSITION 65 WARNINGS ⚠

Diesel engine exhaust and some of its constituents are known to the State of California to cause cancer, birth defects, and other reproductive harm.

The Above For Diesel Engines

The engine exhaust from this product contains chemicals known to the State of California to cause cancer, birth defects, or other reproductive harm.

The Above For Gasoline Engines

ARC WELDING CAN BE HAZARDOUS. PROTECT YOURSELF AND OTHERS FROM POSSIBLE SERIOUS INJURY OR DEATH. KEEP CHILDREN AWAY. PACEMAKER WEARERS SHOULD CONSULT WITH THEIR DOCTOR BEFORE OPERATING.

Read and understand the following safety highlights. For additional safety information, it is strongly recommended that you purchase a copy of "Safety in Welding & Cutting - ANSI Standard Z49.1" from the American Welding Society, P.O. Box 351040, Miami, Florida 33135 or CSA Standard W117.2-1974. A Free copy of "Arc Welding Safety" booklet E205 is available from the Lincoln Electric Company, 22801 St. Clair Avenue, Cleveland, Ohio 44117-1199.

BE SURE THAT ALL INSTALLATION, OPERATION, MAINTENANCE AND REPAIR PROCEDURES ARE PERFORMED ONLY BY QUALIFIED INDIVIDUALS.



FOR ENGINE powered equipment.

1.a. Turn the engine off before troubleshooting and maintenance work unless the maintenance work requires it to be running.



1.b. Operate engines in open, well-ventilated areas or vent the engine exhaust fumes outdoors.



1.c. Do not add the fuel near an open flame welding arc or when the engine is running. Stop the engine and allow it to cool before refueling to prevent spilled fuel from vaporizing on contact with hot engine parts and igniting. Do not spill fuel when filling tank. If fuel is spilled, wipe it up and do not start engine until fumes have been eliminated.

1.d. Keep all equipment safety guards, covers and devices in position and in good repair. Keep hands, hair, clothing and tools away from V-belts, gears, fans and all other moving parts when starting, operating or repairing equipment.

1.e. In some cases it may be necessary to remove safety guards to perform required maintenance. Remove guards only when necessary and replace them when the maintenance requiring their removal is complete. Always use the greatest care when working near moving parts.



1.f. Do not put your hands near the engine fan. Do not attempt to override the governor or idler by pushing on the throttle control rods while the engine is running.

1.g. To prevent accidentally starting gasoline engines while turning the engine or welding generator during maintenance work, disconnect the spark plug wires, distributor cap or magneto wire as appropriate.



1.h. To avoid scalding, do not remove the radiator pressure cap when the engine is hot.



ELECTRIC AND MAGNETIC FIELDS may be dangerous

2.a. Electric current flowing through any conductor causes localized Electric and Magnetic Fields (EMF). Welding current creates EMF fields around welding cables and welding machines

2.b. EMF fields may interfere with some pacemakers, and welders having a pacemaker should consult their physician before welding.

2.c. Exposure to EMF fields in welding may have other health effects which are now not known.

2.d. All welders should use the following procedures in order to minimize exposure to EMF fields from the welding circuit:

2.d.1. Route the electrode and work cables together - Secure them with tape when possible.

2.d.2. Never coil the electrode lead around your body.

2.d.3. Do not place your body between the electrode and work cables. If the electrode cable is on your right side, the work cable should also be on your right side.

2.d.4. Connect the work cable to the workpiece as close as possible to the area being welded.

2.d.5. Do not work next to welding power source.

Mar 95



ELECTRIC SHOCK can kill.

- 3.a. The electrode and work (or ground) circuits are electrically "hot" when the welder is on. Do not touch these "hot" parts with your bare skin or wet clothing. Wear dry, hole-free gloves to insulate hands.
- 3.b. Insulate yourself from work and ground using dry insulation. Make certain the insulation is large enough to cover your full area of physical contact with work and ground.
- In addition to the normal safety precautions, if welding must be performed under electrically hazardous conditions (in damp locations or while wearing wet clothing; on metal structures such as floors, gratings or scaffolds; when in cramped positions such as sitting, kneeling or lying, if there is a high risk of unavoidable or accidental contact with the workpiece or ground) use the following equipment:**
- Semiautomatic DC Constant Voltage (Wire) Welder.
 - DC Manual (Stick) Welder.
 - AC Welder with Reduced Voltage Control.
- 3.c. In semiautomatic or automatic wire welding, the electrode, electrode reel, welding head, nozzle or semiautomatic welding gun are also electrically "hot".
- 3.d. Always be sure the work cable makes a good electrical connection with the metal being welded. The connection should be as close as possible to the area being welded.
- 3.e. Ground the work or metal to be welded to a good electrical (earth) ground.
- 3.f. Maintain the electrode holder, work clamp, welding cable and welding machine in good, safe operating condition. Replace damaged insulation.
- 3.g. Never dip the electrode in water for cooling.
- 3.h. Never simultaneously touch electrically "hot" parts of electrode holders connected to two welders because voltage between the two can be the total of the open circuit voltage of both welders.
- 3.i. When working above floor level, use a safety belt to protect yourself from a fall should you get a shock.
- 3.j. Also see Items 6.c. and 8.



ARC RAYS can burn.

- 4.a. Use a shield with the proper filter and cover plates to protect your eyes from sparks and the rays of the arc when welding or observing open arc welding. Headshield and filter lens should conform to ANSI Z87.1 standards.
- 4.b. Use suitable clothing made from durable flame-resistant material to protect your skin and that of your helpers from the arc rays.
- 4.c. Protect other nearby personnel with suitable, non-flammable screening and/or warn them not to watch the arc nor expose themselves to the arc rays or to hot spatter or metal.



FUMES AND GASES can be dangerous.

- 5.a. Welding may produce fumes and gases hazardous to health. Avoid breathing these fumes and gases. When welding, keep your head out of the fume. Use enough ventilation and/or exhaust at the arc to keep fumes and gases away from the breathing zone. **When welding with electrodes which require special ventilation such as stainless or hard facing (see instructions on container or MSDS) or on lead or cadmium plated steel and other metals or coatings which produce highly toxic fumes, keep exposure as low as possible and below Threshold Limit Values (TLV) using local exhaust or mechanical ventilation. In confined spaces or in some circumstances, outdoors, a respirator may be required. Additional precautions are also required when welding on galvanized steel.**
5. b. The operation of welding fume control equipment is affected by various factors including proper use and positioning of the equipment, maintenance of the equipment and the specific welding procedure and application involved. Worker exposure level should be checked upon installation and periodically thereafter to be certain it is within applicable OSHA PEL and ACGIH TLV limits.
- 5.c. Do not weld in locations near chlorinated hydrocarbon vapors coming from degreasing, cleaning or spraying operations. The heat and rays of the arc can react with solvent vapors to form phosgene, a highly toxic gas, and other irritating products.
- 5.d. Shielding gases used for arc welding can displace air and cause injury or death. Always use enough ventilation, especially in confined areas, to insure breathing air is safe.
- 5.e. Read and understand the manufacturer's instructions for this equipment and the consumables to be used, including the material safety data sheet (MSDS) and follow your employer's safety practices. MSDS forms are available from your welding distributor or from the manufacturer.
- 5.f. Also see item 1.b.

AUG 06

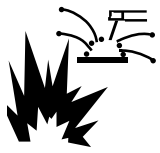

WELDING and CUTTING SPARKS can cause fire or explosion.

6.a. Remove fire hazards from the welding area. If this is not possible, cover them to prevent the welding sparks from starting a fire.

Remember that welding sparks and hot materials from welding can easily go through small cracks and openings to adjacent areas. Avoid welding near hydraulic lines. Have a fire extinguisher readily available.

- 6.b. Where compressed gases are to be used at the job site, special precautions should be used to prevent hazardous situations. Refer to "Safety in Welding and Cutting" (ANSI Standard Z49.1) and the operating information for the equipment being used.
- 6.c. When not welding, make certain no part of the electrode circuit is touching the work or ground. Accidental contact can cause overheating and create a fire hazard.
- 6.d. Do not heat, cut or weld tanks, drums or containers until the proper steps have been taken to insure that such procedures will not cause flammable or toxic vapors from substances inside. They can cause an explosion even though they have been "cleaned". For information, purchase "Recommended Safe Practices for the Preparation for Welding and Cutting of Containers and Piping That Have Held Hazardous Substances", AWS F4.1 from the American Welding Society (see address above).
- 6.e. Vent hollow castings or containers before heating, cutting or welding. They may explode.
- 6.f. Sparks and spatter are thrown from the welding arc. Wear oil free protective garments such as leather gloves, heavy shirt, cuffless trousers, high shoes and a cap over your hair. Wear ear plugs when welding out of position or in confined places. Always wear safety glasses with side shields when in a welding area.
- 6.g. Connect the work cable to the work as close to the welding area as practical. Work cables connected to the building framework or other locations away from the welding area increase the possibility of the welding current passing through lifting chains, crane cables or other alternate circuits. This can create fire hazards or overheat lifting chains or cables until they fail.
- 6.h. Also see item 1.c.
- 6.i. Read and follow NFPA 51B "Standard for Fire Prevention During Welding, Cutting and Other Hot Work", available from NFPA, 1 Batterymarch Park, PO box 9101, Quincy, Ma 02269-9101.
- 6.j. Do not use a welding power source for pipe thawing.

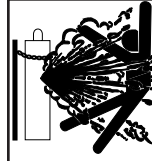

CYLINDER may explode if damaged.

- 7.a. Use only compressed gas cylinders containing the correct shielding gas for the process used and properly operating regulators designed for the gas and pressure used. All hoses, fittings, etc. should be suitable for the application and maintained in good condition.
- 7.b. Always keep cylinders in an upright position securely chained to an undercarriage or fixed support.
- 7.c. Cylinders should be located:
 - Away from areas where they may be struck or subjected to physical damage.
 - A safe distance from arc welding or cutting operations and any other source of heat, sparks, or flame.
- 7.d. Never allow the electrode, electrode holder or any other electrically "hot" parts to touch a cylinder.
- 7.e. Keep your head and face away from the cylinder valve outlet when opening the cylinder valve.
- 7.f. Valve protection caps should always be in place and hand tight except when the cylinder is in use or connected for use.
- 7.g. Read and follow the instructions on compressed gas cylinders, associated equipment, and CGA publication P-1, "Precautions for Safe Handling of Compressed Gases in Cylinders," available from the Compressed Gas Association 1235 Jefferson Davis Highway, Arlington, VA 22202.



FOR ELECTRICALLY powered equipment.

- 8.a. Turn off input power using the disconnect switch at the fuse box before working on the equipment.
- 8.b. Install equipment in accordance with the U.S. National Electrical Code, all local codes and the manufacturer's recommendations.
- 8.c. Ground the equipment in accordance with the U.S. National Electrical Code and the manufacturer's recommendations.

Jan, 07

PRÉCAUTIONS DE SÛRETÉ

Pour votre propre protection lire et observer toutes les instructions et les précautions de sûreté spécifiques qui paraissent dans ce manuel aussi bien que les précautions de sûreté générales suivantes:

Sûreté Pour Soudage A L'Arc

1. Protégez-vous contre la secousse électrique:
 - a. Les circuits à l'électrode et à la pièce sont sous tension quand la machine à souder est en marche. Eviter toujours tout contact entre les parties sous tension et la peau nue ou les vêtements mouillés. Porter des gants secs et sans trous pour isoler les mains.
 - b. Faire très attention de bien s'isoler de la masse quand on soude dans des endroits humides, ou sur un plancher métallique ou des grilles métalliques, principalement dans les positions assis ou couché pour lesquelles une grande partie du corps peut être en contact avec la masse.
 - c. Maintenir le porte-électrode, la pince de masse, le câble de soudage et la machine à souder en bon et sûr état de fonctionnement.
 - d. Ne jamais plonger le porte-électrode dans l'eau pour le refroidir.
 - e. Ne jamais toucher simultanément les parties sous tension des porte-électrodes connectés à deux machines à souder parce que la tension entre les deux pinces peut être le total de la tension à vide des deux machines.
 - f. Si on utilise la machine à souder comme une source de courant pour soudage semi-automatique, ces précautions pour le porte-électrode s'appliquent aussi au pistolet de soudage.
2. Dans le cas de travail au dessus du niveau du sol, se protéger contre les chutes dans le cas où on reçoit un choc. Ne jamais enrouler le câble-électrode autour de n'importe quelle partie du corps.
3. Un coup d'arc peut être plus sévère qu'un coup de soleil, donc:
 - a. Utiliser un bon masque avec un verre filtrant approprié ainsi qu'un verre blanc afin de se protéger les yeux du rayonnement de l'arc et des projections quand on soude ou quand on regarde l'arc.
 - b. Porter des vêtements convenables afin de protéger la peau de soudeur et des aides contre le rayonnement de l'arc.
 - c. Protéger l'autre personnel travaillant à proximité au soudage à l'aide d'écrans appropriés et non-inflammables.
4. Des gouttes de laitier en fusion sont émises de l'arc de soudage. Se protéger avec des vêtements de protection libres de l'huile, tels que les gants en cuir, chemise épaisse, pantalons sans revers, et chaussures montantes.

5. Toujours porter des lunettes de sécurité dans la zone de soudage. Utiliser des lunettes avec écrans latéraux dans les zones où l'on pique le laitier.
6. Eloigner les matériaux inflammables ou les recouvrir afin de prévenir tout risque d'incendie dû aux étincelles.
7. Quand on ne soude pas, poser la pince à un endroit isolé de la masse. Un court-circuit accidentel peut provoquer un échauffement et un risque d'incendie.
8. S'assurer que la masse est connectée le plus près possible de la zone de travail qu'il est pratique de le faire. Si on place la masse sur la charpente de la construction ou d'autres endroits éloignés de la zone de travail, on augmente le risque de voir passer le courant de soudage par les chaînes de levage, câbles de grue, ou autres circuits. Cela peut provoquer des risques d'incendie ou d'échauffement des chaînes et des câbles jusqu'à ce qu'ils se rompent.
9. Assurer une ventilation suffisante dans la zone de soudage. Ceci est particulièrement important pour le soudage de tôles galvanisées plombées, ou cadmiées ou tout autre métal qui produit des fumées toxiques.
10. Ne pas souder en présence de vapeurs de chlore provenant d'opérations de dégraissage, nettoyage ou pistolage. La chaleur ou les rayons de l'arc peuvent réagir avec les vapeurs du solvant pour produire du phosgène (gas fortement toxique) ou autres produits irritants.
11. Pour obtenir de plus amples renseignements sur la sûreté, voir le code "Code for safety in welding and cutting" CSA Standard W 117.2-1974.

PRÉCAUTIONS DE SÛRETÉ POUR LES MACHINES À SOUDER À TRANSFORMATEUR ET À REDRESSEUR

1. Relier à la terre le châssis du poste conformément au code de l'électricité et aux recommandations du fabricant. Le dispositif de montage ou la pièce à souder doit être branché à une bonne mise à la terre.
2. Autant que possible, l'installation et l'entretien du poste seront effectués par un électricien qualifié.
3. Avant de faire des travaux à l'intérieur de poste, la débrancher à l'interrupteur à la boîte de fusibles.
4. Garder tous les couvercles et dispositifs de sûreté à leur place.

Thank You

for selecting a **QUALITY** product by Lincoln Electric. We want you to take pride in operating this Lincoln Electric Company product
 ... as much pride as we have in bringing this product to you!

CUSTOMER ASSISTANCE POLICY

The business of The Lincoln Electric Company is manufacturing and selling high quality welding equipment, consumables, and cutting equipment. Our challenge is to meet the needs of our customers and to exceed their expectations. On occasion, purchasers may ask Lincoln Electric for advice or information about their use of our products. We respond to our customers based on the best information in our possession at that time. Lincoln Electric is not in a position to warrant or guarantee such advice, and assumes no liability, with respect to such information or advice. We expressly disclaim any warranty of any kind, including any warranty of fitness for any customer's particular purpose, with respect to such information or advice. As a matter of practical consideration, we also cannot assume any responsibility for updating or correcting any such information or advice once it has been given, nor does the provision of information or advice create, expand or alter any warranty with respect to the sale of our products.

Lincoln Electric is a responsive manufacturer, but the selection and use of specific products sold by Lincoln Electric is solely within the control of, and remains the sole responsibility of the customer. Many variables beyond the control of Lincoln Electric affect the results obtained in applying these types of fabrication methods and service requirements.

Subject to Change – This information is accurate to the best of our knowledge at the time of printing. Please refer to www.lincolnelectric.com for any updated information.

Please Examine Carton and Equipment For Damage Immediately

When this equipment is shipped, title passes to the purchaser upon receipt by the carrier. Consequently, Claims for material damaged in shipment must be made by the purchaser against the transportation company at the time the shipment is received.

Please record your equipment identification information below for future reference. This information can be found on your machine nameplate.

Product _____

Model Number _____

Code Number or Date Code _____

Serial Number _____

Date Purchased _____

Where Purchased _____

Whenever you request replacement parts or information on this equipment, always supply the information you have recorded above. The code number is especially important when identifying the correct replacement parts.

On-Line Product Registration

- Register your machine with Lincoln Electric either via fax or over the Internet.
 - For faxing: Complete the form on the back of the warranty statement included in the literature packet accompanying this machine and fax the form per the instructions printed on it.
 - For On-Line Registration: Go to our **WEB SITE at www.lincolnelectric.com**. Choose "Quick Links" and then "Product Registration". Please complete the form and submit your registration.

Read this Operators Manual completely before attempting to use this equipment. Save this manual and keep it handy for quick reference. Pay particular attention to the safety instructions we have provided for your protection. The level of seriousness to be applied to each is explained below:

⚠ WARNING

This statement appears where the information **must** be followed **exactly** to avoid **serious personal injury or loss of life**.

⚠ CAUTION

This statement appears where the information **must** be followed to avoid **minor personal injury or damage to this equipment**.

	Page
Safety	i-iv
<hr/>	
Installation	Section A
Technical Specifications	A-1
Safety Precautions	A-2
Location and Ventilation	A-2
Pre-operation Engine Service	A-3, A-4
Electrical Output Connections	A-5, A-6
Premises Wiring and Circuit Breakers	A-7
Electrical Devises used with the POWER-ARC 5500	A-8
<hr/>	
Operation	Section B
Safety Instructions	B-1
General Description	B-1
Recommended Applications.....	B-1
Operational Features and Controls.....	B-1
Welding Capability	B-1
Limitations	B-2
Controls and Settings	B-2
Engine Operation	B-3 Thru B-6
Welding Operation	B-7 Thru B-16
<hr/>	
Accessories	Section C
<hr/>	
Maintenance	Section D
Safety Precautions	D-1
Routine and Periodic Maintenance	D-1
General Assembly Exploded View	D-5
<hr/>	
Troubleshooting and Repair	Section E
<hr/>	
Electrical Diagrams and Dimension Print	Section F
<hr/>	
Parts Manual (Robin / Subaru and Honda Engines)	P-510 Series

TECHNICAL SPECIFICATIONS - POWER-ARC 5500

INPUT - GASOLINE ENGINE					
<u>Manufacturer</u>	<u>Description</u>	<u>Speed</u>	<u>Displacement</u>	<u>Ignition</u>	<u>Capacities</u>
Robin / Subaru EX 27 Codes (11182) (11187) (11403)	1 cyl., 4 cycle air-cooled OHC gasoline 9 HP @ 3600 RPM	3700 RPM ± 50 RPM at no load	16.17 cu. in. (265 cc)	Manual, Recoil start; Manual choke	Fuel: 1.6 gal. (6.1 l) Oil: 1.1 qts.(1.0 l)
Honda GX 270 VA2 Codes (11215) (11404)	1 cyl., 4 cycle air-cooled OHV gasoline 9 HP @ 3600 RPM	3700 RPM ± 50 RPM at no load	16.5 cu. in. (270 cc)	Manual, Recoil start; Manual choke	Fuel: 1.6 gal. (6.1 l) Oil: 1.2 qt. (1.1 l)
RATED OUTPUT - WELDER					
<u>Duty Cycle</u>		<u>Amps AC</u>		<u>Volts at Rated Amperes</u>	
30% Duty Cycle		125 Amps AC Constant Current		20 VAC	
60% Duty Cycle		100 Amps AC Constant Current		25 VAC	
OUTPUT - WELDER AND GENERATOR					
<u>Welding Ranges</u>		<u>Welder Open Circuit Voltage</u>		<u>AC Auxiliary Power</u>	
70 - 125 Amps AC		62 VAC Max.		4000 Continuous Watts 5500 Surge Watts	
PHYSICAL DIMENSIONS					
<u>Height</u>	<u>Width</u>	<u>Depth</u>	<u>Weight</u>		
20.9 in. 530 mm	20 in. 508 mm	30 in. 762 mm	160 lb. 72.5 kg		

POWER-ARC 5500



SAFETY PRECAUTIONS

Read this entire installation section before you start installation.



WARNING

Do not attempt to use this equipment until you have thoroughly read all the operation and maintenance manuals supplied with your machine. They include important safety precautions; detailed engine starting, operating, and maintenance instructions; and parts lists.

ELECTRIC SHOCK can kill.



- Do not touch electrically live parts or electrodes with your skin or wet clothing.
- Insulate yourself from the work and ground.

- Always wear dry insulating gloves.

ENGINE EXHAUST can kill.



- Use in open, well ventilated areas or vent exhaust to the outside.
- Do not stack anything on or near the engine.

MOVING PARTS can injure.



- Do not operate this equipment with any of its doors open or guards off.
- Stop the engine before servicing it.

- Keep away from moving parts.

Only qualified personnel should install, use, or service this equipment.

LOCATION AND VENTILATION

Whenever you use the POWER-ARC 5500, be sure that clean cooling air can flow through the machine's gasoline engine and the generator. Avoid dusty, dirty areas. Also, keep the machine away from heat sources. Do not place the back end of the generator anywhere near hot engine exhaust from another machine. And of course, make sure that engine exhaust is ventilated to an open, outside area.

The POWER-ARC 5500 must be used outdoors. Do not set the machine in puddles or otherwise submerge it in water. Such practices pose safety hazards and cause improper operation and corrosion of parts.

Always operate the POWER-ARC 5500 with the case roof on and all machine components completely assembled. This will protect you from the dangers of moving parts, hot metal surfaces, and live electrical devices.

STORING

1. Store the machine in a cool, dry place when it's not in use. Protect it from dust and dirt. Keep it where it can't be accidentally damaged from construction activities, moving vehicles, and other hazards.
2. If you will be storing the machine for over 30 days, you should drain the fuel to protect fuel system and carburetor parts from gum deposits. Empty all fuel from the tank and run the engine until it stops from lack of fuel.
3. You can store the machine for up to 24 months if you use a gasoline stabilizing additive in the fuel system. Mix the additive with the fuel in the tank and run the engine for a short time to circulate the additive through the carburetor.
4. While the engine is still warm, drain the oil and refill with fresh oil per the engine manual.
5. Remove the spark plug and pour approximately 1/2 ounce (15 ml) of engine oil into the cylinder. Replace the spark plug and crank the engine slowly to distribute the oil.
6. Clean any dirt and debris from the cylinder and cylinder head fins and housing, rotating screen, and muffler areas.
7. Store in a clean, dry area.

POWER-ARC 5500



STACKING

POWER-ARC 5500 machines CANNOT be stacked.

TILTING

Place the machine on a secure, level surface whenever you use it or store it. Any surfaces you place it on other than the ground must be firm, non-skid, and structurally sound.

The gasoline engine is designed to run in a level position for best performance. It can operate at an angle, but this should never be more than 15 degrees in any direction. If you do operate it at a slight angle, be sure to check the oil regularly and keep the oil level full. Also, fuel capacity will be a little less at an angle.

LIFTING

The POWER-ARC 5500 should be lifted by two people. (It weighs 160 lbs/72.5 kg.) Its welded tube roll cage is designed to make lifting easy.

ANGLE OF OPERATION

Internal combustion engines are designed to run in a level condition to achieve optimum performance. The maximum angle of operation for the engine is 15 degrees from horizontal in any direction. Be certain to place the machine on a firm, non-skid, structural supporting surface. Anchor unit if necessary.

If you are operating the engine at a slight angle, be certain to check the oil regularly and maintain a level, full oil condition. The effective fuel capacity will also be slightly less than the specified 1.6 gallon (6.1 liters).

PRE-OPERATION ENGINE SERVICE

Read and understand the information about the gasoline engine in the OPERATION and MAINTENANCE sections of this manual and the engine owner's manual before you operate the POWER-ARC 5500.

OIL



The Power-Arc 5500 with the Robin / Subaru 9HP engine and the Power-Arc 5500 with the Honda 9 HP engine are supplied with low oil protection. Both engines are equipped with protection that will shut down the engine in the event of a low oil condition. The engine cannot be restarted until sufficient oil is added.

The POWER-ARC 5500 is shipped with the engine filled with SAE 10W-30 oil. **CHECK THE OIL LEVEL BEFORE YOU START THE ENGINE.** This is an added precaution. When full, the oil level should be at the top of the fill plug hole. If it is not full, add enough oil to fill it. Be sure the fill plug is tight. Change oil after the first 20 hours of operation. For more oil fill and service information, see the Engine owner's manual.



FUEL

Fill the fuel tank with clean, fresh, regular grade lead-free gasoline. **DO NOT MIX OIL WITH THE GASOLINE.** Remove the fuel cap slowly to release pressure. Keep hands away from the engine muffler or HOT engine parts.

WARNING



GASOLINE can cause fire or explosion.

- Stop engine while fueling.
- Do not smoke when fueling.
- Keep sparks and flame away from tank.
- Do not leave unattended while fueling.
- Wipe up spilled fuel and allow fumes to clear before starting engine.
- Do not overfill tank, fuel expansion may cause overflow.

GASOLINE FUEL ONLY

The POWER-ARC 5500 has a fuel tank mounted on the engine. See the engine owner's manual for more details about fuel.

PowerArc 5500 Typical Fuel Consumption

	Robin / Subaru 9 HP Carb. Certified EX 27	Honda 9 HP Carb. Certified
No Load 3700 RPM ±50 R.P.M.	0.31 Gallons/Hour (1.17 Liters/Hour)	.30 Gallons/Hour (1.14 Liters/Hour)
AC CC Weld Output 125 Amps @ 20 Volts	.70 Gallons/Hour (2.66 Liters/Hour)	.58 Gallons/Hour (2.18 Liters/Hour)
AC CC Weld Output 100 Amps @ 25 Volts	.66 Gallons/Hour (2.48 Liters/Hour)	.55 Gallons/Hour (2.1 Liters/Hour)
Auxiliary Power 4000 Watts (120/240 Volts)	.68 Gallons/Hour (2.59 Liters/Hour)	.67 Gallons/Hour (2.54 Liters/Hour)

MUFFLER DEFLECTOR

The POWER-ARC 5500, Honda model, may or may not be shipped with an exhaust deflector. If you received one, you can mount it on the gasoline engine if your needs so require.

To install the deflector, do the following:

- Align the holes on the deflector plate with the holes on the muffler.
- Position the deflector so that the opening points either right, left, or downward, away from the operator.



Never position the deflector upward. Moisture or debris can enter the engine and damage it. As a general safety practice, position the deflector to direct exhaust gases away from the operator's face and eyes.

- Fasten the deflector onto the muffler with the screws provided.

NOTE: The deflector reduces generator output power up to 100 watts.

SPARK ARRESTER

Gasoline engine mufflers may emit sparks when the engine is running. Some federal, state, or local laws require spark arresters in locations where unarrested sparks could present a fire hazard.

The Robin / Subaru and Honda models of the Power-Arc 5500 come with a spark arrester as standard equipment. Refer to the engine owner's manual for proper maintenance.



An incorrect additional spark arrester may lead to damage to the engine or reduce performance.

POWER-ARC 5500 OUTPUT CONNECTIONS

Physical Location of Items and Components may vary by Code No.

FIGURE A.1 (For Codes 11182, 11187, 11215)

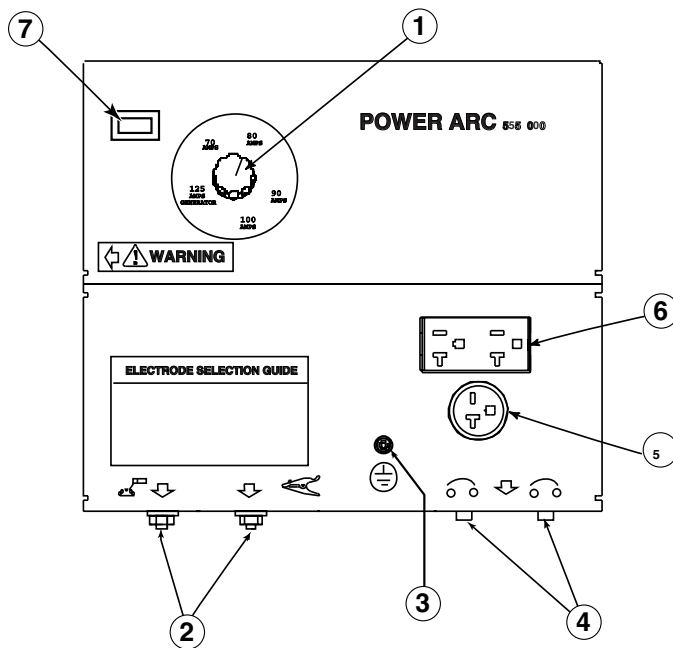

1. CURRENT CONTROL DIAL
2. WELD OUTPUT TERMINALS (2)
3. GROUND STUD
4. CIRCUIT BREAKERS (2) - 20 AMP
5. RECEPTACLE - 240 VOLT, 20 AMP
6. DUPLEX RECEPTACLE - 120 VOLT, 20 AMP
7. TACHOMETER / HOURMETER
(CODE 11215 ONLY)

FIGURE A.2 (For Codes 11403, 11404)

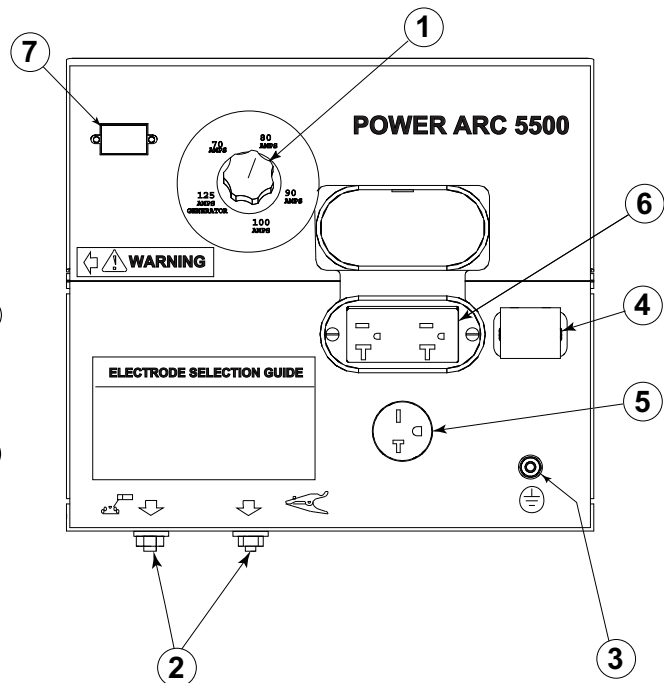

1. CURRENT CONTROL DIAL
2. WELD OUTPUT TERMINALS (2)
3. GROUND STUD
4. CIRCUIT BREAKER - 20 AMP
5. RECEPTACLE - 240 VOLT, 20 AMP
6. DUPLEX RECEPTACLE - 120 VOLT, 20 AMP
7. TACHOMETER / HOURMETER
(CODE 11404 ONLY)

ELECTRICAL OUTPUT CONNECTIONS

See Figure A.1 for the location of the current control dial, weld output terminals, ground stud, circuit breakers, 240 and 120 volt receptacles.

WELDING CABLE CONNECTIONS

Cable Size and Length

Be sure to use welding cables that are large enough. The correct size and length becomes especially important when you are welding at a distance from the welder.

Table A.1 lists recommended cable sizes and lengths for rated current and duty cycle. Length refers to the distance from the welder to the work and back to the welder. Cable diameters are increased for long cable lengths to reduce voltage drops.

TABLE A.1
RECOMMENDED WELDING CABLE
SIZE AND LENGTH

TOTAL COMBINED LENGTH OF ELECTRODE AND WORK CABLES

Cable Length	Cable Size for 125 amp/ 30% Duty Cycle
0-50 feet (0-15 meters)	6 AWG
50-100 feet (15-39 meters)	4 AWG
100-150 feet (30-46 meters)	3 AWG
150-200 feet (46-61 meters)	2 AWG
200-250 feet (61-76 meters)	1 AWG

POWER-ARC 5500



Cable Installation

Install the welding cables to your POWER-ARC 5500 as follows. See Figure A.1 for the location of parts.

1. The gasoline engine must be OFF to install welding cables.
2. Remove the 1/2 - 13 flanged nuts from the output terminals.
3. Connect the electrode holder and work cables to the weld output terminals. You can connect either cable to either terminal, since the POWER-ARC 5500 provides AC weld current.
4. Tighten the flanged nuts securely.
5. Be certain that the metal piece you are welding (the "work") is securely connected to the work clamp and cable.
6. Check and tighten the connections periodically.



CAUTION

- Loose connections will cause the output terminals to overheat. The terminals may eventually melt.
- Do not cross the welding cables at the output terminal connection. Keep the cables isolated and separate from one another.

Lincoln Electric offers a welding accessory kit with the properly specified welding cables. See the ACCESSORIES section of this manual for more information.

MACHINE GROUNDING



Because the POWER-ARC 5500 creates its own power from its gasoline-engine driven generator, you do not need to connect the machine frame to an earth ground. However, for best protection against electrical shock, connect a heavy gauge wire from the ground stud located on the bottom center of the output panel (see Figure A.1) to a suitable earth ground such as a metal pipe driven into the ground.



WARNING

Do not ground the machine to a pipe that carries explosive or combustible material.

When the POWER-ARC 5500 is mounted on a truck or a trailer, the machine generator ground stud MUST be securely connected to the metal frame of the vehicle. See Figure A.1. The ground stud is marked with the symbol.



PLUGS AND HAND-HELD EQUIPMENT

For further protection against electric shock, any electrical equipment connected to the generator receptacles must use a three-blade, grounded type plug or an Underwriter's Laboratories (UL) approved double insulation system with a two-blade plug.

Ground fault protection is needed for hand held equipment.



WARNING

Never operate this machine with damaged or defective cords. All electrical equipment must be in safe condition.

AUXILIARY POWER RECEPTACLES

The control panel of the POWER-ARC 5500 features two auxiliary power receptacles:

- A 20 amp, 120 volt duplex (double outlet) receptacle
- A 20 amp 240 volt simplex (single outlet) receptacle.

See Figure A.1.

Through these receptacles the machine can supply up to 4,000 rated continuous watts and 5,500 surge watts of single-phase AC power.

PREMISES WIRING

The POWER-ARC 5500 three-wire, grounded neutral generator allows it to be connected to premises wiring. However, the wiring procedure needed to meet the National Electrical Code (NEC) regulations as well as city ordinances and can be confusing. The connections could vary from a "commonly grounded" to a "separately derived" system depending on whether you want the unit to be "hard wired" or temporary to the premises.



WARNING

Only a licensed, certified, trained electrician should install the machine to a premises or residential electrical system. Be certain that:

- The premises is isolated and no feed backing into the utility system can occur. Certain state and local laws require the premises to be isolated before the generator is linked to the premises. Check your state and local requirements.
- A double pole, double throw transfer switch in conjunction with the properly rated double throw circuit breaker is connected between the generator power and the utility meter.

The POWER-ARC 5500 does not have a combined 120/240 volt twist-lock receptacle and cannot be connected to a premises as described in other Lincoln literature.

Remember that the POWER-ARC 5500 is intended only for backup, intermittent use power. Oil level must be checked after every 5 hours of use. It cannot withstand long-term use without proper maintenance. See the **MAINTENANCE** section of this manual and the engine owner's manual for more information.

Certain electrical devices cannot be powered by the POWER-ARC 5500. Refer to Table A.2 for these devices.

CIRCUIT BREAKERS



Auxiliary power is protected by circuit breaker. When the machine is operated in high temperature environments, the breakers may tend to trip at lower loads than normally.



CAUTION

Never bypass the circuit breakers. Without overload protection, the POWER-ARC 5500 could overheat and/or cause damage to the equipment being used.

**CAUTION**

Certain Electrical devices cannot be powered by the POWER-ARC 5500. See Table A.2.

TABLE A.2
ELECTRICAL DEVICE USE WITH THE POWER-ARC 5500.

Type	Common Electrical Devices	Possible Concerns
Resistive	Heaters, toasters, incandescent light bulbs, electric range, hot pan, skillet, coffee maker.	NONE
Capacitive	TV sets, radios, microwaves, appliances with electrical control.	Voltage spikes or high voltage regulation can cause the capacitive elements to fail. Surge protection, transient protection, and additional loading is recommended for 100% fail-safe operation. DO NOT RUN THESE DEVICES WITHOUT ADDITIONAL RESISTIVE TYPE LOADS.
Inductive	Single-phase induction motors, drills, well pumps, grinders, small refrigerators, weed and hedge trimmers	These devices require large current inrush for starting. (See Table B.3, GENERATOR POWER APPLICATIONS, in the OPERATION section of this manual for required starting wattages.) Some synchronous motors may be frequency sensitive to attain maximum output torque, but they SHOULD BE SAFE from any frequency induced failures.
Capacitive/Inductive	Computers, high resolution TV sets, complicated electrical equipment.	An inductive type line conditioner along with transient and surge protection is required, and liabilities still exist. DO NOT USE THESE DEVICES WITH A POWER-ARC 5500.

The Lincoln Electric Company is not responsible for any damage to electrical components improperly connected to the POWER-ARC 5500.

POWER-ARC 5500



SAFETY INSTRUCTIONS

Read and understand this entire section before operating your POWER-ARC 5500.



WARNING

Do not attempt to use this equipment until you have thoroughly read all the operation and maintenance manuals supplied with your machine. They include important safety precautions; detailed engine starting, operating, and maintenance instructions; and parts lists.



ELECTRIC SHOCK can kill.

- Do not touch electrically live parts or electrodes with your skin or wet clothing.
- Insulate yourself from the work and ground.
- Always wear dry insulating gloves.



FUMES AND GASES can be dangerous.

- Keep your head out of fumes.
- Use ventilation or exhaust to remove fumes from breathing zone.



WELDING SPARKS can cause fire or explosion.

- Keep flammable material away.
- Do not weld on containers that have held combustibles.



ARC RAYS can burn.

- Wear eye, ear, and body protection.



ENGINE EXHAUST can kill.

- Use in open, well ventilated areas or vent exhaust to the outside.
- Do not stack anything on or near the engine.



MOVING PARTS can injure.

- Do not operate this equipment with any of its doors open or guards off.
- Stop the engine before servicing it.
- Keep away from moving parts.

Only qualified personnel should install, use, or service this equipment.

GENERAL DESCRIPTION

The POWER-ARC 5500 is a generator/welder designed for home use and other non-commercial applications. As a generator it can supply up to 4,000 continuous watts (or 5,500 surge watts) of 120/240 volt, single-phase AC power. As a welder it provides 125 amps of AC constant current for welding with AC stick electrodes. A single dial provides continuous adjustment of welding output. The machine is lightweight, portable, and can be lifted by two people.

The Lincoln warranty covers the Power-Arc 5500 (excluding the engine) for 3 years from the date of purchase. The engine is covered by the engine manufacturer's warranty policy.

RECOMMENDED APPLICATIONS

GENERATOR

The POWER-ARC 5500 gives AC generator output for medium use, non-commercial demands. For more details on operating the generator, see GENERATOR OPERATION in the OPERATION section of this manual.

WELDER

The POWER-ARC 5500 provides excellent constant current AC welding output for stick (SMAW) welding. For more details on using the machine as a welder, see WELDING OPERATION in the OPERATION section of this manual.

OPERATIONAL FEATURES AND CONTROLS

The POWER-ARC 5500 was designed for simplicity. Therefore, it has very few operating controls. A single dial on the control panel lets you select either generator or welding use. For welding, the same dial selects continuous current output over the machine's 70 to 125 amp range.

The gasoline engine controls include a recoil starter, choke, and rotary stop switch. See ENGINE OPERATION in the OPERATION section of this manual and the engine owner's manual for details about starting, running, stopping, and breaking in the gasoline engine.

WELDING CAPABILITY

The POWER-ARC 5500 is rated 125 amps, 20 volts at 30% duty cycle on a ten-minute basis. This means that you can load the welder to 125 amps for three minutes out of every ten-minute period. The machine is also capable of higher duty cycles at lower output currents. You can load the welder to 100 amps for six minutes out of ten for a 60% duty cycle.

The current is continuously variable from 70 to 125 amps AC. The POWER-ARC 5500 can weld with all 3/32 and most 1/8 inch diameter Lincoln AC electrodes.

POWER-ARC 5500



OUTPUT PANEL CONTROLS

Physical Location of Components may vary by Code No.

FIGURE B.1 (For Codes 11182, 11187, 11215)

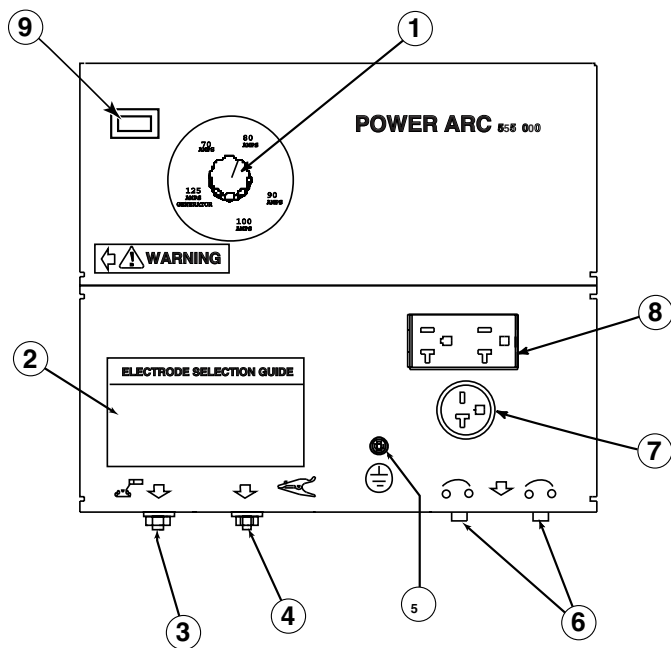

1. CURRENT CONTROL DIAL
2. ELECTRODE SELECTION GUIDE
3. WELD OUTPUT TERMINAL (TO ELECTRODE HOLDER) WITH 1/2 - 13 FLANGE NUT
4. WELD OUTPUT TERMINAL (TO WORK) WITH 1/2 - 13 FLANGE NUT
5. GROUND STUD
6. 20 AMP CIRCUIT BREAKERS (2)
7. 20 AMP, 240 VOLT RECEPTACLE
8. 20 AMP, 120 VOLT DUPLEX RECEPTACLE
9. TACHOMETER / HOURMETER (CODE 11215 ONLY)

LIMITATIONS

- The POWER-ARC 5500 is not recommended for any processes besides those that are normally performed using stick welding (SMAW) procedures.
- The POWER-ARC 5500 is not recommended for pipe thawing.
- During welding, generator power is limited to 100 watts, and output voltages can drop from 120 to 80 volts and 240 to 160 volts. Therefore, DO NOT OPERATE ANY SENSITIVE ELECTRICAL EQUIPMENT WHILE YOU ARE WELDING.

CONTROLS AND SETTINGS

All generator/welder controls are located on the Output Control Panel. Gasoline engine controls are mounted on the engine. See Figures B.1 and B.2 and the explanations that follow.

FIGURE B.2 (For Codes 11403, 11404)

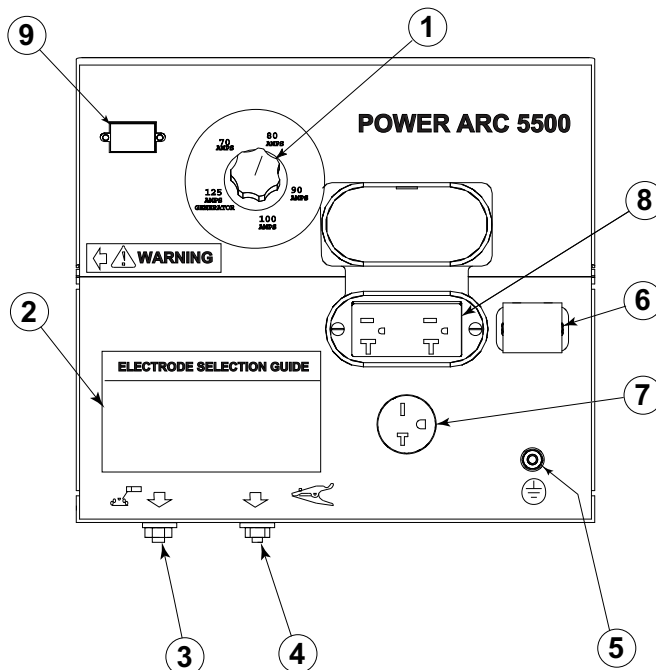

1. CURRENT CONTROL DIAL
2. ELECTRODE SELECTION GUIDE
3. WELD OUTPUT TERMINAL (TO ELECTRODE HOLDER) WITH 1/2 - 13 FLANGE NUT
4. WELD OUTPUT TERMINAL (TO WORK) WITH 1/2 - 13 FLANGE NUT
5. GROUND STUD
6. 20 AMP CIRCUIT BREAKER
7. 20 AMP, 240 VOLT RECEPTACLE
8. 20 AMP, 120 VOLT DUPLEX RECEPTACLE
9. TACHOMETER / HOURMETER (CODE 11404 ONLY)

GENERATOR/WELDER CONTROLS

See Figure B.1 for the location of the following features:

1. **CURRENT CONTROL DIAL:** Adjusts continuous current output. The amperages on the dial correspond to the average amperages needed for specific Lincoln welding electrodes.
2. **ELECTRODE SELECTION GUIDE:** Provides recommended electrode type, size, and welder output setting based on the thickness of the work.
3. **WELD OUTPUT TERMINAL (TO ELECTRODE HOLDER) WITH 1/2 - 13 FLANGE NUT:** Provides the connection point for either the electrode holder or the work cable. (Because the POWER-ARC 5500 is an AC output machine, either output terminal can be used for either cable.)

POWER-ARC 5500



4. **WELD OUTPUT TERMINAL (TO WORK) WITH 1/2 - 13 FLANGE NUT:** Provides the connection point for either the electrode holder or the work cable. (Because the POWER-ARC 5500 is an AC output machine, either output terminal can be used for either cable.)
5. **GROUND STUD:** Provides a connection point for connecting the machine case to earth ground for the safest grounding procedure.
6.
 - **20 AMP CIRCUIT BREAKERS (2):** Provide separate overload current protection for the 120 volt and 240 volt receptacles. (For codes 11182, 11187, 11215)
 - **20 AMP CIRCUIT BREAKER:** Provide separate overload current protection for the 120 volt and 240 volt receptacles. (For codes 11403, 11404)
7. **20 AMP, 240 VOLT RECEPTACLE:** Connection point for supplying 240 volt power to operate one electrical device.
8. **20 AMP, 120 VOLT DUPLEX RECEPTACLE:** Connection point for supplying 120 volt power to operate one or two electrical devices.
9. **Tachometer / Hourmeter:** (For Code 11215, 11404 Only)

Records engine speed in RPMs, engine running time, and alerts the user to perform a specific engine maintenance task by flashing corresponding messages. If the message reads "Chg Oil", the user needs to change the oil in the engine. If the message reads "SVC AIR-FILTER", the user needs to clean or if necessary, change the air filter. (See Honda Engine's owners manual for more information). After maintenance task is performed, the user is required to use the supplied Reset Tool to cancel flashing message and resume normal meter operation. (See page D-1 for further details).

GASOLINE ENGINE CONTROLS

Refer to your engine manual for the location of the following features:

1. **FUEL SHUTOFF VALVE:** Stops the flow of gasoline from the fuel tank to the carburetor. Should be closed whenever you are finished using the POWER-ARC 5500. Must be opened before you start the engine.
2. **FUEL TANK AND CAP:** See TECHNICAL SPECIFICATIONS for capacity.

NOTE: If you use any other alternate fuel tank or supply, be sure to use a recommended in-line fuel filter.

3. **MUFFLER:** Reduces engine noise output. Both the Robin / Subaru and the Honda muffler serves as a spark arrester.

See **SPARK ARRESTER** in the **INSTALLATION** section of this manual.

4. **"ON/OFF Switch:** A two position switch located on the rear of the engine. In the "ON"(I) position, the engine ignition circuit is energized and the engine can be started by pulling the recoil rope starter. In the "OFF"(O) position, the electronic ignition is grounded and the engine shuts down.
5. **AIR CLEANER:** Filters intake air to the carburetor. See **ENGINE MAINTENANCE** in the **MAINTENANCE** section of the engine owner's manual for details about the specific type of air cleaner to use.
6. **CHOKE:** Provides a richer air/fuel mixture for cold engine starting conditions. See the topic **ENGINE OPERATION**, below, for details on setting the choke.
7. **RECOIL STARTER:** Manual, rope-type starter. The handle position allows easy starting from either ground level or pickup-truck level
8. **OIL DRAIN PLUG:** Permits convenient draining of engine oil during maintenance. Both sides of the engine are equipped with an oil drain plug.
9. **OIL FILL PLUG:** Permits convenient filling of engine oil during maintenance. Both sides of the engine are equipped with an oil fill plug.



ENGINE OPERATION



WARNING

DO NOT RUN THE ENGINE AT EXCESSIVE SPEEDS. The maximum allowable high idle speed for the POWER-ARC 5500 is 3750 RPM, no load. **Do NOT adjust the governor screw on the engine. Severe personal injury and damage to the machine can result if it is operated at speeds above the maximum rated speed.**

Read and understand all safety instructions included in the engine manufacturer's **Operating and Maintenance Instructions** manual that is shipped with the POWER-ARC 5500.

POWER-ARC 5500



BEFORE STARTING THE ENGINE

CHECK AND FILL THE ENGINE OIL LEVEL:

1. Place the machine on a level surface.
2. Open the oil fill plug.
3. Fill (if necessary) until oil flows out the top of the fill plug hole.
4. Replace the fill plug and tighten securely.

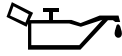

CHECK AND FILL THE ENGINE FUEL TANK:

1. Remove the fuel tank cap.
2. Fill the tank to allow approximately 1/4 inch (5 mm) of tank space for fuel expansion. **DO NOT FILL THE TANK TO THE POINT OF OVERFLOW.**
3. Replace the fuel tank cap and tighten securely.



NOTE: The engine will operate satisfactorily on any gasoline meant for automotive use. A minimum of 87 octane is recommended. **DO NOT MIX OIL WITH THE GASOLINE.**

Use clean, fresh, lead-free gasoline. Leaded gasoline may be used if lead-free is not available. However, lead-free gasoline leaves fewer combustion deposits and gives longer valve life. Purchase gasoline in quantities that will be used within 30 days, to assure freshness.

NOTE: We **DO NOT** recommend using gasoline that contains alcohol, such as gasohol. However, if gasoline with alcohol is used, it **MUST NOT** contain more than 10% Ethanol and **MUST** be removed from the engine during storage. **DO NOT** use gasoline containing Methanol.

STARTING THE ENGINE

NOTE: Remove all loads connected to the AC power receptacles before starting the gasoline engine. Put the "ON/OFF" Switch in the "ON"(I) position.

FOR A "COLD" ENGINE:

1. Open the fuel shutoff valve.
2. Place the choke lever in the "CHOKE" position.
3. Pull slightly on the recoil starter handle until resistance is felt.

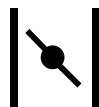

4. Pull the cord rapidly.
5. If the engine does not start, open the choke slightly and pull the starter cord rapidly again.

When the engine starts, gradually open the choke to the "RUN" position. To open the choke fully requires an engine warm-up period of several seconds to several minutes, depending on the temperature. After starting the engine, first open the choke (toward RUN) until the engine just begins to run smoothly. Then open the choke in small steps, allowing the engine to accept small changes in speed and load, until the choke is fully open (in RUN). During engine warm-up the equipment can be operated.

FOR A "HOT" ENGINE:

1. Open the fuel shutoff valve.
2. Place the choke lever in the "RUN" position. Closing the choke of a hot engine will flood the carburetor and prevent starting.
3. Pull slightly on the recoil starter handle until resistance is felt.
4. Pull the cord rapidly.

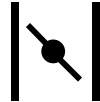

FOR BEST ENGINE STARTING:

- Always use fresh gasoline and be sure the filter is clean and properly maintained.
- If you use an alternate fuel tank or supply, be sure to install an in-line fuel filter.
- Do not pull the recoil starter with the choke in the "CHOKE" position more than one time. Repeated pulls on a choked engine will flood the carburetor.
- If the engine will not start, see the **TROUBLESHOOTING** section of this or the engine owner's manual.



STOPPING THE ENGINE

1. Remove all welding and generator power loads and let the engine cool by running it for several minutes.
2. Stop the engine by placing the "ON/OFF" switch in the "OFF"(O) position.
3. Close the fuel shutoff valve.



WARNING

Close the fuel valve when the machine is transported to prevent fuel leakage from the carburetor. Drain the tank before transporting the machine in a vehicle.

For long periods of storage, turn off the fuel shut-off valve and let the engine run until there is no more fuel in the line. Use a fuel additive such as Sta-Bil to minimize fuel gum deposits.

RUNNING THE ENGINE

The engine is set at the factory to run at high idle speed when not under load. You should not adjust this setting yourself.

BREAK-IN PERIOD

The engine will use a greater amount of oil during its "break-in" period. Check the oil frequently during break-in. For more details, see the MAINTENANCE section in the engine owner's manual.



CAUTION

During break-in, subject the POWER-ARC 5500 to only moderate loads. Avoid long periods running at idle. Before stopping the engine, remove all loads and allow the engine to cool several minutes.

GENERATOR OPERATION



CAUTION

Be sure that any electrical equipment plugged into the generator's AC power receptacles can withstand a $\pm 10\%$ voltage and a $\pm 4\%$ frequency variation. Some electronic devices cannot be powered by the POWER-ARC 5500. Refer to Table A.2, ELECTRICAL DEVICE USE WITH THE POWER-ARC 5500, in the INSTALLATION section of this manual.

GENERAL INFORMATION

The POWER-ARC 5500 generator is rated at 4000 continuous watts (5500 surge watts). It provides both 120 volt and 240 volt power. You can draw up to 20 amps from either side of the 120 volt duplex receptacle, but no more than 33.3 amps from both sides at once. Up to 16.7 amps can be drawn from the single 240 volt receptacle.

Electrical loads in watts are calculated by multiplying the voltage rating of the load by the number of amps it draws. (This information is given on the load device nameplate.) For example, a device rated 120 volts, 2 amps will need 240 watts of power ($120 \times 2 = 240$).

You can use Table B.3, GENERATOR POWER APPLICATIONS, to determine the wattage requirements of the most common types of loads you can power with the POWER-ARC 5500. Be sure to read the notes at the bottom of the table.

TO USE THE POWER - ARC 5500 AS AN AUXILIARY POWER SUPPLY:

1. Start the gasoline engine. See ENGINE OPERATION in this section of the manual and the engine owner's manual.
2. Set the current control dial on the output control panel to "GENERATOR." See Figure B.1.
3. Plug the load(s) into the appropriate 120 volt or 240 volt power receptacle.

NOTE: During welding, the maximum generator output for auxiliary loads is 100 watts.

NOTE: You can supply multiple loads as long as the total load does not exceed 5,500 surge watts or 4,000 Continuous watts. Be sure to start the largest loads first.

POWER-ARC 5500



TABLE B.3
GENERATOR POWER APPLICATIONS

Suggested Power Applications	Running Watts (Continuous)	*Start-up Watts (Surge)
*Air Compressor - 1 HP	2,000	4,000 - 8,000
*Air Compressor - 3/4 HP	1,250	3,100 - 5,000
*Airless Sprayer - 1/3 HP	600	1,500 - 2,400
Chain Saw	1,200	
Circular Saw	1,200	
Coffee Maker	1,000	
*Deep Freezer	500	750 - 2,000
*Electric Motor - 1 HP	1,000	2,500 - 4,000
Electric Range (1 element)	1,500	
Electric Skillet	1,250	
*Furnace Fan - 1/3 HP	1,200	3,000 - 4,800
Portable Grinder (4 1/2")	600	
Portable Grinder (7")	2,000	
Halogen Work Light	500	
Hand Drill - 1/4"	500	
Hand Drill - 3/8"	700	
1500 Watt Heater	1,750	
Hedge Trimmer	450	
Light Bulb	100	
Reciprocating Saw	900	
Radial Arm Saw	2,600	
Radio	50	
*Refrigerator/Freezer (small)	600	1,500 - 2,400
Slow Cooker	200	
*Submersible Pump - 1 HP	1,000	2,500 - 4,000
*Sump Pump	600	1,500 - 2,400
Toaster	1,100	
Weed Trimmer	500	
Lincoln Wire Feeder/Welder	4,000	

NOTES:

Wattages listed are approximate. Check your equipment for actual wattage.

Equipment with unusually high *START-UP WATTS are listed. For start-up of other tabled equipment that uses a motor, allow up to 2 times the running watts shown above. For example a 1 HP motor requires approximately 1000 watts of power when running but may require $(2.5 \times 1000) = 2500$ watts or $(4.0 \times 1000) = 4000$ watts to start.

Multiple loads can be used as long as the total load does not exceed 5,500 surge watts or 4,000 continuous watts. Be certain to start the largest loads first.

Output rating in watts is equivalent to volt-amperes at unity power factor (resistive load) and is calculated as: $WATTS = VOLTS \times AMPS$ DRAWN. for example a 120 volt device which is rated on its nameplate to draw 2 amps will need $(120 \text{ VOLTS}) \times (2 \text{ AMPS}) = 240 \text{ WATTS OF POWER}$. 1 KW = 1000 WATTS.

POWER-ARC 5500



WELDING OPERATION

GENERAL INFORMATION



WARNING



ELECTRIC SHOCK can kill.

- Do not touch electrically live parts or electrodes with your skin or wet clothing.

- Insulate yourself from the work and ground.
- Always wear dry insulating gloves.

The POWER-ARC 5500 has a voltage of up to 62 Volts AC which can shock. The POWER-ARC 5500 generator/welder can deliver from 70 to 125 amps of continuous welding output current. Output can be adjusted by setting the current control dial on the output control panel.

You can get maximum welding output by setting the dial to 125 AMPS. At high current settings like this, some output may decrease as the machine is used. If you are welding for a long time, you may need to turn the dial slightly upward to maintain the same results.

The numbers on the dial correspond to the average amps needed to weld using specific Lincoln welding rods. Table B.4, WELDING APPLICATIONS, gives you the recommended dial settings based on the thickness of the work and the size and type of rod you're using.

TO USE THE POWER-ARC 5500 FOR WELDING:

1. Remove the flange nuts from the weld output terminals and place the work and electrode welding cables over the terminals. (See Figure B.1) Replace and tighten the flange nuts securely. Be sure the connections are tight.
2. Select the appropriate electrode. (See Table B.4) WELDING APPLICATIONS, or the ELECTRODE SELECTION GUIDE on the machine Output Control Panel.
3. Attach the work clamp securely to the work you are welding.
4. Insert the electrode into the electrode holder.
5. Set the current control dial to the desired output current.
6. Start the gasoline engine. See **ENGINE OPERATION** in this section of the manual.
7. Strike an arc and begin welding. For information on welding techniques, see **WELDING GUIDELINES** in this section of the manual.

AFTER YOU FINISH THE WELD:

1. Stop the gasoline engine. See **ENGINE OPERATION** in this section of the manual.
2. Allow the electrode and work to cool completely.
3. Remove the work clamp from the work.
4. Remove any remaining piece of electrode from the electrode holder.
5. If you are finished using the POWER-ARC 5500 for welding, disconnect the welding cables from the weld output terminals. Reattach the flange nuts and leave them on the terminals.

- NOTE:**
1. Welding current is continuously variable with 60% duty cycle applying to output currents 100 Amps and less and 30% duty cycle applying to currents above 100 Amps.
 2. Duty cycle is based on a ten minute period. The welder can be loaded to 125 Amps for three minutes out of every ten minute period or to 100 Amps for six minutes out of every ten minute period.

CONTROL FUNCTION / OPERATION

“Current Control Dial”

Provides welding current adjustment from 70 through 125 Amps.

To obtain maximum weld output, turn the “Current Control Dial” to “**125 Amps**” for either a cold or hot engine. As the machine is used, some welding voltage may decrease at high current settings. If you are welding for long periods of time, the dial may need to be slightly turned upward to provide the same welding results as when the machine was cold.

The numbers listed on the dial correspond to the average amperage needed to weld specific Lincoln rods. Refer to Table B.4 “Welding Application Guidet” and “Electrode Selection Guide” listed on the machine nameplate for proper current and electrode settings.

POWER-ARC 5500



WELDING GUIDELINES

TABLE B.4
WELDING APPLICATIONS/ELECTRODE SELECTION GUIDE

Material Thickness	Electrode Type	Size	Setting
1/8" and thinner	FLEETWELD® 37	3/32"	90 amps
	¹ AWS E6013		70 amps
	FLEETWELD® 180		90 amps
	AWS E6011 Lincoln 7018 AC AWS E7018		
3/16" Maximum	FLEETWELD® 37 AWS E6013	1/8"	125 amps
5/16" Maximum	FLEETWELD® 180 AWS E6011	1/8"	90 amps
Any Thickness	WEARSHIELD® ABR	1/8"	100 amps

NOTES:

The values listed are suggested settings. Actual setting may vary depending on individual preference and/or specific application. Beginners should use Lincoln E7018 AC.

For electrodes not listed, follow tables that are packed with the electrodes.

Ask for the Lincoln WELD DIRECTORY (Publication C2.10) for a complete listing of all Lincoln stick electrodes available.

¹AWS = American Welding Society



WARNING

ARC RAYS can burn.



• **When using an open arc process, it is necessary to use correct eye, head and body protection.**

Semi-automatic, Wire Welding With a Lincoln Wire Feeder / Welder

The Power-Arc 5500 generator power can be used to supply power up to 4,000 watts continuous input power to a Lincoln Wire Feeder/Welder. The Wire Feeder/Welder is equipped with all the supplies needed for Flux-Cored Arc Welding (FCAW). Also some Wire Feeder/Welders come equipped with the essentials needed for Gas Metal Arc Welding, GMAW, or MIG processes, while others require the purchase of a conversion kit. These products are available where Lincoln products are sold. Contact your local authorized Lincoln representative for more details.

Stick Welding

Stick welding is probably the most familiar welding process known. A coated ELECTRODE, the weld rod, is clamped into an ELECTRODE HOLDER, an insulated clamping device, which in turn connects to the ELECTRODE CABLE, a heavy wire. The WORK, the metal piece to be welded, is connected to the WORK CABLE, a heavy wire which contains the WORK CLAMP. Quality Lincoln cables use many fine copper wires with a very flexible insulating covering for the electrode and work cables. When properly connected to the OUTPUT STUDS of a high current power source, the electrode melts and bonds the metal being repaired. See "Cable Installation" section for proper cable connection to a Power-Arc.

The Power-Arc provides excellent weld output characteristics when used in combination with Lincoln AC electrodes. Other AC electrodes may also be used.

Follow the settings listed in Table B.4 "Welding Application Guide" and the "Electrode Selection Guide" found on the nameplate of the machine.

Learning To Stick Weld

The serviceability of a product or structure utilizing this type of information is and must be the sole responsibility of the builder/user. Many variables beyond the control of The Lincoln Electric Company affect the results obtained in applying this type of information. These variables include, but are not limited to, welding procedure, plate chemistry and temperature, weldment design, fabrication methods and service requirements.

POWER-ARC 5500



No one can learn to weld simply by reading about it. Skill comes only with practice. The following pages will help the inexperienced welder understand welding and develop his skill. For more detailed information, order a copy of the book "New Lessons in Arc Welding." (See Book Division section at rear of manual).

The operator's knowledge of arc welding must go beyond the arc itself. He must know how to control the arc, and this requires a knowledge of the welding circuit and the equipment that provides the electric current used in the arc. Figure 3 is a diagram of the welding circuit. The circuit begins where the electrode cable is attached to the welding machine and ends where the work cable is attached to the machine. Current flows through the electrode cable to the electrode holder, through the electrode holder to the electrode and across the arc. On the work side of the arc, the current flows through base metal to the work cable and back to the welding machine. The circuit must be complete for the current to flow. To weld, the work clamp must be tightly connected to clean base metal. Remove paint, rust, etc. as necessary to get a good connection. Connect the work clamp as close as possible to the area you wish to weld. Avoid allowing the welding circuit to pass through hinges, bearings, electronic components or similar devices that can be damaged.

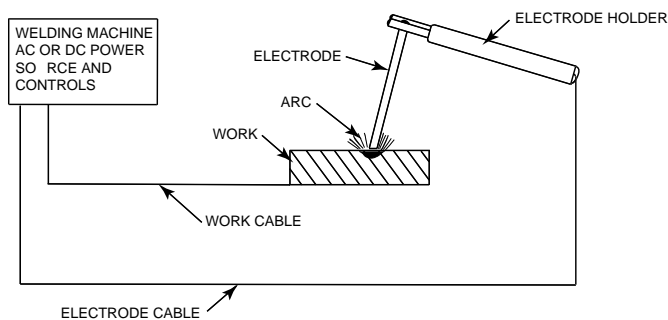

FIG RE 3 - The welding circuit for (Stick) shielded metal arc welding.

The electric arc is made between the work and the tip end of a small metal wire, the electrode, which is clamped in a holder that is held by the welder. A gap is made in the welding circuit (see Figure 3) by holding the tip of the electrode 1/16 - 1/8" (1.6-3.2mm) away from the work or base metal being welded. The electric arc is established in this gap and is held and moved along the joint to be welded, melting the metal as it is moved.

Arc welding is a manual skill requiring a steady hand, good physical condition, and good eyesight. The operator controls the welding arc and, therefore, the quality of the weld made.

What Happens in the Arc?

Figure 4 illustrates the action that takes place in the electric arc. It closely resembles what is actually seen during welding.

The "arc stream" is seen in the middle of the picture. This is the electric arc created by the electric current flowing through the space between the end of the electrode and the work. The temperature of this arc is about 6000°F (3300°C) which is more than enough to melt metal. The arc is very bright, as well as hot, and cannot be looked at with the naked eye without risking painful and possibly permanent injury. A very dark lens, specifically designed for arc welding must be used with the handshield or headshield whenever viewing the arc.

The arc melts the base metal and actually digs into it, much like water through a garden hose nozzle digs into the earth. The molten metal forms a pool or crater and tends to flow away from the arc. As it moves away from the arc, it cools and solidifies. Slag forms on top of the weld to protect it during cooling.

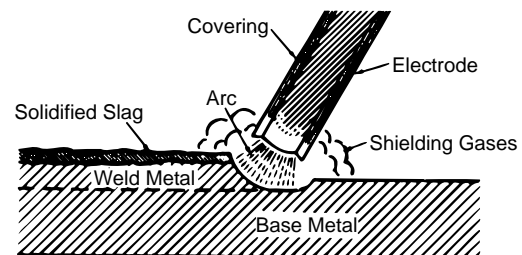

FIGURE 4 - The welding arc.

The function of the covered electrode is much more than simply to carry current to the arc. The electrode is composed of a core metal wire around which has been extruded and baked a chemical covering. The core wire melts into the arc and tiny droplets of molten metal shoot across the arc into the molten pool. The electrode provides additional filler metal for the joint to fill the groove or gap between the two pieces of the base metal. The covering also melts or burns in the arc. It has several functions. It makes the arc steadier, provides a shield of smoke-like gas around the arc to keep oxygen and nitrogen in the air away from the molten metal, and provides a flux for the molten pool. The flux picks up impurities and forms a protective slag. The principle differences between the various types of electrodes are in their coatings. By varying the coating, it is possible to greatly alter the operating characteristics of electrodes. By understanding the differences in the various coatings, you will gain a better understanding of selecting the best electrode for the job you have at hand. In selecting an electrode, you should consider:

1. The type of deposit you want, e.g., mild steel, stainless, low alloy, hardfacing.
2. The thickness of the plate you want to weld.
3. The position it must be welded in (downhand, out-of-position).
4. The surface condition of the metal to be welded.
5. Your ability to handle and obtain the desired electrode.

Four simple manipulations are of prime importance. **Without** complete mastery of these four, further attempts at welding are futile. **With** complete mastery of the four, welding will be easy.

1. The Correct Welding Position

Illustrated is the correct welding position for right-handed people. (For left-handed people it is opposite.)

Whenever possible, weld from left to right (if right-handed). This enables you to see clearly what you are doing.

Hold the electrode at a slight angle as shown in Figure 5.

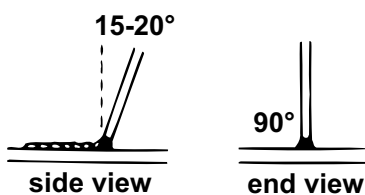

Correct Welding Position

Figure 5

2. The Correct Way to Strike An Arc

Be sure the work clamp makes good electrical contact to the work.

Lower your headshield and scratch the electrode slowly over the metal, and you will see sparks fly. While scratching, lift the electrode 1/8" (3.2mm) and the arc is established.

NOTE: If you stop moving the electrode while scratching, the electrode will stick. Most beginners try to strike the arc by a fast jabbing motion down on the plate. Result: They either stick their electrode or their motion is so fast that they break the arc immediately.

3. The Correct Arc Length

The arc length is the distance from the tip of the electrode core wire to the base metal.

Once the arc has been established, maintaining the correct arc length becomes extremely important. The arc should be short, approximately 1/16 to 1/8" (1.6-3.2mm) long. As the electrode burns off, the electrode must be fed to the work to maintain correct arc length.

The easiest way to tell whether the arc has the correct length is by listening to its sound. A nice, short arc has a distinctive, "crackling" sound, very much like eggs frying in a pan. The incorrect, long arc has a hollow, blowing or hissing sound.

4. The Correct Welding Speed

The important thing to watch while welding is the puddle of molten metal right behind the arc. **DO NOT WATCH THE ARC ITSELF.** The appearance of the puddle and the ridge where the molten puddle solidifies indicates correct welding speed. The ridge should be approximately 3/8" (9.5mm) behind the electrode.

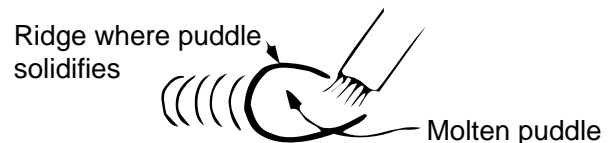

Most beginners tend to weld too fast, resulting in a thin, uneven, "wormy" looking bead. They are not watching the molten metal.

IMPORTANT: It is not generally necessary to weave the arc forward, backward or sideways. Weld along at a steady pace, and you will have an easier time.

NOTE: When welding on thin plate, you will find that you have to increase the welding speed, whereas when welding on heavy plate, it is necessary to go more slowly to ensure fusion and penetration.

PRACTICE

The best way of getting practice in the four skills that enable you to maintain:

1. Correct Welding Position.
2. Correct Way to Strike An Arc.
3. Correct Arc Length.
4. Correct Welding Speed.

is to spend a little more time on the following exercise.

Use the following:

Mild Steel Plate:	3/16" (4.8mm), or heavier.
Electrode:	1/8" (3.2mm) AWS 6011 (Fleetweld® 180)
Current Setting:	90-125 Amps AC

Do the following:

1. Learn to strike the arc by scratching the electrode over the plate. Be sure the angle of the electrode is right and be sure to use both hands.
2. When you can strike an arc without sticking, practice the correct arc length. Learn to distinguish it by its sound.
3. When you are sure that you can hold a short, crackling arc, start moving. Look at the molten puddle constantly, and look for the ridge where the metal solidifies.
4. Run beads on a flat plate. Run them parallel to the top edge (the edge farthest away from you). This gives you practice in running straight welds, and also, it gives you an easy way to check your progress. The 10th weld will look considerably better than the first weld. By constantly checking on your mistakes and your progress, welding will soon be a routine matter.

Common Metals

Most metals found around the farm or small shop are low carbon steel, sometimes referred to as mild steel. Typical items made with this type of steel include most sheet metal, plate, pipe and rolled shapes such as channels, angle irons and "I" beams. This type of steel can usually be easily welded without special precautions. Some steel, however, contains higher carbon. Typical applications include wear plates, axles, connecting rods, shafts, plowshares and scraper blades.

These higher carbon steels can be welded successfully in most cases; however, care must be taken to follow proper procedures, including preheating the metal to be welded and, in some cases, carefully controlling the temperature during and after the welding process. For further information on identifying various types of steel and other metals, and for proper procedures for welding them, we suggest you purchase a copy of "New Lessons in Arc Welding" (See Book Division section).

Regardless of the type of metal being welded, in order to get a quality weld, it is important that it be free of oil, paint, rust or other contaminants.

Types of Welds

Five types of welding joints are: Butt Joints, Fillet Joints, Lap Joints, Edge Joints and Corner Joints.

Of these, the Butt Joint and Fillet Joint are the most common.

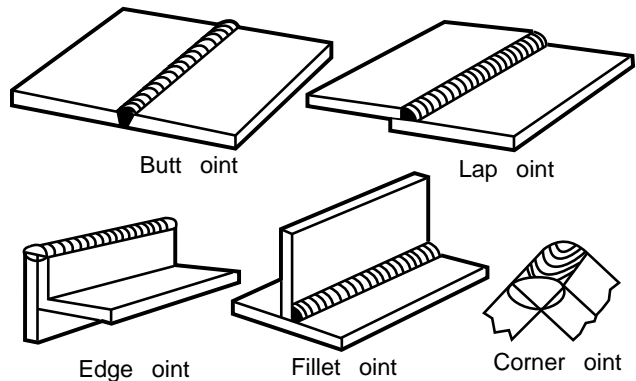

Butt Joints

Butt Joints are the most widely used Joints. Place two plates side by side, leaving 1/16" (1.6mm) for thin metal to 1/8" (3.2mm) for heavy metal space between them in order to get deep penetration.

Tack the plates at both ends, otherwise the heat will cause the plates to move apart. (See drawing).

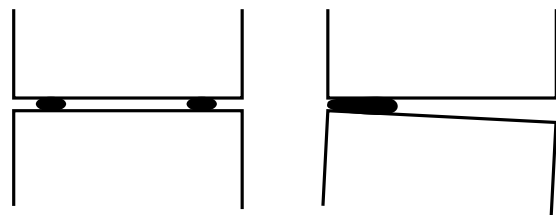

Now weld the two plates together. Weld from left to right (if right-handed). Point the electrode down in the gap between the two plates, keeping the electrodes slightly tilted in the direction of travel.

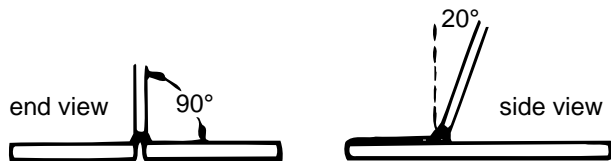

Watch the molten metal to be sure it distributes itself evenly on both edges and in between the plates.

Penetration

Unless a weld penetrates close to 100%, a butt joint will be weaker than the material welded together.

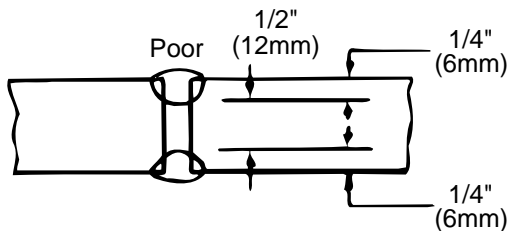

In this example, the total weld is only 1/2 the thickness of the material; thus, the weld is only approximately half as strong as the metal.

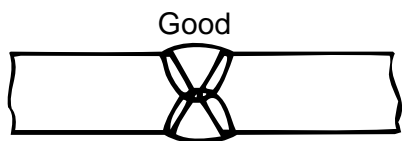

In this example, the joint has been flame beveled or ground prior to welding so that 100% penetration could be achieved. The weld, if properly made, is as strong or stronger than the original metal.

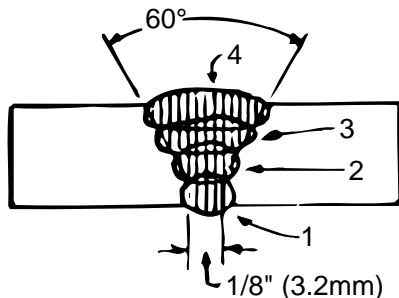

Successive passes must be used to build up butt welds on heavier metal.

Fillet Joints

When welding fillet joints, it is very important to hold the electrode at a 45° angle between the two sides, or the metal will not distribute itself evenly.

To make it easier to get the 45° angle, it is best to put the electrode in the holder at a 45° angle, as shown.

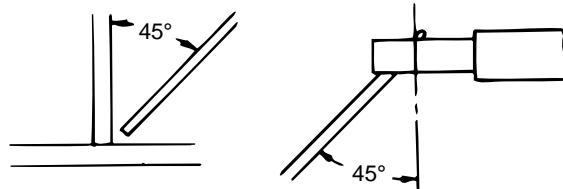

Multiple Pass Welds

Make multiple pass horizontal fillets as shown in the sketch. Put the first bead in the corner with fairly high current. Hold the electrode angle needed to deposit the filler beads as shown putting the final bead against the vertical plate.

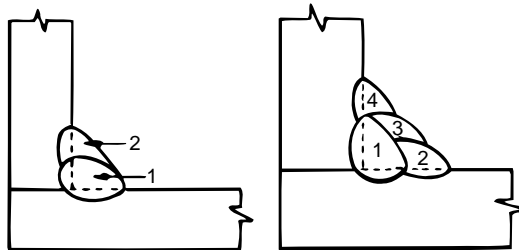

Welding in the Vertical Position

Welding in the vertical position can be done either vertical-up or vertical-down. Vertical-up is used whenever a large, strong weld is desired. Vertical-down is used primarily on sheet metal for fast, low penetrating welds.

Vertical-Up Welding

The problem, when welding vertical-up, is to put the molten metal where it is wanted and make it stay there. If too much molten metal is deposited, gravity will pull it downwards and make it "drip". Therefore, a certain technique has to be followed:

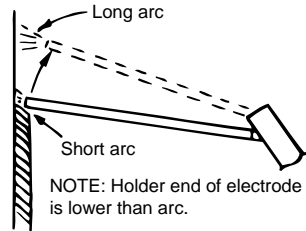

1. Use 1/8" (3.2mm) 90-115 amps or 3/32" (2.5mm) 70 amps AWS 6011.
2. When welding, the electrode should be kept horizontal or pointing slightly upwards. (See drawing above).
3. The arc is struck and metal deposited at the bottom of the two pieces to be welded together.
4. Before too much molten metal is deposited, the arc is SLOWLY moved 1/2-3/4" (12-20mm) upwards. This takes the heat away from the molten puddle, which solidifies. (If the arc is not taken away soon enough, too much metal will be deposited, and it will "drip".)
5. The upward motion of the arc is caused by a very slight wrist motion. Most definitely, the arm must not move in and out, as this makes the entire process very complicated and difficult to learn.
6. If the upward motion of the arc is done correctly with a wrist motion, the arc will automatically become a long arc that deposits little or no metal. (See drawing above.)
7. During this entire process, the ONLY thing to watch is the molten metal. As soon as it has solidified, the arc is SLOWLY brought back, and another few drops of metal are deposited. DO NOT FOLLOW THE UP AND DOWN MOVEMENT OF THE ARC WITH YOUR EYES. KEEP THEM ON THE MOLTEN METAL.

8. When the arc is brought back to the now solidified puddle, IT MUST BE SHORT, otherwise no metal will be deposited, the puddle will melt again, and it will "drip".
9. It is important to realize that the process consists of SLOW, DELIBERATE movements. There are no fast motions.

Vertical-Down Welding

Vertical-down welds are applied at a fast pace. These welds are therefore shallow and narrow, and are excellent for sheet metal. Do not use the vertical-down technique on heavy metal. The welds will not be strong enough.

1. Use 1/8" (3.2m) or 3/32" (2.5mm) AWS 6011.
2. On thin metal use 70-75 amps. (14 ga. 75 A - 16 ga. 60 A.)
3. Hold the electrode in a 30-45° angle with the tip of the electrode pointing upwards.
4. Hold a VERY SHORT arc, but do not let the electrode touch the metal.
5. An up and down whipping motion will help prevent burn-through on very thin plate.

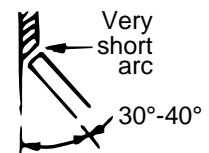

6. Watch the molten metal carefully.

The important thing is to continue lowering the entire arm as the weld is made so the angle of the electrode does not change. Move the electrode fast enough so that the slag does not catch up with the arc.

Overhead Welding

Various techniques are used for overhead welding. However, in the interest of simplicity for the inexperienced welder, the following technique will probably take care of his needs for overhead welding:

1. Use 1/8" (3.2mm) 90-105 A or 3/32" (2.5mm) 70 A AWS 6011 electrode on AC.
2. Put the electrode in the holder so it sticks straight out.
3. Hold the electrode at an angle approximately 30° off vertical, both seen from the side and seen from end. (See drawing below.)



It is important to hold a VERY SHORT arc. (A long arc will result in falling molten metal; a short arc will make the metal stay.)

If necessary, and this is dictated by the appearance of the molten puddle, a slight back and forth whipping technique may be used to prevent "dripping".

Welding Sheet Metal

Welding sheet metal presents an additional problem—burn through. Follow these simple rules:

1. Hold a very short arc. This, together with the proper travel speed, will eliminate burn through.
2. Use 1/8" (3.2mm) or 3/32" (2.5mm) AWS 6011.
3. Use low amperage. 75 A for 1/8" (3.2mm) electrode, 70 A for 3/32" (2.5mm) electrode.
4. Move rapidly enough to stay ahead of the molten slag. A whipping technique may be used to further minimize burn through.
5. If you have a choice, use lap joints rather than fillets or butts; the double thickness effect of a lap joint makes it much easier to weld without burning through.

Hardfacing (To Reduce Wear)

There are several kinds of wear. The two most often encountered are:

1. Metal to Ground Wear: Plowshares, bulldozer blades, buckets, cultivator shares, and other metal parts moving in the soil.
2. Metal to Metal Wear: Trunnions, shafts, rollers and idlers, crane and mine car wheels, etc.

Each of these types of wear demands a different kind of hardfacing electrode.

When applying the proper electrode, the service life of the part will in most cases be more than double. For instance, hardfacing of plowshares results in 3-5 times more acreage plowed.

How to Hardface the Sharp Edge (Metal to Ground Wear)

1. Grind the share, approximately one inch along the edge, so the metal is bright and clean.
2. Place the share on an incline of approximately 20-30°. The easiest way to do this is to put one end of the share on a brick. (See drawings) Most users will want to hardface the underside of the share, but some might find that the wear is on the top side. The important thing is to hardface the side that wears.
3. Use 1/8" (3.2mm) Wearshield at 80-100 A. Strike the arc about one inch from the sharp edge.

4. The bead should be put on with a weaving motion, and it should be 1/2-3/4" (12.7-19.0mm) wide. Do not let the arc blow over the edge, as that will dull the edge. (See drawing below.)

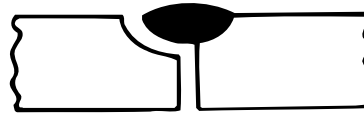
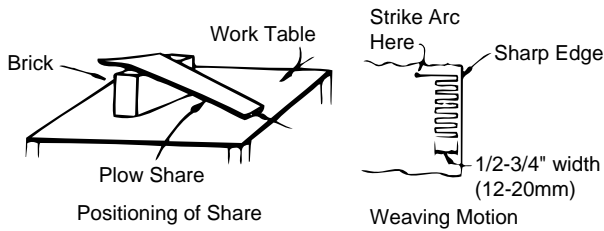

When breaking the weld stays on one piece

To overcome this, the welding operator has two choices:

5. Use the back-stepping method. Begin to weld 3" (76mm) from the heel of the share and weld to the heel. The second weld will begin 6" (152mm) from the heel, the third weld 9" (229mm) from the heel, etc.

1. Preheat the entire casting to 500-1200°F (260-649°C) If the cast iron is hot before welding, there will be no sudden chilling which creates brittle white cast iron. The entire casting will cool slowly.
2. Weld 1/2" (12.7mm) at a time, and do not weld at that spot again until the weld is cool.

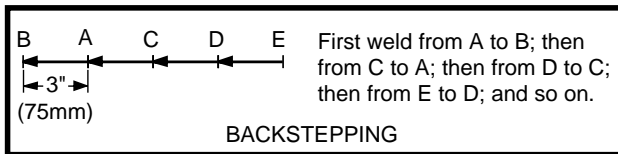

This way, no large amount of heat is put into the mass.

Most inexperienced welders will probably use the second method, because they have no way of preheating large castings. Smaller castings can easily (and should) be preheated before welding. A forge, stove, fire, or the Arc Torch are all excellent means of preheating.

Backstepping greatly reduces the chances for cracking of the share, and it also greatly reduces warping.

NOTE: The entire process is rather fast. Many beginners go much too slowly when hardfacing plowshares, running the risk of burning through the thin metal.

When using the 1/2" (12.7mm) at a time method, it is recommended to start 1/2" (12.7mm) away from the previous bead and weld into the previous bead. This is called backstepping.

Welding Cast Iron

When welding on a piece of cold cast iron, the tremendous heat from the arc will be absorbed and distributed rapidly into the cold mass. This heating and sudden cooling creates WHITE, BRITTLE cast iron in the fusion zone. (See drawing below.)

After welding Cast Iron, protect the casting against fast cooling. Put it in a container of warm, dry sand or lime.

If sand or lime is not available, cover it with sheet metal or any other non-flammable material that will diminish drafts and retain heat.

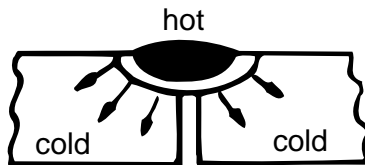

White brittle cast iron

This is the reason why welds in cast iron break. Actually, one piece of the broken cast iron has the entire weld on it and the other piece has no weld on it. (See drawing below.)

Cast Iron Plate Preparation

Wherever practical, the joint to be welded should be "veed" out by grinding or filing to give complete penetration as shown in figures (a), (b) and (c) below. This is especially important on thick castings where maximum strength is required.

In some instances a back-up strip may be used and plates may be gapped 1/8" (3.2mm) or more, as shown in figure (b).

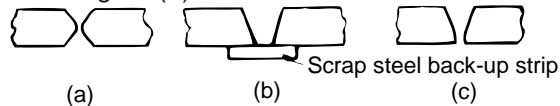

Three ways to prepare plates where complete penetration is necessary.

On sections where only a sealed joint is required and strength is not important, the joint may be welded after slightly veeing out the seam as shown in figure (d) below.

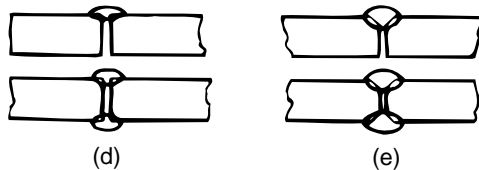

Single and double beads, with and without beveling for tight, partial strength joints.

Selecting Electrodes

Which electrode is best for the particular job . . . how do you use it? These are important questions because the cost, quality, and appearance of your work depends on proper electrode selection and application. MILD STEEL ELECTRODES may be classified into the following groups:

Out-of-Position Group (AWS E6011)

This group includes electrodes which have a snappy, deep penetrating arc and fast freezing deposits.

These electrodes are used for general purpose, all-position fabrication and repair welding. They are also the best choice for pipe welding and sheet metal butt, corner, and edge welds. They can be used for repair work when dirt, grease, plating or paint cannot be completely cleaned from the steel. These electrodes are typically used with motions "A" and "B" (see drawing) for the first pass on vertical-up welds.

High-Speed Group (AWS E6013)

This group includes electrodes which have a moderately forceful arc and deposit rates between those of the out-of-position and high-deposit electrodes.

They are primarily general purpose production electrodes especially for downhill fillets and laps or short and irregular welds that change direction or position. They are also widely used in maintenance and recommended for sheet metal fillet and lap welds. Motion "D" (see drawing) is generally used for vertical-up welding, but motions "A" and "B" are also suitable.

Low Hydrogen Group (AWS E7018)

These electrodes are generally called "low hydrogen". The name comes from the fact that their coating contains little hydrogen in either moisture or chemical form. Low hydrogen electrodes offer these benefits: outstanding crack resistance, lowest porosity on sulphur bearing steels, and X-ray quality deposit capability. Thus, they are the first choice when welding "problem" steels. E7018 can be used in all positions, with Motion "C" (below) recommended for the first pass on vertical-up welds. NEVER use a whipping technique or a long arc with these electrodes. ALWAYS fill craters by drawing electrode away slowly. ALWAYS keep these electrodes dry. Electrodes, when not used within a few hours after a container is opened, must be stored in heated cabinets.

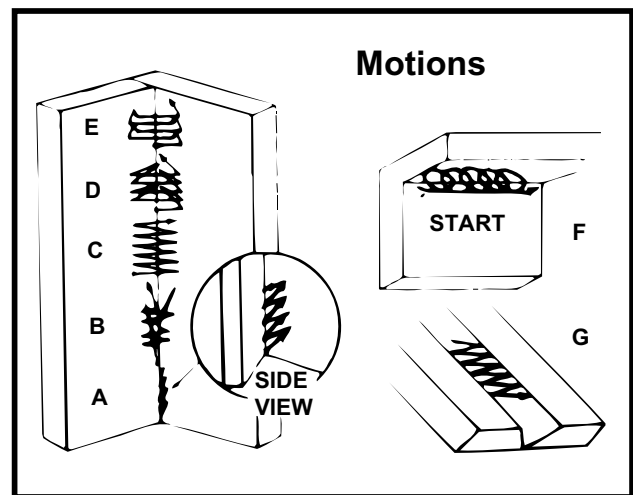

OPTIONS/ACCESSORIES

LINCOLN ELECTRIC ACCESSORIES

The following options/accessories are available for your POWER-ARC 5500 from your local Lincoln Distributor.

Accessory Kit (K875) – Includes the following:

- Twenty feet (6.1 meters) of #6 AWG electrode cable with lug.
- Fifteen feet (4.6 meters) of #6 work cable with lugs.
- Headshield with No. 10 filter
- Work clamp
- Insulated electrode holder
- Sample pack of mild steel electrodes 150 Amp capacity.

Undercarriage (K882-2) - 2- wheeled, hand moving.

Rotor Removal Kit (S20925) – A service kit with thru and impact bolts for removing the generator rotor from the tapered engine crankshaft.

SAFETY PRECAUTIONS



WARNING

- Have qualified personnel do all maintenance and troubleshooting work.
- Turn the engine off before working inside the machine.
- Remove guards only when necessary to perform maintenance and replace them when the maintenance requiring their removal is complete.
- If guards are missing from the machine, get replacements from a Lincoln Distributor. See the EXPLODED VIEW AND PARTS LIST at the back of this manual.

Read the Safety Precautions in the front of this manual and in the engine owner's manual before working on the POWER-ARC 5500.

Keep all equipment safety guards, covers, and devices in position and in good repair. Keep your hands, hair, clothing, and tools away from the recoil housing, fans, and all other moving parts when starting, operating, or repairing this machine.

ROUTINE AND PERIODIC MAINTENANCE

ENGINE MAINTENANCE



CAUTION

To prevent the engine from accidentally starting, disconnect the spark plug lead before servicing the engine.

See the engine owner's manual for a summary of maintenance intervals for the items listed below. Follow either the hourly or the calendar intervals, whichever come first. More frequent service may be required, depending on your specific application and operating conditions. Table D.1 shows engine maintenance replacement parts and numbers.

If this Power Arc 5500 is equipped with a Tachometer/Hourmeter (See page B-3), then use it flash alert feature to determine the oil change intervals, as well as times when air filter service is required.

Once Oil or Air filter service is completed, Tachometer/Hourmeter needs to be reset. The reset procedure will stop the flashing of the display and will trigger the meter to start counting the time for the next engine service. To stop the flashing alert for Oil or Air filter service, do the following: While alert message is flashing, hold the tip of the reset tool against area shown in figure D.1 for several seconds. The display will stop flashing. The service interval has been reset and the message alert should start flashing for the next Oil or Air filter change.

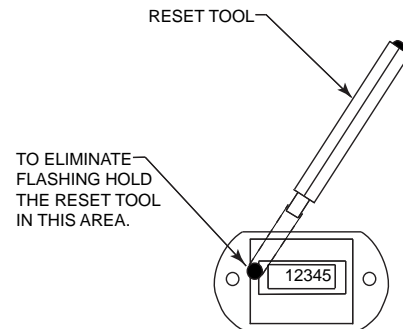

FIGURE D.1



OIL: Check the oil level after every 5 hours of operation or daily. **BE SURE TO MAINTAIN THE OIL LEVEL.**

Change the oil the first time after 20 hours of operation. Then, under normal operating conditions, change the oil after every 100 hours or once every 6 months whichever occurs first. If the engine is operated under heavy load or in high ambient temperatures, change the oil every 25 hours.

Drain the oil from the drain plug located on either side of the engine bottom, as shown in Figure D.2. Refill through the oil fill plug until the oil reaches the top of the fill hole. Use the grade and viscosity recommended in the engine owner's manual.

FIGURE D.2 - OIL DRAIN AND REFILL

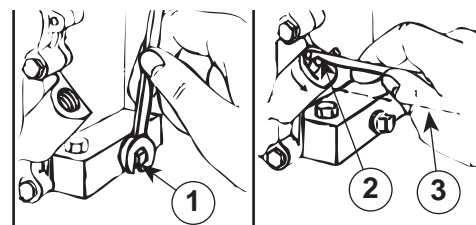

LOCATION

1. OIL DRAIN PLUG
2. OIL FILL PLUG
3. OIL LEVEL



FUEL: At the end of each day's use, refill the fuel tank to minimize moisture condensation and dirt contamination in the fuel line.

ENGINE ADJUSTMENTS



WARNING

OVERSPEED IS HAZARDOUS - The maximum allowable high idle speed for this machine is 3750 RPM, no load. **DO NOT** tamper with the governor components or setting or make any other adjustments to increase the maximum speed. Severe personal injury and damage to the machine can result if operated at speeds above maximum.

Adjustments to the engine are to be made only by a Lincoln Service Center or an authorized Field Service Shop.



CAUTION

Do not use petroleum solvents such as kerosene to clean the air cleaner. They may cause deterioration of the air cleaner. **DO NOT OIL THE AIR CLEANER OR USE PRESSURIZED AIR TO CLEAN OR DRY THE AIR CLEANER.**

To service the pre-cleaner:

1. Wash in liquid detergent and water.
2. Squeeze dry in a clean cloth.
3. Saturate in clean engine oil.
4. Squeeze in a clean, absorbent cloth to remove all excess oil.

CLEAN ENGINE: Remove dirt and debris with a cloth or a brush. Do not clean with a forceful spray of water. Water might contaminate the fuel system.



CAUTION

Periodically clean the muffler area to remove combustible debris.

Clean Rotating Screen: If your POWER-ARC 5500 is equipped with an engine that has a rotating screen, you should clean it as often as needed, to remove dirt or debris that may collect on the screen. A dirty screen can result in engine overheating and damage. (See Figure D.3).

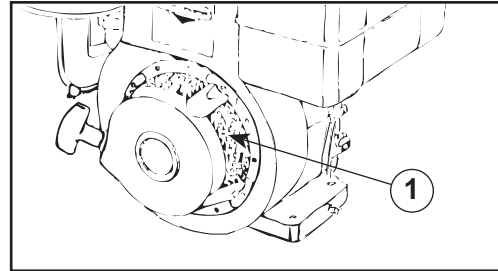

FIGURE D.3 - CLEAN ROTATING SCREEN/FINGER GUARD/DEBRIS GUARD

1. ROTATING SCREEN

CLEAN COOLING SYSTEM: See Figure D.4. Clean the internal cooling fins and surfaces to prevent overspeeding, overheating, and engine damage. Clean every 100 operating hours or as often as necessary.

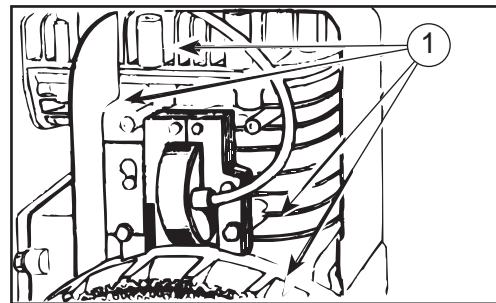

FIGURE D.4 - CLEAN COOLING SYSTEM

1. REMOVE DIRT FROM THESE AREAS.

CLEAN OR REPLACE SPARK PLUG: Clean or replace the spark plug after every 100 hours of operation or every season, whichever comes first. Do not blast the spark plug clean with an abrasive cleaning device. Clean the plug by scraping it or by using a wire brush. Wash the plug with a commercial solvent. After cleaning or when installing a new spark plug, set the terminal gap to .030 inch (.76 mm) with a feeler gauge. See Figure D.5.

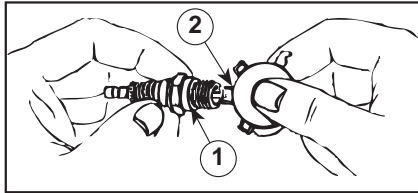

FIGURE D.5 - SET SPARK PLUG GAP

Use the engine owner's manual for latest Plug Gap Info.

CLEAN SPARK ARRESTER SCREEN: Refer to the engine owner's manual that was shipped with your POWER-ARC 5500 for the proper cleaning instructions.

**TABLE D.1
ENGINE MAINTENANCE PARTS**

Part	Robin / Subaru Part #	Honda Part #
SPARK PLUG (RESISTOR)	NGK BR6 HS	NGK BPR6ES DENSO W20EPR-U
FUEL FILTER	NONE	NONE
AIR CLEANER PANEL (Pleated Paper)	279-32616-00	5266721 (17210-ZE2-505)
AIR PRE-CLEANER (AS NEEDED)	279-32611-00 (CAN BE CLEANED AND REUSED AS NEEDED)	2538429 (17218-ZE2-821)

Refer to Table D.1 for engine maintenance parts. The part numbers are accurate at the time of printing. (Verify the current part number by referring to the engine owner's manual.

Replace or clean engine maintenance parts per the interval outlined in the engine owner's manual.

GENERATOR/WELDER MAINTENANCE

STORAGE: Store the POWER-ARC 5500 in clean, dry, protected areas.

CLEANING: Blow out the generator and controls periodically with low pressure air. Do this at least once a week in particularly dirty areas.

BRUSH REMOVAL AND REPLACEMENT: See Figure D.5. It's normal for the brushes and slip rings to wear and darken slightly. Inspect the brushes when a general overhaul is necessary. Remove the brushes and clean the slip rings with fine grit emery paper.



CAUTION

Do not attempt to polish slip rings while engine is running.

To reinstall the brushes, press them upward and slide a cable tie or wooden stick through the brush holder tabs. Install the brush holder into the bearing end bracket and secure with the screws previously removed. Remove the cable tie or wooden stick and the brushes will seat onto the slip rings.

RECEPTACLES: Keep the electrical receptacles in good condition. Remove any dirt, oil, or other debris from their surfaces and holes.

CABLE CONNECTIONS: Check the welding cable connections at the weld output terminals often. Be sure that the connections are always tight.

NOTE: Lincoln offers a rotor removal kit for any service which requires removal of the rotor from the engine. See the ACCESSORIES section for further details.

Removal of engine/generator assembly from the cradle can be achieved as follows:

- Remove the two 5/16-18 hex head cap screws from the engine block via the access hole located in the cradle cross support channel. Leave all other engine mountings intact.
- Remove the two hex nuts from the isolator threaded posts at the stator support bracket located opposite the engine. Leave all other stator mountings intact.
- With a jib hoist or crane, lift the unit upward and remove loose cradle from engine/generator assembly.

FIGURE D.5. – BRUSH REMOVAL AND REPLACEMENT

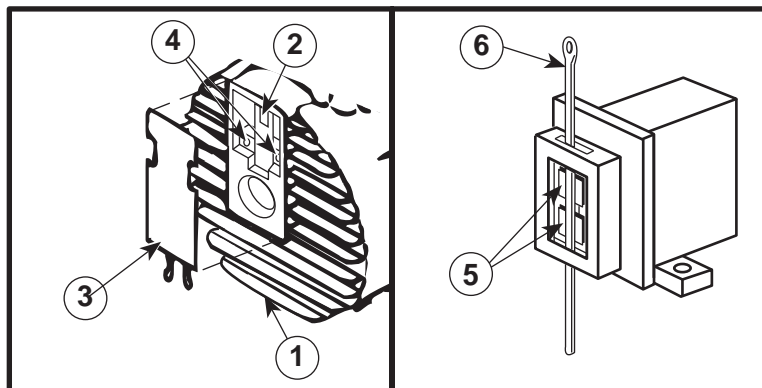

1. GENERATOR END BRACKET
2. BRUSH HOLDER ASSEMBLY
3. COVER
4. SCREWS (2)
5. BRUSHES
6. CABLE TIE

FIGURE D.6. - MAJOR COMPONENT LOCATIONS

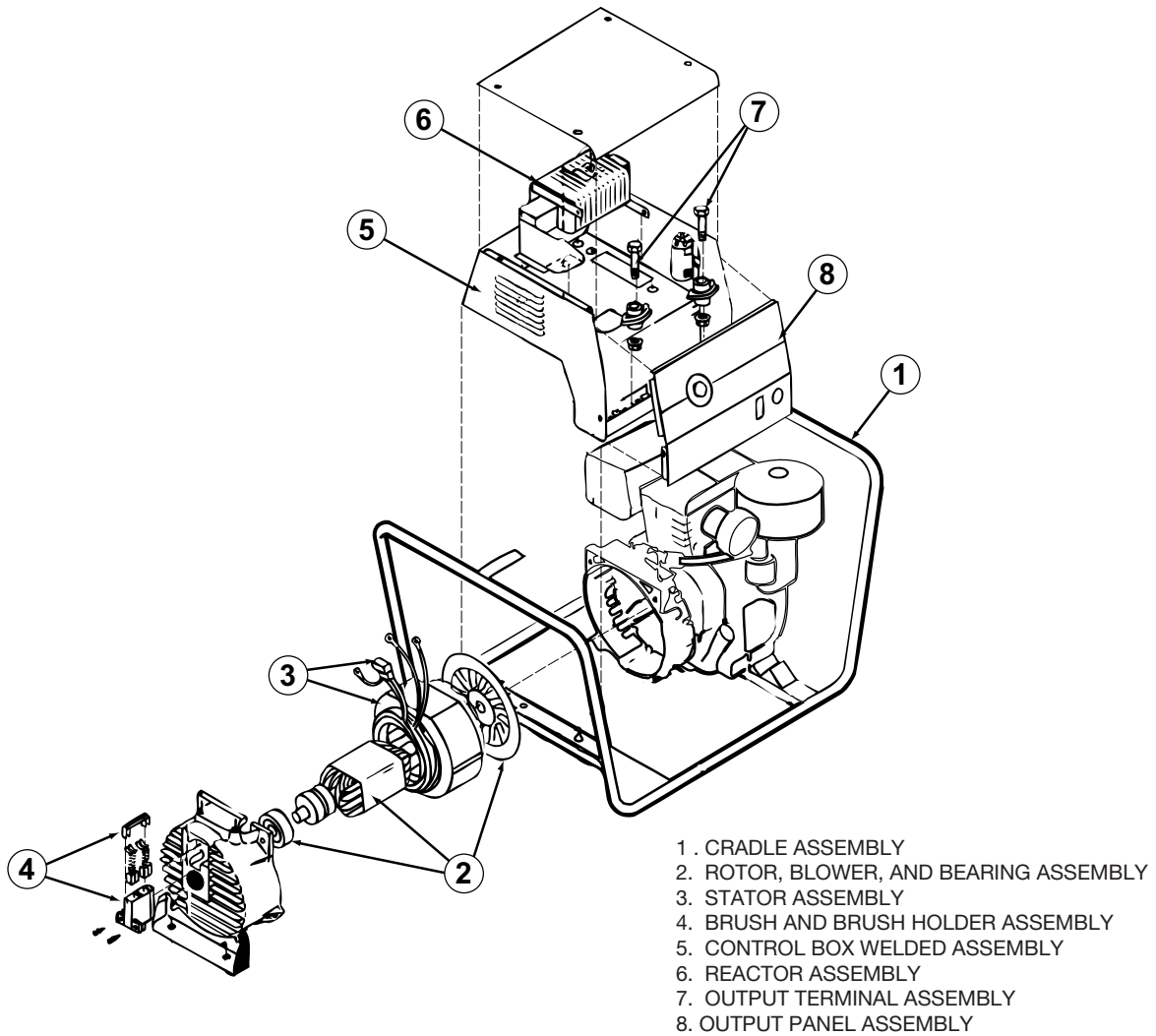

POWER-ARC 5500



HOW TO USE TROUBLESHOOTING GUIDE

WARNING

Service and Repair should only be performed by Lincoln Electric Factory Trained Personnel. Unauthorized repairs performed on this equipment may result in danger to the technician and machine operator and will invalidate your factory warranty. For your safety and to avoid Electrical Shock, please observe all safety notes and precautions detailed throughout this manual.

This Troubleshooting Guide is provided to help you locate and repair possible machine malfunctions. Simply follow the three-step procedure listed below.

Step 1. LOCATE PROBLEM (SYMPTOM).

Look under the column labeled “PROBLEM (SYMPTOMS)”. This column describes possible symptoms that the machine may exhibit. Find the listing that best describes the symptom that the machine is exhibiting.

Step 2. POSSIBLE CAUSE.

The second column labeled “POSSIBLE CAUSE” lists the obvious external possibilities that may contribute to the machine symptom.

Step 3. RECOMMENDED COURSE OF ACTION

This column provides a course of action for the Possible Cause, generally it states to contact your local Lincoln Authorized Field Service Facility.

If you do not understand or are unable to perform the Recommended Course of Action safely, contact your local Lincoln Authorized Field Service Facility.

CAUTION

If for any reason you do not understand the test procedures or are unable to perform the tests/repairs safely, contact your **Local Lincoln Authorized Field Service Facility** for technical troubleshooting assistance before you proceed.

Observe all Safety Guidelines detailed throughout this manual

PROBLEMS (SYMPTOMS)	POSSIBLE CAUSE	RECOMMENDED COURSE OF ACTION
PROBLEMS		
No generator power or welding output.	<ol style="list-style-type: none"> 1. Disconnect anything plugged into auxiliary receptacles and weld loads. 2. Open lead in flashing or field circuit. 3. Open flashing diode (D1) 4. Faulty brushes. 5. Faulty rheostat (R1). 6. Faulty field rectifier (D1). 7. Faulty capacitor (C1). 8. Faulty stator field winding. 9. Faulty rotor. 10. Dirty slip rings, clean slip rings when not in use. 	<p>If all recommended possible areas of misadjustment have been checked and the problem persists, Contact your local Lincoln Authorized Field Service Facility.</p>
Generator power is available but unit will not weld.	<ol style="list-style-type: none"> 1. Loose connection to output stud. 2. Work not connected. 3. Electrode holder loose. 4. No open circuit voltage at output studs. Open lead in weld circuit. 5. Faulty reactor (L1). 	

 **CAUTION**

If for any reason you do not understand the test procedures or are unable to perform the tests/repairs safely, contact your **Local Lincoln Authorized Field Service Facility** for technical troubleshooting assistance before you proceed.

POWER-ARC 5500



Observe all Safety Guidelines detailed throughout this manual

PROBLEMS (SYMPTOMS)	POSSIBLE CAUSE	RECOMMENDED COURSE OF ACTION
PROBLEMS		
Unit will weld but low or no generator power is available.	<ol style="list-style-type: none"> 1. Circuit breaker open. 2. Loose or open connection with electrical plug-in component. 3. Current control dial not at "125". 4. No open circuit voltage at receptacle. Open lead in receptacle circuit. 5. No open circuit voltage at receptacle. Bad receptacle. 6. Rheostat (R1) lead broke. 	
Engine runs erratically or stops running.	<ol style="list-style-type: none"> 1. Engine is not fully warmed-up and engine choke is in the fully open (RUN) position. 2. Engine requires service to head, carburetor, filters, oil, spark plug and/or gas. 	<p>If all recommended possible areas of misadjustment have been checked and the problem persists, Contact your local Lincoln Authorized Field Service Facility.</p>
Engine sputters but will not start.	<ol style="list-style-type: none"> 1. Bad gas, bad filter, air cleaner, spark plug, and/or breather. 	

 **CAUTION**

If for any reason you do not understand the test procedures or are unable to perform the tests/repairs safely, contact your **Local Lincoln Authorized Field Service Facility** for technical troubleshooting assistance before you proceed.

POWER-ARC 5500



Observe all Safety Guidelines detailed throughout this manual

PROBLEMS (SYMPTOMS)	POSSIBLE CAUSE	RECOMMENDED COURSE OF ACTION
PROBLEMS		
Engine will not start.	<ol style="list-style-type: none"> 1. Spark plug boot or wire off, loose or wet. 2. Fuel shutoff valve is closed. 3. Low oil and engine low oil shutdown protection will not allow unit to start. Light in ON-OFF switch will Flash when the engine is cranked. (Engines equipped with low oil shut down protection only). 4. Choke left in full choke position and carburetor flooded. 5. Fuel line clogged or closed. 6. Recoil start will not engage with engine. 7. Fouled spark plug. 8. Engine requires service to head, head gasket, and/or valves. 9. Float open in carburetor & gas leaking from bowl. 10. Engine operated with low oil level. Engine is seized and recoil start will not move. 	<p>If all recommended possible areas of misadjustment have been checked and the problem persists, Contact your local Lincoln Authorized Field Service Facility.</p>

 **CAUTION**

If for any reason you do not understand the test procedures or are unable to perform the tests/repairs safely, contact your **Local Lincoln Authorized Field Service Facility** for technical troubleshooting assistance before you proceed.

POWER-ARC 5500



WIRING DIAGRAM - POWER ARC 5500 (FOR CODES 11182, 11187 ROBIN / SUBARU)

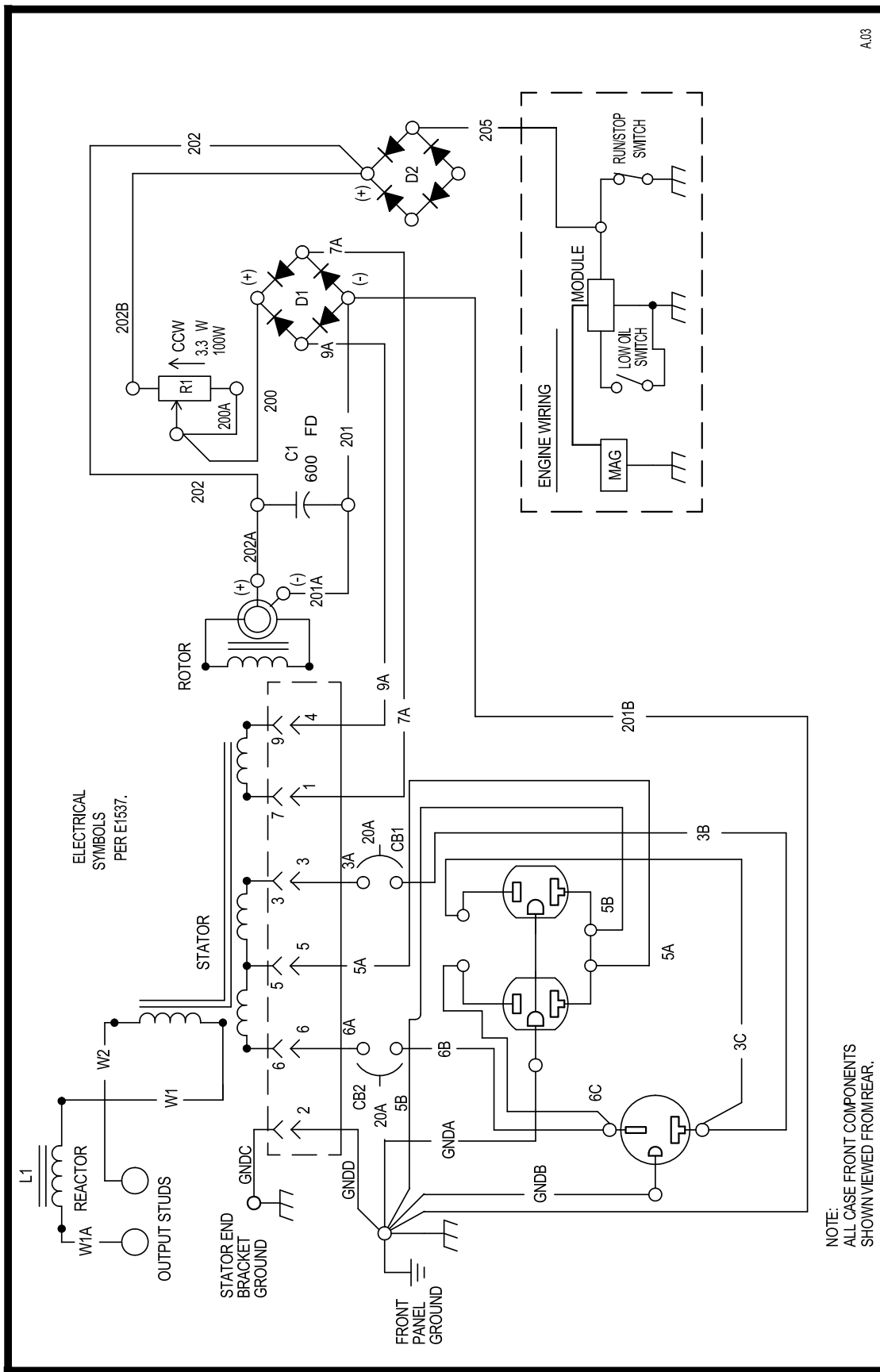

A.03

S25984

NOTE: This diagram is for reference only. It may not be accurate for all machines covered by this manual. The specific diagram for a particular code is pasted inside the machine on one of the enclosure panels. If the diagram is illegible, write to the Service Department for a replacement. Give the equipment code number.

POWER-ARC 5500



WIRING DIAGRAM - POWER ARC 5500 (FOR CODES 11215) HONDA

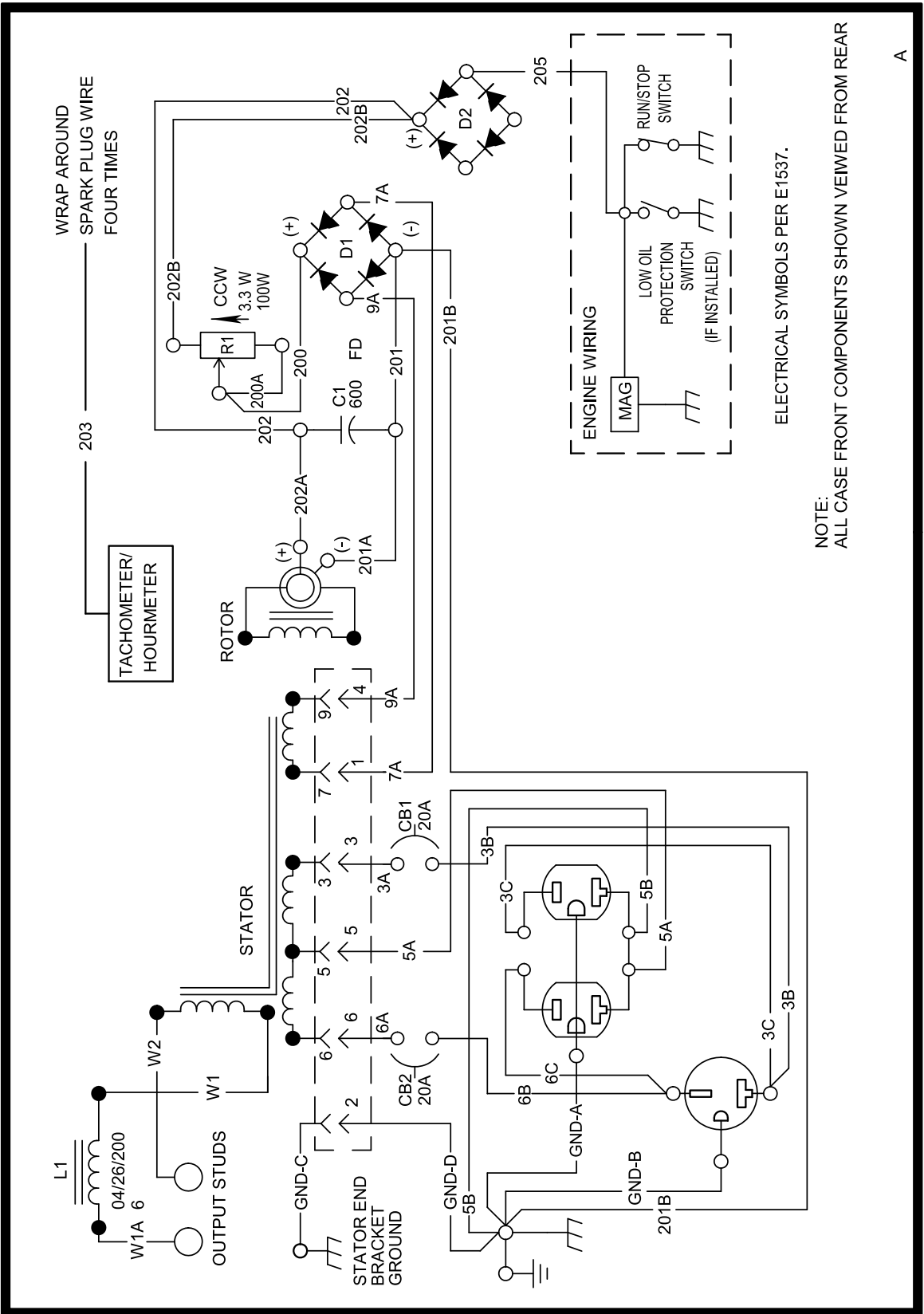

NOTE:
ALL CASE FRONT COMPONENTS SHOWN VIEWED FROM REAR

ELECTRICAL SYMBOLS PER E1537.

A

S26023

NOTE: This diagram is for reference only. It may not be accurate for all machines covered by this manual. The specific diagram for a particular code is pasted inside the machine on one of the enclosure panels. If the diagram is illegible, write to the Service Department for a replacement. Give the equipment code number.

POWER-ARC 5500



WIRING DIAGRAM- POWER ARC 5500 (FOR CODE 11403) ROBIN / SUBARU

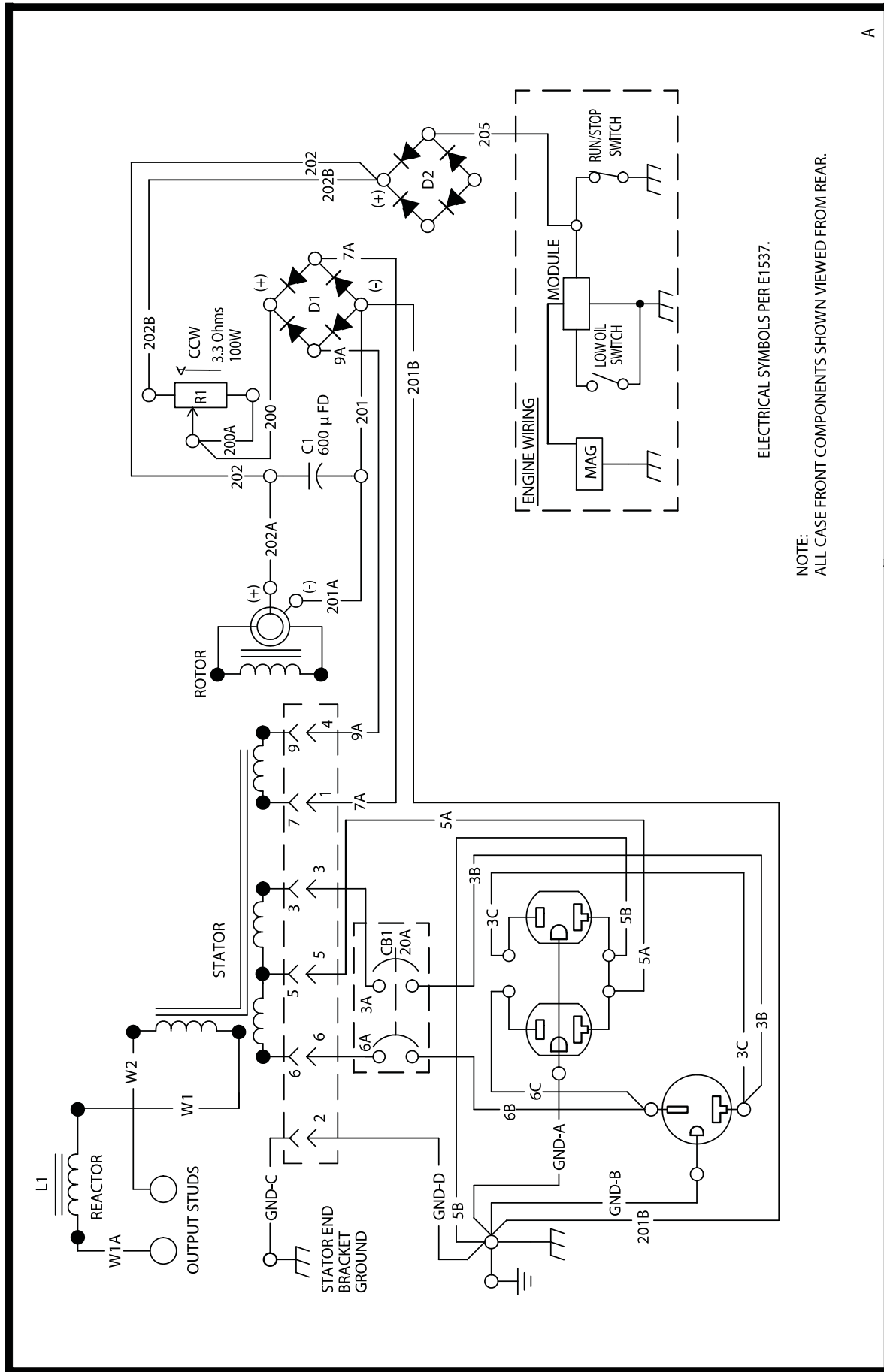

ELECTRICAL SYMBOLS PER E1537.

NOTE:
ALL CASE FRONT COMPONENTS SHOWN VIEWED FROM REAR.

A

S26829

NOTE: This diagram is for reference only. It may not be accurate for all machines covered by this manual. The specific diagram for a particular code is pasted inside the machine on one of the enclosure panels. If the diagram is illegible, write to the Service Department for a replacement. Give the equipment code number.

POWER-ARC 5500



WIRING DIAGRAM - POWER ARC 5500 FOR CODE 11404 (HONDA)

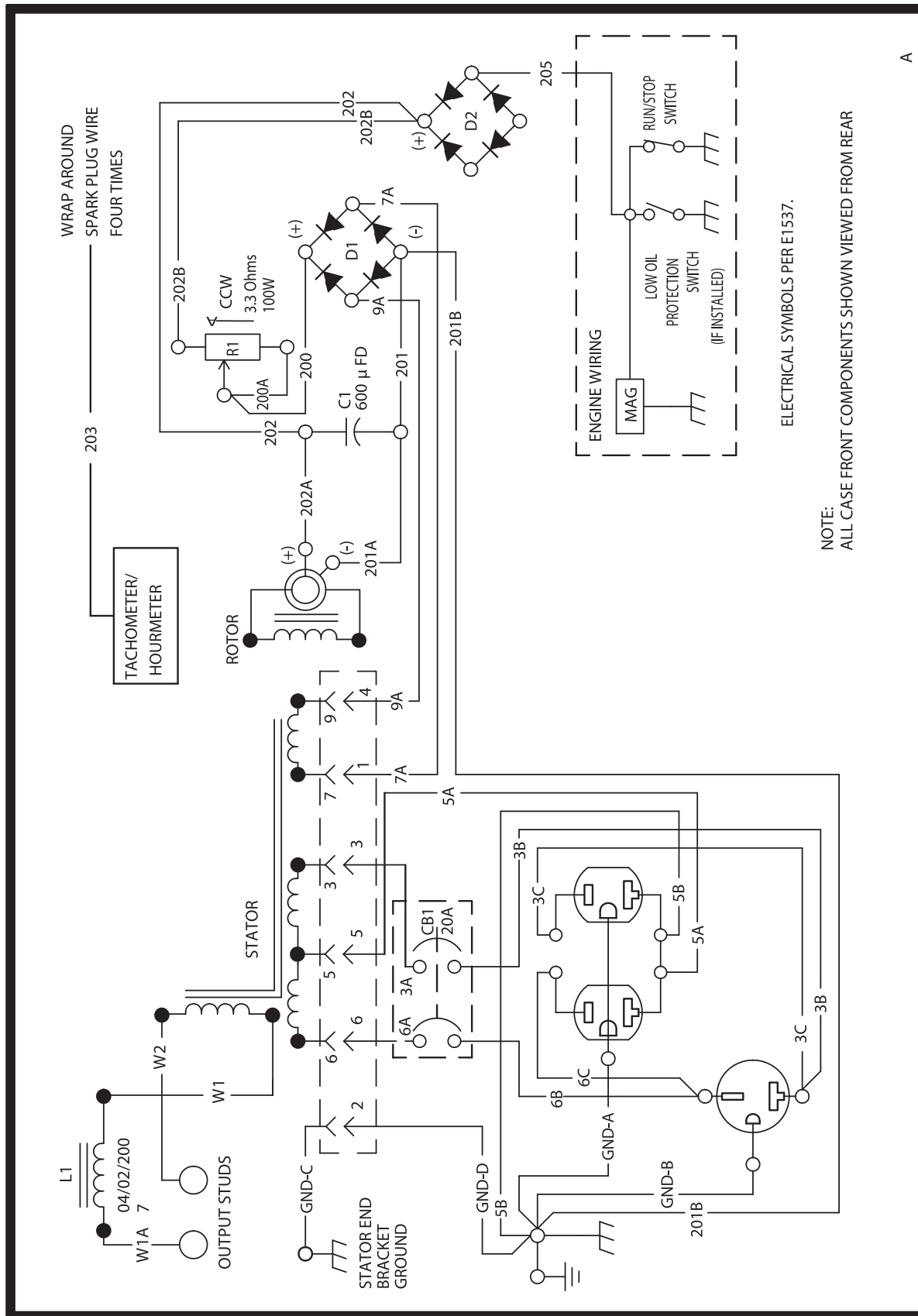

ELECTRICAL SYMBOLS PER E1537.

NOTE:
ALL CASE FRONT COMPONENTS SHOWN VIEWED FROM REAR

A

526830

NOTE: This diagram is for reference only. It may not be accurate for all machines covered by this manual. The specific diagram for a particular code is pasted inside the machine on one of the enclosure panels. If the diagram is illegible, write to the Service Department for a replacement. Give the equipment code number.

POWER-ARC 5500



DIMENSION PRINT POWER ARC 5500

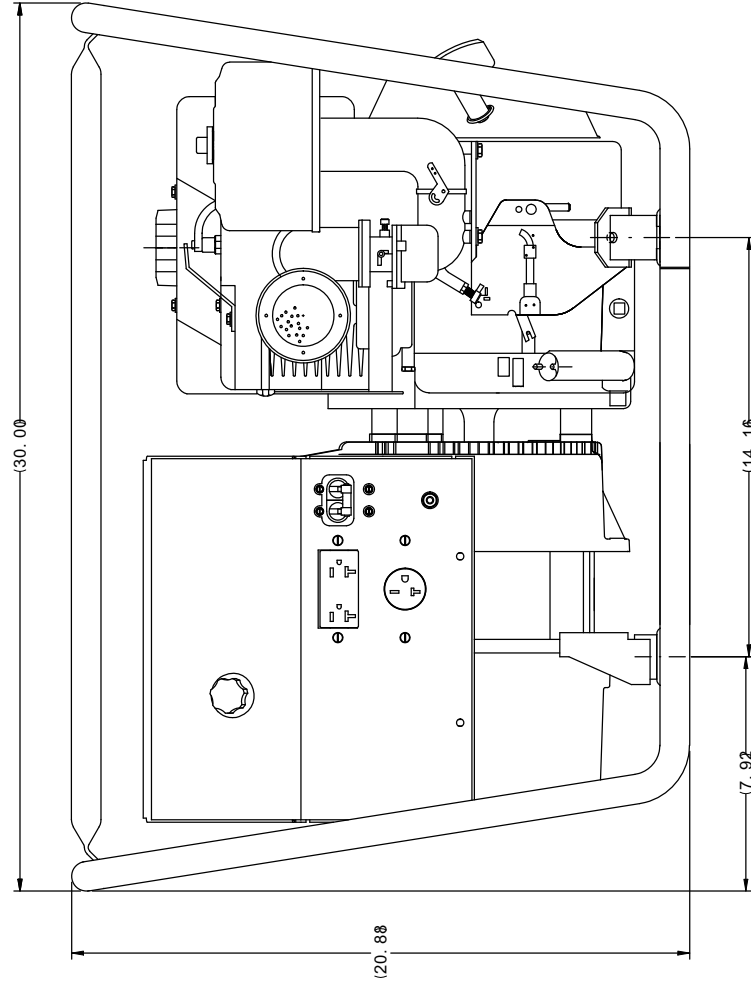
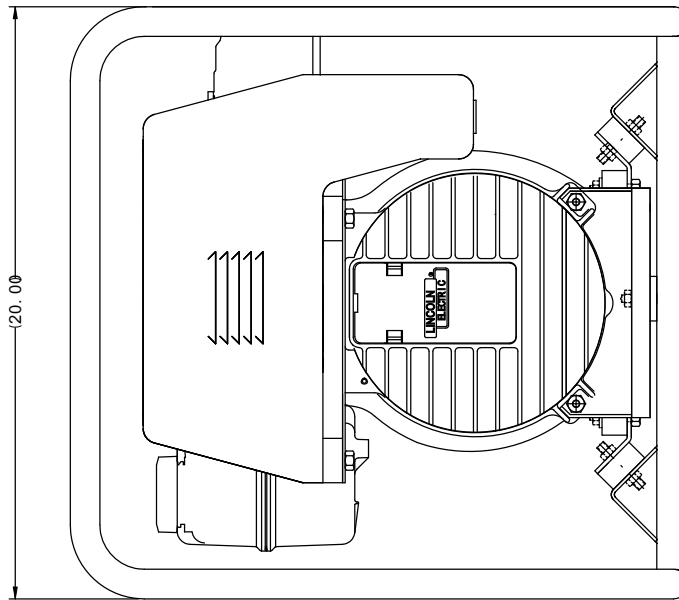

A.01
M17196

POWER-ARC 5500



NOTES

WARNING	<ul style="list-style-type: none"> Do not touch electrically live parts or electrode with skin or wet clothing. Insulate yourself from work and ground. 	<ul style="list-style-type: none"> Keep flammable materials away. 	<ul style="list-style-type: none"> Wear eye, ear and body protection.
Spanish AVISO DE PRECAUCION	<ul style="list-style-type: none"> No toque las partes o los electrodos bajo carga con la piel o ropa mojada. Aíslese del trabajo y de la tierra. 	<ul style="list-style-type: none"> Mantenga el material combustible fuera del área de trabajo. 	<ul style="list-style-type: none"> Protéjase los ojos, los oídos y el cuerpo.
French ATTENTION	<ul style="list-style-type: none"> Ne laissez ni la peau ni des vêtements mouillés entrer en contact avec des pièces sous tension. Isolez-vous du travail et de la terre. 	<ul style="list-style-type: none"> Gardez à l'écart de tout matériel inflammable. 	<ul style="list-style-type: none"> Protégez vos yeux, vos oreilles et votre corps.
German WARNUNG	<ul style="list-style-type: none"> Berühren Sie keine stromführenden Teile oder Elektroden mit Ihrem Körper oder feuchter Kleidung! Isolieren Sie sich von den Elektroden und dem Erdboden! 	<ul style="list-style-type: none"> Entfernen Sie brennbares Material! 	<ul style="list-style-type: none"> Tragen Sie Augen-, Ohren- und Körperschutz!
Portuguese ATENÇÃO	<ul style="list-style-type: none"> Não toque partes elétricas e electrodos com a pele ou roupa molhada. Isole-se da peça e terra. 	<ul style="list-style-type: none"> Mantenha inflamáveis bem guardados. 	<ul style="list-style-type: none"> Use proteção para a vista, ouvido e corpo.
Japanese 注意事項	<ul style="list-style-type: none"> 通電中の電気部品、又は溶材にヒフやぬれた布で触れないこと。 施工物やアースから身体が絶縁されている様にして下さい。 	<ul style="list-style-type: none"> 燃えやすいものの側での溶接作業は絶対にしてはなりません。 	<ul style="list-style-type: none"> 目、耳及び身体に保護具をして下さい。
Chinese 警告	<ul style="list-style-type: none"> 皮肤或湿衣物切勿接触带电部件及焊条。 使你自已与地面和工作件绝缘。 	<ul style="list-style-type: none"> 把一切易燃物品移离工作场所。 	<ul style="list-style-type: none"> 佩戴眼、耳及身体劳动保护用具。
Korean 위험	<ul style="list-style-type: none"> 전도체나 용접봉을 젖은 형갑 또는 피부로 절대 접촉치 마십시오. 모재와 접지를 접촉치 마십시오. 	<ul style="list-style-type: none"> 인화성 물질을 접근시키지 마십시오. 	<ul style="list-style-type: none"> 눈, 귀와 몸에 보호장구를 착용하십시오.
Arabic تحذير	<ul style="list-style-type: none"> لا تلمس الاجزاء التي يسري فيها التيار الكهربائي أو الألكترود بجسد الجسم أو بالملابس المبللة بالماء. ضع عازلا على جسمك خلال العمل. 	<ul style="list-style-type: none"> ضع المواد القابلة للاشتعال في مكان بعيد. 	<ul style="list-style-type: none"> ضع أدوات وملابس واقية على عينيك وأذنيك وجسمك.

READ AND UNDERSTAND THE MANUFACTURER'S INSTRUCTION FOR THIS EQUIPMENT AND THE CONSUMABLES TO BE USED AND FOLLOW YOUR EMPLOYER'S SAFETY PRACTICES.

SE RECOMIENDA LEER Y ENTENDER LAS INSTRUCCIONES DEL FABRICANTE PARA EL USO DE ESTE EQUIPO Y LOS CONSUMIBLES QUE VA A UTILIZAR, SIGA LAS MEDIDAS DE SEGURIDAD DE SU SUPERVISOR.

LISEZ ET COMPRENEZ LES INSTRUCTIONS DU FABRICANT EN CE QUI REGARDE CET EQUIPMENT ET LES PRODUITS A ETRE EMPLOYES ET SUIVEZ LES PROCEDURES DE SECURITE DE VOTRE EMPLOYEUR.

LESEN SIE UND BEFOLGEN SIE DIE BETRIEBSANLEITUNG DER ANLAGE UND DEN ELEKTRODENEINSATZ DES HERSTELLERS. DIE UNFALLVERHÜTUNGSVORSCHRIFTEN DES ARBEITGEBERS SIND EBENFALLS ZU BEACHTEN.

			
<ul style="list-style-type: none"> ● Keep your head out of fumes. ● Use ventilation or exhaust to remove fumes from breathing zone. 	<ul style="list-style-type: none"> ● Turn power off before servicing. 	<ul style="list-style-type: none"> ● Do not operate with panel open or guards off. 	WARNING
<ul style="list-style-type: none"> ● Los humos fuera de la zona de respiración. ● Mantenga la cabeza fuera de los humos. Utilice ventilación o aspiración para gases. 	<ul style="list-style-type: none"> ● Desconectar el cable de alimentación de poder de la máquina antes de iniciar cualquier servicio. 	<ul style="list-style-type: none"> ● No operar con panel abierto o guardas quitadas. 	Spanish AVISO DE PRECAUCION
<ul style="list-style-type: none"> ● Gardez la tête à l'écart des fumées. ● Utilisez un ventilateur ou un aspirateur pour ôter les fumées des zones de travail. 	<ul style="list-style-type: none"> ● Débranchez le courant avant l'entretien. 	<ul style="list-style-type: none"> ● N'opérez pas avec les panneaux ouverts ou avec les dispositifs de protection enlevés. 	French ATTENTION
<ul style="list-style-type: none"> ● Vermeiden Sie das Einatmen von Schweißrauch! ● Sorgen Sie für gute Be- und Entlüftung des Arbeitsplatzes! 	<ul style="list-style-type: none"> ● Strom vor Wartungsarbeiten abschalten! (Netzstrom völlig öffnen; Maschine anhalten!) 	<ul style="list-style-type: none"> ● Anlage nie ohne Schutzgehäuse oder Innenschutzverkleidung in Betrieb setzen! 	German WARNUNG
<ul style="list-style-type: none"> ● Mantenha seu rosto da fumaça. ● Use ventilação e exaustão para remover fumo da zona respiratória. 	<ul style="list-style-type: none"> ● Não opere com as tampas removidas. ● Desligue a corrente antes de fazer serviço. ● Não toque as partes elétricas nuas. 	<ul style="list-style-type: none"> ● Mantenha-se afastado das partes moventes. ● Não opere com os painéis abertos ou guardas removidas. 	Portuguese ATENÇÃO
<ul style="list-style-type: none"> ● ヒュームから頭を離すようにして下さい。 ● 換気や排煙に十分留意して下さい。 	<ul style="list-style-type: none"> ● メンテナンス・サービスに取りかかる際には、まず電源スイッチを必ず切して下さい。 	<ul style="list-style-type: none"> ● パネルやカバーを取り外したままで機械操作をしないで下さい。 	Japanese 注意事項
<ul style="list-style-type: none"> ● 頭部遠離煙霧。 ● 在呼吸區使用通風或排風器除煙。 	<ul style="list-style-type: none"> ● 維修前切斷電源。 	<ul style="list-style-type: none"> ● 儀表板打開或沒有安全罩時不準作業。 	Chinese 警告
<ul style="list-style-type: none"> ● 얼굴로부터 용접가스를 멀리하십시오. ● 호흡지역으로부터 용접가스를 제거하기 위해 가스제거기나 통풍기를 사용하십시오. 	<ul style="list-style-type: none"> ● 보수전에 전원을 차단하십시오. 	<ul style="list-style-type: none"> ● 판넬이 열린 상태로 작동치 마십시오. 	Korean 위험
<ul style="list-style-type: none"> ● ابعء رأسك بعيداً عن الدخان. ● استعمل التهوية أو جهاز ضغط الدخان للخارج لكي تبعء الدخان عن المنطقة التي تتنفس فيها. 	<ul style="list-style-type: none"> ● اقطع التيار الكهربائي قبل القيام بأية صيانة. 	<ul style="list-style-type: none"> ● لا تشغل هذا الجهاز إذا كانت الاغطية الحديدية الواقية ليست عليه. 	Arabic تحذير

LEIA E COMPREENDA AS INSTRUÇÕES DO FABRICANTE PARA ESTE EQUIPAMENTO E AS PARTES DE USO, E SIGA AS PRÁTICAS DE SEGURANÇA DO EMPREGADOR.

使う機械や溶材のメーカーの指示書をよく読み、まず理解して下さい。そして貴社の安全規定に従って下さい。

請詳細閱讀並理解製造廠提供的說明以及應該使用的銀焊材料，並請遵守貴方的有關勞動保護規定。

이 제품에 동봉된 작업지침서를 숙지하시고 귀사의 작업자 안전수칙을 준수하시기 바랍니다.

اقرأ بتمعن وافهم تعليمات المصنع المنتج لهذه المعدات والمواد قبل استعمالها واتبع تعليمات الوقاية لصاحب العمل.



• World's Leader in Welding and Cutting Products •

• Sales and Service through Subsidiaries and Distributors Worldwide •

Cleveland, Ohio 44117-1199 U.S.A. TEL: 216.481.8100 FAX: 216.486.1751 WEB SITE: www.lincolnelectric.com

Download from Www.Somanuals.com. All Manuals Search And Download.

Free Manuals Download Website

<http://myh66.com>

<http://usermanuals.us>

<http://www.somanuals.com>

<http://www.4manuals.cc>

<http://www.manual-lib.com>

<http://www.404manual.com>

<http://www.luxmanual.com>

<http://aubethermostatmanual.com>

Golf course search by state

<http://golfingnear.com>

Email search by domain

<http://emailbydomain.com>

Auto manuals search

<http://auto.somanuals.com>

TV manuals search

<http://tv.somanuals.com>