

PRECISION TIG 185

For use with machines having Code Numbers: **11105, 11106, 11107**
11108, 11109

Safety Depends on You
 Lincoln arc welding and cutting equipment is designed and built with safety in mind. However, your overall safety can be increased by proper installation ... and thoughtful operation on your part. DO NOT INSTALL, OPERATE OR REPAIR THIS EQUIPMENT WITHOUT READING THIS MANUAL AND THE SAFETY PRECAUTIONS CONTAINED THROUGHOUT. And, most importantly, think before you act and be careful.

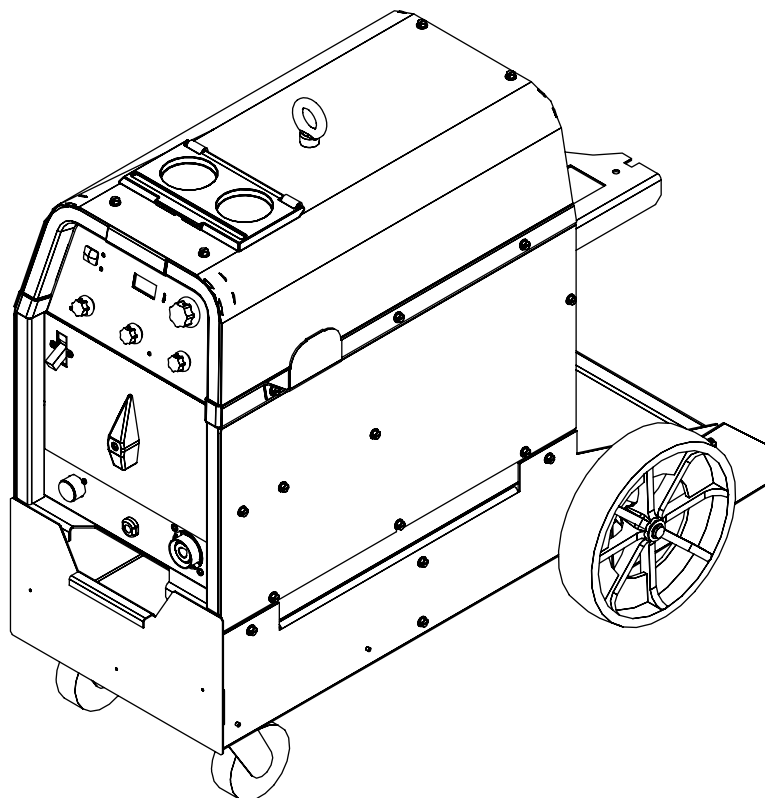

IP 21S

OPERATOR'S MANUAL



LINCOLN[®]
ELECTRIC

Copyright © 2006 Lincoln Global Inc.

• World's Leader in Welding and Cutting Products •

• Sales and Service through Subsidiaries and Distributors Worldwide •

Cleveland, Ohio 44117-1199 U.S.A. TEL: 216.481.8100 FAX: 216.486.1751 WEB SITE: www.lincolnelectric.com

Download from Www.Somanuals.com. All Manuals Search And Download.

⚠ WARNING

⚠ CALIFORNIA PROPOSITION 65 WARNINGS ⚠

Diesel engine exhaust and some of its constituents are known to the State of California to cause cancer, birth defects, and other reproductive harm.

The Above For Diesel Engines

The engine exhaust from this product contains chemicals known to the State of California to cause cancer, birth defects, or other reproductive harm.

The Above For Gasoline Engines

ARC WELDING CAN BE HAZARDOUS. PROTECT YOURSELF AND OTHERS FROM POSSIBLE SERIOUS INJURY OR DEATH. KEEP CHILDREN AWAY. PACEMAKER WEARERS SHOULD CONSULT WITH THEIR DOCTOR BEFORE OPERATING.

Read and understand the following safety highlights. For additional safety information, it is strongly recommended that you purchase a copy of "Safety in Welding & Cutting - ANSI Standard Z49.1" from the American Welding Society, P.O. Box 351040, Miami, Florida 33135 or CSA Standard W117.2-1974. A Free copy of "Arc Welding Safety" booklet E205 is available from the Lincoln Electric Company, 22801 St. Clair Avenue, Cleveland, Ohio 44117-1199.

BE SURE THAT ALL INSTALLATION, OPERATION, MAINTENANCE AND REPAIR PROCEDURES ARE PERFORMED ONLY BY QUALIFIED INDIVIDUALS.



FOR ENGINE powered equipment.

1.a. Turn the engine off before troubleshooting and maintenance work unless the maintenance work requires it to be running.



1.b. Operate engines in open, well-ventilated areas or vent the engine exhaust fumes outdoors.



1.c. Do not add the fuel near an open flame welding arc or when the engine is running. Stop the engine and allow it to cool before refueling to prevent spilled fuel from vaporizing on contact with hot engine parts and igniting. Do not spill fuel when filling tank. If fuel is spilled, wipe it up and do not start engine until fumes have been eliminated.

1.d. Keep all equipment safety guards, covers and devices in position and in good repair. Keep hands, hair, clothing and tools away from V-belts, gears, fans and all other moving parts when starting, operating or repairing equipment.

1.e. In some cases it may be necessary to remove safety guards to perform required maintenance. Remove guards only when necessary and replace them when the maintenance requiring their removal is complete. Always use the greatest care when working near moving parts.



1.f. Do not put your hands near the engine fan. Do not attempt to override the governor or idler by pushing on the throttle control rods while the engine is running.

1.g. To prevent accidentally starting gasoline engines while turning the engine or welding generator during maintenance work, disconnect the spark plug wires, distributor cap or magneto wire as appropriate.

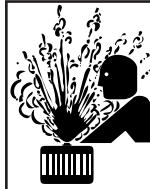

1.h. To avoid scalding, do not remove the radiator pressure cap when the engine is hot.



ELECTRIC AND MAGNETIC FIELDS may be dangerous

2.a. Electric current flowing through any conductor causes localized Electric and Magnetic Fields (EMF). Welding current creates EMF fields around welding cables and welding machines

2.b. EMF fields may interfere with some pacemakers, and welders having a pacemaker should consult their physician before welding.

2.c. Exposure to EMF fields in welding may have other health effects which are now not known.

2.d. All welders should use the following procedures in order to minimize exposure to EMF fields from the welding circuit:

2.d.1. Route the electrode and work cables together - Secure them with tape when possible.

2.d.2. Never coil the electrode lead around your body.

2.d.3. Do not place your body between the electrode and work cables. If the electrode cable is on your right side, the work cable should also be on your right side.

2.d.4. Connect the work cable to the workpiece as close as possible to the area being welded.

2.d.5. Do not work next to welding power source.

Mar '95



ELECTRIC SHOCK can kill.

- 3.a. The electrode and work (or ground) circuits are electrically "hot" when the welder is on. Do not touch these "hot" parts with your bare skin or wet clothing. Wear dry, hole-free gloves to insulate hands.
- 3.b. Insulate yourself from work and ground using dry insulation. Make certain the insulation is large enough to cover your full area of physical contact with work and ground.
- In addition to the normal safety precautions, if welding must be performed under electrically hazardous conditions (in damp locations or while wearing wet clothing; on metal structures such as floors, gratings or scaffolds; when in cramped positions such as sitting, kneeling or lying, if there is a high risk of unavoidable or accidental contact with the workpiece or ground) use the following equipment:**
- Semiautomatic DC Constant Voltage (Wire) Welder.
 - DC Manual (Stick) Welder.
 - AC Welder with Reduced Voltage Control.
- 3.c. In semiautomatic or automatic wire welding, the electrode, electrode reel, welding head, nozzle or semiautomatic welding gun are also electrically "hot".
- 3.d. Always be sure the work cable makes a good electrical connection with the metal being welded. The connection should be as close as possible to the area being welded.
- 3.e. Ground the work or metal to be welded to a good electrical (earth) ground.
- 3.f. Maintain the electrode holder, work clamp, welding cable and welding machine in good, safe operating condition. Replace damaged insulation.
- 3.g. Never dip the electrode in water for cooling.
- 3.h. Never simultaneously touch electrically "hot" parts of electrode holders connected to two welders because voltage between the two can be the total of the open circuit voltage of both welders.
- 3.i. When working above floor level, use a safety belt to protect yourself from a fall should you get a shock.
- 3.j. Also see Items 6.c. and 8.



ARC RAYS can burn.

- 4.a. Use a shield with the proper filter and cover plates to protect your eyes from sparks and the rays of the arc when welding or observing open arc welding. Headshield and filter lens should conform to ANSI Z87.1 standards.
- 4.b. Use suitable clothing made from durable flame-resistant material to protect your skin and that of your helpers from the arc rays.
- 4.c. Protect other nearby personnel with suitable, non-flammable screening and/or warn them not to watch the arc nor expose themselves to the arc rays or to hot spatter or metal.



FUMES AND GASES can be dangerous.

- 5.a. Welding may produce fumes and gases hazardous to health. Avoid breathing these fumes and gases. When welding, keep your head out of the fume. Use enough ventilation and/or exhaust at the arc to keep fumes and gases away from the breathing zone. **When welding with electrodes which require special ventilation such as stainless or hard facing (see instructions on container or MSDS) or on lead or cadmium plated steel and other metals or coatings which produce highly toxic fumes, keep exposure as low as possible and below Threshold Limit Values (TLV) using local exhaust or mechanical ventilation. In confined spaces or in some circumstances, outdoors, a respirator may be required. Additional precautions are also required when welding on galvanized steel.**
5. b. The operation of welding fume control equipment is affected by various factors including proper use and positioning of the equipment, maintenance of the equipment and the specific welding procedure and application involved. Worker exposure level should be checked upon installation and periodically thereafter to be certain it is within applicable OSHA PEL and ACGIH TLV limits.
- 5.c. Do not weld in locations near chlorinated hydrocarbon vapors coming from degreasing, cleaning or spraying operations. The heat and rays of the arc can react with solvent vapors to form phosgene, a highly toxic gas, and other irritating products.
- 5.d. Shielding gases used for arc welding can displace air and cause injury or death. Always use enough ventilation, especially in confined areas, to insure breathing air is safe.
- 5.e. Read and understand the manufacturer's instructions for this equipment and the consumables to be used, including the material safety data sheet (MSDS) and follow your employer's safety practices. MSDS forms are available from your welding distributor or from the manufacturer.
- 5.f. Also see item 1.b.

AUG 06

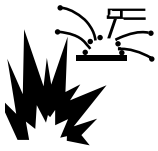

WELDING SPARKS can cause fire or explosion.

6.a. Remove fire hazards from the welding area. If this is not possible, cover them to prevent the welding sparks from starting a fire.

Remember that welding sparks and hot materials from welding can easily go through small cracks and openings to adjacent areas. Avoid welding near hydraulic lines. Have a fire extinguisher readily available.

- 6.b. Where compressed gases are to be used at the job site, special precautions should be used to prevent hazardous situations. Refer to "Safety in Welding and Cutting" (ANSI Standard Z49.1) and the operating information for the equipment being used.
- 6.c. When not welding, make certain no part of the electrode circuit is touching the work or ground. Accidental contact can cause overheating and create a fire hazard.
- 6.d. Do not heat, cut or weld tanks, drums or containers until the proper steps have been taken to insure that such procedures will not cause flammable or toxic vapors from substances inside. They can cause an explosion even though they have been "cleaned". For information, purchase "Recommended Safe Practices for the Preparation for Welding and Cutting of Containers and Piping That Have Held Hazardous Substances", AWS F4.1 from the American Welding Society (see address above).
- 6.e. Vent hollow castings or containers before heating, cutting or welding. They may explode.
- 6.f. Sparks and spatter are thrown from the welding arc. Wear oil free protective garments such as leather gloves, heavy shirt, cuffless trousers, high shoes and a cap over your hair. Wear ear plugs when welding out of position or in confined places. Always wear safety glasses with side shields when in a welding area.
- 6.g. Connect the work cable to the work as close to the welding area as practical. Work cables connected to the building framework or other locations away from the welding area increase the possibility of the welding current passing through lifting chains, crane cables or other alternate circuits. This can create fire hazards or overheat lifting chains or cables until they fail.
- 6.h. Also see item 1.c.

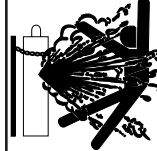

CYLINDER may explode if damaged.

7.a. Use only compressed gas cylinders containing the correct shielding gas for the process used and properly operating regulators designed for the gas and pressure used. All hoses, fittings, etc. should be suitable for the application and maintained in good condition.

- 7.b. Always keep cylinders in an upright position securely chained to an undercarriage or fixed support.
- 7.c. Cylinders should be located:
 - Away from areas where they may be struck or subjected to physical damage.
 - A safe distance from arc welding or cutting operations and any other source of heat, sparks, or flame.
- 7.d. Never allow the electrode, electrode holder or any other electrically "hot" parts to touch a cylinder.
- 7.e. Keep your head and face away from the cylinder valve outlet when opening the cylinder valve.
- 7.f. Valve protection caps should always be in place and hand tight except when the cylinder is in use or connected for use.
- 7.g. Read and follow the instructions on compressed gas cylinders, associated equipment, and CGA publication P-1, "Precautions for Safe Handling of Compressed Gases in Cylinders," available from the Compressed Gas Association 1235 Jefferson Davis Highway, Arlington, VA 22202.



FOR ELECTRICALLY powered equipment.

- 8.a. Turn off input power using the disconnect switch at the fuse box before working on the equipment.
- 8.b. Install equipment in accordance with the U.S. National Electrical Code, all local codes and the manufacturer's recommendations.
- 8.c. Ground the equipment in accordance with the U.S. National Electrical Code and the manufacturer's recommendations.

Mar '95

PRÉCAUTIONS DE SÛRETÉ

Pour votre propre protection lire et observer toutes les instructions et les précautions de sûreté spécifiques qui paraissent dans ce manuel aussi bien que les précautions de sûreté générales suivantes:

Sûreté Pour Soudage A L'Arc

1. Protégez-vous contre la secousse électrique:
 - a. Les circuits à l'électrode et à la pièce sont sous tension quand la machine à souder est en marche. Eviter toujours tout contact entre les parties sous tension et la peau nue ou les vêtements mouillés. Porter des gants secs et sans trous pour isoler les mains.
 - b. Faire très attention de bien s'isoler de la masse quand on soude dans des endroits humides, ou sur un plancher métallique ou des grilles métalliques, principalement dans les positions assis ou couché pour lesquelles une grande partie du corps peut être en contact avec la masse.
 - c. Maintenir le porte-électrode, la pince de masse, le câble de soudage et la machine à souder en bon et sûr état de fonctionnement.
 - d. Ne jamais plonger le porte-électrode dans l'eau pour le refroidir.
 - e. Ne jamais toucher simultanément les parties sous tension des porte-électrodes connectés à deux machines à souder parce que la tension entre les deux pinces peut être le total de la tension à vide des deux machines.
 - f. Si on utilise la machine à souder comme une source de courant pour soudage semi-automatique, ces précautions pour le porte-électrode s'appliquent aussi au pistolet de soudage.
2. Dans le cas de travail au dessus du niveau du sol, se protéger contre les chutes dans le cas où on recoit un choc. Ne jamais enrouler le câble-électrode autour de n'importe quelle partie du corps.
3. Un coup d'arc peut être plus sévère qu'un coup de soleil, donc:
 - a. Utiliser un bon masque avec un verre filtrant approprié ainsi qu'un verre blanc afin de se protéger les yeux du rayonnement de l'arc et des projections quand on soude ou quand on regarde l'arc.
 - b. Porter des vêtements convenables afin de protéger la peau de soudeur et des aides contre le rayonnement de l'arc.
 - c. Protéger l'autre personnel travaillant à proximité au soudage à l'aide d'écrans appropriés et non-inflammables.
4. Des gouttes de laitier en fusion sont émises de l'arc de soudage. Se protéger avec des vêtements de protection libres de l'huile, tels que les gants en cuir, chemise épaisse, pantalons sans revers, et chaussures montantes.

5. Toujours porter des lunettes de sécurité dans la zone de soudage. Utiliser des lunettes avec écrans latéraux dans les zones où l'on pique le laitier.
6. Eloigner les matériaux inflammables ou les recouvrir afin de prévenir tout risque d'incendie dû aux étincelles.
7. Quand on ne soude pas, poser la pince à un endroit isolé de la masse. Un court-circuit accidentel peut provoquer un échauffement et un risque d'incendie.
8. S'assurer que la masse est connectée le plus près possible de la zone de travail qu'il est pratique de le faire. Si on place la masse sur la charpente de la construction ou d'autres endroits éloignés de la zone de travail, on augmente le risque de voir passer le courant de soudage par les chaînes de levage, câbles de grue, ou autres circuits. Cela peut provoquer des risques d'incendie ou d'échauffement des chaînes et des câbles jusqu'à ce qu'ils se rompent.
9. Assurer une ventilation suffisante dans la zone de soudage. Ceci est particulièrement important pour le soudage de tôles galvanisées plombées, ou cadmiées ou tout autre métal qui produit des fumees toxiques.
10. Ne pas souder en présence de vapeurs de chlore provenant d'opérations de dégraissage, nettoyage ou pistolage. La chaleur ou les rayons de l'arc peuvent réagir avec les vapeurs du solvant pour produire du phosgène (gas fortement toxique) ou autres produits irritants.
11. Pour obtenir de plus amples renseignements sur la sûreté, voir le code "Code for safety in welding and cutting" CSA Standard W 117.2-1974.

PRÉCAUTIONS DE SÛRETÉ POUR LES MACHINES À SOUDER À TRANSFORMATEUR ET À REDRESSEUR

1. Relier à la terre le chassis du poste conformément au code de l'électricité et aux recommandations du fabricant. Le dispositif de montage ou la pièce à souder doit être branché à une bonne mise à la terre.
2. Autant que possible, l'installation et l'entretien du poste seront effectués par un électricien qualifié.
3. Avant de faire des travaux à l'intérieur de poste, la débrancher à l'interrupteur à la boîte de fusibles.
4. Garder tous les couvercles et dispositifs de sûreté à leur place.

ELECTROMAGNETIC COMPATIBILITY (EMC)

Conformance

Products displaying the CE mark are in conformity with European Community Council Directive of 3 May 1989 on the approximation of the laws of the Member States relating to electromagnetic compatibility (89/336/EEC). It was manufactured in conformity with a national standard that implements a harmonized standard: EN 50 199 Electromagnetic Compatibility (EMC) Product Standard for Arc Welding Equipment. It is for use with other Lincoln Electric equipment. It is designed for industrial and professional use.

Introduction

All electrical equipment generates small amounts of electromagnetic emission. Electrical emission may be transmitted through power lines or radiated through space, similar to a radio transmitter. When emissions are received by other equipment, electrical interference may result. Electrical emissions may affect many kinds of electrical equipment; other nearby welding equipment, radio and TV reception, numerical controlled machines, telephone systems, computers, etc. Be aware that interference may result and extra precautions may be required when a welding power source is used in a domestic establishment.

Installation and Use

The user is responsible for installing and using the welding equipment according to the manufacturer's instructions. If electromagnetic disturbances are detected then it shall be the responsibility of the user of the welding equipment to resolve the situation with the technical assistance of the manufacturer. In some cases this remedial action may be as simple as earthing (grounding) the welding circuit, see Note. In other cases it could involve constructing an electromagnetic screen enclosing the power source and the work complete with associated input filters. In all cases electromagnetic disturbances must be reduced to the point where they are no longer troublesome.

Note: The welding circuit may or may not be earthed for safety reasons according to national codes.

Changing the earthing arrangements should only be authorized by a person who is competent to assess whether the changes will increase the risk of injury, e.g., by allowing parallel welding current return paths which may damage the earth circuits of other equipment.

Assessment of Area

Before installing welding equipment the user shall make an assessment of potential electromagnetic problems in the surrounding area. The following shall be taken into account:

- a) other supply cables, control cables, signaling and telephone cables; above, below and adjacent to the welding equipment;
- b) radio and television transmitters and receivers;
- c) computer and other control equipment;
- d) safety critical equipment, e.g., guarding of industrial equipment;
- e) the health of the people around, e.g., the use of pacemakers and hearing aids;
- f) equipment used for calibration or measurement;
- g) the immunity of other equipment in the environment. The user shall ensure that other equipment being used in the environment is compatible. This may require additional protection measures;
- h) the time of day that welding or other activities are to be carried out.

3-1-96H

L10093

ELECTROMAGNETIC COMPATIBILITY (EMC)

The size of the surrounding area to be considered will depend on the structure of the building and other activities that are taking place. The surrounding area may extend beyond the boundaries of the premises.

Methods of Reducing Emissions

Mains Supply

Welding equipment should be connected to the mains supply according to the manufacturer's recommendations. If interference occurs, it may be necessary to take additional precautions such as filtering of the mains supply. Consideration should be given to shielding the supply cable of permanently installed welding equipment, in metallic conduit or equivalent. Shielding should be electrically continuous throughout its length. The shielding should be connected to the welding power source so that good electrical contact is maintained between the conduit and the welding power source enclosure.

Maintenance of the Welding Equipment

The welding equipment should be routinely maintained according to the manufacturer's recommendations. All access and service doors and covers should be closed and properly fastened when the welding equipment is in operation. The welding equipment should not be modified in any way except for those changes and adjustments covered in the manufacturer's instructions. In particular, the spark gaps of arc striking and stabilizing devices should be adjusted and maintained according to the manufacturer's recommendations.

Welding Cables

The welding cables should be kept as short as possible and should be positioned close together, running at or close to the floor level.

Equipotential Bonding

Bonding of all metallic components in the welding installation and adjacent to it should be considered. However, metallic components bonded to the work piece will increase the risk that the operator could receive a shock by touching these metallic components and the electrode at the same time. The operator should be insulated from all such bonded metallic components.

Earthing of the Workpiece

Where the workpiece is not bonded to earth for electrical safety, not connected to earth because of its size and position, e.g., ships hull or building steelwork, a connection bonding the workpiece to earth may reduce emissions in some, but not all instances. Care should be taken to prevent the earthing of the workpiece increasing the risk of injury to users, or damage to other electrical equipment. Where necessary, the connection of the workpiece to earth should be made by a direct connection to the workpiece, but in some countries where direct connection is not permitted, the bonding should be achieved by suitable capacitance, selected according to national regulations.

Screening and Shielding

Selective screening and shielding of other cables and equipment in the surrounding area may alleviate problems of interference. Screening of the entire welding installation may be considered for special applications.¹

¹ Portions of the preceding text are contained in EN50199: "Electromagnetic Compatibility (EMC) product standard for arc welding equipment."

Thank You

for selecting a **QUALITY** product by Lincoln Electric. We want you to take pride in operating this Lincoln Electric Company product ... as much pride as we have in bringing this product to you!

Please Examine Carton and Equipment For Damage Immediately

When this equipment is shipped, title passes to the purchaser upon receipt by the carrier. Consequently, Claims for material damaged in shipment must be made by the purchaser against the transportation company at the time the shipment is received.

Please record your equipment identification information below for future reference. This information can be found on your machine nameplate.

Product _____

Model Number _____

Code Number or Date Code _____

Serial Number _____

Date Purchased _____

Where Purchased _____

Whenever you request replacement parts or information on this equipment, always supply the information you have recorded above. The code number is especially important when identifying the correct replacement parts.

On-Line Product Registration

- Register your machine with Lincoln Electric either via fax or over the Internet.
- For faxing: Complete the form on the back of the warranty statement included in the literature packet accompanying this machine and fax the form per the instructions printed on it.
- For On-Line Registration: Go to our **WEB SITE at www.lincolnelectric.com**. Choose "Quick Links" and then "Product Registration". Please complete the form and submit your registration.

Read this Operators Manual completely before attempting to use this equipment. Save this manual and keep it handy for quick reference. Pay particular attention to the safety instructions we have provided for your protection. The level of seriousness to be applied to each is explained below:

⚠ WARNING

This statement appears where the information **must** be followed **exactly** to avoid **serious personal injury or loss of life**.

⚠ CAUTION

This statement appears where the information **must** be followed to avoid **minor personal injury or damage to this equipment**.

Installation	Section A
Technical Specifications	A-1, A-2
Safety Precautions	A-3
Select Suitable Location.....	A-3
Grinding.....	A-3
Stacking	A-3
Tilting.....	A-3
Lifting and Moving	A-3
Tilting.....	A-3
Environmental Rating.....	A-3
Machine Grounding and High Frequency Interference Protection.....	A-3, A-4
Input Connections	A-4
Input Reconnect Procedure	A-5
Output Connections.....	A-5
Connections For Tig (GTAW) Welding.....	A-5
Tig Torch Connections	A-5
Work Cable Connections	A-5
Shielding Gas Connection.....	A-6
Remote Control Connection.....	A-6
Connections For Stick (SMAW) Welding	A-6
Stick Electrode Cable and Work Cable Connection.....	A-6
<hr/>	
Operation	Section B
Safety Precautions	B-1
Graphic Symbols	B-1
Product Description	B-1
Recommended Processes and Equipment	B-2
Recommended Processes.....	B-2
Process Limitations	B-2
Recommended Equipment/Interface.....	B-2
Equipment Limitations.....	B-2
Welding Capability.....	B-2
Controls and Settings	B-3, B-4
Operating Steps	B-4
Welding in TIG Mode	B-4
Pulse TIG Mode	B-4
Remote Control Operation	B-5
Benefits of the Precision TIG 185	B-5
Welding in Stick Mode.....	B-6
<hr/>	
Accessories	Section C
Factory Installed Options.....	C-1
Field Installed Options.....	C-1
<hr/>	
Maintenance	Section D
Safety Precautions	D-1
Routine and Periodic Maintenance.....	D-1
<hr/>	
Troubleshooting	Section E
Safety Precautions.....	E-1
How to Use Troubleshooting Guide.....	E-1
Troubleshooting	E-2 THRU E-7
<hr/>	
Diagrams	Section F
Wiring Diagram	F-1
Dimension Print.....	F-2
<hr/>	
Parts List	P499,P210,P66

TECHNICAL SPECIFICATIONS - PRECISION TIG 185 (K2345-1AND K2347-1,-2)

INPUT - SINGLE PHASE ONLY		
<u>Standard Voltage</u> 208/230/1/60		<u>Input Current at Rated Output</u> 35A / 32A Effective and 70A / 64A Maximum
OUTPUT RANGE		
<u>Output Current Range</u> 7-185 Amps (AC) 5-185 Amps (DC)	<u>Maximum Open Circuit Voltage</u> (STICK AND TIG) AC OCV: 75 DC OCV: 59	<u>Type of Output</u> CC (Constant Current) AC/DC
RATED OUTPUT		
<u>Duty Cycle</u> GTAW 15% Duty Cycle 100% Duty Cycle SMAW 15% Duty Cycle 100% Duty Cycle	<u>Amps</u> 185A AC/DC 90A AC/DC (BAL) 70A AC (AUTO-BAL) 185A AC/DC125 90A AC/DC	<u>Volts at Rated Amperes</u> 15.2 V AC/DC 14.1 V AC/DC 13.8 V AC/DC 27.4 V AC/DC 23.6 V AC/DC

Chart gives max. rated Output Amps @% Duty Cycle (Based on a 10 minute cycle)
(Example; 110A@60% for AC/DC Stick and Balance TIG)

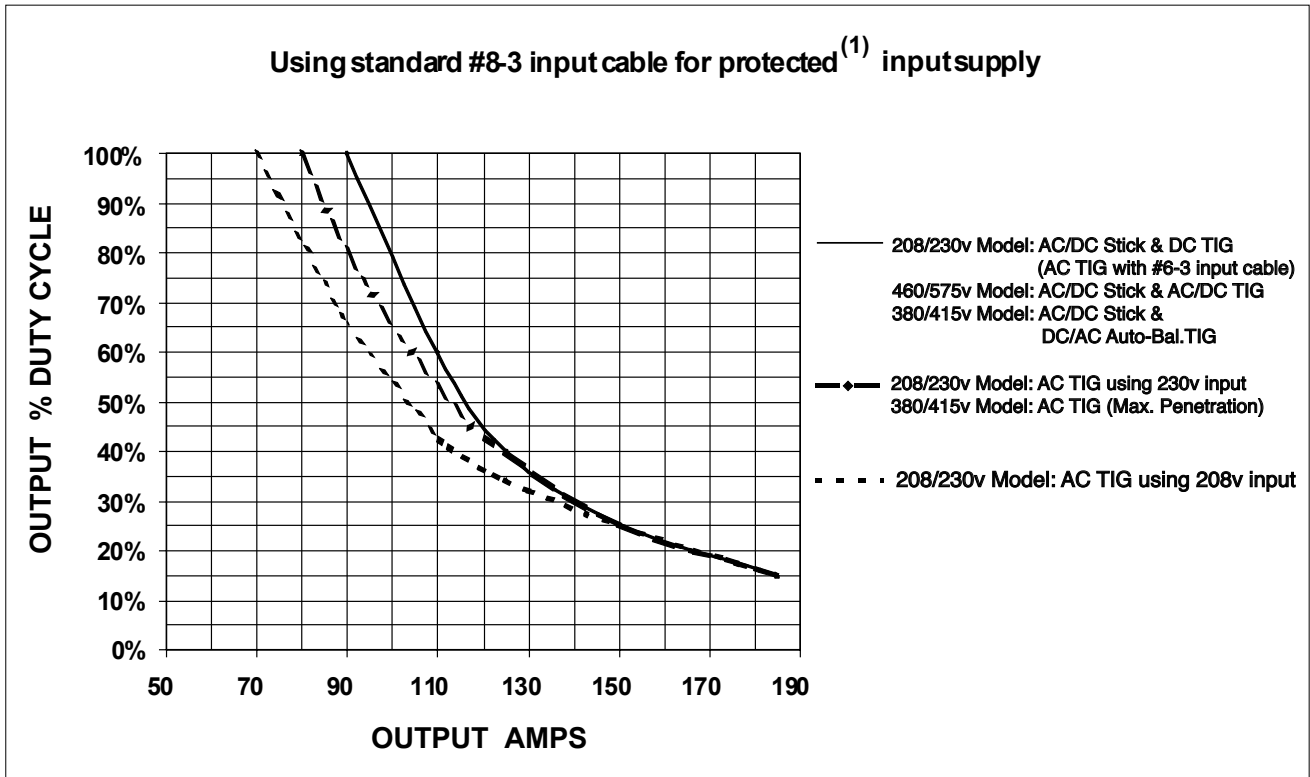



⁽¹⁾ Wiring and protection based on the 2002 U.S. National Electric Code:
Use a Super Lag type fuse or circuit breaker with a delay in tripping action.
Models with NEMA 6-50P plug may be used with a 50 amp protected 6-50R receptacle, or with a maximum 70 amp protected 6-50R receptacle if dedicated for the welder.

PRECISION TIG 185



TECHNICAL SPECIFICATIONS - CANADIAN (K2345-2), INTERNATIONAL K2346-1)

K2345-2 INPUT (at Rated Output)			
<u>Voltage/Phase/Freq.</u> 460/575/1/60 	<u>Current</u> 16 A/13 A Effective 32 A/26 A Max.	<u>Power Factor</u> 0.62 Min.	<u>Idle Current</u> 1.3 A/1.0 A Max.
K2346-1 INPUT (at Rated Output)			
<u>Voltage/Phase/Freq.</u> 380/400-415/1/50/60 	<u>Current</u> 19 A/18 A Effective 39 A/37 A Max.	<u>Power Factor</u> 0.62 Min.	<u>Idle Current</u> 1.3 A/1.0 A Max.
OUTPUT RANGE			
<u>Max. OCV.</u> 74 V (AC) 59 V (DC)	<u>Weld Current</u> 7-185 A (AC) 5-185 A (DC).	<u>Output Type</u> CC (Constant Current) AC or DC	
RATED OUTPUT			
<u>Process Duty Cycle*</u> SMAW 15% 100% GTAW 15% 100%	<u>Weld Current</u> 185 A AC/DC 90 A AC/DC 185 A AC/DC 90 A AC/DC (Auto-Bal.)	<u>Weld Voltage (NEMA)</u> 27.4 V 23.6 V 15.2 V 14.1 V	

* Based on a 10 minute cycle.

PHYSICAL DIMENSIONS⁽²⁾				
MODEL	HEIGHT	WIDTH	DEPTH	WEIGHT
Machine Only (K2345-1,-2) (K2346-1)	20.71 in. 526 mm	14.48 in. 368 mm	25.62 in. 751 mm	Approx. 192 lbs. 87.1 kgs
Ready-Pak (K2347-1)	20.71 in. 526 mm	14.48 in. 368 mm	25.62 in. 651 mm	Approx. 212lbs.. 96.2 kgs.
Ready-PakW/Cart (K2347-2)	31.24 in. 794 mm	19.81 in. 503 mm	38.01 in. 966 mm	Approx. 258lbs. 117.0 kgs.

⁽²⁾ Dimensions are without Lift Eyebolt and Torch Holder

PRECISION TIG 185



SAFETY PRECAUTIONS

Read entire installation section before starting installation.

⚠ WARNING



ELECTRIC SHOCK can kill.

- Only qualified personnel should perform this installation.
- Turn the input power OFF at the disconnect switch or fuse box before working on this equipment.

- Do not touch electrically hot parts.
- Always connect the PRECISION TIG 185 to a power supply grounded per the National Electrical Code and any local codes.

SELECT SUITABLE LOCATION

Place the welder where clean cooling air can freely circulate in and out through the rear louvers. Dirt, dust or any foreign material that can be drawn into the welder should be kept at a minimum. Failure to observe these precautions can result in excessive operating temperatures and nuisance shut-downs.

GRINDING

Do not direct grinding particles towards the welder. An abundance of conductive material can cause maintenance problems.

STACKING

PRECISION TIG 185 **cannot** be stacked.

LIFTING AND MOVING

The PRECISION TIG 185 models are provided with an Eyebolt used for lifting the unit with a hoist. To install; remove the plug button from the case top and screw the Eyebolt securely into the threaded bracket beneath the case top per the below instructions and warnings provided on the case top decal. Save the removed plug button (LE part No.T10397-2) to cover the hole when the lift Eyebolt is removed.

⚠ WARNING



FALLING EQUIPMENT

can cause injury.

- Lift only with equipment of adequate lifting capacity.
- Be sure machine is stable when lifting.

- Use only Lincoln provided T4550-5 1/2-13 x 1.00 eyebolt.
- Fully engage threads and torque eyebolt to 38 ft. lbs.
- Re-torque eyebolt to 38 ft. lbs. before each lift.
- Lift only with equipment of adequate lifting capacity.
- Never lift welder with gas cylinder attached.
- Never lift welder above personnel.

An undercarriage, provided on the Ready-Pak w/Cart model, is also available to easily move the the unit. Refer to the Accessories section of this manual.

Do not attempt to lift the power source with an undercarriage attached.

The undercarriage is designed for hand moving only; mechanized movement can lead to personal injury and/or damage to the PRECISION TIG 185.

TILTING

Each machine must be placed on a secure, level surface, either directly or on a recommended undercarriage. The machine may topple over if this procedure is not followed.

ENVIRONMENTAL RATING

The PRECISION TIG 185 power source carries an IP21 environmental rating. It may be used in normal industrial and commercial environments. Avoid using it in environments which have falling water such as rain.

Read and follow "Electric Shock Warnings" in the Safety section if welding must be performed under electrically hazardous conditions such as welding in wet areas or on or in the workpiece.

MACHINE GROUNDING AND HIGH FREQUENCY INTERFERENCE PROTECTION

This welder must be grounded! See your local and national electrical codes for proper grounding methods.

PRECISION TIG 185



The high frequency generator, being similar to a radio transmitter, may cause radio, TV and electronic equipment interference problems. These problems may be the result of radiated interference. Proper grounding methods can reduce or eliminate radiated interference.

Radiated interference can develop in the following four ways:

1. Direct interference radiated from the welder.
2. Direct interference radiated from the welding leads.
3. Direct interference radiated from feedback into the power lines.
4. Interference from re-radiation of "pickup" by ungrounded metallic objects.

Keeping these contributing factors in mind, installing equipment per the following instructions should minimize problems.

1. Keep the welder power supply lines as short as possible. Input leads within 50 feet (15.2m) of the welder should be enclosed in rigid metallic conduit or equivalent shielding. There should be good electrical contact between this conduit and the welder case ground. Both ends of the conduit should be connected to a driven ground and the entire length should be continuous.
2. Keep the work and electrode leads as short as possible and as close together as possible. Lengths should not exceed 25 ft (7.6m). Tape the leads together when practical.
3. Be sure the torch and work cable rubber coverings are free of cuts and cracks that allow high frequency leakage.
4. Keep the torch in good repair and all connections tight to reduce high frequency leakage.
5. The work piece must be connected to an earth ground close to the work clamp, using one of the following methods:
 - a) A metal underground water pipe in direct contact with the earth for ten feet or more.
 - b) A 3/4" (19mm) galvanized pipe or a 5/8" (16mm) solid galvanized iron, steel or copper rod driven at least eight feet into the ground.

The ground should be securely made and the grounding cable should be as short as possible using cable of the same size as the work cable, or larger. Grounding to the building frame electrical conduit or along pipe system can result in re-radiation, effectively making these members radiating antennas.

6. Keep cover and all screws securely in place.
7. Electrical conductors within 50 ft (15.2m) of the welder should be enclosed in grounded rigid metallic conduit or equivalent shielding, wherever possible. Flexible metallic conduit is generally not suitable.
8. When the welder is enclosed in a metal building, the metal building should be connected to several good earth driven electrical grounds (as in 5 (b) above) around the periphery of the building.

Failure to observe these recommended installation procedures can cause radio or TV and electronic equipment interference problems and result in unsatisfactory welding performance resulting from lost high frequency power.

INPUT CONNECTIONS

Be sure the voltage, phase, and frequency of the input power is as specified on the rating plate, located on the rear of the machine.

208/230 volt models have a NEMA 6-50P plug attached to the #8-3 input power cord and a NEMA 6-50R receptacle is included with the Ready-Pak models. Other voltage models have an input power cord but no plug or receptacle.

Have a qualified electrician provide input power supply to the receptacle or cord in accordance with all local and national electrical codes. Use a single phase line or one phase of a two or three phase line. Choose an input and grounding wire size according to local or national codes. Refer to the **Technical Specifications** page at the beginning of this section. Fuse the input circuit with the recommended super lag fuses or delay type¹ circuit breakers. Using fuses or circuit breakers smaller than recommended may result in "nuisance" shut-offs from welder inrush currents even if not welding at high currents.

¹Also called "inverse time" or "thermal/magnetic" circuit breakers; circuit breakers which have a delay in tripping action that decreases as the magnitude of the current increases.

INPUT RECONNECT PROCEDURE

On multiple input voltage welders, be sure the machine is connected per the following instructions for the voltage being supplied to the welder.

CAUTION

Failure to follow these instructions can cause immediate failure of components within the welder and void machine's warranty.

Multiple voltage models are shipped connected for the highest voltage. To change this connection refer to the following instructions.

WARNING



ELECTRIC SHOCK can kill.

- Turn the input power OFF at the disconnect switch or fuse box before working on this equipment.

For the lowest rated voltage connection (Refer to figure A.1):

1. Remove the sheet metal left side cover.
2. Disconnect lead H3 from the power switch and insulate with the insulation from the H2 lead.
3. Connect lead H2 to the power switch where H3 was connected.
4. Tighten connections.
5. Replace sheet metal cover and all screws

For the highest rated voltage connection (Refer to figure A.1):

The machine is normally shipped connected for the highest rated voltage, however verify the following:

1. Remove the sheet metal left side cover.
2. Disconnect lead H2 from the power switch and insulate with the insulation from the H3 lead.
3. Connect lead H3 to the line switch where H2 was connected.
4. Tighten connections.
5. Replace sheet metal cover and all screws.

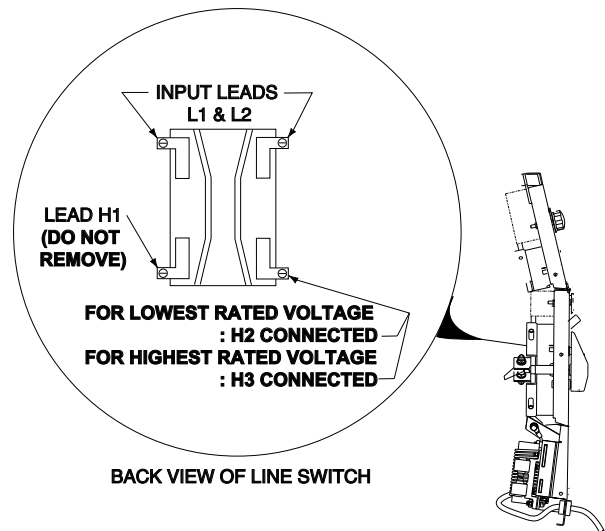

FIGURE A.1 Reconnect Leads

OUTPUT CONNECTIONS

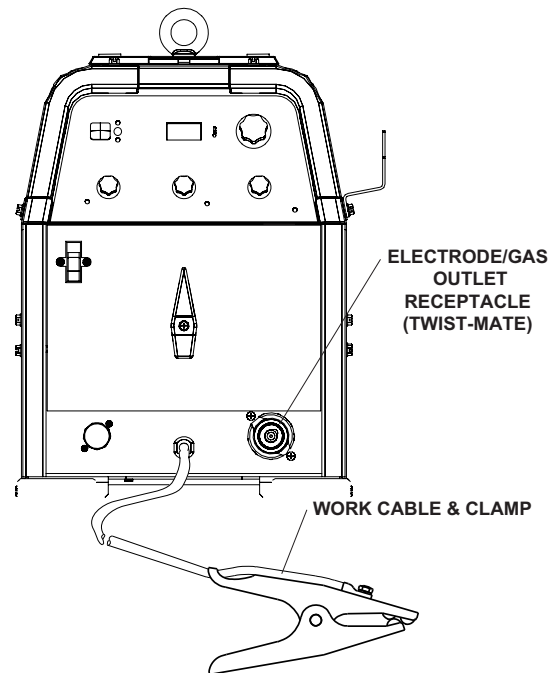

FIGURE A.2 Location of Output Connections

CONNECTIONS FOR TIG (GTAW) WELDING

TIG TORCH CONNECTION

Refer to **Included Equipment** in the Operation Section of this manual for TIG welding equipment which is included with the PRECISION TIG 185.

A PTA-17 Twist-Mate TIG welding torch with cable and connector is supplied with the Ready-Pak Models and available for other models (See Accessories Section). Turn the Power Switch "OFF". Connect the torch cable Twist-Mate quick connect plug into the Electrode/Gas Output Receptacle on the front of the welder and turn it clockwise until it is tight. This is a Twist-Mate quick connect terminal and also provides the gas connection for the shielding gas to the torch.

⚠ WARNING

To avoid receiving a high frequency shock, keep the TIG torch and cables in good condition.

WORK CABLE CONNECTION

A work cable with attached work clamp is factory connected to the PRECISION TIG 185. To minimize high frequency interference, refer to **Machine Grounding and High Frequency Interference Protection** section of this manual for the proper procedure on grounding the work clamp and work piece.

SHIELDING GAS CONNECTION

An adjustable gas pressure regulator with flow gage and hose is supplied with the PRECISION TIG 185 Ready-Pak Models and available separately for other models (See Accessories Section). Obtain the necessary inert shielding gas (usually argon). Connect the cylinder of gas with the pressure regulator and flow gage. Install the gas hose between the regulator and gas inlet (located on the rear of the welder). The gas inlet has a 5/16-18 right hand female thread; CGA#032.

The available Under-Storage Cart features a low platform that simplifies loading and unloading of gas cylinders.

⚠ WARNING



CYLINDER could explode if damaged.

- Keep cylinder upright and chained to a support.
- Keep cylinder away from areas where it could be damaged.
- Never allow the torch to touch the cylinder.
- Keep cylinder away from live electrical circuits.
- Maximum inlet pressure 150 psi.

A cylinder is loaded by leaning it slightly sideways and rocking it up on the platform, being careful not to allow the Under-Storage Cart to roll. **Secure the cylinder in place with the provided chain.** Unload by following these steps in reverse.

REMOTE CONTROL CONNECTION

A remote control receptacle is provided on the case front of the welder for connecting a remote control to the machine. A Foot Amptrol™, foot activated remote control, is included with the PRECISION TIG 185 Ready-Pak models and available separately for other models. Refer to the Optional Accessories section of this manual for other available remote controls.

CONNECTIONS FOR STICK (SMAW) WELDING

STICK ELECTRODE CABLE AND WORK CABLE CONNECTION

Refer to Field Installed Options in Accessories Section of this manual for STICK welding equipment which is available for use with the PRECISION TIG 185. An electrode holder with Twist-Mate cable and Twist-Mate connector are available separately for use with the PRECISION TIG 185. (See Accessories Section). Turn the Power Switch "OFF". Connect the Twist-Mate quick connect plug into the Electrode/Gas Output Receptacle and turn it clockwise until it is tight. The work cable and work clamp are factory connected.

SAFETY PRECAUTIONS

Read and understand this entire section before operating the machine.

WARNING



ELECTRIC SHOCK

can kill.

- Do not touch electrically live parts or electrode with skin or wet clothing.
- Insulate yourself from work and ground.
- Always wear dry insulating gloves.
- Read and follow "Electric Shock Warnings" in the Safety section if welding must be performed under electrically hazardous conditions such as welding in wet areas or on or in the workpiece.



FUMES AND GASES

can be dangerous.

- Keep your head out of fumes.
- Use ventilation or exhaust at the arc, or both, to remove fumes and gases from breathing zone and general area.

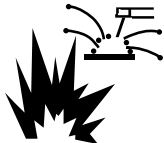

WELDING SPARKS can cause fire or explosion

- Keep flammable material away.
- Do not weld on containers that have held combustibles.



ARC RAYS can burn.

- Wear eye, ear and body protection.

Observe additional Safety Guidelines detailed in the beginning of this manual.

GRAPHIC SYMBOLS THAT APPEAR ON THIS MACHINE OR IN THIS MANUAL



INPUT POWER

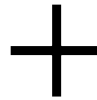

POSITIVE OUTPUT



NEGATIVE OUTPUT



DIRECT CURRENT



PROTECTIVE GROUND



WARNING OR CAUTION

DO NOT SWITCH WHILE WELDING

PRODUCT DESCRIPTION

The PRECISION TIG 185 is a member of our field acclaimed Precision TIG family of industrial arc welding power sources. Premium features include:

1. Precise constant current output.
2. Full range square wave AC/DC TIG (GTAW) welding.
3. Enhanced version of the patented Micro-Start™ Technology for its lower Minimum (5 amps) to higher Maximum (185 amps) output control range.
4. Built-in high frequency stabilization for DC TIG starting and continuous AC TIG welding.
5. AC/DC Stick (SMAW capability.) A new undercarriage (with gas bottle rack) is available for field installation, or is included with an available Ready-Pak TIG Welding Package. The Precision TIG patented convenient built-in storage provisions for welding components and cable management.

The PRECISION TIG 185 also provides advanced features such as:

- Digital Meter
- Presettable control, adjustable Auto Balance™
- Fan As Needed (F.A.N.)
- Timers for fixed Preflow and variable Postflow shielding gas.
- Built-in, easy to set single knob Pulse TIG control with a "blinking" light to indicate the pulse frequency setting.
- Auto-Sense remote control selection.
- Tool-less Twist-Mate electrode cable connection.
- Built-in work clamp cable permanently attached.

Four models are available for 60Hz. with Domestic and Canadian input voltages, as well as an International model with 50/60Hz voltages.

RECOMMENDED PROCESSES AND EQUIPMENT

RECOMMENDED PROCESSES

The PRECISION TIG 185 is recommended for the TIG (GTAW) and Stick (SMAW) welding processes within its output capacity range of 5 amps DC, or 7 amps AC, to 185 amps AC/DC. It is compatible with most Magnum TIG accessories, as well as many industry standard items, such as TIG torches (adapted for Twist-Mate), hoses, and water coolers.

PROCESS LIMITATIONS

The PRECISION TIG machines are not recommended for arc gouging due to its limited output capacity, and are also not recommended for pipe thawing.

RECOMMENDED EQUIPMENT/INTERFACE

(See Installed Options in Accessories Section for more details)

The PRECISION TIG 185 will be available as a basic Machine (Only) and in two Factory-Configured Welding Packages:

1. Machine(Only) (K2345-1)
2. Ready-Pak (K2347-1)
3. Ready-Pak w/Cart (K2347-2)

Basic module will also be available as with Domestic, Canadian and International input voltages for user configuration, with optional accessories.

Select Machine	208/230/1/60 Machine with 6 NEMA 6-50P Plug Cable and Receptacle (K2345-1) 460/575/1/60 Machine only with cable (K2345-2) 380/400/415/1/50/60 Machine only with cable (K2346-1)	
Torch Starter Kit (Select one)	Air Cooled System: TIG-Mate Torch Starter Kit*	Water Cooled System: TIG-Mate 20 Torch Starter Kit*
Water Cooler	Not Applicable	115V 50/60Hz Cool-Arc 40*
Under-Storage Cart (Optional)	K2348-(*)	
Optional Remote Trigger Device (Select one)	Arc Start Switch* Foot Amptrol* Start Pedal Foot Amptrol* Hand Amptrol*	

*For "Part Numbers" or "K Numbers" see Accessories Section.

EQUIPMENT LIMITATIONS

The PRECISION TIG machines are protected from over loads beyond the output ratings and duty cycles, per the Specifications in the Installation Section, with Thermostat protection of the output power coils and rectifiers.

The PRECISION TIG 185 machine uses Twist-Mate output terminals, therefore stud connection adapters (such as LECO. S19257-series) cannot be used for torch connection.

If a PRECISION Tig 185 is powered from an engine generator which doesn't have sufficient capacity, the AC Balance control and the Output control will not provide full range of control.

WELDING CAPABILITY(Duty Cycle)

The PRECISION TIG 185 is rated at 185 amps, 27 volts, at 15% duty cycle on a ten minute basis. It is capable of higher duty cycles at lower output currents. See rated output graph, on specification sheet located in the Installation Section. If the duty cycle is exceeded, a thermal protector will shut off the output until the machine cools.

PRECISION TIG 185



CONTROLS AND SETTINGS

All operator controls and adjustments are located on the front of the PRECISION TIG 185. Refer to Figure B.1 and corresponding explanations.

FIGURE B.1 - CONTROL PANEL

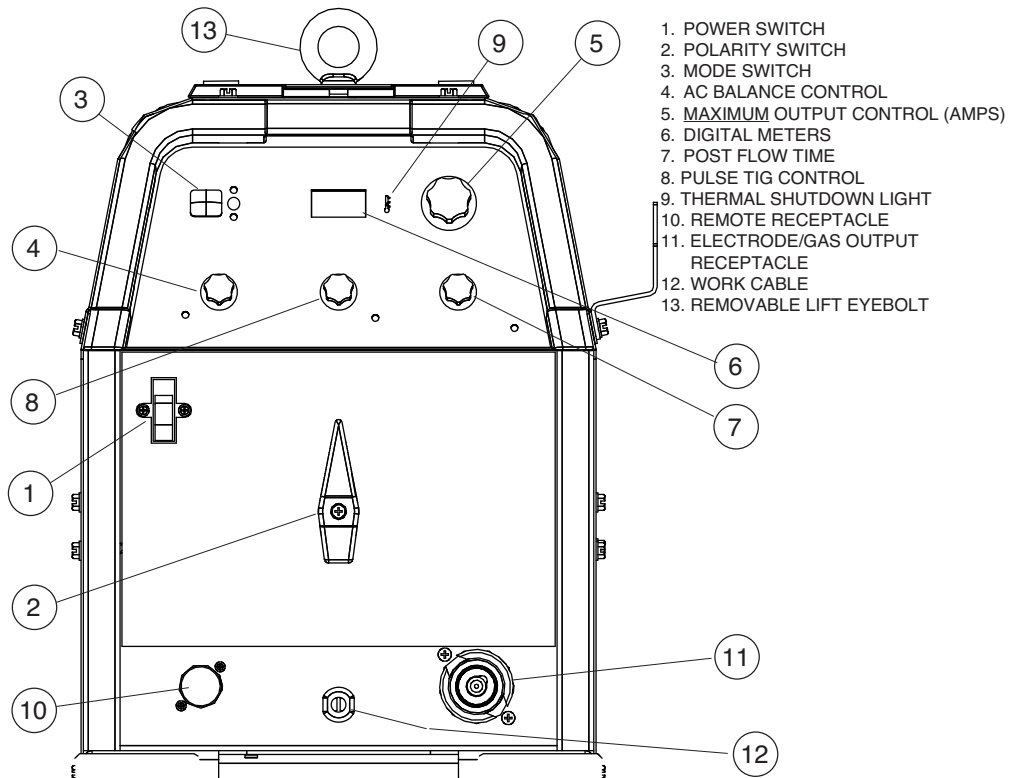

1. POWER SWITCH
2. POLARITY SWITCH
3. MODE SWITCH
4. AC BALANCE CONTROL
5. MAXIMUM OUTPUT CONTROL (AMPS)
6. DIGITAL METERS
7. POST FLOW TIME
8. PULSE TIG CONTROL
9. THERMAL SHUTDOWN LIGHT
10. REMOTE RECEPTACLE
11. ELECTRODE/GAS OUTPUT RECEPTACLE
12. WORK CABLE
13. REMOVABLE LIFT EYEBOLT

CONTROL FUNCTIONALITY

- 1. POWER SWITCH** – Input line switch turns input power ON or OFF, as indicated by the on or off status of the front panel digital display (See Item 6).
- 2. POLARITY SWITCH** – The rotary power switch has 3-positions for DC+, AC and DC- selections for the electrode output stud welding polarity.

CAUTION



• Do not switch the polarity switch while welding or damage may result to the machine.

- 3. MODE SWITCH** – The push button switch allows selection of the two machine welding modes as indicated by colored mode lights:
 - STICK mode – Top position Red light.
 - TIG mode – Bottom position Green light.
- 4. AC BALANCE CONTROL** – The AC Balance Control permits adjustment of the AC TIG wave balance adjustment from Max. Penetration (80% negative wave) at full CW rotation setting, to Max. Cleaning (60% positive wave) at CCW rotation, and includes:
 - Auto Balance position indicated by the Green panel light turning on.

This setting position feature automatically provides the proper amount of cleaning and penetration for normal AC TIG welding.

- 5. MAXIMUM OUTPUT CONTROL** – Presets the output welding current over the rated output range of the machine:
 - With a Remote Current Control (Amptron) connected to the Remote Receptacle (See item 10), this knob sets the Maximum output current level set table with the remote Amptron.
 - For Pulse TIG (See Item 8) this knob sets the Peak Pulse level, with the Remote Amptron (if used).

- 6. DIGITAL METER** – A 3 digit LED meter is used to display the preset output current level before welding, and actual output level while welding:
 - A lit display indicates input power is turned on. (See Item 1.)

- 7. POST FLOW TIME** – Sets the TIG mode shielding gas post flow time over the range of about 1 to 30 seconds after the arc is shut off.

Note: Gas preflow time is fixed at 0.5 second only in TIG mode, but no preflow time will occur if the arc is restarted during Post Flow time, since shielding gas would not have stopped flowing.

PRECISION TIG 185



8. PULSE TIG CONTROL – The Pulse TIG feature built into the Precision TIG 185 is simplified to be a single knob control which sets the Pulse Frequency over the peak pulses/sec. range of about 0.1 to 20 pulses per second:

- Full CCW (min.) setting of the control knob shuts off Pulse TIG (0.0 pps).
- Peak Pulse level is set by the Max. Output Control and the Remote Amptrol (if used).
- Background Current level is typically optimized at a fixed 50% of Peak Pulse level setting.
- Peak Pulse % On-time is typically optimized at a fixed 50%.

A Green light "blinks" with each Peak Pulse to indicate the Pulse TIG Control setting before and during welding.

9. OVER TEMPERATURE LIGHT -  If the welder overheats due to blocked air flow, high ambient air temperature, or exceeded duty cycle, an internal thermostat will open disabling the welding output and this yellow light will illuminate. The cooling fans will continue to run to cool the unit during this time. The light will go out when the unit cools and the thermostat resets. Once the light goes out, the machine will again become available to weld.

10. REMOTE RECEPTACLE – Provides for connection of remote control and/or arc start switch only in TIG Mode: (There is no remote output control capability when stick welding.

- Plugging a remote current control (Amptrol) into this receptacle automatically switches the output control from the panel Max Output Control (See Item 5) to the remote control.
- The connected remote control will then control the output current between the Min. range of the machine and the setting of the panel Max Output Control.
- Switching Mode Switch (See Item 3) to Stick will automatically disable the connected remote control and switch the output control back to the Max Output panel control.

11. ELECTRODE/GAS OUTPUT RECEPTACLE - This quick connect Twist-Mate receptacle provides electrical connection to the electrode holder and cable for Stick welding and a combined electrical and gas connection for the TIG torch when TIG welding.

12. WORK CABLE - This work cable is factory connected to the welder and is connected to the work piece to complete the welding circuit. Refer to **Machine Grounding and High Frequency Interference Protection** in the Installation section of this manual for the proper procedure on grounding the work clamp and work piece to minimize high frequency interference.

OPERATING STEPS

WELDING IN TIG MODE

1. Connect the TIG torch and cable Twist-Mate quick connect plug to the Electrode/Gas output receptacle. This receptacle also contains an integral gas connection for the torch. Connect the work clamp to the work piece.
2. Set the TIG/STICK switch to "TIG".
3. Set the Polarity Switch to DC- for welding steel or stainless steel; or to AC for welding aluminum.
4. Connect the Foot Amptrol to the Remote Control Connector.
5. Turn on the cylinder gas valve and adjust the flow regulator to obtain desired flow.
6. Turn the power switch to "ON". **NOTE:** There will be a 15 second gas flow when the power is turned on.
7. Preset the Output Control on the control panel to the maximum desired amps, as read on the digital meter.
8. Depress the Foot Amptrol to energize the torch and establish an an arc with the work piece. The digital meter reads the actual amps while welding.

NOTE: When the TIG/STICK switch is set to "TIG", depressing the remote control will start a 0.5 second gas pre-flow before energizing the TIG torch. When the remote control is released the TIG torch is de-energized and gas flow will continue for the time set by the Post Flow Time control. When the polarity switch is set to DC, the TIG Arc Starter will turn on and off automatically to start and stabilize the arc. In AC the TIG Arc Starter will turn on with the output and remain on continuously until the remote control is released.

PULSE TIG CONTROL

Use this knob to set the frequency or the number of pulses per second(pps), from 0.1pps to 20pps.

- This setting adjusts heat output and bead shape for travel speed. Thinner plate that is welded with faster travel speed will require higher frequency than thicker plate with slower travel speed. 2-3pps is a typical starting point.

PRECISION TIG 185



REMOTE CONTROL OPERATION

A Foot Amptrol™ is included with the PRECISION TIG 185 Ready-Pak models and available for other models (See Accessories Section) for remote current control while TIG welding. An optional Hand Amptrol may also be used. An optional Arc Start Switch may be used to start and stop the welding if no remote control of the current is desired. Refer to the Accessories Section of this manual.

Both the Hand and Foot Amptrol work in a similar manner. For simplicity, the following explanation will refer only to "Amptrols", meaning both Foot and Hand models. The term "minimum" refers to a foot pedal in the "up" position, as it would be with no foot pressure, or a Hand Amptrol in the relaxed position, with no thumb pressure.

"Maximum" refers to a fully depressed Foot Amptrol, or a fully extended Hand Amptrol.

When the welder is in TIG modes activating the Amptrol energizes the electrode terminal and varies the output welding current from its minimum value of 5 Amp (DC) or 7 Amp (AC), to the maximum value set by the Current Control on the control panel. This helps eliminate accidental high current damage to the work piece and/or tungsten, and provides a fine control of the current. When the welder is in the stick mode a remote control has no effect and is not used.

It is important to note that, in some cases, the tungsten will not start an arc at the minimum current because the tungsten may be too large or cold. To start an arc reliably, it is important to depress the Amptrol far enough so that the machine output current is near the tungsten operating range. For example, a 3/32" tungsten may be used on DC- to weld over the full range of the machine.

To start the arc, the operator may have to turn the current control up and depress the Amptrol approximately 1/4 of the way down. Depressing the Amptrol to its minimum position may not start the arc. Also if the current control is set too low, the arc may not start. In most cases, a large or cold tungsten will not readily establish an arc at low currents. This is normal. In Direct Current mode the PRECISION TIG 185 will start a 3/32", 2% thoriated tungsten electrode at 15 amperes provided the electrode tip is properly grounded and not contaminated.

BENEFITS OF THE PRECISION TIG 185 DESIGN

In AC TIG welding of aluminum, the positive portion of the AC wave provides cleaning (removal of aluminum oxide) of the work piece. This is desirable on materials with a heavy oxide coating. However the positive portion may also cause the electrode to overheat at high currents causing "tungsten spitting". The negative portion of the AC wave offers no cleaning action but concentrates more heat on the work.

The AC waveform of the PRECISION TIG 185 optimizes cleaning and heating of the work. The result is the capability to weld through the complete range in AC TIG or DC- TIG requiring only one electrode, a 3/32" 2% thoriated tungsten.

WELDING IN STICK MODE

1. Put the electrode holder and cable quick connect plug into the electrode output receptacle. Turn clockwise until tight. Connect the work clamp to the work piece.
2. Set the TIG/STICK switch to "STICK".
3. Set the Polarity Switch to the weld mode desired for the type of electrode being used (most commonly DC+).
4. Place the electrode in the electrode holder.

5. Turn the power switch to "ON".
6. Adjust the Current Control to the desired amps.
7. Strike an arc and weld.

NOTE: When the TIG/STICK switch is set to "STICK" the output is always on when the power switch is on. A remote control has no effect on the welding current and the gas flow and high frequency TIG arc starter are disabled.

⚠ WARNING



• In Stick Mode the output terminal and electrode will be electrically hot whenever the power switch is turned on.

RECOMMENDED ELECTRODE AMPERAGE RANGES - PRECISION TIG 185

The PRECISION TIG 185 is rated from 5-185 Amps.

SMAW Process

ELECTRODE TYPE	POLARITY	Welding Amp Range for Stick Electrode Size		
		3/32"	1/8"	5/32"
Fleetweld 5P, Fleetweld 5P+ E6010	DC+	40 - 70	75 - 130	90 - 175
Fleetweld 180 E6011	DC+	40 - 80	55 - 110	105 - 135
Fleetweld 37 E6013	DC+	70 - 95	100 - 135	145 - 180
Fleetweld 47 E7014	DC-	75 - 95	100 - 145	135 - 200
Excalibur E7018	DC+	85 - 110	110 - 160	130 - 200
Blue Max Stainless	DC+	40 - 80	75 - 110	95 - 150
Red Baron Stainless	DC+	40 - 70	60 - 100	90 - 140

Mild steel procedures are based on recommended procedures listed in C2.10 8/94 and the maximum rating of the PRECISION TIG 185
 Blue Max procedures are based on C6.1 6/95
 Red Baron Procedure are based on ES-503 10/93

GTAW Process

Electrode Polarity	DC-	AC		Approximate Argon Gas Flow Rate C.F.H. (l/min.)	
	Electrode Tip Preparation	Balled			
Electrode Type	Sharpened				
Tungsten Size (in.)	EWTh-1, EWCe-2 EWTh-2, EWLa-1 EWG	EWP	EWZr EWTh-1, EWTh-2 EWCe-2, EWLa-1 EWG	Aluminum	Stainless Steel
.010	Up to 15 A.	Up to 10 A.	Up to 15 A.	3-8 (2-4)	3-8 (2-4)
.020	Up to 15 A.	Up to 15 A.	Up to 20 A.	5-10 (3-5)	5-10 (3-5)
.040	Up to 80 A.	Up to 40 A.	Up to 60 A.	5-10 (3-5)	5-10 (3-5)
1/16	Up to 150 A.	Up to 100 A.	Up to 130 A.	5-10 (3-5)	9-13 (4-6)
3/32	Up to MAX. A.	Up to 160 A.	Up to MAX. A.	13-17 (6-8)	11-15 (5-7)
1/8	X	Up to MAX. A.	X	15-23 (7-11)	11-15 (5-7)

Tungsten electrodes are classified as follows by the American Welding Society (AWS):
 PureEWPgreen TRI-MIX OF ELEMENTS.....EWG.....gray
 +1% ThoriaEWTh-1...yellow
 +2% ThoriaEWTh-2...red
 +2% Ceria.....EWCe-2...orange
 +1.5% LanthanaEWLa-1...black
 +0.15 to 0.40% Zirconia...EWZr.....brown

Ceriated Tungsten is now widely accepted as a substitute for 2% Thoriated Tungsten in AC and DC applications.

PRECISION TIG 185



FACTORY INSTALLED OPTIONS

The PRECISION TIG 185 will be available in two Factory-Configured Welding Packages:

1. Precision TIG 185 Ready-Pak (K2347-1)

- 208/230/1/60 Machine (K2345-1)
- 9 ft. (2.7m) Input Cable with NEMA 6-50P Plug*
- NEMA 6-50R Receptacle
- Integrated 10 ft.(3.1m)Work Lead w/Clamp*
- Gas Regulator with 10 ft.(3.1m). Hose
- PTA-17 12.5”(318mm) Ultra=Flex Torch with 3/32”(2.4mm)Electrode and Parts
- Foot Amptrol (K870)
- TIG Slide Rule (WC332)*
- GTAW Book (JFLF-834)*
- Lift Eyebolt*

2. PRECISION TIG 185 Ready-Pak w/Cart (K2347-2)

- 208/230/1/60 Machine (K2345-1)
- 9 ft.(2.7m) Input Cable with NEMA 6-50P Plug*
- NEMA 6-50R Receptacle
- Integrated 10 ft.(3.1m) Work Lead w/Clamp*
- Gas Regulator with 10 ft.(3.1m) Hose
- PTA-17 12.5 ft.(3.8m) One cable Superflex Torch with 3/32”(2.4mm) Electrode and Parts
- Foot Amptrol (K870)
- TIG Slide Rule (WC332)*
- GTAW Book (JFLF-834)*
- Lift Eyebolt*
- Under-Storage Cart (K2348-1)

* Included with K2345-1 Machine Only model.

The PRECISION TIG 185 will also be available as Basic models with Domestic input voltages for user-configuration with optional accessories: (See Table C.1)

TABLE C.1

Select Machine	208/230/1/60 Machine with 9 ft.(2.7m) NEMA 6-50P Plug Cable and Receptacle (K2345-1) 460/575/1/60 Machine only with Cable (K2345-2) 380/400-415/1/50-60 Machine only with Cable (K2346-1)	
Optional Torch Starter Kit (Select one)	Water Cooled System	Air Cooled System
	K2267-1 TIG-Mate 20 Torch Starter Kit Includes: • 200A PTW-20 12.5 ft.(3.81m) Torch • KP510 Parts Kit • Regulator & Hose • K1622-4 Twist Mate Torch Adapter • Water Hose & Hose Coupler • Work Cable & Clamp (Not required for Precision TIG 185)	K2266-1 TIG-Mate Torch Starter Kit Includes: • 150A PTA-17 12.5 ft.(3.81m) Torch. • KP508 Parts Kit. • Regulator & Hose. • K1622-1 Twist Mate Torch Adapter. • Work Cable & Clamp (Not required for Precision TIG 185)
Water Cooler	K1813-1 115V 50/60Hz Cool-Arc 40	Not Applicable
Optional Under-Storage Cart	K2348-1	
Optional Remote Trigger Device (Select one)	K814 Arc Start Switch K870 Foot Amptrol K870-1 Start Pedal Foot Amptrol K963-3 Hand Amptrol	

PRECISION TIG 185

FIELD INSTALLED OPTIONS

The following Options/Accessories are available for the PRECISION TIG 185:

- **K2348-1 Under-Storage Cart**

Includes a front magnetic latch storage drawer and rear storage bin on a single bottle undercarriage. (L12225 Installation Instructions included)

- **K870 Foot Amptrol**

Single pedal foot activation of arc start switch and output control, with 25 ft.(7.6m) plug cable.

- **K870-1 Start Pedal Foot Amptrol**

Independent start pedal on control pedal provides two-stage foot action to easily feel start switch closure at minimum output level for enhanced arc start and crater-fill control. Provided with adjustable, or removable, heel stop and 25 ft.(7.6m) plug cable.

- **K963-3 Hand Amptrol**

Fastens to torch for convenient thumb activation of arc start switch and output control, with 25 ft.(7.6m) plug cable:

- **K814 Arc Start Switch**

Needed for TIG welding without an Amptrol. Includes 25 ft.(7.6m) plug cable, and attaches to torch for convenient finger control.

- **TIG-Mate Torch Starter Kits:**

Includes Torch with Twist-Mate adapter and accessories listed below:

K2266-1 TIG-Mate Torch Starter Kit Includes:

- 150A PTA-17 12.5 ft.(3.8m) Torch
- KP508 Parts Kit
- Regulator & Hose
- K1622-1 Twist Mate Torch Adapter
- Work Cable & Clamp (Not required for PRECISION TIG 185)

K2267-1 TIG-Mate 20 Torch Starter Kit Includes:

- 200A PTW-20 12.5 ft.(3.8m) Torch
- KP510 Parts Kit
- Regulator & Hose
- K1622-4 Twist Mate Torch Adapter
- Water Hose & Hose Coupler
- Work Cable & Clamp
(Not required for PRECISION TIG 185)

- **Magnum “Pro-Torch™ TIG Torch”** assemblies and Accessories.

Requires Twist-Mate Adapter:

K1622-1 for PTA-9/-17

K1622-3 for PTA-26

K1622-4 for PTW water cooled torch

- **Harris #3100211 Harris Argon Flow Regulator**

(Includes 10 ft.(3.1m) hose.)

- **K2374-1 Electrode Holder and Cable**

200 amp Electrode Holder with 10 ft.(3.1m) cable and Twist-Mate connector.

SAFETY PRECAUTIONS

⚠ WARNING

ELECTRIC SHOCK can kill.

- Only qualified personnel should perform this maintenance.
- Turn the input power OFF at the disconnect switch or fuse box before working on this equipment.
- Do not touch electrically hot parts.

⚠ WARNING

To avoid receiving a high frequency shock, keep the TIG torch and cables in good condition.

ROUTINE AND PERIODIC MAINTENANCE

1. Disconnect power supply lines to machine before performing periodic maintenance.
2. Periodically clean the inside of the machine with a low pressure air system. Be sure to clean the following components thoroughly.
 - Main Transformer
 - Electrode/Gas Output Receptacle
 - Polarity Switch
 - Rectifier Assembly
 - Arc Starter/Spark Gap Assembly
 - PC Boards
 - Fan Blades
3. Inspect welder output and control cables for fraying, cuts, and bare spots.
4. Keep TIG torch and cables in good condition.
5. Clean air louvers to ensure proper air flow and cooling.
6. The fan motor has sealed ball bearings which require no maintenance.
7. **SPARK GAP ADJUSTMENT**

The spark gap .020(.5mm) is set at the factory to a gap of 0.015 inches (0.4mm) See Figure D.1. This setting is adequate for most applications. Where less high frequency is desired, the setting can be reduced to 0.015 inches (0.4mm).

⚠ WARNING

Use extreme caution when working with circuit of the high frequency. The high voltages developed can be lethal. Turn the input power off using the disconnect switch or fuse box before working inside machine. This is particularly important when working on the secondary circuit of the high voltage transformer (T3) because the output voltage is dangerously high.

Refer to figure D.1. Note in highly dirty environments where there is an abundance of conductive contaminants, use a low pressure air stream or a firm piece of paper to clean the spark gap. Do not disturb the factory setting.

To check the spark gap:

- Turn off input power as specified above.
- Remove the right side panel from the machine, the spark gap box is located on the lower right side.
- Check the spark gap with a feeler gauge.

If adjustment is needed:

- Adjust the gap by loosening the allen head screw in one of the aluminum blocks, near the front of the unit and tighten the screw in the new position.

If the gap is correct:

- Replace the wraparound.

8. Inspect gas hose and inlet fitting for cracks or leaks.
9. Replace any unreadable labels or decals.
10. Verify that the machine and welding circuit is properly grounded.

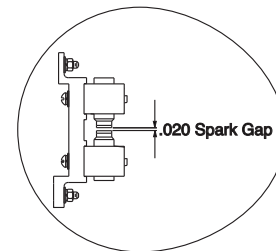
FIGURE D.1 SPARK GAP**FAN MOTOR OR FAN BLADE REPLACEMENT**

When installing a new fan blade or fan motor be sure to maintain proper shaft spacing per Figure D.2 below.

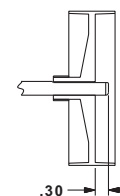
**FIGURE D.2****PRECISION TIG 185**

HOW TO USE TROUBLESHOOTING GUIDE

WARNING

Service and Repair should only be performed by Lincoln Electric Factory Trained Personnel. Unauthorized repairs performed on this equipment may result in danger to the technician and machine operator and will invalidate your factory warranty. For your safety and to avoid Electrical Shock, please observe all safety notes and precautions detailed throughout this manual.

This Troubleshooting Guide is provided to help you locate and repair possible machine malfunctions. Simply follow the three-step procedure listed below.

Step 1. LOCATE PROBLEM (SYMPTOM).

Look under the column labeled "PROBLEM (SYMPTOMS)". This column describes possible symptoms that the machine may exhibit. Find the listing that best describes the symptom that the machine is exhibiting.

Step 2. POSSIBLE CAUSE.

The second column labeled "POSSIBLE CAUSE" lists the obvious external possibilities that may contribute to the machine symptom.

Step 3. RECOMMENDED COURSE OF ACTION

This column provides a course of action for the Possible Cause, generally it states to contact your local Lincoln Authorized Field Service Facility.

If you do not understand or are unable to perform the Recommended Course of Action safely, contact your local Lincoln Authorized Field Service Facility.

CAUTION

If for any reason you do not understand the test procedures or are unable to perform the tests/repairs safely, contact your

Observe all Safety Guidelines detailed throughout this manual

PROBLEMS (SYMPTOMS)	POSSIBLE CAUSE	RECOMMENDED COURSE OF ACTION
OUTPUT PROBLEMS		
Machine is Dead -No Output - No Fan	<ol style="list-style-type: none"> 1. Make certain that the input power switch is in the "ON" position and machine is plugged in. 2. Check the input voltage at the machine. Input voltage must match the rating plate and voltage connection. Refer to Reconnect Procedure in the Installation section of this manual. 3. Blown or missing fuses in input line. 	<p>If all recommended possible areas of misadjustment have been checked and the problem persists, Contact your local Lincoln Authorized Field Service Facility.</p>
Fan runs normally at power up - No output from machine in either Stick or TIG modes.	<ol style="list-style-type: none"> 1. Check for proper input voltages per nameplate and voltage reconnection. 2. Check to make sure polarity switch is not in between two positions. 	
Fan runs - No output from machine in either Stick or TIG modes and the yellow light on the control panel is on.	<ol style="list-style-type: none"> 1. Welding application may have exceed the recommended duty cycle. Allow the unit to run until the fan cools the unit and the yellow light goes out. 	
Machine does not respond (no gas flow, no high frequency and no open circuit voltage) when arc start switch or Amptrol is activated - fan is working.	<ol style="list-style-type: none"> 1. Machine MUST be in the TIG Mode. 2. The Amptrol may be defective. Check for continuity between pins "D" and "E" on cable connector when Amptrol is depressed. 	

 **CAUTION**

If for any reason you do not understand the test procedures or are unable to perform the tests/repairs safely, contact your

PRECISION TIG 185



Observe all Safety Guidelines detailed throughout this manual

PROBLEMS (SYMPTOMS)	POSSIBLE CAUSE	RECOMMENDED COURSE OF ACTION
OUTPUT PROBLEMS		
Machine regularly over heats - thermostat opens, Yellow light on front panel glows. The fan runs but machine has no output.	<ol style="list-style-type: none"> 1. Welding application may exceed recommended duty cycle. Reduce the duty cycle. 2. Dirt and dust may have clogged the cooling channels inside the machine. Blow out unit with clean, dry low pressure air. 3. Air vents and exhaust louvers may be blocked due to inadequate clearance around machine. 	
Output current reduced significantly when AC Balance control knob is set near or at max. penetration or when Output control is set near or at full output.	<ol style="list-style-type: none"> 1. Input power to machine doesn't have sufficient capacity. Try changing Input power to a sufficient supply, refer to Installation section. 2. Machine is powered from an engine generator or an engine welder. If welding at high currents are needed, try powering machine from electricity grid instead of engine generator. 3. Set AC Balance control at Auto Balance position. 	If all recommended possible areas of misadjustment have been checked and the problem persists, Contact your local Lincoln Authorized Field Service Facility.

 **CAUTION**

If for any reason you do not understand the test procedures or are unable to perform the tests/repairs safely, contact your

PRECISION TIG 185



Observe all Safety Guidelines detailed throughout this manual

PROBLEMS (SYMPTOMS)	POSSIBLE CAUSE	RECOMMENDED COURSE OF ACTION
TIG MODE PROBLEMS		
Machine output is intermittently lost. Gas flow and high frequency are also interrupted.	<ol style="list-style-type: none"> 1. Problem may be caused by high frequency interference. Make sure that the machine is grounded properly according to the installation instructions. If there are other high frequency sources in the area, make certain that they are grounded properly. 2. Check Amptrol for proper operation and loose connections. 3. Check for proper input voltage and proper voltage reconnection. 	If all recommended possible areas of misadjustment have been checked and the problem persists, Contact your local Lincoln Authorized Field Service Facility.
Arc "Flutters" when TIG welding.	<ol style="list-style-type: none"> 1. Tungsten electrode may be too large in diameter for the current setting. 2. Tungsten not "sharp" when welding in DC - mode. 3. Gas shielding may be insufficient. Increase gas flow; reduce tungsten stickout beyond gas cup. 4. Check for contaminated gas or leaks in the gas line, torch, or connections. 5. If a helium blend is used as a shielding gas, then reduce the percentage of helium. 	
Arc "Pulsates" when AC TIG welding.	<ol style="list-style-type: none"> 1. Micro Switch mounted on Polarity Switch is not opening in "AC" mode. 	

 **CAUTION**

If for any reason you do not understand the test procedures or are unable to perform the tests/repairs safely, contact your

PRECISION TIG 185



Observe all Safety Guidelines detailed throughout this manual

PROBLEMS (SYMPTOMS)	POSSIBLE CAUSE	RECOMMENDED COURSE OF ACTION
TIG MODE PROBLEMS		
Black areas along weld bead.	<ol style="list-style-type: none"> 1. Clean any oily or organic contamination from the work piece. 2. Tungsten electrode may be contaminated. Replace or sharpen. 3. Check for contaminated gas or leaks in the gas line, torch, or connections. 4. Gas shielding may be insufficient. Increase gas flow; reduce tungsten stickout beyond gas cup. 	If all recommended possible areas of misadjustment have been checked and the problem persists, Contact your local Lincoln Authorized Field Service Facility.
Weak high frequency - machine has normal welding output.	<ol style="list-style-type: none"> 1. Check for poor connections in the welding circuit. 2. Gas shielding may be insufficient. Increase gas flow; reduce tungsten stickout beyond gas cup. 3. Check for work and electrode cables in poor condition allowing high frequency to "Leak Off". 4. Keep cables as short as possible. 5. Check Spark Gap operation and setting (0.020"). 	
High frequency "spark" is present at tungsten electrode, but operator is unable to establish a welding arc. Machine has normal open circuit voltage (refer to Technical Specifications in the Installation Chapter).	<ol style="list-style-type: none"> 1. The tungsten electrode may be contaminated. Replace or sharpen. 2. The current control may be set too low. 3. The tungsten electrode may be too large for the process. 4. If a helium blend is used as a shielding gas, then reduce the percentage of helium. 	

 **CAUTION**

If for any reason you do not understand the test procedures or are unable to perform the tests/repairs safely, contact your

PRECISION TIG 185



Observe all Safety Guidelines detailed throughout this manual

PROBLEMS (SYMPTOMS)	POSSIBLE CAUSE	RECOMMENDED COURSE OF ACTION
TIG WELDING PROBLEMS		
No high frequency. Machine is in the TIG Mode and has normal output.	1. If the machine location is in a highly dirty environment with conductive contaminants, check and clean the spark gap with a low pressure air stream per the maintenance instructions.	If all recommended possible areas of misadjustment have been checked and the problem persists, Contact your local Lincoln Authorized Field Service Facility.
No gas flow when Amptrol is activated in the TIG Mode. Machine has output - fan runs. A "Click" can be heard indicating that the gas solenoid valve is operating.	1. Gas supply is empty or not turned on. 2. Flow regulator may be set too low. 3. Gas hose may be pinched. 4. Gas flow may be blocked with dirt. Check filter screen inside gas inlet fitting to solenoid valve. Use filters to prevent reoccurrence. 5. Consult your local welder/gas distributor.	
When AC TIG welding, the arc is erratic and there is a loss of "cleaning" of the work piece.	1. Tungsten electrode may be too small for process. Use a larger diameter tungsten or a pure tungsten. 2. If a helium blend is used as a shielding gas, then reduce the percentage of helium.	
The end of the tungsten electrode melts away.	1. The welding current is too high for the electrode type and/or size. See Electrode Amperage Ranges in the Operation Section of this manual.	

 **CAUTION**

If for any reason you do not understand the test procedures or are unable to perform the tests/repairs safely, contact your

PRECISION TIG 185



Observe all Safety Guidelines detailed throughout this manual

PROBLEMS (SYMPTOMS)	POSSIBLE CAUSE	RECOMMENDED COURSE OF ACTION
STICK WELDING PROBLEMS		
Stick electrode "Blasts Off" when arc is struck.	1. Weld current may be set too high for electrode size. Reduce current control setting, or use a larger diameter electrode.	If all recommended possible areas of misadjustment have been checked and the problem persists, Contact your local Lincoln Authorized Field Service Facility.
Stick electrode "sticks" in the weld puddle.	1. The weld current may be set too low. Increase the current control setting or use a smaller diameter electrode.	

 **CAUTION**

If for any reason you do not understand the test procedures or are unable to perform the tests/repairs safely, contact your

PRECISION TIG 185



WIRING DIAGRAM - PRECISION TIG 185

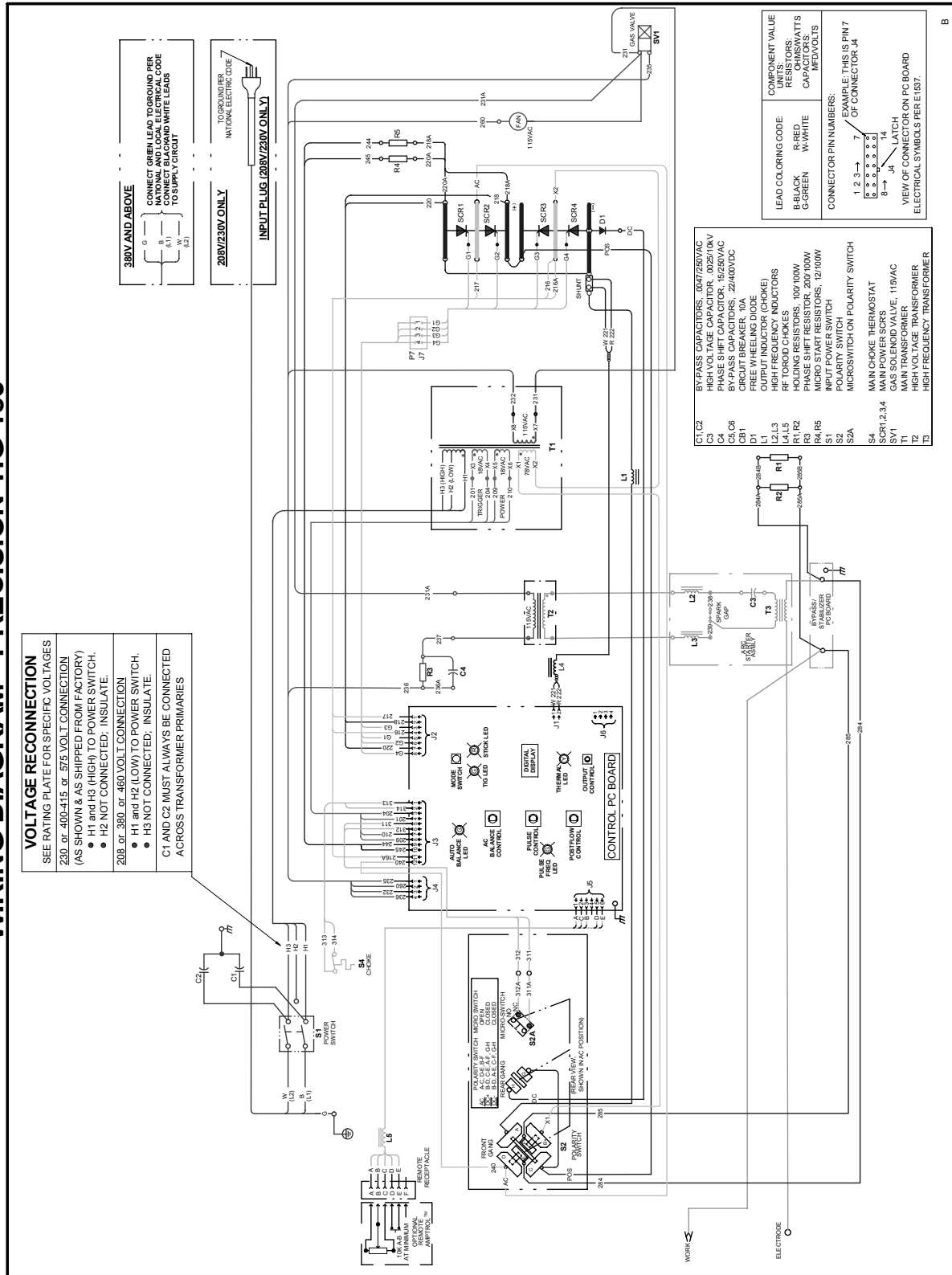

NOTE: This diagram is for reference only. It may not be accurate for all machines covered by this manual. The specific diagram for a particular code is pasted inside the machine on one of the enclosure panels. If the diagram is illegible, write to the Service Department for a replacement. Give the equipment code number..

G4549



MACHINE ONLY AND READY-PAK FOR CODES 11105, 11108

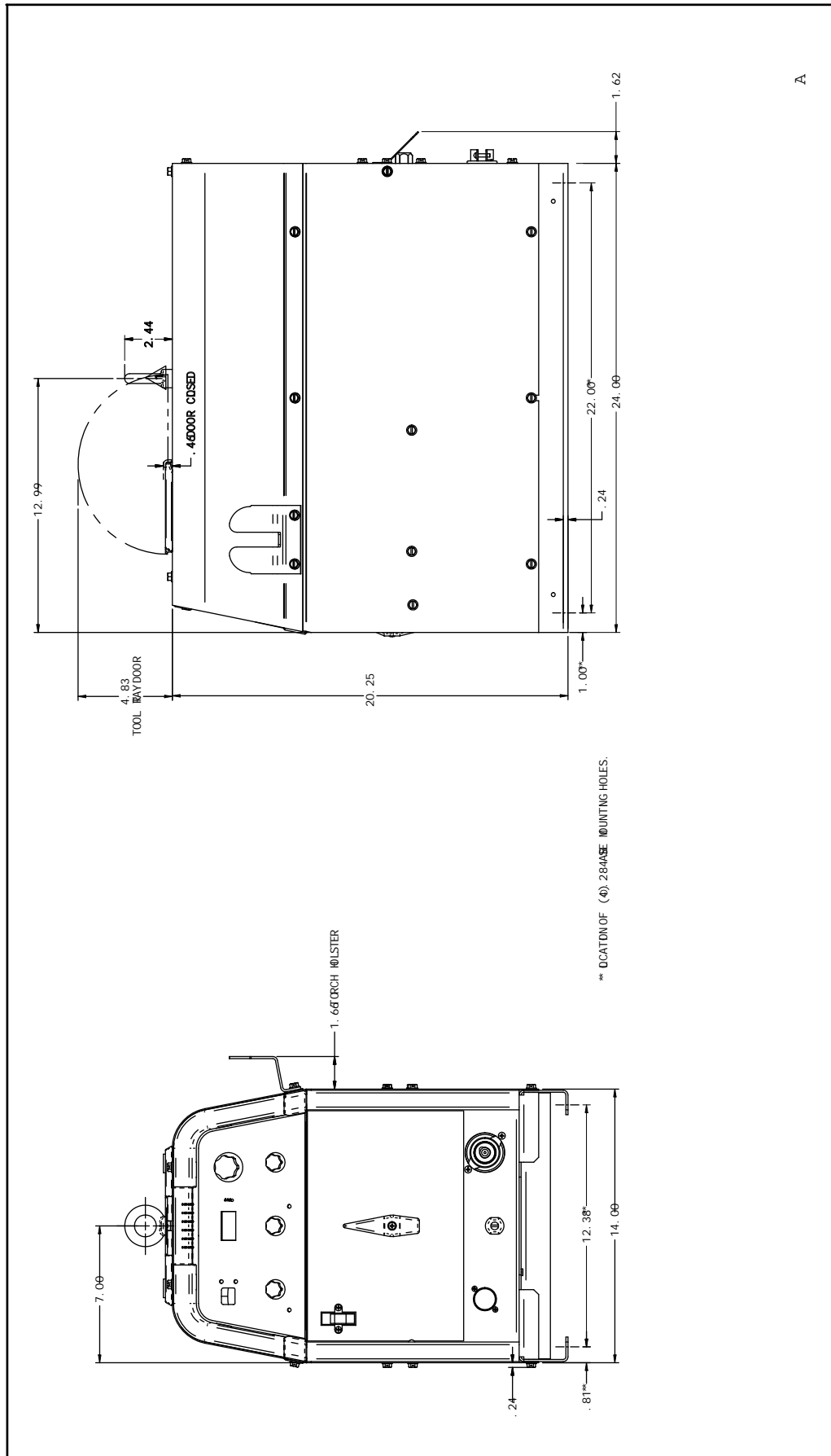

L12201

PRECISION TIG 185



READY-PAK WITH CART FOR CODE 11109

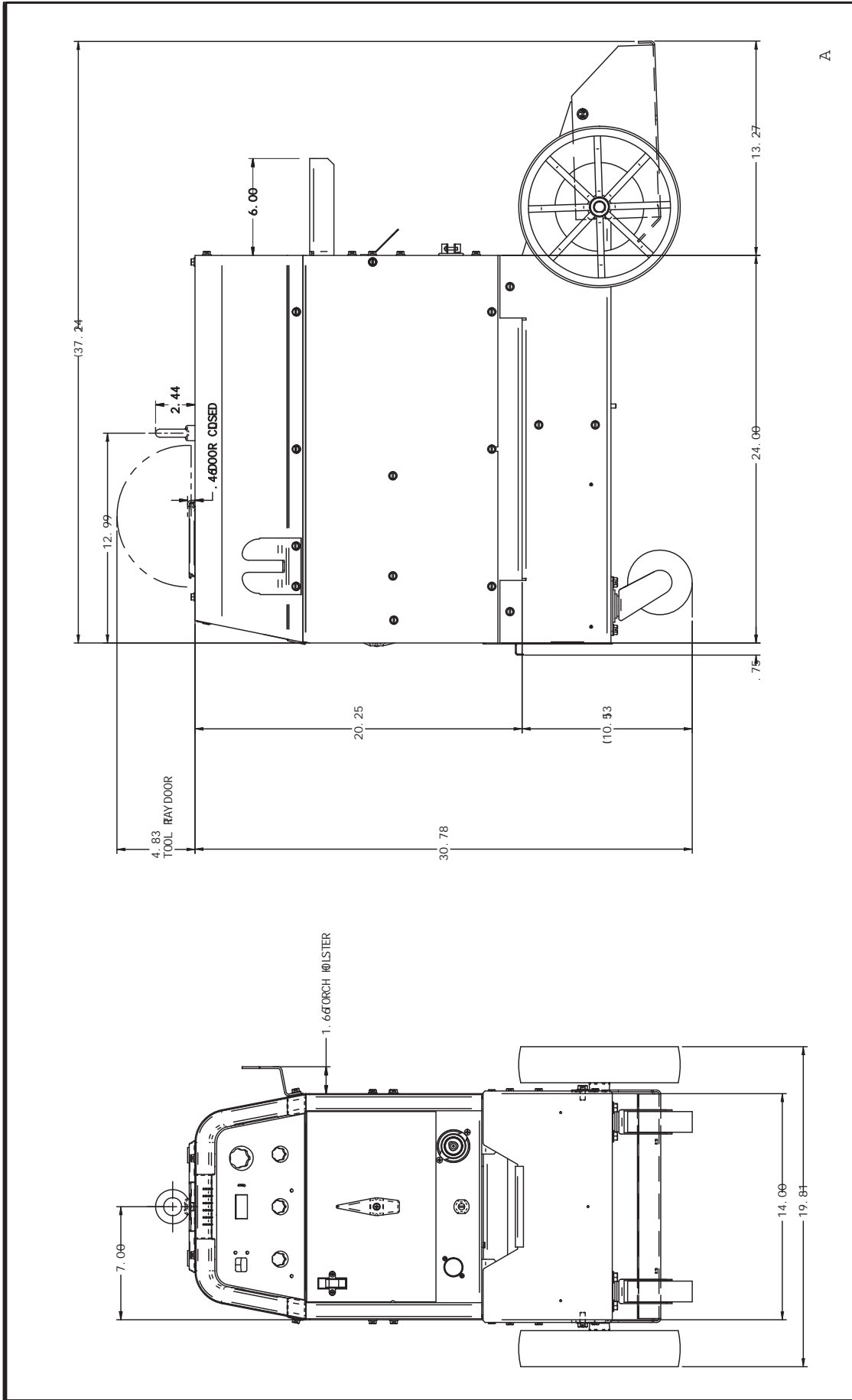

L12202

PRECISION TIG 185



NOTES

PRECISION TIG 185



WARNING	<ul style="list-style-type: none"> Do not touch electrically live parts or electrode with skin or wet clothing. Insulate yourself from work and ground. 	<ul style="list-style-type: none"> Keep flammable materials away. 	<ul style="list-style-type: none"> Wear eye, ear and body protection.
Spanish AVISO DE PRECAUCION	<ul style="list-style-type: none"> No toque las partes o los electrodos bajo carga con la piel o ropa mojada. Aíslese del trabajo y de la tierra. 	<ul style="list-style-type: none"> Mantenga el material combustible fuera del área de trabajo. 	<ul style="list-style-type: none"> Protéjase los ojos, los oídos y el cuerpo.
French ATTENTION	<ul style="list-style-type: none"> Ne laissez ni la peau ni des vêtements mouillés entrer en contact avec des pièces sous tension. Isolez-vous du travail et de la terre. 	<ul style="list-style-type: none"> Gardez à l'écart de tout matériel inflammable. 	<ul style="list-style-type: none"> Protégez vos yeux, vos oreilles et votre corps.
German WARNUNG	<ul style="list-style-type: none"> Berühren Sie keine stromführenden Teile oder Elektroden mit Ihrem Körper oder feuchter Kleidung! Isolieren Sie sich von den Elektroden und dem Erdboden! 	<ul style="list-style-type: none"> Entfernen Sie brennbares Material! 	<ul style="list-style-type: none"> Tragen Sie Augen-, Ohren- und Körperschutz!
Portuguese ATENÇÃO	<ul style="list-style-type: none"> Não toque partes elétricas e electrodos com a pele ou roupa molhada. Isole-se da peça e terra. 	<ul style="list-style-type: none"> Mantenha inflamáveis bem guardados. 	<ul style="list-style-type: none"> Use proteção para a vista, ouvido e corpo.
Japanese 注意事項	<ul style="list-style-type: none"> 通電中の電気部品、又は溶材にヒフやぬれた布で触れないこと。 施工物やアースから身体が絶縁されている様にして下さい。 	<ul style="list-style-type: none"> 燃えやすいものの側での溶接作業は絶対にしてはなりません。 	<ul style="list-style-type: none"> 目、耳及び身体に保護具をして下さい。
Chinese 警告	<ul style="list-style-type: none"> 皮肤或湿衣物切勿接触带电部件及焊条。 使你自已与地面和工作件绝缘。 	<ul style="list-style-type: none"> 把一切易燃物品移离工作场所。 	<ul style="list-style-type: none"> 佩戴眼、耳及身体劳动保护用具。
Korean 위험	<ul style="list-style-type: none"> 전도체나 용접봉을 젖은 형갑 또는 피부로 절대 접촉치 마십시오. 모재와 접지를 접촉치 마십시오. 	<ul style="list-style-type: none"> 인화성 물질을 접근시키지 마십시오. 	<ul style="list-style-type: none"> 눈, 귀와 몸에 보호장구를 착용하십시오.
Arabic تحذير	<ul style="list-style-type: none"> لا تلمس الاجزاء التي يسري فيها التيار الكهربائي أو الألكترود بجند الجسم أو بالملابس المبللة بالماء. ضع عازلا على جسمك خلال العمل. 	<ul style="list-style-type: none"> ضع المواد القابلة للاشتعال في مكان بعيد. 	<ul style="list-style-type: none"> ضع أدوات وملابس واقية على عينيك وأذنيك وجسمك.

READ AND UNDERSTAND THE MANUFACTURER'S INSTRUCTION FOR THIS EQUIPMENT AND THE CONSUMABLES TO BE USED AND FOLLOW YOUR EMPLOYER'S SAFETY PRACTICES.

SE RECOMIENDA LEER Y ENTENDER LAS INSTRUCCIONES DEL FABRICANTE PARA EL USO DE ESTE EQUIPO Y LOS CONSUMIBLES QUE VA A UTILIZAR, SIGA LAS MEDIDAS DE SEGURIDAD DE SU SUPERVISOR.

LISEZ ET COMPRENEZ LES INSTRUCTIONS DU FABRICANT EN CE QUI REGARDE CET EQUIPMENT ET LES PRODUITS A ETRE EMPLOYES ET SUIVEZ LES PROCEDURES DE SECURITE DE VOTRE EMPLOYEUR.

LESEN SIE UND BEFOLGEN SIE DIE BETRIEBSANLEITUNG DER ANLAGE UND DEN ELEKTRODENEINSATZ DES HERSTELLERS. DIE UNFALLVERHÜTUNGSVORSCHRIFTEN DES ARBEITGEBERS SIND EBENFALLS ZU BEACHTEN.

			
<ul style="list-style-type: none"> ● Keep your head out of fumes. ● Use ventilation or exhaust to remove fumes from breathing zone. 	<ul style="list-style-type: none"> ● Turn power off before servicing. 	<ul style="list-style-type: none"> ● Do not operate with panel open or guards off. 	WARNING
<ul style="list-style-type: none"> ● Los humos fuera de la zona de respiración. ● Mantenga la cabeza fuera de los humos. Utilice ventilación o aspiración para gases. 	<ul style="list-style-type: none"> ● Desconectar el cable de alimentación de poder de la máquina antes de iniciar cualquier servicio. 	<ul style="list-style-type: none"> ● No operar con panel abierto o guardas quitadas. 	Spanish AVISO DE PRECAUCION
<ul style="list-style-type: none"> ● Gardez la tête à l'écart des fumées. ● Utilisez un ventilateur ou un aspirateur pour ôter les fumées des zones de travail. 	<ul style="list-style-type: none"> ● Débranchez le courant avant l'entretien. 	<ul style="list-style-type: none"> ● N'opérez pas avec les panneaux ouverts ou avec les dispositifs de protection enlevés. 	French ATTENTION
<ul style="list-style-type: none"> ● Vermeiden Sie das Einatmen von Schweißrauch! ● Sorgen Sie für gute Be- und Entlüftung des Arbeitsplatzes! 	<ul style="list-style-type: none"> ● Strom vor Wartungsarbeiten abschalten! (Netzstrom völlig öffnen; Maschine anhalten!) 	<ul style="list-style-type: none"> ● Anlage nie ohne Schutzgehäuse oder Innenschutzverkleidung in Betrieb setzen! 	German WARNUNG
<ul style="list-style-type: none"> ● Mantenha seu rosto da fumaça. ● Use ventilação e exaustão para remover fumo da zona respiratória. 	<ul style="list-style-type: none"> ● Não opere com as tampas removidas. ● Desligue a corrente antes de fazer serviço. ● Não toque as partes elétricas nuas. 	<ul style="list-style-type: none"> ● Mantenha-se afastado das partes moventes. ● Não opere com os painéis abertos ou guardas removidas. 	Portuguese ATENÇÃO
<ul style="list-style-type: none"> ● ヒュームから頭を離すようにして下さい。 ● 換気や排煙に十分留意して下さい。 	<ul style="list-style-type: none"> ● メンテナンス・サービスに取りかかる際には、まず電源スイッチを必ず切して下さい。 	<ul style="list-style-type: none"> ● パネルやカバーを取り外したまま機械操作をしないで下さい。 	Japanese 注意事項
<ul style="list-style-type: none"> ● 頭部遠離煙霧。 ● 在呼吸區使用通風或排風器除煙。 	<ul style="list-style-type: none"> ● 維修前切斷電源。 	<ul style="list-style-type: none"> ● 儀表板打開或沒有安全罩時不準作業。 	Chinese 警告
<ul style="list-style-type: none"> ● 얼굴로부터 용접가스를 멀리하십시오. ● 호흡지역으로부터 용접가스를 제거하기 위해 가스제거기나 통풍기를 사용하십시오. 	<ul style="list-style-type: none"> ● 보수전에 전원을 차단하십시오. 	<ul style="list-style-type: none"> ● 판넬이 열린 상태로 작동치 마십시오. 	Korean 위험
<ul style="list-style-type: none"> ● ابعد رأسك بعيداً عن الدخان. ● استعمل التهوية أو جهاز ضغط الدخان للخارج لكي تبعد الدخان عن المنطقة التي تتنفس فيها. 	<ul style="list-style-type: none"> ● اقطع التيار الكهربائي قبل القيام بأية صيانة. 	<ul style="list-style-type: none"> ● لا تشغيل هذا الجهاز اذا كانت الاغطية الحديدية الواقية ليست عليه. 	Arabic تحذير

LEIA E COMPREENDA AS INSTRUÇÕES DO FABRICANTE PARA ESTE EQUIPAMENTO E AS PARTES DE USO, E SIGA AS PRÁTICAS DE SEGURANÇA DO EMPREGADOR.

使う機械や溶材のメーカーの指示書をよく読み、まず理解して下さい。そして貴社の安全規定に従って下さい。

請詳細閱讀並理解製造廠提供的說明以及應該使用的銀焊材料，並請遵守貴方的有閣勞動保護規定。

이 제품에 동봉된 작업지침서를 숙지하시고 귀사의 작업자 안전수칙을 준수하시기 바랍니다.

اقرأ بتمعن وافهم تعليمات المصنع المنتج لهذه المعدات والمواد قبل استعمالها واتبع تعليمات الوقاية لصاحب العمل.



• World's Leader in Welding and Cutting Products •

• Sales and Service through Subsidiaries and Distributors Worldwide •

Cleveland, Ohio 44117-1199 U.S.A. TEL: 216.481.8100 FAX: 216.486.1751 WEB SITE: www.lincolnelectric.com

Download from Www.Somanuals.com. All Manuals Search And Download.

Free Manuals Download Website

<http://myh66.com>

<http://usermanuals.us>

<http://www.somanuals.com>

<http://www.4manuals.cc>

<http://www.manual-lib.com>

<http://www.404manual.com>

<http://www.luxmanual.com>

<http://aubethermostatmanual.com>

Golf course search by state

<http://golfingnear.com>

Email search by domain

<http://emailbydomain.com>

Auto manuals search

<http://auto.somanuals.com>

TV manuals search

<http://tv.somanuals.com>