

POWER WAVE[®] AC/DC 1000

For use with machines having Code Numbers: 11124, 11226

Safety Depends on You

Lincoln arc welding and cutting equipment is designed and built with safety in mind. However, your overall safety can be increased by proper installation ... and thoughtful operation on your part. **DO NOT INSTALL, OPERATE OR REPAIR THIS EQUIPMENT WITHOUT READING THIS MANUAL AND THE SAFETY PRECAUTIONS CONTAINED THROUGHOUT.** And, most importantly, think before you act and be careful.



IEC 60974-1

OPERATOR'S MANUAL

LINCOLN[®]
ELECTRIC

Copyright © Lincoln Global Inc.

- World's Leader in Welding and Cutting Products •
- Sales and Service through Subsidiaries and Distributors Worldwide •

Cleveland, Ohio 44117-1199 U.S.A. TEL: 216.481.8100 FAX: 216.486.1751 WEB SITE: www.lincolnelectric.com

Download from Www.Somanuals.com. All Manuals Search And Download.

⚠ WARNING

⚠ CALIFORNIA PROPOSITION 65 WARNINGS ⚠

Diesel engine exhaust and some of its constituents are known to the State of California to cause cancer, birth defects, and other reproductive harm.

The Above For Diesel Engines

The engine exhaust from this product contains chemicals known to the State of California to cause cancer, birth defects, or other reproductive harm.

The Above For Gasoline Engines

ARC WELDING CAN BE HAZARDOUS. PROTECT YOURSELF AND OTHERS FROM POSSIBLE SERIOUS INJURY OR DEATH. KEEP CHILDREN AWAY. PACEMAKER WEARERS SHOULD CONSULT WITH THEIR DOCTOR BEFORE OPERATING.

Read and understand the following safety highlights. For additional safety information, it is strongly recommended that you purchase a copy of "Safety in Welding & Cutting - ANSI Standard Z49.1" from the American Welding Society, P.O. Box 351040, Miami, Florida 33135 or CSA Standard W117.2-1974. A Free copy of "Arc Welding Safety" booklet E205 is available from the Lincoln Electric Company, 22801 St. Clair Avenue, Cleveland, Ohio 44117-1199.

BE SURE THAT ALL INSTALLATION, OPERATION, MAINTENANCE AND REPAIR PROCEDURES ARE PERFORMED ONLY BY QUALIFIED INDIVIDUALS.



FOR ENGINE powered equipment.

1.a. Turn the engine off before troubleshooting and maintenance work unless the maintenance work requires it to be running.



1.b. Operate engines in open, well-ventilated areas or vent the engine exhaust fumes outdoors.



1.c. Do not add the fuel near an open flame welding arc or when the engine is running. Stop the engine and allow it to cool before refueling to prevent spilled fuel from vaporizing on contact with hot engine parts and igniting. Do not spill fuel when filling tank. If fuel is spilled, wipe it up and do not start engine until fumes have been eliminated.

1.d. Keep all equipment safety guards, covers and devices in position and in good repair. Keep hands, hair, clothing and tools away from V-belts, gears, fans and all other moving parts when starting, operating or repairing equipment.

1.e. In some cases it may be necessary to remove safety guards to perform required maintenance. Remove guards only when necessary and replace them when the maintenance requiring their removal is complete. Always use the greatest care when working near moving parts.



1.f. Do not put your hands near the engine fan. Do not attempt to override the governor or idler by pushing on the throttle control rods while the engine is running.

1.g. To prevent accidentally starting gasoline engines while turning the engine or welding generator during maintenance work, disconnect the spark plug wires, distributor cap or magneto wire as appropriate.



1.h. To avoid scalding, do not remove the radiator pressure cap when the engine is hot.



ELECTRIC AND MAGNETIC FIELDS may be dangerous

2.a. Electric current flowing through any conductor causes localized Electric and Magnetic Fields (EMF). Welding current creates EMF fields around welding cables and welding machines

2.b. EMF fields may interfere with some pacemakers, and welders having a pacemaker should consult their physician before welding.

2.c. Exposure to EMF fields in welding may have other health effects which are now not known.

2.d. All welders should use the following procedures in order to minimize exposure to EMF fields from the welding circuit:

2.d.1. Route the electrode and work cables together - Secure them with tape when possible.

2.d.2. Never coil the electrode lead around your body.

2.d.3. Do not place your body between the electrode and work cables. If the electrode cable is on your right side, the work cable should also be on your right side.

2.d.4. Connect the work cable to the workpiece as close as possible to the area being welded.

2.d.5. Do not work next to welding power source.

Mar '95



ELECTRIC SHOCK can kill.

- 3.a. The electrode and work (or ground) circuits are electrically "hot" when the welder is on. Do not touch these "hot" parts with your bare skin or wet clothing. Wear dry, hole-free gloves to insulate hands.
- 3.b. Insulate yourself from work and ground using dry insulation. Make certain the insulation is large enough to cover your full area of physical contact with work and ground.
- In addition to the normal safety precautions, if welding must be performed under electrically hazardous conditions (in damp locations or while wearing wet clothing; on metal structures such as floors, gratings or scaffolds; when in cramped positions such as sitting, kneeling or lying, if there is a high risk of unavoidable or accidental contact with the workpiece or ground) use the following equipment:**
- Semiautomatic DC Constant Voltage (Wire) Welder.
 - DC Manual (Stick) Welder.
 - AC Welder with Reduced Voltage Control.
- 3.c. In semiautomatic or automatic wire welding, the electrode, electrode reel, welding head, nozzle or semiautomatic welding gun are also electrically "hot".
- 3.d. Always be sure the work cable makes a good electrical connection with the metal being welded. The connection should be as close as possible to the area being welded.
- 3.e. Ground the work or metal to be welded to a good electrical (earth) ground.
- 3.f. Maintain the electrode holder, work clamp, welding cable and welding machine in good, safe operating condition. Replace damaged insulation.
- 3.g. Never dip the electrode in water for cooling.
- 3.h. Never simultaneously touch electrically "hot" parts of electrode holders connected to two welders because voltage between the two can be the total of the open circuit voltage of both welders.
- 3.i. When working above floor level, use a safety belt to protect yourself from a fall should you get a shock.
- 3.j. Also see Items 6.c. and 8.



ARC RAYS can burn.

- 4.a. Use a shield with the proper filter and cover plates to protect your eyes from sparks and the rays of the arc when welding or observing open arc welding. Headshield and filter lens should conform to ANSI Z87.1 standards.
- 4.b. Use suitable clothing made from durable flame-resistant material to protect your skin and that of your helpers from the arc rays.
- 4.c. Protect other nearby personnel with suitable, non-flammable screening and/or warn them not to watch the arc nor expose themselves to the arc rays or to hot spatter or metal.



FUMES AND GASES can be dangerous.

- 5.a. Welding may produce fumes and gases hazardous to health. Avoid breathing these fumes and gases. When welding, keep your head out of the fume. Use enough ventilation and/or exhaust at the arc to keep fumes and gases away from the breathing zone. **When welding with electrodes which require special ventilation such as stainless or hard facing (see instructions on container or MSDS) or on lead or cadmium plated steel and other metals or coatings which produce highly toxic fumes, keep exposure as low as possible and within applicable OSHA PEL and ACGIH TLV limits using local exhaust or mechanical ventilation. In confined spaces or in some circumstances, outdoors, a respirator may be required. Additional precautions are also required when welding on galvanized steel.**
5. b. The operation of welding fume control equipment is affected by various factors including proper use and positioning of the equipment, maintenance of the equipment and the specific welding procedure and application involved. Worker exposure level should be checked upon installation and periodically thereafter to be certain it is within applicable OSHA PEL and ACGIH TLV limits.
- 5.c. Do not weld in locations near chlorinated hydrocarbon vapors coming from degreasing, cleaning or spraying operations. The heat and rays of the arc can react with solvent vapors to form phosgene, a highly toxic gas, and other irritating products.
- 5.d. Shielding gases used for arc welding can displace air and cause injury or death. Always use enough ventilation, especially in confined areas, to insure breathing air is safe.
- 5.e. Read and understand the manufacturer's instructions for this equipment and the consumables to be used, including the material safety data sheet (MSDS) and follow your employer's safety practices. MSDS forms are available from your welding distributor or from the manufacturer.
- 5.f. Also see item 1.b.



WELDING and CUTTING SPARKS can cause fire or explosion.

6.a. Remove fire hazards from the welding area. If this is not possible, cover them to prevent the welding sparks from starting a fire.

Remember that welding sparks and hot materials from welding can easily go through small cracks and openings to adjacent areas. Avoid welding near hydraulic lines. Have a fire extinguisher readily available.

- 6.b. Where compressed gases are to be used at the job site, special precautions should be used to prevent hazardous situations. Refer to "Safety in Welding and Cutting" (ANSI Standard Z49.1) and the operating information for the equipment being used.
- 6.c. When not welding, make certain no part of the electrode circuit is touching the work or ground. Accidental contact can cause overheating and create a fire hazard.
- 6.d. Do not heat, cut or weld tanks, drums or containers until the proper steps have been taken to insure that such procedures will not cause flammable or toxic vapors from substances inside. They can cause an explosion even though they have been "cleaned". For information, purchase "Recommended Safe Practices for the Preparation for Welding and Cutting of Containers and Piping That Have Held Hazardous Substances", AWS F4.1 from the American Welding Society (see address above).
- 6.e. Vent hollow castings or containers before heating, cutting or welding. They may explode.
- 6.f. Sparks and spatter are thrown from the welding arc. Wear oil free protective garments such as leather gloves, heavy shirt, cuffless trousers, high shoes and a cap over your hair. Wear ear plugs when welding out of position or in confined places. Always wear safety glasses with side shields when in a welding area.
- 6.g. Connect the work cable to the work as close to the welding area as practical. Work cables connected to the building framework or other locations away from the welding area increase the possibility of the welding current passing through lifting chains, crane cables or other alternate circuits. This can create fire hazards or overheat lifting chains or cables until they fail.
- 6.h. Also see item 1.c.
- 6.i. Read and follow NFPA 51B "Standard for Fire Prevention During Welding, Cutting and Other Hot Work", available from NFPA, 1 Batterymarch Park, PO box 9101, Quincy, Ma 02269-9101.
- 6.j. Do not use a welding power source for pipe thawing.



CYLINDER may explode if damaged.

7.a. Use only compressed gas cylinders containing the correct shielding gas for the process used and properly operating regulators designed for the gas and pressure used. All hoses, fittings, etc. should be suitable for the application and maintained in good condition.

- 7.b. Always keep cylinders in an upright position securely chained to an undercarriage or fixed support.
- 7.c. Cylinders should be located:
 - Away from areas where they may be struck or subjected to physical damage.
 - A safe distance from arc welding or cutting operations and any other source of heat, sparks, or flame.
- 7.d. Never allow the electrode, electrode holder or any other electrically "hot" parts to touch a cylinder.
- 7.e. Keep your head and face away from the cylinder valve outlet when opening the cylinder valve.
- 7.f. Valve protection caps should always be in place and hand tight except when the cylinder is in use or connected for use.
- 7.g. Read and follow the instructions on compressed gas cylinders, associated equipment, and CGA publication P-1, "Precautions for Safe Handling of Compressed Gases in Cylinders," available from the Compressed Gas Association 1235 Jefferson Davis Highway, Arlington, VA 22202.



FOR ELECTRICALLY powered equipment.

- 8.a. Turn off input power using the disconnect switch at the fuse box before working on the equipment.
- 8.b. Install equipment in accordance with the U.S. National Electrical Code, all local codes and the manufacturer's recommendations.
- 8.c. Ground the equipment in accordance with the U.S. National Electrical Code and the manufacturer's recommendations.

Refer to <http://www.lincolnelectric.com/safety> for additional safety information.

PRÉCAUTIONS DE SÛRETÉ

Pour votre propre protection lire et observer toutes les instructions et les précautions de sûreté spécifiques qui paraissent dans ce manuel aussi bien que les précautions de sûreté générales suivantes:

Sûreté Pour Soudage A L'Arc

1. Protégez-vous contre la secousse électrique:
 - a. Les circuits à l'électrode et à la pièce sont sous tension quand la machine à souder est en marche. Eviter toujours tout contact entre les parties sous tension et la peau nue ou les vêtements mouillés. Porter des gants secs et sans trous pour isoler les mains.
 - b. Faire très attention de bien s'isoler de la masse quand on soude dans des endroits humides, ou sur un plancher métallique ou des grilles métalliques, principalement dans les positions assis ou couché pour lesquelles une grande partie du corps peut être en contact avec la masse.
 - c. Maintenir le porte-électrode, la pince de masse, le câble de soudage et la machine à souder en bon et sûr état de fonctionnement.
 - d. Ne jamais plonger le porte-électrode dans l'eau pour le refroidir.
 - e. Ne jamais toucher simultanément les parties sous tension des porte-électrodes connectés à deux machines à souder parce que la tension entre les deux pinces peut être le total de la tension à vide des deux machines.
 - f. Si on utilise la machine à souder comme une source de courant pour soudage semi-automatique, ces précautions pour le porte-électrode s'appliquent aussi au pistolet de soudage.
2. Dans le cas de travail au dessus du niveau du sol, se protéger contre les chutes dans le cas où on reçoit un choc. Ne jamais enrouler le câble-électrode autour de n'importe quelle partie du corps.
3. Un coup d'arc peut être plus sévère qu'un coup de soleil, donc:
 - a. Utiliser un bon masque avec un verre filtrant approprié ainsi qu'un verre blanc afin de se protéger les yeux du rayonnement de l'arc et des projections quand on soude ou quand on regarde l'arc.
 - b. Porter des vêtements convenables afin de protéger la peau de soudeur et des aides contre le rayonnement de l'arc.
 - c. Protéger l'autre personnel travaillant à proximité au soudage à l'aide d'écrans appropriés et non-inflammables.
4. Des gouttes de laitier en fusion sont émises de l'arc de soudage. Se protéger avec des vêtements de protection libres de l'huile, tels que les gants en cuir, chemise épaisse, pantalons sans revers, et chaussures montantes.
5. Toujours porter des lunettes de sécurité dans la zone de soudage. Utiliser des lunettes avec écrans latéraux dans les zones où l'on pique le laitier.
6. Eloigner les matériaux inflammables ou les recouvrir afin de prévenir tout risque d'incendie dû aux étincelles.
7. Quand on ne soude pas, poser la pince à un endroit isolé de la masse. Un court-circuit accidentel peut provoquer un échauffement et un risque d'incendie.
8. S'assurer que la masse est connectée le plus près possible de la zone de travail qu'il est pratique de le faire. Si on place la masse sur la charpente de la construction ou d'autres endroits éloignés de la zone de travail, on augmente le risque de voir passer le courant de soudage par les chaînes de levage, câbles de grue, ou autres circuits. Cela peut provoquer des risques d'incendie ou d'échauffement des chaînes et des câbles jusqu'à ce qu'ils se rompent.
9. Assurer une ventilation suffisante dans la zone de soudage. Ceci est particulièrement important pour le soudage de tôles galvanisées plombées, ou cadmiées ou tout autre métal qui produit des fumées toxiques.
10. Ne pas souder en présence de vapeurs de chlore provenant d'opérations de dégraissage, nettoyage ou pistolage. La chaleur ou les rayons de l'arc peuvent réagir avec les vapeurs du solvant pour produire du phosgène (gas fortement toxique) ou autres produits irritants.
11. Pour obtenir de plus amples renseignements sur la sûreté, voir le code "Code for safety in welding and cutting" CSA Standard W 117.2-1974.

PRÉCAUTIONS DE SÛRETÉ POUR LES MACHINES À SOUDER À TRANSFORMATEUR ET À REDRESSEUR

1. Relier à la terre le châssis du poste conformément au code de l'électricité et aux recommandations du fabricant. Le dispositif de montage ou la pièce à souder doit être branché à une bonne mise à la terre.
2. Autant que possible, l'installation et l'entretien du poste seront effectués par un électricien qualifié.
3. Avant de faire des travaux à l'intérieur de poste, la débrancher à l'interrupteur à la boîte de fusibles.
4. Garder tous les couvercles et dispositifs de sûreté à leur place.

ELECTROMAGNETIC COMPATIBILITY (EMC)

Conformance

Products displaying the CE mark are in conformity with European Community Council Directive of 3 May 1989 on the approximation of the laws of the Member States relating to electromagnetic compatibility (89/336/EEC). It was manufactured in conformity with a national standard that implements a harmonized standard: EN 50 199 Electromagnetic Compatibility (EMC) Product Standard for Arc Welding Equipment. It is for use with other Lincoln Electric equipment. It is designed for industrial and professional use.

Introduction

All electrical equipment generates small amounts of electromagnetic emission. Electrical emission may be transmitted through power lines or radiated through space, similar to a radio transmitter. When emissions are received by other equipment, electrical interference may result. Electrical emissions may affect many kinds of electrical equipment; other nearby welding equipment, radio and TV reception, numerical controlled machines, telephone systems, computers, etc. Be aware that interference may result and extra precautions may be required when a welding power source is used in a domestic establishment.

Installation and Use

The user is responsible for installing and using the welding equipment according to the manufacturer's instructions. If electromagnetic disturbances are detected then it shall be the responsibility of the user of the welding equipment to resolve the situation with the technical assistance of the manufacturer. In some cases this remedial action may be as simple as earthing (grounding) the welding circuit, see Note. In other cases it could involve constructing an electromagnetic screen enclosing the power source and the work complete with associated input filters. In all cases electromagnetic disturbances must be reduced to the point where they are no longer troublesome.

Note: The welding circuit may or may not be earthed for safety reasons according to national codes. Changing the earthing arrangements should only be authorized by a person who is competent to assess whether the changes will increase the risk of injury, e.g., by allowing parallel welding current return paths which may damage the earth circuits of other equipment.

Assessment of Area

Before installing welding equipment the user shall make an assessment of potential electromagnetic problems in the surrounding area. The following shall be taken into account:

- a) other supply cables, control cables, signaling and telephone cables; above, below and adjacent to the welding equipment;
- b) radio and television transmitters and receivers;
- c) computer and other control equipment;
- d) safety critical equipment, e.g., guarding of industrial equipment;
- e) the health of the people around, e.g., the use of pacemakers and hearing aids;
- f) equipment used for calibration or measurement;
- g) the immunity of other equipment in the environment. The user shall ensure that other equipment being used in the environment is compatible. This may require additional protection measures;
- h) the time of day that welding or other activities are to be carried out.

3-1-96H

L10093

ELECTROMAGNETIC COMPATIBILITY (EMC)

The size of the surrounding area to be considered will depend on the structure of the building and other activities that are taking place. The surrounding area may extend beyond the boundaries of the premises.

Methods of Reducing Emissions

Mains Supply

Welding equipment should be connected to the mains supply according to the manufacturer's recommendations. If interference occurs, it may be necessary to take additional precautions such as filtering of the mains supply. Consideration should be given to shielding the supply cable of permanently installed welding equipment, in metallic conduit or equivalent. Shielding should be electrically continuous throughout its length. The shielding should be connected to the welding power source so that good electrical contact is maintained between the conduit and the welding power source enclosure.

Maintenance of the Welding Equipment

The welding equipment should be routinely maintained according to the manufacturer's recommendations. All access and service doors and covers should be closed and properly fastened when the welding equipment is in operation. The welding equipment should not be modified in any way except for those changes and adjustments covered in the manufacturer's instructions. In particular, the spark gaps of arc striking and stabilizing devices should be adjusted and maintained according to the manufacturer's recommendations.

Welding Cables

The welding cables should be kept as short as possible and should be positioned close together, running at or close to the floor level.

Equipotential Bonding

Bonding of all metallic components in the welding installation and adjacent to it should be considered. However, metallic components bonded to the work piece will increase the risk that the operator could receive a shock by touching these metallic components and the electrode at the same time. The operator should be insulated from all such bonded metallic components.

Earthing of the Workpiece

Where the workpiece is not bonded to earth for electrical safety, not connected to earth because of its size and position, e.g., ships hull or building steelwork, a connection bonding the workpiece to earth may reduce emissions in some, but not all instances. Care should be taken to prevent the earthing of the workpiece increasing the risk of injury to users, or damage to other electrical equipment. Where necessary, the connection of the workpiece to earth should be made by a direct connection to the workpiece, but in some countries where direct connection is not permitted, the bonding should be achieved by suitable capacitance, selected according to national regulations.

Screening and Shielding

Selective screening and shielding of other cables and equipment in the surrounding area may alleviate problems of interference. Screening of the entire welding installation may be considered for special applications.¹

¹ Portions of the preceding text are contained in EN50199: "Electromagnetic Compatibility (EMC) product standard for arc welding equipment."

Thank You

for selecting a **QUALITY** product by Lincoln Electric. We want you to take pride in operating this Lincoln Electric Company product
••• as much pride as we have in bringing this product to you!

CUSTOMER ASSISTANCE POLICY

The business of The Lincoln Electric Company is manufacturing and selling high quality welding equipment, consumables, and cutting equipment. Our challenge is to meet the needs of our customers and to exceed their expectations. On occasion, purchasers may ask Lincoln Electric for advice or information about their use of our products. We respond to our customers based on the best information in our possession at that time. Lincoln Electric is not in a position to warrant or guarantee such advice, and assumes no liability, with respect to such information or advice. We expressly disclaim any warranty of any kind, including any warranty of fitness for any customer's particular purpose, with respect to such information or advice. As a matter of practical consideration, we also cannot assume any responsibility for updating or correcting any such information or advice once it has been given, nor does the provision of information or advice create, expand or alter any warranty with respect to the sale of our products.

Lincoln Electric is a responsive manufacturer, but the selection and use of specific products sold by Lincoln Electric is solely within the control of, and remains the sole responsibility of the customer. Many variables beyond the control of Lincoln Electric affect the results obtained in applying these types of fabrication methods and service requirements.

Subject to Change – This information is accurate to the best of our knowledge at the time of printing. Please refer to www.lincolnelectric.com for any updated information.

Please Examine Carton and Equipment For Damage Immediately

When this equipment is shipped, title passes to the purchaser upon receipt by the carrier. Consequently, Claims for material damaged in shipment must be made by the purchaser against the transportation company at the time the shipment is received.

Please record your equipment identification information below for future reference. This information can be found on your machine nameplate.

Product _____

Model Number _____

Code Number or Date Code _____

Serial Number _____

Date Purchased _____

Where Purchased _____

Whenever you request replacement parts or information on this equipment, always supply the information you have recorded above. The code number is especially important when identifying the correct replacement parts.

On-Line Product Registration

- Register your machine with Lincoln Electric either via fax or over the Internet.
 - For faxing: Complete the form on the back of the warranty statement included in the literature packet accompanying this machine and fax the form per the instructions printed on it.
 - For On-Line Registration: Go to our **WEB SITE at www.lincolnelectric.com**. Choose "Quick Links" and then "Product Registration". Please complete the form and submit your registration.

Read this Operators Manual completely before attempting to use this equipment. Save this manual and keep it handy for quick reference. Pay particular attention to the safety instructions we have provided for your protection. The level of seriousness to be applied to each is explained below:

⚠ WARNING

This statement appears where the information **must** be followed **exactly** to avoid **serious personal injury or loss of life**.

⚠ CAUTION

This statement appears where the information **must** be followed to avoid **minor personal injury or damage to this equipment**.

	Page
Installation.....	Section A
Specifications	A-1
Safety Precautions.	A-2
Location and Mounting.....	A-2
Stacking	A-2
Lifting.....	A-2
Environmental Limitations	A-2
Electromagnetic Compatibility	A-2
Input Fuse and Supply Wire Considerations.....	A-3
Input Voltage Selection and Ground Connections	A-3
Connection/Input Access Door, Connection Diagrams System	A-3
System Connection	A-4
Recommended Equipment.....	A-5
Optional Equipment.....	A-6
Connection Diagrams and Check List.....	A-7 thru A-14
Electrode and Work Connection	A-15
Cable Inductance, And its Effects On Welding	A-16
Remote Sense Lead Specifications	A-16 thru A-18
Control Cable Connections Between Power Source and Wire Feeder	A-19, A-20
External I/O Connector.....	A-21
Cables, Connections and Limitations	A-21, A-22
Wire Drive Gear Ratio Setting, Ethernet Configuration	A-23
Devicenet Configuration, Internal Controls, Settings and Descriptions	A-24 thru A-28
<hr/>	
Operation.....	Section B
Safety Precautions, Definition of Welding Modes	B-1
Graphic Symbols	B-2
Product Summary, Recommended Process, Process and Equipment Limitations.....	B-3
Common Equipment Packages and Recommended Equipment	B-3
Case Front Control Descriptions.....	B-4,B-5
Case Rear Components.....	B-6
Power-Up Sequence	B-6
Duty Cycle	B-7
Common Welding Procedures	B-7
Overview of the AC/DC Submerged Arc Process	B-7
Multiple Arc System Considerations.....	B-8
Basic Modes of Operation (CC / CV)	B-8
Weld Sequence, Start Options, End Options, Re-Strike Timer	B-9
Weld Process Adjustment, AC Adjustment, Wave Balance, DC Offset, Frequency	B-10
Multiple Arc AC adjustments for systems equipped with K2282-1 System Interface	B-11
<hr/>	
Accessories	Section C
Kits, Options and Accessories.....	C-1
<hr/>	
Maintenance	Section D
Safety Precautions	D-1
Routine and Periodic Engine Maintenance	D-1
Calibration Specification	D-1

Troubleshooting	Section E
How to Use Troubleshooting Guide.....	E-1
Troubleshooting Guide.....	E-2 thru E-11
Using the Status LED to Troubleshoot System Problem.....	E-12
Error Codes.....	E-13, E-14

Wiring Diagrams and Dimension Print	Section F
--	------------------

Parts List	P-509
-------------------------	--------------

TECHNICAL SPECIFICATIONS - POWER WAVE® AC/DC 1000 (K2344-1, K2344-2)

INPUT AT RATED OUTPUT - THREE PHASE ONLY						
INPUT VOLTS 3 PHASE 50/60 Hz	INPUT CURRENT AMPS		OUTPUT CONDITIONS	IDLE POWER WATTS	POWER FACTOR @ RATED OUTPUT	EFFICIENCY @ RATED OUTPUT
	K2344-1	K2344-2				
380	---	82	1000A@44V. 100% Duty Cycle	225	.95	86%
400	---	79				
460	68	69				
500	62	62				
575	54	55				

OUTPUT		
OPEN CIRCUIT VOLTAGE	AUXILIARY POWER (CIRCUIT BREAKER PROTECTED)	PROCESS CURRENT RANGES (AC or DC)
25 to 100 V _{RMS}	40 VDC AT 10 AMPS 115 VAC AT 10 AMPS	SAW-DC+ } SAW-DC- } Output Range SAW-AC } 200-1000 Average Amps

RECOMMENDED INPUT WIRE AND FUSE SIZES ¹			
3 PHASE INPUT VOLTAGE 50/60Hz	TYPE 90°C COPPER WIRE ³ IN CONDUIT	COPPER GROUNDING CONDUCTOR	TIME-DELAY FUSE OR BREAKER ²
	AWG (mm ²)	AWG (mm ²)	AMPS
380	3(25)	8 (10)	100
400	3(25)	8 (10)	90
460	4(25)	8 (10)	90
500	4(25)	8 (10)	80
575	6(16)	10 (6)	70

PHYSICAL DIMENSIONS					
MODEL	CONFORMITY MARK	HEIGHT	WIDTH	DEPTH	WEIGHT
K2344-1	CSA C/UL	43.5 in 1105 mm	19.2 in 488 mm	33 in 838 mm	600 lbs. 272 kg.
K2344-2 *	 EN 60974-1 CSA C/UL	43.5 in 1105 mm	19.2 in 488 mm	33 in 838 mm	650 lbs. 296 kg.

TEMPERATURE RANGES	
OPERATING TEMPERATURE RANGE 32°F to 104°F(0°C to 40°C)	STORAGE TEMPERATURE RANGE -40°F to 185°F(-40°C to 85°C)

Insulation Class: Class F(155°C)

- Wire and Fuse Sizes based upon the U.S. National Electric Code and maximum output for 40°C (104°) ambient.
 - Also called "inverse time" or "thermal/magnetic" circuit breakers; circuit breakers that have a delay in tripping action that decreases as the magnitude of current increases.
 - Fail to use proper type of copper wire will cause fire hazards.
- * An external filter will be required to meet CE and C-Tick conducted emission requirements. It will meet CE and C-Tick requirements with the use of an optional external filter. (K2444-1 CE and C-Tick Filter Kit)

WELDING PROCESSES			
Process	Electrode Diameter Range	Output Range (Amperes)	Wire Feed Speed Range
SAW	5/64 – 7/32" (2 – 5.6 mm)	200 - 1000	21 - 300 ipm (.53 – 7.62 m/minute)

POWER WAVE® AC/DC 1000



SAFETY PRECAUTIONS

Read this entire installation section before you start installation.



WARNING



ELECTRIC SHOCK can kill.

- Only qualified personnel should perform this installation.
- Turn the input power OFF at the disconnect switch or fuse box before working on this equipment. Turn off the input power to any other equipment connected to the welding system at the disconnect switch or fuse box before working on the equipment.

- Do not touch electrically hot parts.
- Always connect the Power Wave grounding lug (located inside the reconnect input access door) to a proper safety (Earth) ground.

LOCATION AND MOUNTING

Place the welder where clean cooling air can freely circulate in through the rear louvers and out through the case sides and front. Dirt, dust, or any foreign material that can be drawn into the welder should be kept at a minimum. Do not use air filters on the air intake because the air flow will be restricted. Failure to observe these precautions can result in excessive operating temperatures and nuisance shutdowns.



CAUTION

DO NOT MOUNT OVER COMBUSTIBLE SURFACES.

Where there is a combustible surface directly under stationary or fixed electrical equipment, the surface shall be covered with a steel plate at least .06”(1.6mm) thick, which shall extend not more than 5.90”(150mm) beyond the equipment on all sides.

STACKING

Power Wave AC/DC 1000 machine cannot be stacked.

LIFTING



WARNING



FALLING EQUIPMENT can cause injury.

- Lift only with equipment of adequate lifting capacity.
- Be sure machine is stable when lifting.
- Do not lift this machine using lift bail if it is equipped with a heavy accessory such as trailer or gas cylinder.
- Do not lift machine if lift bail is damaged.
- Do not operate machine while suspended from lift bail.

Lift the machine by the lift bail only. The lift bail is designed to lift the power source only. Do not attempt to lift the Power Wave AC/DC 1000 with accessories attached to it.

ENVIRONMENTAL LIMITATIONS

Do not use the Power Wave AC/DC 1000 in an outdoor environment. The Power Wave AC/DC 1000 power source should not be subjected to falling water, nor should any parts of it be submerged in water. Doing so may cause improper operation as well as pose a safety hazard. The best practice is to keep the machine in a dry, sheltered area.

ELECTROMAGNETIC COMPATIBILITY (EMC)

The EMC classification of the Power Wave AC/DC 1000 is Industrial, Scientific and Medical (ISM) group 2, class A. The Power Wave AC/DC 1000 is for industrial use only.

Locate the Power Wave away from radio controlled machinery.



CAUTION

The normal operation of the Power Wave AC/DC 1000 may adversely affect the operation of RF controlled equipment, which may result in bodily injury or damage to the equipment.

POWER WAVE® AC/DC 1000



INPUT AND GROUND CONNECTIONS

MACHINE GROUNDING



The frame of the welder must be grounded. A ground terminal marked with the symbol shown is located inside the reconnect / input access door for this purpose. See your local and national electrical codes for proper grounding methods.

INPUT CONNECTION



ELECTRIC SHOCK can kill.



- Only a qualified electrician should connect the input leads to the Power Wave. Connections should be made in accordance with all local and National Electrical Codes and the connection diagram located on the inside of the reconnect / input access door of the machine. Failure to do so may result in bodily injury or death.

Use a three-phase supply line. A 1.75 inch (45 mm) diameter access hole for the input supply is located on the case back. Connect L1, L2, L3 and ground according to the Input Supply Connection Diagram.

INPUT FUSE AND SUPPLY WIRE CONSIDERATIONS

Refer to Specifications page for recommended fuse and wire sizes. Fuse the input circuit with the recommended super lag fuse or delay type breakers (also called "inverse time" or "thermal/magnetic" circuit breakers). Choose input and grounding wire size according to local or national electrical codes. Using fuses or circuit breakers smaller than recommended may result in "nuisance" shut-offs from welder inrush currents, even if the machine is not being used at high currents.

INPUT VOLTAGE SELECTION

Welders are shipped connected for the highest input voltage listed on the rating plate. To move this connection to a different input voltage, see the diagram located on the inside of the input access door, or the Reconnect Diagram K2344-1 and K2344-2 shown below. If the Auxiliary lead (indicated as 'A') is placed in the wrong position, there are two possible results. If the lead is placed in a position higher than the applied line voltage, the welder may not come on at all. If the Auxiliary lead is placed in a position lower than the applied line voltage, the welder will not come on, and the two circuit breakers in the reconnect area will open. If this occurs, turn off the input voltage, properly connect the auxiliary lead, reset the breakers, and try again.

Reconnect Diagram for K2344-1 Power Wave AC/DC 1000

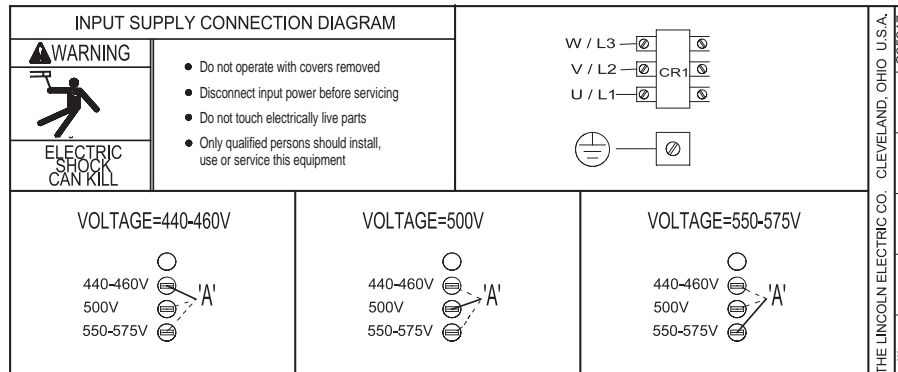

Reconnect Diagram for K2344-2 Power Wave AC/DC 1000 ("CE – ready")

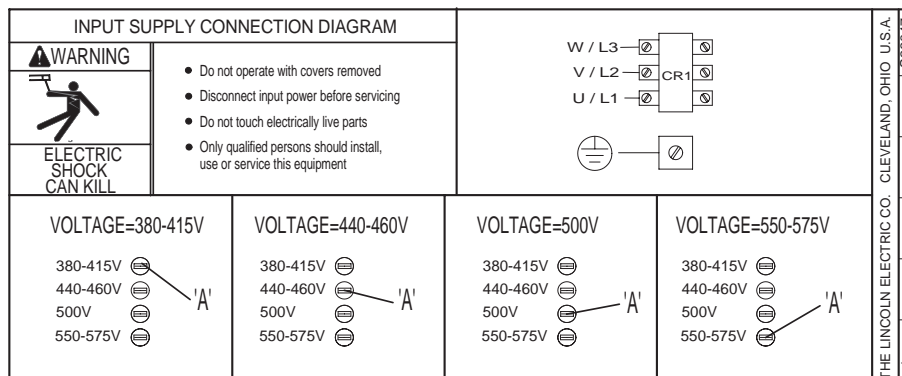

POWER WAVE® AC/DC 1000



SYSTEM CONNECTION

System Overview

The Power Wave AC/DC 1000 power source is designed to be a part of a modular welding system typically controlled by a **Power Feed 10A Controller** or customer supplied **Programmable Logic Controller (PLC)**. Each welding arc may be driven by a single power source or by a number of power sources connected in parallel. The actual number of power sources per arc will vary depending on the application. When only one power source is required for an arc group, it must be configured as a Master. When multiple parallel machines are required, one is designated as the Master and the rest as Slaves. The Master controls the AC switching for the arc group, and the Slaves respond accordingly.

When employed in a multi-arc AC system it is beneficial to synchronize the arcs to each other. The Master for each arc can be configured to follow a dedicated external synchronization signal to determine its frequency and balance. The optional Power Wave System Interface provides the means to synchronize the AC wave shapes of up to four different arcs to a common carrier frequency. This frequency can range from 10 hertz to 300 hertz, with the most practical range being 10 to 100 hertz. It can also control the phase angle between arcs to reduce the effects of welding related issues such as "Arc Blow".

The arc to arc phase relationship is determined by the timing of each arc's "sync" signal relative to the "sync" signal of ARC 1.

In a typical multi-arc system, each arc is controlled by its own Power Feed 10A Controller. The basic characteristics of the individual arcs such as WFS, amplitude, and offset are set locally by each arc's dedicated controller. The frequency, balance, and phase shift parameters of each arc are controlled by the Power Feed 10A Controller for ARC 1, which must be connected to its Master through the Power Wave System Interface (see multi-arc Connection Diagrams on the next few pages).

A PLC interface is an alternate method of control for larger systems. The PLC is typically connected via DeviceNet directly to the Power Wave System Interface, and the Master power source of each arc group in the system.

The following list of Recommended and Optional equipment is included as a reference for the following connection diagrams. The connection diagrams describe the layout of three typical systems. Each diagram has a step by step Installation Checklist. Additionally, a dedicated diagram has been provided detailing the parallel connection of machines for extra output capacity which can be applied to the system diagrams as required.

INSTALLATION

RECOMMENDED EQUIPMENT

System Identifier	Part No.	Description	Single Arc ⁴	Tandem Arc ⁴	Triple Arc ^{3,4}
Power Source	K2344-1 -or- K2344-2	Power Wave AC/DC 1000 Power Source	1 ¹	2 ¹	3 ¹
Weld Cables	K2163-xx -or- K1842-xx	Welding Power Cables Power Source to contact Nozzle, and Power Source to Work K2163 Series cables sold in pairs. K1842 Series cables sold individually. See Price Book for details and bulk cable availability.	Refer to "Output Cable Guidelines" for recommended size and quantity		
Head	K2370-1 -or- K2312-1	Power Feed 10S Head for 3/32 to 7/32 in. solid wire (includes hopper, wire straightener, cross seam adjuster, head mounting hardware, and 2 - 5ft 4/0 weld cables). Power Feed 10S Head for 3/32 to 7/32 in. solid wire (fixture builder's head, with wire straightener - insulators not included).	1 ²	2 ²	3 ²
Torch	K231-xxx	Submerged Arc Contact Nozzle Assembly	1	2	3
Power Source to Head Control Cable	K1785-xx	Feeder Control Cable (14 pin).	1 ²	2 ²	3 ²
User Interface	K2362-1	Power Feed 10A Controller	1 ^{2,4}	2 ^{2,4}	---
ArcLink Digital Communication Cable	K1543-xx 5	ArcLink Control Cables (5 pin). Single Arc: (1) PF-10A Controller to the power source Tandem Arc: (1) Lead Arc to System Interface (2) System Interface to Lead Arc PF-10A Controller (3) Trail Arc to Trail Arc PF-10A Controller Triple Arc: (1) Lead Arc to System Interface	1	3	1
PLC (w/ User Interface)	Customer Supplied	Programmable Logic Controller (DeviceNet compatible)	---	---	1 ⁴
DeviceNet Cables and Accessories	Automation Department or Customer Supplied	DeviceNet Cables, Tees, and Terminators (5 pin) sealed "mini style") form a trunk style network con- necting PLC to each power source and the System Interface. For additional information refer to the "DeviceNet Cable Planning and Installation Manual" (Allen Bradley publication DN-6.7.2).	---	---	Cables, Tees, and Terminators as required per Triple Arc Connection Diagram ⁴
System Interface	K2282-1	Power Wave System Interface provides the means to synchronize the AC wave shapes of up to four different arcs to a common carrier frequen- cy, and control the phase angle between them to reduce the effects of "Arc Blow".	---	1 ²	1 ²
System Interface to Power Source Control Cable	K1795-xx 5	Control Cable (22 pin) connects between each power source and the System Interface.	---	2 ²	3 ²

Notes:

- "Recommended Quantity" assumes one power source per arc. Multiple power sources may be used to increase the output capacity per arc (see "Connection Diagram - Parallel Machines").
- Control Cable connections only required at the Master of each parallel power source arc grouping.
- Can be expanded to 4 or more arcs (Note: The System Interface can currently only synchronize up to four AC arc groupings).
- The triple arc system is an economical breakpoint for a PLC Interface. It does not preclude the use of a PLC for single or tandem arc systems, nor PF-10A's from being used to control multiple arc systems with greater than two arcs.
- Cables can be connected end to end to extend length.

POWER WAVE® AC/DC 1000



INSTALLATION

OPTIONAL EQUIPMENT

System Identifier	Part No.	Description
Ethernet Network Equipment	Customer Supplied	Ethernet Switch, Cables, etc. required for arcs > 1000A, or for use of Power Wave Submerged Arc Utilities software package.
Personal Computer	Customer Supplied	IBM Compatible PC (Windows NT SP6, Windows 2000, Windows XP, or greater) required for use with Power Wave Submerged Arc Utilities software package.
Travel Carriage	K325-x	TC-3 Self-Propelled Travel Carriage for traversing standard carriage beam (per G1458)
Travel Carriage (High Capacity)	K325-HCx	TC-3 Self-Propelled High Capacity Travel Carriage for traversing standard carriage beam (per G1458)
Controller Mounting Bracket User Interface	K2462-1	PF-10A Mounting Bracket mounts PF-10A Controller to left side of TC-3 carriage. Brackets can be cascaded to accommodate more than one controller. Note: Bracket uses mounting holes reserved for K299 Wire Reel Assembly (see Wire Reel Mounting options for additional information).
Horizontal Adjuster	K96	Horizontal Lift Adjuster provides 2" (51mm) crank adjustment of horizontal head position.
Vertical Adjuster	K29	Vertical Lift Adjuster provides 4" (102mm) crank adjustment of vertical head position. Also provides 3.37" (95mm) in-and-out horizontal adjustment with movable stops for repeatability.
Wire Reel Mounting (single)	K299	Wire Reel Assembly accommodates one 50-60 lb (22.7-27.2 kg) coil, includes mounting spindle and braking system. Mounts to left side of TC-3 Std. or High Capacity Travel Carriage (K325-x). Cannot be mounted to TC-3 when K2462-1 PF-10A Mounting Bracket is used (use K390 instead).
Wire Reel Mounting (dual)	K390	Electrode Reels and Mountings for mounting up to two 50-60 lb (22.7-27.2 kg) coils, includes mounting spindle and braking system. Mounts to top of TC-3 High Capacity Travel Carriage (K325-HCx). Does not interfere with K2462-1 PF-10A Mounting Bracket.
Mounting for Dual Head	K387	Tandem Arc Framework includes hex style framework and mounting hardware to attach two PF-10S or PF-10SF heads directly to a high capacity TC-3 carriage, or user supplied fixture or gantry.
Flux Hopper	K219	Flux Hopper with electric flux valve for Submerged Arc welding.
Flux Hopper	K389	Flux Hopper with electric flux valve, for K387 tandem mounting. Mounts directly to hex crossbar.
Remote Wire Drive Module	K2626-1	For wire drive applications greater than 100ft.

POWER WAVE® AC/DC 1000



Connection Diagram- Typical Single Arc System (Power Feed 10A Controller)

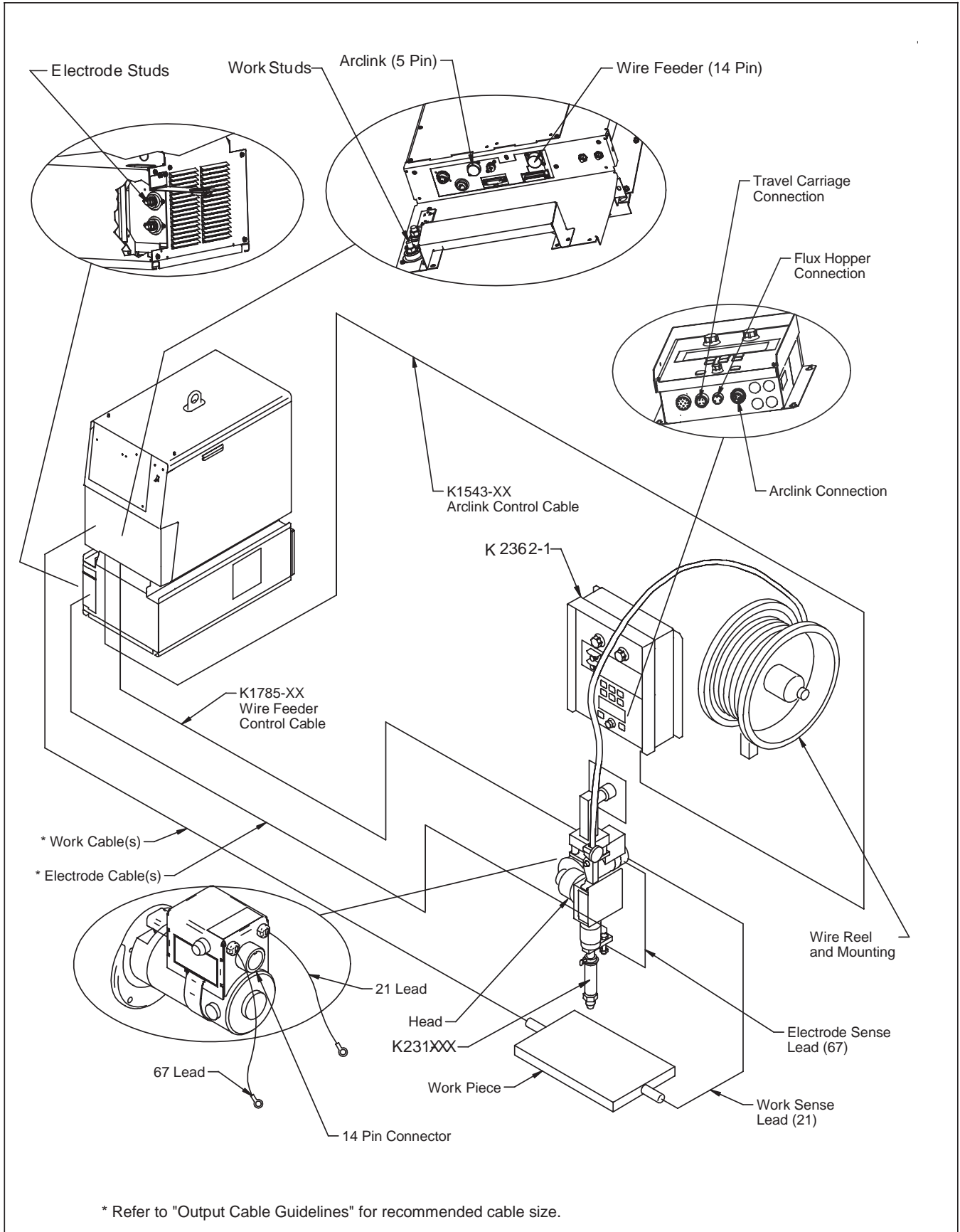

POWER WAVE® AC/DC 1000



STEP BY STEP INSTALLATION CHECKLIST**SINGLE ARC SYSTEM CHECKLIST – (PF-10A CONTROLLED, 1 POWER SOURCE)**
(as shown in the Connection Diagram "Typical Single Arc System")

- Place Power Wave in suitable operating location.
- Mount PF10A Controller.
- Install PF10S Wire Drive and other accessories in their operating location.
- Connect K1785-xx Wire Feeder Control Cable (14 pin) between the Power Wave and Wire Drive.⁽¹⁾
- Connect K1543-xx ArcLink Control Cable (5 pin) between Power Wave and PF10A.⁽¹⁾
- Configure / Install sense leads.
- Connect / Install welding cables per recommended "Output Cable Guidelines."
- Open all Power Wave front panel and configure DIP switch settings per "Internal Controls" section.
- Connect input power to Power Wave per recommended guidelines.
- Turn on Power Wave, and verify all system Status Lights are solid green.

NOTES:

- (1) ArcLink and Wire Feeder control cable connections are only required at the Master power source of each arc grouping. For additional information see the "Extra Capacity Parallel Connection Checklist."

Connection Diagram- Typical Tandem Arc System (Power Feed 10A Controller)

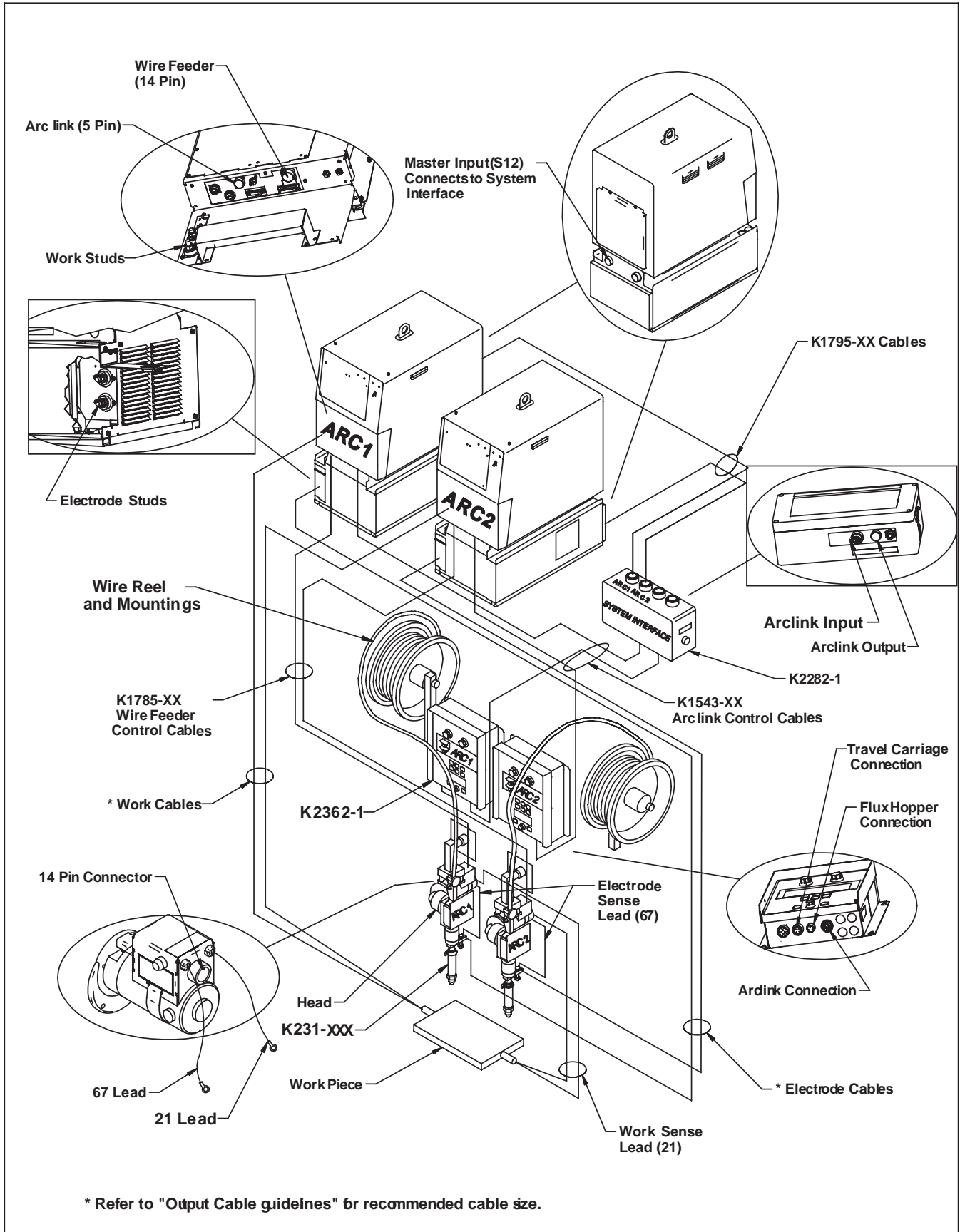

POWER WAVE® AC/DC 1000



STEP BY STEP INSTALLATION CHECKLIST**TANDEM ARC SYSTEM CHECKLIST – (PF-10A CONTROLLED, 1 POWER SOURCE PER ARC)**
(as shown in the Connection Diagram "Typical Tandem Arc System")

- Place Power Waves in suitable operating location.
- Mount PF10A Controllers.
- Install PF10S Wire Drives and other accessories in their operating location.
- Mount Power Wave System Interface.
- Connect K1785-xx Wire Feeder Control Cable (14 pin) between each Power Wave and Wire Drive.⁽¹⁾
- Connect K1543-xx ArcLink Control Cables (5 pin) from Power Wave #1 to the System Interface input, and from the System Interface output to the PF10A Controller for ARC #1.⁽¹⁾
- Connect K1543-xx ArcLink Control Cable (5 pin) between Power Wave #2 and the PF10A Controller for ARC #2.⁽¹⁾
- Connect K1795-xx System Control Cables (22 pin) between each Power Wave and the System Interface. ⁽²⁾
- Configure / Install sense leads.
- Connect / Install welding cables per recommended "Output Cable Guidelines."
- Open all Power Wave front panels and configure DIP switch settings per "Internal Controls" section.
- Connect input power to Power Waves per recommended guidelines.
- Turn on Power Waves, and verify all system Status Lights are solid green.

NOTES:

- (1) ArcLink and Wire Feeder control cable connections are only required at the Master power source of each arc grouping. For additional information see the "Extra Capacity Parallel Connection Checklist."
- (2) The "ARC" (formerly "PHASE") connections from the System Interface are only required for the Master power source of each arc grouping. For additional information see the "Extra Capacity Parallel Connection Checklist."

Connection Diagram- Typical Triple Arc System (DeviceNet PLC Controller)

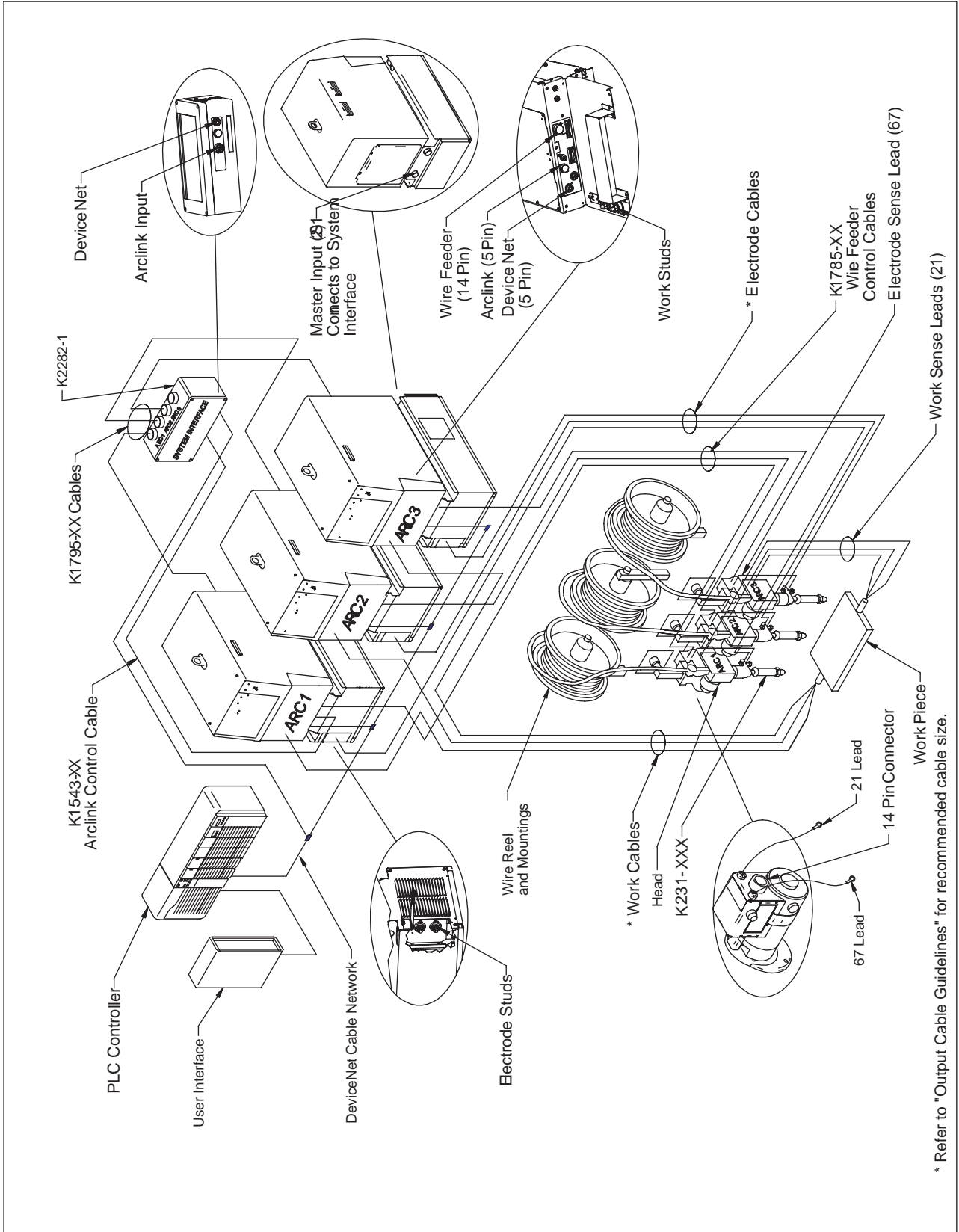

* Refer to "Output Cable Guidelines" for recommended cable size.

STEP BY STEP INSTALLATION CHECKLIST**TRIPLE ARC SYSTEM CHECKLIST – (DEVICENET PLC CONTROLLED, 1 POWER SOURCE PER ARC)**
(as shown in the Connection Diagram "Typical Triple Arc System")

- Place Power Waves in suitable operating location.
- Mount DeviceNet PLC Controller and User Interface.
- Install PF10S Wire Drives and other accessories in their operating location.
- Mount Power Wave System Interface.
- Connect K1785-xx Wire Feeder Control Cable (14 pin) between each Power Wave and Wire Drive.⁽¹⁾
- Connect K1543-xx ArcLink Control Cable (5 pin) from ARC #1 power source to the System Interface input.⁽¹⁾
- Connect K1795-xx System Control Cables (22 pin) between each Power Wave and the appropriate System Interface "ARC" (formerly "PHASE") outputs. ⁽²⁾
- Connect the System Interface and each power source to the PLC via the DeviceNet network.⁽¹⁾
- Configure / Install sense leads.
- Connect / Install welding cables per recommended "Output Cable Guidelines."
- Open all Power Wave front panels and configure DIP switch settings (including the DeviceNet MAC ID and Baud Rate settings) per "Internal Controls" section.
- Connect input power to Power Waves per recommended guidelines.
- Turn on Power Waves, and verify all system Status Lights are solid green.

NOTES:

- (1) ArcLink, DeviceNet and Wire Feeder control cable connections are only required at the Master power source of each arc grouping. For additional information see the "Extra Capacity Parallel Connection Checklist."
- (2) The "ARC" (formerly "PHASE") connections from the System Interface are only required for the Master power source of each arc grouping. For additional information see the "Extra Capacity Parallel Connection Checklist."

Connection Diagram- Parallel Machines

(Example depicts a single arc grouping, and may be repeated for each arc in the system)

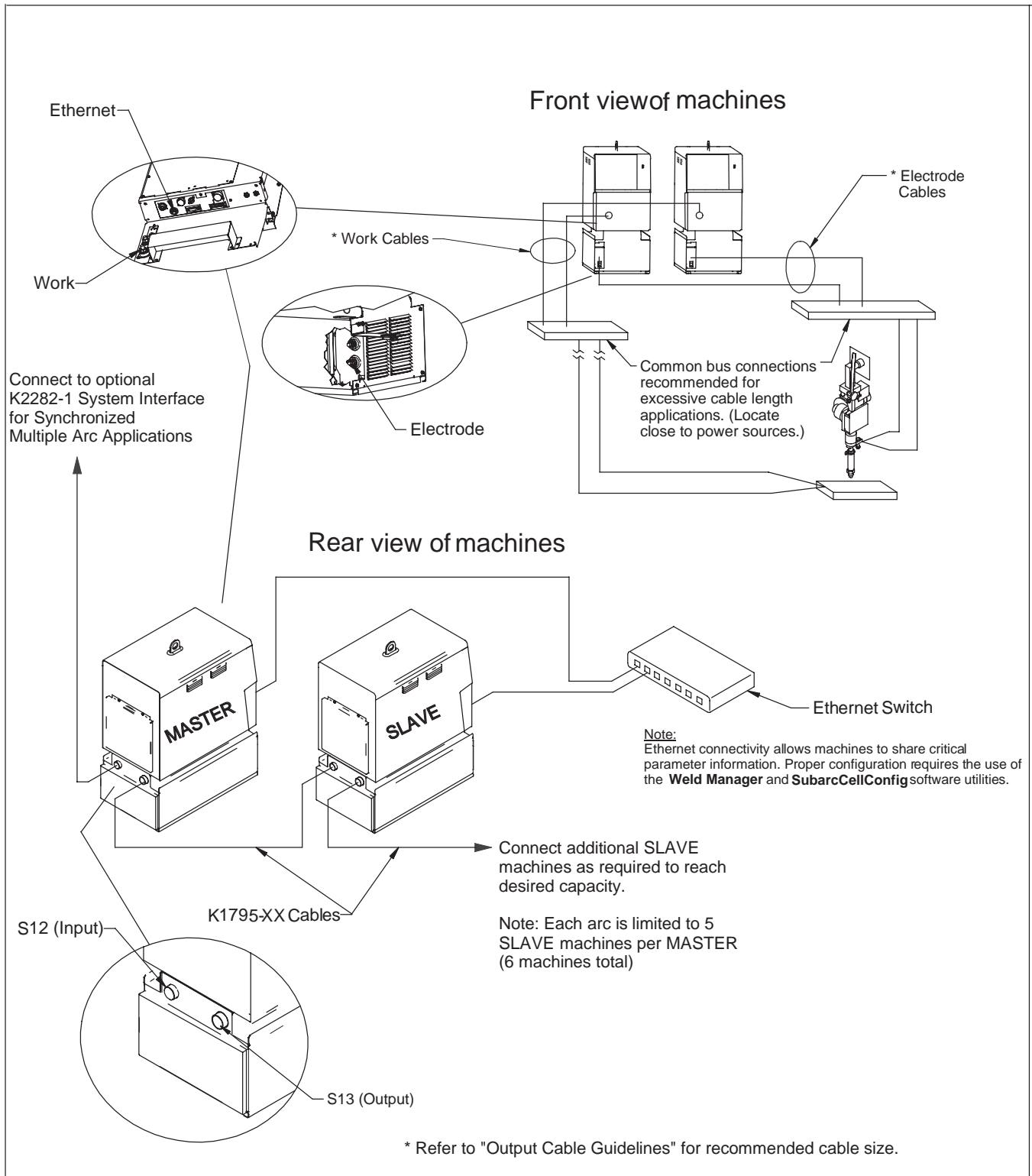

POWER WAVE® AC/DC 1000



STEP BY STEP INSTALLATION CHECKLIST

EXTRA CAPACITY PARALLEL CONNECTION

(as shown in the Connection Diagram "Parallel Machines")

- Follow all steps of Single, Tandem, or Triple Arc checklists.
- Be sure input power is disconnected prior to following the remaining steps.
- Control Cable Connections:
 - PF-10S Connections:**
 - Each PF-10S must be connected to the Master power source of its associated arc.
 - PF-10A Controlled Systems:**
 - Each PF-10A Controller must be connected to the Master power source of its arc via a K1543-xx ArcLink Control Cable (5 pin), but should not be connected to the Slave(s).
 - In a multi-arc system, the System Interface must also be connected to the ARC #1 Master power source via a K1543-xx ArcLink Control Cable (5 pin).
 - DeviceNet PLC Controlled Systems:**
 - Only the Master power source of each arc should be connected to the PLC Controller via the DeviceNet network.
 - In a multi-arc system, the System Interface must connected to the PLC via the DeviceNet network. It must also be connected to the ARC #1 Master power source via a K1543-xx ArcLink Control Cable (5 pin).
- Connect K1795-xx System Control Cables (22 pin) between the Master and Slaves of each arc grouping per the Parallel Machines Connection Diagram.
- Connect / Install welding cables per the recommended "Output Cable Guidelines" and the "Parallel Machines Connection Diagram" for each arc grouping.
- Configure / Install sense leads (the sense lead configuration of all machines in a given parallel arc grouping must be the same).
- Open Power Wave front panels and configure DIP switch settings per "Internal Controls" section.
- Connect Power Wave to LAN (Local Area Network). See "Connection Between Power Source and Ethernet Network."
- Connect input power to Power Waves per recommended guidelines.
- Turn on Power Waves.
- Configure network settings using **Weld Manager** software utility (follow instructions provided).
- Run the **Submerged Arc Cell Configuration** software utility to configure the Master / Slave relationships of each arc grouping (follow instructions provided).

ELECTRODE AND WORK CONNECTIONS

General Guidelines

The unique switching structure of the Power Wave AC/DC 1000 allows it to produce DC positive, DC negative or AC output waveforms without repositioning the work and electrode leads. Additionally, no DIP switch changes are required to switch between the different polarities. All of this is controlled internally by the Power Wave AC/DC 1000, and based exclusively on the weld mode selection.

The following recommendations apply to all output polarities and weld modes:

- **Select the appropriate size cables per the "Output Cable Guidelines" below.** Excessive voltage drops caused by undersized welding cables and poor connections often result in unsatisfactory welding performance. Always use the largest welding cables (electrode and work) that are practical, and be sure all connections are clean and tight.

Note: Excessive heat in the weld circuit indicates undersized cables and/or bad connections.

- **Route all cables directly to the work and wire feeder, avoid excessive lengths and do not coil excess cable.** Route the electrode and work cables in close proximity to one another to minimize the loop area and therefore the inductance of the weld circuit.

- **Always weld in a direction away from the work (ground) connection.**

TABLE A.1 - Output Cable Guidelines

Total Cable Length ft (m) Electrode and Work Combined	Duty Cycle	Number of Parallel Cables	Cable Size Copper
0 (0) to 250 (76.2)	80%	2	4/0 (120 mm ²)
0 (0) to 250 (76.2)	100%	3	3/0 (95 mm ²)

Electrode Connections

Connect an electrode cable of sufficient size and length (Per Table A.1) to the "electrode" stud on the power source (located behind the cover plate on the lower left side). For convenience, the cable can be routed down through the two holes in the left cable tray before being connected to the output terminals. Connect the other end of the electrode cable to the wire drive feed plate on the wire feeder. Be sure the connection to the feed plate makes tight metal-to-metal electrical contact.

For parallel applications with excessive electrode cable lengths, a common bus connection should be used. The common electrode connection serves to minimize voltage drops associated with resistive losses in the electrode path. It should be made of copper, and located as close as possible to the power sources. (See "Connection Diagram – Parallel Machines")

Work Connections

Connect a work lead of sufficient size and length (Per Table 1) between the "work" stud (located beneath the spring loaded output cover on the top, front of the machine) and the work piece. For convenience, the work lead can be routed along the left cable tray, and out the back of the machine. Be sure the connection to the work makes tight metal-to-metal electrical contact.

For parallel and/or multiple arc applications with excessive ground path lengths, a common work connection bus should be used. The common work connection serves to minimize voltage drops associated with resistive losses in the ground paths. It should be made out of copper, and located as close as possible to the power sources (See Common Connection Diagram).

Common Connection Diagram

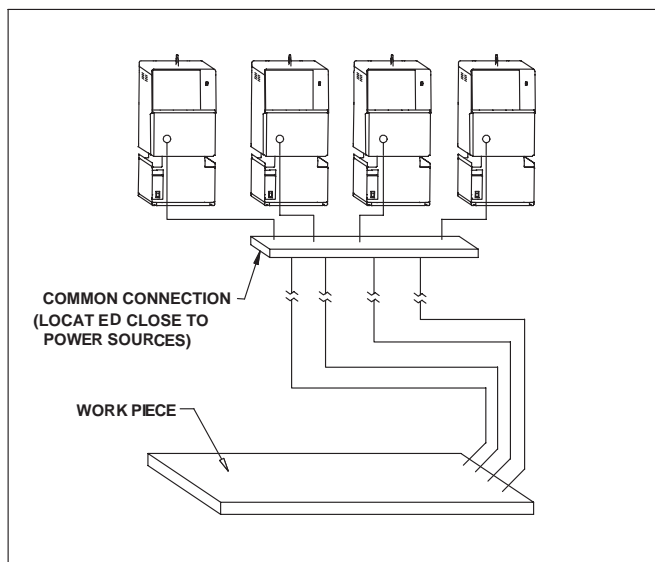

CABLE INDUCTANCE, AND ITS EFFECTS ON WELDING

Excessive cable inductance will cause the welding performance to degrade. There are several factors that contribute to the overall inductance of the cabling system including cable size, and loop area. The loop area is defined by the separation distance between the electrode and work cables, and the overall welding loop length. The welding loop length is defined as the total of length of the electrode cable (A) + work cable (B) + work path (C) (see Figure A.1 below). To minimize inductance always use the appropriate size cables, and whenever possible, run the electrode and work cables in close proximity to one another to minimize the loop area. Since the most significant factor in cable inductance is the welding loop length, avoid excessive lengths and do not coil excess cable. For long work piece lengths, a sliding ground should be considered to keep the total welding loop length as short as possible.

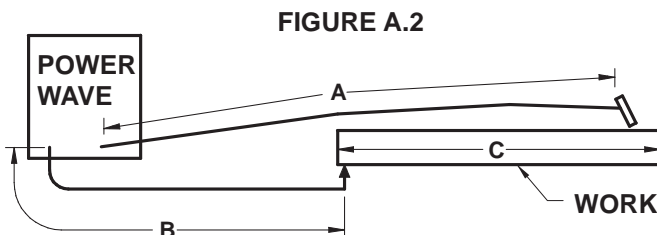

REMOTE SENSE LEAD CONNECTIONS

Voltage Sensing Overview

The best arc performance occurs when the Power Wave AC/DC 1000 has accurate data about the arc conditions. Depending upon the process, inductance within the electrode and work cables can influence the voltage apparent at the studs of the welder, and have a dramatic effect on performance. To counteract this negative effect, remote voltage sense leads are used to improve the accuracy of the arc voltage information supplied to the control pc board.

There are several different sense lead configurations that can be used depending on the application. In extremely sensitive applications it may be necessary to route cables that contain the sense leads away from the electrode and work welding cables.

⚠ CAUTION

If the remote voltage sensing is enabled but the sense leads are missing, improperly connected, or if the electrode polarity switch is improperly configured extremely high welding outputs may occur.

Electrode Voltage Sensing

The remote ELECTRODE sense lead (67) is built into the wire feeder control cable (K1785) and accessible at the wire drive. It should always be connected to the wire drive feed plate when a wire feeder is present. Enabling or disabling electrode voltage sensing is application specific, and automatically configured through software.

Work Voltage Sensing

For most applications the use of a remote work voltage sense lead is recommended. The Power Wave AC/DC 1000 is shipped from the factory with the remote work voltage sense lead enabled. It must be attached to the work as close to the weld as practical, but out of the weld current path. For more information regarding the placement of remote work voltage sense leads, see the section entitled "Voltage Sensing Considerations for Multiple Arc Systems." The remote WORK sense lead (21) can be accessed at one of two locations. Either at the wire drive via the wire feeder control cable (K1785), or at the four-pin WORK sense lead connector located under the spring loaded output cover. Whenever possible, use the WORK sense lead that is built into wire feeder control cable (K1785) since it is closely coupled with the ELECTRODE sense lead and will tend to be more immune to electrical noise. If it is not possible to sense the WORK voltage near the feeder, the four-pin WORK sense lead connector at the power source should be used (a plug and pigtail assembly is provided for this purpose).

⚠ CAUTION

Never connect the WORK sense lead at two different locations.

⚠ WARNING

ELECTRIC SHOCK can kill.



- Do not touch electrically live parts or electrodes with your skin or wet clothing.
- Insulate yourself from the work and ground.
- Always wear dry insulating gloves.

Some simplified applications may perform adequately by sensing the work voltage directly at the WORK STUD without the use of a remote work voltage sense lead. If a remote work voltage sense lead is not used, it must be disabled as follows:

1. Turn off power to the power source at the disconnect switch.
2. Remove the front cover from the power source.

- c. Locate the 8-position DIP switch on the control board and look for switch 8 of the DIP switch.
- d. Using a pencil or other small object, **slide the switch to the OFF position** if the **work sense lead is NOT connected**. Conversely, **slide the switch to the ON position** if the **work sense lead is present**.

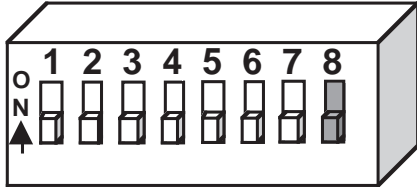

- e. Replace the cover and screws. The PC board will read the switch at power up, and configure the work voltage sense lead appropriately.

Voltage Sensing for "Slave" machines

If "Slave" machines are configured to use remote voltage sensing they receive these signals directly from the "Master" machine. The K1795 control cable used for parallel connection of machines contains both the ELECTRODE sense lead (67) and the WORK sense lead (21). No other external sense lead connections are required for "Slave" machines.

NOTE: All of the machines of a given arc group (both Master and Slaves) must have their work voltage sensing configured identically. All must either use a remote lead or sense directly from the stud. For additional information see the "Work Voltage Sensing" section of this document.

VOLTAGE SENSING CONSIDERATIONS FOR MULTIPLE ARC SYSTEMS

Special care must be taken when more than one arc is welding simultaneously on a single part. Multiple arc applications do not necessarily dictate the use of remote work voltage sense leads, but they are strongly recommended.

If Sense Leads ARE NOT Used:

- **Avoid common current paths.** Current from adjacent arcs can induce voltage into each others current paths that can be misinterpreted by the power sources, and result in arc interference.

If Sense Leads ARE Used:

- **Position the sense leads out of the path of the weld current.** Especially any current paths common to adjacent arcs. Current from adjacent arcs can induce voltage into each others current paths that can be misinterpreted by the power sources, and result in arc interference.
- **For longitudinal applications,** connect all work leads at one end of the weldment, and all of the work voltage sense leads at the opposite end of the weldment. Perform welding in the direction away from the work leads and toward the sense leads.

(See Figure A.2)

FIGURE A.2

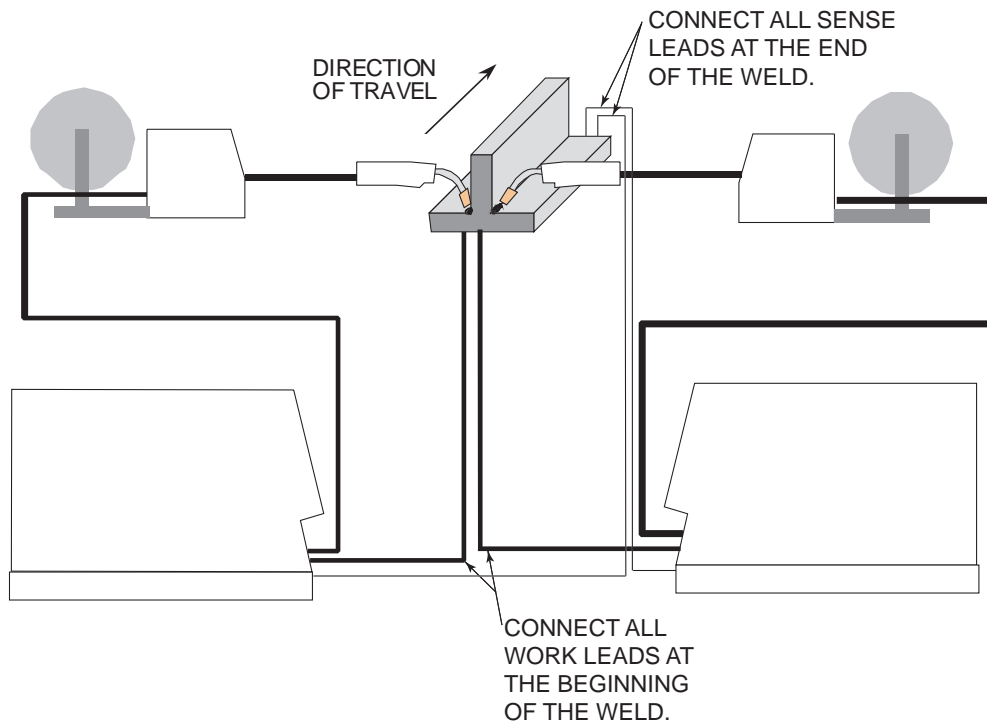

POWER WAVE® AC/DC 1000



- For circumferential applications, connect all work leads on one side of the weld joint, and all of the work voltage sense leads on the opposite side, such that they are out of the current path.

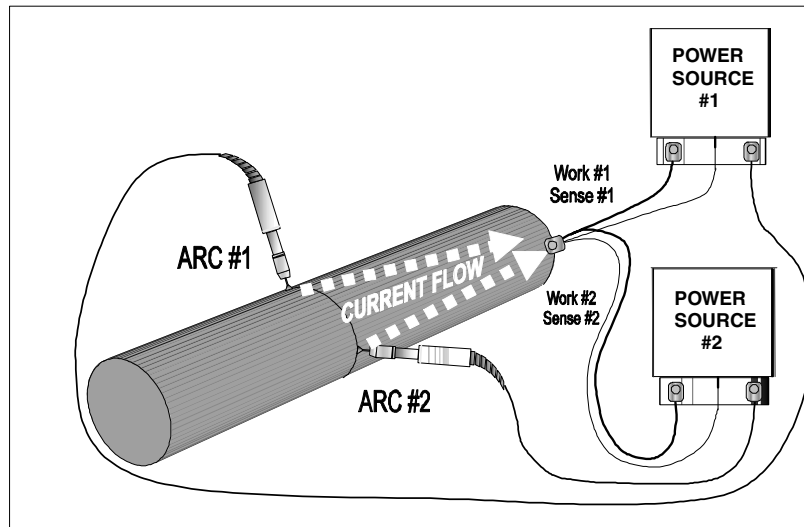

BAD

- CURRENT FLOW FROM ARC #1 AFFECTS SENSE LEAD #2
- CURRENT FLOW FROM ARC #2 AFFECTS SENSE LEAD #1
- NEITHER SENSE LEAD PICKS UP THE CORRECT WORK VOLTAGE, CAUSING STARTING AND WELDING ARC INSTABILITY

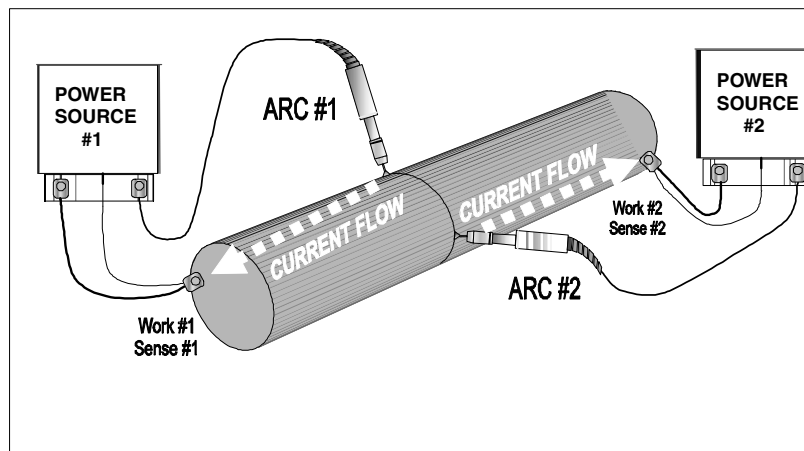

BETTER

- SENSE LEAD #1 IS ONLY AFFECTED BY CURRENT FLOW FROM ARC #1
- SENSE LEAD #2 IS ONLY AFFECTED BY CURRENT FLOW FROM ARC #2
- DUE TO VOLTAGE DROPS ACROSS THE WORKPIECE ARC VOLTAGE MAY BE LOW, CAUSING NEED FOR DEVIATION FROM STANDARD PROCEDURES

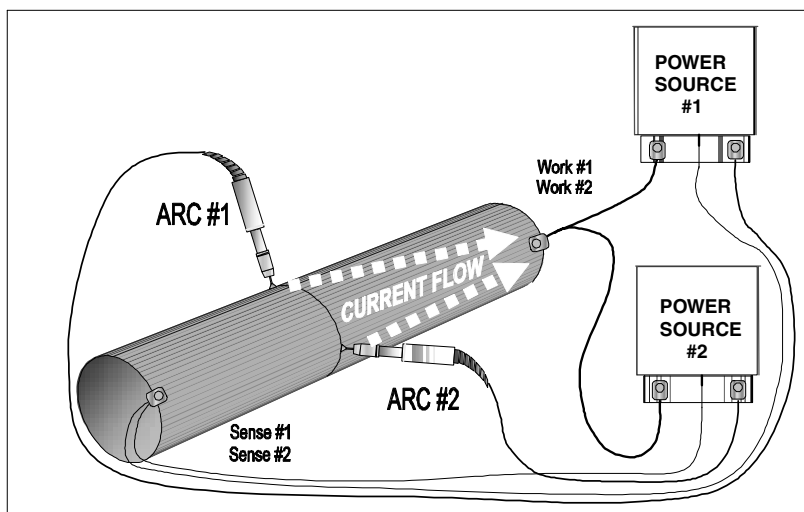

BEST

- BOTH SENSE LEADS ARE OUT OF THE CURRENT PATHS
- BOTH SENSE LEADS DETECT ARC VOLTAGE ACCURATELY
- NO VOLTAGE DROP BETWEEN ARC AND SENSE LEAD
- BEST STARTS, BEST ARCS, MOST RELIABLE RESULTS

CONTROL CABLE CONNECTIONS

General Guidelines

Genuine Lincoln control cables should be used at all times (except where noted otherwise). Lincoln cables are specifically designed for the communication and power needs of the Power Wave / Power Feed systems. Most are designed to be connected end to end for ease of extension. However, it is recommended that the total length not exceed 100 feet (30.5 m). The use of non-standard cables, especially in lengths greater than 25 feet, can lead to communication problems (system shutdowns), poor motor acceleration (poor arc starting), and low wire driving force (wire feeding problems). Always use the shortest length of control cable possible, and DO NOT coil excess cable.

Regarding cable placement, best results will be obtained when control cables are routed separate from the weld cables. This minimizes the possibility of interference between the high currents flowing through the weld cables, and the low level signals in the control cables. These recommendations apply to all communication cables including optional DeviceNet and Ethernet connections.

COMMON EQUIPMENT CONNECTIONS

Connection Between Power Source and Power Feed 10S Series Wire feeder (K1785 - Control Cable). The 14-pin wire feeder control cable connects the power source to the wire drive. If there is more than one power source per arc, it connects from the wire drive to the power source designated as the Master. It contains all of the necessary signals to drive the motor and monitor the arc, including the motor power, tachometer, and arc voltage feedback signals. The wire feeder connection on the Power Wave AC/DC 1000 is located under the spring loaded output cover on the case front. The control cable is keyed and polarized to prevent improper connection. For convenience, the control cables can be routed along the right channel of the Power Wave, out the back, and to the wire feeder. Control cables SHOULD NOT be routed through the same (left) channel as the welding cables.

Connection Between Power Source and Power Feed 10A Controller (K1543 – ArcLink Control Cable). Single and tandem arc systems are typically controlled by a Power Feed 10A Controller (K2362-1). In a tandem, or multi-arc system, each arc requires its own dedicated Power Feed 10A (PF-10A).

The 5-pin ArcLink control cable connects the power source to the PF-10A. If there is more than one power source per arc, it connects from the PF-10A to the power source designated as the Master for that arc. The control cable consists of two power leads, one twisted pair for digital communication, and one lead for voltage sensing. The ArcLink connection on the Power Wave AC/DC 1000 is located under the spring loaded output cover on the case front. The control cable is keyed and polarized to prevent improper connection. For convenience, the control cables can be routed along the right channel of the Power Wave, out the back, and to the PF-10A. Control cables SHOULD NOT be routed through the same (left) channel as the welding cables.

In multiple arc systems equipped with a Power Wave System Interface (K2282-1), and controlled by PF-10A controllers, the system interface must be connected to the ArcLink network of the ARC1 Master power source. See the "Tandem Arc Connection Diagram" for detailed information.

Connections Between Power Source and Optional DeviceNet Programmable Logic Controller(PLC). It is sometimes more practical and cost effective to use a custom PLC interface to control a multi-arc system (refer to the "DeviceNet Configuration" section for interface information). The Power Wave AC/DC 1000 is equipped with a 5-pin DeviceNet mini style receptacle for this purpose. The receptacle is located under the spring loaded output cover on the case front. The DeviceNet cable is keyed and polarized to prevent improper connection. For convenience, it can be routed along the right channel of the Power Wave, and out the back. DeviceNet cables SHOULD NOT be routed through the same (left) channel as the welding cables.

In a typical system, a DeviceNet connection is made between the master power source of each arc, and the PLC interface. When a Power Wave System Interface (K2282-1) is used to synchronize the arcs, it must also be connected to the DeviceNet network. For best results, route DeviceNet cables away from weld cables, wire drive control cables, or any other current carrying device that can create a fluctuating magnetic field. DeviceNet cables must be sourced locally by the customer. For additional guidelines refer to the "DeviceNet Cable Planning and Installation Manual" (Allen Bradley publication DN-6.7.2).

Connections Between Multiple Power Sources Run in Parallel (K1795 - Control Cable). To increase the output capacity for a given arc, the output studs of multiple Power Wave AC/DC 1000 machines can be connected in parallel. The parallel machines utilize a master/slave control scheme to distribute the load and coordinate AC switching. The 22 pin parallel control cable contains all of the necessary signals to keep the machine outputs synchronized, including polarity, ready, kill, and arc voltage feedback signals. The cable connects between the Master/Slave I/O connectors (S12 & S13) located on the rear of the Power Wave AC/DC 1000. The input connector (S12) is located on the lower left side of the case back (as viewed from the rear), and the output connector (S13) is located on the lower right side. The output connector (S13) on the master connects to the input connector (S12) on the slave. If needed the output connector on the slave machine can be used to connect to the input connector of another slave machine in a daisy chain fashion. This connection scheme can be repeated as required until the desired output capacity is achieved. The system is currently limited to a maximum of 5 slaves per master, or a total of 6 machines per arc.

NOTE: In addition to the parallel control cable, parallel connected machines also require an Ethernet connection to share critical weld parameter information. For more information refer to the "Connections Between a Power Source and Ethernet Network" section of this document.

Connection Between Power Source and Ethernet Network. Ethernet connections are required for systems with parallel connected power sources (more than one power source per arc), or to utilize the tools provided in the Power Wave Submerged Arc Utilities software package. To facilitate this, the Power Wave AC/DC 1000 is equipped with an RJ-45 Ethernet connector, which is located under the spring loaded output cover. External Ethernet equipment (cables, switches, etc.) must be supplied by the customer. It is critical that all Ethernet cables external to either a conduit or an enclosure are solid conductor, shielded cat 5 cable, with a drain. The drain should be grounded at the source. The use of cat 5+, cat 5E, cat 6 or stranded cable is not recommended. For best results, route Ethernet cables away from weld cables, wire drive control cables, or any other current carrying device that can create a fluctuating magnetic field. For additional guidelines refer to ISO/IEC 11801. Failure to follow these recommendations can result in an Ethernet connection failure during welding.

NOTE: See Ethernet Configuration section for additional information.

Connections Between a Power Source and System Interface (K1795 - Control Cable). When multiple arcs need to be synchronized, a Power Wave System Interface (K2282-1) is required. The system interface provides a dedicated synchronization signal for frequency and balance to each of the four ARC (a.k.a. PHASE) receptacles. The synchronization signals for ARC1 through ARC4 can be phase shifted with respect to one another to reduce the effects of "arc blow" and other welding related issues. The individual synchronization signals are relayed to the master machine of their corresponding arc via a 22 pin control cable. The control cable(s) connect between the individual ARC receptacles on the system interface, and the Master/Slave input connector on the master of each corresponding arc group. The Master/Slave input connector (S12) is located on the lower left side of the case back (as viewed from the rear) of the Power Wave AC/DC 1000.

NOTE: In addition to the 22-pin arc synchronization cables, the system interface also requires a connection to the system controller either via ArcLink for Power Feed 10A controlled systems (see "Connection Between Power Source and Power Feed 10A Controller"), or via DeviceNet for PLC controlled systems (see "Connection Between a Power Source and Optional DeviceNet PLC Controller").

Connections Between a Power Source and Local PC (RS-232 – Null Modem Cable). For diagnostic and set up purposes it is sometimes necessary to connect the power source directly to a PC (personal computer). The Power Wave AC/DC 1000 is equipped with an RS-232 DB-25 style serial connector for this purpose. It is located under the spring loaded output cover on the case front. RS-232 cables must be supplied by the user (Radio Shack part # 26-269; Note: USB port adapter - part #26-183 - is also required for PC's equipped with USB instead of a serial port). For best results, route the RS-232 cable away from weld cables, wire drive control cables, or any other current carrying device that can create a fluctuating magnetic field.

EXTERNAL I/O CONNECTOR

The Power Wave AC/DC 1000 is equipped with a terminal strip for making simple input signal connections. (See Figure A.2a) The terminal strip is located underneath the spring-loaded cover, and divided into three groups:

FIGURE A.2a



Trigger group, Cold Inch Group and Shutdown Group. When the Power Wave AC/DC 1000 is controlled via DeviceNet, the Trigger and Cold Inch Groups can interfere with the welding sequence and should not be used.

All inputs use "normally open" logic except the shutdown group. The shutdown inputs use "normally closed" logic, and are always enabled. Shutdown2 is typically used for signaling low flow in the water cooler. Unused shutdowns must be tied to the +15V supply for the shutdown group. Machines are shipped from the factory with jumpers installed on both shutdown inputs. (See Figure A.3)

Notes:

1. Activating the Trigger or Cold Inch group inputs on a system without a user interface or other means of configuring the Weld Sequencer will result in default values for Weld Mode, WFS and Work point settings.
2. Trigger and Cold Inch group inputs may be redefined as "Weld Profile Selections" by Production Monitoring software (see Production Monitoring Literature for details)
3. On later machines, pin 12 has been redefined as a gear ratio selection input. See "Setting the Wire Drive Gear Ratio" for further information.

FIGURE A.3

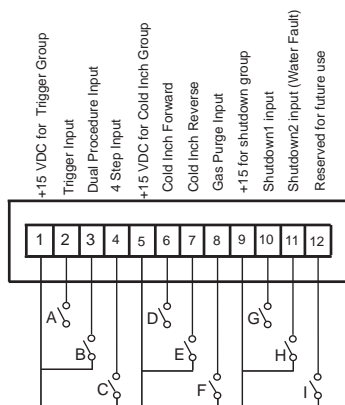

RECEPTACLE SPECIFICATION

Table A.2 Output Arclink Receptacle S1 (5 pin – MS style)

PIN	Lead #	Function
A	53	Arclink L
B	54	Arclink H
C	67A	Electrode Voltage Sense
D	52	Ground(0v)
E	51	+40vdc

Table A.3 Voltage Sense Receptacle S2 (4 pin – Circular Plastic)

PIN	Lead #	Function
3	21A	Work Voltage Sense

Table A.4 RS232 Connector S3 (DB-25 style)

PIN	Lead #	Function
2	253	RS232 Receive
3	254	RS232 Transmit
4	#	S3 Pin5
5	#	S3 Pin4
6	##	S3 Pin20
20	##	S3 Pin6
7	251	RS232 Common

Table A.5 DeviceNet Connector S5 (5 pin - "mini" style)

PIN	Lead #	Function
2	894	+24vdc DeviceNet
3	893	Common DeviceNet
4	892	DeviceNet H
5	891	DeviceNet L

Table A.6 Wire Drive Interface Receptacle S6 (14 pin – MS style)

Pin	Function
A	Motor "+"
B	Motor "-"
C	+40 VDC for solenoid
D	Solenoid input
E	Tach 2A differential signal
F	Single Tach Input
G	+15 VDC Tach
H	Tach common
I	Work voltage sense lead 21
J	Electrode voltage sense lead 67
K	Tach 1A differential signal
L	Tach 1B differential signal
M	Tach 2B differential signal
N	Electrode voltage sense lead 67

Table A.7 External I/O S7 (12 pin – terminal block)

PIN	Lead #	Function
1	851	+15vdc for Trigger group
2	852	Trigger input
3	853	Dual procedure input
4	854	4 step input (Disabled as of S25564-19)
5	855	+15vdc for cold inch group (Disabled as of S25564-19)
6	856	cold inch forward
7	857	cold inch reverse
8	858	gas purge input
9	859	+15vdc for shutdown group
10	860	shutdown1 input
11	861	shutdown2 input
12	862	input B

Table A.8 Master / Slave I/O and System Interface Output Receptacles (22 Pin – MS bayonet style)

Pin	Master / Slave Input (S12)	Master / Slave Output (S13)	Optional System Interface (ARC1, ARC2, ARC3, ARC4)
A	Reserved for future use	Reserved for future use	---
B	Reserved for future use	Reserved for future use	---
C	Sync In	Reserved for future use	Sync Out
D	Sync In	Reserved for future use	Sync Out
E	Ready In	Ready In	---
F	Ready In	Ready In	---
G	Polarity Out	Polarity Out	---
H	Polarity Out	Polarity Out	---
I	Ground	---	---
J	Reserved for future use	Reserved for future use	---
K	Reserved for future use	Reserved for future use	---
L	+40v (COM)	Reserved for future use	---
M	+40v ("+")	Reserved for future use	---
N	Reserved for future use	Reserved for future use	---
P	Reserved for future use	Reserved for future use	---
R	Reserved for future use	Reserved for future use	---
S	Reserved for future use	Reserved for future use	---
T	Drain (ethernet)	Drain (ethernet)	---
U	Kill Out	Kill Out	---
V	Kill Out	Kill Out	---
W	Work voltage sensing (21)	Work voltage sensing (21)	---
X	Electrode Voltage Sensing (67)	Electrode Voltage Sensing (67)	---

Table A.9 Ethernet Connector S9 (8 pin – RJ-45 Style Connector / cat 5 Cable)

PIN	Function
1	Transmit +
2	Transmit -
3	Receive +
4	---
5	---
6	Receive -
7	---
8	---

WIRE DRIVE GEAR RATIO SETTING

Changing the wirefeeder gear ratio requires a gear change in the wire drive, and a configuration change at the power source. The Power Wave AC/DC 1000 can be configured to support up to 4 unique gear ratios. The gear ratio configuration is selected via a DIP switch on the Feed Head PC Board and a jumper on the External I/O connector (S7 - located beneath the spring loaded output cover on the top, front of the machine).

As shipped from the factory, the low speed (high torque) gear is installed. To change the gear ratio of the feeder, see the Wirefeeder Instruction Manual. To achieve the correct speed, the power source must also be configured for the actual gear ratio installed in the wire drive per the instructions below:

⚠ WARNING



ELECTRIC SHOCK can kill.

- Do not touch electrically live parts or electrodes with your skin or wet clothing.
- Insulate yourself from the work and ground.
- Always wear dry insulating gloves.

⚠ WARNING

(See Figure A.3a)

1. Turn off power to the power source at the disconnect switch. All configuration changes must be made with the power OFF.
2. Access the Feed Head board and External I/O connector to configure the power source per table A.9a.
3. Replace the cover and screws as required. The Feed Head PC board will "read" the new configuration at power up, and automatically adjust all control parameters for the speed range selected.

FIGURE A.3a

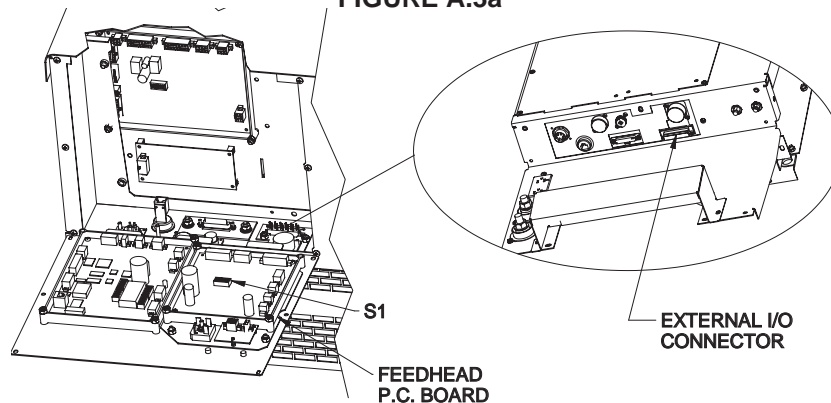
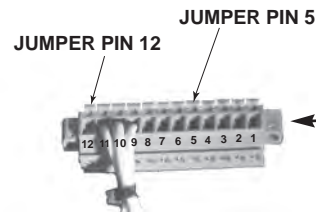

TABLE A.9a

Ratio	Dip Switch #8 (Feed Head PCB - Bank S1)	External I/O Jumper (Pin 5 to Pin 12)
142:1	OFF	NO
95:1	ON	NO
57:1*	OFF	YES
Reserved* (Presently 57:1)	ON	YES



* These Gear Ratios options are enabled in S25564-11 and later Feed Head software.

ETHERNET CONFIGURATION

Ethernet capability is provided for data monitoring, or to enable parallel machine operation. To utilize these features the network settings of each Power Wave AC/DC 1000 must be properly configured. This is accomplished through the use of the **Weld Manager** software utility. Follow the instructions provided with the utility to properly configure the Ethernet address.

When used in a system with parallel machines, the **Submerged Arc Cell Configuration** software utility must be used to map the master/slave relationships within and between the different arc groups. This utility allows the user to configure the system by selecting from a list of master and slave machines (as determined by their individual dip switch settings).

NOTE: Each machine must be configured as either a Master or Slave via the dip switches on the Ethernet PC Board. Furthermore, Master machines must be configured for either internal synchronization (stand alone applications), or external synchronization (multiple arc applications utilizing a Power Wave System Interface). See the "Internal Controls" section of this document.

POWER WAVE® AC/DC 1000



DEVICENET CONFIGURATION

For systems controlled via DeviceNet, The MAC ID and baud rate must be properly configured (see the Internal Controls section of this document). Other information regarding basic system integration of the Power Wave AC/DC 1000 with a DeviceNet PLC is provided in the DeviceNet Interface Specification (part of the Power Wave Submerged Arc Utilities software package available on CD from the Lincoln Electric Company).

INTERNAL CONTROLS

INTERNAL CONTROLS DESCRIPTION

(See figure A.4)

The P.C. Boards located behind the Power Wave AC/DC 1000 front access panel are equipped with DIP switches for custom configuration. To access the DIP switches:

WARNING

ELECTRIC SHOCK can kill.

- Do not touch electrically live parts or electrodes with your skin or wet clothing.

- Insulate yourself from the work and ground.
- Always wear dry insulating gloves.

1. Turn off power at the disconnect switch.
2. Remove the screws securing the front access panel.
3. Open the access panel, allowing the weight of the panel to be carried by the hinge tab at the bottom. Make sure the weight of the access panel is supported by the hinge tabs, not the wiring harness.
4. Adjust the DIP switches as necessary (see information below).
5. Replace the panel and screws, and restore power.

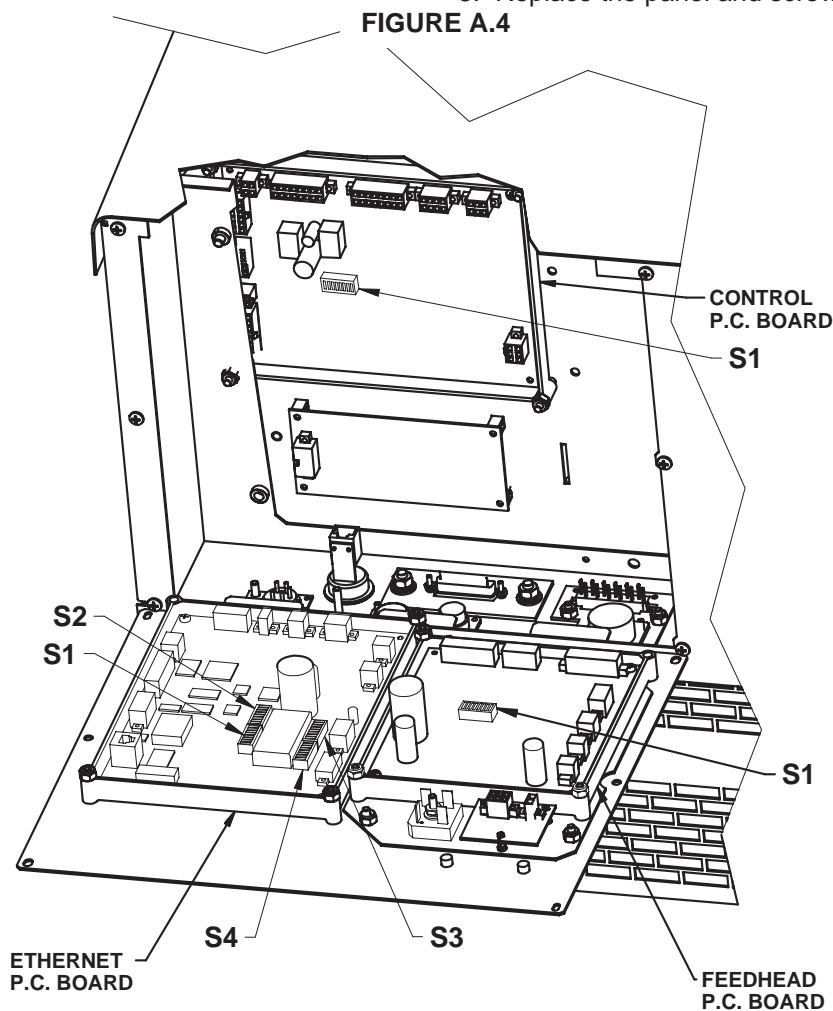

POWER WAVE® AC/DC 1000



CONTROL BOARD DIP SWITCH (S1):

BANK S1

TABLE A.10

Switch	Description	Comments	
1	Object Instance LSB* (see table A.14)	ArcLink configuration	
2	Object Instance MSB** (see table A.14)		
3	Equipment Group 1 Select (default OFF)		
4	Equipment Group 2 Select (default OFF)		
5	Equipment Group 3 Select (default OFF)		
6	Equipment Group 4 Select (default OFF)		
7	off ArcLink Object Auto mapping enabled (default)	Default setting	
	on ArcLink Object Auto mapping disabled	Requires manual configuration	
8	off Work sense lead not connected	Used for configuring work sense lead (See section A)	
	on Work sense lead connected (default)		

*LSB - Least Significant Bit
 **MSB - Most Significant Bit

FEED HEAD BOARD DIP SWITCH (S1):

BANK S1

TABLE A.11

Switch	Description	Comments	
1	Object Instance LSB (see table A.14)	ArcLink Configuration	
2	Object Instance MSB (see table A.14)		
3	Equipment Group 1 Select (default OFF)		
4	Equipment Group 2 Select (default OFF)		
5	Equipment Group 3 Select (default OFF)		
6	Equipment Group 4 Select (default OFF)		
7	off Electrode polarity positive (default)	Must be OFF for Power Wave AC/DC 1000	
	on Electrode polarity negative		
8	off ¹ Low speed gear 142:1 (default)	Gear ratio configuration.	
	on ¹ High speed gear 95:1		
	off ² High speed gear 57:1		
	on ² Reserved (presently configured for 57:1)	These two options available in S25564-11 and later software.	

Notes: 1. No jumper installed on External I/O connector (pin 5 to pin 12).
 2. Jumper installed on External I/O connector (pin 5 to pin 12).

ETHERNET BOARD DIP SWITCHES (S1, S2):

Bank S1 – ArcLink Set-up

TABLE A.12

Switch	Description	Comments	
1	Object Instance LSB (see table A.14)	Used for ArcLink Configuration	
2	Object Instance MSB (see table A.14)		
3	Equipment Group 1 Select (default OFF)		
4	Equipment Group 2 Select (default OFF)		
5	Equipment Group 3 Select (default OFF)		
6	Equipment Group 4 Select (default OFF)		
7	Reserved for future use (default OFF)		
8	Reserved for future use (default OFF)		

Bank S2 – DeviceNet Set-up

TABLE A.13

Switch	Description	Comments	
1	DeviceNet Baud Rate see Table A.15	Used for DeviceNet Configuration	
2			
3			
4			
5	DeviceNet Mac ID see Table A.16		
6			
7			
8			

POWER WAVE® AC/DC 1000



TABLE A.14

OBJECT INSTANCE

switch 2	switch 1	Instance
off	off	0(default)
off	on	1
on	off	2
on	on	3

TABLE A.15

DeviceNet Baud Rate:

Switch 1	Switch 2	Baud Rate
off	off	125K (default)
on	off	250K
off	on	500K
on	on	Programmable value.

DEVICENET MAC ID

TABLE A.16

Mac I.D.	Switch 8	Switch7	Switch6	Switch5	Switch4	Switch 3	
0	0	0	0	0	0	0	Software Selectable
1	0	0	0	0	0	1	
2	0	0	0	0	1	0	
3	0	0	0	0	1	1	
4	0	0	0	1	0	0	
5	0	0	0	1	0	1	
6	0	0	0	1	1	0	
7	0	0	0	1	1	1	
8	0	0	1	0	0	0	
9	0	0	1	0	0	1	
10	0	0	1	0	1	0	
11	0	0	1	0	1	1	
12	0	0	1	1	0	0	
13	0	0	1	1	0	1	
14	0	0	1	1	1	0	
15	0	0	1	1	1	1	
16	0	1	0	0	0	0	
17	0	1	0	0	0	1	
18	0	1	0	0	1	0	
19	0	1	0	0	1	1	
20	0	1	0	1	0	0	
21	0	1	0	1	0	1	
22	0	1	0	1	1	0	
23	0	1	0	1	1	1	
24	0	1	1	0	0	0	
25	0	1	1	0	0	1	
26	0	1	1	0	1	0	
27	0	1	1	0	1	1	
28	0	1	1	1	0	0	
29	0	1	1	1	0	1	
30	0	1	1	1	1	0	
31	0	1	1	1	1	1	
32	1	0	0	0	0	0	
33	1	0	0	0	0	1	
34	1	0	0	0	1	0	
35	1	0	0	0	1	1	
36	1	0	0	1	0	0	
37	1	0	0	1	0	1	
38	1	0	0	1	1	0	
39	1	0	0	1	1	1	
40	1	0	1	0	0	0	
41	1	0	1	0	0	1	
42	1	0	1	0	1	0	
43	1	0	1	0	1	1	
44	1	0	1	1	0	0	
45	1	0	1	1	0	1	
46	1	0	1	1	1	0	
47	1	0	1	1	1	1	
48	1	1	0	0	0	0	
49	1	1	0	0	0	1	
50	1	1	0	0	1	0	
51	1	1	0	0	1	1	
52	1	1	0	1	0	0	
53	1	1	0	1	0	1	
54	1	1	0	1	1	0	
55	1	1	0	1	1	1	
56	1	1	1	0	0	0	
57	1	1	1	0	0	1	
58	1	1	1	0	1	0	
59	1	1	1	0	1	1	
60	1	1	1	1	0	0	
61	1	1	1	1	0	1	
62	1	1	1	1	1	0	Default Setting

POWER WAVE® AC/DC 1000



ETHERNET BOARD DIP SWITCHES (S3, S4):

MASTER

Internal Synchronization Signal
(for systems without K2282-1 System Interface)

"BANK S4"
Master / Slave Config

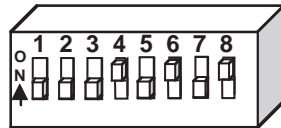

"BANK S3"
I / O Termination

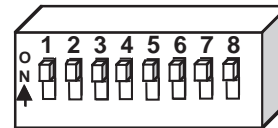

← (DEFAULT)

MASTER

External Synchronization Signal
(for systems with K2282-1 System Interface)

"BANK S4"
Master / Slave Config

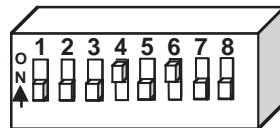

"BANK S3"
I / O Termination

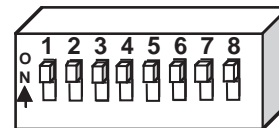
**SLAVE**

"BANK S4"
Master / Slave Config

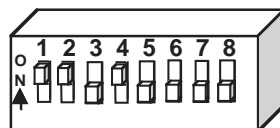

"BANK S3"
I / O Termination

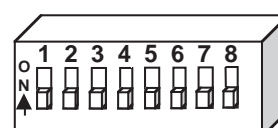

SAFETY PRECAUTIONS

Read this entire section of operating instructions before operating the machine.



ELECTRIC SHOCK can kill.

- Unless using cold feed feature, when feeding with gun trigger, the electrode and drive mechanism are always electrically energized and could remain energized several seconds after the welding ceases.
- Do not touch electrically live parts or electrodes with your skin or wet clothing.
- Insulate yourself from the work and ground.
 - Always wear dry insulating gloves.



FUMES AND GASES can be dangerous.

- Keep your head out of fumes.
- Use ventilation or exhaust to remove fumes from breathing zone.



WELDING SPARKS can cause fire or explosion.

- Keep flammable material away.
- Do not weld on containers that have held combustibles.



ARC RAYS can burn.

- Wear eye, ear, and body protection.

Observe additional guidelines detailed in the beginning of this manual.

DEFINITIONS OF WELDING MODES

NON-SYNERGIC WELDING MODES

- A **Non-synergic** welding mode requires all welding process variables to be set by the operator.

SYNERGIC WELDING MODES

















- A **Synergic** welding mode offers the simplicity of single knob control. The machine will select the correct voltage and amperage based on the wire feed speed (WFS) set by the operator.

COMMON WELDING ABBREVIATIONS

SAW

- Submerged Arc Welding

GRAPHIC SYMBOLS THAT APPEAR ON THIS MACHINE OR IN THIS MANUAL

	INPUT POWER		
	ON	U_0	OPEN CIRCUIT VOLTAGE
	OFF	U_1	INPUT VOLTAGE
	HIGH TEMPERATURE	U_2	OUTPUT VOLTAGE
	MACHINE STATUS	I_1	INPUT CURRENT
	CIRCUIT BREAKER	I_2	OUTPUT CURRENT
	WIRE FEEDER		PROTECTIVE GROUND
	POSITIVE OUTPUT		
	NEGATIVE OUTPUT		WARNING or CAUTION
	3 PHASE INVERTER		Explosion
	INPUT POWER		Dangerous Voltage
$3 \sim$	THREE PHASE		Shock Hazard
	DIRECT CURRENT		

PRODUCT SUMMARY

The Power Wave AC/DC 1000 is a high performance, digitally controlled inverter welding power source. It is capable of producing a variable frequency and amplitude AC output, DC positive output, or DC negative output without the need for external reconnection. It utilizes complex, high-speed waveform control to support a variety of constant current and constant voltage welding modes in each of its output configurations.

The Power Wave AC/DC 1000 power source is designed to be a part of a modular welding system. Each welding arc may be driven by a single machine, or by a number of machines in parallel. In multiple arc applications the phase angle and frequency of different machines can be synchronized with the use of an external System Interface to improve performance and reduce the effects of arc blow.

The Power Wave AC/DC 1000 is primarily designed to interface with compatible ArcLink equipment. However, it can also communicate with other industrial machines and monitoring equipment via DeviceNet, or Ethernet. The result is a highly integrated and flexible welding cell.

RECOMMENDED PROCESSES

The Power Wave AC/DC 1000 is designed for submerged arc welding (SAW). Due to its modular design the Power Wave AC/DC can operate on either single arc or multiple arc applications. Each machine is factory preprogrammed with multiple welding procedures to support all types of submerged arc welding. The Power Wave AC/DC 1000 carries an output rating of 1000 amps, 44 volts (at 100% duty cycle). If higher currents are required machines can be easily paralleled.

PROCESS LIMITATIONS

The Power Wave AC/DC 1000 is suitable only for the processes listed.

Do not use Power Wave AC/DC 1000 for pipe thawing.

EQUIPMENT LIMITATIONS

The Power Wave AC/DC 1000 is not to be used in outdoor environments.

Operating Temperature Range is 32°F to 104°F (0°C to +40°C).

Only the ArcLink Power Feed 10S series wire feeders and Power Feed 10A controller may be used in a standard system. Other Lincoln or non-Lincoln wire feeders can only be used with custom interfaces. The Power Wave AC/DC will support a maximum average output current of 1000 Amps at 100% Duty Cycle.

COMMON EQUIPMENT PACKAGES

Basic Package

K2344-1 or K2344-2	Power Wave AC/DC 1000
K2370-1	Power Feed 10S Head Wire Feeder
K2362-1	Power Feed 10A Controller / User Interface
K1543-xx	Control Cable (5 pin – 5 pin) - power source to controller.
K1785-xx	Control Cable (14 pin – 14 pin) - power source to wire feeder.

Optional kits

K2282-1	System Interface - for Synchronizing multiple arc applications.
K1795-xx	Control Cable (22 pin – 22 pin) - for paralleling / multiple arc applications.
K2312-1	Power Feed 10SF wire feeder (for fixture builders).
K2311-1	Power Feed 10SM Motor Conversion Kit (to convert existing NA-3/NA-4/NA-5 wire feeder gear boxes).
K2444-1	CE, C-Tick Filter Kit

RECOMMENDED EQUIPMENT

(See Installation Section)

POWER WAVE® AC/DC 1000



CASE FRONT CONTROL DESCRIPTIONS

(See Figure B.5)

(See Figure B.4)

1. **Power Switch:** Controls input power to the Power Wave
2. **Status Lights:** A two color light that indicates system errors. Normal operation is a steady green light. Error conditions are indicated in the **Troubleshooting Section**.

NOTE: The robotic PowerWaves' status light will flash green, for up to 15 seconds when the machine is first turned on. This is a normal situation as the machine goes through a self test at power up.

3. **Thermal Fault Light :** A yellow light that comes on when an over temperature situation occurs. Output is disabled until the machine cools down. When cool, the light goes out and output is enabled.

FIGURE B.4

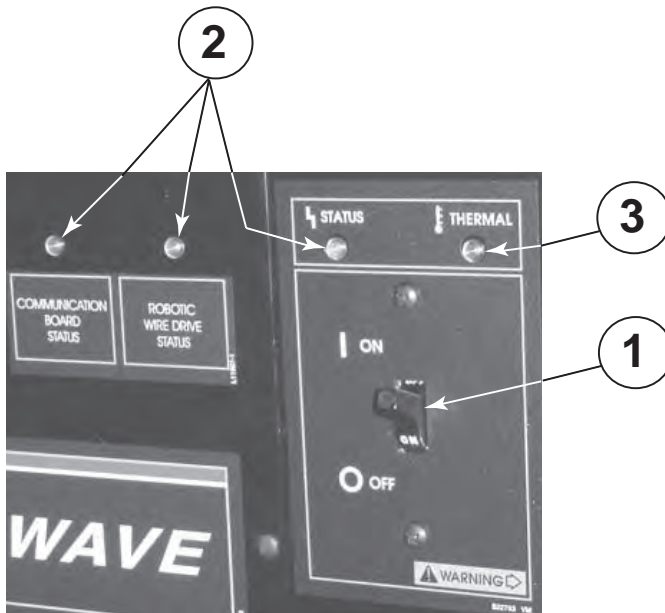

4. **10 Amp Wire Feeder Circuit Breaker:** Protects 40 volt DC wire feeder power supply.
5. **115 VAC Auxiliary Power Circuit Breaker:** Protects case front receptacle auxiliary supply. (10 amps)
6. **21 Work Sense Lead Connector(4-Pin)**
7. **Arclink Connector (5-Pin)**
8. **DeviceNet Connector (5-Pin)**
9. **Work Output Studs**
10. **Electrode Output Studs**
11. **Auxiliary Output**
12. **Ethernet Connector (RJ-45)**
13. **Wire Feeder Connection (14-Pin)**-Connects the control cable between the power source and wire feeder.
14. **External Input Connector**
15. **Serial Communication (RS-232)**

FIGURE B.5

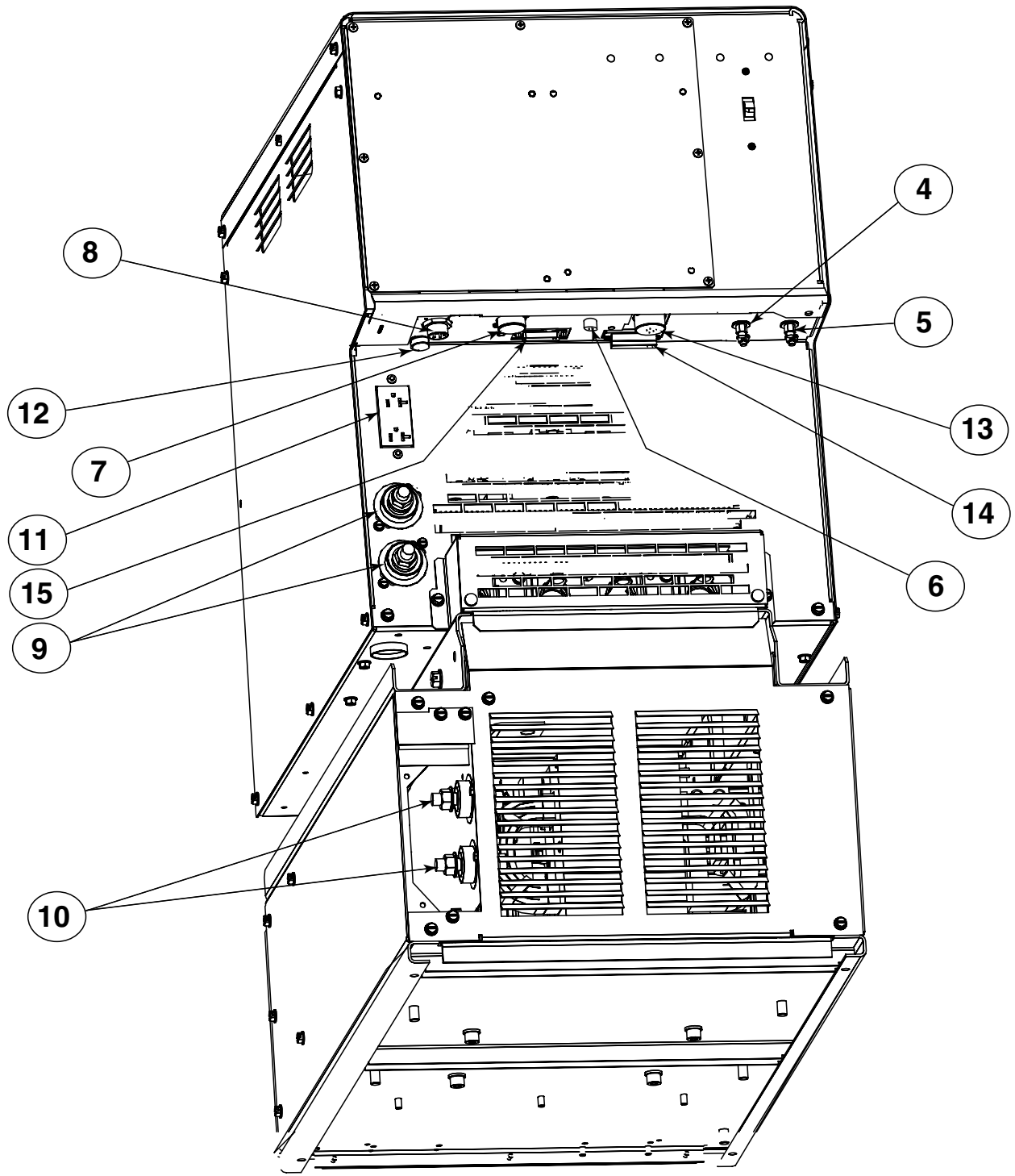

POWER WAVE® AC/DC 1000



CASE REAR COMPONENTS DESCRIPTION (See Figure B.6)

1. **Input Contactor:** Connection point for incoming 3 Phase power (see "Recommended Input Wire and Fuse Size" chart in this document).
2. **Case Ground:** The frame of the welder must be grounded to earth at this terminal. See your local and national electrical codes for proper grounding methods.
3. **Auxiliary Reconnect:** Select proper tap based on input voltage.
4. **CB3:** Primary side protection for auxiliary transformer (T2).
5. **CB4:** Primary side protection for auxiliary transformer (T1).
6. **Impeller Fan Technology™** provides superior cooling.
7. **Master/Slave Input (S12):** Input connection for paralleling machines, or multi-arc synchronization.
8. **Master/Slave Output (S13):** Output connection for paralleling machines.

9. AC Switch Assembly W/Impeller Fan

10. **Optional CE Filter Assembly (not shown):** CE compliance filter connects in series with input connection. Available for K2344-2 only.

POWER-UP SEQUENCE

When power is applied to the Power Wave AC/DC 1000, the status lights will flash green, for up to 15 seconds. This is normal and indicates Power Wave AC/DC 1000 is performing a self test, and mapping (identifying) each component in the local ArcLink system. The status lights will also flash green as a result of a system reset or configuration change during operation. When the status lights become steady green the system is ready for normal operation.

If the status lights do not become steady green consult the troubleshooting section of this manual for further instruction.

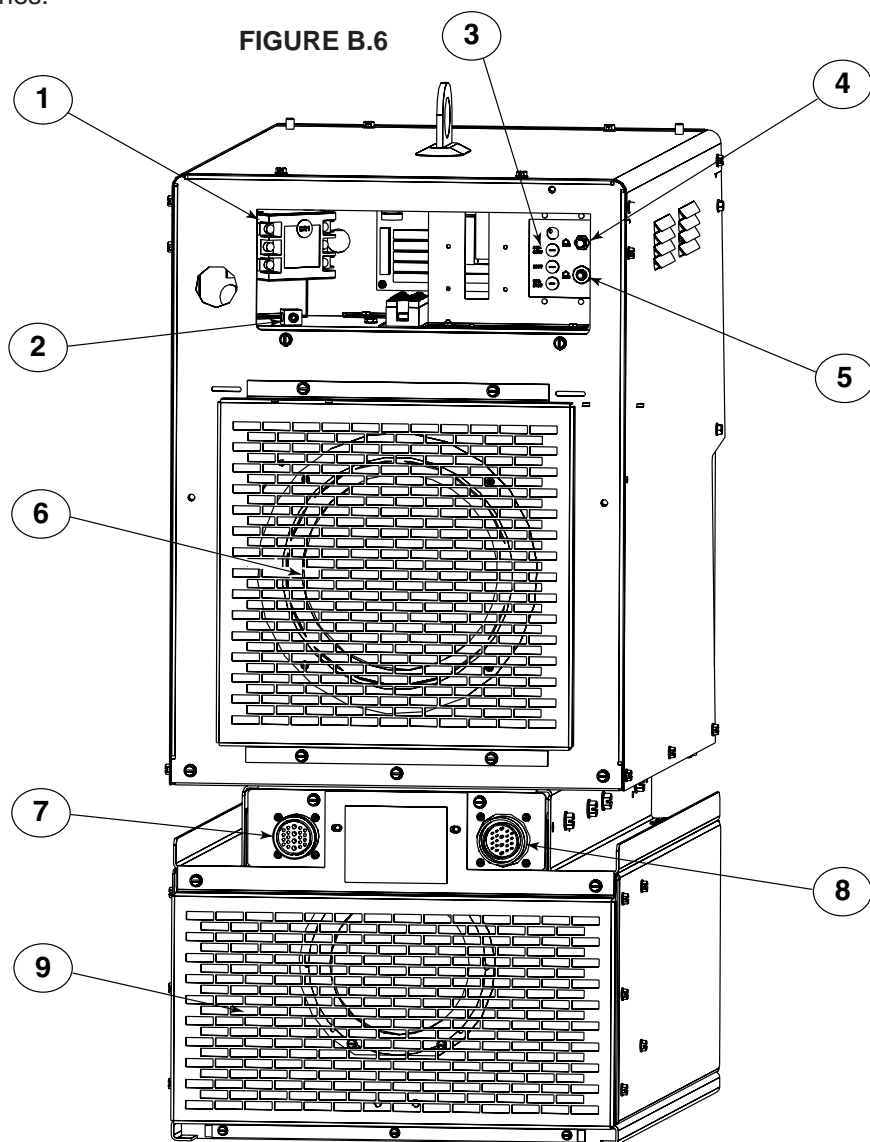

POWER WAVE® AC/DC 1000



DUTY CYCLE

The Power Wave AC/DC is capable of welding at a 100% duty cycle (continuous welding).

COMMON WELDING PROCEDURES

MAKING A WELD

The serviceability of a product or structure utilizing the welding programs is and must be the sole responsibility of the builder/user. Many variables beyond the control of The Lincoln Electric Company affect the results obtained in applying these programs. These variables include, but are not limited to, welding procedure, plate chemistry and temperature, weldment design, fabrication methods and service requirements. The available range of a welding program may not be suitable for all applications, and the build/user is and must be solely responsible for welding program selection.

The steps for operating the Power Wave AC/DC 1000 will vary depending upon the user interface of the welding system. The flexibility of the Power Wave AC/DC 1000 lets the user customize operation for the best performance.

First, consider the desired welding procedures and the part to be welded. Choose an electrode material, diameter, and flux.

Second, find the program in the welding software that best matches the desired welding process. The standard software shipped with the Power Wave AC/DC 1000 encompasses a wide range of common processes and will meet most needs. If a special welding program is desired, contact the local Lincoln Electric sales representative.

To make a weld, the Power Wave AC/DC 1000 needs to know the desired welding parameters. Waveform Control Technology™ allows full customization of Strike, Run-in, Crater and other parameters for exacting performance.

OVERVIEW OF THE AC/DC SUBMERGED ARC PROCESS

The Power Wave AC/DC 1000 combines the advantages of AC and DC Submerged Arc Welding (SAW) into a single power source. The limiting factor of AC-SAW welding has always been the time it takes to transition from positive to negative polarity. This lag through the zero crossing can cause arc instability, penetration, and deposition problems in certain applications. The Power Wave AC/DC 1000 utilizes the speed of an inverter based power source, and the flexibility of Waveform Control Technology™ to address this issue. By adjusting the Frequency, Wave Balance and Offset of the AC waveform the operator can now control the balance (relationship) between the penetration of DC positive and the deposition of DC negative while taking full advantage of the reduction in arc blow associated with AC.

FIGURE B.1

AC/DC Submerged Arc Process

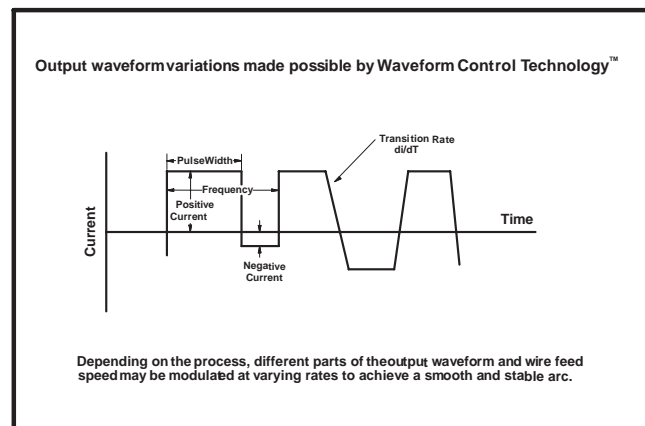

MULTIPLE ARC SYSTEM CONSIDERATIONS

Large scale SAW applications often employ multiple arcs to increase deposition rates. In multiple arc systems, magnetic forces created by like and opposing weld currents of adjacent arcs can result in arc interaction that can physically push or pull the arc columns together. To counteract this effect, the phase relationship between adjacent arcs can be adjusted to alternate and equalize the duration of magnetic push and pull forces. This is accomplished by the use of an optional K2282-1 Power Wave System Interface, which not only synchronizes the arcs, but also enables adjustment of the phase relationship between them. Ideally, the net result is a cancellation of the interacting forces.

FIGURE B.2

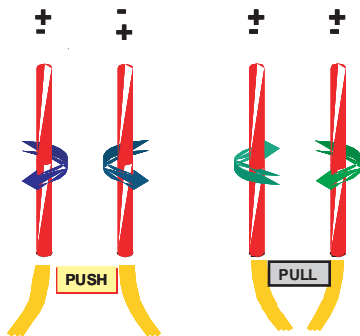
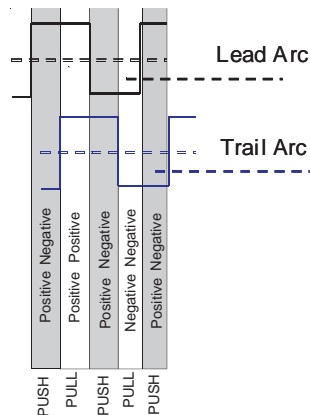

FIGURE B.3



⚠ CAUTION

Never simultaneously touch electrically "hot" parts in the electrode circuits of two different welders. The electrode to electrode no load voltage of multiple arc systems with opposite polarities can be double the no load voltage of each arc. Consult the Safety information located at the front of the Instruction Manual for additional information.

BASIC MODES OF OPERATION

CONSTANT CURRENT (CC)

- Operator presets Current and desired Voltage.
- The Power Source:
 - Goal is to maintain a constant arc length.
 - Drives a constant Current.
 - Synergically Controls WFS to Maintain Voltage at the desired Set point.
- Arc Length is proportional to Voltage.
- Traditionally used for larger diameter wires and slower travel speeds.

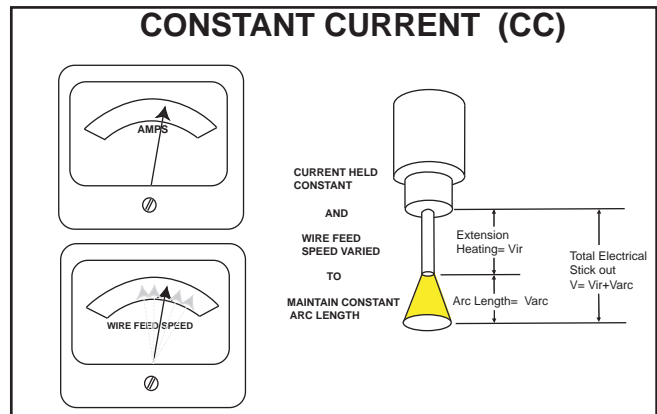

CONSTANT VOLTAGE (CV)

- Operator presets Wire Feed Speed and desired Voltage
- The Power Source:
 - Goal is to maintain a constant arc length.
 - Commands constant wire feed speed
 - Synergically Controls Current to Maintain Voltage at the desired Set point
- Arc Length is proportional to Voltage
- Traditionally used for smaller diameter wires and faster travel speeds.

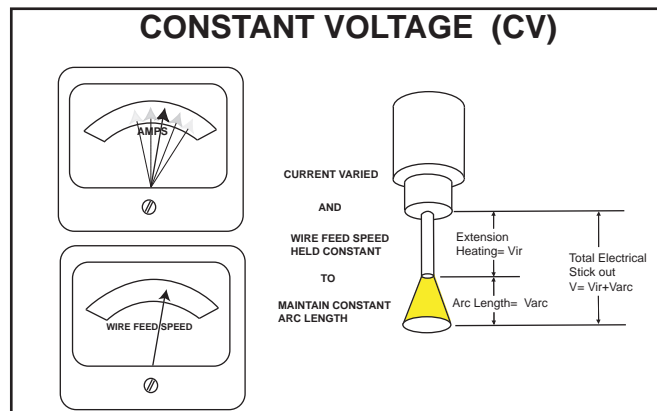

WELD SEQUENCE:

The weld sequence defines the weld procedure from beginning to end. The Power Wave AC/DC 1000 not only provides adjustment of basic welding parameters, but also allows the operator to fine tune the start and finish of each weld for superior performance.

All adjustments are made through the user interface. Because of the different configuration options, your system may not have all of the following adjustments. Regardless of availability, all controls are described below.

Weld Sequence

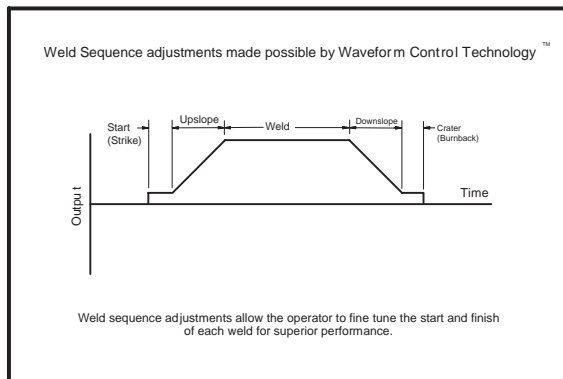

START OPTIONS

The Strike, Start, and Upslope parameters are used at the beginning of the weld sequence to establish a stable arc and provide a smooth transition to the welding parameters.

- **Strike** settings are valid from the beginning of the sequence (Trigger) until the arc is established. They control Run-in (speed at which the wire approaches the workpiece), and provide the power to establish the arc.
 - Typically output levels are increased and WFS is reduced during the Strike portion of the weld sequence
- **Start** values allow the arc to become stabilized once it is established.
 - Extended Start times or improperly set parameters can result poor starting
- **Upslope** determines the amount of time it takes to ramp from the Start parameters to the Weld parameters. The transition is linear and may be up or down depending on the relationship between the Start and Weld settings.

END OPTIONS

The **Downslope**, **Crater**, and **Burnback** parameters are used to define the end of the weld sequence.

- **Downslope** determines the amount of time it takes to ramp from the Weld parameters to the Crater parameters. The transition is linear and may be up or down depending on the relationship between the Weld and Crater settings.
- **Crater** parameters are typically used to fill the crater at the end of the weld, and include both time and output settings.
- **Burnback** defines the amount of time the output remains on after the wire has stopped. This feature is used to prevent the wire from sticking in the weld puddle, and condition the end of the wire for the next weld. A Burnback time of 0.4 sec is sufficient in most applications. The output level for Burnback is generally set to the same level as the last active weld sequence state (either Weld or Crater).

RE-STRIKE TIMER

If the arc goes out for any reason (short circuit or open circuit), the Power Wave AC/DC 1000 will enter a Re-strike state. During this state the system will automatically manipulate the WFS and output in an attempt to re-establish the arc. The Re-strike timer determines how long the system will attempt to re-establish the arc before it shuts down.

- Used to protect the welding system and/or work piece being welded.
- A Re-strike time of 1 to 2 sec is sufficient in most applications.

WELD PROCESS ADJUSTMENTS

Depending on the weld mode, there are a number of adjustments that can be made, including but not limited to Current, Voltage and WFS. These adjustments apply to either AC or DC processes, and control the basic parameters of the weld.

AC ADJUSTMENTS

In addition to the basic weld parameters, there are a number of unique adjustments related to the AC waveform of the Power Wave AC/DC 1000. These adjustments enable the operator to balance the relationship between penetration and deposition to tailor the output for specific applications.

WAVE BALANCE

- Refers to amount of time the waveform spends in DC+ portion of the cycle.
- Use Wave Balance to control the penetration and deposition of a given process.

Wave Balance

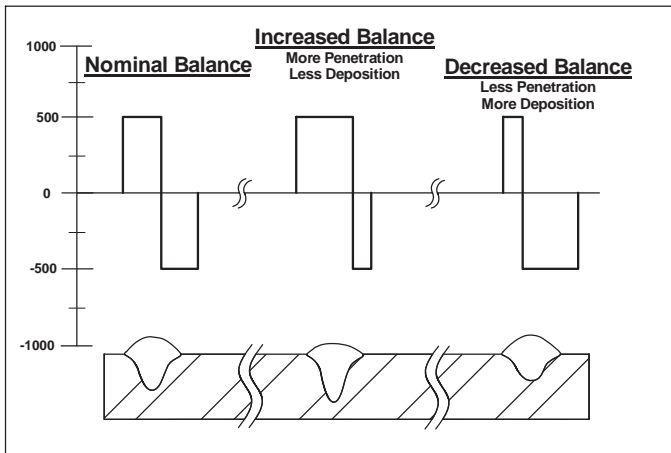

DC OFFSET

- Refers to +/- shift of the current waveform with respect to the zero crossing.
- Use Offset to control the penetration and deposition of a given process.

DC Offset

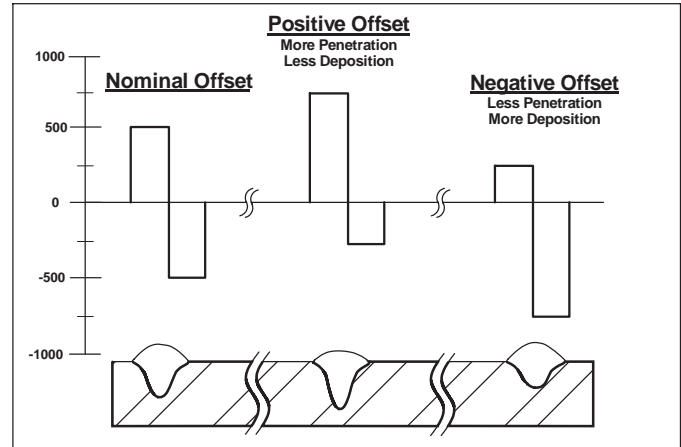

FREQUENCY

- POWER WAVE AC/DC 1000 can produce Output Frequencies from 10 - 100Hz
- Use Frequency to fine tune stability
- Higher frequencies in multiple arc setups can help reduce arc interaction

Frequency

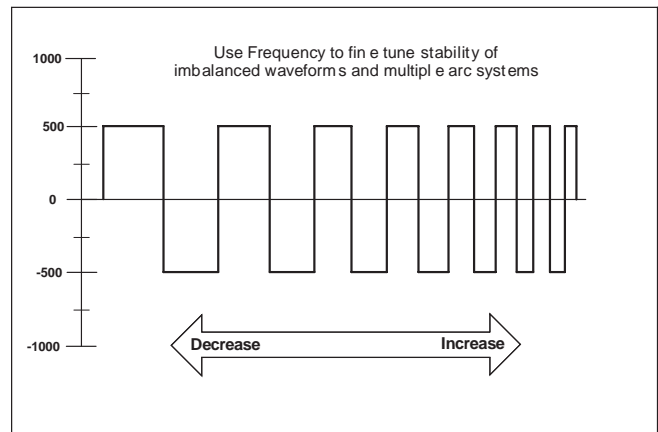

MULTIPLE ARC AC ADJUSTMENTS FOR SYSTEMS EQUIPPED WITH K2282-1 SYSTEM INTERFACE

Phase

The **phase relationship** between the arcs helps to minimize the magnetic interaction between adjacent arcs. It is essentially a time offset between the waveforms of different arcs, and is set in terms of an angle from 0 to 360°, representing no offset to a full period offset. The offset of each arc is set independently with respect to the lead arc of the system (ARC 1).

Recommendations:

- For balanced waveforms a phase relationship of 90° should be maintained between adjacent arcs.

	ARC 1	ARC2	ARC3	ARC 4
2 Arc System	0°	90°	X	X
3 Arc System	0°	90°	180°	X
4 Arc System	0°	90°	180°	270°

- For unbalanced waveforms:
 - Avoid switching at same time
 - Break up long periods of unchanged polarity relative to adjacent arcs

Phase Relationship

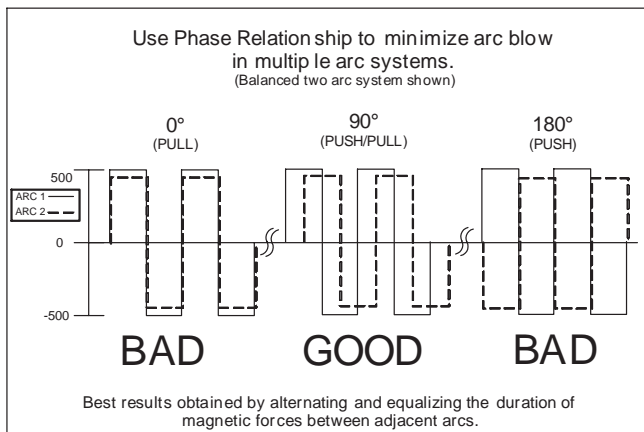

KITS, OPTIONS AND ACCESSORIES

OPTIONAL KITS AND ACCESSORIES

K2282-1 Power Wave System Interface

The optional Power Wave System Interface provides the means to synchronize the AC wave shapes of up to four different arcs to a common carrier frequency. This frequency can range from 10 hertz to 300 hertz, with the most practical range being 10 to 100 hertz. It can also control the phase relationship between arcs to reduce the effects of welding related issues such as "Arc Blow".

K2444-1 CE – C-Tick Filter Kit

This external filter kit is available for the **K2344-2** Power Wave AC/DC 1000, and mounts directly to the reconnect area on the rear of the machine. The filter is necessary to meet CE conducted emission requirements.

SOFTWARE TOOLS

The Power Wave AC/DC 1000 is shipped with a CD including software tools and other documents related to the integration, configuration, and operation of the system. The **Power Wave Submerged Arc Utilities** CD includes the following items and all of the documentation to support them.

Name	Purpose
Weld Manager	Setup Ethernet address information, and apply security settings.
Command Center	AC/DC system tool to observe and log welding operation, verify DeviceNet welding configuration, and facilitate quality analysis.
Submerged Arc Cell Configuration	Used to configure and verify a multi-arc or parallel connected power source (more than one Power Wave per arc) systems.
Production Monitoring	Allows user to setup Production Monitoring options on the Power Wave including Email notification, Shift Timers, Wire Package Tracking. Also provides means to retrieve statistical welding data, generate machine reports, and update the Power Wave Firmware and Welding Software.
Diagnostics Utility	Utility to diagnose Power Wave problems, read system information, calibrate output voltage and current, test sense leads, and diagnose feed head issues. Can also setup and verify DeviceNet operation.
Weld Manager (Palm Application)	Palm based utility used to configure, backup and restore various Power Feed 10A Controller settings (can be used to copy settings from one PF-10A to another). Also provides means to retrieve version information and setup Ethernet address of the local Power Wave system (only those components directly connected to the PF-10A via ArcLink).

SAFETY PRECAUTIONS

WARNING

ELECTRIC SHOCK can kill.



- Only Qualified personnel should perform this maintenance.
- Turn the input power OFF at the disconnect switch or fuse box before working on this equipment.
- Do not touch electrically hot parts.

ROUTINE MAINTENANCE

Routine maintenance consists of periodically blowing out the machine, using a low-pressure airstream, to remove accumulated dust and dirt from the intake and outlet louvers, and the cooling channels in the machine.

PERIODIC MAINTENANCE

Calibration of the Power Wave AC/DC 1000 is critical to its operation. Generally speaking the calibration will not need adjustment. However, neglected or improperly calibrated machines may not yield satisfactory weld performance. To ensure optimal performance, the calibration of output Voltage and Current should be checked yearly.

CALIBRATION SPECIFICATION

Output Voltage and Current are calibrated at the factory. Generally speaking the machine calibration will not need adjustment. However, if the weld performance changes, or the yearly calibration check reveals a problem, use the calibration section of the Diagnostics Utility to make the appropriate adjustments.

The calibration procedure itself requires the use of a grid (Resistive Load Bank), and certified actual meters for voltage and current. The accuracy of the calibration will be directly affected by the accuracy of the measuring equipment you use. The **Diagnostics Utility** includes detailed instructions, and is available on the **Power Wave Submerged Arc Utilities** and **Service Navigator CD's**.

POWER WAVE® AC/DC 1000



HOW TO USE TROUBLESHOOTING GUIDE

WARNING

Service and Repair should only be performed by Lincoln Electric Factory Trained Personnel. Unauthorized repairs performed on this equipment may result in danger to the technician and machine operator and will invalidate your factory warranty. For your safety and to avoid Electrical Shock, please observe all safety notes and precautions detailed throughout this manual.

This Troubleshooting Guide is provided to help you locate and repair possible machine malfunctions. Simply follow the three-step procedure listed below.

Step 1. LOCATE PROBLEM (SYMPTOM).

Look under the column labeled "PROBLEM (SYMPTOMS)". This column describes possible symptoms that the machine may exhibit. Find the listing that best describes the symptom that the machine is exhibiting.

Step 2. POSSIBLE CAUSE.

The second column labeled "POSSIBLE CAUSE" lists the obvious external possibilities that may contribute to the machine symptom.

Step 3. RECOMMENDED COURSE OF ACTION

This column provides a course of action for the Possible Cause, generally it states to contact your local Lincoln Authorized Field Service Facility.

If you do not understand or are unable to perform the Recommended Course of Action safely, contact your local Lincoln Authorized Field Service Facility.

CAUTION

If for any reason you do not understand the test procedures or are unable to perform the tests/repairs safely, contact your **Local Lincoln Authorized Field Service Facility** for technical troubleshooting assistance before you proceed.

Observe all Safety Guidelines detailed throughout this manual

PROBLEMS (SYMPTOMS)	POSSIBLE CAUSE	RECOMMENDED COURSE OF ACTION
Major physical or electrical damage is evident when the sheet metal covers are removed.	1. Contact your local authorized Lincoln Electric Field Service facility for technical assistance.	1. Contact your local authorized Lincoln Electric Field Service facility for technical assistance.
Input fuses keep blowing.	1. Improperly sized input fuses. 2. Improper Weld Procedure requiring output levels in excess of machine rating. 3. Major physical or electrical damage is evident when the sheet metal covers are removed.	1. Make sure fuses are properly sized. See Installation section of this manual for recommended sizes. 2. Reduce output current, duty cycle, or both. 3. Contact an authorized Lincoln Electric Service facility.
Machine will not power up (no lights)	1. No Input Power. 2. Circuit breaker CB4 (in reconnect area) may have tripped. Power Down and Reset CB4. 3. Input voltage selection made improperly.	1. Make sure input supply disconnect has been turned ON. Check input fuses. Make certain that the Power Switch (SW1) on the power source is in the "ON" position. 2. Power Down and Reset CB4. 3. Power down, check input voltage reconnect according to diagram on reconnect cover. (Qualified person should perform this operation)

 **CAUTION**

If for any reason you do not understand the test procedures or are unable to perform the tests/repairs safely, contact your **Local Lincoln Authorized Field Service Facility** for technical troubleshooting assistance before you proceed.

POWER WAVE® AC/DC 1000



Observe all Safety Guidelines detailed throughout this manual

PROBLEMS (SYMPTOMS)	POSSIBLE CAUSE	RECOMMENDED COURSE OF ACTION
<p>Machine won't weld, can't get any output. (CR1 will not pull in.)</p> <p>This problem will normally be accompanied by an error code. Error codes are displayed as a series of red and green flashes by the status light(s). See "Status Light" section of this document for additional information.</p>	<ol style="list-style-type: none"> 1. Input voltage is too low or too high. 2. Thermal Error. 3. Primary current limit has been exceeded. (CR1 drops out when output is initiated). 4. Inverter Fault - switch pc board, contactor problem, etc. 	<ol style="list-style-type: none"> 1. Make certain that input voltage is proper, according to the Rating Plate located on the rear of the machine. 2. See "Thermal LED is ON" section. 3. Possible short in output circuit. Turn machine off. Remove all loads from the output of the machine. Turn back on, and activate output. If condition persists, turn power off, and contact an authorized Lincoln Electric Field Service facility. 4. Contact your local authorized Lincoln Electric Field Service facility for technical assistance.
<p>Thermal LED is on.</p>	<ol style="list-style-type: none"> 1. Improper fan operation. 2. Switch Board or AC Output Chopper board thermostat. 3. DC Bus PC board thermostat 4. Open thermostat circuit. 	<ol style="list-style-type: none"> 1. Check for proper fan operation. (Fans should run whenever output power is on.) Check for material blocking intake or exhaust louvers, or for excessive dirt clogging cooling channels in machine. 2. After machine has cooled, reduce load, duty cycle, or both. Check for material blocking intake or exhaust louvers. 3. Check for excessive load on 40VDC supply. 4. Check for broken wires, open connections or faulty thermostats DC Bus, Switch, and AC Chopper PC Board heat sinks.

 **CAUTION**

If for any reason you do not understand the test procedures or are unable to perform the tests/repairs safely, contact your **Local Lincoln Authorized Field Service Facility** for technical troubleshooting assistance before you proceed.

POWER WAVE® AC/DC 1000



Observe all Safety Guidelines detailed throughout this manual

PROBLEMS (SYMPTOMS)	POSSIBLE CAUSE	RECOMMENDED COURSE OF ACTION
Auxiliary receptacle is "dead".	<ol style="list-style-type: none"> 1. Circuit breaker CB2 (on case front) may have tripped. 2. Circuit breaker CB3 or CB4 (in reconnect area) may have tripped. 	<ol style="list-style-type: none"> 1. Power down and reset CB2. 2. Power down and reset CB3 or CB4.
WELD AND ARC QUALITY PROBLEMS		
General degradation of weld performance	<ol style="list-style-type: none"> 1. Wire feed problem. 2. Cabling problems. 3. Verify weld mode is correct for process. 4. Machine calibration. 	<ol style="list-style-type: none"> 1. Check for feeding problems. Make sure proper gear ratio has been selected. 2. Check for bad connections, excessive loops in cable, etc. <p>NOTE: The presence of heat in the external welding circuit indicates poor connections or undersized cables.</p> <ol style="list-style-type: none"> 3. Select the correct weld mode for the application. 4. The power source may require calibration. (current, voltage, WFS).
Wire burns back to tip when the arc is initiated.	<ol style="list-style-type: none"> 1. Voltage sense lead problem. 2. Wire feed problem. 	<ol style="list-style-type: none"> 1. Check sense lead connections. Check DIP switch settings for sense lead configuration and arc polarity. Make sure Electrode and Work connections are not reversed. 2. Check for feeding problems. Make sure proper gear ratio has been selected.
Wire burns back to tip at the end of the weld.	<ol style="list-style-type: none"> 1. Burnback Time 	<ol style="list-style-type: none"> 1. Reduce burnback time and/or work point.

⚠ CAUTION

If for any reason you do not understand the test procedures or are unable to perform the tests/repairs safely, contact your **Local Lincoln Authorized Field Service Facility** for technical troubleshooting assistance before you proceed.

POWER WAVE® AC/DC 1000



Observe all Safety Guidelines detailed throughout this manual

PROBLEMS (SYMPTOMS)	POSSIBLE CAUSE	RECOMMENDED COURSE OF ACTION
WELD AND ARC QUALITY PROBLEMS		
Cannot weld AC.	1. Improper Ethernet I/O Configuration. 2. AC Switch Problem.	1. Verify Ethernet board DIP Switch settings. 2. If major physical or electrical damage is evident when the sheet metal cover is removed from the AC Switch (lower section of the machine). Contact your local authorized Lincoln Electric Field Service facility for technical assistance.
Machine output shuts down during a weld.	1. Secondary current limit has been exceeded, and the machine shuts down to protect itself. 2. Single phase input (loss of L2). 3. Re-strike Time exceeded.	1. Adjust procedure or reduce load to lower current draw from the machine. 2. Single phase input (loss of L2). A single phase input (loss of L2) will reduce the secondary current limit and cause secondary over current shutdown at lower output levels. Check the input fuses and supply lines. 3. Adjust the process parameters to avoid excessive arc loss time or increase the re-strike time.
Machine won't produce full output.	1. Input voltage may be too low, limiting output capability of the power source. 2. Machine calibration.	1. Make certain that the input voltage is proper, according to the Rating Plate located on the rear of the machine. 2. Calibrate secondary current and voltage.
Excessively long and erratic arc.	1. Voltage sensing problem. 2. Machine calibration.	1. Check for proper configuration and implementation of voltage sensing circuits. 2. Calibrate secondary current and voltage.

⚠ CAUTION

If for any reason you do not understand the test procedures or are unable to perform the tests/repairs safely, contact your **Local Lincoln Authorized Field Service Facility** for technical troubleshooting assistance before you proceed.

POWER WAVE® AC/DC 1000



Observe all Safety Guidelines detailed throughout this manual

PROBLEMS (SYMPTOMS)	POSSIBLE CAUSE	RECOMMENDED COURSE OF ACTION
DEVICENET-PLC CONTROLLED SYSTEM		
Device does not go on Line.	<ol style="list-style-type: none"> 1. 24v bus power. 2. Baud rate. 3. MAC ID. 4. Termination. 5. Wiring. 6. EDS Files. 	<ol style="list-style-type: none"> 1. Verify that LED 2 is on when the DeviceNet network is powered. This can be done with the Power Wave turned on or off. 2. Verify the baud rate setting is the same as the DeviceNet Master. The baud rate is set via dip switch on the Ethernet PC Board. The current value of the baud rate setting can be viewed on the DeviceNet tab of the Diagnostics Utility. 3. Verify the DeviceNet MAC ID is correct. The Mac ID is set via dip switch on the Ethernet PC Board. The current value of the MAC ID can be viewed on the DeviceNet tab of the Diagnostics Utility. 4. Verify that the DeviceNet bus is terminated correctly. 5. Verify the wiring of all multi-port taps and field attachable ends. 6. (Electronic Data Sheet Files) Verify that the correct EDS files are being used if they are needed. The DeviceNet tab of the Diagnostics Utility displays the current Product Code and Vendor Revision of the Power Wave.
Device goes off line during welding	<ol style="list-style-type: none"> 1. Interference / Noise. 2. Termination. 3. Shielding. 	<ol style="list-style-type: none"> 1. Verify that DeviceNet cables are not running next to (in close proximity with) current carrying conductors. This includes the welding cables, input cables, etc. 2. Verify that the DeviceNet bus is terminated correctly. 3. Verify that the cable shielding is correctly grounded at the bus power supply. The shield should be tied into the bus ground at only one point.

⚠ CAUTION

If for any reason you do not understand the test procedures or are unable to perform the tests/repairs safely, contact your **Local Lincoln Authorized Field Service Facility** for technical troubleshooting assistance before you proceed.

POWER WAVE® AC/DC 1000



Observe all Safety Guidelines detailed throughout this manual

PROBLEMS (SYMPTOMS)	POSSIBLE CAUSE	RECOMMENDED COURSE OF ACTION
DEVICENET-PLC CONTROLLED SYSTEM		
	4. Power Supply. 5. Expected Packet Rate.	4. Verify that the DeviceNet bus power supply can supply sufficient current for the devices on the network. 5. Verify that 1000/(Expected Packet Rate) " (scans per second). The DeviceNet tab of the Diagnostics Utility displays these values.
Output will not come on.	1. DeviceNet trigger not asserted. 2. Touch Sense command. 3. Passive Mode. 4. Welding Cables. 5. Output Disabled. 6. Other modules faulted.	1. From the DeviceNet tab of the Diagnostics Utility , select Monitor. The Monitor window will be displayed. Verify under the "Produced Assembly" that "Trigger" is highlighted. 2. From the DeviceNet tab of the Diagnostics Utility , select Monitor. The Monitor window will be displayed. Verify under the "Produced Assembly" that "Touch Sense" is NOT highlighted. 3. The DeviceNet tab of the Diagnostics Utility displays the Power Wave's passive mode status. If the status needs to be changed, select Configure, and make the necessary modification. 4. Verify that welding cables are connected properly. 5. From the DeviceNet tab of the Diagnostics Utility , select Monitor. The Monitor window will be displayed. Verify under the "Produced Assembly" that "Disable Output" is NOT highlighted. 6. Verify no other modules are faulted (all system Status Lights should be steady green). Use Diagnostics Utility to display any current faults in the system.

 **CAUTION**

If for any reason you do not understand the test procedures or are unable to perform the tests/repairs safely, contact your **Local Lincoln Authorized Field Service Facility** for technical troubleshooting assistance before you proceed.

POWER WAVE® AC/DC 1000



Observe all Safety Guidelines detailed throughout this manual

PROBLEMS (SYMPTOMS)	POSSIBLE CAUSE	RECOMMENDED COURSE OF ACTION
DEVICENET-PLC CONTROLLED SYSTEM		
Bad Weld Starting	<ol style="list-style-type: none"> 1. Wire Feed problem. 2. Strike Wire Feed Speed. 3. Incorrect Weld Schedule. 4. Voltage Sense Leads. 5. Analog Scans Between Updates. 6. Analog Hysteresis. 7. Limit Error. 8. Fan Out. 9. Gas. 	<ol style="list-style-type: none"> 1. Verify Feeders drive roll tension is not too low allowing the wire to slip in the rolls. Verify wire can be pulled easily through the wire conduit. Verify Contact tip is not blocked. 2. Verify the Strike Wire Feed Speed set correctly. 3. Verify the correct weld schedule is selected. 4. Verify voltage sense leads are properly connected and configured as described in the instruction manual. 5. The DeviceNet tab of the Diagnostics Utility displays the Power Wave's "Analog Scans Between Updates" and "I/O Scans/Sec." Verify that "Analog Scans Between Updates" is 1/4 of "I/O Scans/Sec" value. 6. From the DeviceNet tab of the Diagnostics Utility, select Configure. Verify in "Analog Input Channels" that the Hysteresis settings are all 0. 7. Verify all analog input values are within limits. 8. From the DeviceNet tab of the Diagnostics Utility, select Monitor. Verify under "Analog Input Fan Out" that Burnback is present for all analogs in. 9. Verify Gas is being turned on before the output.

⚠ CAUTION

If for any reason you do not understand the test procedures or are unable to perform the tests/repairs safely, contact your **Local Lincoln Authorized Field Service Facility** for technical troubleshooting assistance before you proceed.

POWER WAVE® AC/DC 1000



Observe all Safety Guidelines detailed throughout this manual

PROBLEMS (SYMPTOMS)	POSSIBLE CAUSE	RECOMMENDED COURSE OF ACTION
DEVICENET-PLC CONTROLLED SYSTEM		
Analog Inputs don't respond or don't respond quickly.	<ol style="list-style-type: none"> 1. Analog Scans Between Updates. 2. Analog In Active Selections. 3. Analog Hysteresis. 4. Passive Mode. 	<ol style="list-style-type: none"> 1. The DeviceNet tab of the Diagnostics Utility displays the Power Wave's "Analog Scans Between Updates" and "I/O Scans/Sec." Verify that "Analog Scans Between Updates" is 1/4 of "I/O Scans/Sec" value. 2. From the DeviceNet tab of the Diagnostics Utility, select Configure. Verify in "Analog Input Channels" that the required channels are set active. 3. From the DeviceNet tab of the Diagnostics Utility, select Configure. Verify in "Analog Input Channels" that the Hysteresis settings are all 0. 4. The DeviceNet tab of the Diagnostics Utility displays the Power Wave's passive mode status. If the status needs to be changed, select Configure, and make the necessary modification.
Gas purge not working.	<ol style="list-style-type: none"> 1. Out of gas. 2. Gas Purge not asserted. 3. Passive Mode. 4. Gas Lines. 	<ol style="list-style-type: none"> 1. Verify there is gas available at the input of the gas solenoid. 2. From the DeviceNet tab of the Diagnostics Utility, select Monitor. The Monitor window will be displayed. Verify under the "Produced Assembly" that "Gas Purge" is highlighted. 3. The DeviceNet tab of the Diagnostics Utility displays the Power Wave's passive mode status. If the status needs to be changed, select Configure, and make the necessary modification. 4. Verify nothing is obstructing the flow of gas.

⚠ CAUTION

If for any reason you do not understand the test procedures or are unable to perform the tests/repairs safely, contact your **Local Lincoln Authorized Field Service Facility** for technical troubleshooting assistance before you proceed.

POWER WAVE® AC/DC 1000



Observe all Safety Guidelines detailed throughout this manual

PROBLEMS (SYMPTOMS)	POSSIBLE CAUSE	RECOMMENDED COURSE OF ACTION
DEVICENET-PLC CONTROLLED SYSTEM		
Bad Weld Ending	<ol style="list-style-type: none"> 1. Burnback Disabled. 2. Burnback Time. 3. Analog Scans Between Updates. 4. Limit Error reported at the end of a weld. 5. Fan Out. 6. Welding set points. 7. Analog Hysteresis. 8. Gas. 	<ol style="list-style-type: none"> 1. From the DeviceNet tab of the Diagnostics Utility, select Monitor. The Monitor window will be displayed. Verify under the "State Enabled" that "Burnback" is present. 2. Using Command Center verify that Burnback Time for the active schedule in the main window has a value other than 0. 3. The DeviceNet tab of the Diagnostics Utility displays the Power Wave's "Analog Scans Between Updates" and "I/O Scans/Sec." Verify that "Analog Scans Between Updates" is 1/4 of "I/O Scans/Sec" value. 4. Verify all welding settings for Burnback and Crater states. 5. From the DeviceNet tab of the Diagnostics Utility, select Monitor. Verify under "Analog Input Fan Out" that Burnback is present for all analogs in. 6. Verify Burnback set points for work point, trim, and wave values. 7. From the DeviceNet tab of the Diagnostics Utility, select Configure. Verify in "Analog Input Channels" that the Hysteresis settings are all 0. 8. Verify Gas is turned on.
Bad Welding	<ol style="list-style-type: none"> 1. Analog Scans Between Updates. 2. Voltage Sense Leads. 	<ol style="list-style-type: none"> 1. The DeviceNet tab of the Diagnostics Utility displays the Power Wave's "Analog Scans Between Updates" and "I/O Scans/Sec." Verify that "Analog Scans Between Updates" is 1/4 of "I/O Scans/Sec" value. 2. Verify voltage sense leads are properly connected and configured as described in the instruction manual.

⚠ CAUTION

If for any reason you do not understand the test procedures or are unable to perform the tests/repairs safely, contact your **Local Lincoln Authorized Field Service Facility** for technical troubleshooting assistance before you proceed.

POWER WAVE® AC/DC 1000



USING THE STATUS LED TO TROUBLESHOOT SYSTEM PROBLEMS

The Power Wave AC/DC 1000 is equipped with three externally mounted status lights, one for the power source, and each module contained in the power source. If a problem occurs it is important to note the condition of the status lights. **Therefore, prior to cycling power to the system, check the power source status light for error sequences as noted below.**

Included in this section is information about the power source, Wire Drive Module, and Communication Module Status LED's, and some basic troubleshooting charts for both machine and weld performance.

The STATUS LIGHTS are dual-color LED's that indicate system errors. Normal operation for each is steady green. Error conditions are indicated in the following chart.

Troubleshooting the Power Wave AC/DC 1000 Using the External Status LED's

Steady Green	System OK. Power source is operational, and is communicating normally with all healthy peripheral equipment connected to its ArcLink network.
Blinking Green	Occurs during power up or a system reset, and indicates the Power Wave AC/DC 1000 is mapping (identifying) each component in the system. Normal for first 1-10 seconds after power is turned on, or if the system configuration is changed during operation.
Fast Blinking Green	Indicates Auto-mapping has failed
Alternating Green and Red	<p>Non-recoverable system fault. If the Status lights are flashing any combination of red and green, errors are present. Read the error code(s) before the machine is turned off.</p> <p>Error Code interpretation through the Status light is detailed in the Service Manual. Individual code digits are flashed in red with a long pause between digits. If more than one code is present, the codes will be separated by a green light. Only active error conditions will be accessible through the Status Light.</p> <p>Error codes can also be retrieved with the Diagnostics Utility (included on the Power Wave Submerged Arc Utilities and Service Navigator CD's). This is the preferred method, since it can access historical information contained in the error logs.</p> <p>To clear the active error(s), turn power source off, and back on to reset.</p>
Steady Red	Not applicable.
Blinking Red	Not applicable.

CAUTION

If for any reason you do not understand the test procedures or are unable to perform the tests/repairs safely, contact your **Local Lincoln Authorized Field Service Facility** for technical troubleshooting assistance before you proceed.

POWER WAVE® AC/DC 1000



Observe all Safety Guidelines detailed throughout this manual

ERROR CODES

The following is a partial list of possible error codes for the Power Wave AC/DC 1000. For a complete listing consult the Service Manual for this machine.

POWER SOURCE- WELD CONTROLLER

Error Code #	Indication
31 Primary (Input) overcurrent error.	Excessive Primary current present. May be related to a switch board or output rectifier failure.
32 Capacitor "A" under voltage (Left side facing machine)	Low voltage on the main capacitors. May be caused by improper input configuration, or an open/short circuit in the primary side of the machine.
33 Capacitor "B" under voltage (Right side facing machine)	
34 Capacitor "A" over voltage (Left side facing machine)	Excess voltage on the main capacitors. May be caused by improper input configuration, , excessive line voltage, or improper capacitor balance (see Error 43)
35 Capacitor "B" over voltage (Right side facing machine)	
36 Thermal error	Indicates over temperature. Usually accompanied by Thermal LED. Check fan operation. Be sure process does not exceed duty cycle limit of the machine.
37 Soft start error	Capacitor pre-charge failed. Usually accompanied by codes 32-35.
41 Secondary (Output) overcurrent error	The long term average secondary (weld) current limit has been exceeded. This error will cause the machine output to phase back to 100 amps, typically resulting in a condition referred to as "noodle welding". NOTE: The long term average secondary current limit is 1050 amps.
43 Capacitor delta error	The maximum voltage difference between the main capacitors has been exceeded. May be accompanied by errors 32-35. May be caused by an open or short in the primary or secondary circuit(s).
46 Secondary (Output) overcurrent error	Absolute maximum output level has been exceeded. Usually associated with excessive short circuit currents and/or specific weld mode issues. This is a short term average designed to protect the inverter switching circuitry.
49 Single phase error	Indicates machine is running on single phase input power. Usually caused by the loss of the middle leg of the input power (L2).
54 Secondary (Output) overcurrent error	The long term average secondary (weld) current limit has been exceeded. This error will immediately turn off the machine output.
Other	Error codes that contain three or four digits are defined as fatal errors. These codes generally indicate internal errors on the Power Source Control Board. If cycling the input power on the machine does not clear the error, contact the Service Department.

CAUTION

If for any reason you do not understand the test procedures or are unable to perform the tests/repairs safely, contact your **Local Lincoln Authorized Field Service Facility** for technical troubleshooting assistance before you proceed.

POWER WAVE® AC/DC 1000



Observe all Safety Guidelines detailed throughout this manual

WIRE DRIVE MODULE

Error Code #	Indication
81 Motor Overload	Long term average motor current limit has been exceeded. Typically indicates mechanical overload of system. If problem continues consider higher gear ratio.
82 Motor Overcurrent	Absolute maximum motor current level has been exceeded. This is a short term average to protect drive circuitry.
83 Shutdown #1	The normally closed circuit of Shutdown #1 has been interrupted. Check the connection between pins 9 and 10 on the External I/O connector (S7).
84 Shutdown #2	The normally closed circuit of Shutdown #2 has been interrupted. Check the connection between pins 9 and 11 on the External I/O connector (S7).

COMMUNICATION MODULE

Error Code #	Indication
118 DeviceNet connection error	Lost Connection with DeviceNet Master
119 DeviceNet de-allocation error	The DeviceNet Master de-allocated the connection
133 Write ArcLink action failure	May be caused by activating Cold Inch while welding through DeviceNet
145 Duplicate MAC ID error	Check MAC ID assignments on DeviceNet Setup Dip switch Bank (S2)
146 DeviceNet Bus off	Check condition of on board DeviceNet Status indicators
147 DeviceNet polled I/O error	Problem changing attribute over polled I/O
149 DeviceNet I/O data error	Received DeviceNet I/O data with wrong number of bytes
169 Ethernet Connection Time out 171 Ethernet Socket Time out 172 Ethernet Watch Dog Time out	Loss of communication with PC Application.
194 Ethernet Send Problem 195 Ethernet Problem 197 Ethernet Problem	Communication problem between Master and Slave machines.
198 Ethernet Client Time out	Master lost communications with Slave Machine.
216 Ethernet Problem	Communication problem between Master and Slave machines.
224 Ethernet Problem	Master had problem connecting to a Slave machine.
226 Ethernet Problem	Communication problem between Master and Slave machines.

CAUTION

If for any reason you do not understand the test procedures or are unable to perform the tests/repairs safely, contact your **Local Lincoln Authorized Field Service Facility** for technical troubleshooting assistance before you proceed.

POWER WAVE® AC/DC 1000



POWER WAVE™ AC/DC 1000 (460/500/575) POWER SOURCE WIRING DIAGRAM FOR CODE 11124

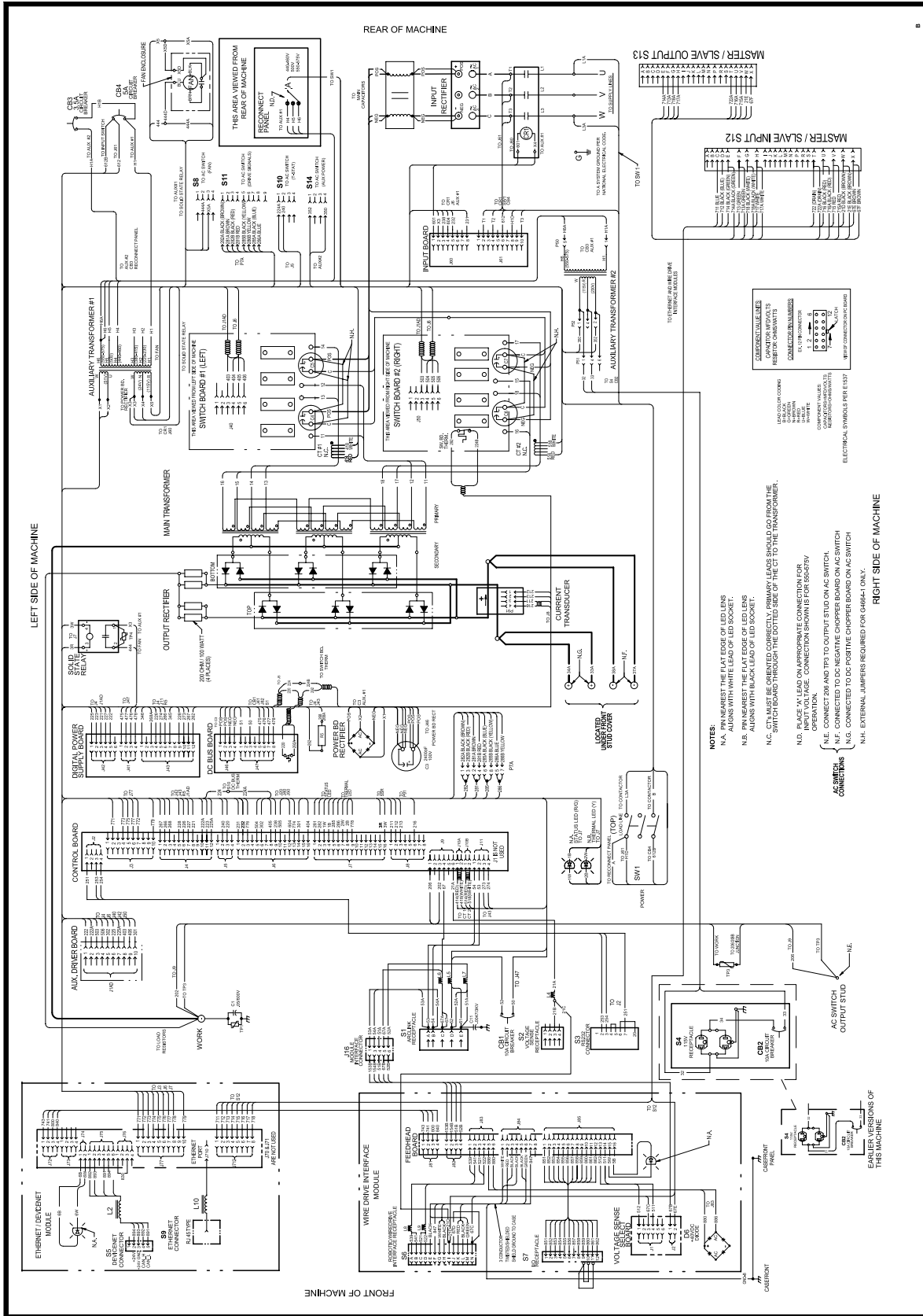

G4601

NOTE: This diagram is for reference only. It may not be accurate for all machines covered by this manual. The specific diagram for a particular code is pasted inside the machine on one of the enclosure panels. If the diagram is illegible, write to the Service Department for a replacement. Give the equipment code number.

POWER WAVE® AC/DC 1000



POWER WAVE™ AC/DC 1000 (400/460/500/575) POWER SOURCE WIRING DIAGRAM FOR CODE 11226

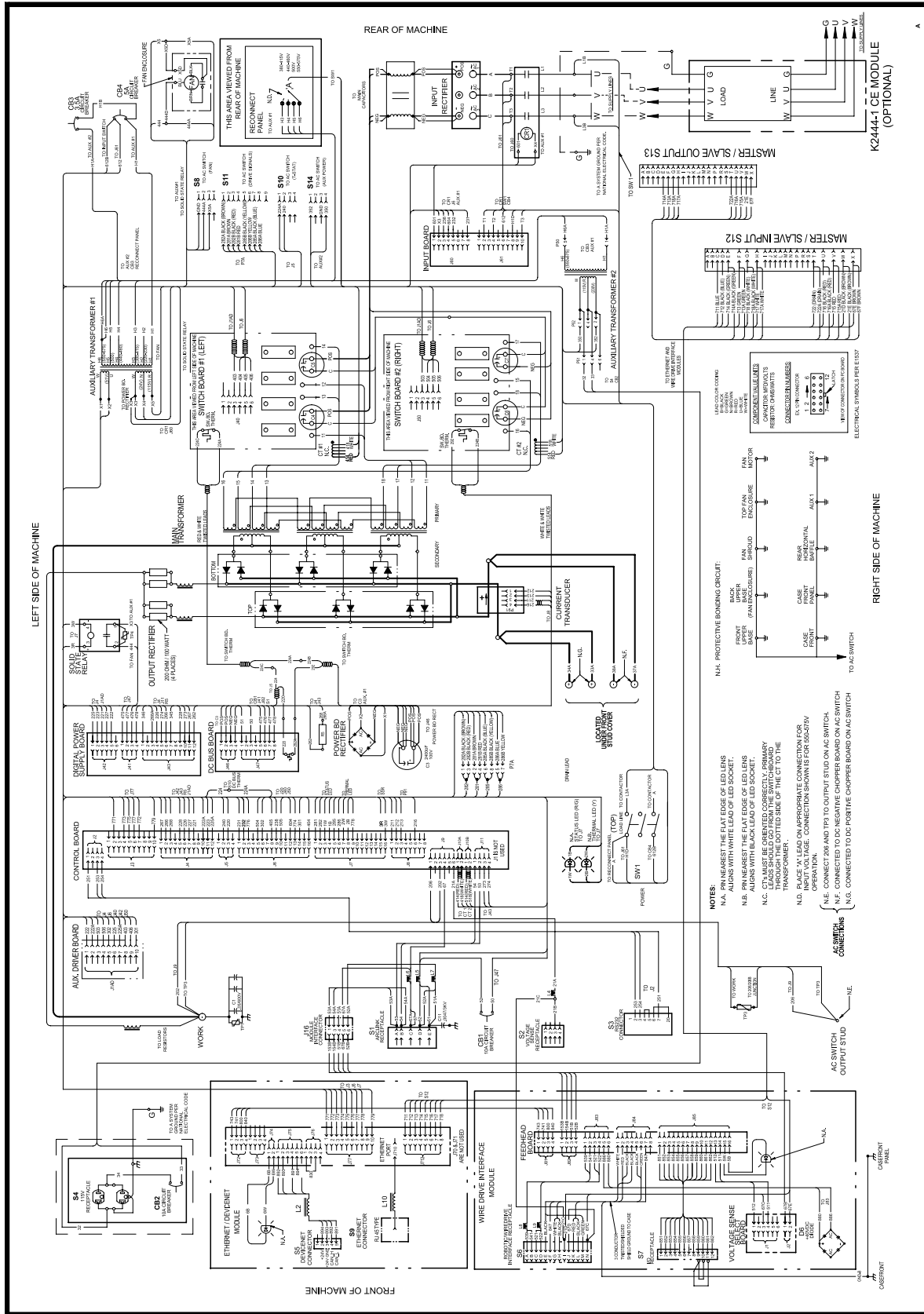

G4601-1

NOTE: This diagram is for reference only. It may not be accurate for all machines covered by this manual. The specific diagram for a particular code is pasted inside the machine on one of the enclosure panels. If the diagram is illegible, write to the Service Department for a replacement. Give the equipment code number.

POWER WAVE® AC/DC 1000



POWER WAVE™ AC/DC 1000 (460/500/575) AC SWITCH WIRING DIAGRAM FOR CODE 11124

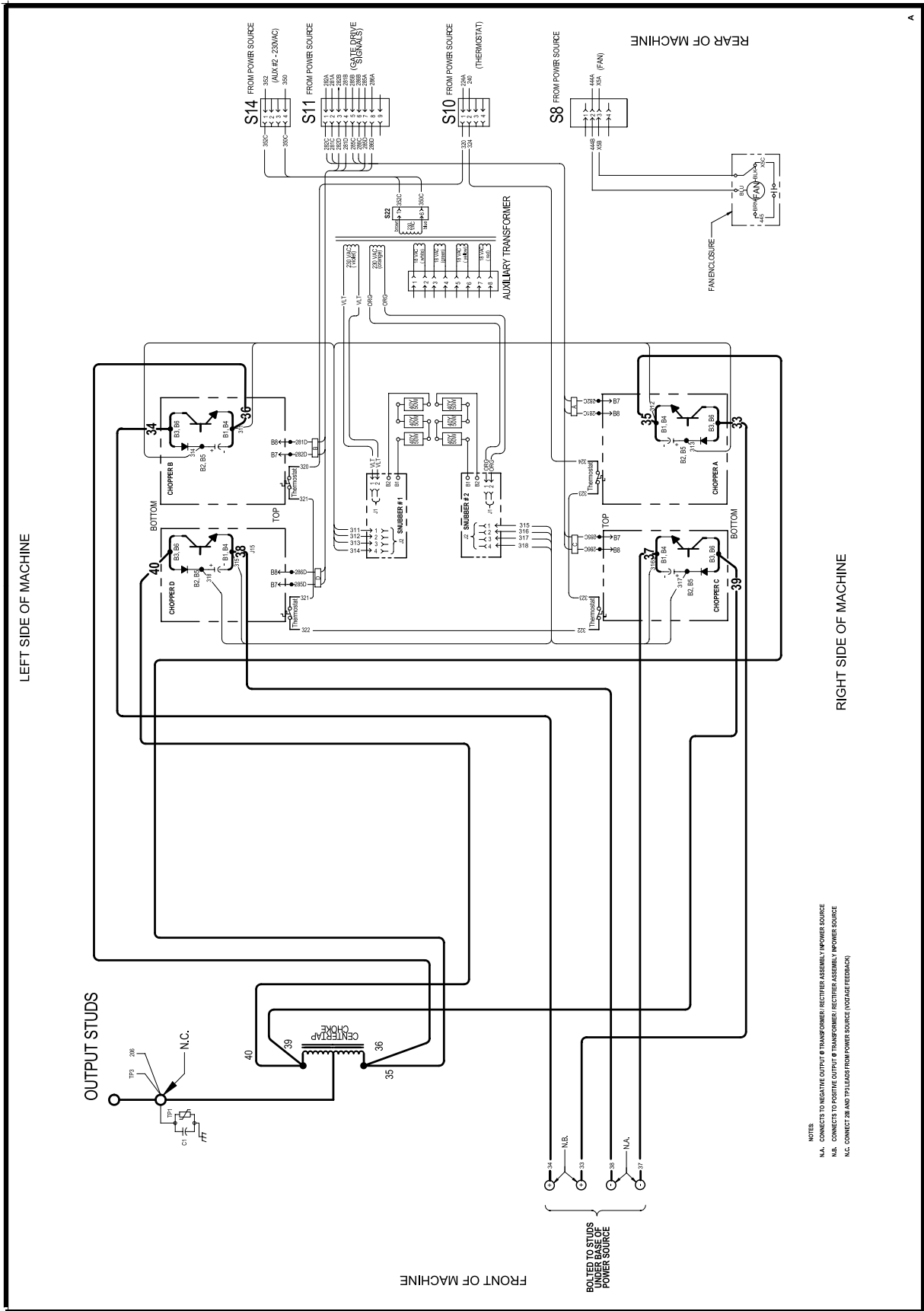

G4637

POWER WAVE™ AC/DC 1000 (400/460/500/575) AC SWITCH WIRING DIAGRAM FOR CODE 11226

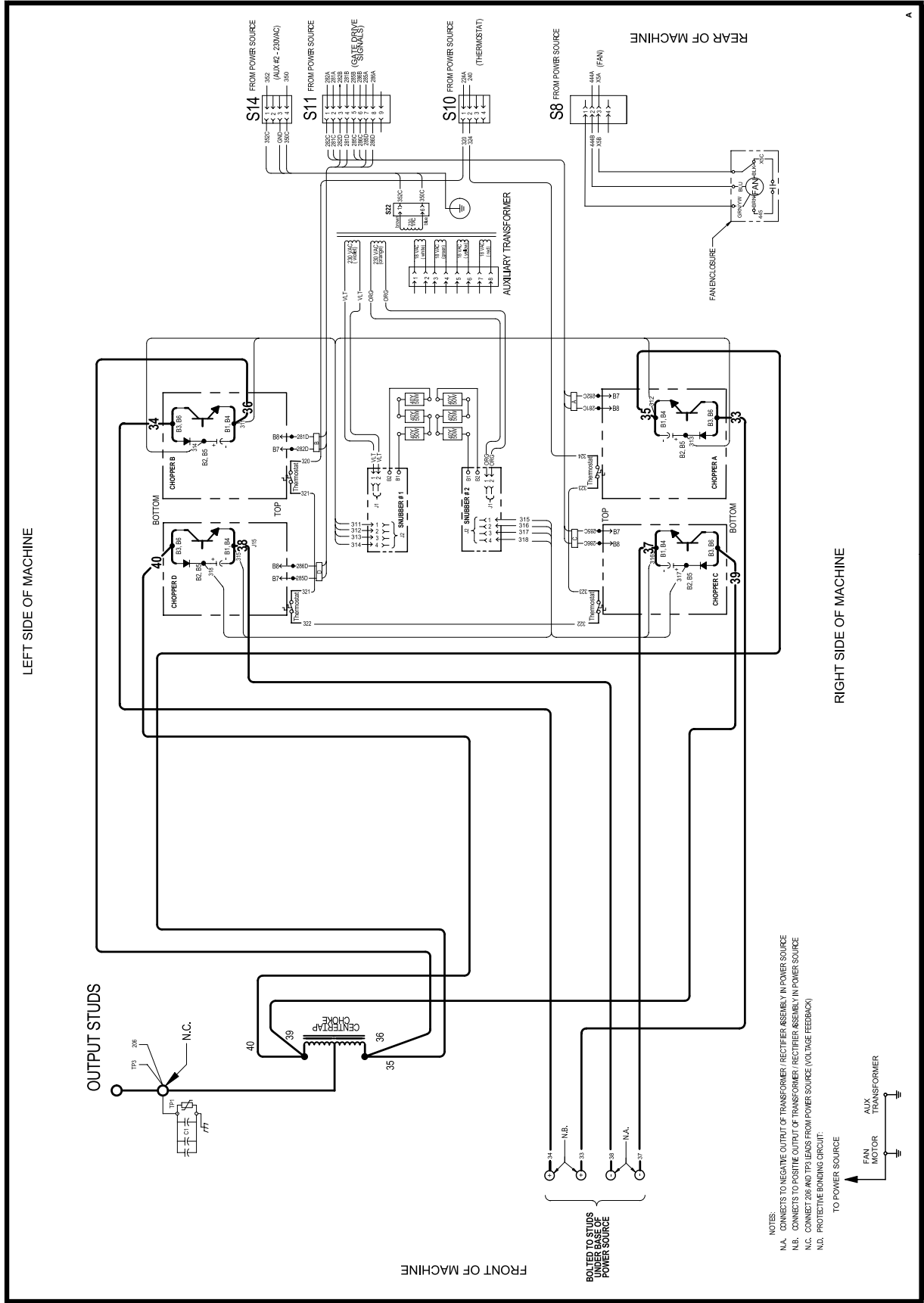

G4637-1

OUTPUT STUDS

LEFT SIDE OF MACHINE

FRONT OF MACHINE

RIGHT SIDE OF MACHINE

REAR OF MACHINE

- NOTES:
- N.A. CONNECTS TO NEGATIVE OUTPUT OF TRANSFORMER / RECTIFIER ASSEMBLY IN POWER SOURCE
 - N.B. CONNECTS TO POSITIVE OUTPUT OF TRANSFORMER / RECTIFIER ASSEMBLY IN POWER SOURCE
 - N.C. CONNECT 206 AND TP3 LEADS FROM POWER SOURCE (VOLTAGE FEEDBACK)
 - N.D. PROTECTIVE BONDING CIRCUIT.

BOLTED TO STUDS UNDER BASE OF POWER SOURCE

TO POWER SOURCE

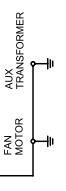

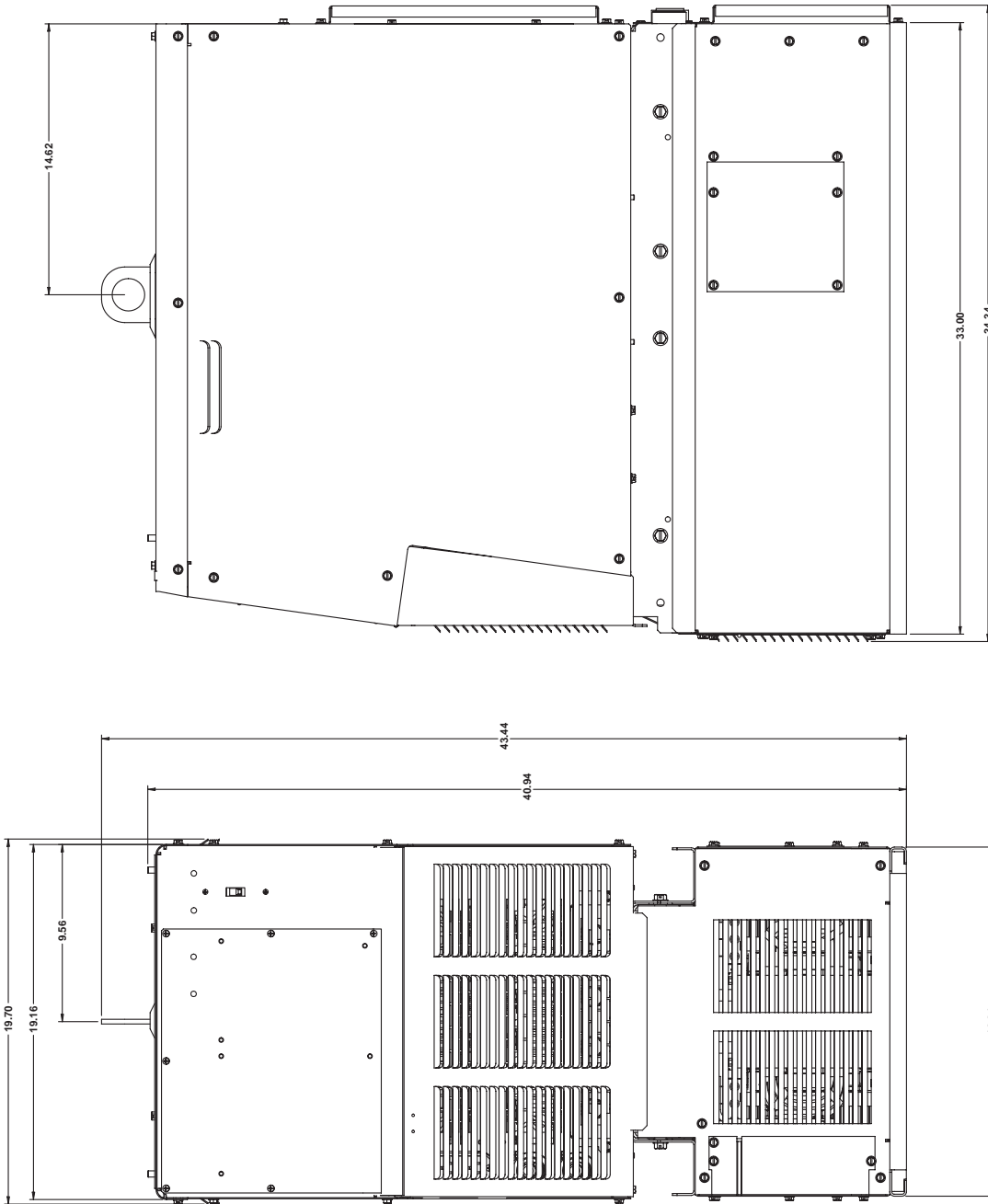

A01
L12302

POWER WAVE® AC/DC 1000



NOTES

POWER WAVE® AC/DC 1000



			
WARNING	<ul style="list-style-type: none"> Do not touch electrically live parts or electrode with skin or wet clothing. Insulate yourself from work and ground. 	<ul style="list-style-type: none"> Keep flammable materials away. 	<ul style="list-style-type: none"> Wear eye, ear and body protection.
Spanish AVISO DE PRECAUCION	<ul style="list-style-type: none"> No toque las partes o los electrodos bajo carga con la piel o ropa mojada. Aíslese del trabajo y de la tierra. 	<ul style="list-style-type: none"> Mantenga el material combustible fuera del área de trabajo. 	<ul style="list-style-type: none"> Protéjase los ojos, los oídos y el cuerpo.
French ATTENTION	<ul style="list-style-type: none"> Ne laissez ni la peau ni des vêtements mouillés entrer en contact avec des pièces sous tension. Isolez-vous du travail et de la terre. 	<ul style="list-style-type: none"> Gardez à l'écart de tout matériel inflammable. 	<ul style="list-style-type: none"> Protégez vos yeux, vos oreilles et votre corps.
German WARNUNG	<ul style="list-style-type: none"> Berühren Sie keine stromführenden Teile oder Elektroden mit Ihrem Körper oder feuchter Kleidung! Isolieren Sie sich von den Elektroden und dem Erdboden! 	<ul style="list-style-type: none"> Entfernen Sie brennbares Material! 	<ul style="list-style-type: none"> Tragen Sie Augen-, Ohren- und Körperschutz!
Portuguese ATENÇÃO	<ul style="list-style-type: none"> Não toque partes elétricas e electrodos com a pele ou roupa molhada. Isole-se da peça e terra. 	<ul style="list-style-type: none"> Mantenha inflamáveis bem guardados. 	<ul style="list-style-type: none"> Use proteção para a vista, ouvido e corpo.
Japanese 注意事項	<ul style="list-style-type: none"> 通電中の電気部品、又は溶材にヒブやぬれた布で触れないこと。 施工物やアースから身体が絶縁されている様にして下さい。 	<ul style="list-style-type: none"> 燃えやすいものの側での溶接作業は絶対にしてはなりません。 	<ul style="list-style-type: none"> 目、耳及び身体に保護具をして下さい。
Chinese 警告	<ul style="list-style-type: none"> 皮肤或湿衣物切勿接触带电部件及焊缝。 使你自己与地面和工件绝缘。 	<ul style="list-style-type: none"> 把一切易燃物品移离工作场所。 	<ul style="list-style-type: none"> 佩戴眼、耳及身体劳动保护用具。
Korean 위험	<ul style="list-style-type: none"> 전도체나 용접봉을 젖은 헝겍 또는 피부로 절대 접촉치 마십시오. 모재와 접지를 접촉치 마십시오. 	<ul style="list-style-type: none"> 인화성 물질을 접근시키지 마십시오. 	<ul style="list-style-type: none"> 눈, 귀와 몸에 보호장구를 착용하십시오.
Arabic تحذير	<ul style="list-style-type: none"> لا تلمس الاجزاء التي يسري فيها التيار الكهربائي أو الألكترود بجلك الجسم أو بالملابس المبللة بالماء. ضع عازل على جسمك خلال العمل. 	<ul style="list-style-type: none"> ضع المواد القابلة للاشتعال في مكان بعيد. 	<ul style="list-style-type: none"> ضع أدوات وملابس واقية على عينيك وأذنيك وجسمك.

READ AND UNDERSTAND THE MANUFACTURER'S INSTRUCTION FOR THIS EQUIPMENT AND THE CONSUMABLES TO BE USED AND FOLLOW YOUR EMPLOYER'S SAFETY PRACTICES.

SE RECOMIENDA LEER Y ENTENDER LAS INSTRUCCIONES DEL FABRICANTE PARA EL USO DE ESTE EQUIPO Y LOS CONSUMIBLES QUE VA A UTILIZAR, SIGA LAS MEDIDAS DE SEGURIDAD DE SU SUPERVISOR.

LISEZ ET COMPRENEZ LES INSTRUCTIONS DU FABRICANT EN CE QUI REGARDE CET EQUIPMENT ET LES PRODUITS A ETRE EMPLOYES ET SUIVEZ LES PROCEDURES DE SECURITE DE VOTRE EMPLOYEUR.

LESEN SIE UND BEFOLGEN SIE DIE BETRIEBSANLEITUNG DER ANLAGE UND DEN ELEKTRODENEINSATZ DES HERSTELLERS. DIE UNFALLVERHÜTUNGSVORSCHRIFTEN DES ARBEITGEBERS SIND EBENFALLS ZU BEACHTEN.

			
<ul style="list-style-type: none"> ● Keep your head out of fumes. ● Use ventilation or exhaust to remove fumes from breathing zone. 	<ul style="list-style-type: none"> ● Turn power off before servicing. 	<ul style="list-style-type: none"> ● Do not operate with panel open or guards off. 	WARNING
<ul style="list-style-type: none"> ● Los humos fuera de la zona de respiración. ● Mantenga la cabeza fuera de los humos. Utilice ventilación o aspiración para gases. 	<ul style="list-style-type: none"> ● Desconectar el cable de alimentación de poder de la máquina antes de iniciar cualquier servicio. 	<ul style="list-style-type: none"> ● No operar con panel abierto o guardas quitadas. 	Spanish AVISO DE PRECAUCION
<ul style="list-style-type: none"> ● Gardez la tête à l'écart des fumées. ● Utilisez un ventilateur ou un aspirateur pour ôter les fumées des zones de travail. 	<ul style="list-style-type: none"> ● Débranchez le courant avant l'entretien. 	<ul style="list-style-type: none"> ● N'opérez pas avec les panneaux ouverts ou avec les dispositifs de protection enlevés. 	French ATTENTION
<ul style="list-style-type: none"> ● Vermeiden Sie das Einatmen von Schweißrauch! ● Sorgen Sie für gute Be- und Entlüftung des Arbeitsplatzes! 	<ul style="list-style-type: none"> ● Strom vor Wartungsarbeiten abschalten! (Netzstrom völlig öffnen; Maschine anhalten!) 	<ul style="list-style-type: none"> ● Anlage nie ohne Schutzgehäuse oder Innenschutzverkleidung in Betrieb setzen! 	German WARNUNG
<ul style="list-style-type: none"> ● Mantenha seu rosto da fumaça. ● Use ventilação e exaustão para remover fumo da zona respiratória. 	<ul style="list-style-type: none"> ● Não opere com as tampas removidas. ● Desligue a corrente antes de fazer serviço. ● Não toque as partes elétricas nuas. 	<ul style="list-style-type: none"> ● Mantenha-se afastado das partes moventes. ● Não opere com os painéis abertos ou guardas removidas. 	Portuguese ATENÇÃO
<ul style="list-style-type: none"> ● ヒュームから頭を離すようにして下さい。 ● 換気や排煙に十分留意して下さい。 	<ul style="list-style-type: none"> ● メンテナンス・サービスに取りかかる際には、まず電源スイッチを必ず切ってください。 	<ul style="list-style-type: none"> ● パネルやカバーを取り外したまま機械操作をしないで下さい。 	Japanese 注意事項
<ul style="list-style-type: none"> ● 頭部遠離煙霧。 ● 在呼吸區使用通風或排風器除煙。 	<ul style="list-style-type: none"> ● 維修前切斷電源。 	<ul style="list-style-type: none"> ● 儀表板打開或沒有安全罩時不準作業。 	Chinese 警告
<ul style="list-style-type: none"> ● 얼굴로부터 용접가스를 멀리하십시오. ● 호흡지역으로부터 용접가스를 제거하기 위해 가스제거기나 통풍기를 사용하십시오. 	<ul style="list-style-type: none"> ● 보수전에 전원을 차단하십시오. 	<ul style="list-style-type: none"> ● 관널이 열린 상태로 작동치 마십시오. 	Korean 위험
<ul style="list-style-type: none"> ● ابعء رأسك بعيداً عن الدخان. ● استعمل التهوية أو جهاز ضغط الدخان للخارج لكي تبعد الدخان عن المنطقة التي تتنفس فيها. 	<ul style="list-style-type: none"> ● اقطع التيار الكهربائي قبل القيام بأية صيانة. 	<ul style="list-style-type: none"> ● لا تشغيل هذا الجهاز اذا كانت الاغطية الحديدية الواقية ليست عليه. 	Arabic تحذير

LEIA E COMPREENDA AS INSTRUÇÕES DO FABRICANTE PARA ESTE EQUIPAMENTO E AS PARTES DE USO, E SIGA AS PRÁTICAS DE SEGURANÇA DO EMPREGADOR.

使う機械や溶材のメーカーの指示書をよく読み、まず理解して下さい。そして貴社の安全規定に従って下さい。

請詳細閱讀並理解製造廠提供的說明以及應該使用的銀焊材料，並請遵守貴方的有閣勞動保護規定。

이 제품에 동봉된 작업지침서를 숙지하시고 귀사의 작업자 안전수칙을 준수하시기 바랍니다.

اقرأ بتمعن وافهم تعليمات المصنع المنتج لهذه المعدات والمواد قبل استعمالها واتبع تعليمات الوقاية لصاحب العمل.



• World's Leader in Welding and Cutting Products •

• Sales and Service through Subsidiaries and Distributors Worldwide •

Cleveland, Ohio 44117-1199 U.S.A. TEL: 216.481.8100 FAX: 216.486.1751 WEB SITE: www.lincolnelectric.com

Download from [Www.Somanuals.com](http://www.Somanuals.com). All Manuals Search And Download.

Free Manuals Download Website

<http://myh66.com>

<http://usermanuals.us>

<http://www.somanuals.com>

<http://www.4manuals.cc>

<http://www.manual-lib.com>

<http://www.404manual.com>

<http://www.luxmanual.com>

<http://aubethermostatmanual.com>

Golf course search by state

<http://golfingnear.com>

Email search by domain

<http://emailbydomain.com>

Auto manuals search

<http://auto.somanuals.com>

TV manuals search

<http://tv.somanuals.com>