

# RANGER™ 300 D and 300 DLX

For use with machines having Code Numbers: **10399; 10400; 10850**

### Safety Depends on You

Lincoln arc welding and cutting equipment is designed and built with safety in mind. However, your overall safety can be increased by proper installation ... and thoughtful operation on your part. **DO NOT INSTALL, OPERATE OR REPAIR THIS EQUIPMENT WITHOUT READING THIS MANUAL AND THE SAFETY PRECAUTIONS CONTAINED THROUGHOUT.** And, most importantly, think before you act and be careful.



Date of Purchase: \_\_\_\_\_  
 Serial Number: \_\_\_\_\_  
 Code Number: \_\_\_\_\_  
 Model: \_\_\_\_\_  
 Where Purchased: \_\_\_\_\_

## OPERATOR'S MANUAL



Copyright © 2003 Lincoln Global Inc.

- World's Leader in Welding and Cutting Products •
- Sales and Service through Subsidiaries and Distributors Worldwide •

Cleveland, Ohio 44117-1199 U.S.A. TEL: 216.481.8100 FAX: 216.486.1751 WEB SITE: [www.lincolnelectric.com](http://www.lincolnelectric.com)

Download from [Www.Somanuals.com](http://Www.Somanuals.com). All Manuals Search And Download.

## ⚠ WARNING

### ⚠ CALIFORNIA PROPOSITION 65 WARNINGS ⚠

Diesel engine exhaust and some of its constituents are known to the State of California to cause cancer, birth defects, and other reproductive harm.

The Above For Diesel Engines

The engine exhaust from this product contains chemicals known to the State of California to cause cancer, birth defects, or other reproductive harm.

The Above For Gasoline Engines

**ARC WELDING CAN BE HAZARDOUS. PROTECT YOURSELF AND OTHERS FROM POSSIBLE SERIOUS INJURY OR DEATH. KEEP CHILDREN AWAY. PACEMAKER WEARERS SHOULD CONSULT WITH THEIR DOCTOR BEFORE OPERATING.**

Read and understand the following safety highlights. For additional safety information, it is strongly recommended that you purchase a copy of "Safety in Welding & Cutting - ANSI Standard Z49.1" from the American Welding Society, P.O. Box 351040, Miami, Florida 33135 or CSA Standard W117.2-1974. A Free copy of "Arc Welding Safety" booklet E205 is available from the Lincoln Electric Company, 22801 St. Clair Avenue, Cleveland, Ohio 44117-1199.

**BE SURE THAT ALL INSTALLATION, OPERATION, MAINTENANCE AND REPAIR PROCEDURES ARE PERFORMED ONLY BY QUALIFIED INDIVIDUALS.**



### FOR ENGINE powered equipment.

1.a. Turn the engine off before troubleshooting and maintenance work unless the maintenance work requires it to be running.



1.b. Operate engines in open, well-ventilated areas or vent the engine exhaust fumes outdoors.



1.c. Do not add the fuel near an open flame welding arc or when the engine is running. Stop the engine and allow it to cool before refueling to prevent spilled fuel from vaporizing on contact with hot engine parts and igniting. Do not spill fuel when filling tank. If fuel is spilled, wipe it up and do not start engine until fumes have been eliminated.

1.d. Keep all equipment safety guards, covers and devices in position and in good repair. Keep hands, hair, clothing and tools away from V-belts, gears, fans and all other moving parts when starting, operating or repairing equipment.

1.e. In some cases it may be necessary to remove safety guards to perform required maintenance. Remove guards only when necessary and replace them when the maintenance requiring their removal is complete. Always use the greatest care when working near moving parts.



1.f. Do not put your hands near the engine fan. Do not attempt to override the governor or idler by pushing on the throttle control rods while the engine is running.

1.g. To prevent accidentally starting gasoline engines while turning the engine or welding generator during maintenance work, disconnect the spark plug wires, distributor cap or magneto wire as appropriate.



1.h. To avoid scalding, do not remove the radiator pressure cap when the engine is hot.



### ELECTRIC AND MAGNETIC FIELDS may be dangerous

2.a. Electric current flowing through any conductor causes localized Electric and Magnetic Fields (EMF). Welding current creates EMF fields around welding cables and welding machines

2.b. EMF fields may interfere with some pacemakers, and welders having a pacemaker should consult their physician before welding.

2.c. Exposure to EMF fields in welding may have other health effects which are now not known.

2.d. All welders should use the following procedures in order to minimize exposure to EMF fields from the welding circuit:

2.d.1. Route the electrode and work cables together - Secure them with tape when possible.

2.d.2. Never coil the electrode lead around your body.

2.d.3. Do not place your body between the electrode and work cables. If the electrode cable is on your right side, the work cable should also be on your right side.

2.d.4. Connect the work cable to the workpiece as close as possible to the area being welded.

2.d.5. Do not work next to welding power source.

Mar '95



## ELECTRIC SHOCK can kill.

- 3.a. The electrode and work (or ground) circuits are electrically "hot" when the welder is on. Do not touch these "hot" parts with your bare skin or wet clothing. Wear dry, hole-free gloves to insulate hands.
- 3.b. Insulate yourself from work and ground using dry insulation. Make certain the insulation is large enough to cover your full area of physical contact with work and ground.
- In addition to the normal safety precautions, if welding must be performed under electrically hazardous conditions (in damp locations or while wearing wet clothing; on metal structures such as floors, gratings or scaffolds; when in cramped positions such as sitting, kneeling or lying, if there is a high risk of unavoidable or accidental contact with the workpiece or ground) use the following equipment:**
- Semiautomatic DC Constant Voltage (Wire) Welder.
  - DC Manual (Stick) Welder.
  - AC Welder with Reduced Voltage Control.
- 3.c. In semiautomatic or automatic wire welding, the electrode, electrode reel, welding head, nozzle or semiautomatic welding gun are also electrically "hot".
- 3.d. Always be sure the work cable makes a good electrical connection with the metal being welded. The connection should be as close as possible to the area being welded.
- 3.e. Ground the work or metal to be welded to a good electrical (earth) ground.
- 3.f. Maintain the electrode holder, work clamp, welding cable and welding machine in good, safe operating condition. Replace damaged insulation.
- 3.g. Never dip the electrode in water for cooling.
- 3.h. Never simultaneously touch electrically "hot" parts of electrode holders connected to two welders because voltage between the two can be the total of the open circuit voltage of both welders.
- 3.i. When working above floor level, use a safety belt to protect yourself from a fall should you get a shock.
- 3.j. Also see Items 6.c. and 8.



## ARC RAYS can burn.

- 4.a. Use a shield with the proper filter and cover plates to protect your eyes from sparks and the rays of the arc when welding or observing open arc welding. Headshield and filter lens should conform to ANSI Z87.1 standards.
- 4.b. Use suitable clothing made from durable flame-resistant material to protect your skin and that of your helpers from the arc rays.
- 4.c. Protect other nearby personnel with suitable, non-flammable screening and/or warn them not to watch the arc nor expose themselves to the arc rays or to hot spatter or metal.



## FUMES AND GASES can be dangerous.

- 5.a. Welding may produce fumes and gases hazardous to health. Avoid breathing these fumes and gases. When welding, keep your head out of the fume. Use enough ventilation and/or exhaust at the arc to keep fumes and gases away from the breathing zone. **When welding with electrodes which require special ventilation such as stainless or hard facing (see instructions on container or MSDS) or on lead or cadmium plated steel and other metals or coatings which produce highly toxic fumes, keep exposure as low as possible and below Threshold Limit Values (TLV) using local exhaust or mechanical ventilation. In confined spaces or in some circumstances, outdoors, a respirator may be required. Additional precautions are also required when welding on galvanized steel.**
- 5.b. Do not weld in locations near chlorinated hydrocarbon vapors coming from degreasing, cleaning or spraying operations. The heat and rays of the arc can react with solvent vapors to form phosgene, a highly toxic gas, and other irritating products.
- 5.c. Shielding gases used for arc welding can displace air and cause injury or death. Always use enough ventilation, especially in confined areas, to insure breathing air is safe.
- 5.d. Read and understand the manufacturer's instructions for this equipment and the consumables to be used, including the material safety data sheet (MSDS) and follow your employer's safety practices. MSDS forms are available from your welding distributor or from the manufacturer.
- 5.e. Also see item 1.b.

Mar '95



### WELDING SPARKS can cause fire or explosion.

6.a. Remove fire hazards from the welding area. If this is not possible, cover them to prevent the welding sparks from starting a fire.

Remember that welding sparks and hot materials from welding can easily go through small cracks and openings to adjacent areas. Avoid welding near hydraulic lines. Have a fire extinguisher readily available.

- 6.b. Where compressed gases are to be used at the job site, special precautions should be used to prevent hazardous situations. Refer to "Safety in Welding and Cutting" (ANSI Standard Z49.1) and the operating information for the equipment being used.
- 6.c. When not welding, make certain no part of the electrode circuit is touching the work or ground. Accidental contact can cause overheating and create a fire hazard.
- 6.d. Do not heat, cut or weld tanks, drums or containers until the proper steps have been taken to insure that such procedures will not cause flammable or toxic vapors from substances inside. They can cause an explosion even though they have been "cleaned". For information, purchase "Recommended Safe Practices for the Preparation for Welding and Cutting of Containers and Piping That Have Held Hazardous Substances", AWS F4.1 from the American Welding Society (see address above).
- 6.e. Vent hollow castings or containers before heating, cutting or welding. They may explode.
- 6.f. Sparks and spatter are thrown from the welding arc. Wear oil free protective garments such as leather gloves, heavy shirt, cuffless trousers, high shoes and a cap over your hair. Wear ear plugs when welding out of position or in confined places. Always wear safety glasses with side shields when in a welding area.
- 6.g. Connect the work cable to the work as close to the welding area as practical. Work cables connected to the building framework or other locations away from the welding area increase the possibility of the welding current passing through lifting chains, crane cables or other alternate circuits. This can create fire hazards or overheat lifting chains or cables until they fail.
- 6.h. Also see item 1.c.

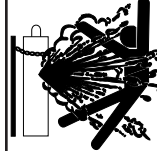

### CYLINDER may explode if damaged.

7.a. Use only compressed gas cylinders containing the correct shielding gas for the process used and properly operating regulators designed for the gas and pressure used. All hoses, fittings, etc. should be suitable for the application and maintained in good condition.

- 7.b. Always keep cylinders in an upright position securely chained to an undercarriage or fixed support.
- 7.c. Cylinders should be located:
  - Away from areas where they may be struck or subjected to physical damage.
  - A safe distance from arc welding or cutting operations and any other source of heat, sparks, or flame.
- 7.d. Never allow the electrode, electrode holder or any other electrically "hot" parts to touch a cylinder.
- 7.e. Keep your head and face away from the cylinder valve outlet when opening the cylinder valve.
- 7.f. Valve protection caps should always be in place and hand tight except when the cylinder is in use or connected for use.
- 7.g. Read and follow the instructions on compressed gas cylinders, associated equipment, and CGA publication P-1, "Precautions for Safe Handling of Compressed Gases in Cylinders," available from the Compressed Gas Association 1235 Jefferson Davis Highway, Arlington, VA 22202.



### FOR ELECTRICALLY powered equipment.

- 8.a. Turn off input power using the disconnect switch at the fuse box before working on the equipment.
- 8.b. Install equipment in accordance with the U.S. National Electrical Code, all local codes and the manufacturer's recommendations.
- 8.c. Ground the equipment in accordance with the U.S. National Electrical Code and the manufacturer's recommendations.

Mar '95



# Thank You

for selecting a **QUALITY** product by Lincoln Electric. We want you to take pride in operating this Lincoln Electric Company product  
•• as much pride as we have in bringing this product to you!

### **Please Examine Carton and Equipment For Damage Immediately**

When this equipment is shipped, title passes to the purchaser upon receipt by the carrier. Consequently, Claims for material damaged in shipment must be made by the purchaser against the transportation company at the time the shipment is received.

Please record your equipment identification information below for future reference. This information can be found on your machine nameplate.

Model Name & Number \_\_\_\_\_

Code & Serial Number \_\_\_\_\_

Date of Purchase \_\_\_\_\_

Whenever you request replacement parts for or information on this equipment always supply the information you have recorded above.

**Read this Operators Manual completely** before attempting to use this equipment. Save this manual and keep it handy for quick reference. Pay particular attention to the safety instructions we have provided for your protection. The level of seriousness to be applied to each is explained below:

### **⚠ WARNING**

This statement appears where the information **must** be followed **exactly** to avoid **serious personal injury** or **loss of life**.

### **⚠ CAUTION**

This statement appears where the information **must** be followed to avoid **minor personal injury** or **damage to this equipment**.

<b>Installation.....</b>	<b>Section A</b>
Technical Specifications .....	A-1
Installation Instructions.....	A-2
Location and Ventilation .....	A-2
Storing.....	A-2
Stacking .....	A-2
Tilting.....	A-2
High Altitude Operation .....	A-3
Lifting.....	A-3
Additional Safety Precautions .....	A-3
Pre-Operation Engine Service.....	A-3
Oil.....	A-3
Fuel .....	A-4
Engine Coolant.....	A-4
Battery Connections.....	A-4
Exhaust Deflector.....	A-4
Spark Arrester .....	A-4
Electrical Connections.....	A-5
Machine Grounding.....	A-5
Welding Cable Connections.....	A-5
Auxiliary Power Receptacles, Plugs, and Hand-Held Equipment .....	A-6
Circuit Breakers.....	A-6
Premises Wiring .....	A-6
<hr/>	
<b>Operation.....</b>	<b>Section B</b>
General Description.....	B-1
Design Features .....	B-1
Additional Features .....	B-2
Recommended Applications.....	B-2
Limitations .....	B-2
Additional Safety Precautions .....	B-2
Controls and Settings .....	B-2
Welder / Generator Controls .....	B-3
Engine Controls.....	B-4
Engine Operation .....	B-5
Before Starting the Engine .....	B-5
Starting the Engine.....	B-6
Cold Weather Starting and Operation .....	B-6
Stopping the Engine.....	B-6
Break-In Period .....	B-7
Welding Operation.....	B-7
AC / DC Stick (Constant Current) Welding .....	B-8
AC / DC TIG (Constant Current) Welding .....	B-9
DC Wire Feed Welding (CV) with <u>Ranger 300 DLX</u> .....	B-9
DC Wire Feed Welding (CV) with <u>Ranger 300 D</u> .....	B-10
Carbon Arc Gouging (Constant Current).....	B-10
Summary of Welding Processes and Machine Settings .....	B-11
Auxiliary Power.....	B-13
Simultaneous Welding and Power Loads .....	B-13
120 / 240 Volt Dual Voltage Receptacle .....	B-14
120 V Duplex Receptacles.....	B-14
<hr/>	
<b>Accessories .....</b>	<b>Section C</b>
General Options / Accessories.....	C-1
TIG Welding Options / Accessories.....	C-1
Semiautomatic FCAW and MIG Welding (Ranger 300 DLX) Options / Accessories .....	C-1
Semiautomatic FCAW and MIG Welding (Ranger 300 D) Options / Accessories.....	C-2

---

<b>Maintenance .....</b>	<b>Section D</b>
Safety Precautions .....	D-1
Kubota Engine Maintenance Schedule .....	D-1
Kubota Engine Maintenance Components .....	D-1
Routine and Periodic Engine Maintenance .....	D-2
Oil .....	D-2
Oil Filter .....	D-2
Fuel .....	D-3
Bleeding The Fuel System .....	D-3
Air Filter .....	D-3
Tightening the Fan Belt .....	D-3
Cooling System .....	D-3
Battery Maintenance .....	D-4
Welder / Generator Maintenance .....	D-5
Storage .....	D-5
Cleaning .....	D-5
Brush Removal and Replacement .....	D-5

---

<b>Troubleshooting .....</b>	<b>Section E</b>
Safety Precautions .....	E-1
How to Use Troubleshooting Guide .....	E-1
Troubleshooting Guide .....	E-2 thru E-4

---

<b>Connection Diagrams, Wiring Diagrams &amp; Dimension Print .....</b>	<b>Section F</b>
---	------------------

---

<b>Parts List .....</b>	<b>P-290 Series</b>
-------------------------	---------------------

---



## TECHNICAL SPECIFICATIONS - Ranger 300 D (K1522-1), Ranger 300 DLX (K1522-2)

INPUT - DIESEL ENGINE					
Make/Model	Description	Speed (RPM)	Displacement	Starting System	Capacities
Kubota DH905 Diesel Engine	3 cylinder 26.0 HP @ 3600 RPM	High Idle 3700 Low Idle 2150 Full Load 3600	54.9 cu. in (898 cc)	12VDC battery (Group 45, 495 cold crank amps) 1 KW Starter 30 A. Alternator w/ built in reg.	Fuel: 10 gal. 38 L  Oil: 5.4 Qts. 5.1 L  Coolant: 5.7 qts. 5.4 L
			<b>Bore x Stroke</b>  2.83" x 2.90" (72 mm x 73.6mm)		
RATED OUTPUT - WELDER					
Welding Output		Volts at Rated Amps		Duty Cycle	Max. OCV @ 3700 RPM
DC Constant Current 300 amps		25 volts		100%	80 volts RMS
AC Constant Current 300 amps		25 volts		100%	
DC Constant Voltage (300 D) 200 amps		20 volts		100%	
DC Constant Voltage (300 DLX) 300 amps		30 volts		60%*	
DC Constant Voltage (300 DLX) 280 amps		30 volts		100%	
OUTPUT - GENERATOR					
Auxiliary Power <sup>1</sup>					
12,000 Watts, 60 Hz 120/240 Volts 100 % Duty Cycle					
PHYSICAL DIMENSIONS					
HEIGHT	WIDTH	DEPTH		WEIGHT	
37.38 in.	24.75 in.	60.50 in.		1093 lbs. (300 D) 1133 lbs. (300 DLX)	
949.4 mm	628.7 mm	1528.6 mm		480.8 kg. (300 D) 499.0 kg. (300 DLX)	

\* Duty cycle is based on a 10 minute period. The machine can be loaded to 300 amps for 6 minutes out of every 10 minute period.

1. Output rating in watts is equivalent to volt-amperes at unity power factor. Output voltage is within  $\pm 10\%$  at all loads up to rated capacity. When welding, available auxiliary power will be reduced.

### RANGER 300 D AND 300 DLX



## SAFETY PRECAUTIONS

**⚠ WARNING**

Do not attempt to use this equipment until you have thoroughly read the engine manufacturer's manual supplied with your welder. It includes important safety precautions, detailed engine starting, operating and maintenance instructions, and parts lists.

**ELECTRIC SHOCK can kill.**

- Do not touch electrically live parts or electrode with skin or wet clothing.
- Insulate yourself from work and ground
- Always wear dry insulating gloves.

**ENGINE EXHAUST can kill.**

- Use in open, well ventilated areas or vent exhaust outside.

**MOVING PARTS can injure.**

- Do not operate with doors open or guards off.
- Stop engine before servicing.
- Keep away from moving parts.

See additional warning information at front of this operator's manual.

Only qualified personnel should install, use, or service this equipment.

## LOCATION AND VENTILATION

Whenever you use the RANGER 300, be sure that clean cooling air can flow through the machine's diesel engine and the machine case. Avoid dusty, dirty areas. Also, keep the machine away from heat sources. Do not place the engine end of the machine anywhere near hot engine exhaust from another machine or closer than two feet from a wall. And of course, make sure that engine exhaust is ventilated to an open, outside area.

The RANGER 300 may be used outdoors. Do not set the machine in puddles or otherwise submerge it in water. Such practices pose safety hazards and cause improper operation and corrosion of parts.

Always operate the RANGER 300 with the case roof on and all machine components completely assembled. This will protect you from the dangers of moving parts, hot metal surfaces, and live electrical devices.

**⚠ CAUTION****DO NOT MOUNT OVER COMBUSTIBLE SURFACES.**

Where there is a combustible surface directly under stationary or fixed electrical equipment, the surface shall be covered with a steel plate at least .06"(1.6mm) thick, which shall extend not more than 5.90"(150mm) beyond the equipment on all sides.

## STORING

1. Store the machine in a cool, dry place when it is not in use. Protect it from dust and dirt. Keep it where it can't be accidentally damaged from construction activities, moving vehicles, and other hazards.
2. Drain the engine oil and refill with fresh 10W30 oil. Run the engine for about five minutes to circulate oil to all the parts. See the MAINTENANCE section of this manual for details on changing oil.
3. If you are storing the machine for more than 30 days, drain the coolant from the radiator. Open the cock at the bottom of the radiator and remove the pressure cap so that the coolant drains completely. Attach a note that says "NO WATER" on the radiator.
4. Remove the battery, recharge it, and adjust the electrolyte level. Store the battery in a dry, dark place.
5. If the engine is not used for a long period of time, every two to three months fill the radiator and run the engine for about five minutes to keep it free from rust.

## STACKING

RANGER 300 machines **CANNOT** be stacked.

## TILTING

Place the machine on a secure, level surface whenever you use it or store it. Any surfaces you place it on other than the ground must be firm, non-skid, and structurally sound.

The diesel engine is designed to run in a level position for best performance. It can operate at an angle, but this should never be more than 20 degrees in any direction. If you do operate it at a slight angle, be sure to check the oil regularly and keep the oil level at the FULL mark as it would be in its normal level condition. Also, fuel capacity will be a little less at an angle.

RANGER 300 D AND 300 DLX



## HIGH ALTITUDE OPERATION

It may be necessary to de-rate the welder output at higher altitudes. Derate the welder output 0.4% for every 100 ft. (30 m) above 500 ft. (150 m). Some engine adjustment may be required above 5,000 ft. (1,500 m). Contact a Kubota Service Representative.

## LIFTING

The RANGER 300 weighs approximately 1150 lbs/522 kg. A lift bail is mounted to the machine frame and should always be used when lifting the machine.

## ADDITIONAL SAFETY PRECAUTIONS

### ⚠ WARNING



**FALLING EQUIPMENT** can cause injury.

- Do not lift this machine using lift bale if it is equipped with a heavy accessory such as trailer or gas cylinder.
- Lift only with equipment of adequate lifting capacity.
- Be sure machine is stable when lifting.

The recommended undercarriage for use with this equipment for in-plant and yard towing by a vehicle is Lincoln's K953-1. If the user adapts a non-Lincoln undercarriage, he must assume responsibility that the method of attachment and usage does not result in a safety hazard nor damage the welding equipment. Some of the factors to be considered are as follows:

1. Design capacity of undercarriage vs. weight of Lincoln equipment and likely additional attachments.
2. Proper support of, and attachment to, the base of the welding equipment so there will be no undue stress to the framework.
3. Proper placement of the equipment on the undercarriage to insure stability side to side and front to back when being moved and when standing by itself while being operated or serviced.

4. Typical conditions of use, i.e., travel speed; roughness of surface on which the undercarriage will be operated; environmental conditions; likely maintenance.

5. Conformance with federal, state and local laws.<sup>(1)</sup>

(1) Consult applicable federal, state and local laws regarding specific requirements for use on public highways.

## PRE-OPERATION ENGINE SERVICE

### ⚠ CAUTION

READ and UNDERSTAND the engine operating and maintenance instructions supplied with this machine.

### ⚠ WARNING

- Keep hands way from the engine muffler or HOT engine parts.
- Stop the engine when fueling.
- Do not smoke when fueling.
- Do not overfill the fuel tank.
- Wipe up spilled fuel and allow the fumes to clear before starting the engine.
- Keep sparks and flame away from the fuel tank.

### OIL

The RANGER 300 is shipped with the engine filled with SAE 10W-30 oil. CHECK THE OIL LEVEL BEFORE YOU START THE ENGINE. If it is not full, add enough oil to fill it to the full mark.

Always use oil that is rated for diesel engine service (API classification of CD/CE).

For more information on oil viscosity and service conditions, see the MAINTENANCE section of this manual and the engine Operator's Manual.

## RANGER 300 D AND 300 DLX



**FUEL**

Fill the fuel tank with clean No. 2, diesel fuel only. Do not fill to the top of the filler neck to allow room for expansion.

The RANGER 300 has a 10 gallon (38 liter) fuel tank with a top fill and fuel gauge mounted on the control panel. See the OPERATION and MAINTENANCE sections of this manual for more details about fuel.

**ENGINE COOLANT**
**WARNING**

**HOT COOLANT** can burn skin.

- Do not remove cap if radiator is hot.

The welder is shipped with the engine and radiator filled with a 50% mixture of ethylene glycol and water. The recovery bottle should be partially filled. See the MAINTENANCE section and the engine Operator's Manual for more information on coolant.

**BATTERY CONNECTIONS**
**WARNING**

**GASES FROM BATTERY** can explode.

- Keep sparks, flame and cigarettes away from battery.

To prevent **EXPLOSION** when:

- **INSTALLING A NEW BATTERY** — disconnect negative cable from old battery first and connect to new battery last.
- **CONNECTING A BATTERY CHARGER** — remove battery from welder by disconnecting negative cable first, then positive cable and battery clamp. When reinstalling, connect negative cable last. Keep well ventilated.
- **USING A BOOSTER** — connect positive lead to battery first then connect negative lead to negative battery lead at engine foot.



- **BATTERY ACID** can burn eyes and skin.
- Wear gloves and eye protection and be careful when working near battery.

- Follow instructions printed on battery.

**IMPORTANT:** To prevent **ELECTRICAL DAMAGE** WHEN:

- Installing new batteries.
- Using a booster.

Use correct polarity — **Negative Ground**.

The RANGER 300 is shipped with the negative battery cable disconnected. Before you operate the machine, make sure the Engine Switch is in the OFF position and attach the disconnected cable securely to the negative (-) battery terminal.

Remove the insulating cap from the negative battery terminal. Replace and tighten negative battery cable terminal. **NOTE:** This machine is furnished with a wet charged battery; if unused for several months, the battery may require a booster charge. Be sure to use the correct polarity when charging the battery.

**EXHAUST DEFLECTOR**
**CAUTION**

Shut off the machine and allow the muffler to cool before touching the muffler.

The RANGER 300 is shipped with the exhaust deflector detached. Install it on the muffler outlet using the clamp supplied. Rotate the deflector to the desired direction before tightening the clamp.

**SPARK ARRESTER**

Diesel engine mufflers may emit sparks when the engine is running. Some federal, state, or local laws require spark arresters in locations where unarrested sparks could present a fire hazard.

Standard muffler and deflectors (like the ones included with the RANGER 300 do not act as spark arresters. When local laws require it, a spark arrester must be installed on the machine and properly maintained. An optional spark arrester kit (K903-1) is available for your RANGER 300. See the ACCESSORIES section of this manual for more information.

**CAUTION**

An incorrect spark arrester may lead to damage to the engine or reduce performance.

RANGER 300 D AND 300 DLX



## ELECTRICAL CONNECTIONS

See Figure B.1 in the OPERATION section of this manual for location of the 115 and 230 volt receptacles, weld output terminals, circuit breakers and ground stud.

### MACHINE GROUNDING



Because the RANGER 300 creates its own power from its diesel-engine driven generator, and if the machine is not connected to premises wiring (home, shop, etc.), you do not need to connect the machine frame to an earth ground. However, for best protection against electrical shock, connect a heavy gauge wire (#8 AWG or larger) from the ground stud located on the bottom of the output panel (See Figure B.1) to a suitable earth ground such as a metal pipe driven into the ground.

### WARNING

Do not ground the machine to a pipe that carries explosive or combustible material.

When the Ranger 300 is mounted on a truck or a trailer, the machine generator ground stud **MUST** be securely connected to the metal frame of the vehicle. See Figure B.1. The ground stud is marked with the ground symbol.

If the RANGER 300 is connected to premises wiring such as a home or shop, it must be properly connected to the system earth ground.

## WELDING CABLE CONNECTIONS

### CABLE SIZE AND LENGTH

Be sure to use welding cables that are large enough. The correct size and length becomes especially important when you are welding at a distance from the welder.

Table A.1 lists recommended cable sizes and lengths for rated current and duty cycle. Length refers to the distance from the welder to the work and back to the welder. Cable diameters are increased for long cable lengths to reduce voltage drops.

Lincoln Electric offers a welding accessory kit with the properly specified welding cables. See the ACCESSORIES section of this manual for more information.

### TOTAL COMBINED LENGTH OF ELECTRODE AND WORK CABLES

Cable Length	Cable Size for 300 Amps 100% Duty Cycle
0-50 Ft. (0-15 meters)	1/0 AWG
50-100 Ft. (15-39 meters)	1/0 AWG
100-150 Ft. (30-46 meters)	2/0 AWG
150-200 Ft. (46-61 meters)	2/0 AWG
200-250 Ft. (61-76 meters)	3/0 AWG

**Table A.1**

### CABLE INSTALLATION

Install the welding cables to your RANGER 300 as follows. See Figure B.1 for location of parts.

1. The diesel engine must be OFF to install welding cables.
2. Remove the flanged nuts from the output terminals.
3. Connect the electrode holder and work cables to the weld output terminals. The terminals are identified on the case front.
4. Tighten the flanged nuts securely.
5. Be certain that the metal piece you are welding (the "work") is properly connected to the work clamp and cable.
6. Check and tighten the connections periodically.

### CAUTION

- Loose connections will cause the output terminals to overheat. The terminals may eventually melt.
- Do not cross the welding cables at the output terminal connection. Keep the cables isolated and separate from one another.

RANGER 300 D AND 300 DLX



## AUXILIARY POWER RECEPTACLES, PLUGS, AND HAND-HELD EQUIPMENT

The control panel of the RANGER 300 features three auxiliary power receptacles: See Figure B.1.

- Two 15 amp, 120 volt duplex (double outlet) receptacles.
- One 50 amp 120/240 volt simplex (single outlet) receptacle.

Through these receptacles the machine can supply up to 12,000 rated continuous watts of single-phase, 60 Hz AC power.

For further protection against electric shock, any electrical equipment connected to the generator receptacles must use a three-blade, grounded type plug or an Underwriter's Laboratories (UL) approved double insulation system with a two-blade plug. Lincoln offers an accessory plug kit that has the right type of plugs. See the ACCESSORIES section of this manual for more information.

If you need ground fault protection for hand-held equipment refer to the K896-1 GFCI Receptacle kit in the ACCESSORIES section of this manual for more information.

## CIRCUIT BREAKERS



The RANGER 300 machines are equipped with 50 amp circuit breakers on the 120/240 V receptacle and 15 amp circuit breakers on the 120 receptacles for overload protection. Under high heat a breaker may tend to trip at lower loads than it would normally.

### CAUTION

Never bypass the circuit breakers. Without overload protection, the RANGER 300 D/DLX could overheat and/or cause damage to the equipment being used.

## PREMISES WIRING

The RANGER 300 is suitable for temporary, standby, or emergency power using the engine manufacturer's recommended maintenance schedule. With its three-wire grounded neutral generator, it can be permanently installed as a standby power unit for 240 volt, three wire, single phase 50 ampere service.

### WARNING

Only a licensed, certified, trained electrician should install the machine to a premises or residential electrical system. Be certain that:

- The installation complies with the National Electrical Code and all other applicable electrical codes.
- The premises is isolated and no feedbacking into the utility system can occur. Certain state and local laws require the premises to be isolated before the generator is linked to the premises. Check your state and local requirements.
- A double pole, double throw transfer switch in conjunction with the properly rated double throw circuit breaker is connected between the generator power and the utility meter.

The following information and the connection diagram, Figure A.1, can be used as a guide by the electrician for most applications to premises wiring.

1. Install a double pole, double throw switch between the power company meter and the premises disconnect. The switch rating must be the same as or greater than the premises disconnect and service overcurrent protection.
2. Take the necessary steps to assure that the load is limited to the capacity of the RANGER 300 by installing a 50 amp 240 volt double pole circuit breaker. Maximum rated load for the 240 volt auxiliary is 50 amperes. Loading above 50 amperes will reduce output voltage below the allowable -10% of rated voltage. This may damage appliances or other motor-driven equipment.
3. Install a 50 amp 120/240 volt plug (NEMA type 14-50) to a double pole circuit breaker using No. 8 or larger, 4 conductor cable of the desired length. (The 50 amp 120/240 volt plug is available in the optional power plug kit.)
4. Plug this cable in to the 50 amp 120/240 volt receptacle on the RANGER 300 case front.

## RANGER 300 D AND 300 DLX



Figure A.1

CONNECTION OF RANGER 300 TO PREMISES WIRING

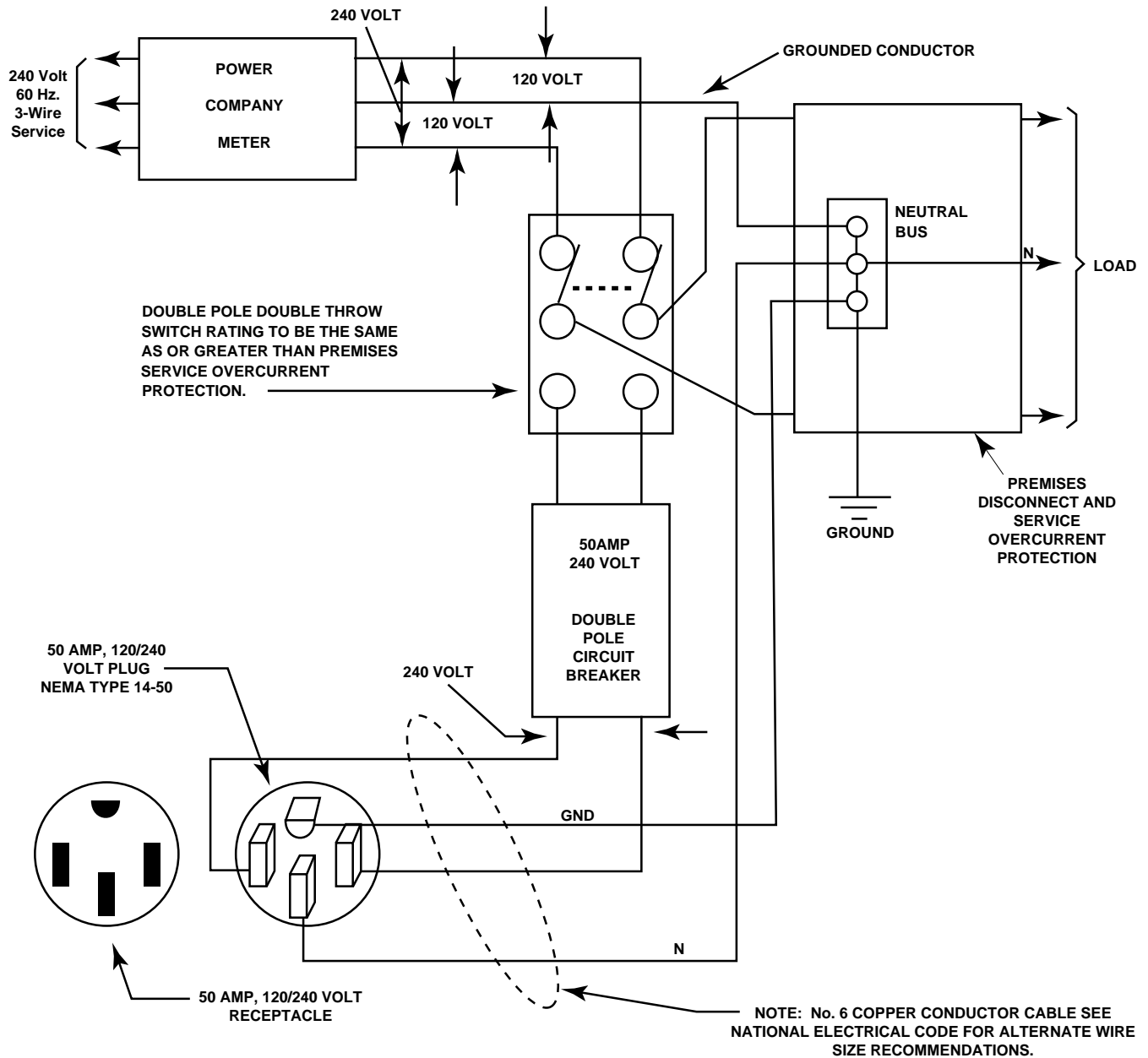

**⚠ WARNING**

Connection of Ranger 300 to premises wiring must be done by a licensed electrician and must comply with the National Electrical Code and all other applicable electrical codes.

RANGER 300 D AND 300 DLX



## GENERAL DESCRIPTION

The RANGER 300 is a diesel-engine driven, multi-process AC and DC arc welder and AC power generator for commercial and residential applications. As a generator it can supply up to 12,000 continuous watts of 120/240 volt, 60 Hz, single-phase AC power to operate AC power tools, battery chargers, and lighting; it can also be used to provide standby power. As a welder it provides 300 amps of AC current for welding with AC stick electrodes or 300 amps of DC current for DC stick welding. The RANGER 300 can also perform AC/DC TIG welding and DC semiautomatic wire feed welding.

The engine used on the Ranger 300 machines is the Kubota "Super Five" water-cooled, 3 cylinder DH905 engine. The DH905 has an offset piston design with built in steel strut and a more rigid crank-case. The Kubota "Three Vortex Combustion System" gives higher power output, lower fuel consumption, lower noise, and cleaner exhaust. The "Super Glow System" gives rapid pre-heating for easy starting in cold weather. The large oil sump adds to the long life of this engine. The high capacity 30 amp alternator gives fast charging of the 495 CCA battery. The engine is extremely smooth and has very low vibration, even at low idle speed.

The Ranger 300 machines are housed in a heavy gauge steel case that is protected by a durable powder paint finish. The case is completely insonorized for remarkably quiet operation. An easy to open hinged door allows access to the engine for single side service. The welder alternator has all copper windings and a high temperature insulation system that includes three coats of electrical grade varnish.

## DESIGN FEATURES - ALL MODELS

### FOR WELDING:

- Excellent AC and DC constant current output for stick welding applications.
- 40 to 300 amps constant current output with seven range settings.
- Excellent semi-automatic wire feed welding on constant voltage output range(s).
- TIG welding - full range on DC and up to 250 amps on AC.
- 100% duty cycle rating on all output ranges.
- Remote control capability standard on all models. Amphenol receptacle for easy connection of Lincoln remote control accessories.

### FOR AUXILIARY POWER:

- 12,000 watts of 120/240 volt 60Hz AC auxiliary power.
- Power for tools, lights, electric pumps and for standby emergency power.
- Drive a 2 HP motor (provided it is started under no load).
- Two 15 amp industrial grade 120 volt duplex receptacles for up to 60 amps of 120 volt power.
- One 50 amp 120/240 volt dual voltage receptacle for up to 50 amps of 240 volt auxiliary power. Allows easy connection to premises wiring.
- Four 15 amp circuit breakers for 120V duplex receptacles and 2-50 amp circuit breakers for 240V receptacle.
- Weld and have AC power at the same time (within machine total capacity).
- Compatible with GFCI's (ground fault circuit interrupters).

### OTHER FEATURES:

- Insonorized for extremely quiet operation (99LW(A) and 74 db(A) @ 23 ft (7m)).
- Kubota 3-cylinder, liquid cooled, diesel engine. Designed for long life, easy maintenance and excellent fuel economy and low noise.
- Engine always starts in low idle for minimum engine wear in cold weather.
- Manual operated lift pump for easy priming of engine if it runs out of fuel.
- Engine protection system shuts engine down on low oil pressure or over temperature of coolant.
- Indicator lights for low oil pressure, over temperature and battery charger low output.
- Engine Hour Meter standard on all models.
- Engine coolant recovery bottle eliminates air in radiator and makes it easy to check coolant level.
- Battery with 495 cold cranking amps.
- Straight through ventilation - cooling air for welder alternator enters front of machine and is exhausted out rear.
- Large capacity 10 gallon (38 l) fuel tank.
- Automatic idler reduces engine speed when not welding or drawing auxiliary power. Machine always starts in low idle. Reduces fuel consumption and extends engine life.
- Compact size fits many smaller trucks.
- Single side engine service with easy to open access door.
- Copper alternator windings and high temperature insulation for dependability and long life.
- Powder painted case and base for outstanding corrosion protection.

## RANGER 300 D AND 300 DLX





## ADDITIONAL FEATURES RANGER 300 D (K1522-1):

- One constant voltage wire-feed welding range - 80 to 200 amps.  
The wire feed setting permits the Ranger 300D to be used with the LN-25 Wire Feeder and .035, .045 or .068 NR®-211-MP Innershield electrodes. Limited MIG (GMAW) welding can also be done with .030 or .035 L-50 & L-56 using blended Argon shielding gas. "Auto-Idle" functions when using an LN-25 with an internal contactor.

## ADDITIONAL FEATURES RANGER 300 DLX (K1522-2):

- Four constant voltage (CV) wire-feed welding ranges with fine control on each range for welding at 40 to 300 amps.
- Excellent arc characteristics with MIG (GMAW) and recommended Innershield electrodes (FCAW).
- Wire feeder amphenol receptacle (14 pin) for quick connection of control cable.
- Voltmeter for reading CV wire-feed welding arc voltage.
- Built in contactor with front panel selection of "cold" or "hot" welding terminals.
- Aluminum TIG welding when used with K930-1 TIG Module. Output contactor control with Amptrol.
- Recommended wire feeders are the LN-25 with 42 Volt Remote Output Control Module or with internal contactor and all models of the LN-7.

## RECOMMENDED APPLICATIONS

### WELDER

The RANGER 300 provides excellent constant current AC/DC welding output for stick (SMAW) welding and for TIG welding, and it offers constant voltage output for DC semiautomatic wire feed welding.

### GENERATOR

The RANGER 300 gives AC generator output for medium use demands.

## LIMITATIONS

- The Ranger 300 is **not recommended** for any processes besides those that are normally performed using stick welding (SMAW), TIG welding (GTAW), MIG (GMAW) welding and Innershield® (FCAW) welding.
- The RANGER 300 D/DLX is **not recommended** for pipe thawing.
- During welding, generator power is limited and output voltages can drop. Therefore, **DO NOT OPERATE ANY SENSITIVE ELECTRICAL EQUIPMENT WHILE YOU ARE WELDING.** See Table B.4 for permissible simultaneous welding and auxiliary power loads.

## ADDITIONAL SAFETY PRECAUTIONS

Always operate the welder with the roof and case sides in place as this provides maximum protection from moving parts and assures proper cooling air flow.

Read and understand all Safety Precautions before operating this machine. Always follow these and any other safety procedures included in this manual and in the Engine Owner's Manual.

Only qualified personnel should install, use, or service this equipment.

## CONTROLS AND SETTINGS

All generator/welder controls are located on the Output Control Panel of the machine case front. Diesel engine glow plug, idler control, and start/stop controls are also on the case front. See Figure B.1 and the explanations that follow.

RANGER 300 D AND 300 DLX



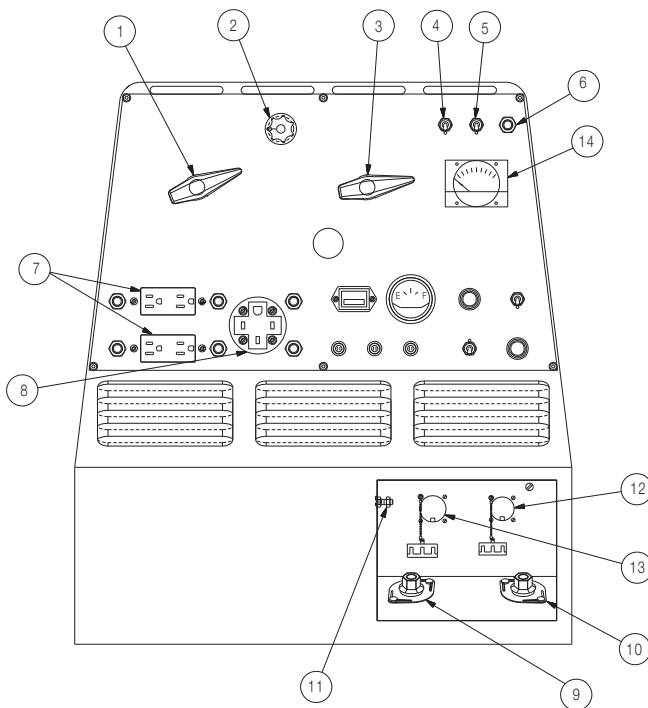

**FIGURE B.1  
OUTPUT PANEL CONTROLS**

## WELDER/GENERATOR CONTROLS

See Figure B.1 for the location of the following features:

1. **OUTPUT RANGE SELECTOR:** Selects continuous current output for constant current stick or TIG applications (blue settings) and constant voltage wire feed applications (red settings). The amperages on the dial correspond to the maximum amperages for each corresponding range setting. Never change the range switch setting while welding since this could damage the switch.
  2. **FINE OUTPUT CONTROL:** Allows fine adjustment of current or voltage within the selected output range.
  3. **POLARITY SWITCH:** Selects DC+, DC- or AC welding output. Color codings aid in the proper selection of stick (blue) or wire feed (red) polarity setting. On the RANGER 300 DLX the color setting of the polarity switch must match the color setting of the OUTPUT RANGE SELECTOR. Never change the polarity switch setting while welding since this could damage the switch.
  4. **CONTROL AT WELDER/REMOTE CONTROL SWITCH:** Allows the operator to control welding output at the welding control panel or at a remote station. Remote connections are made at the 6 pin or 14 pin amphenol connector.
  5. **WELDING TERMINALS SWITCH (DLX Model Only)**  
The toggle switch labeled "WELDING TERMINALS ALWAYS ON" and "WELDING TERMINALS REMOTELY CONTROLLED" is used to control the operation of the RANGER 300 DLX output contactor. With the switch in the "WELDING TERMINALS ALWAYS ON" position, the contactor is closed at low and high idle.
- When a wire feeder or TIG Module control cable is attached to either the 6 pin of 14 pin amphenol connector and the Welding Terminals switch is in the "WELDING TERMINALS REMOTELY CONTROLLED" position, the contactor is open in low idle and high idle until and the wire feeder trigger or Amptrol is closed. This closes the 2-4 circuit. When the gun trigger or Amptrol is released, the contactor opens and there is no voltage present at the electrode.
6. **WIRE FEEDER POWER CIRCUIT BREAKER:** Opens the wire feeder circuit and disables the feeder if a fault is detected in the circuit.
  7. **15 AMP, 120 VOLT DUPLEX RECEPTACLES:** Connection point for supplying 120 volt power to operate one or two electrical devices.
  8. **50 AMP, 120/240 VOLT RECEPTACLE:** Connection point for supplying 240 volt power to operate one electrical device.
  9. **WELD OUTPUT TERMINAL (TO WORK) WITH FLANGE NUT:** Provides the connection point for the work cable.
  10. **WELD OUTPUT TERMINAL (TO ELECTRODE HOLDER) WITH FLANGE NUT:** Provides the connection point for the electrode holder.
  11. **GROUND STUD:** Provides a connection point for connecting the machine case to earth ground for the safest grounding procedure.
  12. **6 PIN AMPHENOL:** For attaching optional remote control equipment to the RANGER 300 D/DLX (Includes contactor closure circuit on the Ranger 300 DLX & remote control circuit).
  13. **14 PIN AMPHENOL (DLX Model Only):** For attaching wire feeder control cables to the RANGER 300 DLX (Includes contractor closure circuit, remote control circuit, wire feeder 115/42 volt power source).
  14. **VOLTMETER (DLX MODEL ONLY) -** Displays actual voltage at the output terminals when welding in CV-mode.

RANGER 300 D AND 300 DLX



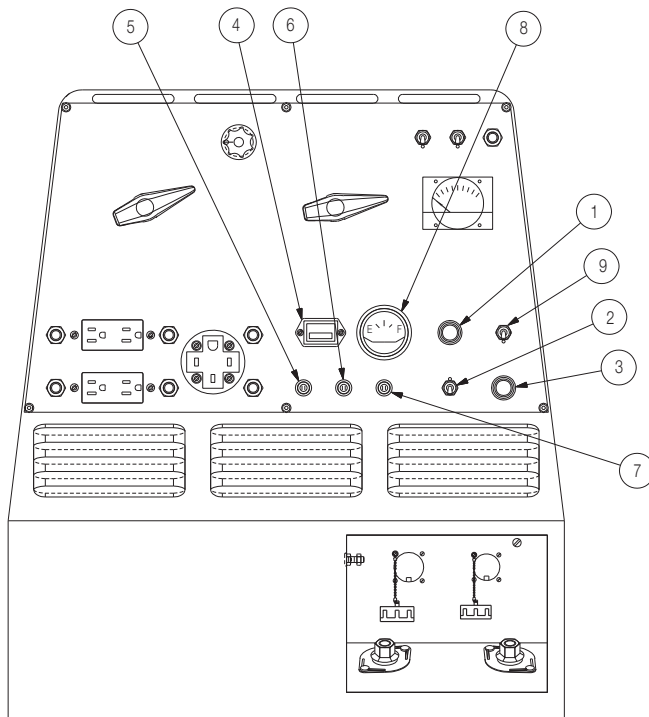





**FIGURE B.2  
DIESEL ENGINE CONTROLS**

## ENGINE CONTROLS

See Figure B.2 for the location of the following features:

1. GLOW PLUG PUSH-BUTTON: Activates glow plugs to preheat engine for starting. 
2. IDLER CONTROL SWITCH: The idler switch has two positions. "HIGH" and "AUTO".

When in "HIGH" (  ) position, the engine will run continuously at high speed for approximately 8 seconds and then go to high speed.

When in "AUTO" (  /  ) idle position, the idler operates as follows:

### a) Welding

Low idle with Ranger 300 DLX in the "WELDING TERMINALS ALWAYS ON" mode or with a Ranger 300D - When the electrode touches work, the welding arc is initiated and the engine to accelerates to full speed.

Low idle and in the "WELDING TERMINALS REMOTELY CONTROLLED" mode - Pressing the gun trigger or Amptrol closes the Ranger 300 DLX output contactor and causes the engine to accelerate to full speed.

After the gun trigger or Amptrol is released and/or welding ceases (and no auxiliary power is being drawn), the engine will return to low idle after approximately 10 to 14 seconds.

- b) Auxiliary Power - With the engine running at low idle and auxiliary power for lights or tools is drawn (approximately 100-150 watts or greater) from the receptacles, the engine will accelerate to high speed. If no power is being drawn from the receptacles (and not welding) for 10-14 seconds.

3. START PUSH-BUTTON: When the push-button is held, the starter motor cranks over the engine - release the Button once the engine starts. 

NOTE: If you press the START push-button when the engine is running, you may damage the ring gear or starter motor.

4. ENGINE HOUR METER: Records engine running time. Use to determine when to perform required maintenance.
5. BATTERY LIGHT: Is off when battery charging system is functioning normally. If the red light turns on while the engine is running, the fan belt may be broken or the alternator or the voltage regulator may be defective.

It is normal for the light to go on when the "Engine" switch is switched to the "ON" position with the engine not running. It will go off after one minute to prevent discharging the battery if the engine is not started. If this happens, the engine protection circuit must be reset by turning the "Engine" switch to the "OFF" position and back to the "ON" position.

6. OIL PRESSURE LIGHT: Remains off with proper oil pressure. If the red light turns on while the engine is running, the engine protection system will stop the engine. 

It is normal for the light to go on when the "Engine" switch is switched to the "ON" position with the engine not running. It will go off after one minute to prevent discharging the battery if the engine is not started. If this happens, the engine protection circuit must be reset by turning the "Engine" switch to the "OFF" position and back to the "ON" position.

## RANGER 300 D AND 300 DLX



7. **WATER TEMPERATURE LIGHT:** Remains off under normal operating temperatures.  If the red light turns on, the engine protection system will stop the engine. The light will remain on when the engine is over temperature and the "Engine" switch is in the "ON" position (engine not running) but will go off as the engine cools.
8. **FUEL LEVEL GAUGE:** Displays the level of diesel fuel in the 10-gallon fuel tank.
9. **ENGINE ON-OFF SWITCH:** Energizes the fuel solenoid in the ON position. In the STOP position, stops fuel flow to the injection pump and stops the engine.

## ENGINE OPERATION

### WARNING

DO NOT RUN THE ENGINE AT EXCESSIVE SPEEDS. The maximum allowable high idle speed for the RANGER 300 is 3700 RPM, no load. Do NOT adjust the governor screw on the engine. Severe personal injury and damage to the machine can result if it is operated at speeds above the maximum rated speed.

Read and understand all safety instructions included in the Kubota instruction manual that is shipped with your RANGER 300.

## BEFORE STARTING THE ENGINE

Check the engine oil level:  
See Figure D.1 for location of dipstick.



1. Be sure the machine is on a level surface.
2. Remove the engine oil dipstick and wipe it with a clean cloth. Reinsert the dipstick and check the level on the dipstick.
3. Add oil (if necessary) to bring the level up to the full mark. Do not overfill.
4. Replace the dipstick.

Check and fill the engine fuel tank:



### WARNING



**DIESEL fuel can cause fire or explosion.**

- Stop engine when fueling.
  - Do not smoke when fueling.
  - Do not overfill tank.
- Keep sparks and flame away from tank.

1. Remove the fuel tank cap.
2. Fill the tank approximately 4 inches (100 mm) from the top of the filler neck to allow for fuel expansion (observe the fuel gauge.) **DO NOT FILL THE TANK TO THE POINT OF OVERFLOW.**
3. Replace the fuel tank cap and tighten securely.

RANGER 300 D AND 300 DLX



**NOTE:** DO NOT allow the RANGER 300 to run out of fuel. If it does, you will have to bleed the injection system. See the Maintenance section of this manual and the Engine Operators Manual for instructions on bleeding the fuel injection system.

### ⚠ CAUTION

#### USE DIESEL FUEL ONLY

Purchase diesel fuel in quantities that will be used within 30 days, to assure freshness.

## STARTING THE ENGINE

### ⚠ CAUTION

Remove all loads connected to the AC power receptacles and the welder before starting the diesel engine.

1. Open the engine compartment door and check that the fuel shutoff valve located above the clear plastic fuel filter housing is in the open position (lever in the vertical position). See Figure B.3.

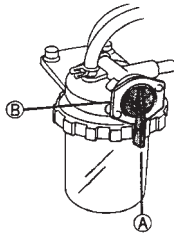

(A) "ON"  
(B) "OFF"

FIGURE B.3

2. Check for proper level of coolant in the plastic reserve overflow tank. The level should be between the full and the low marks.
3. Check for proper oil level on the oil dipstick. Close engine compartment door.
4. Set "IDLER" switch to "AUTO". 
5. Set the "ENGINE" switch to "ON". Observe that both the oil pressure light and battery charger light are on. Check the fuel gauge to make sure that there is an adequate fuel level (NEVER ALLOW THE RANGER 300 D/DLX TO RUN OUT OF FUEL).

6. Press the "GLOW PLUG" button to pre-heat the cylinders per the following table: 

Ambient Temperature	Pre-Heat Time
Above 50°F (10°C)	NOT REQUIRED
50°F (10°C) to 23°F (-5°C)	Approximately 5 seconds
Below 23°F (-5°C)	Approximately 10 seconds

### ⚠ CAUTION

Never press the Glow Plug button continuously for more than 20 seconds.

7. Release the "GLOW PLUG" button and press the "START" button to crank the engine. Release when the engine starts. 
8. Check that the indicator lights are off. If not, immediately stop the engine and investigate the indicated problem.
9. Allow the engine to warm up at low idle speed for several minutes before applying a load and/or switching to high idle. Allow a longer warm up time in cold weather.

**NOTE:** If the engine fails to start in 60 seconds or stops running the "ENGINE" switch must be switched to "OFF" and then switched back to "ON" before attempting to restart the engine. This resets the engine protection circuit.

## COLD WEATHER STARTING AND OPERATION.

The Kubota engine used in the Ranger 300 can be started in temperatures as low as 5°F (-15°C). At temperatures below 23°F (-5°C), it is recommended that No. 1D diesel fuel be used in place of No. 2D. Allow engine to warm up before applying a load or switching to HIGH idle.

## STOPPING THE ENGINE

1. Remove all welding and generator power loads and let the engine cool by running it for several minutes at low idle.
2. Stop the engine by placing the Engine Switch in the OFF position. This turns off the fuel solenoid. You can also stop the engine by turning off the fuel valve located on the fuel filter housing.

RANGER 300 D AND 300 DLX



## BREAK-IN PERIOD

Any engine will use a small amount of oil during its "break-in" period. For the diesel engine on the RANGER 300, break-in is about 50 running hours.

Check the oil every four hours during break-in. Change the oil after the first 50 hours of operation, every 100 hours thereafter. Change the oil filter at the second oil change.

### CAUTION

During break-in, subject the RANGER 300 to moderate loads. Avoid long periods running at idle. Before stopping the engine, remove all loads and allow the engine to cool several minutes.

**TABLE B.1**  
**TYPICAL RANGER 300 FUEL CONSUMPTION**

Low Idle - No Load 2000 RPM	.30 gallons/hour (1.0 liters/hour)
High Idle - No Load 3700 RPM	.60 gallons/hour (2.2 liters/hour)
AC CC Weld Output 300 Amps @ 25 Volts	1.1 gallons/hour (4.2 liters/hour)
DC CC Weld Output 300 Amps @ 25 Volts	1.2 gallons/hour (4.6 liters/hour)
DC CV Weld Output 300 Amps @ 28 Volts*	.90 gallons/hour (3.6 liters/hour)
Auxiliary Power, 12,000 kVA	1.3 gallons/hour (4.9 liters/hour)

\* DLX model only

## WELDING OPERATION

### WARNING

Do not attempt to use this equipment until you have thoroughly read the engine manufacturer's manual supplied with your welder. It includes important safety precautions, detailed engine starting, operating and maintenance instructions, and parts lists.



**ELECTRIC SHOCK** can kill.

- Do not touch electrically live parts or electrode with skin or wet clothing.
- Insulate yourself from work and ground
- Always wear dry insulating gloves.



**FUMES AND GASES** can be dangerous.

- Keep your head out of fumes.
- Use ventilation or exhaust to remove fumes from breathing zone.



**MOVING PARTS** can injure.

- Do not operate with doors open or guards off.
- Stop engine before servicing.
- Keep away from moving parts.



**WELDING SPARKS** can cause fire or explosion.

- Keep flammable material away.



**ARC RAYS** can burn.

- Wear eye, ear and body protection.

**See additional warning information throughout this operator's manual.**

The RANGER 300 machines can deliver from 45 to 300 amps of constant current for AC/DC stick welding. The Ranger 300 DLX can deliver 45 to 300 amps of constant voltage current for DC semiautomatic wire feed welding. The Ranger 300 D can deliver 45 to 200 amps of constant voltage current for DC semiautomatic wire feed welding. AC/DC constant current TIG welding is possible across the entire range from 45 to 300 amps although 250 amps is the maximum recommended for AC TIG welding of aluminum.

Output can be adjusted by setting the POLARITY SWITCH, the OUTPUT RANGE dial, and the FINE CONTROL dial on the output control panel to the settings that are best for your selected welding process.

## RANGER 300 D AND 300 DLX



## AC/DC STICK (CONSTANT CURRENT) WELDING

1. Remove the flange nuts from output terminals and place the work and electrode welding cables over the terminals. See Figure B.4. Replace and tighten the flange nuts securely. Be sure the connections are tight.
2. Select the appropriate electrode. See "Welding Tips 1" included with your RANGER 300.
3. Attach the work clamp securely to the work you are welding.
4. Insert the electrode into the electrode holder.
5. Set the IDLER CONTROL to AUTO and start the diesel engine.
6. Set the RANGE switch to a setting equal to or slightly lower than the welding current recommended for the electrode being used. For the best welding performance, always set the RANGE switch to the lowest CC-blue setting that will give the desired weld current. This will assure that the OUTPUT dial is set towards the high end of the dial. If the OUTPUT dial is set at 10 and the welding current is to low, move the RANGE switch to the next highest setting.
7. Set the POLARITY switch to the desired polarity (CC-blue setting).
8. Set the OUTPUT control. For stick welding, always use a setting between 5 and 10 on the dial (blue range).
9. Strike an arc and begin welding. The OUTPUT control can be adjusted while welding.

### **⚠ CAUTION**

DO NOT change the RANGE switch setting while welding. This can result in damage to the switch.

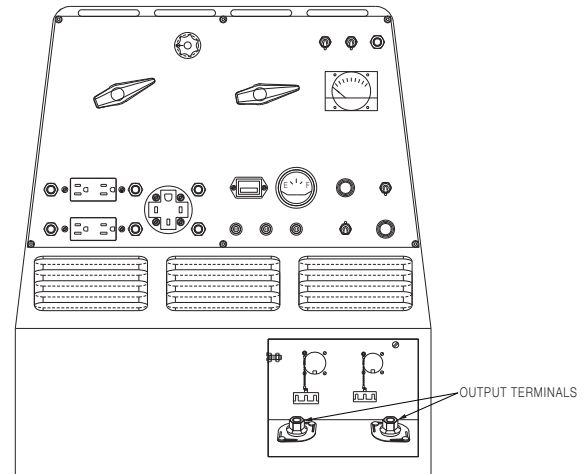

**FIGURE B.4  
WELDING CIRCUIT CONNECTIONS**

### AFTER YOU FINISH WELDING:

1. Stop the engine.
2. Allow the electrode and work to cool completely.
3. Remove the work clamp from the work.
4. Remove any remaining piece of electrode from the electrode holder.
5. If you are finished using the RANGER 300 for welding, disconnect the welding cables from the weld output terminals. Reattach the flange nuts and leave them on the terminals.

RANGE SETTING ON MACHINE	ACTUAL CURRENT RANGE
50	30 to 50 AMPS
75	50 to 75 AMPS
100	70 to 100 AMPS
140	95 to 140 AMPS
180	110 to 180 AMPS
225	130 to 225 AMPS
300	160 to 300 AMPS

RANGER 300 D AND 300 DLX



## AC/DC TIG (CONSTANT CURRENT) WELDING

1. Connect the K930-1 TIG Module to the RANGER 300. Follow the installation instructions provided with the kit.
2. Refer to the instruction manual with the TIG module (IM 528) for operation with a RANGER 300. And proper machine settings.
3. Set the RANGE switch to the appropriate setting for the electrode you are using. Refer to IM-528 with the TIG module or refer to Table B.2 for AC TIG welding.
4. Set the POLARITY SWITCH to the desired polarity.
5. Do not AC TIG weld on the 250 AC range setting. The output current may exceed the rating of the RANGER 300.
6. Start the arc and begin welding.

**NOTE:** When using the RANGER 300 for AC TIG welding of aluminum, the TIG Module is to be set for CONTINUOUS HF.

### AFTER YOU FINISH WELDING:

1. Stop the engine.
2. Allow the electrode and work to cool completely.
3. Remove the work clamp from the work.

**TABLE B.2**  
**AC TIG WELDING**  
**TIG ELECTRODE / RANGE SETTINGS**

Pure (EWP) Tungsten Diameter	"Range" Switch Settings	Appropriate Welding Current
1/8"	75, 100 or 140 <sup>(1)</sup>	100 - 200 amps
3/32"	50, 75 or 100	50 - 100 amps
1/16"	50, 75 or 100	45 - 150 amps
1% Thoriated Tungsten Diameter	"Range" Switch Settings	Appropriate Welding Current
1/8"	100, 140 or 180	160 - 250 amps
3/32"	50, 100 or 140	100 - 180 amps
1/16"	50 or 100	60 - 120 amps

(1) The welding current will be approximately 200 amps with the range switch set at 120 and the OUTPUT CONTROL set at 10. Do not use a range setting higher than 120 for AC TIG welding with a pure tungsten electrode.

## DC WIRE FEED WELDING (CV) WITH RANGER 300 DLX

1. Connect one of the following: the LN-25, LN-7 or LN-8 Wire Feeder.
2. Some recommended Innershield electrodes are: .068 NR-211MP, .068 NR-232, NR-203 series, 5/64 NR-311, and 5/64 NS-3M also Lincore® 33 and 55 hardfacing electrodes can be used. Cable length and other conditions can affect the ultimate results of this application. Request Lincoln publication N-675 for additional information.

Recommended Outershield electrodes are .045 (1.1 mm), .052 (1.3 mm), and 1/16 (1.6 mm) Outershield 71 and 1/16 (1.6 mm) Outershield 70. Request Lincoln publication GS-200 for additional information.

For MIG welding, the recommended electrodes are .030 (0.8 mm), .035 (0.9 mm) and .045 (1.1 mm) L-50 and L-56. You must use a blended shielding gas such as C25 (75% Argon, 25% CO<sub>2</sub>). Request Lincoln publication GS-100 for additional information.

3. Set the IDLER CONTROL to "AUTO" for the LN-25 "HIGH" for the LN-7 or LN-8 and start the diesel engine.
4. Set the RANGE switch to either HIGH, MEDIUM HIGH, MEDIUM LOW, or LOW (CV-red) depending on your wire size and speed.
5. Set the POLARITY SWITCH to either WIRE FEED DC+ or WIRE FEED DC (red), depending on the electrode.
6. Set the OUTPUT control to a setting between 1 and 10 that gives the most stable arc for the application. Try a higher RANGE switch setting if the arc is unstable.
7. Strike an arc and begin welding. The OUTPUT control can be adjusted while welding. **DO NOT** change the RANGE switch setting while welding. This can result in damage to the switch.

### AFTER YOU FINISH WELDING:

1. Stop the engine.
2. Allow the work to cool completely.
3. Remove the work clamp from the work.

RANGER 300 D AND 300 DLX





## DC WIRE FEED WELDING (CV) WITH RANGER 300D

1. Connect an LN-25 with internal contactor to the Ranger 300D.
2. The only Innershield electrode recommended for use with the Ranger 300D is NR211MP. The electrode sizes and welding ranges that can be used with the Ranger 300D are shown in the following table:

Electrode Diameter	Wire Speed in. / min.	Approximate Current Range
.035"	70 - 110	60 - 120 amps
.045"	70 - 130	120 - 170 amps
.068"	40 - 90	125 - 210 amps

The Ranger 300 D is recommended for limited "MIG" welding (GMAW - gas metal arc welding). The recommended electrodes are .030 and .035 L-50 and L-56. They must be used with a blended shielding gas such as C25 (75% Argon - 25% CO<sub>2</sub>). The .035 diameter electrode gives improved starting compared to .030 diameter. The welding ranges that can be used with the Ranger 300D are shown in the following table:

Electrode Diameter	Wire Speed in. / min.	Approximate Current Range
.030"	150 - 450	80 - 170 amps
.035"	100 - 350	80 - 190 amps

3. Set the IDLER control to AUTO.
4. Set the RANGER switch to the WIRE FEED (CV-red setting).
5. Set the POLARITY SWITCH to either WIRE FEED DC+ (red) or WIRE FEED DC- (red), depending on the electrode.
6. Set the OUTPUT control to a setting between 1 and 10 that gives the most stable arc for the application.
7. Strike an arc and begin welding. the OUTPUT control can be adjusted while welding. **DO NOT** change the RANGE switch setting while welding. This can result in damage to the switch.

### AFTER YOU FINISH WELDING:

1. Stop the engine
2. Allow the work to cool completely
3. Remove the work clamp from the work

## CARBON ARC GOUGING (CONSTANT CURRENT)

1. The recommended electrode is a 3/16" (4.8 mm) dia. carbon
2. Set the RANGE switch to 300
3. Set the POLARITY switch to DC+ (cc - blue setting)
4. Set the OUTPUT control to 10
5. Strike an arc and begin gouging

After you finish gouging:

1. Stop the engine
2. Allow the electrode and work to cool completely
3. Remove the work clamp from the work

## SUMMARY OF WELDING PROCESSES AND MACHINE SETTINGS

### TABLE B.3

### SUMMARY OF WELDING PROCESSES FOR RANGER 300 DLX

PROCESS	CONTROL CABLE & DIAGRAM	IDLE MODE	OUTPUT CONTROL SWITCH	WELDING TERMINALS SWITCH	ELECTRODE WHEN NOT WELDING	TO START WELDING
STICK - CC CARBON ARC GOUGING - CC	NO	AUTO	AT WELDER	ALWAYS ON	HOT	Touch electrode to work. Welding starts immediately and engine goes to high idle.
TIG - CC K930-1 TIG MODULE / K936-1 CONTROL CABLE	YES S23732-9	AUTO	REMOTE	REMOTE	COLD	Press Amptrol. Welding starts immediately.
WIRE FEED - CV, LN-25 WITH 42V REMOTE CON- TROL KIT	YES S23732-3	AUTO	REMOTE	REMOTE	COLD	Press gun trigger, Ranger 300 DLX contactor closes. Welding starts immediately and engine goes to high idle.
WIRE FEED - CV, LN-25 WITH INTERNAL CONTACTOR	NO S23732-1 S23732-2	AUTO	AT WELDER	ALWAYS ON	COLD	Press gun trigger, LN-25 contactor closes. Welding starts immediately and engine goes to high idle.
WIRE FEED - CV, LN-742	YES S23732-5	AUTO	REMOTE	REMOTE	COLD	Press gun trigger, Ranger 300 DLX contactor closes. Welding starts immediately and engine goes to high idle.
WIRE FEED - CV, LN-7 or LN-8	YES S23732-4 S23732-6	HIGH	REMOTE	REMOTE	COLD	Press gun trigger, Ranger 300 DLX contactor closes. Welding starts immediately.
K487-15 WIRE FEED- CV SPOOL GUN / K488 CONTROL MODULE	YES S23732-8	HIGH	AT WELDER	REMOTE	COLD	Press gun trigger, Ranger 300 DLX contactor closes. Welding starts immediately.

RANGER 300 D AND 300 DLX



## SUMMARY OF WELDING PROCESSES AND MACHINE SETTINGS

### TABLE B.4

### SUMMARY OF WELDING PROCESSES FOR RANGER 300 D

PROCESS	CONTROL CABLE & DIAGRAM	IDLE MODE	OUTPUT CONTROL SWITCH	ELECTRODE WHEN NOT WELDING	TO START WELDING
STICK - CC CARBON ARC GOUGING - CC	NO	AUTO	AT WELDER	HOT	Touch electrode to work. Welding starts immediately and engine goes to high idle.
TIG - CC K930-1 TIG MODULE / K936-1 CONTROL CABLE	YES S23732-10	AUTO	REMOTE	HOT	Press Amptrol. Welding starts immediately.
WIRE FEED - CV, LN-25 / INTERNAL CONTACTOR	NO S23732-1 S23732-2	AUTO	AT WELDER	COLD	Press gun trigger, LN-25 contactor closes. Electrode touches work, welding starts immediately and engine goes to high idle.
WIRE FEED - CV, LN-7 / K240 CONTACTOR KIT	YES S23732-11	HIGH	AT WELDER	COLD	Press gun trigger, K240 contactor closes. Welding starts immediately.

RANGER 300 D AND 300 DLX



## AUXILIARY POWER

The Ranger 300 can provide up to 12,000 watts of 120/240 volts AC, Single phase 60 HZ power for continuous use. The front of the machine includes three receptacles for connecting AC power Plugs, one 50 amp 120/240 volt NEMA 14-50R receptacle and two 15 amp 120 volt NEMA 5-15R receptacles. Do not connect any plugs that connect to the power receptacles in parallel.

Start the engine and set the "IDLER" control switch to the desired operating mode. Set the "CONTROL" to 10. Voltage is now correct at the receptacles for auxiliary power.

Most single phase motors through 2.0 HP can be started if there is no load on the motor or other load connected to the machine. Since the full load current of a 2.0 HP motor is typically 18 to 20 Amps when

operated at 120 V or 9 to 11 Amps when operated at 240 V, it should be connected to the 120/240 dual voltage receptacle. The full load current of a 1.5 HP motor is typically 15 to 17 Amps when operated at 120 V or 7.5 to 8.5 Amps when operated at 240 V, it also should be connected to the 120/240 dual voltage receptacle. a 1.0 HP that draws less than 15 Amps at 120 V can be plugged into one of the 120 V duplex receptacles.

## SIMULTANEOUS WELDING AND POWER LOADS

Auxiliary power ratings are with no welding load. Simultaneous welding and power loads are permitted by the following table. The permissible currents shown assume that current is being drawn from either the 120 volt or 240 volt supply (not both at the same time).

**RANGER 300 SIMULTANEOUS WELDING AND POWER LOADS  
(OUTPUT CONTROL SET AT 10)  
TABLE B.5**

Output Selector Setting	Welding Output Amps	Permissible Power Watts (Unity Power Factor)	Permissible Auxiliary Current in Amperes @ 120V	Permissible Auxiliary Current in Amperes @ 240V
300	300	NONE	0	0
225	225	3000	25	13
180	180	4800	40	20
140	140	6400	53	27
100	100	8000	60	33
75	75	9000	60	38
50	50	10,000	60	42
CV LOW (300 DLX)	200	4000	33	17
CV (300 D)	60	9600	60	40
CV MED. LOW (300 DLX)	225 80	3000 8800	25 60	13 27
CV MED. HIGH (300 DLX)	250 100	2000 8000	17 60	8 33
CV HIGH (300 DLX)	300 150	0 6000	0 50	0 25

**NOTE:** Voltage and permissible watts decrease as "CONTROL" is adjusted to settings less than 10. It is recommended that at settings less than 10, only incandescent lighting loads be connected to the auxiliary power receptacles.

RANGER 300 D AND 300 DLX



## 120/240 VOLT DUAL VOLTAGE RECEPTACLE

The 120/240 volt receptacle can supply up to 50 amps of 240 volt power to a two wire circuit, up to 50 amps of 120 volt power from each side of the three wire circuit, (up to 100 amps total). Do not connect the 115 volt circuits in parallel. Current sensing for the auto-

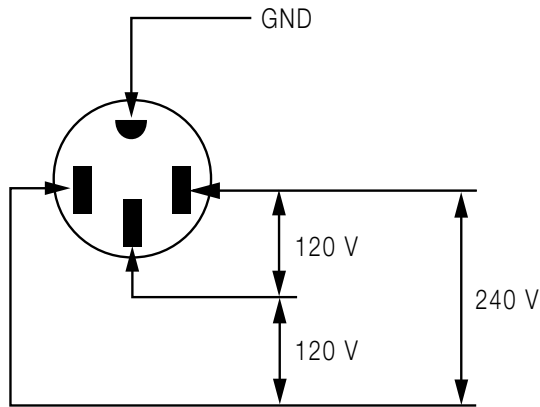

matic idle feature is in both legs of the three wire circuit as shown below.

**FIGURE B.5**

## 120V DUPLEX RECEPTACLES

The 120V auxiliary power receptacles should only be used with three wire grounding type plugs or approved double insulated tools with two wire plugs.

### Maximum Current Draw from 120V Duplex Receptacles - No Welding

240 V LOAD FROM FULL KVA RECEPTACLE	EACH HALF OF EACH 120V DUPLEX	TOTAL FROM ONE 120V DUPLEX	TOTAL FROM BOTH 120V DUPLEXES
0	15 AMPS	30 AMPS	60 AMPS
20 AMPS	15 AMPS	30 AMPS	60 AMPS
30 AMPS	15 AMPS	30 AMPS	40 AMPS
40 AMPS	15 AMPS	20 AMPS	20 AMPS
50 AMPS	0	0	0

### Maximum Current Draw from Optional 120V GFCI Duplex Receptacles - No Welding

240 V LOAD FROM FULL KVA RECEPTACLE	EACH HALF OF EACH 120V DUPLEX	TOTAL FROM ONE 120V DUPLEX	TOTAL FROM BOTH 120V DUPLEXES
0	15 AMPS	15 AMPS	30 AMPS
35 AMPS	15 AMPS	15 AMPS	30 AMPS
50 AMPS	0	0	0

## GENERAL OPTIONS / ACCESSORIES

The following options/accessories are available for your RANGER 300 from your local Lincoln Distributor.

**K953-1 Two-Wheeled Trailer** - For in-plant or yard towing of the RANGER 300. Suitable for road towing with optional Fender and Light Kit. Load capacity is 2,100 lbs.

**K802-R Power Plug Kit** - Provides four 15 amp, 115 volt plugs and one 50 amp, dual voltage (115/230V), full kVA plug.

**K703 Accessory Kit** - Includes the following:

- Thirty-five feet (10.5 meters) of #1/0 AWG electrode cable.
- Thirty feet (9.1 meters) of # 1/0 AWG work cable.
- Headshield with No. 12 filter.
- GC500 work clamp.
- Cooltong® 300 insulated electrode holder.

The cables are rated at 300 amps, 100 duty cycle.

**K903-1 Spark Arrester Kit** - A field-installed kit for the RANGER 300 engine muffler exhaust pipe (either engine option). Includes a heavy-gauge steel, approved spark arrester, mounting clamp and adapter.

**K857 Remote Control** - Includes a control box with 25 feet (7.5 meters) of 4 conductor cable. Allows output voltage to be controlled remotely.

**K896-1 GFCI Receptacle Kit** - Includes two UL approved 120 volt ground fault circuit interrupter receptacles (duplex type) with covers and installation instructions. Each receptacle is rated 15 amps, but the maximum total current from each GFCI duplex is limited to 20 amps. The GFCI receptacles replace the two factory installed 120 volt duplex receptacles.

## TIG WELDING OPTIONS / ACCESSORIES

**K930-1 TIG Module** - The TIG Module is an accessory that provides high frequency and shielding gas control for AC and DC GTAW (TIG) welding applications. It provides contactor control of constant current welding power sources having an internal contactor.

The TIG Module is supplied without accessories, Arc Start switches, Amptrols, cables, torches and mounting brackets must be purchased separately.

**K939-1 Docking Kit** - For mounting the K930-1 TIG Module on top of the Ranger 300.

**K936-1 Control Cable** - Control cable for 300 DLX for connecting the K930-1 TIG Module to a RANGER 300 DLX.

**K936-3 Control Cable** - Control cable for connecting K930-1 TIG module to a Ranger 300 D.

**K814 Arc Start Switch** - A remote start switch used in conjunction with the K930-1 TIG Module to energize the RANGER 300 DLX output terminals via the TIG module.

**K963 Hand Amptrol** - Remote output control on RANGER 300 D/DLX and contactor control on Ranger 300 DLX.

**K870 Foot Amptrol** - Remote output control on RANGER 300 D/DLX and contactor control on Ranger 300 DLX.

## SEMIAUTOMATIC FCAW AND MIG WELDING (RANGER 300 DLX) OPTIONS / ACCESSORIES

**LN-25 Wire Feeder** - This portable unit provides CC/CV for flux-cored arc welding (FCAW) and metal inert gas welding (MIG).

**LN-7 or LN-8 Wire Feeder** - Semiautomatic constant speed wire feeders.

**NOTE:** Gas-shielded welding requires a Magnum Gun. Gasless welding requires an Innershield Gun.

**K487-25 Magnum Spool Gun** - A lightweight, semi-automatic wire feeder for aluminum welding with argon gas. Has built-in remote wire speed control in the handle. Requires the K488 SG Control Module. Includes 50 feet (15.2 meters) of power cable.

**K488 SG Control Module** - Controls wire speed and gas flow. Provides the required control interface between the RANGER 300DLX and the K487-25 Magnum Spool Gun.

RANGER 300 D AND 300 DLX



## SEMI-AUTOMATIC FCAW AND MIG WELDING (RANGER 300 D) OPTIONS / ACCESSORIES

**LN-25 Wire Feeder** - The recommended wire feeder for use with the Ranger 300 D is the K449 LN-25. This portable unit provides CC/CV for flux-cored arc welding (FCAW) and metal inert gas welding (MIG). for remote control use either a K857 Remote Control Kit (25 ft.) or a K444-1 Remote Voltage Control Kit (25 ft.) which mounts inside the LN-25.

## ⚠ WARNING

Have qualified personnel do the maintenance work. Turn the engine off before working inside the machine. In some cases, it may be necessary to remove safety guards to perform required maintenance. Remove guards only when necessary and replace them when the maintenance requiring their removal is complete. Always use the greatest care when working near moving parts.

Do not put your hands near the engine cooling blower fan. If a problem cannot be corrected by following the instructions, take the machine to the nearest Lincoln Field Service Shop.



### ELECTRIC SHOCK can kill.

- Do not touch electrically live parts or electrode with skin or wet clothing.
- Insulate yourself from work and ground
- Always wear dry insulating gloves.



### ENGINE EXHAUST can kill.

- Use in open, well ventilated areas or vent exhaust outside.



### MOVING PARTS can injure.

- Do not operate with doors open or guards off.
- Stop engine before servicing.
- Keep away from moving parts.

See additional warning information throughout this operator's manual and the Engine manual as well.

## KUBOTA ENGINE MAINTENANCE SCHEDULE

TABLE D.1

FREQUENCY	MAINTENANCE REQUIRED
Daily or Before Starting Engine	<ul style="list-style-type: none"> <li>• Fill fuel tank.</li> <li>• Check oil level.</li> <li>• Check air cleaner for dirty, loose, or damaged parts.</li> <li>• Check air intake and cooling areas, clean as necessary.</li> </ul>
Every 50 Hours	<ul style="list-style-type: none"> <li>• Check fuel lines and clamps.</li> </ul>
Every 100 Hours	<ul style="list-style-type: none"> <li>• Clean air filter element. <sup>(1)</sup></li> <li>• Check battery electrolyte level.</li> <li>• Check fan belt tightness.</li> </ul>
Every 200 Hours	<ul style="list-style-type: none"> <li>• Change engine oil. <sup>(2)</sup></li> <li>• Replace oil filter cartridge. <sup>(2)</sup></li> <li>• Check radiator hoses.</li> </ul>
Every 400 Hours	<ul style="list-style-type: none"> <li>• Replace fuel filter element.</li> </ul>

(1) Replace air filter element after 600 hours of operation or sooner under dusty operating conditions.

(2) If the engine is operated under heavy load, in high ambient temperatures, or under dusty conditions, change the oil and oil filter every 100 hours.

Refer to your Kubota Operator's Manual for periodic maintenance at 500 hours and beyond.

## KUBOTA ENGINE MAINTENANCE COMPONENTS

TABLE D.2

ITEM	MAKE AND PART NUMBER
Oil Filter Element	Kubota 16271-32092 Fram PH 3593A
Air Cleaner Element	Donaldson P148970
Fuel Filter Element	Kubota 15231-43560 Fram C6921

RANGER 300 D AND 300 DLX





## ROUTINE AND PERIODIC ENGINE MAINTENANCE

### WARNING

To prevent the engine from accidentally starting, disconnect the negative battery cable before servicing the engine.

See Table D.1 for a summary of maintenance intervals for the items listed below. More frequent service may be required, depending on your specific application and operating conditions. See the Kubota Engine Operator's Manual for further information

### OIL

Check the oil level before starting engine or daily. **BE SURE TO MAINTAIN THE OIL LEVEL.** Change the oil for the first time after 50 hours of operation. Then, under normal operating conditions, change the oil as specified in the maintenance schedule.

### CHANGING THE OIL

Change the oil, while the engine is still warm, as follows:

1. Drain the oil from the drain plug located on the engine bottom, as shown in Figure D.1.
2. Replace the plug and tighten it securely.
3. Remove the oil fill cap and add oil until the level reaches the full mark on the dipstick. The quantity of oil required for an oil and oil filter change is 5.4 quarts (5.1 L). Use oil that is rated for diesel engine service (API classification CD/CE). Use SAE viscosity grades per the following table:

Ambient Temperature	Viscosity Grades
Above 25°C (77°F)	SAE 10W-30, SAE10W-40 or SAE30
0°C (32°F) to 25°C(77°F)	SAE 10W-30, SAE10W-40 or SAE20
Below 0°C (32°F)	SAE 10W-30, SAE10W-40 or SAE10

4. Reinstall the oil fill cap and the dipstick and start the engine. Run for several minutes and stop engine - Wait 5 minutes to allow the oil to come down to the oil pan and check oil level again.

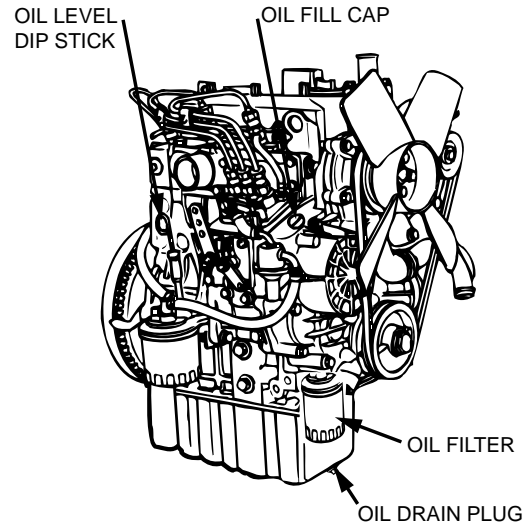

**FIGURE D.1**  
**OIL COMPONENT LOCATIONS**

### OIL FILTER

Change the oil filter the first time after 50 hours of operation. Then, under normal operating conditions, change the oil filter at every oil change.

Change the oil filter as follows:

1. Drain the oil from the engine and allow the oil filter to drain.
2. Remove the old filter (spin it off) and discard it. Wipe off the filter mounting surface and adapter.
3. Apply a thin coat of new oil to the rubber gasket on the new oil filter.
4. Spin the new filter on to the mounting adapter until the gasket just touches the mounting surface, then turn it down another 1/2 to 3/4 turn. Do not over-tighten the new filter.
5. Refill the engine with the proper amount and type of oil as described in the CHANGING THE OIL section. Start the engine and check for leaks around the filter element. Correct any leaks (usually by retightening the filter, but only enough to stop leaks) before placing the RANGER 300 back in service.
6. If there are no leaks, stop the engine and recheck the oil level. If necessary, add oil to bring the level up to the FULL mark, but do not overfill.

## FUEL

At the end of each day's use, refill the fuel tank  to minimize moisture condensation and dirt contamination in the fuel line. Do not overfill; leave room for the fuel to expand.

Use only fresh, No. 2 grade DIESEL fuel. Do not use kerosene.

See the Kubota Engine Operator's Manual for instructions on replacing the fuel filter.

## BLEEDING THE FUEL SYSTEM

You will need to bleed air from the fuel system any time the fuel filter or fuel lines have been detached and refitted; after the fuel tank has been run out of fuel; or before using the engine after long storage. Bleed the fuel system as follows:

### WARNING

To avoid personal injury, do not bleed a hot engine. This could cause fuel to spill onto a hot exhaust manifold, creating a danger of fire.

Refer to Figure D.2

1. Fill the fuel tank, Open the fuel cock.
2. Open the air vent plug on the fuel injection pump two turns using a 10mm wrench.
3. Move the fuel feed pump lever by hand until fuel flows out of the air vent plug.
4. Tighten the air vent plug.

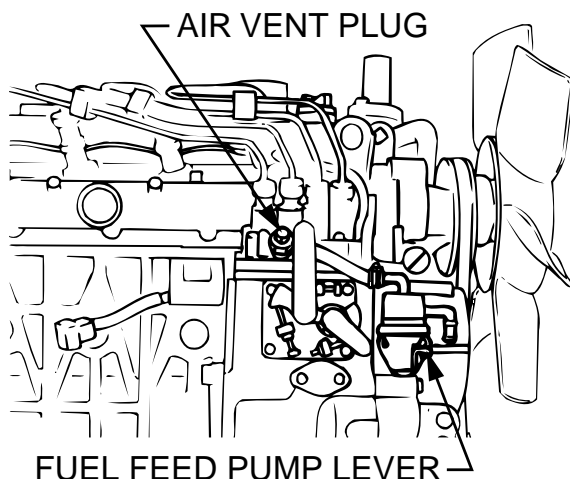

FIGURE D.2

FUEL BLEEDING COMPONENT LOCATIONS

## AIR CLEANER

The Kubota diesel engine is equipped with a dry type air filter. Never apply oil to it. Service the air cleaner as follows:

1. Remove the dust cup from the bottom of the air cleaner housing. Clean out any accumulated dust.
2. If dust is sticking to the element, blow compressed air through the element from the inside out. Turn the element as you apply air. Air pressure should be under 99 psi (68 newton/cm<sup>2</sup>). Replace the filter if there is carbon or oil on the element.
3. Replace the element at least every 600 hours of operation and sooner under dusty conditions.

## TIGHTENING THE FAN BELT

If the fan belt is loose, the engine can overheat and the battery lose its charge. Check tightness by pressing on the belt midway between the pulleys. It should deflect about .25 in. under a load of 20 lbs. (9 Kg) (6 mm).

## COOLING SYSTEM

### WARNING

HOT COOLANT can burn skin.



- Do not remove cap if radiator is hot.

Check the coolant level by observing the level in the plastic reserve overflow tank. Add 50/50 antifreeze / water solution if the level is close to or below the "LOW" mark. do not fill above the "FULL" mark. Remove radiator cap and add coolant to radiator if overflow tank is empty.

To drain the coolant, open the petcock at the bottom or the radiator. Open the radiator cap to allow complete drainage. (Tighten the petcock and refill with a 50/50 antifreeze/water solution.) Use an automotive grade (low silicate) ethylene glycol antifreeze. The cooling system capacity is 5.4 quarts (5.1L.). Replace and tighten the radiator cap.

## ⚠ CAUTION

Always premix the antifreeze and clean tap water before adding to the radiator or the overflow tank. It is very important that a precise 50/50 solution be used with this engine year round. This gives proper cooling during hot weather and freezing protection to -34° F (-37° C).

Cooling solution exceeding 50% ethylene glycol can result in engine overheating and damage to the engine. Coolant solution must be premixed before adding to radiator.

Periodically remove the dirt from the radiator fins.

Periodically check the fan belt and radiator hoses. Replace if signs of deterioration are found.

## BATTERY MAINTENANCE

### ⚠ WARNING



GASES FROM BATTERY can explode.

- Keep sparks, flame and cigarettes away from battery.

To prevent EXPLOSION when:

- **INSTALLING A NEW BATTERY** — disconnect negative cable from old battery first and connect to new battery last.
- **CONNECTING A BATTERY CHARGER** — remove battery from welder by disconnecting negative cable first, then positive cable and battery clamp. When reinstalling, connect negative cable last. Keep well ventilated.
- **USING A BOOSTER** — connect positive lead to battery first then connect negative lead to negative battery lead at engine foot.



BATTERY ACID can burn eyes and skin.

- Wear gloves and eye protection and be careful when working near battery.
- Follow instructions printed on battery.

To prevent **ELECTRICAL DAMAGE** when:

- Installing a battery.
- Using a booster.

Use correct polarity - Negative Ground.

To prevent **BATTERY DISCHARGE**, if you have an ignition switch, turn it off when engine is not running.

## CLEANING THE BATTERY

Keep the battery clean by wiping it with a damp cloth when dirty. If the terminals appear corroded, disconnect the battery cables and wash the terminals with an ammonia solution or a solution of 1/4 pound (0.1113 kg) of baking soda and 1 quart (0.946 l) of water. Be sure the battery vent plugs (if equipped) are tight so that none of the solution enters the cells.

After cleaning, flush the outside of the battery, the battery compartment, and surrounding areas with clear water. Coat the battery terminals lightly with petroleum jelly or a non-conductive grease to retard corrosion.

Keep the battery clean and dry. Moisture accumulation on the battery can lead to more rapid discharge and early battery failure.

## CHECKING ELECTROLYTE LEVEL

If battery cells are low, fill them to the neck of the filler hole with distilled water and recharge. If one cell is low, check for leaks.

The battery is a group 45, with a rating of 495 cold cranking amps.

## CHARGING THE BATTERY

When you charge, jump, replace, or otherwise connect battery cables to the battery, be sure the polarity is correct. Improper polarity can damage the charging circuit. The RANGER 300 positive (+) battery terminal has a red terminal cover.

If you need to charge the battery with an external charger, disconnect the negative cable first, then the positive cable before you attach the charger leads. After the battery is charged, reconnect the positive battery cable first and the negative cable last. Failure to do so can result in damage to the internal charger components.

Follow the instructions of the battery charger manufacturer for proper charger settings and charging time.

## WELDER / GENERATOR MAINTENANCE

### STORAGE

Store the RANGER 300 in clean, dry protected areas.

### CLEANING

Blow out the generator and controls periodically with low pressure air. Do this at least once a week in particularly dirty areas.

### OUTPUT RANGE SELECTOR AND POLARITY SWITCHES:

Switch contacts should not be greased. To keep contacts clean, rotate the switch through its entire range frequently. Good practice is to turn the handle from maximum to minimum setting twice each morning before starting to weld.

### BRUSH REMOVAL AND REPLACEMENT

It is normal for the brushes and slip rings to wear and darken slightly. Inspect the brushes when a generator overhaul is necessary.

### WARNING

Do not attempt to polish slip rings while the engine is running.

RANGER 300 D AND 300 DLX



## HOW TO USE TROUBLESHOOTING GUIDE

**⚠ WARNING**

Service and Repair should only be performed by Lincoln Electric Factory Trained Personnel. Unauthorized repairs performed on this equipment may result in danger to the technician and machine operator and will invalidate your factory warranty. For your safety and to avoid Electrical Shock, please observe all safety notes and precautions detailed throughout this manual.

This Troubleshooting Guide is provided to help you locate and repair possible machine malfunctions. Simply follow the three-step procedure listed below.

**Step 1. LOCATE PROBLEM (SYMPTOM).**

Look under the column labeled "PROBLEM (SYMPTOMS)". This column describes possible symptoms that the machine may exhibit. Find the listing that best describes the symptom that the machine is exhibiting.

**Step 2. POSSIBLE CAUSE.**

The second column labeled "POSSIBLE CAUSE" lists the obvious external possibilities that may contribute to the machine symptom.

**Step 3. RECOMMENDED COURSE OF ACTION**

This column provides a course of action for the Possible Cause, generally it states to contact your local Lincoln Authorized Field Service Facility.

If you do not understand or are unable to perform the Recommended Course of Action safely, contact your local Lincoln Authorized Field Service Facility.

**⚠ WARNING**

ELECTRIC SHOCK can kill.

- Do not touch electrically live parts such as output terminals or internal wiring.



ENGINE EXHAUST can kill.

- Use in open, well ventilated areas or vent exhaust outside.



MOVING PARTS can injure.

- Do not operate with doors open or guards off.
- Stop engine before servicing.
- Keep away from moving parts.
- Remove guards only when necessary and replace when work requiring removal is complete.
- Only qualified personnel should install, use or service this equipment.

**⚠ CAUTION**

If for any reason you do not understand the test procedures or are unable to perform the tests/repairs safely, contact your Local Lincoln Authorized Field Service Facility for technical troubleshooting assistance before you proceed.

RANGER 300 D AND 300 DLX



Observe all Safety Guidelines detailed throughout this manual

PROBLEMS (SYMPTOMS)	POSSIBLE AREAS OF MISADJUSTMENTS(S)	RECOMMENDED COURSE OF ACTION
Major Physical or Electrical Damage is Evident.		1. Contact your Local Lincoln Authorized Field Service Facility.
Engine will not "crank".	<ol style="list-style-type: none"> <li>1. Battery is low.</li> <li>2. Loose battery cable connections.</li> <li>3. Faulty engine starter motor.</li> </ol>	<ol style="list-style-type: none"> <li>1. Charge Battery.</li> <li>2. Inspect, clean and tighten.</li> <li>3. Contact authorized Kubota Service Shop.</li> </ol>
Engine will "crank" but not start.	<ol style="list-style-type: none"> <li>1. Fuel shut off valve is in off position.</li> <li>2. Out of fuel.</li> <li>3. Engine switch in "OFF" position.</li> <li>4. High coolant temperature (Indicator light lit).</li> <li>5. Faulty fuel solenoid or faulty PC board.</li> </ol>	<ol style="list-style-type: none"> <li>1. Move lever on fuel filter housing to "ON" (vertical) position.</li> <li>2. Fill tank and bleed fuel system. See MAINTENANCE section</li> <li>3. Set switch to "ON" position.</li> <li>4. Check engine cooling system.</li> <li>5. Contact your Local Lincoln Authorized Field Service Facility for technical troubleshooting assistance.</li> </ol>
Engine shuts down shortly after starting.	<ol style="list-style-type: none"> <li>1. Low oil level. Oil pressure indicator light will flash while engine is running.</li> <li>2. Circuit breaker CB9 located in engine compartment is open. Oil pressure and charging indicator lights will not be on when engine switch is ON and engine is not running if CB9 is tripped.</li> </ol>	<ol style="list-style-type: none"> <li>1. Change oil and oil filter and fill to proper level. Start engine and look for leaks.</li> <li>2. Reset CB9. If it continues to trip, contact your Local Lincoln Authorized Field Service Facility for technical troubleshooting assistance.</li> </ol>
Engine shuts down while under load.	<ol style="list-style-type: none"> <li>1. High coolant temperature (Indicator light lit).</li> </ol>	<ol style="list-style-type: none"> <li>1. Reduce load if it is exceeding machine rating. Add coolant to system if low. Clean fins on radiator if dirty. Tighten fan belt if loose.</li> </ol>
Battery does not stay charged.	<ol style="list-style-type: none"> <li>1. Faulty battery.</li> <li>2. Loose connections at battery or alternator.</li> <li>3. Loose fan belt.</li> <li>4. Faulty engine alternator.</li> </ol>	<ol style="list-style-type: none"> <li>1. Replace</li> <li>2. Clean and tighten connections.</li> <li>3. Tighten. See Maintenance Section.</li> <li>4. Consult authorized Kubota Service Shop.</li> </ol>

 **CAUTION**

If for any reason you do not understand the test procedures or are unable to perform the tests/repairs safely, contact your Local Lincoln Authorized Field Service Facility for technical troubleshooting assistance before you proceed.

RANGER 300 D AND 300 DLX



Observe all Safety Guidelines detailed throughout this manual

PROBLEMS (SYMPTOMS)	POSSIBLE AREAS OF MISADJUSTMENTS(S)	RECOMMENDED COURSE OF ACTION
Engine will not idle down to low speed.	<ol style="list-style-type: none"> <li>1. Idler switch in High idle position.</li> <li>2. External load on welder or auxiliary power.</li> <li>3. Faulty wiring or PC board.</li> </ol>	<ol style="list-style-type: none"> <li>1. Set switch to Auto.</li> <li>2. Remove all external loads.</li> <li>3. Contact your Local Lincoln Authorized Field Service Facility for technical troubleshooting assistance.</li> </ol>
Engine will not go to high idle when attempting to weld.	<ol style="list-style-type: none"> <li>1. Poor work lead connection to work.</li> <li>2. "Welding Terminals" switch is in wrong position.</li> <li>3. Faulty high speed solenoid or faulty PC board.</li> </ol>	<ol style="list-style-type: none"> <li>1. Make sure work clamp is tightly connected to clean base metal.</li> <li>2. Set to "Always On" when welding without a welding terminal control cable. Refer to Operations chapter for proper use of this switch.</li> <li>3. Contact your Local Lincoln Authorized Field Service Facility for technical troubleshooting assistance.</li> </ol>
Engine will not go to high idle when using auxiliary power.	<ol style="list-style-type: none"> <li>1. Auxiliary power load is less than 100 watts.</li> <li>2. Faulty high speed solenoid or faulty PC board.</li> </ol>	<ol style="list-style-type: none"> <li>1. Idler may not respond with less than a 100 watt load. Set idler to "High".</li> <li>2. Contact your Local Lincoln Authorized Field Service Facility for technical troubleshooting assistance.</li> </ol>
Engine will not go to high idle and circuit breaker CB8 located in engine compartment is open.	<ol style="list-style-type: none"> <li>1. Faulty high speed solenoid</li> </ol>	<ol style="list-style-type: none"> <li>1. Reset CB8. If it continues to trip, contact your Local Lincoln Authorized Field Service Facility for technical troubleshooting assistance.</li> </ol>

 **CAUTION**

If for any reason you do not understand the test procedures or are unable to perform the tests/repairs safely, contact your Local Lincoln Authorized Field Service Facility for technical troubleshooting assistance before you proceed.

RANGER 300 D AND 300 DLX



Observe all Safety Guidelines detailed throughout this manual

PROBLEMS (SYMPTOMS)	POSSIBLE AREAS OF MISADJUSTMENTS(S)	RECOMMENDED COURSE OF ACTION
No welding power output.	<ol style="list-style-type: none"> <li>"Welding Terminals" switch in wrong position.</li> <li>Faulty welding alternator or faulty PC board.</li> </ol>	<ol style="list-style-type: none"> <li>Place switch in "Always On" position when welding without welding terminal control cable. Refer to Operation chapter for proper switch function.</li> <li>Contact your Local Lincoln Authorized Field Service Facility for technical troubleshooting assistance.</li> </ol>
Welder has output but no control.	<ol style="list-style-type: none"> <li>"Control" switch is in wrong position.</li> <li>Poor remote kit connection.</li> <li>Faulty remote kit.</li> <li>Faulty control potentiometer or faulty PC board.</li> </ol>	<ol style="list-style-type: none"> <li>Place switch in "Control at Welder" position to control output at welder. Place switch in "Remote" position to control output remotely. Refer to Operation chapter for proper switch function.</li> <li>Check connections.</li> <li>Replace if necessary.</li> <li>Contact your Local Lincoln Authorized Field Service Facility for technical troubleshooting assistance.</li> </ol>
No auxiliary power.	<ol style="list-style-type: none"> <li>Open circuit breakers.</li> <li>Faulty connections to auxiliary receptacles.</li> <li>GFCI tripped.</li> <li>Faulty welding alternator or faulty PC board.</li> </ol>	<ol style="list-style-type: none"> <li>Reset breakers. If breakers keep tripping, reduce power draw.</li> <li>Check connections.</li> <li>Clear any ground fault and reset GFCI circuit by pressing "Reset" button on the 120 V receptacle.</li> <li>Contact your Local Lincoln Authorized Field Service Facility for technical troubleshooting assistance.</li> </ol>
Wire feeder does not work when connected to welder 14 pin amphe-nol (DLX models only).	<ol style="list-style-type: none"> <li>Wire Feeder Power circuit breaker open.</li> <li>Faulty wiring in control cable</li> <li>Faulty wire feeder.</li> </ol>	<ol style="list-style-type: none"> <li>Reset</li> <li>Repair or replace cable</li> <li>Replace with known good one.</li> </ol>

 **CAUTION**

If for any reason you do not understand the test procedures or are unable to perform the tests/repairs safely, contact your Local Lincoln Authorized Field Service Facility for technical troubleshooting assistance before you proceed.

RANGER 300 D AND 300 DLX





RANGER 300 D & RANGER 300 DLX / LN-25 ACROSS THE ARC CONNECTION DIAGRAM WITH OPTIONAL K857 REMOTE CONTROL

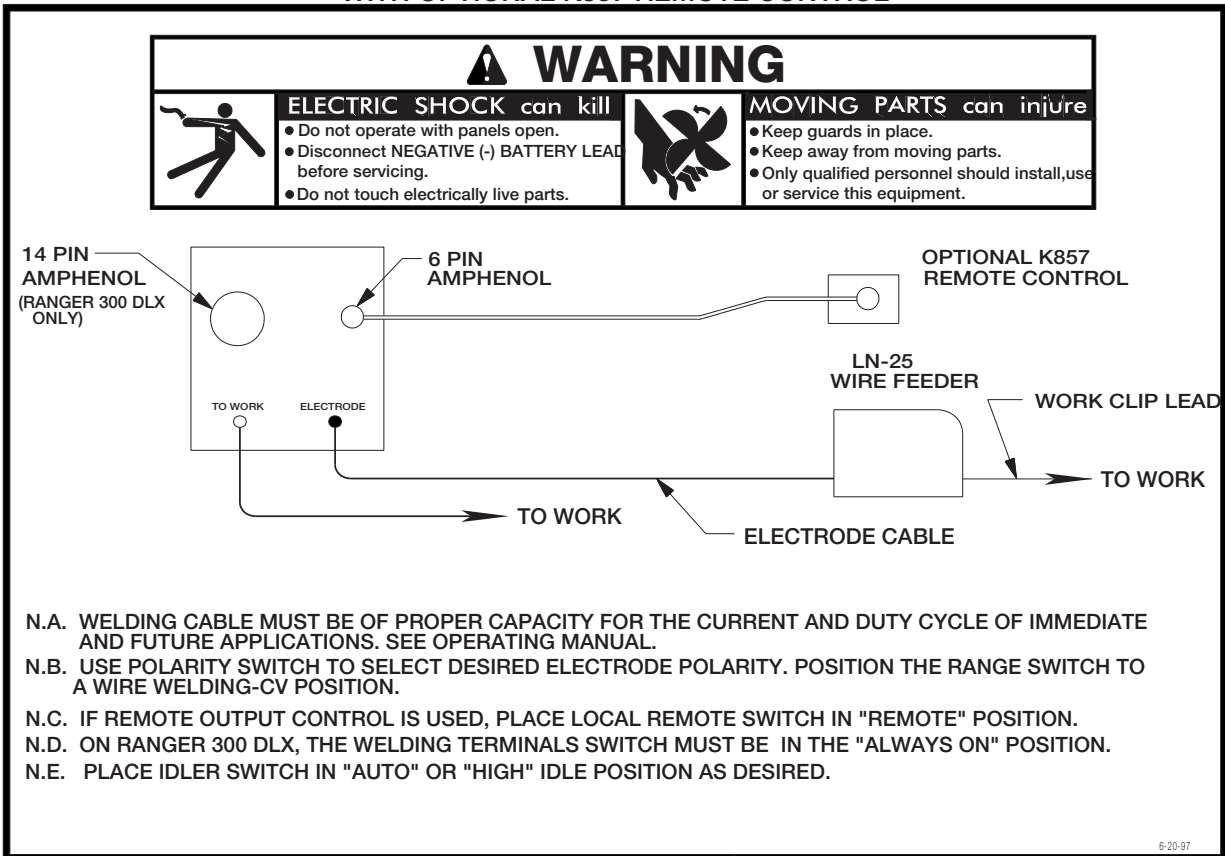

RANGER 300 D & RANGER 300 DLX / LN-25 ACROSS THE ARC CONNECTION DIAGRAM WITH OPTIONAL K444-1 REMOTE CONTROL

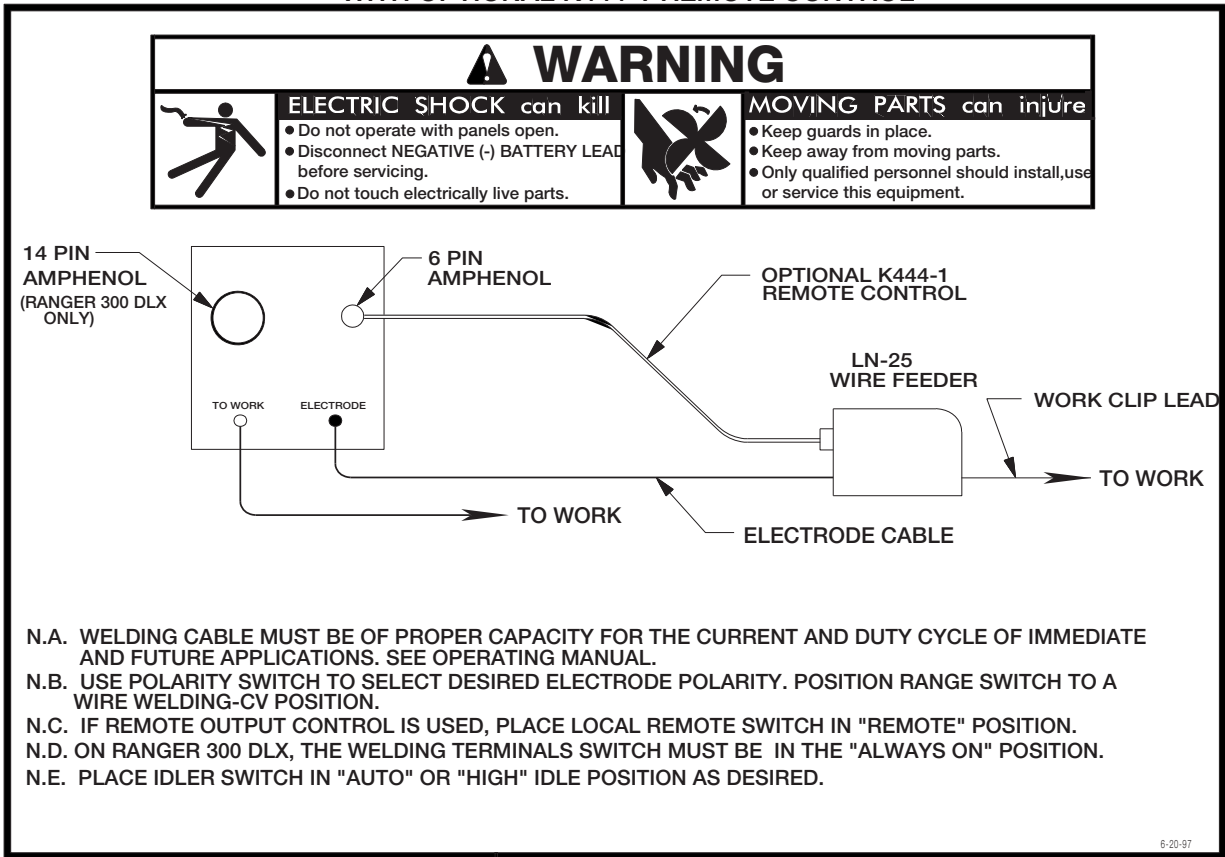

RANGER 300 D AND 300 DLX



**RANGER 300 DLX / LN-25 WITH K624-1 42 VOLT REMOTE OUTPUT CONTROL MODULE CONNECTION DIAGRAM**

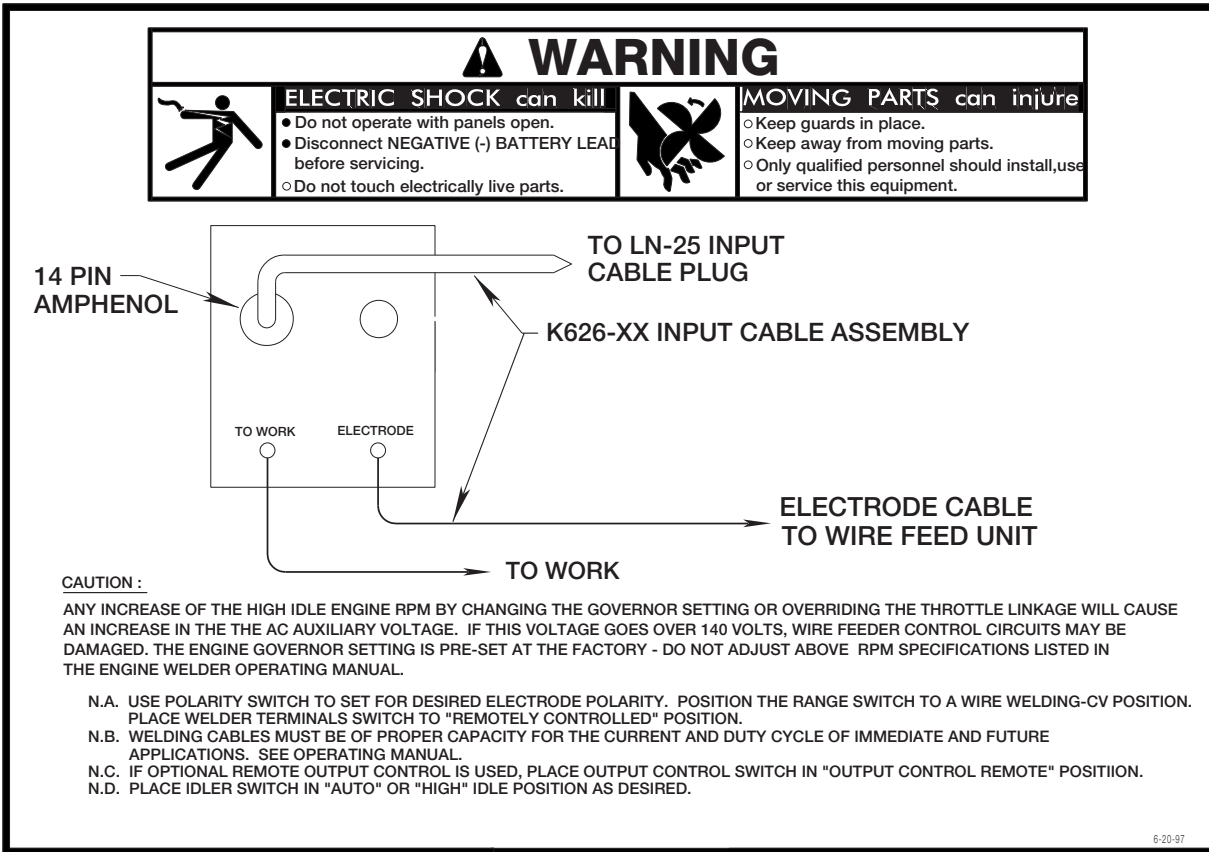

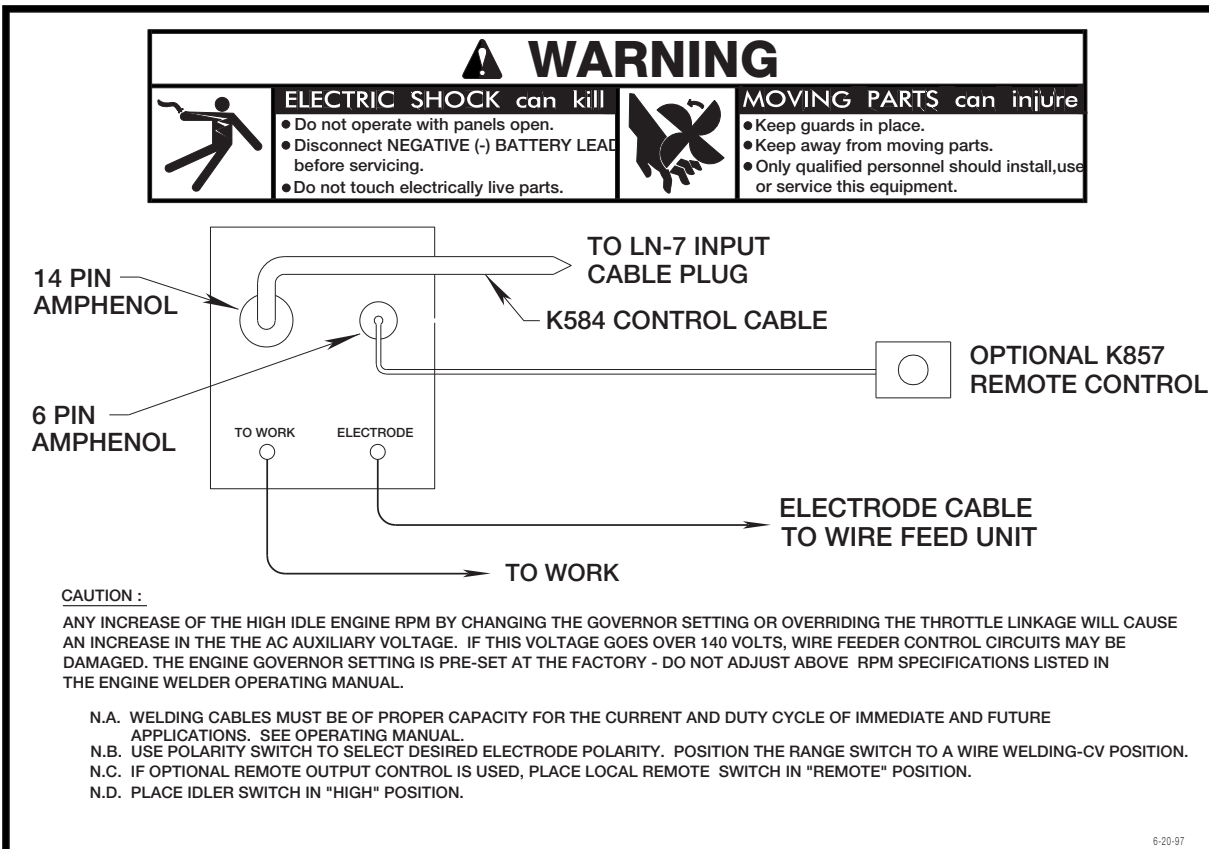

**RANGER 300 DLX / LN-7 CONNECTION DIAGRAM**



RANGER 300 D AND 300 DLX



**RANGER 300 DLX / LN-742 CONNECTION DIAGRAM**

<b>⚠ WARNING</b>		
	<b>ELECTRIC SHOCK can kill</b> <ul style="list-style-type: none"> <li>• Do not operate with panels open.</li> <li>• Disconnect NEGATIVE (-) BATTERY LEAD before servicing.</li> <li>• Do not touch electrically live parts.</li> </ul>	
<b>MOVING PARTS can injure</b> <ul style="list-style-type: none"> <li>• Keep guards in place.</li> <li>• Keep away from moving parts.</li> <li>• Only qualified personnel should install, use or service this equipment.</li> </ul>		

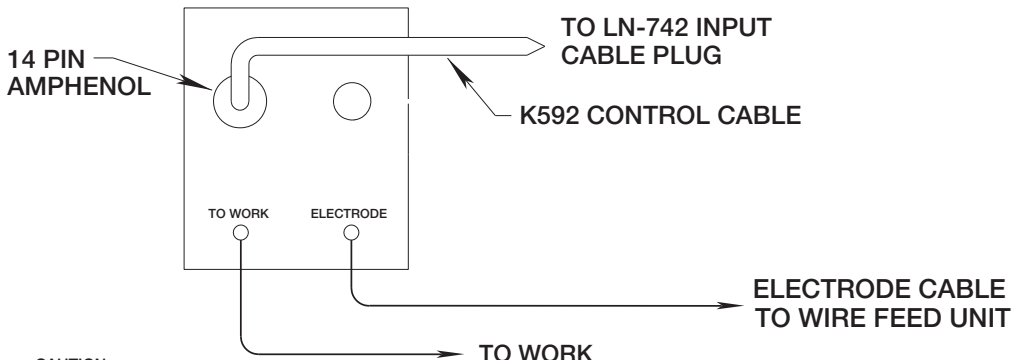

  

**CAUTION :**  
 ANY INCREASE OF THE HIGH IDLE ENGINE RPM BY CHANGING THE GOVERNOR SETTING OR OVERRIDING THE THROTTLE LINKAGE WILL CAUSE AN INCREASE IN THE THE AC AUXILIARY VOLTAGE. IF THIS VOLTAGE GOES OVER 140 VOLTS, WIRE FEEDER CONTROL CIRCUITS MAY BE DAMAGED. THE ENGINE GOVERNOR SETTING IS PRE-SET AT THE FACTORY - DO NOT ADJUST ABOVE RPM SPECIFICATIONS LISTED IN THE ENGINE WELDER OPERATING MANUAL.

N.A. WELDING CABLES MUST BE OF PROPER CAPACITY FOR THE CURRENT AND DUTY CYCLE OF IMMEDIATE AND FUTURE APPLICATIONS. SEE OPERATING MANUAL.  
 N.B. USE POLARITY SWITCH TO SET FOR DESIRED ELECTRODE POLARITY. POSITION THE RANGE SWITCH TO A WIRE WELDING-CV POSITION.  
 N.C. PLACE WELDER TERMINALS SWITCH TO "REMOTELY CONTROLLED" POSITION.  
 N.D. IF OPTIONAL REMOTE OUTPUT CONTROL IS USED, PLACE OUTPUT CONTROL SWITCH IN "OUTPUT CONTROL REMOTE" POSITION.  
 N.E. PLACE IDLER SWITCH IN "AUTO" OR "HIGH" IDLE POSITION AS DESIRED.

6-20-97  
523732-5

**RANGER 300 DLX / LN-8 CONNECTION DIAGRAM**

<b>⚠ WARNING</b>		
	<b>ELECTRIC SHOCK can kill</b> <ul style="list-style-type: none"> <li>• Do not operate with panels open.</li> <li>• Disconnect NEGATIVE (-) BATTERY LEAD before servicing.</li> <li>• Do not touch electrically live parts.</li> </ul>	
<b>MOVING PARTS can injure</b> <ul style="list-style-type: none"> <li>• Keep guards in place.</li> <li>• Keep away from moving parts.</li> <li>• Only qualified personnel should install, use or service this equipment.</li> </ul>		

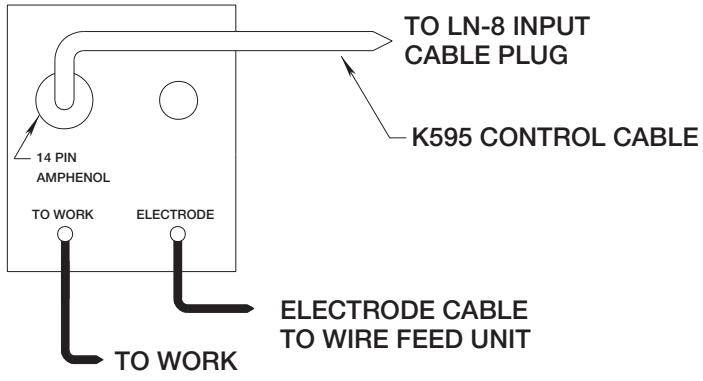
**CAUTION :**  
 ANY INCREASE OF THE HIGH IDLE ENGINE RPM BY CHANGING THE GOVERNOR SETTING OR OVERRIDING THE THROTTLE LINKAGE WILL CAUSE AN INCREASE IN THE THE AC AUXILIARY VOLTAGE. IF THIS VOLTAGE GOES OVER 140 VOLTS, WIRE FEEDER CONTROL CIRCUITS MAY BE DAMAGED. THE ENGINE GOVERNOR SETTING IS PRE-SET AT THE FACTORY - DO NOT ADJUST ABOVE RPM SPECIFICATIONS LISTED IN THE ENGINE WELDER OPERATING MANUAL.

N.A. WELDING CABLES MUST BE OF PROPER CAPACITY FOR THE CURRENT AND DUTY CYCLE OF IMMEDIATE AND FUTURE APPLICATIONS. SEE OPERATING MANUAL.  
 N.B. USE POLARITY SWITCH TO SELECT DESIRED ELECTRODE POLARITY. POSITION THE RANGE SWITCH TO A WIRE WELDING-CV POSITION. PLACE LOCAL / REMOTE SWITCH IN "REMOTE" POSITION.  
 N.C. PLACE IDLER SWITCH IN "HIGH" POSITION.

6-20-97  
523732-6

RANGER 300 D AND 300 DLX



**RANGER 300 DLX TO K867 CONTROL CABLE ADAPTER CONNECTION DIAGRAM**

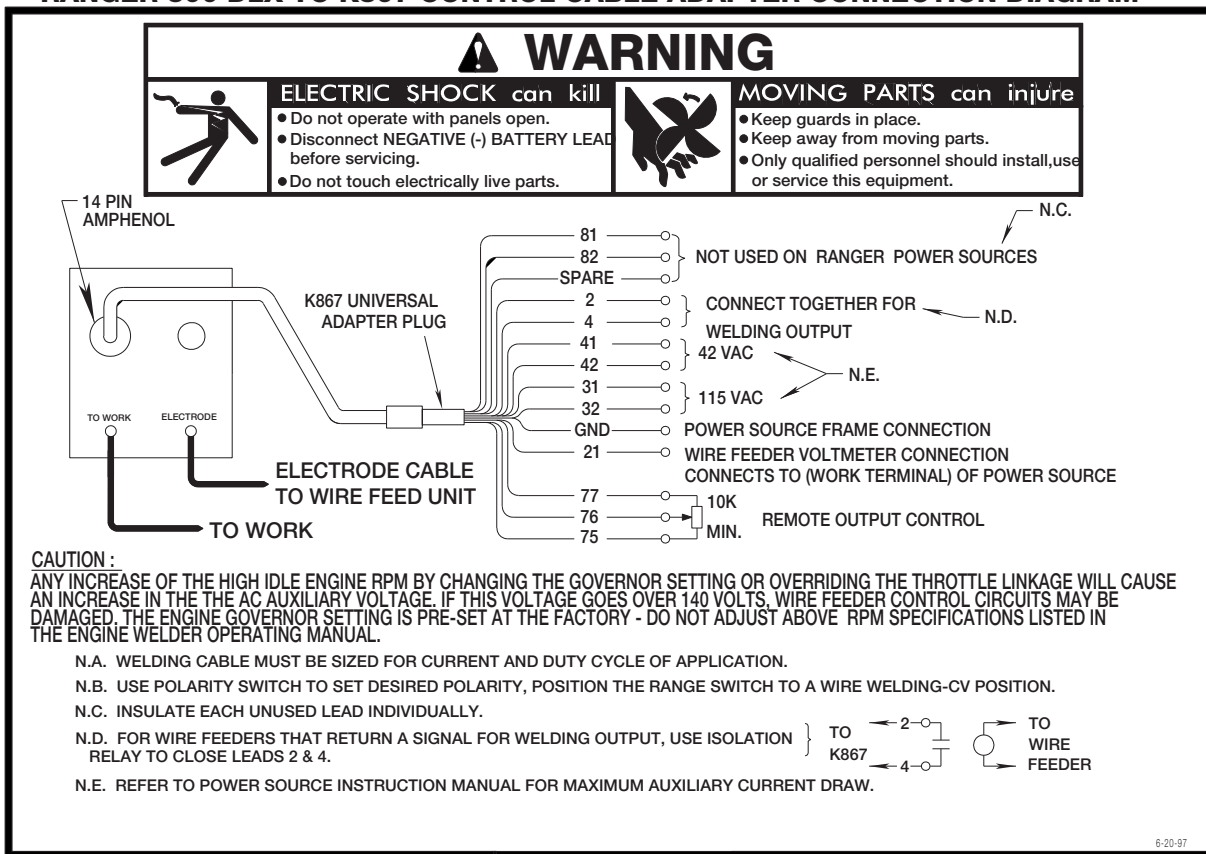

**RANGER 300 DLX / K691-10 / K488 / K487 SPOOL GUN CONNECTION DIAGRAM**

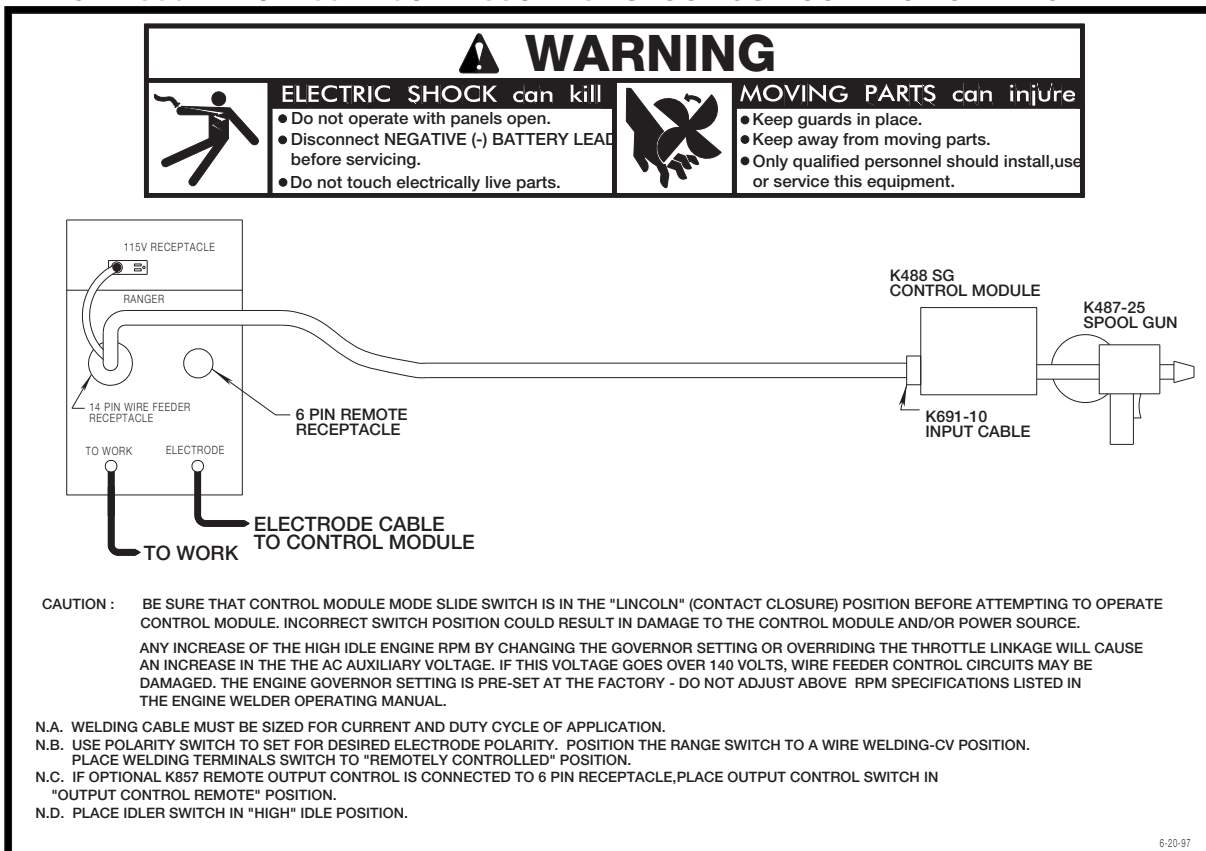

RANGER 300 D AND 300 DLX



**RANGER 300 DLX / K930-1 TIG MODULE / CONNECTION DIAGRAM**

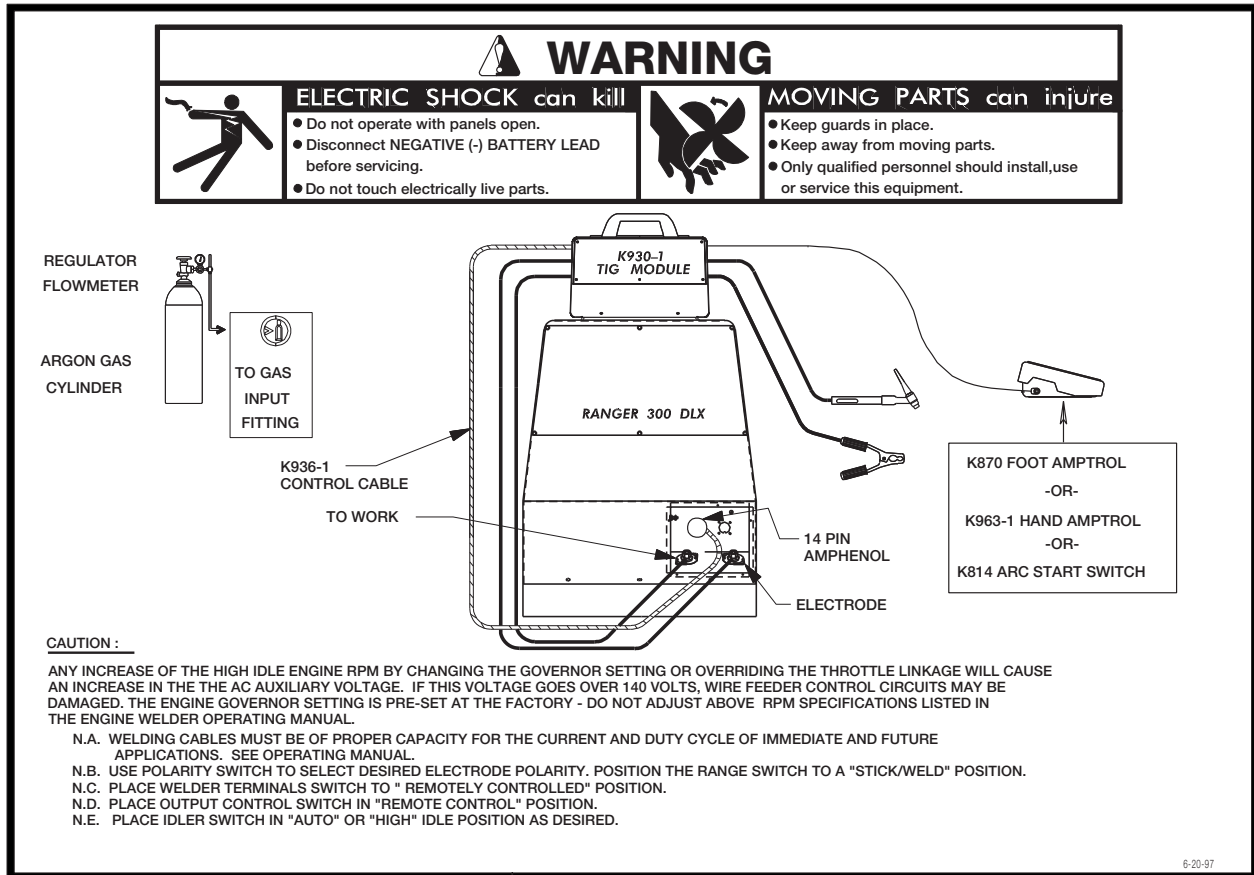

**RANGER 300 D / K930-1 TIG MODULE WITH K938-1 CONTACTOR KIT / CONNECTION DIAGRAM**

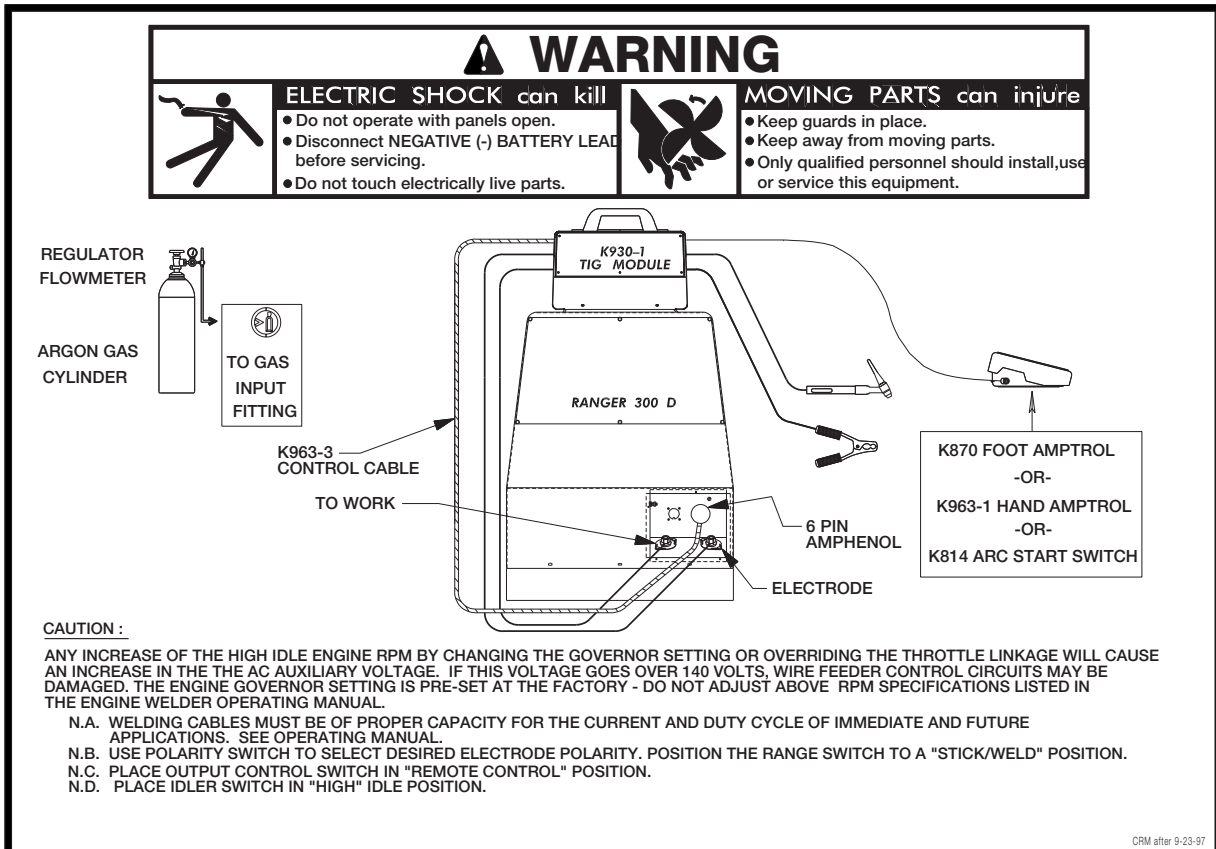

RANGER 300 D AND 300 DLX



## RANGER 300 D / LN-7 / K240 CONTACTOR KIT

<b>⚠ WARNING</b>		
	<b>ELECTRIC SHOCK can kill</b>	
	<ul style="list-style-type: none"> <li>• Do not operate with panels open.</li> <li>• Disconnect NEGATIVE (-) BATTERY LEAD before servicing.</li> <li>• Do not touch electrically live parts.</li> </ul>	
		<b>MOVING PARTS can injure</b>
		<ul style="list-style-type: none"> <li>• Keep guards in place.</li> <li>• Keep away from moving parts.</li> <li>• Only qualified personnel should install, use or service this equipment.</li> </ul>

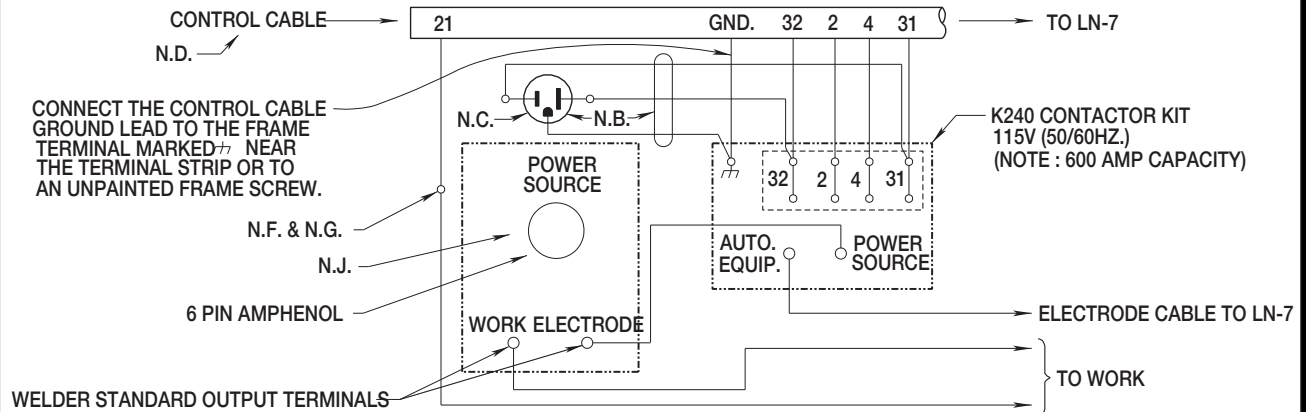

- N.A. USE POWER SOURCE POLARITY SWITCH TO SET FOR DESIRED ELECTRODE POLARITY. POSITION THE OUTPUT SELECTOR SWITCH ON THE POWER SOURCE TO THE CV POSITION.
- N.B. 3 CONDUCTOR #16 POWER CORD PHYSICALLY SUITABLE FOR THE INSTALLATION AND PLUG RATED AT 115 VOLTS 15 AMPERES AC.
- N.C. PLUG INTO 115 VOLT AC RECEPTACLE ON WELDER CONTROL PANEL OR OTHER 115 VOLT AC SUPPLY RATED AT A MINIMUM OF 500 VOLT AMPERES.
- N.D. LEADS #21 AND GND. DO NOT APPEAR ON LN-7'S WITH CODES BELOW 7026.
- N.E. WELDING CABLES MUST BE OF PROPER CAPACITY FOR THE CURRENT AND DUTY CYCLE OF IMMEDIATE AND FUTURE APPLICATIONS. (SEE OPERATOR'S MANUAL.)
- N.F. IF LN-7 IS EQUIPPED WITH A METER KIT, EXTEND LEAD #21 USING #14 OR LARGER INSULATED WIRE PHYSICALLY SUITABLE FOR THE INSTALLATION. AN S16586-"LENGTH" REMOTE VOLTAGE SENSING WORK LEAD MAY BE ORDERED FOR THIS PURPOSE. CONNECT IT DIRECTLY TO THE WORK PIECE INDEPENDENT OF THE WELDING WORK CABLE. FOR CONVENIENCE, THIS EXTENDED #21 LEAD SHOULD BE TAPED TO THE WELDING WORK LEAD.
- N.G. TAPE UP BOLTED CONNECTION WHERE LEAD #21 IS EXTENDED.
- N.H. IDLER SWITCH ON POWER SOURCE MUST BE IN HIGH IDLE POSITION.
- N.J. IF AN OPTIONAL K857 REMOTE OUTPUT CONTROL IS USED, CONNECT IT TO THE RANGER 300 D AMPHENOL CONNECTOR.  
NOTE: PLACE OUTPUT CONTROL SWITCH IN "OUTPUT CONTROL REMOTE" POSITION WHEN REMOTE OUTPUT CONTROL IS USED.

**CAUTION:** ANY SPEED UP OF THE ENGINE RPM BY CHANGING THE GOVERNOR SETTING OR OVERRIDING THE THROTTLE LINKAGE WILL CAUSE AN INCREASE IN THE AC AUXILIARY VOLTAGE. IF THIS VOLTAGE GOES ABOVE 140 VOLTS, THE LN-7 CONTROL CIRCUIT WILL BE DAMAGED. THE ENGINE GOVERNOR SETTING IS PRE-SET AT THE FACTORY - DO NOT ADJUST ABOVE RPM SPECIFICATIONS LISTED IN ENGINE WELDER OPERATING MANUAL.

6-20-97

S23732-11

RANGER 300 D AND 300 DLX



WIRING DIAGRAM - RANGER 300 DLX

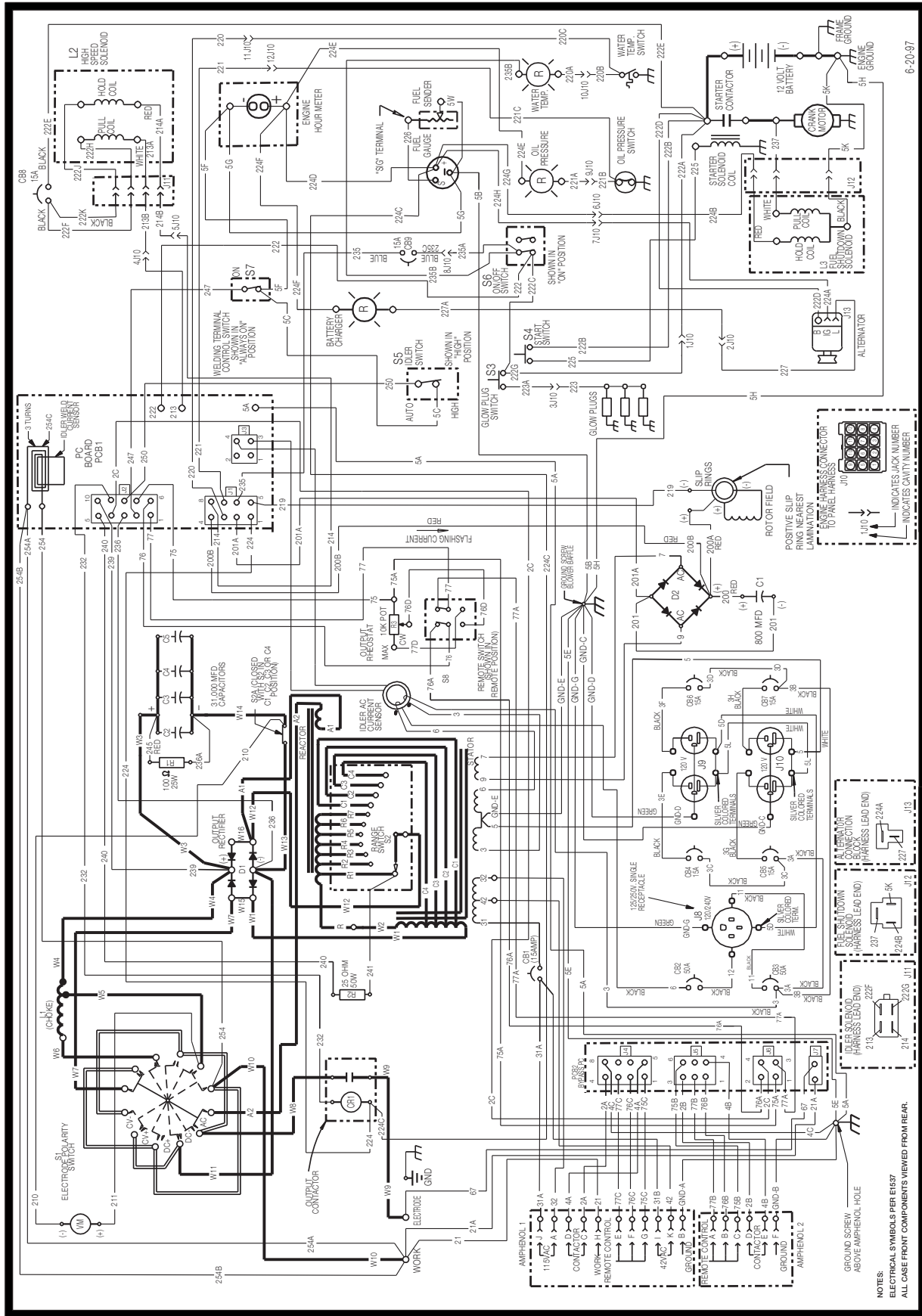

**NOTE:** This diagram is for reference only. It may not be accurate for all machines covered by this manual. The specific diagram for a particular code is pasted inside the machine on one of the enclosure panels. If the diagram is illegible, write to the Service Department for a replacement. Give the equipment code number.

RANGER 300 D AND 300 DLX



WIRING DIAGRAM - RANGER 300 D

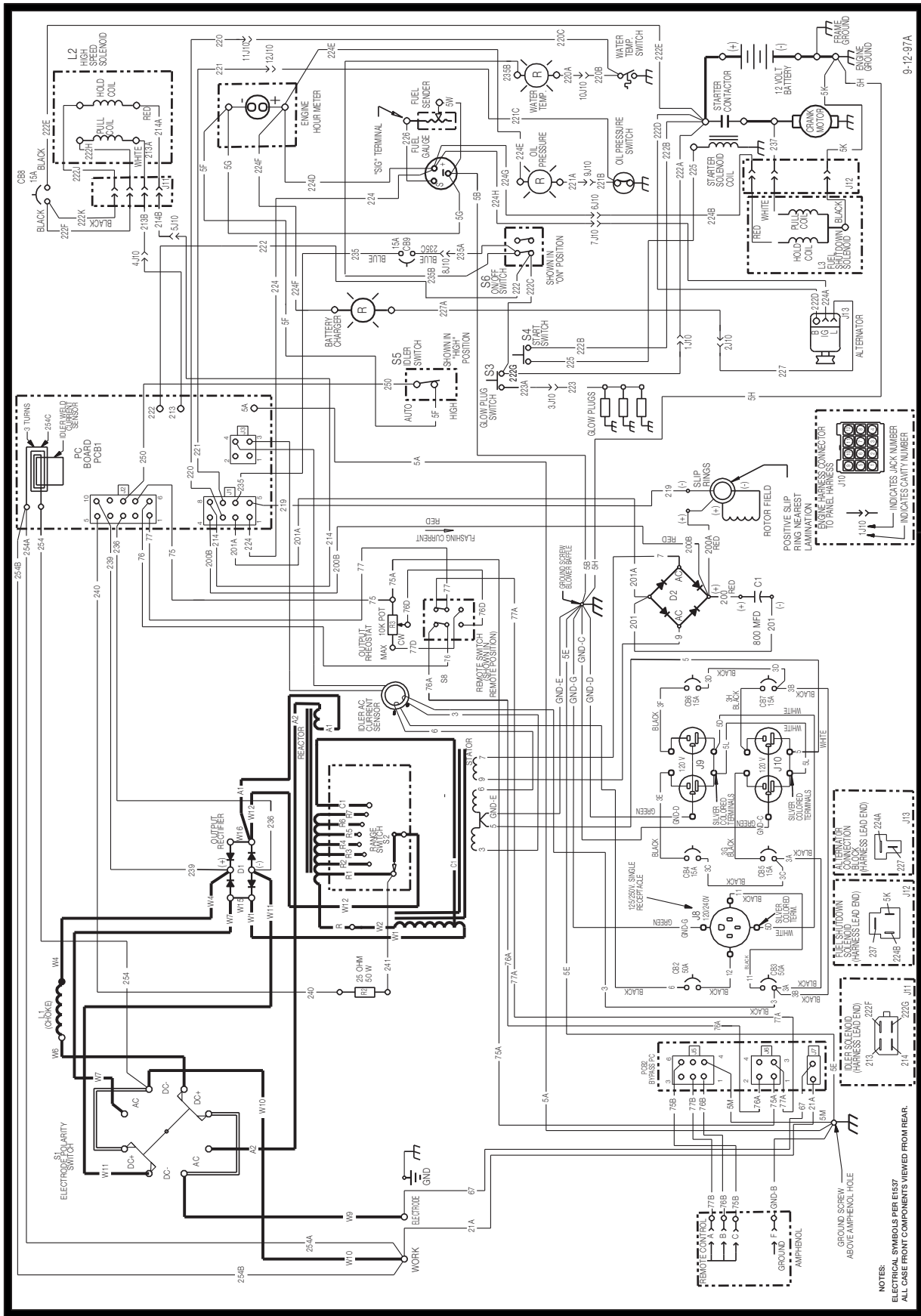

9-12-97A  
L10556

NOTE: This diagram is for reference only. It may not be accurate for all machines covered by this manual. The specific diagram for a particular code is pasted inside the machine on one of the enclosure panels. If the diagram is illegible, write to the Service Department for a replacement. Give the equipment code number.

RANGER 300 D AND 300 DLX





WIRING DIAGRAM - RANGER 300DLX

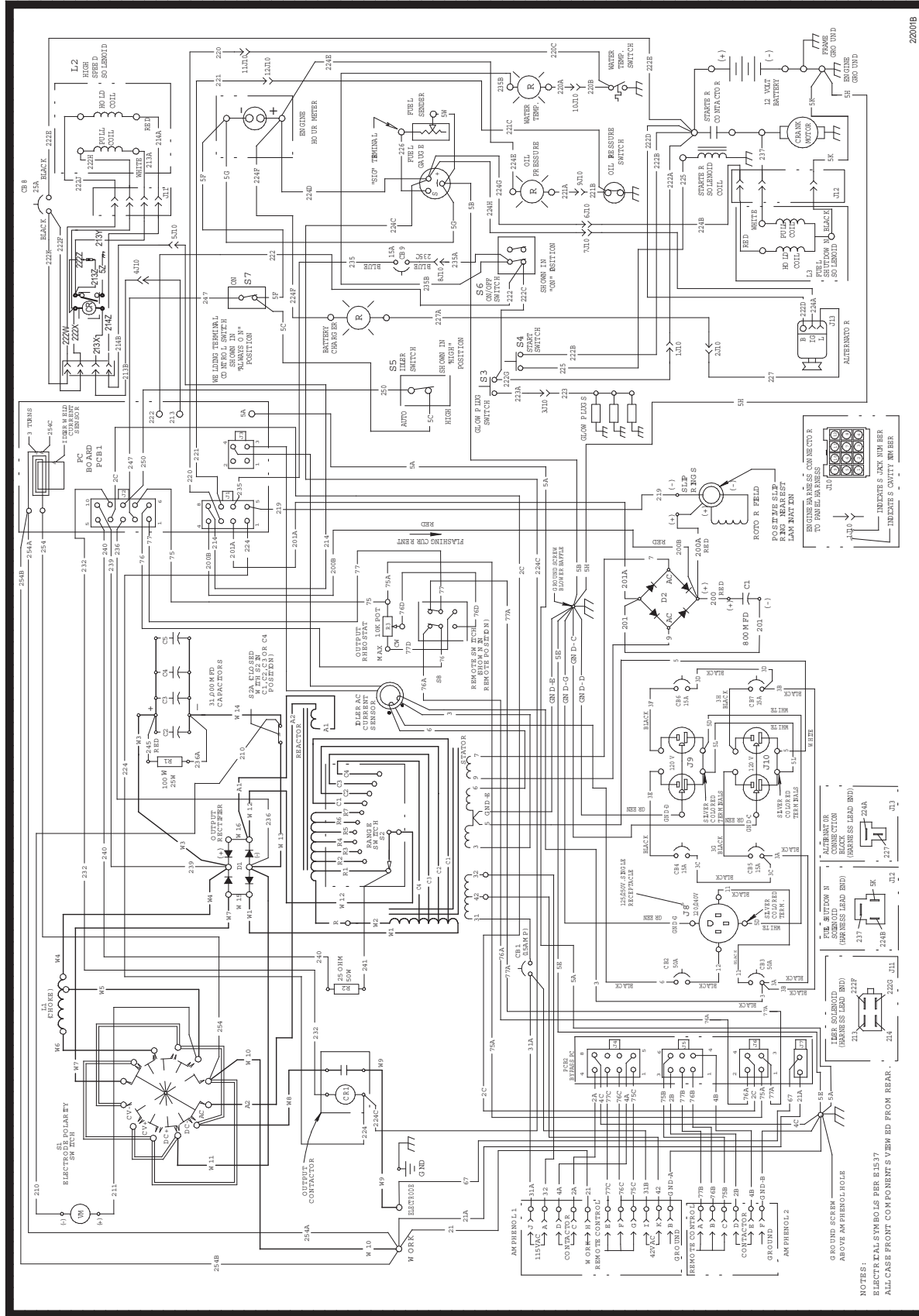

L11702

NOTE: This diagram is for reference only. It may not be accurate for all machines covered by this manual. The specific diagram for a particular code is pasted inside the machine on one of the enclosure panels. If the diagram is illegible, write to the Service Department for a replacement. Give the equipment code number..

RANGER 300 D AND 300 DLX



DIMENSION PRINT - RANGER 300

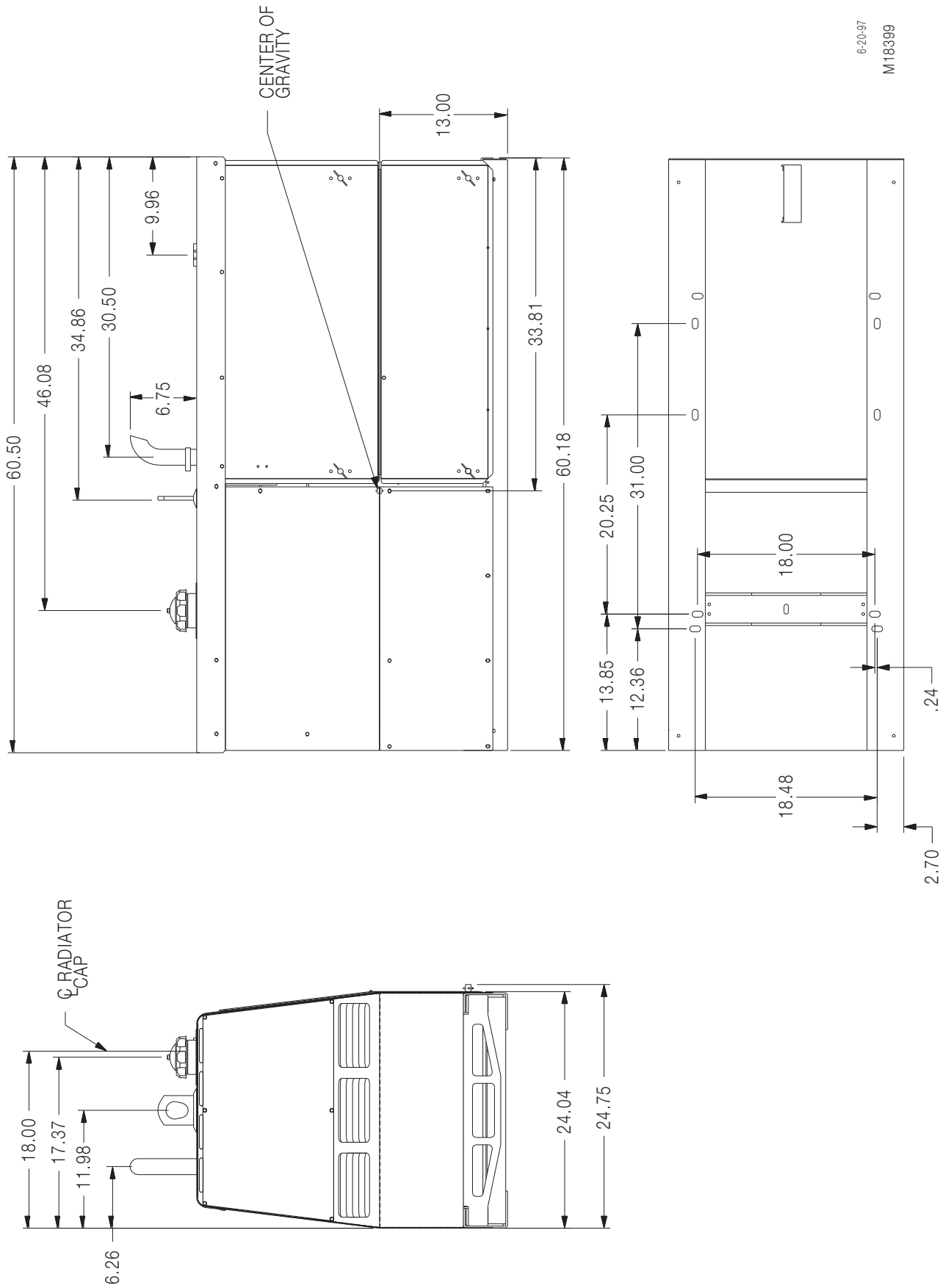

6-20-97  
M18399

RANGER 300 D AND 300 DLX



# NOTES

---

RANGER 300 D AND 300 DLX



# NOTES

---

RANGER 300 D AND 300 DLX





<b>WARNING</b>	<ul style="list-style-type: none"> <li>● Do not touch electrically live parts or electrode with skin or wet clothing.</li> <li>● Insulate yourself from work and ground.</li> </ul>	<ul style="list-style-type: none"> <li>● Keep flammable materials away.</li> </ul>	<ul style="list-style-type: none"> <li>● Wear eye, ear and body protection.</li> </ul>
Spanish <b>AVISO DE PRECAUCION</b>	<ul style="list-style-type: none"> <li>● No toque las partes o los electrodos bajo carga con la piel o ropa mojada.</li> <li>● Aíslese del trabajo y de la tierra.</li> </ul>	<ul style="list-style-type: none"> <li>● Mantenga el material combustible fuera del área de trabajo.</li> </ul>	<ul style="list-style-type: none"> <li>● Protéjase los ojos, los oídos y el cuerpo.</li> </ul>
French <b>ATTENTION</b>	<ul style="list-style-type: none"> <li>● Ne laissez ni la peau ni des vêtements mouillés entrer en contact avec des pièces sous tension.</li> <li>● Isolez-vous du travail et de la terre.</li> </ul>	<ul style="list-style-type: none"> <li>● Gardez à l'écart de tout matériel inflammable.</li> </ul>	<ul style="list-style-type: none"> <li>● Protégez vos yeux, vos oreilles et votre corps.</li> </ul>
German <b>WARNUNG</b>	<ul style="list-style-type: none"> <li>● Berühren Sie keine stromführenden Teile oder Elektroden mit Ihrem Körper oder feuchter Kleidung!</li> <li>● Isolieren Sie sich von den Elektroden und dem Erdboden!</li> </ul>	<ul style="list-style-type: none"> <li>● Entfernen Sie brennbares Material!</li> </ul>	<ul style="list-style-type: none"> <li>● Tragen Sie Augen-, Ohren- und Körperschutz!</li> </ul>
Portuguese <b>ATENÇÃO</b>	<ul style="list-style-type: none"> <li>● Não toque partes elétricas e electrodos com a pele ou roupa molhada.</li> <li>● Isole-se da peça e terra.</li> </ul>	<ul style="list-style-type: none"> <li>● Mantenha inflamáveis bem guardados.</li> </ul>	<ul style="list-style-type: none"> <li>● Use proteção para a vista, ouvido e corpo.</li> </ul>
Japanese <b>注意事項</b>	<ul style="list-style-type: none"> <li>● 通電中の電気部品、又は溶材にヒフやぬれた布で触れないこと。</li> <li>● 施工物やアースから身体が絶縁されている様にして下さい。</li> </ul>	<ul style="list-style-type: none"> <li>● 燃えやすいものの側での溶接作業は絶対にしてはなりません。</li> </ul>	<ul style="list-style-type: none"> <li>● 目、耳及び身体に保護具をして下さい。</li> </ul>
Chinese <b>警告</b>	<ul style="list-style-type: none"> <li>● 皮肤或湿衣物切勿接触带电部件及焊条。</li> <li>● 使你自已与地面和工件绝缘。</li> </ul>	<ul style="list-style-type: none"> <li>● 把一切易燃物品移离工作场所。</li> </ul>	<ul style="list-style-type: none"> <li>● 佩戴眼、耳及身体劳动保护用具。</li> </ul>
Korean <b>위험</b>	<ul style="list-style-type: none"> <li>● 전도체나 용접봉을 젖은 헝겍 또는 피부로 절대 접촉치 마십시오.</li> <li>● 모재와 접지를 접촉치 마십시오.</li> </ul>	<ul style="list-style-type: none"> <li>● 인화성 물질을 접근시키지 마십시오.</li> </ul>	<ul style="list-style-type: none"> <li>● 눈, 귀와 몸에 보호장구를 착용하십시오.</li> </ul>
Arabic <b>تحذير</b>	<ul style="list-style-type: none"> <li>● لا تلمس الاجزاء التي يسري فيها التيار الكهربائي أو الألكترود بجسد الجسم أو بالملابس المبللة بالماء.</li> <li>● ضع عازلا على جسمك خلال العمل.</li> </ul>	<ul style="list-style-type: none"> <li>● ضع المواد القابلة للاشتعال في مكان بعيد.</li> </ul>	<ul style="list-style-type: none"> <li>● ضع أدوات وملابس واقية على عينيك وأذنيك وجسمك.</li> </ul>

**READ AND UNDERSTAND THE MANUFACTURER'S INSTRUCTION FOR THIS EQUIPMENT AND THE CONSUMABLES TO BE USED AND FOLLOW YOUR EMPLOYER'S SAFETY PRACTICES.**

**SE RECOMIENDA LEER Y ENTENDER LAS INSTRUCCIONES DEL FABRICANTE PARA EL USO DE ESTE EQUIPO Y LOS CONSUMIBLES QUE VA A UTILIZAR, SIGA LAS MEDIDAS DE SEGURIDAD DE SU SUPERVISOR.**

**LISEZ ET COMPRENEZ LES INSTRUCTIONS DU FABRICANT EN CE QUI REGARDE CET EQUIPMENT ET LES PRODUITS A ETRE EMPLOYES ET SUIVEZ LES PROCEDURES DE SECURITE DE VOTRE EMPLOYEUR.**

**LESEN SIE UND BEFOLGEN SIE DIE BETRIEBSANLEITUNG DER ANLAGE UND DEN ELEKTRODENEINSATZ DES HERSTELLERS. DIE UNFALLVERHÜTUNGSVORSCHRIFTEN DES ARBEITGEBERS SIND EBENFALLS ZU BEACHTEN.**

			
<ul style="list-style-type: none"> <li>● Keep your head out of fumes.</li> <li>● Use ventilation or exhaust to remove fumes from breathing zone.</li> </ul>	<ul style="list-style-type: none"> <li>● Turn power off before servicing.</li> </ul>	<ul style="list-style-type: none"> <li>● Do not operate with panel open or guards off.</li> </ul>	<b>WARNING</b>
<ul style="list-style-type: none"> <li>● Los humos fuera de la zona de respiración.</li> <li>● Mantenga la cabeza fuera de los humos. Utilice ventilación o aspiración para gases.</li> </ul>	<ul style="list-style-type: none"> <li>● Desconectar el cable de alimentación de poder de la máquina antes de iniciar cualquier servicio.</li> </ul>	<ul style="list-style-type: none"> <li>● No operar con panel abierto o guardas quitadas.</li> </ul>	Spanish <b>AVISO DE PRECAUCION</b>
<ul style="list-style-type: none"> <li>● Gardez la tête à l'écart des fumées.</li> <li>● Utilisez un ventilateur ou un aspirateur pour ôter les fumées des zones de travail.</li> </ul>	<ul style="list-style-type: none"> <li>● Débranchez le courant avant l'entretien.</li> </ul>	<ul style="list-style-type: none"> <li>● N'opérez pas avec les panneaux ouverts ou avec les dispositifs de protection enlevés.</li> </ul>	French <b>ATTENTION</b>
<ul style="list-style-type: none"> <li>● Vermeiden Sie das Einatmen von Schweißrauch!</li> <li>● Sorgen Sie für gute Be- und Entlüftung des Arbeitsplatzes!</li> </ul>	<ul style="list-style-type: none"> <li>● Strom vor Wartungsarbeiten abschalten! (Netzstrom völlig öffnen; Maschine anhalten!)</li> </ul>	<ul style="list-style-type: none"> <li>● Anlage nie ohne Schutzgehäuse oder Innenschutzverkleidung in Betrieb setzen!</li> </ul>	German <b>WARNUNG</b>
<ul style="list-style-type: none"> <li>● Mantenha seu rosto da fumaça.</li> <li>● Use ventilação e exaustão para remover fumo da zona respiratória.</li> </ul>	<ul style="list-style-type: none"> <li>● Não opere com as tampas removidas.</li> <li>● Desligue a corrente antes de fazer serviço.</li> <li>● Não toque as partes elétricas nuas.</li> </ul>	<ul style="list-style-type: none"> <li>● Mantenha-se afastado das partes moventes.</li> <li>● Não opere com os painéis abertos ou guardas removidas.</li> </ul>	Portuguese <b>ATENÇÃO</b>
<ul style="list-style-type: none"> <li>● ヒュームから頭を離すようにして下さい。</li> <li>● 換気や排煙に十分留意して下さい。</li> </ul>	<ul style="list-style-type: none"> <li>● メンテナンス・サービスに取りかかる際には、まず電源スイッチを必ず切ってください。</li> </ul>	<ul style="list-style-type: none"> <li>● パネルやカバーを取り外したまま機械操作をしないで下さい。</li> </ul>	Japanese <b>注意事項</b>
<ul style="list-style-type: none"> <li>● 頭部遠離煙霧。</li> <li>● 在呼吸區使用通風或排風器除煙。</li> </ul>	<ul style="list-style-type: none"> <li>● 維修前切斷電源。</li> </ul>	<ul style="list-style-type: none"> <li>● 儀表板打開或沒有安全罩時不準作業。</li> </ul>	Chinese <b>警告</b>
<ul style="list-style-type: none"> <li>● 얼굴로부터 용접가스를 멀리하십시오.</li> <li>● 호흡지역으로부터 용접가스를 제거하기 위해 가스제거기나 통풍기를 사용하십시오.</li> </ul>	<ul style="list-style-type: none"> <li>● 보수전에 전원을 차단하십시오.</li> </ul>	<ul style="list-style-type: none"> <li>● 판넬이 열린 상태로 작동치 마십시오.</li> </ul>	Korean <b>위험</b>
<ul style="list-style-type: none"> <li>● ابعدها رأسك بعيداً عن الدخان.</li> <li>● استعمل التهوية أو جهاز ضغط الدخان للخارج لكي تبعد الدخان عن المنطقة التي تتنفس فيها.</li> </ul>	<ul style="list-style-type: none"> <li>● أقطع التيار الكهربائي قبل القيام بأية صيانة.</li> </ul>	<ul style="list-style-type: none"> <li>● لا تشغيل هذا الجهاز اذا كانت الاغطية الحديدية الواقية ليست عليه.</li> </ul>	Arabic <b>تحذير</b>

**LEIA E COMPREENDA AS INSTRUÇÕES DO FABRICANTE PARA ESTE EQUIPAMENTO E AS PARTES DE USO, E SIGA AS PRÁTICAS DE SEGURANÇA DO EMPREGADOR.**

使う機械や溶材のメーカーの指示書をよく読み、まず理解して下さい。そして貴社の安全規定に従って下さい。

請詳細閱讀並理解製造廠提供的說明以及應該使用的銀焊材料，並請遵守貴方的有閣勞動保護規定。

이 제품에 동봉된 작업지침서를 숙지하시고 귀사의 작업자 안전수칙을 준수하시기 바랍니다.

اقرأ بتمعن وافهم تعليمات المصنع المنتج لهذه المعدات والمواد قبل استعمالها واتبع تعليمات الوقاية لصاحب العمل.



• World's Leader in Welding and Cutting Products •

• Sales and Service through Subsidiaries and Distributors Worldwide •

Cleveland, Ohio 44117-1199 U.S.A. TEL: 216.481.8100 FAX: 216.486.1751 WEB SITE: [www.lincolnelectric.com](http://www.lincolnelectric.com)

Download from [Www.Somanuals.com](http://Www.Somanuals.com). All Manuals Search And Download.



## Free Manuals Download Website

<http://myh66.com>

<http://usermanuals.us>

<http://www.somanuals.com>

<http://www.4manuals.cc>

<http://www.manual-lib.com>

<http://www.404manual.com>

<http://www.luxmanual.com>

<http://aubethermostatmanual.com>

Golf course search by state

<http://golfingnear.com>

Email search by domain

<http://emailbydomain.com>

Auto manuals search

<http://auto.somanuals.com>

TV manuals search

<http://tv.somanuals.com>