

INVERTEC™ V160-T

For use with machines having Code Numbers: **10878; 11032**

Safety Depends on You

Lincoln arc welding and cutting equipment is designed and built with safety in mind. However, your overall safety can be increased by proper installation ... and thoughtful operation on your part. **DO NOT INSTALL, OPERATE OR REPAIR THIS EQUIPMENT WITHOUT READING THIS MANUAL AND THE SAFETY PRECAUTIONS CONTAINED THROUGHOUT.** And, most importantly, think before you act and be careful.



OPERATOR'S MANUAL



LINCOLN®
ELECTRIC

Copyright © Lincoln Global Inc.

- World's Leader in Welding and Cutting Products •
- Sales and Service through Subsidiaries and Distributors Worldwide •

Cleveland, Ohio 44117-1199 U.S.A. TEL: 216.481.8100 FAX: 216.486.1751 WEB SITE: www.lincolnelectric.com

Download from Www.Somanuals.com. All Manuals Search And Download.

⚠ WARNING



CALIFORNIA PROPOSITION 65 WARNINGS



Diesel engine exhaust and some of its constituents are known to the State of California to cause cancer, birth defects, and other reproductive harm.

The Above For Diesel Engines

The engine exhaust from this product contains chemicals known to the State of California to cause cancer, birth defects, or other reproductive harm.

The Above For Gasoline Engines

ARC WELDING CAN BE HAZARDOUS. PROTECT YOURSELF AND OTHERS FROM POSSIBLE SERIOUS INJURY OR DEATH. KEEP CHILDREN AWAY. PACEMAKER WEARERS SHOULD CONSULT WITH THEIR DOCTOR BEFORE OPERATING.

Read and understand the following safety highlights. For additional safety information, it is strongly recommended that you purchase a copy of "Safety in Welding & Cutting - ANSI Standard Z49.1" from the American Welding Society, P.O. Box 351040, Miami, Florida 33135 or CSA Standard W117.2-1974. A Free copy of "Arc Welding Safety" booklet E205 is available from the Lincoln Electric Company, 22801 St. Clair Avenue, Cleveland, Ohio 44117-1199.

BE SURE THAT ALL INSTALLATION, OPERATION, MAINTENANCE AND REPAIR PROCEDURES ARE PERFORMED ONLY BY QUALIFIED INDIVIDUALS.



FOR ENGINE powered equipment.

1.a. Turn the engine off before troubleshooting and maintenance work unless the maintenance work requires it to be running.



1.b. Operate engines in open, well-ventilated areas or vent the engine exhaust fumes outdoors.



1.c. Do not add the fuel near an open flame welding arc or when the engine is running. Stop the engine and allow it to cool before refueling to prevent spilled fuel from vaporizing on contact with hot engine parts and igniting. Do not spill fuel when filling tank. If fuel is spilled, wipe it up and do not start engine until fumes have been eliminated.

1.d. Keep all equipment safety guards, covers and devices in position and in good repair. Keep hands, hair, clothing and tools away from V-belts, gears, fans and all other moving parts when starting, operating or repairing equipment.

1.e. In some cases it may be necessary to remove safety guards to perform required maintenance. Remove guards only when necessary and replace them when the maintenance requiring their removal is complete. Always use the greatest care when working near moving parts.



1.f. Do not put your hands near the engine fan. Do not attempt to override the governor or idler by pushing on the throttle control rods while the engine is running.

1.g. To prevent accidentally starting gasoline engines while turning the engine or welding generator during maintenance work, disconnect the spark plug wires, distributor cap or magneto wire as appropriate.



1.h. To avoid scalding, do not remove the radiator pressure cap when the engine is hot.



ELECTRIC AND MAGNETIC FIELDS may be dangerous

2.a. Electric current flowing through any conductor causes localized Electric and Magnetic Fields (EMF). Welding current creates EMF fields around welding cables and welding machines

2.b. EMF fields may interfere with some pacemakers, and welders having a pacemaker should consult their physician before welding.

2.c. Exposure to EMF fields in welding may have other health effects which are now not known.

2.d. All welders should use the following procedures in order to minimize exposure to EMF fields from the welding circuit:

2.d.1. Route the electrode and work cables together - Secure them with tape when possible.

2.d.2. Never coil the electrode lead around your body.

2.d.3. Do not place your body between the electrode and work cables. If the electrode cable is on your right side, the work cable should also be on your right side.

2.d.4. Connect the work cable to the workpiece as close as possible to the area being welded.

2.d.5. Do not work next to welding power source.



ELECTRIC SHOCK can kill.

- 3.a. The electrode and work (or ground) circuits are electrically "hot" when the welder is on. Do not touch these "hot" parts with your bare skin or wet clothing. Wear dry, hole-free gloves to insulate hands.
- 3.b. Insulate yourself from work and ground using dry insulation. Make certain the insulation is large enough to cover your full area of physical contact with work and ground.

In addition to the normal safety precautions, if welding must be performed under electrically hazardous conditions (in damp locations or while wearing wet clothing; on metal structures such as floors, gratings or scaffolds; when in cramped positions such as sitting, kneeling or lying, if there is a high risk of unavoidable or accidental contact with the workpiece or ground) use the following equipment:

- Semiautomatic DC Constant Voltage (Wire) Welder.
- DC Manual (Stick) Welder.
- AC Welder with Reduced Voltage Control.

- 3.c. In semiautomatic or automatic wire welding, the electrode, electrode reel, welding head, nozzle or semiautomatic welding gun are also electrically "hot".
- 3.d. Always be sure the work cable makes a good electrical connection with the metal being welded. The connection should be as close as possible to the area being welded.
- 3.e. Ground the work or metal to be welded to a good electrical (earth) ground.
- 3.f. Maintain the electrode holder, work clamp, welding cable and welding machine in good, safe operating condition. Replace damaged insulation.
- 3.g. Never dip the electrode in water for cooling.
- 3.h. Never simultaneously touch electrically "hot" parts of electrode holders connected to two welders because voltage between the two can be the total of the open circuit voltage of both welders.
- 3.i. When working above floor level, use a safety belt to protect yourself from a fall should you get a shock.
- 3.j. Also see Items 6.c. and 8.



ARC RAYS can burn.

- 4.a. Use a shield with the proper filter and cover plates to protect your eyes from sparks and the rays of the arc when welding or observing open arc welding. Headshield and filter lens should conform to ANSI Z87.1 standards.
- 4.b. Use suitable clothing made from durable flame-resistant material to protect your skin and that of your helpers from the arc rays.
- 4.c. Protect other nearby personnel with suitable, non-flammable screening and/or warn them not to watch the arc nor expose themselves to the arc rays or to hot spatter or metal.



FUMES AND GASES can be dangerous.

- 5.a. Welding may produce fumes and gases hazardous to health. Avoid breathing these fumes and gases. When welding, keep your head out of the fume. Use enough ventilation and/or exhaust at the arc to keep fumes and gases away from the breathing zone. **When welding with electrodes which require special ventilation such as stainless or hard facing (see instructions on container or MSDS) or on lead or cadmium plated steel and other metals or coatings which produce highly toxic fumes, keep exposure as low as possible and within applicable OSHA PEL and ACGIH TLV limits using local exhaust or mechanical ventilation. In confined spaces or in some circumstances, outdoors, a respirator may be required. Additional precautions are also required when welding on galvanized steel.**
- 5.b. The operation of welding fume control equipment is affected by various factors including proper use and positioning of the equipment, maintenance of the equipment and the specific welding procedure and application involved. Worker exposure level should be checked upon installation and periodically thereafter to be certain it is within applicable OSHA PEL and ACGIH TLV limits.
- 5.c. Do not weld in locations near chlorinated hydrocarbon vapors coming from degreasing, cleaning or spraying operations. The heat and rays of the arc can react with solvent vapors to form phosgene, a highly toxic gas, and other irritating products.
- 5.d. Shielding gases used for arc welding can displace air and cause injury or death. Always use enough ventilation, especially in confined areas, to insure breathing air is safe.
- 5.e. Read and understand the manufacturer's instructions for this equipment and the consumables to be used, including the material safety data sheet (MSDS) and follow your employer's safety practices. MSDS forms are available from your welding distributor or from the manufacturer.
- 5.f. Also see item 1.b.

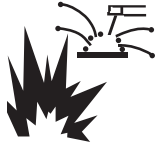

WELDING and CUTTING SPARKS can cause fire or explosion.

6.a. Remove fire hazards from the welding area. If this is not possible, cover them to prevent the welding sparks from starting a fire.

Remember that welding sparks and hot materials from welding can easily go through small cracks and openings to adjacent areas. Avoid welding near hydraulic lines. Have a fire extinguisher readily available.

- 6.b. Where compressed gases are to be used at the job site, special precautions should be used to prevent hazardous situations. Refer to "Safety in Welding and Cutting" (ANSI Standard Z49.1) and the operating information for the equipment being used.
- 6.c. When not welding, make certain no part of the electrode circuit is touching the work or ground. Accidental contact can cause overheating and create a fire hazard.
- 6.d. Do not heat, cut or weld tanks, drums or containers until the proper steps have been taken to insure that such procedures will not cause flammable or toxic vapors from substances inside. They can cause an explosion even though they have been "cleaned." For information, purchase "Recommended Safe Practices for the Preparation for Welding and Cutting of Containers and Piping That Have Held Hazardous Substances," AWS F4.1 from the American Welding Society (see address above).
- 6.e. Vent hollow castings or containers before heating, cutting or welding. They may explode.
- 6.f. Sparks and spatter are thrown from the welding arc. Wear oil free protective garments such as leather gloves, heavy shirt, cuffless trousers, high shoes and a cap over your hair. Wear ear plugs when welding out of position or in confined places. Always wear safety glasses with side shields when in a welding area.
- 6.g. Connect the work cable to the work as close to the welding area as practical. Work cables connected to the building framework or other locations away from the welding area increase the possibility of the welding current passing through lifting chains, crane cables or other alternate circuits. This can create fire hazards or overheat lifting chains or cables until they fail.
- 6.h. Also see item 1.c.
- 6.i. Read and follow NFPA 51B "Standard for Fire Prevention During Welding, Cutting and Other Hot Work," available from NFPA, 1 Batterymarch Park, PO box 9101, Quincy, Ma 022690-9101.
- 6.j. Do not use a welding power source for pipe thawing.



CYLINDER may explode if damaged.

- 7.a. Use only compressed gas cylinders containing the correct shielding gas for the process used and properly operating regulators designed for the gas and pressure used. All hoses, fittings, etc. should be suitable for the application and maintained in good condition.
- 7.b. Always keep cylinders in an upright position securely chained to an undercarriage or fixed support.
- 7.c. Cylinders should be located:
 - Away from areas where they may be struck or subjected to physical damage.
 - A safe distance from arc welding or cutting operations and any other source of heat, sparks, or flame.
- 7.d. Never allow the electrode, electrode holder or any other electrically "hot" parts to touch a cylinder.
- 7.e. Keep your head and face away from the cylinder valve outlet when opening the cylinder valve.
- 7.f. Valve protection caps should always be in place and hand tight except when the cylinder is in use or connected for use.
- 7.g. Read and follow the instructions on compressed gas cylinders, associated equipment, and CGA publication P-1, "Precautions for Safe Handling of Compressed Gases in Cylinders," available from the Compressed Gas Association 1235 Jefferson Davis Highway, Arlington, VA 22202.



FOR ELECTRICALLY powered equipment.

- 8.a. Turn off input power using the disconnect switch at the fuse box before working on the equipment.
- 8.b. Install equipment in accordance with the U.S. National Electrical Code, all local codes and the manufacturer's recommendations.
- 8.c. Ground the equipment in accordance with the U.S. National Electrical Code and the manufacturer's recommendations.

Refer to <http://www.lincolnelectric.com/safety> for additional safety information.

PRÉCAUTIONS DE SÛRETÉ

Pour votre propre protection lire et observer toutes les instructions et les précautions de sûreté spécifiques qui paraissent dans ce manuel aussi bien que les précautions de sûreté générales suivantes:

Sûreté Pour Soudage A L'Arc

1. Protégez-vous contre la secousse électrique:
 - a. Les circuits à l'électrode et à la pièce sont sous tension quand la machine à souder est en marche. Eviter toujours tout contact entre les parties sous tension et la peau nue ou les vêtements mouillés. Porter des gants secs et sans trous pour isoler les mains.
 - b. Faire très attention de bien s'isoler de la masse quand on soude dans des endroits humides, ou sur un plancher métallique ou des grilles métalliques, principalement dans les positions assis ou couché pour lesquelles une grande partie du corps peut être en contact avec la masse.
 - c. Maintenir le porte-électrode, la pince de masse, le câble de soudage et la machine à souder en bon et sûr état de fonctionnement.
 - d. Ne jamais plonger le porte-électrode dans l'eau pour le refroidir.
 - e. Ne jamais toucher simultanément les parties sous tension des porte-électrodes connectés à deux machines à souder parce que la tension entre les deux pinces peut être le total de la tension à vide des deux machines.
 - f. Si on utilise la machine à souder comme une source de courant pour soudage semi-automatique, ces précautions pour le porte-électrode s'appliquent aussi au pistolet de soudage.
2. Dans le cas de travail au dessus du niveau du sol, se protéger contre les chutes dans le cas où on recoit un choc. Ne jamais enrouler le câble-électrode autour de n'importe quelle partie du corps.
3. Un coup d'arc peut être plus sévère qu'un coup de soliel, donc:
 - a. Utiliser un bon masque avec un verre filtrant approprié ainsi qu'un verre blanc afin de se protéger les yeux du rayonnement de l'arc et des projections quand on soude ou quand on regarde l'arc.
 - b. Porter des vêtements convenables afin de protéger la peau de soudeur et des aides contre le rayonnement de l'arc.
 - c. Protéger l'autre personnel travaillant à proximité au soudage à l'aide d'écrans appropriés et non-inflammables.
4. Des gouttes de laitier en fusion sont émises de l'arc de soudage. Se protéger avec des vêtements de protection libres de l'huile, tels que les gants en cuir, chemise épaisse, pantalons sans revers, et chaussures montantes.
5. Toujours porter des lunettes de sécurité dans la zone de soudage. Utiliser des lunettes avec écrans latéraux dans les zones où l'on pique le laitier.

6. Eloigner les matériaux inflammables ou les recouvrir afin de prévenir tout risque d'incendie dû aux étincelles.
7. Quand on ne soude pas, poser la pince à un endroit isolé de la masse. Un court-circuit accidentel peut provoquer un échauffement et un risque d'incendie.
8. S'assurer que la masse est connectée le plus près possible de la zone de travail qu'il est pratique de le faire. Si on place la masse sur la charpente de la construction ou d'autres endroits éloignés de la zone de travail, on augmente le risque de voir passer le courant de soudage par les chaînes de levage, câbles de grue, ou autres circuits. Cela peut provoquer des risques d'incendie ou d'échauffement des chaînes et des câbles jusqu'à ce qu'ils se rompent.
9. Assurer une ventilation suffisante dans la zone de soudage. Ceci est particulièrement important pour le soudage de tôles galvanisées plombées, ou cadmiées ou tout autre métal qui produit des fumées toxiques.
10. Ne pas souder en présence de vapeurs de chlore provenant d'opérations de dégraissage, nettoyage ou pistolage. La chaleur ou les rayons de l'arc peuvent réagir avec les vapeurs du solvant pour produire du phosgène (gas fortement toxique) ou autres produits irritants.
11. Pour obtenir de plus amples renseignements sur la sûreté, voir le code "Code for safety in welding and cutting" CSA Standard W 117.2-1974.

PRÉCAUTIONS DE SÛRETÉ POUR LES MACHINES À SOUDER À TRANSFORMATEUR ET À REDRESSEUR

1. Relier à la terre le châssis du poste conformément au code de l'électricité et aux recommandations du fabricant. Le dispositif de montage ou la pièce à souder doit être branché à une bonne mise à la terre.
2. Autant que possible, l'installation et l'entretien du poste seront effectués par un électricien qualifié.
3. Avant de faire des travaux à l'intérieur de poste, la débrancher à l'interrupteur à la boîte de fusibles.
4. Garder tous les couvercles et dispositifs de sûreté à leur place.

Thank You — for selecting a **QUALITY** product. We want you to take pride in operating this product ... as much pride as we have in bringing this product to you!

CUSTOMER ASSISTANCE POLICY

The business of The Lincoln Electric Company is manufacturing and selling high quality welding equipment, consumables, and cutting equipment. Our challenge is to meet the needs of our customers and to exceed their expectations. On occasion, purchasers may ask Lincoln Electric for advice or information about their use of our products. We respond to our customers based on the best information in our possession at that time. Lincoln Electric is not in a position to warrant or guarantee such advice, and assumes no liability, with respect to such information or advice. We expressly disclaim any warranty of any kind, including any warranty of fitness for any customer's particular purpose, with respect to such information or advice. As a matter of practical consideration, we also cannot assume any responsibility for updating or correcting any such information or advice once it has been given, nor does the provision of information or advice create, expand or alter any warranty with respect to the sale of our products.

Lincoln Electric is a responsive manufacturer, but the selection and use of specific products sold by Lincoln Electric is solely within the control of, and remains the sole responsibility of the customer. Many variables beyond the control of Lincoln Electric affect the results obtained in applying these types of fabrication methods and service requirements.

Subject to Change – This information is accurate to the best of our knowledge at the time of printing. Please refer to www.lincolnelectric.com for any updated information.

Please Examine Carton and Equipment For Damage Immediately

When this equipment is shipped, title passes to the purchaser upon receipt by the carrier. Consequently, Claims for material damaged in shipment must be made by the purchaser against the transportation company at the time the shipment is received.

Please record your equipment identification information below for future reference. This information can be found on your machine nameplate.

Product _____

Model Number _____

Code Number or Date Code _____

Serial Number _____

Date Purchased _____

Where Purchased _____

Whenever you request replacement parts or information on this equipment, always supply the information you have recorded above. The code number is especially important when identifying the correct replacement parts.

On-Line Product Registration

- Register your machine with Lincoln Electric either via fax or over the Internet.
- For faxing: Complete the form on the back of the warranty statement included in the literature packet accompanying this machine and fax the form per the instructions printed on it.
- For On-Line Registration: Go to our **WEB SITE at www.lincolnelectric.com**. Choose "Quick Links" and then "Product Registration". Please complete the form and submit your registration.

Read this Operators Manual completely before attempting to use this equipment. Save this manual and keep it handy for quick reference. Pay particular attention to the safety instructions we have provided for your protection. The level of seriousness to be applied to each is explained below:

⚠ WARNING

This statement appears where the information **must** be followed **exactly** to avoid **serious personal injury or loss of life**.

⚠ CAUTION

This statement appears where the information **must** be followed to avoid **minor personal injury or damage to this equipment**.

	Page
Installation	Section A
Technical Specifications	A-1
Select Suitable Location	A-2
Stacking	A-2
Tilting	A-2
Machine Grounding and High Frequency Interference Protection	A-2
Input Connections	A-3
Ground Connection	A-3, A-4
ARFU (Auto-Restore Fuse)	A-4
Output Connections	A-5
Output and Gas Connection for Tig Welding	A-5
Output Connection for Stick Welding	A-5
Work Cable Connection	A-5
Quick Disconnect Plug	A-6
Shielding Gas Connection	A-6
Remote Control Connection	A-6
<hr/>	
Operation	Section B
Safety Instructions	B-1
General Description	B-1
Welding Capability	B-1
Limitations	B-1
Rear Control Panel	B-2
Controls and Settings, 2 Step and 4 Step Tig Sequence	B-2 thru B-5
DIP Switch Functions (Service Information)	B-6 thru B-11
DIP Switch 1: Machine Type	B-6
DIP Switch 2: Preflow Timer	B-6
DIP Switch 3: 2 Step Restart Enable	B-7
DIP Switch 4: 4 Step Restart Enable	B-8, B-9
DIP Switch 5: Low OCV Enable	B-10
DIP Switch 6: European/USA Machine Configuration	B-10
DIP Switch 7 & 8: Upslope Timer	B-11
Start/Crater Current Adjustment	B-11
<hr/>	
Accessories	Section C
Optional Accessories and Compatible Equipment	C-1
Factory, Field Installed	C-1
<hr/>	
Maintenance	Section D
Safety Precautions	D-1
Input Filter Capacitor Discharge Procedure	D-1
Routine Maintenance	D-1
<hr/>	
Troubleshooting	Section E
How to Use Troubleshooting Guide	E-1
Troubleshooting Guide	E-2 thru E-4
<hr/>	
Wiring Diagram	Section F
<hr/>	
Parts Lists	P-403
<hr/>	

TECHNICAL SPECIFICATIONS - V160-T

INPUT - SINGLE PHASE ONLY			
Input Voltages / 50 /60 Hz.		Max. Input Current at rated Output	
115 V (20 A Plug and branch) 115 V (30 A branch) 230 V		20 A 25 A 34 A	
RATED OUTPUT			
Duty Cycle	Output Amps	Output Volts	Input Circuit
100%	60 (Stick) 90 (TIG)	22.4 13.6	115V (20A Plug and Branch)
	80 (Stick) 110 (TIG)	23.2 14.4	115V (30A Branch)
35%	160 (Stick) 160 (TIG)	26.4 16.4	230V (30A Branch)
100%	130 (Stick) 130 (TIG)	25.2 15.2	230V (30A Branch)
OUTPUT			
Output Current Range	Maximum Open Circuit Voltage		Type of Output
5-160 Amps	48 Volts Max.		DC
RECOMMENDED INPUT WIRE AND FUSE SIZES FOR MAXIMUM RATED OUTPUT			
INPUT VOLTAGE / FREQUENCY (HZ)	TYPE S, SO ST, STO, OR EXTRA HARD USAGE INPUT CORD AWG	MAXIMUM TIME-DELAY CIRCUIT BREAKER OR FUSE SIZE (AMPS)	
230/50/60	#12	30	
PHYSICAL DIMENSIONS			
Height	Width	Depth	Weight
12.6 in. 320 mm	7.9 in. 200 mm	16.9 in. 430 mm	Approx. 24.2lbs. 11 kgs.
TEMPERATURE RANGES			
OPERATING TEMPERATURE RANGE		STORAGE TEMPERATURE RANGE	
-20°C to +40°C		-50°C to +85°C	

V160-T



Read entire installation section before starting installation.

SAFETY PRECAUTIONS

WARNING



ELECTRIC SHOCK can kill.

- Only qualified personnel should perform this installation.
- Disconnect input power by removing plug from receptacle before working inside V160-T. Allow machine to sit for

5 minutes minimum to allow the power capacitors to discharge before working inside this equipment.

- Insulate yourself from the work and ground.
- Always wear dry insulating gloves.
- Always connect the V160-T to a power supply grounded according to the National Electrical Code and local codes.

SELECT SUITABLE LOCATION

This machine will operate in harsh environments. However, it is important that simple preventative measures are followed to assure long life and reliable operation.

- Do not place or operate this machine on a surface with an incline greater than 15° from horizontal.
- This machine must be located where there is free circulation of clean air without restrictions for air movement to and from the air vents. Do not cover the machine with paper, cloth or rags when switched on.
- Dirt and dust that can be drawn into the machine should be kept to a minimum.
- Keep the machine dry and do not place it on wet ground or in puddles.
- Locate the machine away from radio controlled machinery. Normal operation may adversely affect the operation of nearby radio controlled machinery, which may result in injury or equipment damage. Read the section on "Machine Grounding and High Frequency Interference Protection" in this manual.
- When operated in ambient temperatures greater than 40°C, the output duty cycle may be reduced.

- Do not mount over combustible surfaces.

STACKING

The Invertec V160-T cannot be stacked.

TILTING

Place the machine directly on a secure, level surface. The machine may topple over if this procedure is not followed.

MACHINE GROUNDING AND HIGH FREQUENCY INTERFERENCE PROTECTION

The Capacitor Discharge Circuit used in the high frequency generator can be blamed for many radio, TV and electronic equipment interference problems. These problems may be the result of radiated interference. Proper grounding methods can reduce or eliminate radiated interference.

The Invertec V160-T has been field tested under recommended installation conditions. It complies with FCC allowable limits for radiation.

Radiated interference can develop in the following four ways:

1. Direct interference radiated from the welder.
2. Direct interference radiated from the welding leads.
3. Direct interference radiated from feedback into the power lines.
4. Interference from re-radiation of "pickup" by ungrounded metallic objects.

V160-T



Keeping these contributing factors in mind, installing equipment per the following instructions should minimize problems.

1. Keep the welder power supply lines as short as possible and enclose as much of them as possible in rigid metallic conduit or equivalent shielding for a distance of 50ft. (15.2m). Both ends of the conduit should be connected to a driven ground and the entire length should be continuous.
2. Keep the work and electrode leads as short as possible and as close together as possible. Lengths should not exceed 25ft. (7.6m). Tape the leads together when practical.
3. Be sure the torch and work cable rubber coverings are free of cuts and cracks that allow high frequency leakage. Cables with high natural rubber content, such as Lincoln Stable-Arc® better resist high frequency leakage than neoprene and other synthetic rubber insulated cables.
4. Keep the torch in good repair and all connections tight to reduce high frequency leakage.
5. The work terminal must be connected to a ground within ten feet of the welder, using one of the following methods.
 - a) A metal underground water pipe in direct contact with the earth for ten feet or more.
 - b) A 3/4" (19mm) galvanized pipe or a 5/8" (16mm) solid galvanized iron, steel or copper rod driven at least eight feet into the ground.

The ground should be securely made and the grounding cable should be as short as possible using cable of the same size as the work cable, or larger. Grounding to the building frame electrical conduit or a long pipe system can result in re-radiation, effectively making these members radiating antennas.
6. Keep all panels securely in place.
7. All electrical conductors within 50 ft (15.2m) of the welder should be enclosed in grounded, rigid metallic conduit or equivalent shielding. Flexible metallic conduit is generally not suitable.
8. When the welder is enclosed in a metal building, several earth driven electrical grounds connected (as in 5 (b) above) around the periphery of the building are recommended.

Failure to observe these recommended installation procedures can cause radio or TV interference problems.

INPUT CONNECTIONS

⚠ WARNING

ELECTRIC SHOCK can kill.



- Have a qualified electrician install and service this equipment.
- Disconnect input power by removing plug from receptacle before working inside V160-T. Allow machine to sit for 5 minutes minimum to allow the power capacitors to discharge before working inside this equipment.

5 minutes minimum to allow the power capacitors to discharge before working inside this equipment.

- Do not touch electrically hot parts.

GROUND CONNECTION



The frame of the welder must be grounded. A ground terminal marked with the symbol is located on the under panel for this purpose. See your local and national electrical codes for proper grounding methods.

⚠ CAUTION

The grounding is supplied in the input cord, it is important that the Supply Receptacle Ground connection is connected.

⚠ WARNING

This installation should be performed by a qualified electrician to ensure correct connections of the leads to the plug spades.

- The electrical system must be made by skilled technicians with the specific professional and technical qualifications and in compliance with the regulations in force in the country where the equipment is installed.
- The welding power source supply cable is provided with a green or yellow/green wire that must **ALWAYS** be earthed. This green or yellow/green wire must **NEVER** be used with other voltage conductors.
- Install only plugs that are corresponding to safety regulations.

Fuse the input circuit with time delay fuses marked "D" or delay type¹ circuit breakers. Using fuses or circuit breakers smaller than recommended may result in "nuisance" shut-offs from welder inrush currents even if not welding at high currents.

¹Also called inverse time or thermal/magnetic circuit breakers. These circuit breakers have a delay in trip action that decreases as the magnitude of the current increases.

The Invertec V160-T is recommended for use on an individual branch circuit.

115V INPUT

The rated output of the V160-T is available when connected to a 30A branch circuit. When connected to a branch circuit with lower ampacity, lower welding current and duty cycle must be used. An output guide is provided below. The values are approximate and must be adjusted downward if the fuse or circuit breaker trips off. Other loads on the circuit and fuse/circuit breaker characteristics will affect the available output. Do not exceed these welding conditions:

15A plug on a 15A branch

10% duty cycle

Stick: 65A

TIG: 95A

15A plug on a 20A branch

10% duty cycle

Stick: 75A

TIG: 105A

20A plug on a 20A branch

10% duty cycle

Stick: 85A

TIG: 120A

The Invertec V160-T is provided with a 115/230V cable, 6.6ft.(2m) in length, with a 15Amp 5-15P plug molded onto the cord.

The V160-T is supplied with an additional 20A plug that can replace the 15A plug to achieve higher output. To install the supplied 20A plug:

Connect the white (neutral) wire under terminal clamp with silver screw, and black (hot) wire under terminal clamp with brass screw. Connect green wire under terminal clamp with green screw.

ARFU (AUTO-RESTORE FUSE)

The dual input voltage machine is provided with an ARFU device. It only operates when the input is connected to an 115V supply and protects from input over current conditions.

When the ARFU has been activated due to an input over current condition, the output will be turned off and the green Power LED will blink indicating an over-current condition. This condition usually occurs when the unit is operated beyond its rated duty cycle. The unit will self-restore after a short time and will be ready for normal operation once the green Power LED stops blinking and remains on.

NOTE: The ARFU replaces a fuse (F2) that was used in older V160's.

WARNING

- **Failure to wire as instructed may cause personal injury or damage to equipment. To be installed or checked by an electrician or qualified person only.**

230V INPUT

To achieve the full output capacity of the V160-T, 230VAC inputs should be used. The change over is accomplished by replacing the 115VAC plug with a 30 Amp 230VAC plug (NEMA 6-30P).

ATTACHMENT PLUG

In all cases, the green or green/yellow grounding wire must be connected to the grounding pin of the plug, usually identified by a green screw.

All attachment plugs must comply with the Standard for Attachment Plugs and Receptacles, UL498.

The product is considered acceptable for use only when an attachment plug as specified is properly attached to the supply cord.

The Invertec V160-T will auto reconnect to either 115V or 230V supplies.

ENGINE DRIVEN GENERATOR

For use on engine drives, keep in mind the above input draw restrictions and the following precaution.

The Invertec V160-T can be operated on engine driven generators as long as the 230 volt auxiliary meets the following conditions:

- The AC waveform peak voltage is below 400 volts*.
- The AC waveform frequency is between 45 and 65Hz.
- The RMS voltage of the AC waveform is always greater than 208VAC *.

* for 115 VAC input divide these values in half.

The following Lincoln engine drives meet these conditions when run in the high idle mode:

- Ranger 250,305
- Commander 300, 400, & 500

Many engine drives do not meet these conditions (eg Miller Bobcats, etc). Operation of the Invertec V160-T is not recommended on engine drives not conforming to these conditions. Such combinations may overvoltage the Invertec V160-T power source.

OUTPUT CONNECTIONS

⚠ WARNING



ELECTRIC SHOCK can kill.

- **Keep the electrode holder, TIG torch and cables insulation in good condition and in place.**
- **Do not touch electrically live parts or electrode with skin or wet clothing.**
- **Insulate yourself from work and ground.**
- **Turn the input line Switch on the Invertec V160-T “off” before connecting or disconnecting output cables or other equipment.**

OUTPUT AND GAS CONNECTION FOR TIG WELDING (FIGURE A.1)

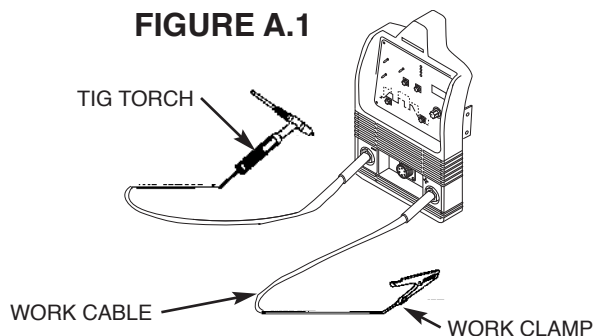

This unit does not include a TIG torch, but one may be purchased separately. The Lincoln PTA-9 (K1781-1 or K1781-3 only with no gas valve) or PTA-17 (K1782-1 or K1782-3) are recommended for use with this machine for this purpose; however, any similar TIG torch can be used. To attach the Twist-Mate Plug to a Lincoln Torch, slide the rubber boot onto the torch cable (enlarge the boot opening if necessary), screw the fitting on the torch cable into the brass connector snugly and slide the boot back over the brass connector. (See Figure A.1a)

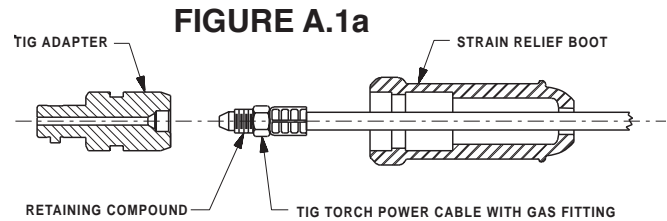

The ground lead and TIG Torch Twist Mate® Connector are supplied with the welder. To connect the cables, turn the Power Switch “OFF”. Connect the torch Twist Mate plug into the DC(-) Electrode/Gas Output Receptacle on the front of the welder and turn it clockwise until tight.

WORK CABLE CONNECTION

Next, connect the work cable to the “+” output terminal in the same way.

To minimize high frequency interference, refer to **Machine Grounding and High Frequency Interference Protection** section of this manual for the proper procedure on grounding the work clamp and work piece.

OUTPUT CONNECTION FOR STICK WELDING (FIGURE A.2)

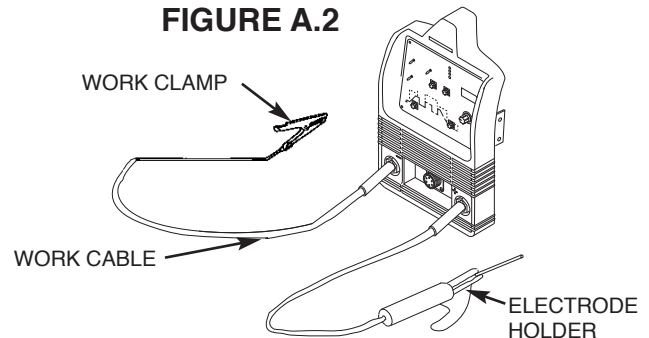

First determine the proper electrode polarity for the electrode to be used. Consult the electrode data for this information. Then connect the output cables to the output terminals corresponding to this polarity. For instance, for DC(+) welding, connect the electrode cable (which is connected to the electrode holder) to the “+” output terminal and the work cable (which is connected to the work clamp) to the “-” output terminal. Insert the connector with the key lining up with the keyway, and rotate approximately 1/4 turn clockwise; until the connection is snug. Do not over tighten.

QUICK DISCONNECT PLUG (FOR STICK ELECTRODE CABLE)

A quick disconnect system is used for the welding cable connections. The stick electrode cable will need to have a plug attached.

1. Cut off welding cable lug, if present.
2. Remove .75 in. (19mm) of welding cable insulation.
3. Slide rubber boot onto cable end. The boot end may be trimmed to match the cable diameter. Use soap or other nonpetroleum-based lubricant to help slide the boot over the cable, if needed.

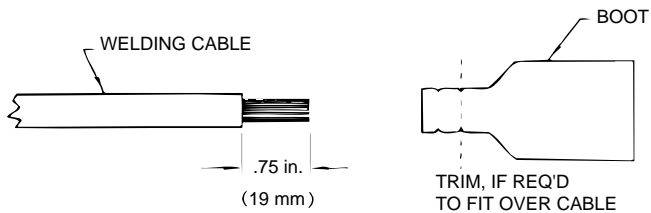

4. Cut 45-50% of the copper strands back 1/4" (6 mm).

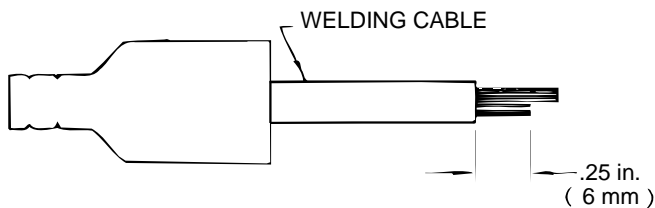

5. Fold copper strands over cut strands and insert into ferrule.

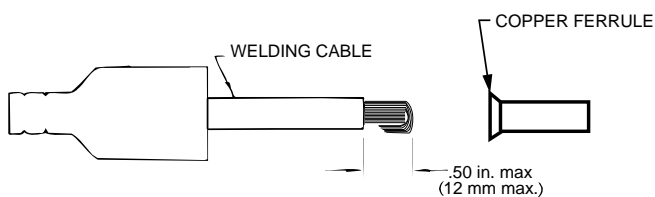

6. Slide the copper ferrule into the brass plug.
7. Tighten set screw to collapse copper tube. Screw must apply pressure against welding cable. The top of the set screw will be well below the surface of the brass plug after tightening.

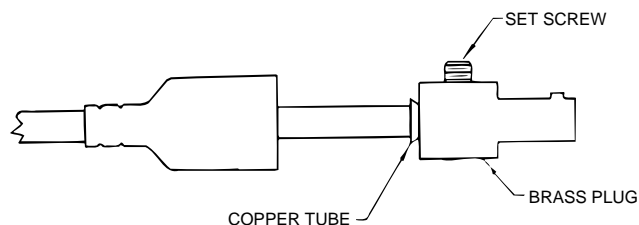

8. Slide rubber boot over brass plug. The rubber boot must be positioned to completely cover all electrical surfaces after the plug is locked into the receptacle.

SHIELDING GAS CONNECTION

Obtain the necessary inert shielding gas. Connect the cylinder of gas with a pressure regulator and flow gage. Install a gas hose between the regulator and gas inlet (located on the rear of the welder). The gas inlet has a 5/16-18 right hand female thread; CGA #032.

⚠ WARNING

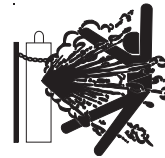

CYLINDER could explode if damaged.

•Keep cylinder upright and chained to a support.

•Keep cylinder away from areas where it could be damaged.

•Never allow the torch to touch the cylinder.

•Keep cylinder away from live electrical circuits.

REMOTE CONTROL CONNECTION

A remote control receptacle is provided on the lower center case front of the welder for connecting a remote control to the machine. Refer to the Optional Accessories section of this manual for available remote controls.

The following items can be connected to the 6 pin socket on the front panel:

- Remote control potentiometer (K857) for Stick welding.
- Remote Foot Amptrol (K870), Hand Amptrol (K963-3).
- Arc Start Switch (K814).

Read and understand this entire section before operating your machine.

SAFETY INSTRUCTIONS

WARNING



ELECTRIC SHOCK can kill.

- Do not touch electrically live parts such as output terminals or internal wiring.
- Insulate yourself from the work and ground.
- Always wear dry insulating gloves.



FUMES AND GASES can be dangerous.

- Keep your head out of fumes.
- Use ventilation or exhaust to remove fumes from breathing zone.



WELDING, CUTTING and GOUGING SPARKS can cause fire or explosion

- Keep flammable material away.
- Do not weld, cut or gouge on containers that have held combustibles.



ARC RAYS can burn.

- Wear eye, ear and body protection.

Only qualified personnel should operate this equipment. Observe all safety information throughout this manual.

GENERAL DESCRIPTION

The Invertec V160-T is an industrial 160 amp arc welding power source which utilizes single phase input power, to produce constant current output. The welding response of this Invertec has been optimized for stick (SMAW) and TIG (GTAW). The unit is ideal for industrial applications where portability is important.

The Invertec V160-T performs DC TIG with high frequency or Touch Start Tig Starting with excellent results.

WELDING CAPABILITY

The Invertec V160-T is rated at 160 amps, 26.4 volts, at 35% duty cycle on a ten minute basis. It is capable of higher duty cycles at lower output currents. It is capable of 130 amps, 25.2 volts at 100% duty cycle⁽¹⁾. If the duty cycle is exceeded, a thermal protector will shut off the output until the machine cools. See Technical Specifications in A-1 for other rated outputs.

The Invertec V160-T is recommended for stick welding with such popular electrodes as Fleetweld® 35, Fleetweld 37, Fleetweld 180 and Jet-LH 78 MR.

LIMITATIONS

The V160-T is not recommended for pipe thawing.

⁽¹⁾When connected to 230VAC inputs.

REAR CONTROL PANEL

1. **Power Switch:** Controls the input power to the machine. Make sure the machine is properly connected to the input supply before turning the machine on.(See Figure B.1)
2. **Fan:** The cooling fan will turn ON when the machine is turned ON and it will continue to run whenever the output of the machine is ON. If the output of the machine is OFF for more than five minutes, the fan will turn OFF. This reduces the amount of dirt that is deposited inside the machine and reduces power consumption.(See Figure B.1)

Refer to the Output LED section below for more information about conditions when the output of the machine is ON.

3. **Gas Inlet:** Connector for the TIG shielding gas. The gas source must have a pressure regulator and flow gage installed.(See Figure B.1)

CONTROLS AND SETTINGS (See Figure B.2)

4. **Mode Switch:** This switch changes the welding modes of the machine. The V160-T has three welding modes: **Stick** (SMAW), **Lift TIG** (GTAW) and **HF TIG** (GTAW).

When the mode switch is in the Stick position, the following welding features are enabled:

- **Hot Start:** This is a temporary increase in the output current during the start of the stick welding process. This helps ignite the arc quickly and reliably.
- **Arc Force:** This is a temporary increase in the output current during normal stick welding. This temporary increase in output current is used to clear intermittent connections between the electrode and the weld puddle that occur during normal stick welding.
- **Anti-Sticking:** This is a function which decreases the output current of the machine to a low level when the operator makes an error and sticks the electrode to the work piece. This decrease in current allows the operator to remove the electrode from the electrode holder without creating large sparks which can damage the electrode holder.

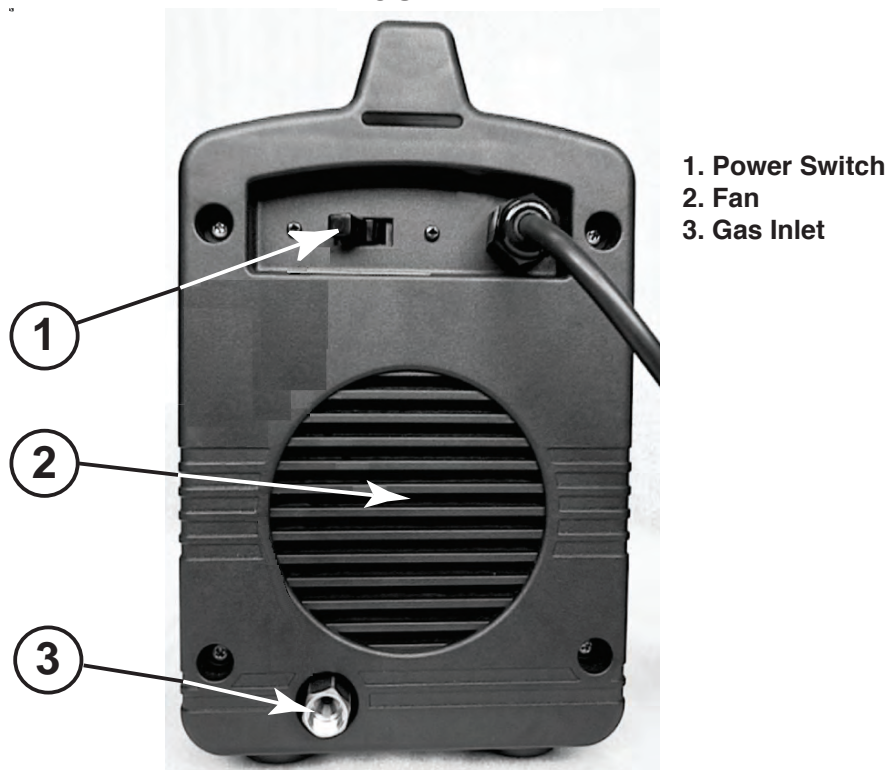
FIGURE B.1

V160-T

LINCOLN
ELECTRIC

When the mode switch is in the **Lift TIG** position, the stick welding functions are disabled and the machine is ready for **Lift TIG** welding. **Lift TIG** is a method of starting a TIG weld by first pressing the TIG torch electrode on the work piece in order to create a low current short circuit. Then, the electrode is lifted from the work piece to start the TIG arc. After machine output is triggered ON, with an Arc Start Switch or Foot Amptrol the arc must be started within 6.5 seconds or output will turn OFF and trigger sequence must be restarted.

When the mode switch is in the **HF TIG** position, the stick welding functions are disabled and the machine is ready for **HF TIG** welding. During the **HF TIG** mode, the TIG arc is started by HF without pressing the electrode on the work piece. After triggering output ON, the HF (and output) used for starting the TIG arc will remain ON for 6.5 seconds. If the arc is not started in this time limit, the trigger sequence must be restarted.

5. Trigger Mode Switch: This switch changes between 2-step and 4-step trigger sequences. For an explanation of these trigger sequences refer to the Trigger Mode Sequences following Controls and Settings.

6. Power LED: This indicator will blink on and off when the machine is first turned on. After approximately 2 seconds it will stop blinking and remain on to signal that the machine is ready. The indicator will also blink during over current conditions when operating on 115V input.

7. Thermal LED: This indicator will turn on when the machine is overheated and the output has been disabled. This normally occurs when the duty cycle of the machine has been exceeded.

FIGURE B.2

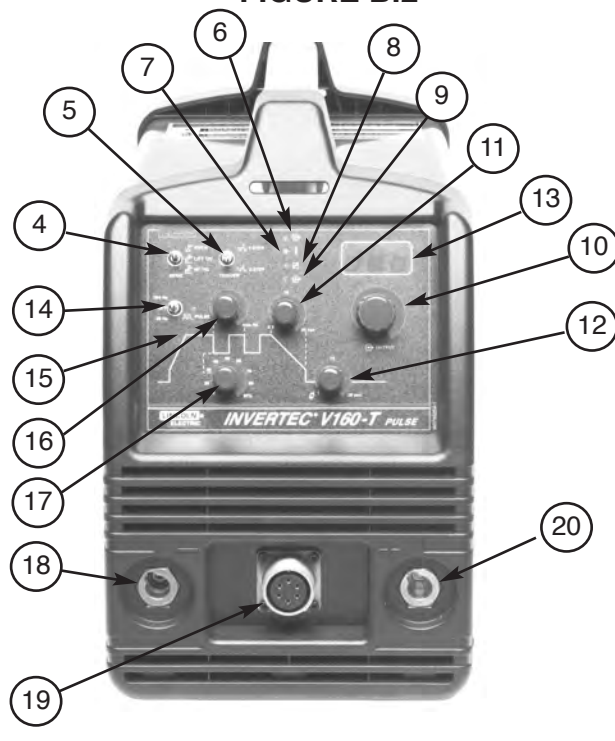

- 4. Mode Switch
- 5. Trigger Mode Switch
- 6. Power LED
- 7. Thermal LED
- 8. Remote LED
- 9. Output LED
- 10. Output Current Control
- 11. Downslope Control
- 12. Postflow Control
- 13. Digital Display

- 14. Pulse Mode Switch
- 15. Pulse LED
- 16. Pulse Frequency Control
- 17. Background Current Control
- 18. Electrode Connection (Negative)
- 19. Remote Control Connector
- 20. Electrode Connection (Positive)

Leave the machine on to allow the internal components to cool. When the indicator turns off, normal operation is again possible.

8. Remote LED: This indicator will turn ON when a remote control is connected to the machine via the remote control connector. Using a remote control will change the function of the output current control., refer to the output current control section below. (Note: When K814 Arc Start Switch is connected to remote connector, remote LED will remain OFF).

9. Output LED: This indicator turns on when the output of the machine is on.

- In the stick welding mode, the output of the machine is automatically turned ON.
- For both of the TIG welding modes, the output of the machine is turned ON and OFF by an Arc Start Switch or Hand/Foot Amptrol attached to the Remote Control Connector. (See #4 - Mode Switch - above for details on output triggering for TIG arc starting).

10. Output Current Control: This controls the output or welding current of the machine.

The function of this control knob is changed if a remote control is connected. If the Remote LED is ON, this indicates that a remote control is connected and the function of the output current control will be:

- Stick Welding Mode: The remote control will adjust the output current of the machine from 5 to 160A. The output current control knob on the display panel is not used.
- TIG Welding Modes: The maximum output current of the machine is set by the output current control knob. The remote control then adjusts the output current from the minimum output (5A) to the value set by the output current control knob. For example, if the output current control knob on the machine is set to 100A then the remote control will adjust the output current from a minimum of 5A to a maximum of 100A.

11. Downslope Control: In the TIG welding modes, this control knob will adjust the downslope time from 0.5 to 20 seconds. (The default upslope time is 0.5 seconds.) Refer to the trigger sequence section below to understand how downslope is activated. In Stick welding mode, this function is not used.

V160-T

LINCOLN
ELECTRIC

12. Postflow Control: In the TIG welding modes, this control knob will adjust the shielding gas postflow time from 0.5 to 30 seconds. (The preflow time is always 0.5 seconds.) In Stick welding mode, this function is not used.

13. Digital Display: This meter displays the preset welding current before welding and the actual welding current during welding. Like the output current control, the function of the meter is changed if a remote control is connected.

14. Pulsing Mode Switch: In the TIG welding modes, this switch turns the pulsing function ON and controls the pulsing frequency range (20Hz or 300Hz). In Stick welding mode, this function is not used.

15. Pulsing LED: This indicator shows the pulsing frequency when pulsing is turned ON. With this indication, the operator can adjust the frequency to the desired value before welding. (Note: At higher frequencies the LED blinks very fast and seems to be continuously ON however it is pulsing.) If pulsing is turned OFF or if the machine is in Stick welding mode, the indicator will be OFF.

16. Pulsing Frequency Control: When the pulsing function is ON, this control knob will adjust the pulsing frequency. The pulsing frequency adjustment range is 0.2 - 20Hz or 3 - 300Hz depending on the Pulsing Mode Switch position.

17. Background Current Control: When the pulsing function is ON, this control knob will adjust the pulsing background current. This is the current during the low portion of the pulse waveform; it can be adjusted from 10% to 90% of the welding current.

TRIGGER MODE SEQUENCES

For the V160-T, TIG welding can be done in either the 2-step or 4-step mode which is selected with the Trigger Mode Switch. DIP Switch functions are set by the factory. For adjustments on DIP Switch settings and functions see DIP SWITCH FUNCTIONS in this Operations Section.

2-Step Sequence

Note: 2-Step works with either an Arc Start Switch (for output triggering only, current control is at machine) or with a Foot or Hand Amptrol™ (for both remote output triggering and current control). 2-Step used with Arc Start Switch is referenced in following sequence.

1. Press and hold the Arc Start Switch to start the sequence.

The machine will open the gas valve to start the flow of the shielding gas. After a 0.5 second preflow time to purge air from the torch hose, the output of the machine is turned ON. At this time the arc can be started.

After the arc is started the output current will be increased to the welding current. The time for this increase or upslope is presettable. The default is 0.5 seconds.

2. Release the Arc Start Switch to stop welding.

The machine will now decrease the output current at a controlled rate or downslope time, until the Start/Crater current is reached and the output of the machine is turned OFF. The downslope time is adjusted by the Downslope Parameter.

After the arc is turned OFF, the gas valve will remain open to continue the flow of the shielding gas to the hot electrode and work piece. The duration of this postflow shielding gas is adjusted by the Postflow Parameter. This operation is shown in (2 step diagram 1).

2 Step Diagram 1

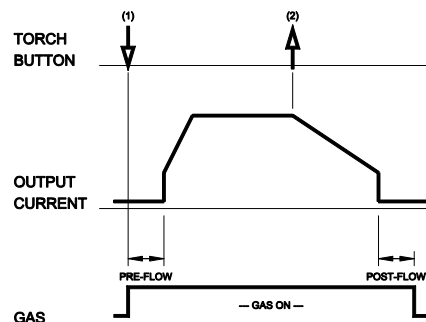

Possible variations of this standard sequence is shown below. It is possible to press and hold the TIG torch trigger a second time during downslope to restart. After the trigger is pressed the output current will increase to the welding current. This operation is shown in (2 step diagram 2).

2 Step Diagram 2

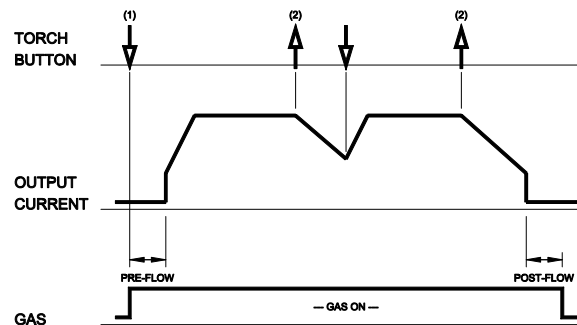

4-Step Sequence

Note: 4-Step works with Arc Start Switch only. Amptrol™ type devices will not work properly and should not be used. The Arc Start Switch's actuator is also referred to as the "Tig torch trigger" in the following sequence.

1. Press and hold the Arc Start Switch to start the sequence. The machine will open the gas valve to start the flow of the shielding gas. After 0.5 second preflow time to purge air from the torch hose, the output of the machine is turned ON. At this time the arc can be started. After the arc is started the output current will be at the Start/Finish current. This condition can be maintained as long or as short as necessary.

If the Start/Finish current is not necessary, do not hold the TIG torch trigger as described at the beginning of this step. Instead, quickly press and release the trigger. In this condition, the machine will automatically pass from Step 1 to Step 2 when the arc is started.

2. Release the TIG torch trigger to start the main part of the weld.

The output current will increase to the welding current. The time for this increase or upslope is presettable. The default is 0.5 seconds.

3. Press and hold the TIG torch trigger when the main part of the weld is complete.

The machine will now decrease the output current at a controlled rate or downslope time, until the Start/Finish current is reached. The downslope time is adjusted by the Downslope Parameter. This Start/Finish current can be maintained as long or as short as necessary.

4. Release the TIG torch trigger.

The output current of the machine will turn OFF and the gas valve will remain open to continue the flow of the shielding gas. The duration of this postflow time is adjusted by the Postflow control knob. This operation is shown in (4 step diagram 1).

Possible variations of this standard sequence are shown below. It is possible to press and hold the TIG torch trigger another time to end the downslope time and maintain the output current at the Start/Finish current. When the TIG torch trigger is released the output will turn OFF and postflow will begin. This operation shown in (4 step diagram 2).

4 Step Diagram 2

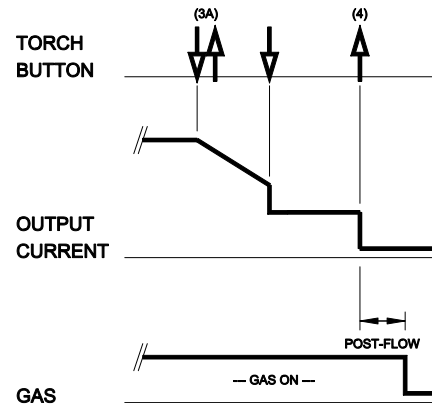

4 Step Diagram 1

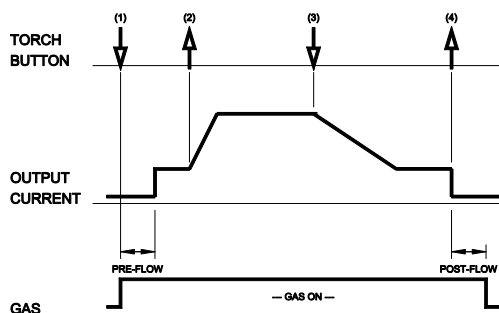

V160-T

LINCOLN
ELECTRIC

DIP SWITCH FUNCTIONS

The following sections explain the 8 DIP switch functions of the V160. Read and understand the functions before making any changes because abnormal operation can occur with the wrong settings. The machine must be turned OFF when the DIP Switches are changed.

WARNING



ELECTRIC SHOCK CAN KILL:

Be sure that all installation, operation, maintenance and repair procedures are performed only by qualified individuals. Lincoln Electric is not responsible for damages caused by improper installation, improper care or abnormal operation.

Before opening the machine to make changes to the DIP Switches it must first be turned OFF and disconnected from the input source. Do not open the machine or change the DIP Switches with power applied to the machine. Only Lincoln trained service technicians are authorized to perform these modifications.

The DIP switches are numbered from 1 to 8 shown in Figure B.3. Switch 1 is on the bottom and switch 8 is on the top. When a switch is pushed to the right (or to the back of the machine) it is ON; when it is pushed to the left (or to the front of the machine) it is OFF.

The standard production settings for the V160-T are shown with in bold letters **OFF** Table B.1. If a switch setting has bold letters **OFF**, do not make any changes; abnormal operation could occur.

TABLE B.1

DIP Switch	V160-T CE	V160-T Pulse CE	V160-T USA
1	OFF	OFF	OFF
2	OFF	OFF	OFF
3	OFF	OFF	ON
4	ON	ON	OFF
5	OFF	OFF	OFF
6	OFF	OFF	ON
7	OFF	OFF	OFF
8	OFF	OFF	OFF

DIP Switch 1: Machine Type

This controls the output of the V160-T and some welding waveform functions. It configures the V160-T to automatically turn OFF depending on the position of the Welding Mode switch. Refer to DIP Switch 6 for more information.

DIP Switch 2: Preflow Timer

This controls the preflow timer for TIG welding (used only on "T" type machines). When the DIP switch is OFF the preflow time is 0.5 seconds. When it is ON the preflow time is 0.1 seconds.

FIGURE B.3

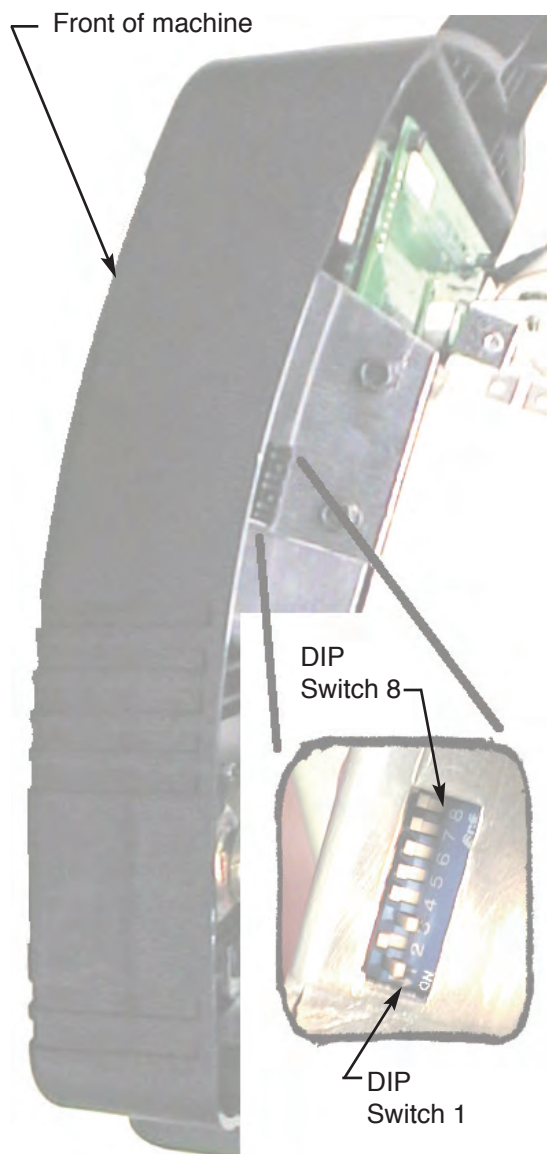

DIP Switch 3: 2 Step Restart Enable

This controls the 2 Step Restart function. When the switch is ON the 2 Step Restart function is enabled.

2-Step Restart Disabled (DIP Switch 3 = OFF)

1. Press and hold the TIG torch trigger to start the sequence. The machine will open the gas valve to start the flow of the shielding gas. After the preflow time, the output of the machine is turned ON. At this time the arc is started according to the selected welding mode (Lift TIG or HF TIG). After the arc is started the output current will be increased (upslope) to the welding current.
2. Release the TIG torch trigger to stop welding. The machine will now decrease the output current at a controlled rate (downslope), until the Start/Crater current is reached and the output of the machine is turned OFF. After the arc is turned OFF, the gas valve will remain open for the duration of the post-flow time.

FIGURE B.4

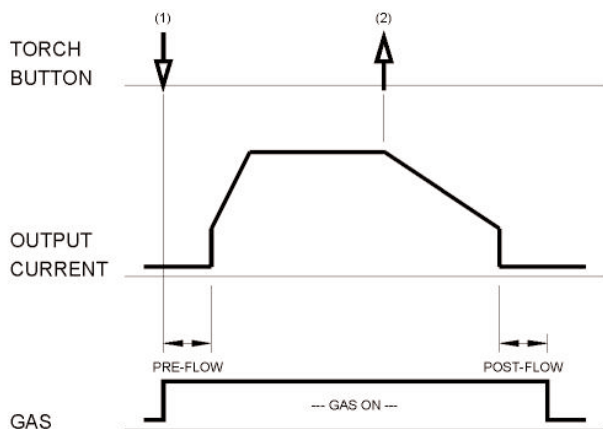

As shown in figure B.5, it is also possible to press and hold the TIG torch trigger a second time during downslope to end the downslope time and maintain the output current at the Start/Crater current. When the TIG torch trigger is released the output will turn OFF and the postflow time will start.

FIGURE B.5

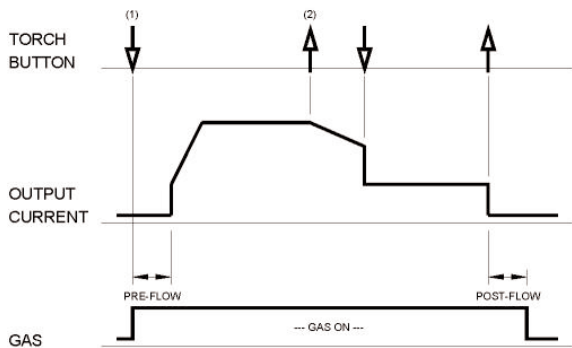

2-Step Restart Enabled (DIP Switch 3 = ON)

Same as step 1.

Same as step 2.

As shown in figure B.6, it is possible to press and hold the TIG torch trigger a second time during downslope to restart. After the trigger is pressed the output current will increase to the welding current, like in step 1. When the main part of the weld is complete go to the beginning of step 2. **FIGURE B.6**

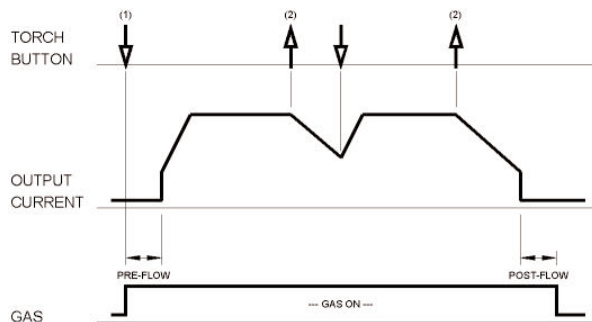

DIP Switch 4: 4 Step Restart Enable

This controls the 4 Step Restart function. When the switch is ON the 4 Step Restart function is enabled. ("Foot pedal" remote controls should never be used with the 4 step sequences.)

4-Step Restart Disabled (DIP Switch 4 = OFF)

1. Press and hold the TIG torch trigger to start the sequence. The machine will open the gas valve to start the flow of the shielding gas. After the preflow time, the output of the machine is turned ON. At this time the arc is started according to the selected welding mode (Lift TIG or HF TIG). After the arc is started the output current will be at the Start/Crater current. This condition can be maintained as long or as short as necessary.

FIGURE B.7

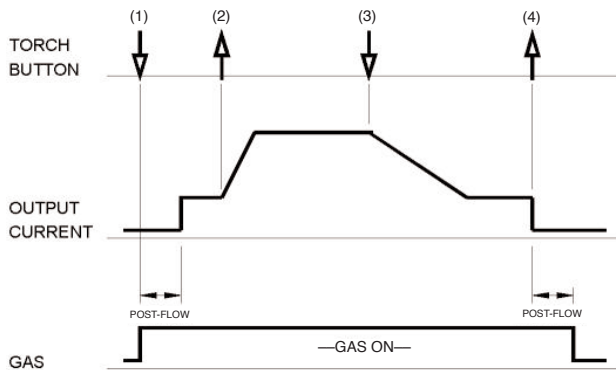

If the Start/Crater current is not necessary, do not hold the TIG torch trigger as described at the beginning of this step. Instead, quickly press and release it. In this condition, the machine will automatically pass from Step 1 to Step 2 when the arc is started.

2. Release the TIG torch trigger to start the main part of the weld. The output current will be increased (upslope) to the welding current.
3. Press and hold the TIG torch trigger when the main part of the weld is complete. The machine will now decrease the output current at a controlled rate (downslope), until the Start/Crater current is reached. This Start/Crater current can be maintained as long or as short as necessary.
- 3A. If it is not necessary to maintain the Start/Crater current, the TIG torch trigger can be pressed and released instead of holding it. In this case, step 4 will automatically follow.

4. Release the TIG torch trigger. The output current of the machine will turn OFF and the gas valve will remain open for the duration of the postflow time.

As shown in figure B.8, after the TIG torch trigger is quickly pressed and released from step 3A, it is possible to press and hold the TIG torch trigger another time to end the downslope time and maintain the output current at the Start/Crater current. When the TIG torch trigger is released the output will turn OFF and postflow will begin.

FIGURE B.8

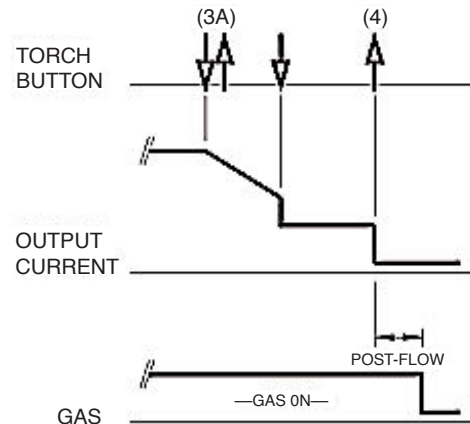

As shown in figure B.9, again after the TIG torch trigger is quickly pressed and released from step 3A, it is possible to quickly press and release the TIG torch trigger a second time to end the downslope time and stop welding.

FIGURE B.9

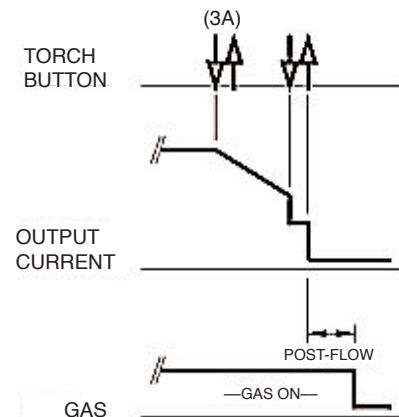

4-Step Restart Enabled (DIP Switch 4 = ON)

Same as step 1.

Same as step 2.

- Press and hold the TIG torch trigger when the main part of the weld is complete. The machine will now decrease the output current at a controlled rate (downslope), until the Start/Crater current is reached. This Start/Crater current can be maintained as long or as short as necessary.

FIGURE B.10

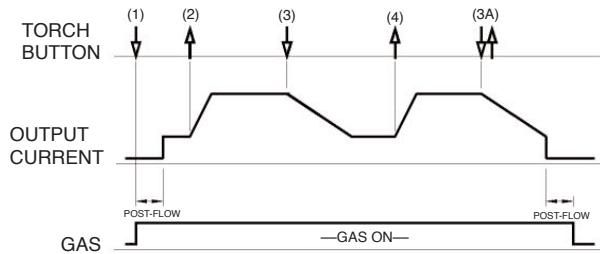

This sequence has an automatic restart so welding will continue after this step. If the weld is completely finished, use the following sequence instead of step 3 described above.

- Quickly press and release the TIG torch trigger. The machine will now decrease the output current at a controlled rate (downslope), until the Start/Crater current is reached and the output of the machine is turned OFF. After the arc is turned OFF the postflow time will start.
- Release the TIG torch trigger. The output current will again increase (upslope) to the welding current, like in step 2, to continue welding. When the main part of the weld is complete go to step 3.

As shown in figure B.11, after the TIG torch trigger is quickly pressed and released from step 3A, it is possible to press and hold the TIG torch trigger another time to end the downslope time and maintain the output current at the Start/Crater current. When the TIG torch trigger is released the output will again increase (upslope) to the welding current, like in step 4, to continue welding. When the main part of the weld is complete go to step 3.

FIGURE B.11

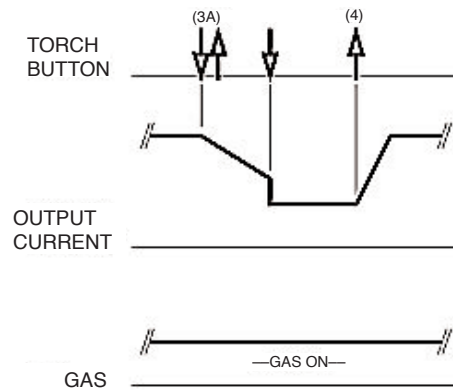

As shown in figure B.12, again after the TIG torch trigger is quickly pressed and released from step 3A, it is possible to quickly press and release the TIG torch trigger a second time to end the downslope time and stop welding.

FIGURE B.12

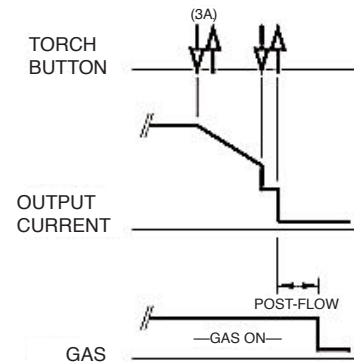

DIP Switch 5: Low OCV Enable

This controls the OCV of the machine. When the DIP switch is OFF the OCV is set to the normal level as stated in the manuals for the machines. When the DIP switch is ON the OCV is reduced to 20V. This low OCV mode was created for the Australian markets and should only be used as required by these Australian specifications. The low OCV will somewhat reduce the starting performance of the machine when dirt, rust, and/or slag is present on the work piece.

DIP Switch 6: European/USA Machine Configuration

This configures several functions of the V160 as required by the European and USA markets. For the European market it is OFF and for the USA market it is ON.

Specifically, this configures the operation of the TIG slope timers, remote control, and trigger. However, this configuration also depends on the position of DIP Switch 1 which selects the machine type. This setting can be changed but only if the following functions are clearly understood.

(DIP Switch 1 = OFF)

In TIG welding mode, the following conditions can exist.

- European Machine Configuration (DIP Switch 6 = OFF)

The TIG slope functions are always enabled. After the arc is started the output current will be increased (upslope) to the welding current. At the end of the weld the current will be decreased with the downslope function. Using a "foot pedal" remote control is not recommended with this setup.

A trigger is always needed to turn ON the output of the machine.

- USA Machine Configuration (DIP Switch 6 = ON)
The TIG slope functions depends on the possible connection of a remote control.
- No remote control connected. The TIG slope functions are enabled. After the arc is started the output current will be increased (upslope) to the welding current. At the end of the weld the current will be decreased with the downslope function.

- Remote control connected. The TIG slope functions are disabled for the 2 step trigger mode. If slopes are needed a foot pedal remote control can be used. The TIG slope functions are enabled for the 4 step trigger mode.

A trigger is always needed to turn ON the output of the machine.

DIP Switch 7 & 8: Upslope Timer

These control the upslope timer for TIG welding (used only on "T" type machines). The following table shows the DIP Switch settings and selected upslope time.

DIP Switch 7	DIP Switch 8	Upslope Time
ON	ON	0.1 seconds
OFF	OFF	0.5 seconds
ON	OFF	1 second
OFF	ON	4 seconds

Start/Crater Current Adjustment

The start/crater current of a "T" type machine can be changed if necessary. The values are set from the factory.

European Machines:

20% (160A welding current = 32A start/crater current)

USA Machines:

10% (160A welding current = 16A start/crater current)

WARNING

Be sure that all installation, operation, maintenance and repair procedures are performed only by qualified individuals. Lincoln Electric is not responsible for damages caused by improper installation, improper care or abnormal operation.

This adjustment procedure must be performed only by Lincoln trained service technicians. The machine will be operating with the cover removed where it is possible to come in contact with high voltages. Read all the following instructions before starting the procedure.



ELECTRIC SHOCK CAN KILL:

- Welding equipment generates high voltages.
- Do not touch the live parts of the machine, the electrode, the work clamp, or connected work pieces when this equipment is on.
- Insulate yourself from live electrical connections, the electrode, the work clamp, and the connected work pieces.

1. Remove the cover of the machine to access the control Printed Circuit Boards on the case front.

2. To adjust the start/crater current, output current from the machine must flow through a load bank or a TIG arc. Connect the necessary equipment. In both cases, load bank or TIG arc, a trigger must be connected to the machine. If a load bank is used, it must be setup for 160A and approximately 25V.
3. Make sure all electrical connections are free from contact with other parts of the machine. Reconnect the case back if necessary. Turn ON the machine.
4. On the control panel of the machine, select the following:
 - Mode Switch: LIFT TIG (Do not use HF TIG or damage to measuring equipment will occur.)
 - Trigger Mode: 4 Step
 - Pulsing: OFF
 - Output Current: Maximum (160A)
5. Activate the trigger of the machine to achieve the start or crater current portion of the welding sequence. Refer to the trigger sequences explained above if more information is needed.
6. In this condition, measure the output current of the machine and adjust the start/crater current as necessary. The calibration trimmer for the start/crater current is located on the left side of the machine (as viewed from the front) on the display board. The access hole for this trimmer is the higher one on the display board. (Do not adjust the lower trimmer on the display board; this is the output current calibration.)

The output current is set to 160A, therefore the start/crater current calibration will be a percentage of this 160A setting. Use the following equation for determining the desired start/crater current calibration:

Desired start/crater current percentage multiplied by 160 = calibration current.

For example, to calibrate the machine for 15% start/crater current, multiply this by 160 to get the calibration current ($0.15 \times 160 = 24$).

7. Release the trigger to turn off the output of the machine. Turn OFF the machine and disconnect it from the input source. Reassemble the machine making sure the ground wire to the cover is connected.

V160-T



OPTIONAL ACCESSORIES AND COMPATIBLE EQUIPMENT

Factory Installed

1-Twist-Mate Torch Connector (W/Gas Pass Through)
1- Ground Lead and Plug Assembly
Strap Packet
Instruction Manual

Field Installed

K870 - Foot Amptrol™ for TIG welding. When the V160-T's Output Control is in the "REMOTE" position, the foot Amptrol energizes the output and controls the output remotely. The Foot Amptrol connects directly to the 6 pin Amphenol.

K963-3 - Hand Amptrol™ for TIG welding. When the V160-T's Output Control is in the "Remote" position, the hand Amptrol energizes the output and controls the output remotely. The Hand Amptrol connects directly to the 6 pin Amphenol.

K814 - Arc Start Switch - Energizes the output for TIG welding if remote output control of the amperage is not desired. It allows on/off TIG welding at the current set by the Current Control on the control panel. When using the Arc Start Switch set the Output Control to the "LOCAL" position.

Magnum® PTA-9 and PTA-17 TIG Torches - The following standard Magnum® TIG torches with one-piece cable may be used with the Invertec V160-T.

• K1781-1	PTA-9	12.5 ft	medium back cap
• K1781-3	PTA-9	25 ft	medium back cap
• K1782-1	PTA-17	12.5 ft	long back cap
• K1782-3	PTA-17	25 ft	long back cap

NOTE: Each torch requires a Twist-Mate adapter,(one is included with the machine). Collets, collet bodies, and nozzles are not included and must be ordered separately.

CABLE PLUGS

K852-50 - Cable Plug Kit for 1/0-2/0 cable. Attaches to welding cable to provide quick disconnect from machine.

Twist-Mate Torch Adapter K1622-1 - One is shipped with the welder to connect the Magnum PTA-9 torch. If you do not care to interchange this part between torches (one is required to connect Magnum PTA-9 or PTA-17 TIG torches with one-piece cable to the V160-T) you may order an additional adapters. The quick connect plug provides connection for both gas and welding current.

TIG Torch Parts Kits - Parts kits are available for the PTA-9 and PTA-17 TIG torches. These kits include back cap, collets, collet bodies, nozzles and tungstens.

Order KP507 for PTA-9 torches

Order KP508 for PTA-17 torches

See publication E12.150 for parts kits breakdown.

Cut Length Consumables - TIG welding filler metals are available for welding stainless steel, mild steel, aluminum and copper alloys. See publication C9.10.

V160-T



SAFETY PRECAUTIONS



WARNING



ELECTRIC SHOCK can kill.

- Have an electrician install and service this equipment.
- Turn the input power off at the fuse box, disconnect supply lines and allow machine to sit for five minutes minimum to allow the power capacitors to discharge before working inside this equipment.
- Do not touch electrically live parts.



CAUTION

- Disconnect the power supply before every operation.
- Always use gloves in compliance with the safety standards.

INPUT FILTER CAPACITOR DISCHARGE PROCEDURE



WARNING

The machine has internal capacitors which are charged to a high voltage during power-on conditions. This voltage is dangerous and must be discharged before the machine can be serviced. Discharging is done automatically by the machine each time the power is switched off. However, you must allow the machine to sit for at least 5 minutes to allow time for the process to take place.

ROUTINE MAINTENANCE

Prevent metal powder from accumulating near the Heat Sink fins.



WARNING

- Disconnect the power supply before every operation.

Carry out the following periodic controls on the power source:

- Clean the power source inside by means of low-pressure compressed air.
- Check the electric connections and all the connection cables.

V160-T



HOW TO USE TROUBLESHOOTING GUIDE

WARNING

Service and Repair should only be performed by Lincoln Electric Factory Trained Personnel. Unauthorized repairs performed on this equipment may result in danger to the technician and machine operator and will invalidate your factory warranty. For your safety and to avoid Electrical Shock, please observe all safety notes and precautions detailed throughout this manual.

This Troubleshooting Guide is provided to help you locate and repair possible machine malfunctions. Simply follow the three-step procedure listed below.

Step 1. LOCATE PROBLEM (SYMPTOM).

Look under the column labeled “PROBLEM (SYMPTOMS)”. This column describes possible symptoms that the machine may exhibit. Find the listing that best describes the symptom that the machine is exhibiting.

Step 2. POSSIBLE CAUSE.

The second column labeled “POSSIBLE CAUSE” lists the obvious external possibilities that may contribute to the machine symptom.

Step 3. RECOMMENDED COURSE OF ACTION

This column provides a course of action for the Possible Cause, generally it states to contact your local Lincoln Authorized Field Service Facility.

If you do not understand or are unable to perform the Recommended Course of Action safely, contact your local Lincoln Authorized Field Service Facility.

CAUTION

If for any reason you do not understand the test procedures or are unable to perform the tests/repairs safely, contact your **Local Lincoln Authorized Field Service Facility** for technical troubleshooting assistance before you proceed.

V160-T



Observe all Safety Guidelines detailed throughout this manual

PROBLEMS (SYMPTOMS)	POSSIBLE CAUSE	RECOMMENDED COURSE OF ACTION
PROBLEMS IN STICK WELDING		
Excessive spatter	<ol style="list-style-type: none"> 1. Long arc 2. High current 	<p>If all recommended possible areas of misadjustment have been checked and the problem persists, Contact your local Lincoln Authorized Field Service Facility.</p>
Craters	<ol style="list-style-type: none"> 1. Fast movement of the electrode away from piece. 	
Inclusions	<ol style="list-style-type: none"> 1. Poor cleanliness or distribution of the Welding passes. 2. Improper movement of the electrode. 	
Insufficient penetration	<ol style="list-style-type: none"> 1. High progression speed. 2. Welding current too low. 3. Narrow chamfering. 	
Sticking	<ol style="list-style-type: none"> 1. Arc too short. 2. Current too low. 	
Porosity	<ol style="list-style-type: none"> 1. Humidity in electrode. 2. Long arc. 	
Cracks	<ol style="list-style-type: none"> 1. Current too high. 2. Dirty materials. 3. Hydrogen in weld (present on electrode coating). 	

Observe all Safety Guidelines detailed throughout this manual

PROBLEMS (SYMPTOMS)	POSSIBLE CAUSE	RECOMMENDED COURSE OF ACTION
PROBLEMS IN TIG WELDING		
Oxidation	<ol style="list-style-type: none"> 1. Insufficient gas. 2. No protection on the back side. 	<p>If all recommended possible areas of misadjustment have been checked and the problem persists, Contact your local Lincoln Authorized Field Service Facility.</p>
Tungsten inclusions	<ol style="list-style-type: none"> 1. Incorrect electrode sharpening. 2. Electrode too small. 3. Operating failure (contact of the tip with the workpiece). 	
Porosity	<ol style="list-style-type: none"> 1. Dirt on the edges. 2. Dirt on the filler material. 3. Excessive travel speed. 4. Current intensity too low. 	
Hot cracking	<ol style="list-style-type: none"> 1. Unsuitable filler material. 2. High heat supply. 3. Dirty materials. 	

V160-T



Observe all Safety Guidelines detailed throughout this manual

PROBLEMS (SYMPTOMS)	POSSIBLE CAUSE	RECOMMENDED COURSE OF ACTION
ELECTRICAL FAILURES		
Machine fails to come on (Power LED off)	<ol style="list-style-type: none"> 1. No Input Voltage. 2. Faulty supply plug or cable. 3. Internal fuse blown. 	<p>If all recommended possible areas of misadjustment have been checked and the problem persists, Contact your local Lincoln Authorized Field Service Facility.</p>
Power Input incorrect Input over-current (Power LED Flashing)	<ol style="list-style-type: none"> 1. Input voltage out of range (less than 95 or greater than 265VAC). 2. Input current too high due to operating beyond rated duty cycle. 	
No output current (Power LED on) (Output LED off)	<ol style="list-style-type: none"> 1. While in TIG mode, Trigger circuit not mode at 6 pin amphenol. 	
Thermal overload (Thermal LED on)	<ol style="list-style-type: none"> 1. Unit has been operated beyond its capacity rating. 2. Airflow through machine is restricted or fan has failed. 	

WIRING DIAGRAM CODE 10878

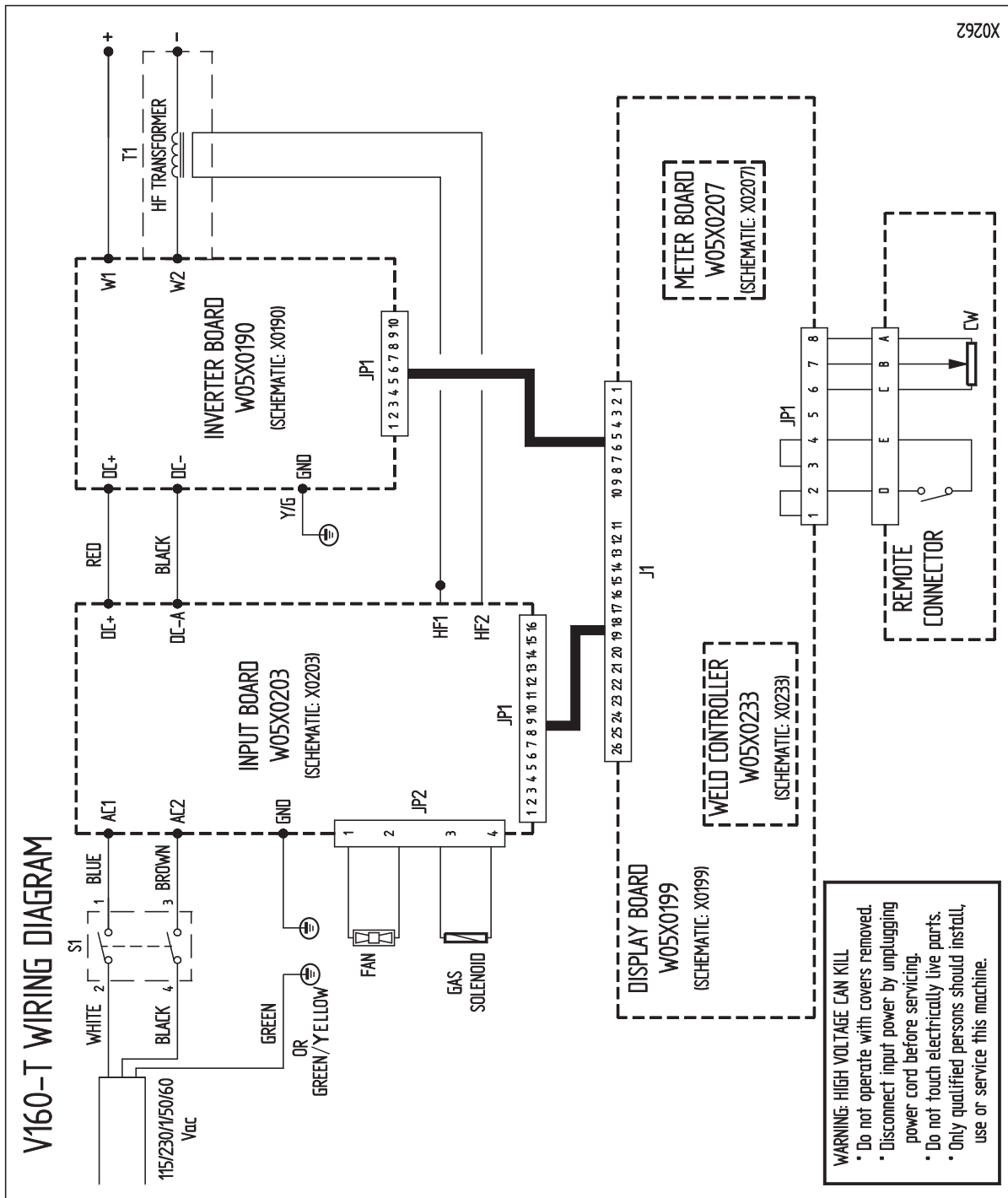

NOTE: This diagram is for reference only. It may not be accurate for all machines covered by this manual. The specific diagram for a particular code is pasted inside the machine on one of the enclosure panels. If the diagram is illegible, write to the Service Department for a replacement. Give the equipment code number.

WIRING DIAGRAM CODE 11032

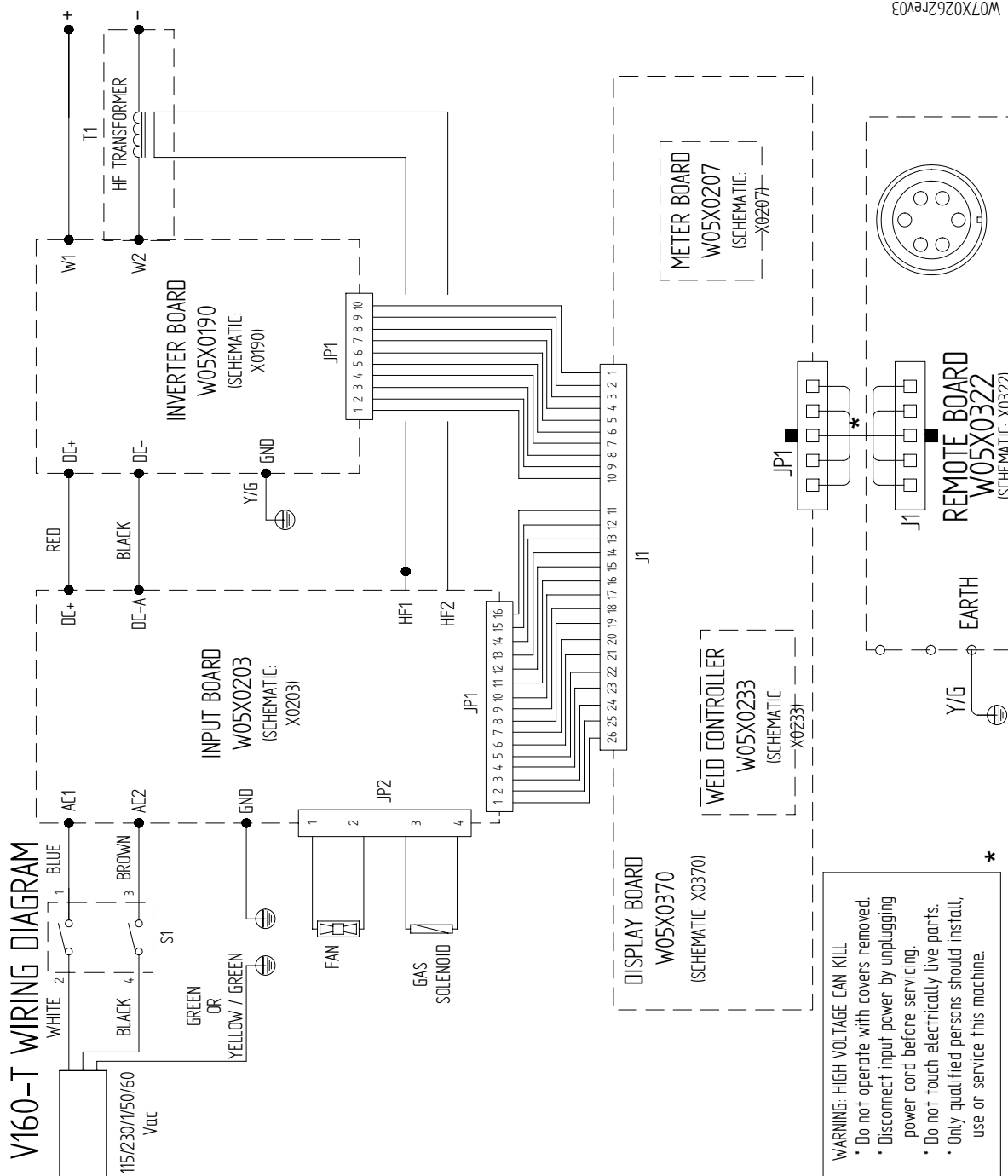

NOTE: This diagram is for reference only. It may not be accurate for all machines covered by this manual. The specific diagram for a particular code is pasted inside the machine on one of the enclosure panels. If the diagram is illegible, write to the Service Department for a replacement. Give the equipment code number.

NOTES

V160-T



			
WARNING	<ul style="list-style-type: none"> Do not touch electrically live parts or electrode with skin or wet clothing. Insulate yourself from work and ground. 	<ul style="list-style-type: none"> Keep flammable materials away. 	<ul style="list-style-type: none"> Wear eye, ear and body protection.
Spanish AVISO DE PRECAUCION	<ul style="list-style-type: none"> No toque las partes o los electrodos bajo carga con la piel o ropa mojada. Aíslese del trabajo y de la tierra. 	<ul style="list-style-type: none"> Mantenga el material combustible fuera del área de trabajo. 	<ul style="list-style-type: none"> Protéjase los ojos, los oídos y el cuerpo.
French ATTENTION	<ul style="list-style-type: none"> Ne laissez ni la peau ni des vêtements mouillés entrer en contact avec des pièces sous tension. Isolez-vous du travail et de la terre. 	<ul style="list-style-type: none"> Gardez à l'écart de tout matériel inflammable. 	<ul style="list-style-type: none"> Protégez vos yeux, vos oreilles et votre corps.
German WARNUNG	<ul style="list-style-type: none"> Berühren Sie keine stromführenden Teile oder Elektroden mit Ihrem Körper oder feuchter Kleidung! Isolieren Sie sich von den Elektroden und dem Erdboden! 	<ul style="list-style-type: none"> Entfernen Sie brennbares Material! 	<ul style="list-style-type: none"> Tragen Sie Augen-, Ohren- und Körperschutz!
Portuguese ATENÇÃO	<ul style="list-style-type: none"> Não toque partes elétricas e electrodos com a pele ou roupa molhada. Isole-se da peça e terra. 	<ul style="list-style-type: none"> Mantenha inflamáveis bem guardados. 	<ul style="list-style-type: none"> Use proteção para a vista, ouvido e corpo.
Japanese 注意事項	<ul style="list-style-type: none"> ● 通電中の電気部品、又は溶材にヒブやぬれた布で触れないこと。 ● 施工物やアースから身体が絶縁されている様にして下さい。 	<ul style="list-style-type: none"> ● 燃えやすいものの側での溶接作業は絶対にしてはなりません。 	<ul style="list-style-type: none"> ● 目、耳及び身体に保護具をして下さい。
Chinese 警告	<ul style="list-style-type: none"> ● 皮肤或湿衣物切勿接触带电部件及焊条。 ● 使你自己与地面和工件绝缘。 	<ul style="list-style-type: none"> ● 把一切易燃物品移离工作场所。 	<ul style="list-style-type: none"> ● 佩戴眼、耳及身体劳动保护用具。
Korean 위험	<ul style="list-style-type: none"> ● 전도체나 용접봉을 젖은 헝겍 또는 피부로 절대 접촉치 마십시오. ● 모재와 접지를 접촉치 마십시오. 	<ul style="list-style-type: none"> ● 인화성 물질을 접근 시키지 마시오. 	<ul style="list-style-type: none"> ● 눈, 귀와 몸에 보호장구를 착용하십시오.
Arabic تحذير	<ul style="list-style-type: none"> ● لا تلمس الاجزاء التي يسري فيها التيار الكهربائي أو الألكترود بجك الجسم أو بالملابس المبللة بالماء. ● ضع عازلا على جسمك خلال العمل. 	<ul style="list-style-type: none"> ● ضع المواد القابلة للاشتعال في مكان بعيد. 	<ul style="list-style-type: none"> ● ضع أدوات وملابس واقية على عينيك وأذنيك وجسمك.

READ AND UNDERSTAND THE MANUFACTURER'S INSTRUCTION FOR THIS EQUIPMENT AND THE CONSUMABLES TO BE USED AND FOLLOW YOUR EMPLOYER'S SAFETY PRACTICES.

SE RECOMIENDA LEER Y ENTENDER LAS INSTRUCCIONES DEL FABRICANTE PARA EL USO DE ESTE EQUIPO Y LOS CONSUMIBLES QUE VA A UTILIZAR, SIGA LAS MEDIDAS DE SEGURIDAD DE SU SUPERVISOR.

LISEZ ET COMPRENEZ LES INSTRUCTIONS DU FABRICANT EN CE QUI REGARDE CET EQUIPMENT ET LES PRODUITS A ETRE EMPLOYES ET SUIVEZ LES PROCEDURES DE SECURITE DE VOTRE EMPLOYEUR.

LESEN SIE UND BEFOLGEN SIE DIE BETRIEBSANLEITUNG DER ANLAGE UND DEN ELEKTRODENEINSATZ DES HERSTELLERS. DIE UNFALLVERHÜTUNGSVORSCHRIFTEN DES ARBEITGEBERS SIND EBENFALLS ZU BEACHTEN.

			
<ul style="list-style-type: none"> • Keep your head out of fumes. • Use ventilation or exhaust to remove fumes from breathing zone. 	<ul style="list-style-type: none"> • Turn power off before servicing. 	<ul style="list-style-type: none"> • Do not operate with panel open or guards off. 	WARNING
<ul style="list-style-type: none"> • Los humos fuera de la zona de respiración. • Mantenga la cabeza fuera de los humos. Utilice ventilación o aspiración para gases. 	<ul style="list-style-type: none"> • Desconectar el cable de alimentación de poder de la máquina antes de iniciar cualquier servicio. 	<ul style="list-style-type: none"> • No operar con panel abierto o guardas quitadas. 	Spanish AVISO DE PRECAUCION
<ul style="list-style-type: none"> • Gardez la tête à l'écart des fumées. • Utilisez un ventilateur ou un aspirateur pour ôter les fumées des zones de travail. 	<ul style="list-style-type: none"> • Débranchez le courant avant l'entretien. 	<ul style="list-style-type: none"> • N'opérez pas avec les panneaux ouverts ou avec les dispositifs de protection enlevés. 	French ATTENTION
<ul style="list-style-type: none"> • Vermeiden Sie das Einatmen von Schweißrauch! • Sorgen Sie für gute Be- und Entlüftung des Arbeitsplatzes! 	<ul style="list-style-type: none"> • Strom vor Wartungsarbeiten abschalten! (Netzstrom völlig öffnen; Maschine anhalten!) 	<ul style="list-style-type: none"> • Anlage nie ohne Schutzgehäuse oder Innenschutzverkleidung in Betrieb setzen! 	German WARNUNG
<ul style="list-style-type: none"> • Mantenha seu rosto da fumaça. • Use ventilação e exaustão para remover fumo da zona respiratória. 	<ul style="list-style-type: none"> • Não opere com as tampas removidas. • Desligue a corrente antes de fazer serviço. • Não toque as partes elétricas nuas. 	<ul style="list-style-type: none"> • Mantenha-se afastado das partes moventes. • Não opere com os painéis abertos ou guardas removidas. 	Portuguese ATENÇÃO
<ul style="list-style-type: none"> ● ヒュームから頭を離すようにして下さい。 ● 換気や排煙に十分留意して下さい。 	<ul style="list-style-type: none"> ● メンテナンス・サービスに取りかかる際には、まず電源スイッチを必ず切して下さい。 	<ul style="list-style-type: none"> ● パネルやカバーを取り外したまま機械操作をしないで下さい。 	Japanese 注意事項
<ul style="list-style-type: none"> ● 頭部遠離煙霧。 ● 在呼吸區使用通風或排風器除煙。 	<ul style="list-style-type: none"> ● 維修前切斷電源。 	<ul style="list-style-type: none"> ● 儀表板打開或沒有安全罩時不準作業。 	Chinese 警告
<ul style="list-style-type: none"> ● 얼굴로부터 용접가스를 멀리하십시오. ● 호흡지역으로부터 용접가스를 제거하기 위해 가스제거기나 통풍기를 사용하십시오. 	<ul style="list-style-type: none"> ● 보수전에 전원을 차단하십시오. 	<ul style="list-style-type: none"> ● 관널이 열린 상태로 작동치 마십시오. 	Korean 위험
<ul style="list-style-type: none"> ● ابعء رأسك بعيداً عن الدخان. ● استعمل التهوية أو جهاز ضغط الدخان للخارج لكي تبعد الدخان عن المنطقة التي تتنفس فيها. 	<ul style="list-style-type: none"> ● اقطع التيار الكهربائي قبل القيام بأية صيانة. 	<ul style="list-style-type: none"> ● لا تشغيل هذا الجهاز اذا كانت الاعطية الحديدية الواقية ليست عليه. 	Arabic تحذير

LEIA E COMPREENDA AS INSTRUÇÕES DO FABRICANTE PARA ESTE EQUIPAMENTO E AS PARTES DE USO, E SIGA AS PRÁTICAS DE SEGURANÇA DO EMPREGADOR.

使う機械や溶材のメーカーの指示書をよく読み、まず理解して下さい。そして貴社の安全規定に従って下さい。

請詳細閱讀並理解製造廠提供的說明以及應該使用的銀焊材料，並請遵守貴方的有閣勞動保護規定。

이 제품에 동봉된 작업지침서를 숙지하시고 귀사의 작업자 안전수칙을 준수하시기 바랍니다.

اقرأ بتمعن وأفهم تعليمات المصنع المنتج لهذه المعدات والمواد قبل استعمالها واتبع تعليمات الوقاية لصاحب العمل.



• World's Leader in Welding and Cutting Products •

• Sales and Service through Subsidiaries and Distributors Worldwide •

Cleveland, Ohio 44117-1199 U.S.A. TEL: 216.481.8100 FAX: 216.486.1751 WEB SITE: www.lincolnelectric.com

Download from Www.Somanuals.com. All Manuals Search And Download.

Free Manuals Download Website

<http://myh66.com>

<http://usermanuals.us>

<http://www.somanuals.com>

<http://www.4manuals.cc>

<http://www.manual-lib.com>

<http://www.404manual.com>

<http://www.luxmanual.com>

<http://aubethermostatmanual.com>

Golf course search by state

<http://golfingnear.com>

Email search by domain

<http://emailbydomain.com>

Auto manuals search

<http://auto.somanuals.com>

TV manuals search

<http://tv.somanuals.com>