

SQUARE WAVE TIG 255

For use with machines having Code Number 10022 thru 10026 & 10134, 10451,10452,10453.

Safety Depends on You

Lincoln arc welding and cutting equipment is designed and built with safety in mind. However, your overall safety can be increased by proper installation ... and thoughtful operation on your part. **DO NOT INSTALL, OPERATE OR REPAIR THIS EQUIPMENT WITHOUT READING THIS MANUAL AND THE SAFETY PRECAUTIONS CONTAINED THROUGHOUT.** And, most importantly, think before you act and be careful.

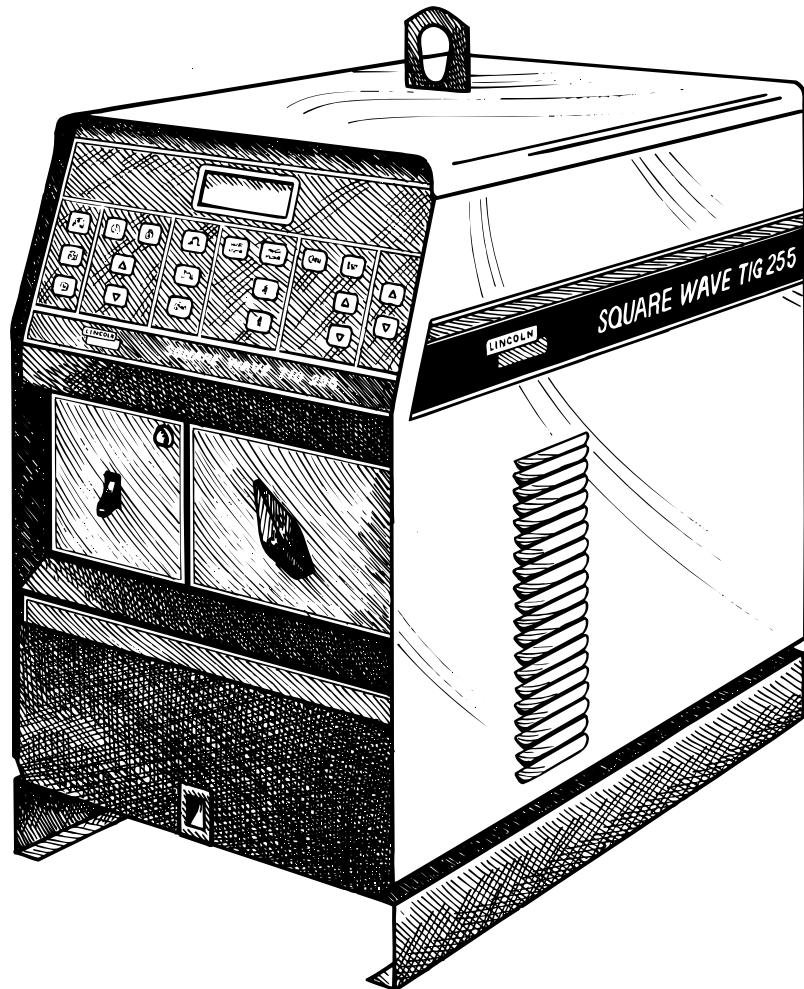

This manual covers equipment which is obsolete and no longer in production by The Lincoln Electric Co. Specifications and availability of optional features may have changed.

OPERATOR'S MANUAL



World's Leader in Welding and Cutting Products

Premier Manufacturer of Industrial Motors

Sales and Service through Subsidiaries and Distributors Worldwide
22801 St. Clair Ave. Cleveland, Ohio 44117-1199 U.S.A. Tel. (216) 481-8100

Download from [Www.Somanuals.com](http://www.Somanuals.com). All Manuals Search And Download.

SAFETY

WARNING

CALIFORNIA PROPOSITION 65 WARNINGS

Diesel engine exhaust and some of its constituents are known to the State of California to cause cancer, birth defects, and other reproductive harm.

The Above For Diesel Engines

The engine exhaust from this product contains chemicals known to the State of California to cause cancer, birth defects, or other reproductive harm.

The Above For Gasoline Engines

ARC WELDING CAN BE HAZARDOUS. PROTECT YOURSELF AND OTHERS FROM POSSIBLE SERIOUS INJURY OR DEATH. KEEP CHILDREN AWAY. PACEMAKER WEARERS SHOULD CONSULT WITH THEIR DOCTOR BEFORE OPERATING.

Read and understand the following safety highlights. For additional safety information, it is strongly recommended that you purchase a copy of "Safety in Welding & Cutting - ANSI Standard Z49.1" from the American Welding Society, P.O. Box 351040, Miami, Florida 33135 or CSA Standard W117.2-1974. A Free copy of "Arc Welding Safety" booklet E205 is available from the Lincoln Electric Company, 22801 St. Clair Avenue, Cleveland, Ohio 44117-1199.

BE SURE THAT ALL INSTALLATION, OPERATION, MAINTENANCE AND REPAIR PROCEDURES ARE PERFORMED ONLY BY QUALIFIED INDIVIDUALS.



FOR ENGINE powered equipment.

1.a. Turn the engine off before troubleshooting and maintenance work unless the maintenance work requires it to be running.



1.b. Operate engines in open, well-ventilated areas or vent the engine exhaust fumes outdoors.



1.c. Do not add the fuel near an open flame welding arc or when the engine is running. Stop the engine and allow it to cool before refueling to prevent spilled fuel from vaporizing on contact with hot engine parts and igniting. Do not spill fuel when filling tank. If fuel is spilled, wipe it up and do not start engine until fumes have been eliminated.



1.d. Keep all equipment safety guards, covers and devices in position and in good repair. Keep hands, hair, clothing and tools away from V-belts, gears, fans and all other moving parts when starting, operating or repairing equipment.

1.e. In some cases it may be necessary to remove safety guards to perform required maintenance. Remove guards only when necessary and replace them when the maintenance requiring their removal is complete. Always use the greatest care when working near moving parts.

1.f. Do not put your hands near the engine fan. Do not attempt to override the governor or idler by pushing on the throttle control rods while the engine is running.



1.h. To avoid scalding, do not remove the radiator pressure cap when the engine is hot.



ELECTRIC AND MAGNETIC FIELDS may be dangerous

2.a. Electric current flowing through any conductor causes localized Electric and Magnetic Fields (EMF). Welding current creates EMF fields around welding cables and welding machines

2.b. EMF fields may interfere with some pacemakers, and welders having a pacemaker should consult their physician before welding.

2.c. Exposure to EMF fields in welding may have other health effects which are now not known.

2.d. All welders should use the following procedures in order to minimize exposure to EMF fields from the welding circuit:

2.d.1. Route the electrode and work cables together - Secure them with tape when possible.

2.d.2. Never coil the electrode lead around your body.

2.d.3. Do not place your body between the electrode and work cables. If the electrode cable is on your right side, the work cable should also be on your right side.

2.d.4. Connect the work cable to the workpiece as close as possible to the area being welded.

2.d.5. Do not work next to welding power source.

Mar '95

SAFETY



ELECTRIC SHOCK can kill.

- 3.a. The electrode and work (or ground) circuits are electrically "hot" when the welder is on. Do not touch these "hot" parts with your bare skin or wet clothing. Wear dry, hole-free gloves to insulate hands.
- 3.b. Insulate yourself from work and ground using dry insulation. Make certain the insulation is large enough to cover your full area of physical contact with work and ground.

In addition to the normal safety precautions, if welding must be performed under electrically hazardous conditions (in damp locations or while wearing wet clothing; on metal structures such as floors, gratings or scaffolds; when in cramped positions such as sitting, kneeling or lying, if there is a high risk of unavoidable or accidental contact with the workpiece or ground) use the following equipment:

- **Semiautomatic DC Constant Voltage (Wire) Welder.**
 - **DC Manual (Stick) Welder.**
 - **AC Welder with Reduced Voltage Control.**
- 3.c. In semiautomatic or automatic wire welding, the electrode, electrode reel, welding head, nozzle or semiautomatic welding gun are also electrically "hot".
- 3.d. Always be sure the work cable makes a good electrical connection with the metal being welded. The connection should be as close as possible to the area being welded.
- 3.e. Ground the work or metal to be welded to a good electrical (earth) ground.
- 3.f. Maintain the electrode holder, work clamp, welding cable and welding machine in good, safe operating condition. Replace damaged insulation.
- 3.g. Never dip the electrode in water for cooling.
- 3.h. Never simultaneously touch electrically "hot" parts of electrode holders connected to two welders because voltage between the two can be the total of the open circuit voltage of both welders.
- 3.i. When working above floor level, use a safety belt to protect yourself from a fall should you get a shock.
- 3.j. Also see Items 6.c. and 8.



ARC RAYS can burn.

- 4.a. Use a shield with the proper filter and cover plates to protect your eyes from sparks and the rays of the arc when welding or observing open arc welding. Headshield and filter lens should conform to ANSI Z87.1 standards.
- 4.b. Use suitable clothing made from durable flame-resistant material to protect your skin and that of your helpers from the arc rays.
- 4.c. Protect other nearby personnel with suitable, non-flammable screening and/or warn them not to watch the arc nor expose themselves to the arc rays or to hot spatter or metal.



FUMES AND GASES can be dangerous.

- 5.a. Welding may produce fumes and gases hazardous to health. Avoid breathing these fumes and gases. When welding, keep your head out of the fume. Use enough ventilation and/or exhaust at the arc to keep fumes and gases away from the breathing zone. **When welding with electrodes which require special ventilation such as stainless or hard facing (see instructions on container or MSDS) or on lead or cadmium plated steel and other metals or coatings which produce highly toxic fumes, keep exposure as low as possible and below Threshold Limit Values (TLV) using local exhaust or mechanical ventilation. In confined spaces or in some circumstances, outdoors, a respirator may be required. Additional precautions are also required when welding on galvanized steel.**
- 5.b. Do not weld in locations near chlorinated hydrocarbon vapors coming from degreasing, cleaning or spraying operations. The heat and rays of the arc can react with solvent vapors to form phosgene, a highly toxic gas, and other irritating products.
- 5.c. Shielding gases used for arc welding can displace air and cause injury or death. Always use enough ventilation, especially in confined areas, to insure breathing air is safe.
- 5.d. Read and understand the manufacturer's instructions for this equipment and the consumables to be used, including the material safety data sheet (MSDS) and follow your employer's safety practices. MSDS forms are available from your welding distributor or from the manufacturer.
- 5.e. Also see item 1.b.

Mar '95

SAFETY

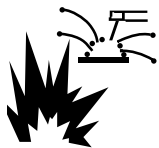

WELDING SPARKS can cause fire or explosion.

6.a. Remove fire hazards from the welding area. If this is not possible, cover them to prevent the welding sparks from starting a fire. Remember that welding sparks and hot materials from welding can easily go through small cracks and openings to adjacent areas. Avoid welding near hydraulic lines. Have a fire extinguisher readily available.

- 6.b. Where compressed gases are to be used at the job site, special precautions should be used to prevent hazardous situations. Refer to "Safety in Welding and Cutting" (ANSI Standard Z49.1) and the operating information for the equipment being used.
- 6.c. When not welding, make certain no part of the electrode circuit is touching the work or ground. Accidental contact can cause overheating and create a fire hazard.
- 6.d. Do not heat, cut or weld tanks, drums or containers until the proper steps have been taken to insure that such procedures will not cause flammable or toxic vapors from substances inside. They can cause an explosion even though they have been "cleaned". For information, purchase "Recommended Safe Practices for the Preparation for Welding and Cutting of Containers and Piping That Have Held Hazardous Substances", AWS F4.1 from the American Welding Society (see address above).
- 6.e. Vent hollow castings or containers before heating, cutting or welding. They may explode.
- 6.f. Sparks and spatter are thrown from the welding arc. Wear oil free protective garments such as leather gloves, heavy shirt, cuffless trousers, high shoes and a cap over your hair. Wear ear plugs when welding out of position or in confined places. Always wear safety glasses with side shields when in a welding area.
- 6.g. Connect the work cable to the work as close to the welding area as practical. Work cables connected to the building framework or other locations away from the welding area increase the possibility of the welding current passing through lifting chains, crane cables or other alternate circuits. This can create fire hazards or overheat lifting chains or cables until they fail.
- 6.h. Also see item 1.c.

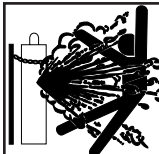

CYLINDER may explode if damaged.

- 7.a. Use only compressed gas cylinders containing the correct shielding gas for the process used and properly operating regulators designed for the gas and pressure used. All hoses, fittings, etc. should be suitable for the application and maintained in good condition.
- 7.b. Always keep cylinders in an upright position securely chained to an undercarriage or fixed support.
- 7.c. Cylinders should be located:
- Away from areas where they may be struck or subjected to physical damage.
 - A safe distance from arc welding or cutting operations and any other source of heat, sparks, or flame.
- 7.d. Never allow the electrode, electrode holder or any other electrically "hot" parts to touch a cylinder.
- 7.e. Keep your head and face away from the cylinder valve outlet when opening the cylinder valve.
- 7.f. Valve protection caps should always be in place and hand tight except when the cylinder is in use or connected for use.
- 7.g. Read and follow the instructions on compressed gas cylinders, associated equipment, and CGA publication P-1, "Precautions for Safe Handling of Compressed Gases in Cylinders," available from the Compressed Gas Association 1235 Jefferson Davis Highway, Arlington, VA 22202.



FOR ELECTRICALLY powered equipment.

- 8.a. Turn off input power using the disconnect switch at the fuse box before working on the equipment.
- 8.b. Install equipment in accordance with the U.S. National Electrical Code, all local codes and the manufacturer's recommendations.
- 8.c. Ground the equipment in accordance with the U.S. National Electrical Code and the manufacturer's recommendations.

Mar '95

PRÉCAUTIONS DE SÛRETÉ

Pour votre propre protection lire et observer toutes les instructions et les précautions de sûreté spécifiques qui paraissent dans ce manuel aussi bien que les précautions de sûreté générales suivantes:

Sûreté Pour Soudage A L'Arc

1. Protégez-vous contre la secousse électrique:
 - a. Les circuits à l'électrode et à la pièce sont sous tension quand la machine à souder est en marche. Éviter toujours tout contact entre les parties sous tension et la peau nue ou les vêtements mouillés. Porter des gants secs et sans trous pour isoler les mains.
 - b. Faire très attention de bien s'isoler de la masse quand on soude dans des endroits humides, ou sur un plancher métallique ou des grilles métalliques, principalement dans les positions assis ou couché pour lesquelles une grande partie du corps peut être en contact avec la masse.
 - c. Maintenir le porte-électrode, la pince de masse, le câble de soudage et la machine à souder en bon et sûr état de fonctionnement.
 - d. Ne jamais plonger le porte-électrode dans l'eau pour le refroidir.
 - e. Ne jamais toucher simultanément les parties sous tension des porte-électrodes connectés à deux machines à souder parce que la tension entre les deux pinces peut être le total de la tension à vide des deux machines.
 - f. Si on utilise la machine à souder comme une source de courant pour soudage semi-automatique, ces précautions pour le porte-électrode s'appliquent aussi au pistolet de soudage.
2. Dans le cas de travail au dessus du niveau du sol, se protéger contre les chutes dans le cas où on reçoit un choc. Ne jamais enrouler le câble-électrode autour de n'importe quelle partie du corps.
3. Un coup d'arc peut être plus sévère qu'un coup de soleil, donc:
 - a. Utiliser un bon masque avec un verre filtrant approprié ainsi qu'un verre blanc afin de se protéger les yeux du rayonnement de l'arc et des projections quand on soude ou quand on regarde l'arc.
 - b. Porter des vêtements convenables afin de protéger la peau de soudeur et des aides contre le rayonnement de l'arc.
 - c. Protéger l'autre personnel travaillant à proximité au soudage à l'aide d'écrans appropriés et non-inflammables.
4. Des gouttes de laitier en fusion sont émises de l'arc de soudage. Se protéger avec des vêtements de protection libres de l'huile, tels que les gants en cuir, chemise épaisse, pantalons sans revers, et chaussures montantes.
5. Toujours porter des lunettes de sécurité dans la zone de soudage. Utiliser des lunettes avec écrans latéraux dans les

zones où l'on pique le laitier.

6. Eloigner les matériaux inflammables ou les recouvrir afin de prévenir tout risque d'incendie dû aux étincelles.
7. Quand on ne soude pas, poser la pince à un endroit isolé de la masse. Un court-circuit accidentel peut provoquer un échauffement et un risque d'incendie.
8. S'assurer que la masse est connectée le plus près possible de la zone de travail qu'il est pratique de le faire. Si on place la masse sur la charpente de la construction ou d'autres endroits éloignés de la zone de travail, on augmente le risque de voir passer le courant de soudage par les chaînes de levage, câbles de grue, ou autres circuits. Cela peut provoquer des risques d'incendie ou d'échauffement des chaînes et des câbles jusqu'à ce qu'ils se rompent.
9. Assurer une ventilation suffisante dans la zone de soudage. Ceci est particulièrement important pour le soudage de tôles galvanisées plombées, ou cadmiées ou tout autre métal qui produit des fumées toxiques.
10. Ne pas souder en présence de vapeurs de chlore provenant d'opérations de dégraissage, nettoyage ou pistolage. La chaleur ou les rayons de l'arc peuvent réagir avec les vapeurs du solvant pour produire du phosgène (gas fortement toxique) ou autres produits irritants.
11. Pour obtenir de plus amples renseignements sur la sûreté, voir le code "Code for safety in welding and cutting" CSA Standard W 117.2-1974.

PRÉCAUTIONS DE SÛRETÉ POUR LES MACHINES À SOUDER À TRANSFORMATEUR ET À REDRESSEUR

1. Relier à la terre le châssis du poste conformément au code de l'électricité et aux recommandations du fabricant. Le dispositif de montage ou la pièce à souder doit être branché à une bonne mise à la terre.
2. Autant que possible, l'installation et l'entretien du poste seront effectués par un électricien qualifié.
3. Avant de faire des travaux à l'intérieur de poste, la débrancher à l'interrupteur à la boîte de fusibles.
4. Garder tous les couvercles et dispositifs de sûreté à leur place.

Thank You

for selecting a **QUALITY** product by Lincoln Electric. We want you to take pride in operating this Lincoln Electric Company product
••• as much pride as we have in bringing this product to you!

Please Examine Carton and Equipment For Damage Immediately

When this equipment is shipped, title passes to the purchaser upon receipt by the carrier. Consequently, Claims for material damaged in shipment must be made by the purchaser against the transportation company at the time the shipment is received.

Please record your equipment identification information below for future reference. This information can be found on your machine nameplate.

Model Name & Number _____

Code & Serial Number _____

Date of Purchase _____

Whenever you request replacement parts for or information on this equipment always supply the information you have recorded above.

Read this Operators Manual completely before attempting to use this equipment. Save this manual and keep it handy for quick reference. Pay particular attention to the safety instructions we have provided for your protection. The level of seriousness to be applied to each is explained below:

WARNING

This statement appears where the information **must** be followed **exactly** to avoid **serious personal injury** or **loss of life**.

CAUTION

This statement appears where the information **must** be followed to avoid **minor personal injury** or **damage to this equipment**.

TABLE OF CONTENTS

	Page
Safety	2-6
<hr/>	
Installation	8-12
Technical Specifications	8
Input and Output Specifications	
Cable and Fuse Sizes	
Physical Dimensions	
Location	9
Machine Grounding.....	9
Input Connections	10
Output Connections	11
<hr/>	
Operation	13-23
Safety Instructions	13
Graphic Symbols	14-15
General Description	16
Design Features and Advantages.....	16
Welding Capability	17
Limitations	17
Controls and Settings.....	18
Hand and Foot Amptrol Operation	20
Welding Operation	20-23
Tig Welding Guidelines	20
Tig Welding Sequence of Operation (2 Step Mode)	21
Tig Welding Sequence of Operation (4 Step Mode)	22
Advanced Tig Welding Features	22
Stick Welding	23
Auxillary Power	23
Overload Protection	23
<hr/>	
Accessories	24
<hr/>	
Maintenance	25-26
Safety Precautions	25
Routine and Periodic Maintenance	25
General Assembly Exploded View.....	26
<hr/>	
Troubleshooting	27-34
How To Use Troubleshooting Guide	27
Troubleshooting Guide	28-34
<hr/>	
Wiring Diagrams	35-36
<hr/>	
Parts Manual	APPENDIX

INSTALLATION

TECHNICAL SPECIFICATIONS - SQUARE WAVE TIG 255

INPUT - SINGLE PHASE ONLY		
Standard Voltage 208/230/460/1/60 230/460/575/1/60 200/240/400/1/50/60 220/380/440/1/50/60 380/415/500/1/50/60 220/380/415/1/50/60	Input Current at Rated Output ⁽¹⁾ 81/74/37 74/37/30 85/77/44 77/45/39 45/41/33 77/45/41	Code Number 10022 10023 10024 10452 10453 10451
RATED OUTPUT		
Duty Cycle 40% Duty Cycle NEMA Class II (40) 60% Duty Cycle 100% Duty Cycle	Amps 255 200 150	Volts at Rated Amperes 30 28 26
OUTPUT		
Welding Current Range (Continuous) 5-315 Amps AC and DC	Constant Open Circuit Voltage Stick OCV: 76 TIG OCV: 53	Auxiliary Power 115 Volts AC, 10 Amps 220Volts AC, 2 Amps (50/60 Hz. machines only)

RECOMMENDED INPUT WIRE AND FUSE SIZES							
		For all Stick, DC TIG, and Balanced AC TIG Welding at 255A/30V/40% Duty Cycle Based on the 1993 US. National Electrical Code			For Unbalanced AC TIG Welding Above 180 Amps, 255A/16V/40% Duty Cycle, Auto Balance Based on the 1993 U.S. National Electrical Code		
Input Voltage / Frequency	Fuse (Super Lag) or Breaker Size	Input Ampere Rating on Nameplate	Type 75°C Copper Wire in Conduit AWG (IEC) Sizes	Type 75°C Copper Ground Wire in Conduit AWG (IEC) Sizes	Input Amperes	Type 75°C Copper Wire in Conduit AWG (IEC) Sizes	Type 75°C Copper Ground Wire in Conduit AWG (IEC) Sizes
208/60	125	81	6 (16mm ²)	6 (16mm ²)	102	4 (25mm ²)	6 (16mm ²)
230/60	100	74	6 (16mm ²)	8 (10mm ²)	92	4 (25mm ²)	6 (16mm ²)
460/60	50	37	10 (6mm ²)	10 (6mm ²)	46	8 (10mm ²)	10 (6mm ²)
575/60	50	30	10 (6mm ²)	10 (6mm ²)	37	10 (6mm ²)	10 (6mm ²)
200/50/60	125	85	6 (16mm ²)	6 (16mm ²)	105	4 (25mm ²)	6 (16mm ²)
220/50/60	100	77	6 (16mm ²)	8 (10mm ²)	96	4 (25mm ²)	8 (10mm ²)
380/50/60	70	46	8 (10mm ²)	8 (10mm ²)	55	8 (10mm ²)	8 (10mm ²)
400/50/60	60	43	10 (6mm ²)	10 (6mm ²)	53	8 (10mm ²)	10 (6mm ²)
415/50/60	60	41	10 (6mm ²)	10 (6mm ²)	51	8 (10mm ²)	10 (6mm ²)
440/50/60	60	39	10 (6mm ²)	10 (6mm ²)	48	8 (10mm ²)	10 (6mm ²)
500/50/60	50	34	10 (6mm ²)	10 (6mm ²)	42	10 (6mm ²)	10 (6mm ²)

PHYSICAL DIMENSIONS			
Height 30.5 in.	Width 19.0 in. (Lift bail, add 3.5 in)	Depth 30.0 in.	Weight 300 lbs (137 kg)
775 mm	485 mm (Lift bail, add 90 mm)	760 mm	

(1) Unbalanced TIG welding above 180 amps will draw higher input currents; see Supply Connections section.

Read entire installation section before starting installation.

Safety Precautions

WARNING



ELECTRIC SHOCK can kill.

- Only qualified personnel should perform this installation.
- Turn the input power OFF at the disconnect switch or fuse box before working on this equipment.
- Do not touch electrically hot parts.
- Always connect the Square Wave TIG 255 grounding terminal (located on the bottom of the input connection box) to a good electrical earth ground.

SELECT SUITABLE LOCATION

Place the welder where clean cooling air can freely circulate in through the rear louvers and out through the side louvers. Dirt, dust or any foreign material that can be drawn into the welder should be kept at a minimum. Failure to observe these precautions can result in excessive operating temperatures and nuisance shut-downs.

STACKING

Square Wave TIG 255's cannot be stacked.

TILTING

Each machine must be placed on a secure, level surface, either directly or on a recommended undercarriage. The machine may topple over if this procedure is not followed.

ENVIRONMENTAL PROTECTION

Square Wave TIG 255 power sources carry an IP21 protection rating. They are rated for use in rain-sheltered environments.

MACHINE GROUNDING AND HIGH FREQUENCY INTERFERENCE PROTECTION

The frame of the welder must be grounded. A ground terminal marked with the symbol  is located at the bottom of the input box for this purpose. See your local and national electrical codes for proper grounding methods.

The spark gap oscillator in the high frequency generator, being similar to a radio transmitter, can be blamed for many radio, TV and electronic equipment interference problems. These problems may be the result of radiated interference. Proper grounding methods can reduce or eliminate radiated interference.

Radiated interference can develop in the following four ways:

1. Direct interference radiated from the welder.
2. Direct interference radiated from the welding leads.
3. Direct interference radiated from feedback into the power lines.
4. Interference from re-radiation of "pickup" by ungrounded metallic objects.

Keeping these contributing factors in mind, installing equipment per the following instructions should minimize problems.

1. Keep the welder power supply lines as short as possible and completely enclose them in rigid metallic conduit or equivalent shielding for a minimum distance of 50 feet (15.2m). There should be good electrical contact between this conduit and the welder. Both ends of the conduit should be connected to a driven ground and the entire length should be continuous.
2. Keep the work and electrode leads as short as possible and as close together as possible. Lengths should not exceed 25 ft (7.6m). Tape the leads together when practical.
3. Be sure the torch and work cable rubber coverings are free of cuts and cracks that allow high frequency leakage. Cables with high natural rubber content, such as Lincoln Stable-Arc® better resist high frequency leakage than neoprene and other synthetic rubber insulated cables.

INSTALLATION

4. Keep the torch in good repair and all connections tight to reduce high frequency leakage.
5. The work terminal must be connected to a ground within ten feet of the welder, using one of the following methods:
 - a) A metal underground water pipe in direct contact with the earth for ten feet or more.
 - b) A 3/4" (19mm) galvanized pipe or a 5/8" (16mm) solid galvanized iron, steel or copper rod driven at least eight feet into the ground.The ground should be securely made and the grounding cable should be as short as possible using cable of the same size as the work cable, or larger. Grounding to the building frame electrical conduit or a long pipe system can result in re-radiation, effectively making these members radiating antennas.
6. Keep all access panels and covers securely in place.
7. All electrical conductors within 50 ft (15.2m) of the welder should be enclosed in grounded rigid metallic conduit or equivalent shielding. Flexible metallic conduit is generally not suitable.
8. When the welder is enclosed in a metal building, several good earth driven electrical grounds (as in 5 (b) above) around the periphery of the building are recommended.

Failure to observe these recommended installation procedures can cause radio or TV interference problems and result in unsatisfactory welding performance resulting from lost high frequency power.

INPUT CONNECTIONS

Be sure the voltage, phase, and frequency of the input power is as specified on the rating plate, located on the rear of the machine.

Welder supply line entry provision is in the case rear panel with a removable cover over the input connection panel area. Entry is through a 1.7 in (43mm) diameter hole in the case back. European machines have a plastic bushing good for 3 - 10mm² conductors. For larger input conductors a customer supplied plastic bushing should be used if required by local or national code specifications.

See Figure 1 for the location of the rating plate, the entry hole, and the reconnect panel.

FIGURE 1 - REAR PANEL

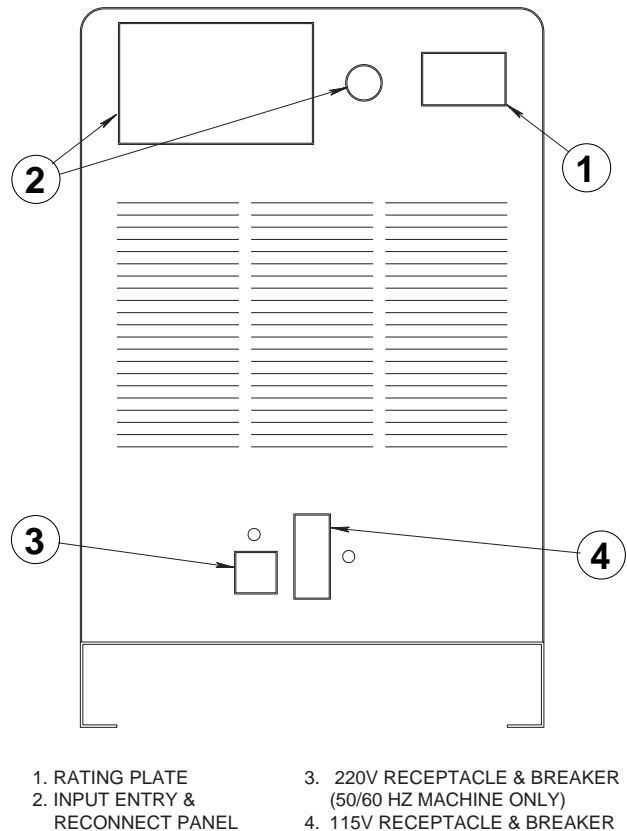

Have a qualified electrician connect the input leads to L1 and L2 of the input panel in accordance with all local codes and national electrical codes, and the connection diagram located on the inside of the cover. Use a single phase line or one phase of a two or three phase line.

On multiple input voltage welders, be sure the reconnect panel is connected per the following instructions for the voltage being supplied to the welder.

CAUTION

Failure to follow these instructions can cause immediate failure of components within the welder.

INSTALLATION

Welders are shipped connected for the highest input voltage as listed on the rating Plate. To change this connection for a different input voltage, reconnect the power strap (P) to the terminal corresponding to the input voltage used. Designations on reconnect panel, LOW, MID and HIGH correspond to the nameplate input voltages of a triple voltage welder. Dual voltage welders use only LOW and HIGH. Single voltage welders use only HIGH.

EXAMPLE: On a 208/230/460 volt welder, LOW is 208V, MID is 230V, and HIGH is 460V.

Fuse the input circuit with the recommended super lag fuses or delay type¹ circuit breakers. Choose an input and grounding wire size according to local or national codes, refer to Specification page at the beginning of this chapter. Using fuses or circuit breakers smaller than recommended may result in “nuisance” shut-offs from welder inrush currents even if not welding at high currents.

Unbalanced AC TIG welding draws higher input currents than those for stick, DC TIG, or Balanced AC TIG welding. The welder is designed for these higher input currents. However, where unbalanced AC TIG welding above 180 amps is planned, the higher input currents require larger input wire sizes and fuses. Refer to Specification page at the beginning of this chapter.

The Square Wave TIG 255 should be permanently wired into the power system. No plugs or connectors are necessary.

OUTPUT CONNECTIONS

⚠ WARNING

To avoid receiving a high frequency shock, keep the TIG torch and cables in good condition.

See Figure 2 for the location of the work and electrode terminals, the gas and optional water solenoids, and the Remote Receptacle.

¹Also called “inverse time” or “thermal/magnetic” circuit breakers; circuit breakers which have a delay in tripping action that decreases as the magnitude of the current increases.

FIGURE 2 - FRONT PANEL

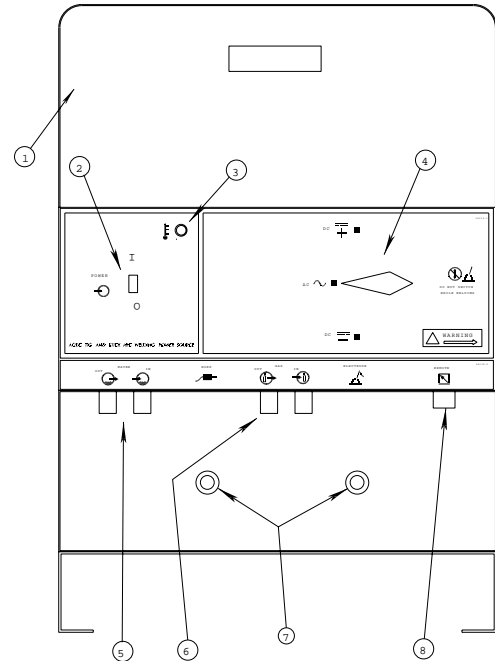

- | | |
|----------------------------------|------------------------------------|
| 1. CONTROL AND DISPLAY AREA | 5. OPTIONAL WATER SOLENOID |
| 2. POWER SWITCH | 6. GAS SOLENOID |
| 3. THERMOSTATIC PROTECTION LIGHT | 7. WORK (LEFT) AND ELECTRODE STUDS |
| 4. POLARITY SWITCH | 8. REMOTE RECEPTACLE |

TIG TORCH CONNECTION

TIG welding torches come with 12.5 ft (3.8m) and 25 ft (7.6m) cables. Use the shorter length whenever possible to minimize possible radio interference problems. With power source off, connect the torch cable to the “Electrode” stud on the welder. Connect a separate work cable to the “Work” stud of the welder. See Table 1 for recommended work cable sizes. Both work and electrode cables should be routed through the cable strain relief holes provided in the base directly below the welding output terminals.

TABLE 1
Cable Sizes for Combined Lengths of Copper Electrode and Work Cable

Machine Size	Lengths up to 100 ft	100 to 200 ft	200 to 250 ft
255 Amp 40% Duty Cycle	#2 (35mm ²)	#1 (45mm ²)	1/0 (55mm ²)

TIG torches include the necessary gas and, when designed for water cooling, water hoses. Connect the fittings on these hoses to the welder fittings. Any torch conforming to Compressed Gas Association (CGA) standards can be connected.

INSTALLATION

The welder fittings have the following threads: Gas Inlet and Outlet: 5/8"-18 right-hand female; Water inlet and Outlet: 5/8"-18 left-hand female. The cylinder of inert shielding gas must be equipped with a pressure regulator and flow meter. Install a hose between the flow meter and gas inlet on the welder.

WARNING

Observe the safety precautions necessary for handling and using compressed gas containers. Contact your supplier for specific information.

DO NOT operate a water-cooled torch unless water is flowing. Water doesn't flow until solenoid is actuated.

If using a water-cooled torch with a Magnum water cooler, connect the cooler water outlet to the "Water Valve In" fitting. Connect the TIG torch inlet to the "Water Valve Out" fitting.

If using a water-cooled torch with a free-running water supply, install a water line between the welder "Water Inlet" and the supply. Include a strainer in the water supply line to prevent dirt particles from obstructing water flow in the valve and cooling chamber of the TIG torch. Failure to do so could result in water valve malfunction and overheating of the water-cooled torch. Connect the torch water line to the welder "Water Out" fitting. Use a nonmetallic drain line from the electrode connection to the drain or water recirculating pump.

For other conditions, consult the manufacturer's instructions for the water cooler or TIG torch being used.

STICK ELECTRODE CABLE CONNECTION

Turn the Power switch Off. Run the electrode and work cables through the strain relief holes below the welding output terminals, and connect the cables to the proper terminals. This strain relief prevents damage to the welding output terminals if the cables are pulled excessively. Select cable size according to Table 1.

WARNING

Do not connect a TIG torch and stick electrode cable at the same time. They will both be electrically **HOT** whenever the output contactor is energized.

OPERATING INSTRUCTIONS

General Warnings

SAFETY INSTRUCTIONS

WARNING



ELECTRIC SHOCK can kill.

- Do not touch electrically live parts or electrode with skin or wet clothing.
- Insulate yourself from work and ground.
- Always wear dry insulating gloves.



FUMES AND GASES can be dangerous.

- Keep your head out of fumes.
- Use ventilation or exhaust to remove fumes from breathing zone.

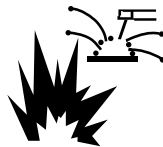

WELDING SPARKS can cause fire or explosion

- Keep flammable material away.
- Do not weld on containers that have held combustibles.















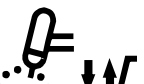





ARC RAYS can burn.

- Wear eye, ear and body protection.

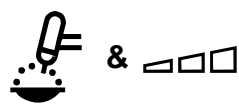

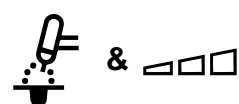











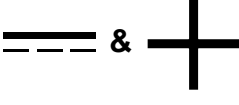
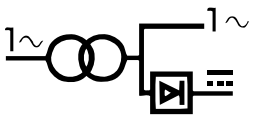
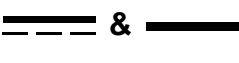

Observe additional Safety Guidelines detailed in the beginning of this manual.

OPERATION

GRAPHIC SYMBOLS THAT APPEAR ON THIS MACHINE OR IN THIS MANUAL

	TIG 2-STEP		AFTERFLOW / AFTERFLOW TIME
	TIG 4-STEP		
	STICK		CONTINUOUS HIGH FREQUENCY
	CURRENT CONTROL OUTPUT		START ONLY HIGH FREQUENCY
	LOCAL CURRENT CONTROL		OFF
	REMOTE CURRENT CONTROL		ON
	INCREASE		CLEAN (INCREASE POSITIVE POLARITY)
	OUTPUT		PENETRATE (INCREASE NEGATIVE POLARITY)
	DECREASE		
	HIGH FREQUENCY		TIG PULSER

GRAPHIC SYMBOLS THAT APPEAR ON THIS MACHINE OR IN THIS MANUAL (CONT.)

	AC WAVE BALANCE		GAS OUTPUT
	PULSED PER SECOND		GAS INPUT
	OVER TEMPERATURE		ELECTRODE CONNECTION
	INPUT POWER		PROTECTIVE GROUND
	DC+ POLARITY		SINGLE PHASE TRANSFORMER AC & DC RECTIFIER POWER SOURCE
	DC- POLARITY		
	DO NOT SWITCH WHILE WELDING		TIG (GTAW)
	WARNING		SINGLE PHASE
	WATER (COOLANT) OUTPUT		WORK CONNECTION
	WATER (COOLANT) INPUT		AC POLARITY

OPERATION

GENERAL DESCRIPTION

The Square Wave TIG 255 is a constant current, single range square wave AC/DC TIG (GTAW) arc welding power source with built-in high frequency stabilization. It also has stick (SMAW) capability. It is available from the factory in one model only; there are no factory installed options, only variations in input voltage and frequency.

The Square Wave TIG 255 includes advanced features such as Auto-Balance™, 2-Step/4-Step Arc Start Switch operation and a TIG pulser. In addition, fixed preflow and variable afterflow timers are included for shielding gas and cooling water control.

Recommended Processes And Equipment

The Square Wave TIG 255 is recommended for the TIG (GTAW) and stick (SMAW) welding processes within its output capacity of 5 to 315 amps, on both AC and DC polarity. It is compatible with all Magnum TIG accessories (see Accessory section in this manual), as well as many industry standard items, such as TIG torches, hoses, and water coolers.

Operational Features and Controls

The Square Wave 255 has the following controls as standard: TIG 2-Step/TIG 4-Step/Stick mode selection, Local/Remote current control selection, Continuous/Start Only/Off high frequency selection, Auto/Manual AC wave balance selection with the manual wave balance adjustment, TIG pulser On/Off selection with frequency adjustment, afterflow adjustment, and DC+/DC-/AC polarity selection.

Design Features and Advantages

- Welding current limit can be preset from 5 to 315 amps and is displayed on the Ammeter when not welding.
- Auto Balance circuitry automatically provides the proper amount of cleaning and penetration when AC TIG welding. Manual AC wave balance adjustment is also possible.
- 2-Step/4-Step Arc Start Switch Capability.
- TIG Pulser with On/Off Selection, and Pulses Per Second adjustment. Background current and duty cycle are automatically adjusted according to the peak welding current.
- Fixed preflow time of 0.5 seconds. Preflow time is eliminated if welding restarts during gas afterflow of previous weld. This avoids unnecessary delays when making repeated welds.
- Adjustable afterflow time control.
- Local/Remote current selection.
- Stick/TIG selection.
- Continuous/Start/Off High Frequency selection.
- DC+/AC/DC- Polarity Switch.
- Power Factor Correction for lower input currents and smaller input wire sizes.
- Remote Receptacle for Amptrol or Arc Start Switch.
- Low Voltage Arc Start Switch Circuit (24 V AC) for maximum operator safety.
- Gas and optional Water Valves: Inlet & outlet fittings conform to Compressed Gas Association (CGA) standards.
- Built-in High Frequency Generator.
- 115 Volt Receptacle with 10 amp Circuit Breaker.
- 220 Volt European (Schuko) type receptacle with 2 amp circuit breaker for water coolers (50/60Hz machines only).
- Excellent arc starting and stability up through 315 amps.
- High resistance to AC arc rectification.
- No tungsten spitting within current range of electrode.
- Compact size, requires only a 19 in x 30 in (485 mm x 760 mm) footprint.
- Designed to NEMA EW-1 & International IEC-974 Standards.
- Single output range of 5-315 amps covers the majority of all TIG welding applications.
- Solid State Output Contactor: no noise, no parts to wear.
- Digital Ammeter and Voltmeter for precise readings from 5 to 315 amps welding.

- Strain relief holes in base for welding cables, gas and water hoses and control cables.
- Easy access for input connections. Connections are simple strip and clamp of input wires (no lugs required).
- Low fan noise at idle.
- Modular construction for easy servicing.
- Simple keypad layout allows even novice users to operate with minimal instruction.
- Unused controls are automatically locked out to simplify setup. Examples: the AC wave balance control has no effect in DC; the High Frequency and gas and water valves do not operate in Stick mode; TIG Pulser is locked out in the Stick mode.
- Recessed panels protect controls, output terminals gas and water fittings.
- Large safety margins and protective circuits protect rectifiers from transient voltages and high currents.
- Submersion dipping of assembled transformer, choke, rectifier in special sealing/insulating material gives added protection against moisture and corrosive atmospheres.
- Line Voltage Compensated.
- Thermostatically Protected.
- Electronic Over Current Protection.
- Hinged Cover over Output Panel.

Welding Capability

The Square Wave TIG 255 is rated at 255 amps, 30 volts, at 40% duty cycle on a ten minute basis. It is capable of higher duty cycles at lower output currents. If the duty cycle(s) are exceeded, a thermal protector will shut off the output until the machine cools to a reasonable operating temperature.

Limitations

Arc Gouging cannot be performed with the Square Wave TIG 255.

The Square Wave TIG 255 is not recommended for pipe thawing.

OPERATION

CONTROLS AND SETTINGS

All operator controls and adjustments are located on the case front of the Square Wave TIG 255. Refer to Figures 3 and 4 and corresponding explanations.

FIGURE 3 - CONTROL PANEL KEYS

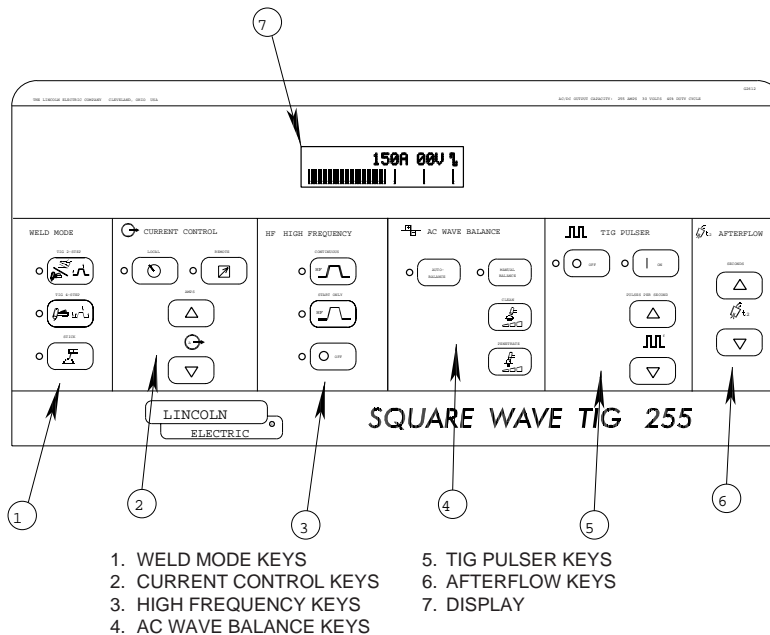

CONTROL PANEL KEYS

The keys are grouped into six areas, described below and in Figure 3. Some areas are active in both TIG and Stick, while others are active in TIG only. The red LED indicator lights are used to tell which functions are active, and the display (Item 1) is used to check the settings of the up/down keys.

- 1. WELD MODE KEYS:** These keys select the Weld Mode desired: TIG 2-Step, TIG 4-Step, or Stick. Read the complete Operating Instructions section for more information on TIG 2-Step and TIG 4-Step.
- 2. CURRENT CONTROL:** This area contains the Local/Remote keys, as well as the Amps Up/Amps Down keys. These keys are used to set the welding current from 5 to 315 amps, as well as to select Local or Remote control. Local control allows the current to be adjusted only with the Amps Up/Amps Down keys. Remote control allows the use of a hand or foot operated remote control. Read the complete Operating Instructions section for more information on Local and Remote.
- 3. HIGH FREQUENCY:** These keys are active in the TIG mode only. Select from Continuous, Start Only, or Off. Read the TIG Welding Section for information on High Frequency.
- 4. AC WAVE BALANCE:** These keys are active in the AC TIG mode only. They are used to set the amount of cleaning and/or penetration produced during an AC TIG weld. Auto Balance™ automatically sets the AC Wave Balance according to the welding current. If manual adjustment is desired, the Manual Balance key can be pressed, and the balance adjusted from +5 (cleaning) to -10 (penetration) with the Cleaning and Penetration keys. Read the Advanced Features section for a complete explanation of the AC Wave Balance.
- 5. TIG PULSER:** These keys are active in the TIG mode only. The On/Off keys turn the TIG Pulser on and off. The Pulses Per Second keys adjust the pulsing frequency up and down, from 0.5 to 10 pulses per second. Read the Advanced Features section for more information on the TIG Pulser.
- 6. AFTERFLOW:** These keys are active in the TIG mode only. They must adjust the afterflow time from 5 to 50 seconds for shielding gas and cooling water flow through solenoids located on the case front. As the Afterflow time is adjusted, the Afterflow time, in seconds, is shown in the Momentary Display.

7. CONTROL PANEL: The display is divided into five sections. See Figures 4A and 4B.

FIGURE 4A - DISPLAY

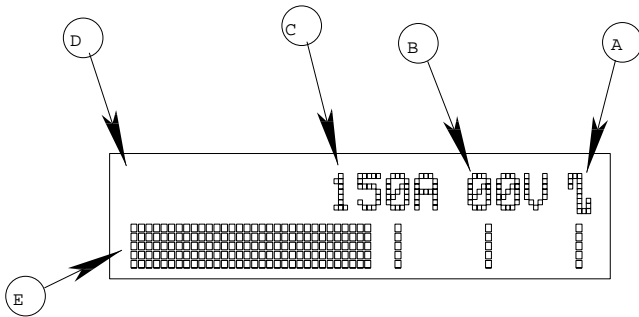

- A. AC/DC INDICATOR
 B. VOLTMETER
 C. AMMETER
 D. MOMENTARY DISPLAY
 E. BAR GRAPH

FIGURE 4B - DISPLAY

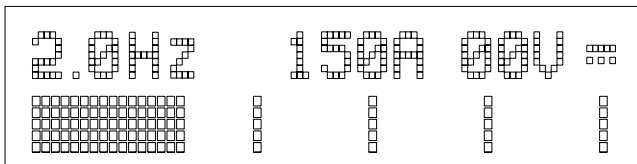

- A. AC/DC INDICATOR: This symbol represents the output polarity of the 255 . . . either AC or DC. AC is shown in Figure 4A; DC is shown in Figure 4B.
- B. VOLTMETER: This meter displays open circuit voltage as well as welding voltage, as measured on the output studs of the Square Wave TIG 255.
- C. AMMETER: The ammeter can display preset current (for setting the welding current before welding) and actual welding current (the value of the welding current during a weld). Read the complete Operating Instructions section for more information on the ammeter.
- D. MOMENTARY DISPLAY: This area is blank under most conditions; see Figure 4A. Different values may be displayed here as certain keypad keys are pressed. See Figure 4B; the TIG Pulser is being adjusted, so the Pulse Frequency, 2.0 Hz, is being displayed. Information in the Momentary Display lasts for five seconds after a key is pressed. Read the complete Operating Instructions section for more information on the values that appear in the Momentary Display.

- E. BAR GRAPH DISPLAY: This area provides a graphical display of values shown on the Ammeter and on the Momentary Display. When the Momentary Display is blank (as in Figure 4A), the Bar Graph Display represents values shown on the ammeter. When a low value is shown on the ammeter, only a few “bars” will appear on the left hand side of the Bar Graph Display. As the ammeter value increases, more and more “bars” will appear. Whenever a value appears in the Momentary Display, the Bar Graph Display will represent the Momentary Display value, not the ammeter value.

CASE FRONT CONTROLS

Refer to Figure 5 for the location of the following controls:

1. POWER SWITCH: Controls the input power to the Square Wave TIG 255.
2. OVER TEMPERATURE LIGHT: A yellow light which only lights when an over temperature situation occurs. See the Maintenance Section for more information on the thermostatic protection.
3. POLARITY SWITCH: Selects DC+, AC or DC- welding polarity. Do not switch under load.

FIGURE 5 - CASE FRONT CONTROLS

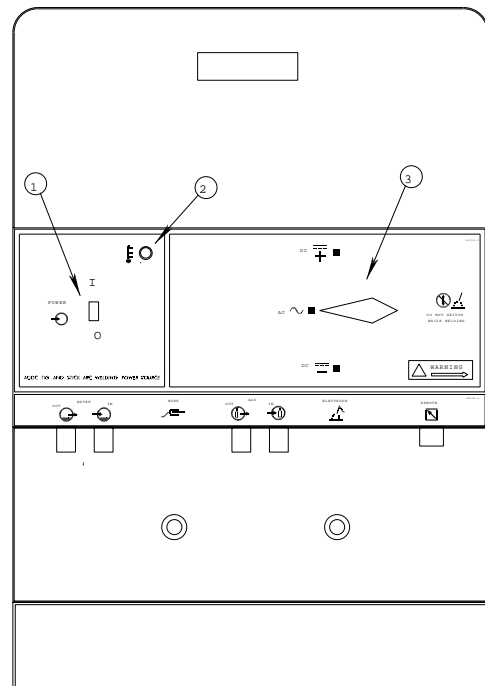

1. POWER SWITCH
2. THERMOSTATIC PROTECTION LIGHT
3. POLARITY SWITCH

OPERATION

HAND AND FOOT AMPCTRL ACCESSORY OPERATION

Both the Hand and Foot Ampctrl work in a similar manner. They are meant to be used for remote current control when Remote Current Control is selected. The TIG 2-Step mode must be selected when using an Ampctrl for remote current control. As explained below, Ampctrls can also be used as arc start switches if Local Current Control is selected.

For simplicity, the following explanation will refer only to "Ampctrls", meaning both Foot and Hand models. The term "minimum" refers to a Foot pedal in the "up" position, as it would be with no foot pressure, or a Hand Ampctrl in the relaxed position, with no thumb pressure. "Maximum" refers to a fully depressed Foot Ampctrl, or a fully extended Hand Ampctrl.

The Ampctrl is capable of controlling the output current from 5 amps to the preset current displayed on the ammeter. For example, if the ammeter is preset for 200 amps and the Current Control switch is in the REMOTE position, the Ampctrl, when depressed just past its minimum position, will cause the Square Wave TIG 255 to weld at 5 amps. At the Ampctrls maximum position, the output would be near 200 amps.

It is important to note that, for many applications, the tungsten will not start an arc at only 5 amps. To start an arc reliably, it is important to depress the Ampctrl far enough so that the machine output current is near the tungsten operating range. In the example above, a 3/32" tungsten may be used on DC- to weld near 200 amps. To start the weld, the operator may have to depress the Ampctrl approximately 1/4 of the way down, or to nearly 50 amps, in order to start the arc. Merely depressing the Ampctrl to its 5 amp minimum position will not start the arc.

If the Current Control switch is set to the LOCAL position, an Ampctrl can be used as an arc start switch. Depressing the Ampctrl just past minimum will cause the Ampctrls built-in arc start switch to close, and backing off completely causes the built-in start switch to open. The Ampctrl will have no effect on the welding current when used as an arc start switch.

WELDING OPERATION

TIG Welding

Familiarize yourself with the Controls and Display Section before attempting operation of the Square Wave TIG 255.

TIG Welding Guidelines

TIG welding can be done in either the TIG 2-Step or the TIG 4-Step Weld Mode. TIG 2-Step is typically used with Hand or Foot Ampctrls, with Remote Current control. TIG 4-Step is typically used with Arc Start switches and Local Current Control, because it provides a very brief current upslope, and a 5-second current downslope. TIG 4-Step also functions like a trigger interlock, making it unnecessary to hold down the Arc Start switch during a weld. Note, on later versions, TIG 4-Step was made available for use with Remote Current Control with the release of ROM version S21228-4 (initiated on Control board G2150-3 on codes 10022 and higher). This feature requires that the remote control device in use must have separate Arc Start and Output Control mechanisms. Read the TIG Welding Sequence of Operation sections for more details on 2-Step and 4-Step Operation.

**TABLE 2
RECOMMENDED POLARITY
SETTINGS FOR TIG WELDING**

Type of Welding	Electrode Polarity	High Frequency Setting
Stainless Steel	DC-	START
Aluminum & Magnesium	AC	CONTINUOUS
Other Metals	DC-	START

TABLE 3
TYPICAL CURRENT RANGES ⁽¹⁾ FOR TUNGSTEN ELECTRODES ⁽²⁾

Tungsten Electrode Diameter in. (mm)	DCEN (-)	DCEP (+)	AC				Approximate Argon Gas Flow Rate C.F.H. (1/min.)		TIG Torch Nozzle Size ^{(4), (5)}
			Unbalanced Wave		Balanced Wave		Aluminum	Stainless Steel	
			1%, 2% Thoriated Tungsten	1%, 2% Thoriated Tungsten	Pure Tungsten	1%, 2% Thoriated Tungsten Zirconiated			
.010 (.25)	2-15	⁽³⁾	2-15	2-15	2-15	---	3-8 (2-4)	3-8 (2-4)	#4, #5, #6
0.020 (.50)	5-20	⁽³⁾	5-15	5-20	10-20	5-20	5-10 (3-5)	5-10 (3-5)	
0.040 (1.0)	15-80	⁽³⁾	10-60	15-80	20-30	20-60	5-10 (3-5)	5-10 (3-5)	
1/16 (1.6)	70-150	10-20	50-100	70-150	30-80	60-120	5-10 (3-5)	9-13 (4-6)	#5, #6
3/32 (2.4)	150-250	15-30	100-160	140-235	60-130	100-180	13-17 (6-8)	11-15 (5-7)	#6, #7, #8
1/8 (3.2)	250-400	25-40	150-210	225-325	100-180	160-250	15-23 (7-11)	11-15 (5-7)	
5/32 (4.0)	400-500	40-55	200-275	300-400	100-240	200-320	21-25 (10-12)	13-17 (6-8)	#8, #10
3/16 (4.8)	500-750	55-80	250-350	400-500	190-300	290-390	23-27 (11-13)	18-22 (8-10)	
1/4 (6.4)	750-1000	80-125	325-450	500-630	250-400	340-525	28-32 (13-15)	23-27(11-13)	

- (1) When used with argon gas. The current ranges shown must be reduced when using argon/helium or pure helium shielding gasses.
- (2) Tungsten electrodes are classified as follows by the American Welding Society (AWS):
 Pure EWP
 1% Thoriated EWTh-1
 2% Thoriated EWTh-2
 Though not yet recognized by the AWS, Ceriated Tungsten is now widely accepted as a substitute for 2% Thoriated Tungsten in AC and DC applications.
- (3) DCEP is not commonly used in these sizes.
- (4) TIG torch nozzle "sizes" are in multiples of 1/16ths of an inch:
 #4 = 1/4 in. (6 mm)
 #5 = 5/16 in. (8 mm)
 #6 = 3/8 in. (10 mm)
 #7 = 7/16 in. (11 mm)
 #8 = 1/2 in. (12.5 mm)
 #10 = 5/8 in. (16 mm)
- (5) TIG torch nozzles are typically made from alumina ceramic. Special applications may require lava nozzles, which are less prone to breakage, but cannot withstand high temperatures and high duty cycles.

TIG WELDING SEQUENCE OF OPERATION (2-STEP MODE)

1. Connect an Arc Start Switch or an Amptrol to the Remote Receptacle.
2. Turn on the welder, gas supply and water supply (if so equipped). The Control Panel Display and red LEDs will illuminate when the power is on.
3. Select the TIG 2-Step Weld Mode.
4. Select Local (if using an Arc Start Switch) or Remote (if using an Amptrol) current control. Set the output current using the Amps Up/Down keys. The output current setting will be displayed on the Ammeter.
5. Select Continuous High Frequency if welding with AC polarity, or Start Only High Frequency if welding with DC- polarity. High Frequency Off can be used for scratch start welding.
6. Select AC or DC- electrode polarity. See Table 2.
7. If welding with AC polarity, select Auto Balance™. This gives the optimum ratio between cleaning and penetration, automatically adjusted for the output current. If manual adjustment of the AC Wave Balance is desired, select Manual Balance, and adjust the wave balance with the Cleaning and Penetration keys. See the Advanced Features section for more information on setting and using the AC Wave Balance.
8. Select TIG Pulser On or Off. If the TIG Pulser is on, adjust the pulse frequency with the Pulses Per Second Up/Down keys. See the Advanced Features section for more information on setting and using the TIG Pulser.
9. Set the Afterflow time with the Seconds Up/Down keys. Afterflow time provides shielding gas flow (and cooling water, if used) after the weld. Use short Afterflow times with low currents and small tungstens, use long afterflow times at high output currents with large tungstens.

OPERATION

10. Press and release the Arc Start Switch, and set the gas flow meter. The welder is now ready for welding.
 11. Position the tungsten electrode at the start of the weld at a 65 to 75 angle with the horizontal so that the electrode is approximately 1/8" (4mm) above the work piece. Press the Arc Start Switch. This opens the gas and water valves to automatically purge air from the hose and torch. After a 0.5 second preflow time, the high frequency becomes available to strike the arc.
 12. Hold the Arc Start Switch or Amptrol down until an arc is established. If using an Amptrol, read the section on Hand and Foot Amptrol Operation. Release the Arc Start Switch or Amptrol to stop the arc and start the Afterflow timer. After the Afterflow time has expired, the gas and water valves will close. To make another weld, repeat steps 11 and 12.
9. Set the Afterflow time with the Seconds Up/Down keys. Afterflow time provides shielding gas flow (and cooling water, if used) after the weld. Use short Afterflow times with low currents and small tungstens, long afterflow times at high output currents with large tungstens.
 10. Press and release the Arc Start Switch, and set the gas flow meter. The welder is now ready for welding.
 11. Position the tungsten electrode at the start of the weld at a 65 to 75 angle with the horizontal so that the electrode is approximately 1/8" (4mm) above the work piece. Press the Arc Start Switch. This opens the gas and water valves to automatically purge air from the hose and torch. After a 0.5 second preflow time, the high frequency becomes available to strike the arc.
 12. Hold the Arc Start Switch down until an arc is established. The arc will start at a low current value. Release the Arc Start Switch. At this point, the Square Wave TIG 255 will quickly ramp up to the welding current, and the weld will continue indefinitely. Press the Arc Start Switch a second time to initiate a 5-second downslope. The current will go down to a crater fill current that is equal to 25% of the welding current. Release the Arc Start Switch to stop the arc and start the Afterflow timer. After the Afterflow time has expired, the gas and water valves will close. To make another weld, repeat steps 11 and 12.

TIG WELDING SEQUENCE OF OPERATION (4-Step Mode)

1. Connect an Arc Start Switch to the Remote Receptacle.
2. Turn the welder, gas supply and water supply (if so equipped), on. The Control Panel Display and red LEDs will illuminate when the power is on.
3. Select the TIG 4-Step Weld Mode.
4. Select the Local current control. Set the output current using the Amps Up/Down keys. The output current setting will be displayed on the Ammeter. On later version machines, remote control is also available in TIG 4-Step mode on codes 10022 and higher utilizing ROM version S21228-4 and higher provided that the remote control used has separate Arc Start and Output Control mechanisms.
5. Select Continuous High Frequency if welding with AC polarity, or Start Only High Frequency if welding with DC- polarity. High Frequency Off can be used for scratch start welding.
6. Select AC or DC- electrode polarity. See Table 2.
7. If welding with AC polarity, select Auto Balance™. This gives the optimum ratio between cleaning and penetration, automatically adjusted for the output current. If manual adjustment of the AC Wave Balance is desired, select Manual Balance, and adjust the wave balance with the Cleaning and Penetration keys. See the Advanced Features section for more information on setting and using the AC Wave Balance.
8. Select TIG Pulser On or Off. If the TIG Pulser is on, adjust the pulse frequency with the Pulses Per Second Up/Down keys. See the Advanced Features section for more information on setting and using the TIG Pulser.

ADVANCED TIG WELDING FEATURES

AC Wave Balance and Auto Balance™

AC Wave Balance is a feature unique to square wave TIG power sources. It is active only in AC TIG mode. It controls the amount of positive and negative current in the AC output.

The Square Wave TIG 255 allows the operator to select Auto Balance™. This selection provides automatic adjustment of the AC Wave Balance; it is suitable for most welding conditions. Auto Balance gives the ideal amount of cleaning and penetration, based on the welding current output.

Manual adjustment of the AC Wave Balance is also possible. Select the Manual Balance key, and the Balance setting will appear in the Momentary Display. Manual Balance settings vary from +5 (maximum cleaning) to -10 (maximum penetration). A setting of 0 yields a balanced output (equal amounts of cleaning and penetration). Use the following as a guide when setting the Balance manually:

BALANCED (0): The amounts of positive and negative are the same.

CLEANING (+1 to +5): Provides more positive current than negative. Since the positive current produces the “cleaning” or oxide removal on aluminum, this setting is used for welding on heavily oxidized aluminum.

PENETRATION (-1 to -10): Provides more negative current than positive. The arc plasma will be more concentrated and more easily directed to where the heat is needed. Higher penetration settings allow a given size of tungsten to carry more current.

CAUTION: Use only the amount of cleaning required because the greater amount of positive current will heat the tungsten more and possibly cause it to melt or “spit”. Also, the arc is usually more flared and less stable with more cleaning current.

In general, use just enough “cleaning” to remove oxides and to give good wetting to the puddle.

TIG Pulser

The Square Wave TIG 255 contains a unique TIG Pulser circuit. The TIG Pulser has On/Off selections, as well as adjustments for Pulses Per Second Up/Down. When the Pulser is turned On, or when the Pulses Per Second are adjusted, the pulse frequency is shown in the Momentary Display. It can be varied from 0.5 Hz to 10 Hz in 0.5 Hz increments. (One Hertz {Hz} is equivalent to one pulse per second.) The background current (the welding current at the low point of the pulse cycle) is automatically adjusted from 40% to 60% of the peak current by the Square Wave TIG 255. The duty cycle (the ratio between that time spent at the peak current vs, the time spent at the background current) is fixed at 50%.

STICK WELDING

1. Remove the amptrol or Arc Start Switch from the Remote Receptacle.
2. Turn the welder on. The Control Panel Display and red LEDs will illuminate when the power is on.
3. Select Stick Mode and Local Current Control. Set the output current using the Amps Up/Down keys. The output current setting will be displayed on the Ammeter. No other functions or adjustments operate in the Stick Mode.
4. Select DC+, AC or DC- electrode polarity.

5. Clamp the electrode in the electrode holder, start the weld by lightly touching the electrode to the work. Stop the weld by pulling the electrode away from the work piece. Note, in Stick Mode the output studs remain electrically “HOT”.

AUXILIARY POWER

ALL MACHINES

The Square Wave TIG 255 provides 10 amps of 115 volt AC power at a standard NEMA 5-15R receptacle, located on the lower case back of the machine. This circuit is protected from shorts and overloading by a 10 amp circuit breaker, located next to the receptacle. The auxiliary circuit is intended for running water coolers and small power tools, whose current draw is within the 10 amp rating. Note that some types of equipment, especially pumps and large motors, have starting currents which are significantly higher than their running current. These higher starting currents may cause the circuit breaker to open. If this situation occurs, the user should refrain from using the Square Wave TIG 255 auxiliary for that equipment.

50/60Hz MACHINES - (Codes 10024 thru 10026 & 10134)

Square Wave TIG 255 machines rated for 50/60Hz operation provide 2 amps of 220 volt AC power at a continental European (Schuko) type receptacle, located on the lower case back of the machine. This circuit is protected from shorts and overloading by a 2 amp circuit breaker, located above the receptacle. The auxiliary circuit is intended for running water coolers whose current draw is within the 2 amp rating of the receptacle. Note that some types of equipment, especially pumps and motors, have starting currents which are significantly higher than their running currents. These higher starting currents may cause the circuit breaker to open. If this situation occurs, the user should refrain from using the Square Wave TIG 255 auxiliary for that equipment.

OVERLOAD PROTECTION

This welder has thermostatic protection from excessive duty cycles, overloads, loss of cooling, and high ambient temperatures. When the welder is subjected to an overload or loss of cooling, a thermostat will open. This condition will be indicated by the illumination of the yellow Thermostatic Protection Light on the case front (see Figure 2). Also, the Display will be blank, and all of the red Control Panel LEDs will be out. The fan will continue to run to cool the power source. No welding is possible until the machine is allowed to cool and the Thermostatic Protection Light goes out.

OPTIONS / ACCESSORIES

- Hand Amptrol (K963)
- Foot Amptrol (K870)
- Arc Start Switch (K814)
- Magnum Cooler Horizontal TIG Mounting Bracket (K559-2)
- Undercarriage (K932-1)

UNDERCARRIAGE FUNCTION

The Square Wave TIG 255 is designed to be used with a Lincoln K932-1 Undercarriage. Complete installation instructions are included with the K932-1 undercarriage. When the undercarriage is properly installed, the Square Wave TIG 255 lift bail is non-functional. Do not attempt to lift the power source with the undercarriage attached. The undercarriage is designed for hand moving only; mechanized towing can lead to injury and/or damage to the Square Wave TIG 255.

INSTALLATION OF FIELD INSTALLED OPTIONS

Instructions for connecting the K932-1 Undercarriage and the K559-2 Magnum Cooler Horizontal TIG Mounting Bracket are included with those accessories.

Installation of the K963 Hand Amptrol, the K814 Arc Start Switch and K870 Foot Amptrol are as follows:

Lift the Output Cover Door (if so equipped) on the Square Wave TIG 255. Feed the cable up through the strain relief holes in the base, and connect the 6-pin MS-type (Amphenol) connector to the Remote Receptacle (See Figure 2). Secure with the threaded collar.

MAINTENANCE

Safety Precautions

WARNING



ELECTRIC SHOCK can kill.

- Only qualified personnel should perform this maintenance.
- Turn the input power **OFF** at the disconnect switch or fuse box before working on this equipment.
- Do not touch electrically hot parts.

Routine and Periodic Maintenance

WARNING

To avoid receiving a high frequency shock, keep the TIG torch and cables in good condition.

1. Disconnect power supply lines to machine before performing periodic maintenance.
2. Periodically clean the inside of the machine with a low pressure air system. Be sure to clean the following components thoroughly. See Figure 6 for location of those components.
 - Main Transformer
 - Output Studs
 - Polarity Switch
 - Rectifier Assembly
 - Control Box Assembly
 - Spark Gap Assembly
 - Protection PC Board - (Mounted to rear of control box assembly)
3. Inspect welder output and control cables for fraying, cuts, and bare spots.
4. Keep TIG torch and cables in good condition.
5. The fan motor has sealed ball bearings which require no maintenance.
6. Inspect spark gap spacing at regular intervals to maintain a 0.015 in (0.4mm) gap. (Smallest possible air gap consistent with good welding is desirable to minimize R.F.I. problems.) Dressing or any refinishing of the spark gap contacts is not recommended. If the contact surfaces become irregular or completely eroded, replacement of both electrodes is recommended.

MAINTENANCE

FIGURE 6 - GENERAL ASSEMBLY EXPLODED VIEW

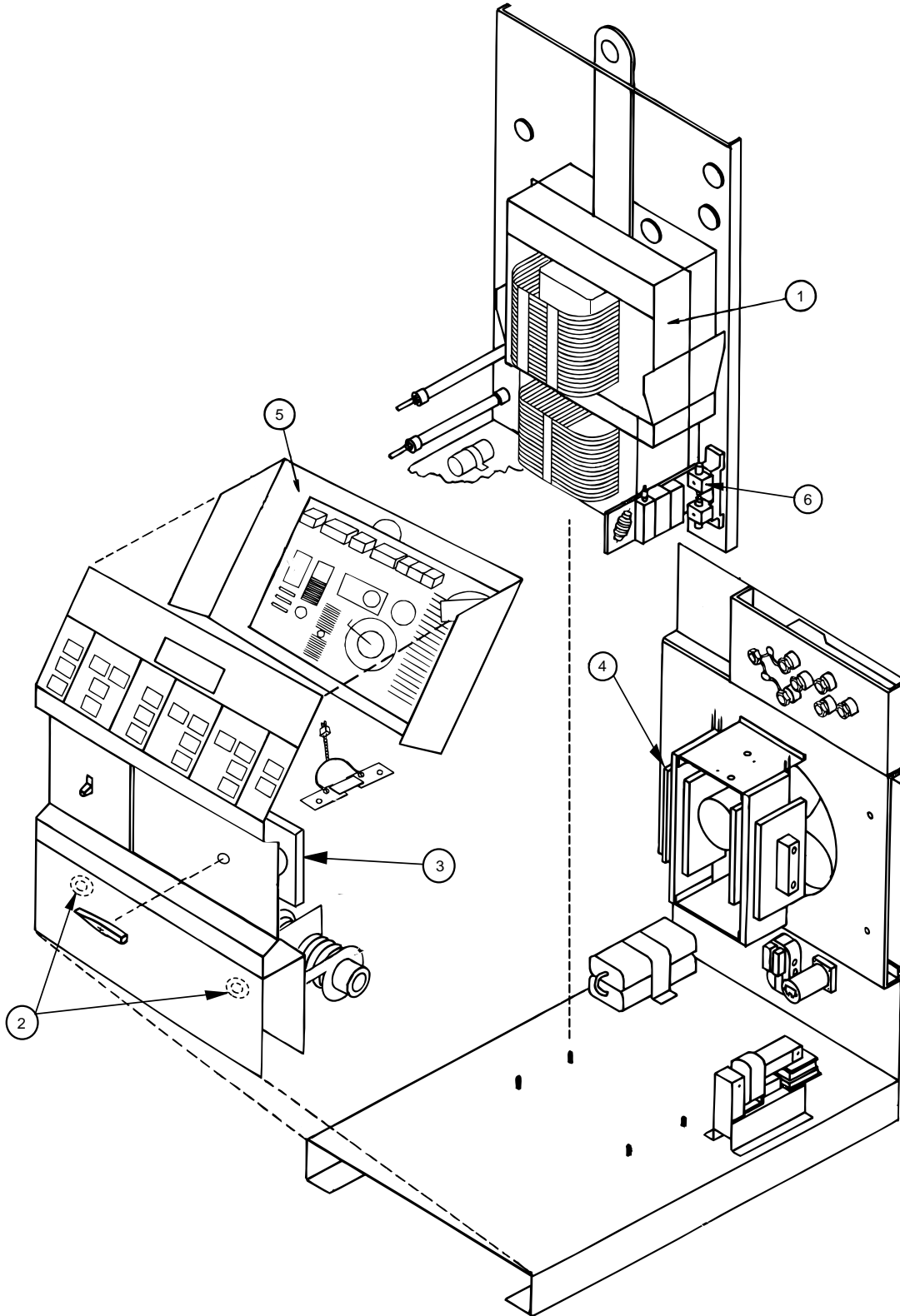

- 1. MAIN TRANSFORMER
- 2. OUTPUT STUDS
- 3. POLARITY SWITCH
- 4. RECTIFIER ASSEMBLY

- 5. CONTROL BOX ASSEMBLY
- 6. SPARK GAP ASSEMBLY
- 7. PROTECTION PC BOARD -
(Mounted to rear of control box assembly)

How To Use Troubleshooting Guide

WARNING

This Troubleshooting Guide is designed to be used by the machine Owner/Operator. Unauthorized repairs performed on this equipment may result in danger to the technician and machine operator and will invalidate your factory warranty. For your safety, please observe all safety notes and precautions detailed in the Safety Section of this manual to avoid electrical shock or danger while troubleshooting this equipment.

This Troubleshooting Guide is provided to help you locate and correct possible machine misadjustments. Simply follow the three-step procedure listed below.

Step 1. LOCATE PROBLEM (SYMPTOM)

Look under the column labeled "PROBLEM (SYMPTOMS)". This column describes possible symptoms that your machine may exhibit. Find the listing that best describes the symptom that your machine is exhibiting.

Step 2. PERFORM EXTERNAL RECOMMENDED TESTS

The second column labeled "POSSIBLE AREAS OF MISADJUSTMENT(S)" lists the obvious external possibilities that may contribute to the machine symptom. Perform these tests/checks in the order listed. In general, these tests can be conducted without removing the case wrap-around cover.

Step 3. CONSULT LOCAL AUTHORIZED FIELD SERVICE FACILITY

If you have exhausted all of the recommended tests in step 2, consult your local Authorized Field Service Facility.

CAUTION

If for any reason you do not understand the test procedures or are unable to perform the tests/repairs safely, contact your local Authorized Field Service Facility for technical troubleshooting assistance before you proceed.

TROUBLESHOOTING

Troubleshooting Guide

Observe Safety Guidelines detailed in the beginning of this manual.

PROBLEMS (SYMPTOMS)	POSSIBLE AREAS OF MISADJUSTMENT(S)	RECOMMENDED COURSE OF ACTION
OUTPUT PROBLEMS		
Major Physical or Electrical Damage is Evident.	1. Contact The Lincoln Electric Service Dept. (216) 383-2531	<p>If all recommended possible areas of misadjustment have been checked and the problem persists, Contact your local Lincoln Authorized Field Service Facility.</p>
Machine is Dead - No Output - No Fan No Displays.	<ol style="list-style-type: none"> 1. Make certain that the input power switch is in the "ON" position. 2. Check the input voltage at the machine. Input voltage must match the rating plate and reconnect the panel. 3. Blown or missing fuses in input line. 	
Fan runs - Display and control panel dark. No output from machine in either Stick or TIG modes.	1. Check for proper input voltages. As per nameplate and reconnect panel.	
The voltmeter reads "00" in Stick Mode, and there is no output from the machine when in the TIG 2-Step Mode.	1. Inspect to assure that the arc start switch is in the on (closed) position when welding in the TIG Mode.	
Machine does not respond (no gas flow, no high frequency and no open circuit voltage) when arc switch or amptrol is activated - displays and fan working.	<ol style="list-style-type: none"> 1. Machine MUST be in one of the TIG Modes. 2. The arc start switch or amptrol may be defective. Check for continuity between pins "D" and "E" on cable connector when arc switch or amptrol is activated. 	
115VAC Receptacle not working properly (voltage is below 108VAC). Machine has welding output - fan is running.	1. Check for 115VAC at receptacle - if low (below 108VAC), then check input voltage to machine.	

CAUTION

If for any reason you do not understand the test procedures or are unable to perform the tests/repairs safely, contact your local Authorized Field Service Facility for technical troubleshooting assistance before you proceed.

Observe Safety Guidelines detailed in the beginning of this manual.

PROBLEMS (SYMPTOMS)	POSSIBLE AREAS OF MISADJUSTMENT(S)	RECOMMENDED COURSE OF ACTION
OUTPUT PROBLEMS		
Machine regularly over heats - thermostat opens, PL1 (yellow light on front panel) glows. The fan runs but machine has no output and no display.	<ol style="list-style-type: none"> 1. Welding application may exceed recommended duty cycle. 2. Dirt and dust may have clogged the cooling channels inside the machine. Blow out unit with clean, dry compressed air. 3. Air intake and exhaust louvers may be blocked due to inadequate clearance around machine. 	<p>If all recommended possible areas of misadjustment have been checked and the problem persists, Contact your local Lincoln Authorized Field Service Facility.</p>
<p>Machine makes a very loud buzzing noise in DC Stick Mode, or in DC TIG Mode when the arc start or amptrol is pressed.</p> <p>There is no current draw from machine's output studs. (The machine is not externally loaded).</p>	<ol style="list-style-type: none"> 1. Inspect output stud insulators for cracks or signs of overheating. 	

 CAUTION

If for any reason you do not understand the test procedures or are unable to perform the tests/repairs safely, contact your local Authorized Field Service Facility for technical troubleshooting assistance before you proceed.

TROUBLESHOOTING

Troubleshooting Guide

Observe Safety Guidelines detailed in the beginning of this manual.

PROBLEMS (SYMPTOMS)	POSSIBLE AREAS OF MISADJUSTMENT(S)	RECOMMENDED COURSE OF ACTION
FUNCTION PROBLEMS		
The yellow light (PL1) on the front panel is not lit.	1. Normal condition - this light will glow only if machine is in an overheated condition. (Thermal overload).	If all recommended possible areas of misadjustment have been checked and the problem persists, Contact your local Lincoln Authorized Field Service Facility.
One or more keypad lights (LEDS) are dark and cannot be lit when their respective keys are pressed - machine is operable.	1. Be sure that the proper weld mode is selected. For example, the high frequency keys and keypad lights (LEDS) are not active in the stick mode.	
The Beeper (Piezoelectric Buzzer) cannot be heard - machine operating normally.	1. Background noise may be too loud for user to hear beeper.	

CAUTION

If for any reason you do not understand the test procedures or are unable to perform the tests/repairs safely, contact your local Authorized Field Service Facility for technical troubleshooting assistance before you proceed.

Observe Safety Guidelines detailed in the beginning of this manual.

PROBLEMS (SYMPTOMS)	POSSIBLE AREAS OF MISADJUSTMENT(S)	RECOMMENDED COURSE OF ACTION
TIG MODE PROBLEMS		
Machine output is intermittently lost. Gas flow and high frequency are also interrupted.	<ol style="list-style-type: none"> 1. Problem may be caused by high frequency interference. Make sure that the machine is grounded properly according to the installation instructions. If there are other high frequency sources in the area, make certain that they are grounded properly. 2. Check arc start switch or amptrol for proper operation and loose connections. 	<p>If all recommended possible areas of misadjustment have been checked and the problem persists, Contact your local Lincoln Authorized Field Service Facility.</p>
Arc "Flutters" when TIG welding.	<ol style="list-style-type: none"> 1. Tungsten electrode may be too large in diameter. 2. Tungsten not "Sharp" when welding in DC negative mode. 3. If helium is used as a shielding gas, then reduce the percentage of helium. 4. Adjust flow rate of shielding gas. 5. Check hoses and connections for leaks. 	
Lack of penetration in AC TIG welding.	<ol style="list-style-type: none"> 1. Manual balance control set improperly - set to negative 10 (-10) for maximum penetration. 	
Black areas along weld bead.	<ol style="list-style-type: none"> 1. Tungsten electrode may be contaminated. Replace or sharpen. 2. Shielding gas flow may be insufficient. 3. Contaminated gas or faulty gas line or torch. 	
Black areas along weld bead at or near end of weld.	<ol style="list-style-type: none"> 1. Increase post flow time. 	

CAUTION

If for any reason you do not understand the test procedures or are unable to perform the tests/repairs safely, contact your local Authorized Field Service Facility for technical troubleshooting assistance before you proceed.

TROUBLESHOOTING

Troubleshooting Guide

Observe Safety Guidelines detailed in the beginning of this manual.

PROBLEMS (SYMPTOMS)	POSSIBLE AREAS OF MISADJUSTMENT(S)	RECOMMENDED COURSE OF ACTION
TIG WELDING PROBLEMS		
Machine has low output when in TIG 4-Step Mode.	<ol style="list-style-type: none"> 1. Machine must be in "Local" Control Mode when 4-Step is used. 	<p>If all recommended possible areas of misadjustment have been checked and the problem persists, Contact your local Lincoln Authorized Field Service Facility.</p>
Weak high frequency - machine has normal welding output.	<ol style="list-style-type: none"> 1. Spark gap may be misadjusted. Check and reset per maintenance instructions. 2. Improper shielding gas flow. Adjust for a flow of 10 to 30 CFH (4.7 to 14.1 l/min.) for most applications. 3. Work and electrode cables in poor condition allowing high frequency to "Leak Off". Use good quality cables with a high natural rubber content, such as Lincoln Stable Arc Cable. Cables should be as short as possible. 	
The display shows zero amps, but indicates open circuit voltage (approximately 53V). The arc start switch or amptrol is <u>not</u> actuated.	<ol style="list-style-type: none"> 1. The arc start switch or amptrol may be defective. There should <u>not</u> be any continuity between pins "D" and "E" on the arc start cable connector, unless the unit is actuated. 2. If an amptrol is not being used, the machine <u>must</u> be in the Local Control Mode. 	
High frequency "Spark" is present at tungsten electrode, but operator is unable to establish a welding arc. Machine has normal open circuit voltage (approximately 53V).	<ol style="list-style-type: none"> 1. Torch may be faulty. 2. If an amptrol is not being used, then the machine must be in the Local Control Mode. 3. Tungsten electrode may be too large for the process. 4. If helium shielding gas is being used, then reduce percentage of helium. 5. If TIG welding in the DC negative mode, then a properly sharpened thoriated tungsten should be used. 6. Check the welding cables and output stud connections. 	

CAUTION

If for any reason you do not understand the test procedures or are unable to perform the tests/repairs safely, contact your local Authorized Field Service Facility for technical troubleshooting assistance before you proceed.

Observe Safety Guidelines detailed in the beginning of this manual.

PROBLEMS (SYMPTOMS)	POSSIBLE AREAS OF MISADJUSTMENT(S)	RECOMMENDED COURSE OF ACTION
TIG WELDING PROBLEMS		
No high frequency. Machine is in the TIG Mode and has normal output.	<ol style="list-style-type: none"> 1. In order for the high frequency to operate, the machine must be either in the start only Mode or the continuous high frequency mode. 2. The high frequency spark gap may be too large or shorted. Check gap as per maintenance instructions. 	<p>If all recommended possible areas of misadjustment have been checked and the problem persists, Contact your local Lincoln Authorized Field Service Facility.</p>
No gas or water flow when arc start switch or amptrol is activated in the TIG Mode. Machine has output - fan runs. When toggling between the Stick and TIG Modes a "Click" <u>can</u> be heard indicating that the solenoids are operating.	<ol style="list-style-type: none"> 1. Gas supply is empty or not turned on. 2. Gas or water hose may be pinched. 3. Gas or water solenoid may be blocked with dirt. Use filters to prevent reoccurrence. Consult your Local welder/gas distributor. 	
Arc rectification when AC TIG welding.	<ol style="list-style-type: none"> 1. Tungsten electrode may be too small for process. 2. Manual balance control may be misadjusted. Readjust to the negative direction. 3. If helium gas is being used, reduce percentage of helium. 	

 CAUTION

If for any reason you do not understand the test procedures or are unable to perform the tests/repairs safely, contact your local Authorized Field Service Facility for technical troubleshooting assistance before you proceed.

TROUBLESHOOTING

Troubleshooting Guide

Observe Safety Guidelines detailed in the beginning of this manual.

PROBLEMS (SYMPTOMS)	POSSIBLE AREAS OF MISADJUSTMENT(S)	RECOMMENDED COURSE OF ACTION
STICK WELDING PROBLEMS		
Stick electrode "Blasts Off" when arc is struck.	<ol style="list-style-type: none"> 1. Weld current is set too high for recommended electrode size. Reduce preset current adjustment. 	<p>If all recommended possible areas of misadjustment have been checked and the problem persists, Contact your local Lincoln Authorized Field Service Facility.</p>
Cannot adjust AC Wave Balance when welding in the Stick Mode.	<ol style="list-style-type: none"> 1. This is a normal condition. Wave balance keys are automatically disabled in the Stick Mode. 	
Machine welds at a very low output regardless of the preset current setting - arc is stable.	<ol style="list-style-type: none"> 1. If welding in the Remote Control Mode, the remote amptrol may be defective or not installed properly. 2. If the output is low when the machine is in the Local Control Mode, the problem could be internal to the machine. 	
Variable or sluggish welding arc when welding in the Stick Mode.	<ol style="list-style-type: none"> 1. Check work and electrode cables for loose or poor connections. 2. The weld cables may be too small or too long to permit the desired current to flow. 3. The preset current adjustment may be set too low. 	

CAUTION

If for any reason you do not understand the test procedures or are unable to perform the tests/repairs safely, contact your local Authorized Field Service Facility for technical troubleshooting assistance before you proceed.

WIRING DIAGRAM - SQUARE WAVE TIC 255 CODE 10022, 10023 & 10024

WIRING DIAGRAM

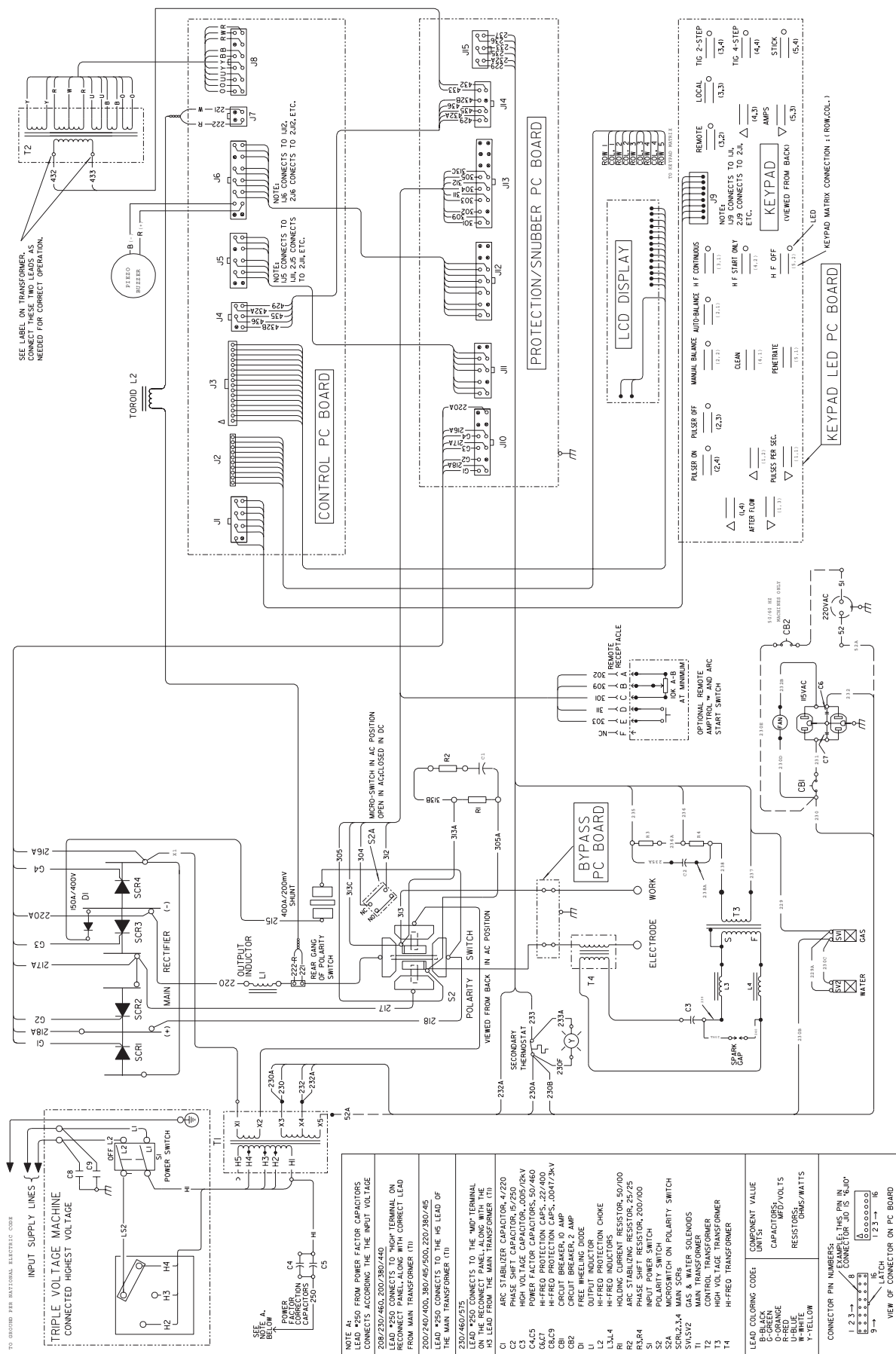

TO GROUND PER NATIONAL ELECTRIC CODE

INPUT SUPPLY LINES
TRIPLE VOLTAGE MACHINE
CONNECTED HIGHEST VOLTAGE

- NOTE 1:** LEAD #250 FROM POWER FACTOR CAPACITORS CONNECTS ACCORDING TO THE INPUT VOLTAGE 208/230/460, 200/380/440
- NOTE 2:** LEAD #250 CONNECTS TO "HIGH" TERMINAL ON RECONNECT PANEL, ALONG WITH CORRECT LEAD FROM MAIN TRANSFORMER (T1)
- NOTE 3:** LEAD #250 CONNECTS TO THE H5 LEAD OF THE MAIN TRANSFORMER (T1)
- NOTE 4:** LEAD #250 CONNECTS TO THE "WD" TERMINAL ON THE RECONNECT PANEL, ALONG WITH THE H3 LEAD FROM MAIN TRANSFORMER (T1)
- C1 MAN. STABILIZER CAPACITOR, 4/220
 - C2 PHASE SHIFT CAPACITOR, 15/250
 - C3 HIGH VOLTAGE CAPACITOR, .005/28V
 - C4,C5 POWER FACTOR CAPACITORS, 50/460
 - C6,C7 H-FRED PROTECTION CAPS, 22/400
 - C8,C9 H-FRED PROTECTION CAPS, .0047/3kV
 - CB1 CIRCUIT BREAKER, 2 AMP
 - CB2 FREE WHEELING DIODE
 - D1
 - L1 OUTPUT INDUCTOR
 - L2 H-FRED PROTECTION CHoke
 - L3,L4
 - R1 ARC STABILIZING RESISTOR, 25/25
 - R2 ARC STABILIZING RESISTOR, 200/100
 - R3,R4
 - S1 INPUT POWER SWITCH
 - S2 POLARITY SWITCH
 - SCR1,2,3,4 MAIN SCRS
 - SW1,SV2 GAS & WATER SOLENOIDS
 - T1 MAIN TRANSFORMER
 - T2 CONTROL TRANSFORMER
 - T3 H-FRED PROTECTION TRANSFORMER
 - T4 H-FRED TRANSFORMER
- LEAD COLORING CODE:** COMPONENT VALUE UNITS:
 B-BLACK CAPACITORS: MFD/VOLTS
 G-GREEN RESISTORS: OHMS/WATTS
 R-RED
 U-BLUE
 Y-YELLOW
- CONNECTOR PIN NUMBERS:** THIS PIN IS "GND"
 1 2 3 → 8 CONNECTOR J10 (10-100)
 4 5 6 7 8 9
 1 2 3 → 16 LATCH
 4 5 6 7 8 9
 VIEW OF CONNECTOR ON PC BOARD

NOTE: This diagram is for reference only. It may not be accurate for all machines covered by this manual. The specific diagram for a particular code is pasted inside the machine on one of the enclosure panels. If the diagram is illegible, write to the Service Department for a replacement. Give the equipment code number.

WIRING DIAGRAM

WIRING DIAGRAM - SQUARE WAVE TIG 255 CODE 10451, 10452 & 10453

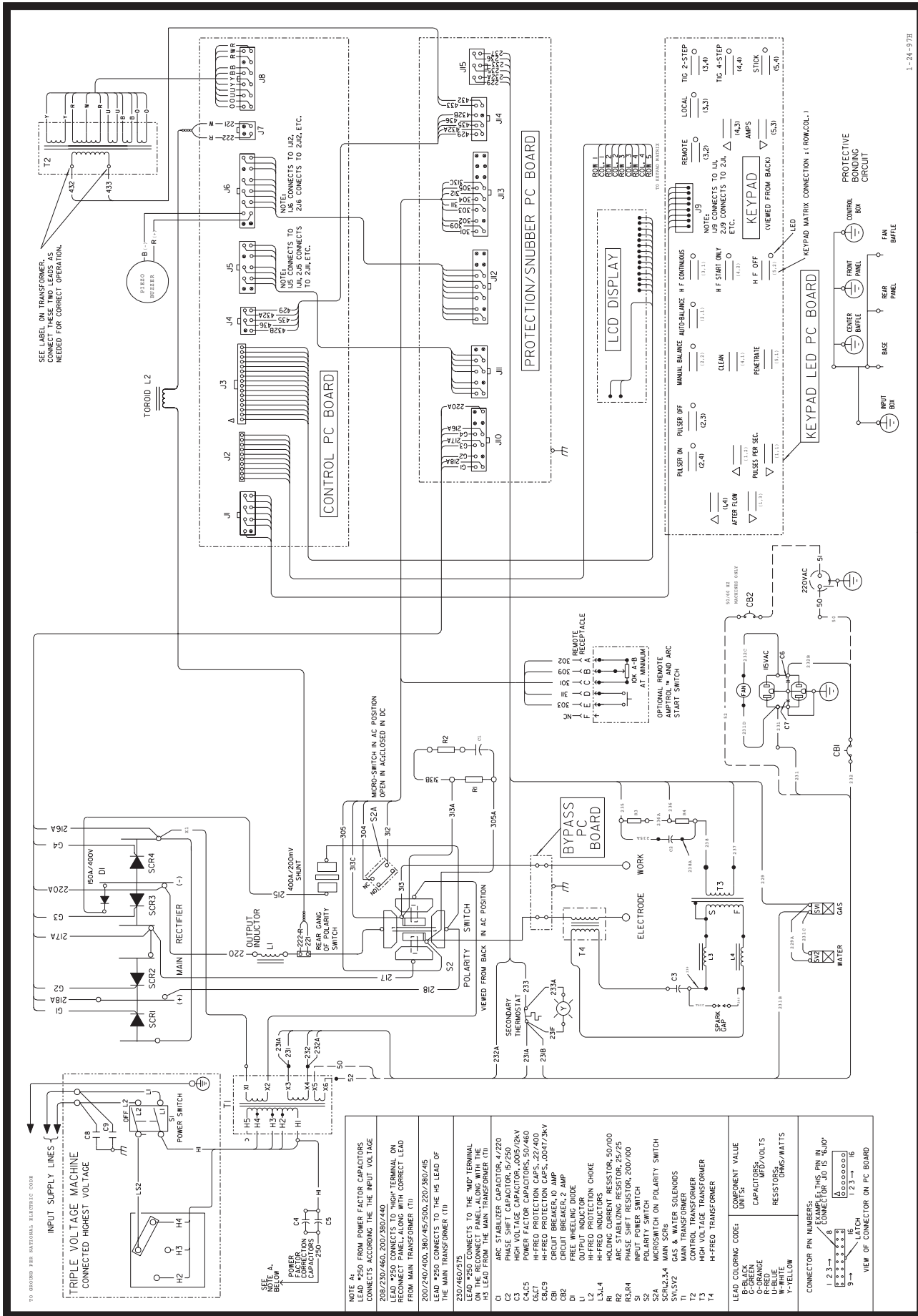

1-24-97H

033302

			
WARNING	<ul style="list-style-type: none"> ● Do not touch electrically live parts or electrode with skin or wet clothing. ● Insulate yourself from work and ground. 	<ul style="list-style-type: none"> ● Keep flammable materials away. 	<ul style="list-style-type: none"> ● Wear eye, ear and body protection.
Spanish AVISO DE PRECAUCION	<ul style="list-style-type: none"> ● No toque las partes o los electrodos bajo carga con la piel o ropa mojada. ● Aíslese del trabajo y de la tierra. 	<ul style="list-style-type: none"> ● Mantenga el material combustible fuera del área de trabajo. 	<ul style="list-style-type: none"> ● Protéjase los ojos, los oídos y el cuerpo.
French ATTENTION	<ul style="list-style-type: none"> ● Ne laissez ni la peau ni des vêtements mouillés entrer en contact avec des pièces sous tension. ● Isolez-vous du travail et de la terre. 	<ul style="list-style-type: none"> ● Gardez à l'écart de tout matériel inflammable. 	<ul style="list-style-type: none"> ● Protégez vos yeux, vos oreilles et votre corps.
German WARNUNG	<ul style="list-style-type: none"> ● Berühren Sie keine stromführenden Teile oder Elektroden mit Ihrem Körper oder feuchter Kleidung! ● Isolieren Sie sich von den Elektroden und dem Erdboden! 	<ul style="list-style-type: none"> ● Entfernen Sie brennbares Material! 	<ul style="list-style-type: none"> ● Tragen Sie Augen-, Ohren- und Körperschutz!
Portuguese ATENÇÃO	<ul style="list-style-type: none"> ● Não toque partes elétricas e electrodos com a pele ou roupa molhada. ● Isole-se da peça e terra. 	<ul style="list-style-type: none"> ● Mantenha inflamáveis bem guardados. 	<ul style="list-style-type: none"> ● Use proteção para a vista, ouvido e corpo.
Japanese 注意事項	<ul style="list-style-type: none"> ● 通電中の電気部品、又は溶材にヒフやぬれた布で触れないこと。 ● 施工物やアースから身体が絶縁されている様にして下さい。 	<ul style="list-style-type: none"> ● 燃えやすいものの側での溶接作業は絶対にしてはなりません。 	<ul style="list-style-type: none"> ● 目、耳及び身体に保護具をして下さい。
Chinese 警告	<ul style="list-style-type: none"> ● 皮肤或湿衣物切勿接觸帶電部件及鐳條。 ● 使你自已與地面和工件絕緣。 	<ul style="list-style-type: none"> ● 把一切易燃物品移離工作場所。 	<ul style="list-style-type: none"> ● 佩戴眼、耳及身體勞動保護用具。
Korean 위험	<ul style="list-style-type: none"> ● 전도체나 용접봉을 젖은 헝겍 또는 피부로 절대 접촉치 마십시오. ● 모재와 접지를 접촉치 마십시오. 	<ul style="list-style-type: none"> ● 인화성 물질을 접근시키지 마시오. 	<ul style="list-style-type: none"> ● 눈, 귀와 몸에 보호장구를 착용하십시오.
Arabic تحذير	<ul style="list-style-type: none"> ● لا تلمس الاجزاء التي يسري فيها التيار الكهربائي أو الإلكترود بجلد الجسم أو بالملابس المبللة بالماء. ● ضع عازلا على جسمك خلال العمل. 	<ul style="list-style-type: none"> ● ضع المواد القابلة للاشتعال في مكان بعيد. 	<ul style="list-style-type: none"> ● ضع أدوات وملابس واقية على عينيك وأذنيك وجسمك.

READ AND UNDERSTAND THE MANUFACTURER'S INSTRUCTION FOR THIS EQUIPMENT AND THE CONSUMABLES TO BE USED AND FOLLOW YOUR EMPLOYER'S SAFETY PRACTICES.

SE RECOMIENDA LEER Y ENTENDER LAS INSTRUCCIONES DEL FABRICANTE PARA EL USO DE ESTE EQUIPO Y LOS CONSUMIBLES QUE VA A UTILIZAR, SIGA LAS MEDIDAS DE SEGURIDAD DE SU SUPERVISOR.

LISEZ ET COMPRENEZ LES INSTRUCTIONS DU FABRICANT EN CE QUI REGARDE CET EQUIPMENT ET LES PRODUITS A ETRE EMPLOYES ET SUIVEZ LES PROCEDURES DE SECURITE DE VOTRE EMPLOYEUR.

LESEN SIE UND BEFOLGEN SIE DIE BETRIEBSANLEITUNG DER ANLAGE UND DEN ELEKTRODENEINSATZ DES HERSTELLERS. DIE UNFALLVERHÜTUNGSVORSCHRIFTEN DES ARBEITGEBERS SIND EBENFALLS ZU BEACHTEN.

			
<ul style="list-style-type: none"> ● Keep your head out of fumes. ● Use ventilation or exhaust to remove fumes from breathing zone. 	<ul style="list-style-type: none"> ● Turn power off before servicing. 	<ul style="list-style-type: none"> ● Do not operate with panel open or guards off. 	WARNING
<ul style="list-style-type: none"> ● Los humos fuera de la zona de respiración. ● Mantenga la cabeza fuera de los humos. Utilice ventilación o aspiración para gases. 	<ul style="list-style-type: none"> ● Desconectar el cable de alimentación de poder de la máquina antes de iniciar cualquier servicio. 	<ul style="list-style-type: none"> ● No operar con panel abierto o guardas quitadas. 	Spanish AVISO DE PRECAUCION
<ul style="list-style-type: none"> ● Gardez la tête à l'écart des fumées. ● Utilisez un ventilateur ou un aspirateur pour ôter les fumées des zones de travail. 	<ul style="list-style-type: none"> ● Débranchez le courant avant l'entretien. 	<ul style="list-style-type: none"> ● N'opérez pas avec les panneaux ouverts ou avec les dispositifs de protection enlevés. 	French ATTENTION
<ul style="list-style-type: none"> ● Vermeiden Sie das Einatmen von Schweißrauch! ● Sorgen Sie für gute Be- und Entlüftung des Arbeitsplatzes! 	<ul style="list-style-type: none"> ● Strom vor Wartungsarbeiten abschalten! (Netzstrom völlig öffnen; Maschine anhalten!) 	<ul style="list-style-type: none"> ● Anlage nie ohne Schutzgehäuse oder Innenschutzverkleidung in Betrieb setzen! 	German WARNUNG
<ul style="list-style-type: none"> ● Mantenha seu rosto da fumaça. ● Use ventilação e exaustão para remover fumo da zona respiratória. 	<ul style="list-style-type: none"> ● Não opere com as tampas removidas. ● Desligue a corrente antes de fazer serviço. ● Não toque as partes elétricas nuas. 	<ul style="list-style-type: none"> ● Mantenha-se afastado das partes moventes. ● Não opere com os painéis abertos ou guardas removidas. 	Portuguese ATENÇÃO
<ul style="list-style-type: none"> ● ヒュームから頭を離すようにして下さい。 ● 換気や排煙に十分留意して下さい。 	<ul style="list-style-type: none"> ● メンテナンス・サービスに取りかかる際には、まず電源スイッチを必ず切して下さい。 	<ul style="list-style-type: none"> ● パネルやカバーを取り外したままで機械操作をしないで下さい。 	Japanese 注意事項
<ul style="list-style-type: none"> ● 頭部遠離煙霧。 ● 在呼吸區使用通風或排風器除煙。 	<ul style="list-style-type: none"> ● 維修前切斷電源。 	<ul style="list-style-type: none"> ● 儀表板打開或沒有安全罩時不準作業。 	Chinese 警告
<ul style="list-style-type: none"> ● 얼굴로부터 용접가스를 멀리하십시오. ● 호흡지역으로부터 용접가스를 제거하기 위해 가스제거기나 통풍기를 사용하십시오. 	<ul style="list-style-type: none"> ● 보수전에 전원을 차단하십시오. 	<ul style="list-style-type: none"> ● 판넬이 열린 상태로 작동치 마십시오. 	Korean 위험
<ul style="list-style-type: none"> ● ابعد رأسك بعيداً عن الدخان. ● استعمل التهوية أو جهاز ضغط الدخان للخارج لكي تبعد الدخان عن المنطقة التي تتنفس فيها. 	<ul style="list-style-type: none"> ● اقطع التيار الكهربائي قبل القيام بأية صيانة. 	<ul style="list-style-type: none"> ● لا تشغيل هذا الجهاز اذا كانت الاغطية الحديدية الواقية ليست عليه. 	Arabic تحذير

LEIA E COMPREENDA AS INSTRUÇÕES DO FABRICANTE PARA ESTE EQUIPAMENTO E AS PARTES DE USO, E SIGA AS PRÁTICAS DE SEGURANÇA DO EMPREGADOR.

使う機械や溶材のメーカーの指示書をよく読み、まず理解して下さい。そして貴社の安全規定に従って下さい。

請詳細閱讀並理解製造廠提供的說明以及應該使用的銀焊材料，並請遵守貴方的有關勞動保護規定。

이 제품에 동봉된 작업지침서를 숙지하시고 귀사의 작업자 안전수칙을 준수하시기 바랍니다.

اقرأ بتمعن وافهم تعليمات المصنع المنتج لهذه المعدات والمواد قبل استعمالها واتبع تعليمات الوقاية لصاحب العمل.



LIMITED WARRANTY

STATEMENT OF WARRANTY:

The Lincoln Electric Company (Lincoln) warrants to the original purchaser (end-user) of new equipment that it will be free of defects in workmanship and material.

This warranty is void if Lincoln finds that the equipment has been subjected to improper care or abnormal operation.

WARRANTY PERIOD:

All warranty periods date from the date of shipment to the original purchaser and are as follows:

Three Years:

Transformer Welders
Motor-generator Welders
Inverter Welders
Automatic Wire Feeders
Semiautomatic Wire Feeders
Plasma-cutting Power Source
Engine Driven Welders (except engine and engine accessories) with operating speed under 2,000 RPM

Two Years:

Engine Driven Welders (except engines, engine accessories and Power-Arc 4000 generator/welders) with operating speed over 2,000 RPM

All engine and engine accessories are warranted by the engine or engine accessory manufacturer and are not covered by this warranty.

One Year:

Equipment not listed above such as gun and cable assemblies, water coolers, FAS TRAK or MIG-TRAK equipment, Power-Arc 4000 generator/welders, Wire Feed Module (Factory Installed) and field-installed optional equipment.

TO OBTAIN WARRANTY COVERAGE:

You are required to notify Lincoln Electric, your Lincoln Distributor, Lincoln Service Center or Field Service Shop of any defect within the warranty period. Written notification is recommended.

WARRANTY REPAIR:

If Lincoln's inspection of the equipment confirms the existence of a defect covered by this warranty, the defect will be corrected by repair or replacement at Lincoln's option.

WARRANTY COSTS:

You must bear the cost of shipping the equipment to a Lincoln Service Center or Field Service Shop as well as return shipment to you from that location.

IMPORTANT WARRANTY LIMITATIONS:

- Lincoln will not accept responsibility for repairs made without its authorization.
- Lincoln shall not be liable for consequential damages (such as loss of business, etc.) caused by the defect or reasonable delay in correcting the defect.
- Lincoln's liability under this warranty shall not exceed the cost of correcting the defect.
- This written warranty is the only express warranty provided by Lincoln with respect to its products. Warranties implied by law such as the Warranty of Merchantability are limited to the duration of this limited warranty for the equipment involved.

**WARRANTY SUPERSEDED
SEE INWS-1**

March, '96



World's Leader in Welding and Cutting Products

Premier Manufacturer of Industrial Motors

• Sales and Service through Subsidiaries and Distributors Worldwide •

22801 St. Clair Ave. Cleveland, Ohio 44117-1199 U.S.A. Tel. 216-481-8100

Download from www.somaterials.com. All Manuals Search And Download.

Free Manuals Download Website

<http://myh66.com>

<http://usermanuals.us>

<http://www.somanuals.com>

<http://www.4manuals.cc>

<http://www.manual-lib.com>

<http://www.404manual.com>

<http://www.luxmanual.com>

<http://aubethermostatmanual.com>

Golf course search by state

<http://golfingnear.com>

Email search by domain

<http://emailbydomain.com>

Auto manuals search

<http://auto.somanuals.com>

TV manuals search

<http://tv.somanuals.com>