



User's guide

Logitech®
Wireless Desktop
MK300





Contents

English	Setup, 6	Features and troubleshooting, 10
Deutsch	Einrichten, 6	Merkmale und Fehlerbehebung, 22
Français	Installation, 6	Fonctions et dépannage, 34
Italiano	Installazione, 6	Funzioni e risoluzione dei problemi, 46



www.logitech.com/support, 58





Thank you!

Danke!

Merci!

Grazie!





Logitech® Wireless Desktop MK300





Logitech® Wireless Desktop MK300

1

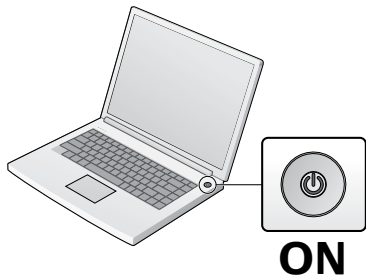



Logitech® Wireless Desktop MK300

2

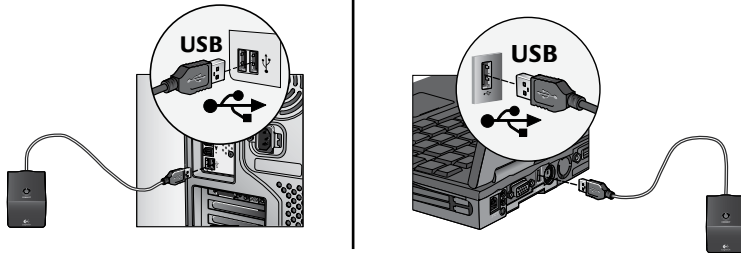

3





Logitech® Wireless Desktop MK300

4

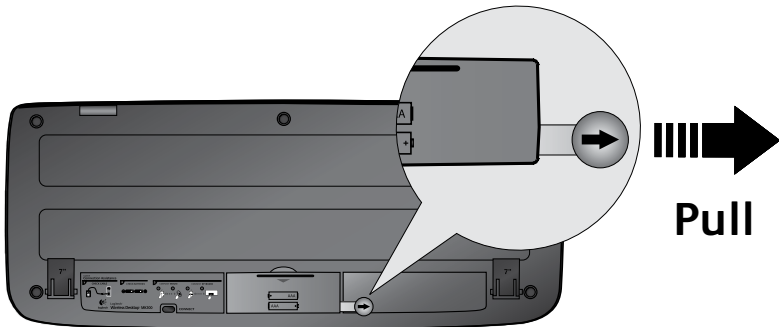

Deutsch ZIEHEN

Français TIRER

Italiano TIRARE



5



Deutsch ZIEHEN

Français TIRER

Italiano TIRARE



Keyboard features: hot keys



To enjoy **all** the features of your keyboard or to customize it to suit your needs, please install the Logitech® SetPoint™ Software that comes with your product.

1. Logitech application switcher

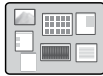

2. Internet zone

- a. Email application
- b. Internet browser
- c. Internet search engine
- d. Messenger

3. Multimedia navigation

- a. Previous track
- b. Play/pause track
- c. Next track

4. Volume zone

- a. Mute volume
- b. Volume down
- c. Volume up

5. Convenience zone

- a. Windows® calculator
- b. Battery status check (See **Battery management** for more information.)



Keyboard features: hot keys





Keyboard features: F-keys



To enjoy **all** the features of your keyboard or to customize it to suit your needs, please install the Logitech® SetPoint™ Software that comes with your product.



User-friendly enhanced F-keys let you easily launch applications or control your music. To use the enhanced functions (gray icons), press the key and the **F-Key Fn** you want to use simultaneously.

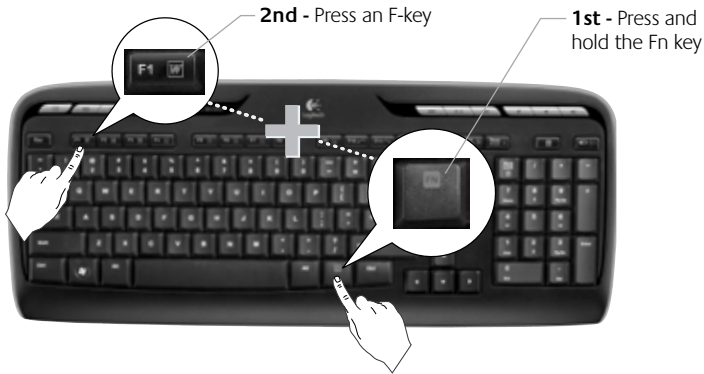



Keyboard features: F-keys



1. **Fn** key (for use with F-keys)

2. Productivity zone

- Fn** +F1 Launches document application
- Fn** +F2 Launches spreadsheet application
- Fn** +F3 Launches presentation application
- Fn** +F4 Launches calendar

3. Favorites zone

Fn +F5 to F8 program your favorite application, folder, or web site with a long, simultaneous press of **Fn** and the corresponding **F5**, **F6**, **F7**, or **F8** key (just like the presets of a car radio).



Keyboard features: F-keys



4. Internet zone

- Fn + F9** Save file
- Fn + F10** Undo last operation
- Fn + F11** Redo last operation
- Fn + F12** Opens/closes CD-DVD tray

5. Miscellaneous

- Fn + Print Screen:** Contextual menu
- Fn + Pause/Break:** Scroll lock
- Fn + Battery status check:** PC sleep mode





Mouse features: buttons and scrolling

1. Left click
2. Right click
3. Scroll wheel – Use SetPoint software to set your preferred speed and acceleration. (See **Customizing the keyboard and mouse.**)
4. Battery-indicator light – The LED glows green for 10 seconds when the mouse is powered on. The LED blinks red when battery level drops below 10%.
5. Power switch – Turn off the mouse if you intend to take it with you while traveling or if you will not be using the mouse for an extended period of time.
6. Connect button – See **Troubleshooting** for information about usage.



Customizing the keyboard and mouse

1. Double-click the **Mouse and Keyboard Settings** icon on the Windows® desktop to make changes. 
2. To customize the keyboard, click the My Keyboard tab. For the mouse, click the My Mouse tab.

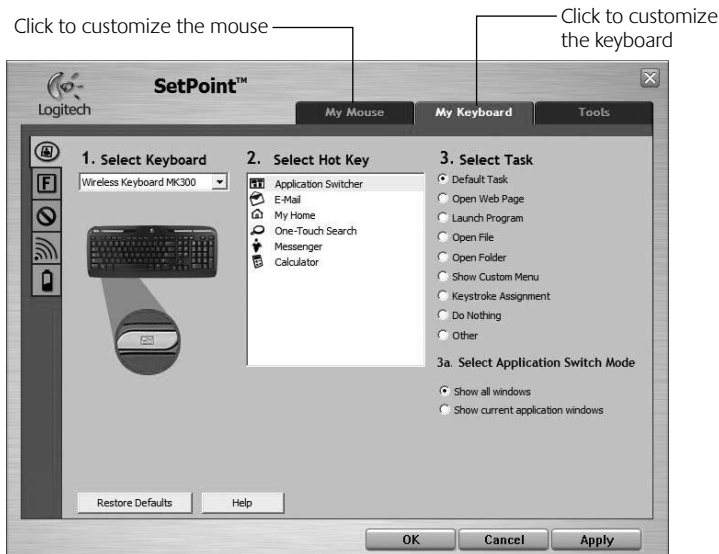

- For either the keyboard or mouse, a series of tabs is shown on the left.
- Choose a tab, such as the keyboard **F-key Settings**. A picture of the keyboard is displayed showing F-keys (list 2) to which tasks can be assigned (list 3).
- In the **2. Select F-key** list, highlight the F-key to be reassigned a task.
- In the **3. Select Task** list, highlight the new task.
- When you are done, click **OK** to save the new F-key assignments.

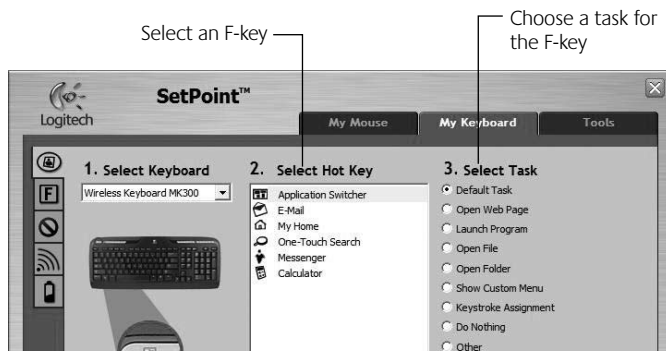

Keyboard F-key Settings tab



My Mouse tab

For more information about customizing your keyboard and mouse, please refer to the help system.

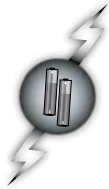

Battery management

Your keyboard has up to 15 months of battery life, and your mouse has up to 8 months. (Note that the mouse can work with *only* one battery, but with significantly reduced battery life.)*

Battery sleep mode

Did you know that both your keyboard and mouse go into sleep mode after you stop using them for a few minutes? This feature helps limit battery usage. Both devices are up and running immediately once you begin using them again.

How to check the battery level for the keyboard (software required)

Press the **Battery Status Check** hotkey. 

The SetPoint Software Keyboard Battery tab pops up. It shows the current battery level of the keyboard.

How to check the battery level for the mouse

- **Option 1:** Turn the mouse off, and then on using the On/Off slider switch on the bottom of the mouse. Look at the battery LED on the top case. If the LED glows green for 10 seconds, the batteries are good. If the LED blinks red, the battery level has dropped to 10%. (You still have a few days of battery usage left.)
- **Option 2:** Launch the SetPoint Software, and click the Mouse Battery tab to see the current battery level of the mouse.

Mouse bottom



Switch



LED

*Battery life varies with usage and computing conditions. Heavy usage usually results in shorter battery life.





Troubleshooting

Keyboard and mouse are not working



Check the cable connection.
Also, try changing USB ports.

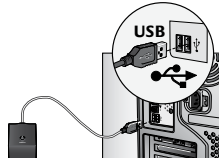

Move closer? Try moving the keyboard or mouse closer to the receiver.



Relocate the receiver. Place the receiver away from electrical devices and avoid metallic surfaces.



Check battery installation. Also check the battery power of each device. (See **Battery management** for more information.)

To open the mouse battery compartment, press down on the compartment cover, and slide cover toward rear of mouse.

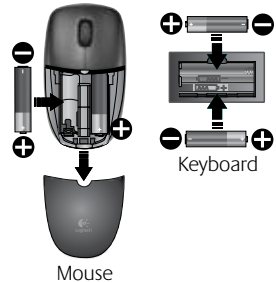



Troubleshooting



Is the mouse turned on? On the mouse bottom, move the power slider switch **right** to turn on the mouse. The Battery LED on the mouse top case should light green for 10 seconds. (See **Battery management** for more information.)



Mouse bottom



Are you experiencing slow or jerky cursor movement? Try the mouse on a different surface (e.g., deep, dark surfaces may affect how the cursor moves on the computer screen).



Establish a connection:

1. Press the **Connect** button on the receiver.
2. **QUICKLY** press the Connect button (half second) under each device. The mouse LED (top case) should blink.

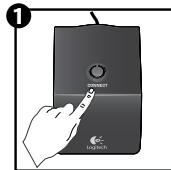

Connect mouse

For additional help, refer to the Customer Support telephone numbers on page 58.

Also visit www.logitech.com/comfort for more information about using your product, and for ergonomics.

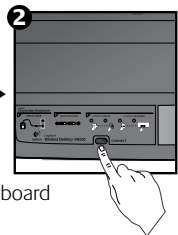
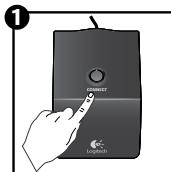

Connect keyboard





Tastaturmerkmale: Sondertasten



Damit Sie den **gesamten** Funktionsumfang der Tastatur nutzen und an Ihre Arbeitsweise anpassen können, müssen Sie die mitgelieferte Software Logitech® SetPoint™ installieren.

1. Logitech- Programmumschalter



2. Internet

- a. E-Mail-Anwendung
- b. Webbrowser
- c. Internet-Suchmaschine
- d. Messenger

3. Multimedia-Navigation

- a. Vorheriger Titel
- b. Wiedergabe/Pause
- c. Nächster Titel

4. Lautstärke

- a. Ton aus
- b. Lautstärke -
- c. Lautstärke +

5. Praktische Zone

- a. Windows®-Rechner
- b. Batterieprüfung (siehe **Batterie**)





Tastaturmerkmale: Sondertasten





Tastaturmerkmale: F-Tasten



Damit Sie den **gesamten** Funktionsumfang der Tastatur nutzen und an Ihre Arbeitsweise anpassen können, müssen Sie die mitgelieferte Software Logitech® SetPoint™ installieren.



Über die erweiterten F-Tasten können Sie Anwendungen starten oder die Musikwiedergabe steuern. Drücken Sie zum Aktivieren der erweiterten Funktion einer F-Taste (graue Symbole) gleichzeitig die **Fn**- und die entsprechende **F**-Taste.

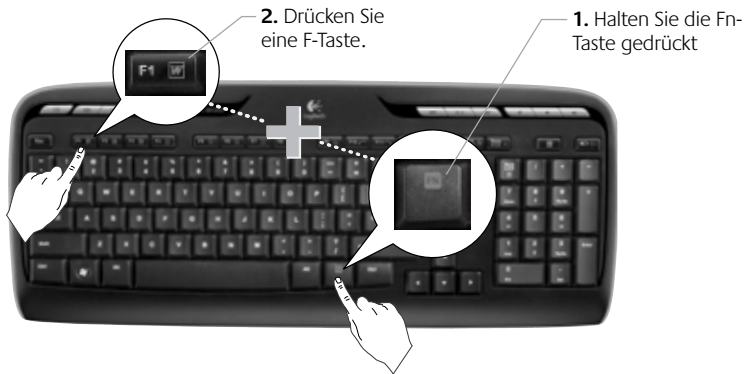



Tastaturmerkmale: F-Tasten



1. **Fn**-Taste (im Kombination mit den F-Tasten)

2. Arbeitserleichterung

Fn +F1 Startet eine Anwendung zur Textverarbeitung

Fn +F2 Startet eine Anwendung zur Tabellenkalkulation

Fn +F3 Startet eine Anwendung für Präsentationen

Fn +F4 Startet den Kalender

3. Favoriten

Fn + F5 bis F8: Weisen Sie der Taste eine Anwendung, einen Ordner oder eine Website zu, indem Sie **Fn** und die entsprechende F-Taste (F5, F6, F7 oder F8) gleichzeitig lange drücken (wie bei einem Autoradio).



Tastaturmerkmale: F-Tasten



4. Internet

- Fn + F9** Datei speichern
- Fn + F10** Letzten Vorgang rückgängig machen
- Fn + F11** Zuetzt rückgängig gemachten Vorgang wiederholen
- Fn + F12** CD-/DVD-Fach öffnen/schließen

5. Verschiedenes

- Fn + Druck:** Kontextmenü
- Fn + Pause/Untbr:** Rollen
- Fn + Batterieprüfung**
PC-Standby-Modus





Mausmerkmale: Tasten und Tastenrad

1. Linksklick
2. Rechtsklick
3. Tastenrad: In der Software SetPoint können Sie Geschwindigkeit und Beschleunigung einstellen (siehe **Ändern der Einstellungen für Tastatur und Maus**).
4. Batterie-LED: Die LED leuchtet zehn Sekunden lang grün, wenn die Maus eingeschaltet wird. Sie blinkt rot, wenn der Ladezustand der Batterien unter 10% sinkt.
5. Ein-/Ausschalter: Zum Ausschalten der Maus, wenn Sie sie länger nicht benutzen oder unterwegs sind.
6. Connect-Taste: Informationen zum Einsatz dieser Taste finden Sie im Abschnitt **Fehlerbehebung**.





Ändern der Einstellungen für Tastatur und Maus

1. Doppelklicken Sie auf das Symbol **Maus- und Tastatureinstellungen**  auf dem Windows®-Desktop, um Änderungen vorzunehmen.
2. Die Einstellungen für die Tastatur finden Sie auf der Registerkarte “Eigene Tastatur”. Die Einstellungen für die Maus auf der Registerkarte “Eigene Maus”.

Zum Ändern
der Mauseinstellungen klicken

Zum Ändern der Tastatur-
einstellungen klicken





3. Auf der linken Seite befinden sich Registerkarten mit Einstellungen für Tastatur bzw. Maus.
4. Wählen Sie eine (z. B. **F-Tasten**). Eine Abbildung der Tastatur, die F-Tasten (Liste 2) und die verfügbaren Funktionen (Liste 3) werden angezeigt.
5. Markieren Sie in der Liste **2. F-Taste wählen** die F-Taste, deren Funktion geändert werden soll.
6. Markieren Sie in der Liste **3. Funktion wählen** die gewünschte Funktion.
7. Klicken Sie auf **OK**, um die neuen Funktionszuweisungen zu speichern.

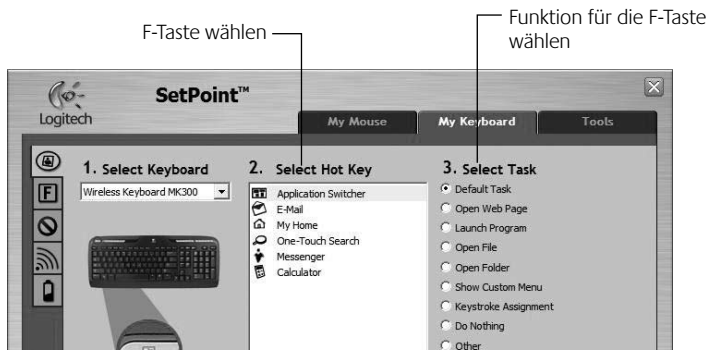

Einstellungen für die F-Tasten der Tastatur

Registerkarte mit Mauseinstellungen



Registerkarte "Eigene Maus"

Informationen zum Ändern der Tastatur- und Mauseinstellungen finden Sie in der Onlinehilfe.

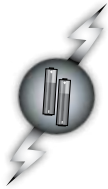

Batterie

Die Batterielaufzeit beträgt bei der Tastatur bis zu 15 Monate und bei der Maus bis zu acht Monate. (Beachten Sie, dass die Maus mit *nur einer* Batterie zwar funktioniert, aber die Laufzeit erheblich reduziert ist.)*

Standby-Modus der Batterie

Wussten Sie, dass sowohl Tastatur als auch Maus in den Standby-Modus schalten, wenn sie ein paar Minuten lang nicht genutzt werden? Dadurch wird die Batterie geschont. Beide Geräte sind sofort einsatzbereit, wenn Sie eine Taste drücken bzw. sie bewegen.

So prüfen Sie den Ladezustand der Tastaturbatterie (Software erforderlich)

Drücken Sie die Sondertaste **Batterieprüfung** .

Die Registerkarte "Tastaturbatterie" der Software SetPoint wird geöffnet und zeigt den aktuellen Ladezustand der Batterie an.

So prüfen Sie den Ladezustand der Mausbatterie:

- **Möglichkeit 1:** Schalten Sie die Maus über den Schiebeschalter auf der Unterseite aus und wieder ein. Leuchtet die Batterie-LED auf der Oberseite zehn Sekunden lang grün, sind die Batterien in Ordnung. Blinkt sie rot, ist der Ladezustand der Batterien unter 10% gesunken. (Die Batterie sollte aber noch ein paar Tage halten.)
- **Möglichkeit 2:** Starten Sie die Software SetPoint und klicken Sie auf die Registerkarte "Mausbatterie", um den Ladezustand anzuzeigen.

Unterseite der Maus



* Die Laufzeit der Batterie ist von Nutzungs- und Umgebungsbedingungen abhängig. Täglicher, kontinuierlicher Einsatz verkürzt die Laufzeit.





Fehlerbehebung

Tastatur und Maus funktionieren nicht



Überprüfen Sie die Kabelverbindungen.

Schließen Sie die Geräte an einer anderen USB-Schnittstelle an.

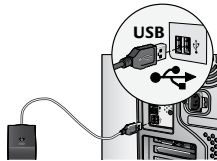

Näher? Verringern Sie den Abstand zwischen Tastatur bzw. Maus und Empfänger.



Empfängerposition Platzieren Sie den Empfänger nicht in der Nähe von elektrischen Geräten und vermeiden Sie metallische Oberflächen.



Prüfen Sie, ob die Batterien richtig eingelegt sind. Prüfen Sie außerdem den Ladezustand der Batterien beider Geräte (siehe **Batterie**).

Drücken Sie zum Öffnen des Batteriefachs auf den Deckel und schieben Sie ihn nach unten.

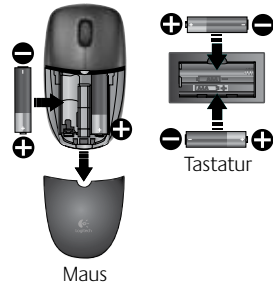
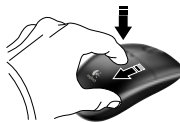



Fehlerbehebung



Ist Maus eingeschaltet? Schieben Sie den Schalter auf der Unterseite der Maus nach **rechts**, um die Maus einzuschalten. Die Batterie-LED auf der Oberseite der Maus sollte zehn Sekunden lang grün leuchten (siehe **Batterie**).



Unterseite
der Maus



Der Mauszeiger bewegt sich langsam oder ruckartig

Verwenden Sie eine andere Unterlage (z. B. können dunkle Oberflächen die Abtastung beeinträchtigen).



Herstellen der Verbindung:

1. Drücken Sie die **Connect**-Taste am Empfänger.
2. Drücken Sie die Connect-Taste beider Geräte kurz (eine halbe Sekunde lang). Die LED an der Oberseite sollte blinken.

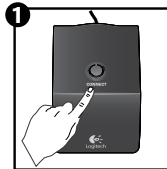

Maus verbinden

Wenn Sie weitere Hilfe benötigen, rufen Sie unseren Kundendienst an. Die Telefonnummer finden Sie auf Seite 58.

*Auf der Logitech-Website finden Sie unter **www.logitech.com/comfort** Informationen zu den Produkten und zur Ergonomie.*

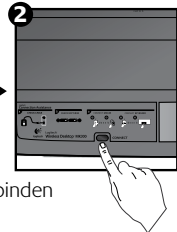
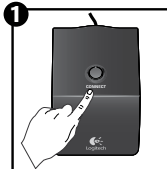

Tastatur verbinden





Touches de raccourci du clavier



Pour profiter pleinement de **toutes** les fonctions de votre clavier ou pour l'adapter à vos besoins, installez le logiciel Logitech® SetPoint™ livré avec le produit.

1. Sélecteur de changement d'application Logitech



2. Zone Internet

- a. Application de courrier électronique
- b. Navigateur Web
- c. Moteur de recherche Internet
- d. Messenger

3. Navigation multimédia

- a. Piste précédente
- b. Lecture/Pause
- c. Piste suivante

4. Zone de volume

- a. Sourdine
- b. Volume -
- c. Volume +

5. Zone Fonctions pratiques

- a. Calculatrice Windows®
- b. Vérification du niveau des piles (voir **Gestion de l'alimentation** pour plus d'informations).



Touches de raccourci du clavier





Touches de fonction du clavier



Pour profiter pleinement de **toutes** les fonctions de votre clavier ou pour l'adapter à vos besoins, installez le logiciel Logitech® SetPoint™ livré avec le produit.



Des touches de fonction conviviales vous permettent de lancer des applications et de contrôler facilement la musique que vous écoutez. Pour profiter des fonctions avancées (icônes grises), appuyez simultanément sur la touche **Fn** et la **touche F** de votre choix.

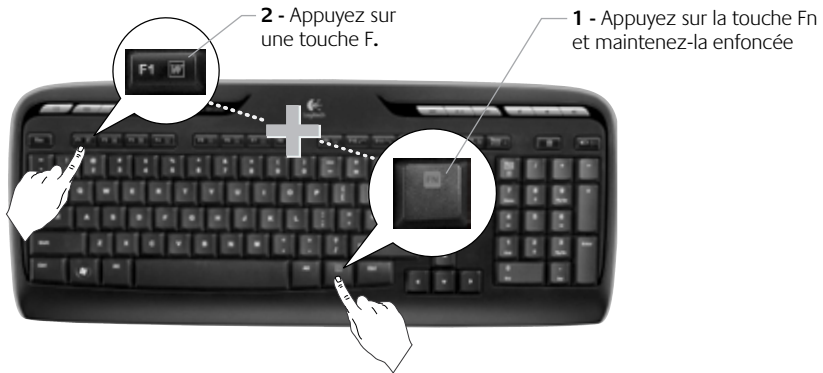

Touches de fonction du clavier



1. **Fn** Touche Fn (en combinaison avec les touches F)

2. Zone Productivité

- Fn** +F1 Lance l'application de document
- Fn** +F2 Lance l'application de feuille de calcul
- Fn** +F3 Lance l'application de présentation
- Fn** +F4 Lance le calendrier

3. Zones Favoris

Fn + F5 à F8 programme vos applications, dossiers ou sites Web préférés au moyen d'une pression longue et simultanée de la touche **Fn** et de la touche correspondante **F5**, **F6**, **F7** ou **F8** (comme pour la présélection de radios sur un autoradio).



Touches de fonction du clavier



4. Zone Internet

- Fn** + **F9** Enregistrer un fichier
- Fn** + **F10** Annuler la dernière opération
- Fn** + **F11** Répéter la dernière opération
- Fn** + **F12** Ouvrir/fermer le plateau CD/DVD

5. Divers

- Fn** + **Impr Syst**: menu contextuel
- Fn** + **Pause/Attn**: Arrêt défil
- Fn** + **touche de vérification du niveau des piles**: PC en mode veille



Fonctions de la souris: boutons et défilement

1. Clic gauche
2. Clic droit
3. Roulette de défilement – Utilisez le logiciel SetPoint pour définir vos paramètres de vitesse et d'accélération favoris (voir **Personnalisation du clavier et de la souris**).
4. Témoin d'état des piles – Il brille en vert pendant 10 secondes lorsque la souris est sous tension. Il brille en rouge quand le niveau de charge des piles tombe sous la barre des 10%.
5. Interrupteur d'alimentation: mettez la souris hors tension pour l'emporter lors de vos déplacements ou si vous ne comptez pas l'utiliser pendant une longue période.
6. Bouton Connect – Voir **Dépannage** pour obtenir des informations sur son utilisation.





Personnalisation du clavier et de la souris

1. Pour effectuer des changements, cliquez deux fois sur l'icône **Paramètres de la souris et du clavier** située sur le bureau Windows®.
2. Pour personnaliser le clavier, cliquez sur l'onglet **Mon clavier**. Pour la souris, cliquez sur l'onglet **Ma souris**.

Cliquer sur cet onglet pour personnaliser la souris

Cliquer sur cet onglet pour personnaliser le clavier



3. Une série d'onglets liés au clavier ou à la souris s'affiche sur la gauche.
4. Choisissez un onglet, tel que **Paramètres des touches F** du clavier. Une image du clavier s'affiche, indiquant les touches F (liste 2) auxquelles les tâches peuvent être affectées (liste 3).
5. Dans la liste **2. Sélection de la touche F**, mettez en surbrillance la touche F à laquelle vous souhaitez réaffecter une tâche.
6. Dans la liste **3. Sélectionner une tâche**, mettez en surbrillance la nouvelle tâche.
7. Lorsque vous avez terminé, cliquez sur **OK** pour enregistrer les nouvelles affectations de touches F.

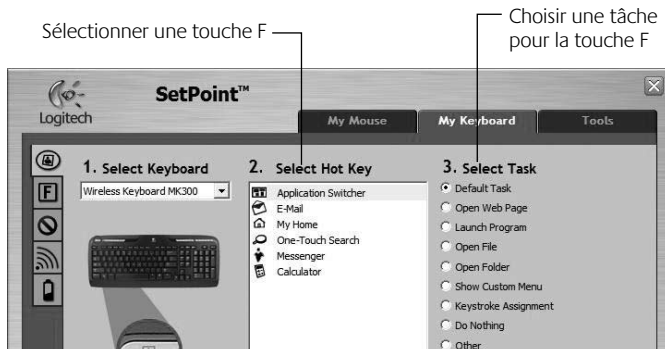

Onglet Paramètres des touches F du clavier

Personnaliser la souris à l'aide de cet onglet



Onglet Ma souris

Pour plus d'informations sur la personnalisation du clavier et de la souris, veuillez vous reporter au système d'aide.



Gestion de l'alimentation

La durée de vie des piles du clavier s'élève à 15 mois maximum et celle des piles de la souris à huit mois maximum. La souris peut fonctionner avec *une seule pile*, mais celle-ci aura alors une durée de vie considérablement réduite.*

Mode de veille

Saviez-vous que le clavier et la souris se mettent en mode veille après quelques minutes d'inactivité ? Cette fonction permet de limiter l'utilisation des piles. Le mode veille des deux dispositifs est désactivé dès que vous recommencez à les utiliser.

Comment vérifier le niveau des piles du clavier (logiciel requis) ?

Appuyez sur la touche de **vérification du niveau des piles**. 

L'onglet des piles du clavier du logiciel SetPoint apparaît. Il affiche le niveau en cours des piles du clavier.

Comment vérifier l'état des piles de la souris ?

- **Option 1:** mettez la souris hors tension, puis sous tension à l'aide du commutateur Marche/Arrêt situé sous la souris. Regardez le témoin d'état des piles sur la coque. Si le témoin LED brille en vert pendant 10 secondes, le niveau des piles est correct. S'il brille en rouge, cela signifie que le niveau de charge des piles est tombé sous la barre des 10%. La souris va continuer à fonctionner pendant quelques jours.
- **Option 2:** lancez le logiciel SetPoint et cliquez sur l'onglet des piles de la souris pour afficher le niveau en cours des piles de la souris.

Dessous de la souris



Interrupteur



Témoin lumineux

* La durée de vie des piles est susceptible de varier en fonction de l'environnement et du mode d'utilisation. Une utilisation quotidienne prolongée aura pour effet d'écourter la longévité des piles.



Dépannage

Le clavier et la souris ne fonctionnent pas



Vérifiez la connexion du câble.

Essayez également de changer de ports USB.

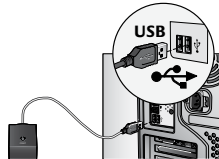

Proximité ? Essayez de rapprocher le clavier et la souris du récepteur.



Changez l'emplacement du récepteur. Eloignez le récepteur des autres appareils électriques et évitez les surfaces métalliques.



Vérifiez que les piles sont bien installées.

Vérifiez également l'alimentation de chaque dispositif (voir **Gestion de l'alimentation** pour plus d'informations).

Pour ouvrir le compartiment des piles de la souris, appuyez sur son couvercle et faites glisser ce dernier vers l'arrière de la souris.

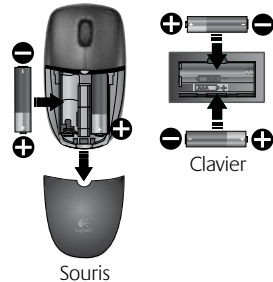
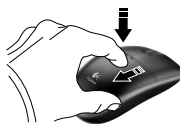

Dépannage



La souris est-elle sous tension ? Sous la souris, déplacez l'interrupteur d'alimentation vers la **droite** pour mettre la souris sous tension.

Le témoin d'état des piles situé sur la coque de la souris doit briller en vert pendant 10 secondes (voir **Gestion de l'alimentation** pour plus d'informations).



Dessous de la souris



Le mouvement du curseur est lent ou intermittent.

Essayez la souris sur une surface différente (les surfaces très foncées ne sont pas les plus adaptées).



Etablissez une connexion:

1. Appuyez sur le bouton **Connect** du récepteur.
2. Appuyez **RAPIDEMENT** (une demi-seconde) sur le bouton Connect sous chaque dispositif. Le témoin LED situé sur la coque de la souris doit briller.

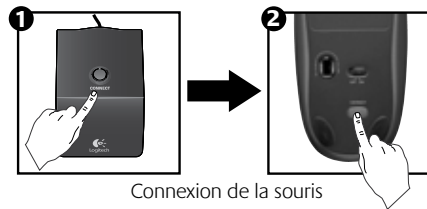

Connexion de la souris

Pour obtenir de l'aide supplémentaire, reportez-vous aux numéros de téléphone du service clientèle à la page 58.

Pour en savoir plus sur l'utilisation des produits et leur confort, accédez au site Web www.logitech.com/comfort.

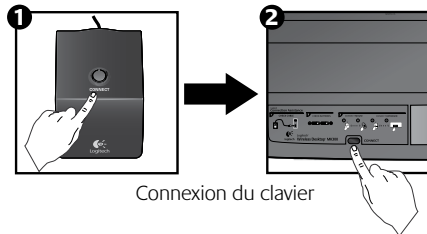

Connexion du clavier



Caratteristiche della tastiera: tasti dedicati



Per poter utilizzare **tutte** le funzionalità della tastiera o per personalizzarla è necessario installare il software Logitech® SetPoint™ incluso nel prodotto.

1. Passaggio fra applicazioni Logitech

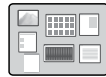

2. Area Internet

- a. Applicazione di posta elettronica
- b. Browser Internet
- c. Motore di ricerca in Internet
- d. Messenger

3. Navigazione multimediale

- a. Brano precedente
- b. Riproduzione/Pausa
- c. Brano successivo

4. Area volume

- a. Disattivazione audio
- b. Volume -
- c. Volume +

5. Area praticità

- a. Calcolatrice Windows®
- b. Verifica livello di carica delle batterie (Vedere **Gestione delle batterie** per maggiori informazioni.)

Caratteristiche della tastiera: tasti dedicati





Caratteristiche della tastiera: tasti funzione



Per poter utilizzare **tutte** le funzionalità della tastiera o per personalizzarla è necessario installare il software Logitech® SetPoint™ incluso nel prodotto.



I tasti funzione intuitivi consentono di avviare con facilità applicazioni o controllare i brani musicali. Per utilizzare le funzioni avanzate (icone grigie), premere contemporaneamente il tasto e il **tasto funzione** desiderato **Fn**.



Caratteristiche della tastiera: tasti funzione



1. **Fn** (da usare insieme ai tasti funzione)

2. Area produttività

Fn +F1 Avvia l'applicazione per documenti

Fn +F2 Avvia l'applicazione per fogli di calcolo

Fn +F3 Avvia l'applicazione per presentazioni

Fn +F4 Avvia il calendario

3. Area preferiti

Fn + i tasti da **F5** a **F8** attivano l'applicazione, la cartella o il sito Web preferito. Per programmarli, tenere premuti contemporaneamente e per alcuni secondi (nello stesso modo in cui si memorizza una stazione radio nell'autoradio) il tasto **Fn** e il tasto **F5**, **F6**, **F7** o **F8** desiderato.



Caratteristiche della tastiera: tasti funzione



4. Area Internet

- Fn** +F9 Salva file
- Fn** +F10 Annulla ultima operazione
- Fn** +F11 Ripristina ultima operazione
- Fn** +F12 Apre/chiede il cassetto del CD-DVD

5. Vari

- Fn** + **Stampa schermo**: menu contestuale
- Fn** + **Pausa Interr**: blocco scorrimento
- Fn** + **Verifica livello di carica delle batterie**: modalità di sospensione del PC



Caratteristiche del mouse: pulsanti e scorrimento

1. Pulsante sinistro
2. Pulsante destro
3. Scroller – Utilizzare il software SetPoint per impostare la velocità e l'accelerazione preferite. Vedere **Personalizzazione della tastiera e del mouse**.
4. Indicatore luminoso del livello di carica delle batterie – Il LED si illumina di colore verde per 10 secondi quando si accende il mouse. Il LED lampeggia di colore rosso quando il livello di carica delle batterie è inferiore a 10%.
5. Pulsante di alimentazione - Spegnerne il mouse per il trasporto o se si prevede di non utilizzarlo per un periodo di tempo prolungato.
6. Pulsante Connect – Vedere **Risoluzione dei problemi** per informazioni su come utilizzarlo.



Personalizzazione della tastiera e del mouse

1. Fare doppio clic sull'icona **Impostazioni mouse e tastiera**  sul desktop di Windows® per apportare le modifiche desiderate.
2. Per personalizzare la tastiera, fare clic sulla scheda Tastiera. Per personalizzare il mouse, fare clic sulla scheda Mouse.

Fare clic per personalizzare il mouse

Fare clic per personalizzare la tastiera



3. Per il mouse e la tastiera è disponibile una serie di schede sulla sinistra.
4. Scegliere una scheda, ad esempio quella delle **impostazioni dei tasti funzione** della tastiera. Viene visualizzata un'immagine della tastiera con i tasti funzione (elenco 2) a cui è possibile assegnare operazioni (elenco 3).
5. Evidenziare il tasto funzione a cui riassegnare un'operazione nell'elenco **2. Seleziona tasto F**.
6. Evidenziare la nuova operazione nell'elenco **3. Seleziona operazione**.
7. Al termine, fare clic su **OK** per salvare le nuove assegnazioni dei tasti funzione.



Selezionare un tasto funzione

Selezionare un'operazione per il tasto funzione

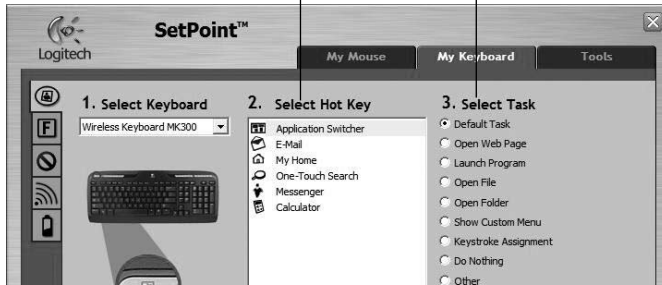

Scheda delle impostazioni dei tasti funzione della tastiera

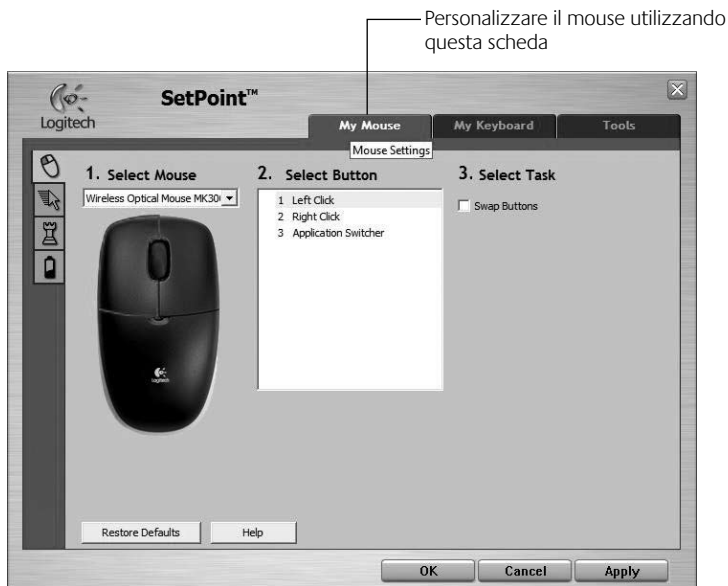

Scheda Mouse

Per ulteriori informazioni su come personalizzare la tastiera e il mouse, consultare la guida in linea del software.

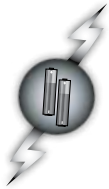

Gestione delle batterie

Le batterie della tastiera durano fino a 15 mesi e quelle del mouse fino a 8. Si noti che il mouse può funzionare con una *sola* batteria, ma per un periodo di tempo notevolmente più breve.*

Modalità di sospensione delle batterie

Sia il mouse che la tastiera attivano la modalità di sospensione se non vengono utilizzati per alcuni minuti. Questa funzionalità consente di limitare il consumo delle batterie. Quando vengono utilizzati di nuovo, entrambi i dispositivi riprendono a funzionare immediatamente.

Verifica del livello di carica delle batterie della tastiera (è richiesto il software)

Premere il tasto dedicato **Verifica livello di carica delle batterie.** 

In SetPoint viene visualizzata la scheda delle batterie della tastiera che ne indica il livello di carica corrente.

Verifica del livello di carica delle batterie del mouse

- **Opzione 1:** spegnere il mouse e quindi riaccenderlo utilizzando l'interruttore di accensione posto sulla base del mouse. Osservare il LED del livello di carica delle batterie: se si accende di colore verde per 10 secondi, il livello di carica delle batterie è buono; se lampeggia di colore rosso, il livello di carica delle batterie è inferiore al 10% (è possibile utilizzare le batterie ancora per qualche giorno).
- **Opzione 2:** avviare SetPoint e fare clic sulla scheda relativa alle batterie del mouse per vedere il livello di carica corrente.

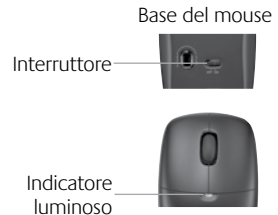

* La durata delle batterie varia a seconda della frequenza e del tipo di utilizzo. Un utilizzo intenso riduce di norma la durata.





Risoluzione dei problemi

Il mouse e la tastiera non funzionano



Controllare il collegamento del cavo. Provare anche a utilizzare un'altra porta USB.

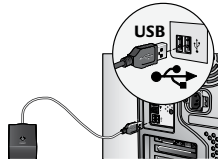

Avvicinare il dispositivo. Provare ad avvicinare la tastiera o il mouse al ricevitore.



Collocare il ricevitore in un'altra posizione. Posizionare il ricevitore lontano da dispositivi elettrici ed evitare superfici metalliche.



Verificare che le batterie siano state inserite correttamente. Controllare inoltre il livello di carica delle batterie di ciascun dispositivo (per ulteriori informazioni vedere **Gestione delle batterie**).

Per aprire il vano batterie del mouse, premere il coperchio del vano e farlo scorrere verso il retro del mouse.

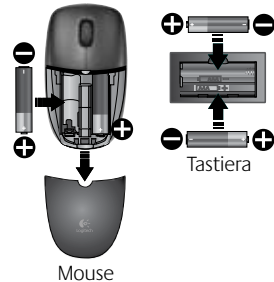
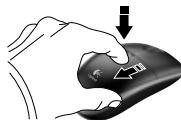

Risoluzione dei problemi



Controllare se il mouse è acceso. Accendere il mouse facendo scorrere verso **destra** l'interruttore di accensione posto sulla base del mouse. Il LED del livello di carica delle batterie posto nella parte superiore del mouse dovrebbe accendersi di colore verde per 10 secondi (per ulteriori informazioni vedere **Gestione delle batterie**).



Base del mouse



Il cursore si muove lentamente o a scatti? Provare a utilizzare il mouse su una superficie differente (ad esempio, le superfici di colore molto scuro potrebbero influenzare il movimento del cursore sullo schermo).



Stabilire la connessione:

1. Premere il pulsante **Connect** del ricevitore.
2. **Premere RAPIDAMENTE (per mezzo secondo)** il pulsante Connect posto sulla base di ogni dispositivo. Il LED posto sulla parte superiore del mouse lampeggia.

Per maggiori suggerimenti, vedere i numeri di telefono del Servizio di assistenza a pagina 58.

Per ulteriori informazioni relative al comfort e all'utilizzo del prodotto, visitare il sito www.logitech.com/comfort.

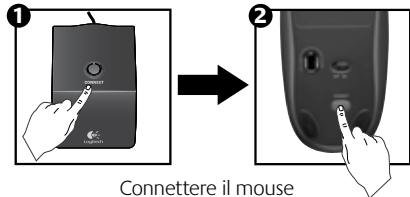

Connettere il mouse

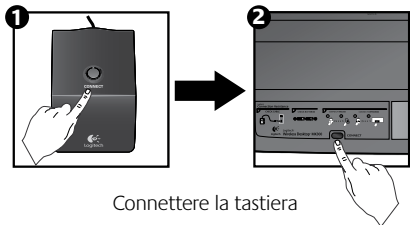

Connettere la tastiera



www.logitech.com/support



België / Belgique	Dutch: +32-(0)2 200 64 44; French: +32-(0)2 200 64 40	Russija	+7(495) 641 34 60
Česká Republika	+420 239 000 335	Schweiz / Suisse Svizzera	D +41-(0)22 761 40 12 F +41-(0)22 761 40 16 I +41-(0)22 761 40 20 E +41 (0)22 761 40 25
Danmark	+45-38 32 31 20	South Africa	0800 981 089
Deutschland	+49-(0)69-51 709 427	Suomi	+358-(0)9 725 191 08
España	+34 -91-275 45 88	Sverige	+46-(0)8-501 632 83
France	+33-(0)1-57 32 32 71	Türkiye	00800 44 882 5862
Ireland	+353-(0)1 524 50 80	United Arab Emirates	8000 441-4294
Italia	+39-02-91 48 30 31	United Kingdom	+44-(0)203-024-81 59
Magyarország	+36-177-74 853	European, Mid. East., & African Hq. Romanel s/Morges, Switzerland	English: +41-(0)22 761 40 25 Fax: +41-(0)21 863 54 02
Nederland	+31-(0)-20-200 84 33	Eastern Europe	English: 41-(0)22 761 40 25
Norge	+47-(0)24 159 579		
Österreich	+43-(0)1 206 091 026		
Polska	00800 441 17 19		
Portugal	+351-21-415 90 16		







www.logitech.com

© 2009 Logitech. All rights reserved. Logitech, the Logitech logo, and other Logitech marks are owned by Logitech and may be registered. All other trademarks are the property of their respective owners. Logitech assumes no responsibility for any errors that may appear in this manual. Information contained herein is subject to change without notice.

620-001672.005

Free Manuals Download Website

<http://myh66.com>

<http://usermanuals.us>

<http://www.somanuals.com>

<http://www.4manuals.cc>

<http://www.manual-lib.com>

<http://www.404manual.com>

<http://www.luxmanual.com>

<http://aubethermostatmanual.com>

Golf course search by state

<http://golfingnear.com>

Email search by domain

<http://emailbydomain.com>

Auto manuals search

<http://auto.somanuals.com>

TV manuals search

<http://tv.somanuals.com>