



Getting started with  
Ultimate Ears™ 900  
Noise-Isolating Earphones



## Package contents

1. UE 900 earphones with audio cable
2. Vi Cable with microphone and control
3. Soft silicone ear cushions,  
5 additional pairs: XXS, XS, S, M, L
4. Comply™ Foam Tips,  
3 pairs of ear cushions: S, M, L
5. ¼-inch (6.35 mm) adapter
6. Airline adapter (reduces in-flight  
volume spikes)
7. Protective hard case
8. Pouch

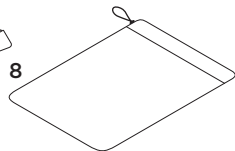
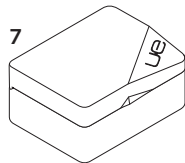
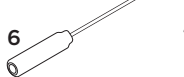
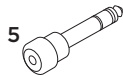

## Features

1. Earphone
  2. 3.5 mm connector
  3. Pre-formed ear loop
  4. Detachable cable
  5. Volume up
  6. Media/calling controls
  7. Volume down
  8. Ear cushion retaining rib
  9. Microphone
- One click:  
Play/pause (audio source)  
Call answer/hang up (mobile phone)
  - Double click:  
Next track (audio source)
  - Triple click:  
Previous track (audio source)

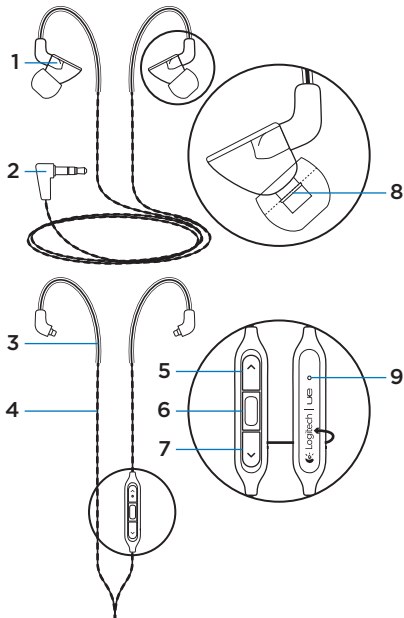

## Setup

### 1



**Comply™  
Foam Tips**



Choose ear cushion size for comfortable fit and good sound. Go to [www.logitech.com/support/ue900](http://www.logitech.com/support/ue900) for more information about choosing ear cushions.

### 2

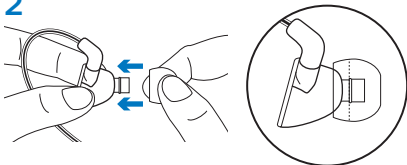

Attach ear cushions to earphones. Push cushion past rib for secure fit.

### 3

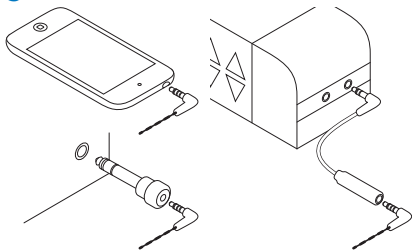

Connect earphones to a device with 3.5 mm headphone jack.

For air travel, use Airline adapter to reduce volume spikes caused by in-flight announcements.

For devices with a 1/4-inch (6.35 mm) input jack, use the 1/4-inch (6.35 mm) adapter.

4

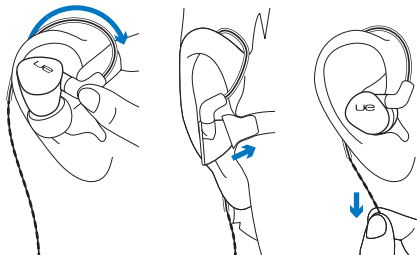

Wear the earphones

1. Wrap cable around ear.
2. Insert right earphone (marked "R") in right ear and left earphone (marked "L") in left ear.
3. Gently pull cable tight to remove slack.

Note: Do not remove earphone from ear by pulling on cable.

## Changing cables

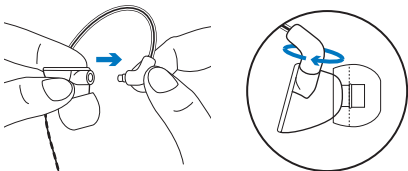

1. Hold earphone. Hold cable where it attaches to earphone.
2. Gently pull cable from earphone.
3. Attach new cable. Cable snaps into place.

Note: Make sure to connect the "R" (right) cable to the "R" earphone and the "L" (left) cable to the "L" earphone.

## Cleaning the earphones

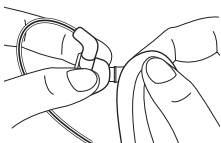

Remove cushion and wipe with clean cloth.

## Storing the earphones

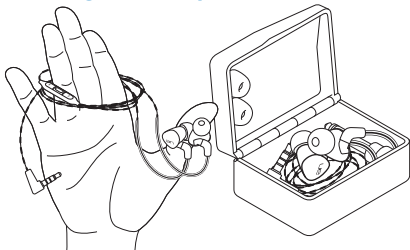

1. Wrap cable around three fingers.
2. Place earphones in case.

## Troubleshooting

- **No sound or faint sound** Fully insert cable connector into headphone jack on your device. Check cable attachment to earphone. Try increasing earphone volume, and check the volume in your media application.
- **Diminished sound quality or weak bass** Check ear cushion seal. Try another ear cushion size. Check for blockage where ear cushion connects to earphone. Remove blockage with clean cloth.
- **Earphones not working with a computer** Specify audio settings for your operating system:
  - Windows®** (Control Panel)
    - Voice playback and recording: Computer's soundcard
    - Sound playback: Computer's speakers

### Mac® OS (Preferences)

- Sound input: Internal microphone
- Sound output: Internal speakers

For more information, go to [www.logitech.com/support/ue900](http://www.logitech.com/support/ue900). Also refer to your operating system documentation.

- **Detached ear cushion** Make sure to press ear cushion past rib on earphone.

### Additional help

For online help, go to [www.logitech.com/support/ue900](http://www.logitech.com/support/ue900)

### What do you think?

Please take a minute to tell us.  
Thank you for purchasing our product.

[www.logitech.com/ithink](http://www.logitech.com/ithink)

[www.logitech.com/support/ue900](http://www.logitech.com/support/ue900)



United States

+1 646-454-3200



## POWER TO THE MUSIC

[www.logitech.com](http://www.logitech.com)

© 2012 Logitech. Logitech, the Logitech logo, and other Logitech marks are owned by Logitech and may be registered. Microsoft, Windows, and the Windows logo are trademarks of the Microsoft group of companies. Mac and the Mac logo are trademarks of Apple Inc., registered in the U.S. and other countries. Comply is a registered trademark of Hearing Components. All other trademarks are the property of their respective owners. Logitech assumes no responsibility for any errors that may appear in this manual. Information contained herein is subject to change without notice.

620-004015.004

Download from [Www.Somanuals.com](http://Www.Somanuals.com). All Manuals Search And Download.



## Free Manuals Download Website

<http://myh66.com>

<http://usermanuals.us>

<http://www.somanuals.com>

<http://www.4manuals.cc>

<http://www.manual-lib.com>

<http://www.404manual.com>

<http://www.luxmanual.com>

<http://aubethermostatmanual.com>

Golf course search by state

<http://golfingnear.com>

Email search by domain

<http://emailbydomain.com>

Auto manuals search

<http://auto.somanuals.com>

TV manuals search

<http://tv.somanuals.com>