

# marantz®

***PROFESSIONAL***

**Model PMD690 User Guide**

---

Portable PC Card Recorder

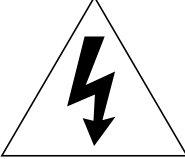
	<b>CAUTION</b> <b>RISK OF ELECTRIC SHOCK</b> <b>DO NOT OPEN</b>	
<b>CAUTION: TO REDUCE THE RISK OF ELECTRIC SHOCK, DO NOT REMOVE COVER (OR BACK) NO USER-SERVICEABLE PARTS INSIDE REFER SERVICING TO QUALIFIED SERVICE PERSONNEL</b>		

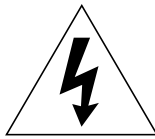

The lightning flash with arrowhead symbol, within an equilateral triangle, is intended to alert the user to the presence of uninsulated "dangerous voltage" within the product's enclosure that may be of sufficient magnitude to constitute a risk of electric shock to persons.



The exclamation point within an equilateral triangle is intended to alert the user to the presence of important operating and maintenance (servicing) instructions in the literature accompanying the appliance.

## WARNING

**TO REDUCE THE RISK OF FIRE OR ELECTRIC SHOCK,  
DO NOT EXPOSE THIS APPLIANCE TO RAIN OR MOISTURE.**

---

**CAUTION: TO PREVENT ELECTRIC SHOCK, MATCH WIDE  
BLADE OF PLUG TO WIDE SLOT, FULLY INSERT.**

**ATTENTION: POUR ÉVITER LES CHOCS ÉLECTRIQUES,  
INTRODUIRE LA LAME LA PLUS LARGE DE LA FICHE DANS LA  
BORNE CORRESPONDANTE DE LA PRISE ET POUSSER  
JUSQU'AU FOND.**

---

# SAFETY INSTRUCTIONS

## READ BEFORE OPERATING EQUIPMENT

This product was designed and manufactured to meet strict quality and safety standards. There are, however, some installation and operation precautions which you should be particularly aware of.

1. Read Instructions — All the safety and operating instructions should be read before the appliance is operated.
2. Retain Instructions — The safety and operating instructions should be retained for future reference.
3. Heed Warnings — All warnings on the appliance and in the operating instructions should be adhered to.
4. Follow Instructions — All operating and use instructions should be followed.
5. Water and Moisture — The appliance should not be used near water — for example, near a bathtub, wash-bowl, kitchen sink, laundry tub, in a wet basement, or near a swimming pool, etc.
6. Carts and Stands — The appliance should be used only with a cart or stand that is recommended by the manufacturer.
7. An appliance and cart combination should be moved with care. Quick stops, excessive force, and uneven surfaces may cause the appliance and cart combination to overturn.



8. Wall or Ceiling Mounting — The appliance should be mounted to a wall or ceiling only as recommended by the manufacturer.
9. Ventilation — The appliance should be situated so that its location or position does not interfere with its proper ventilation. For example, the appliance should not be situated on a bed, sofa, rug, or similar surface that may block the ventilation openings; or, placed in a built-in installation, such as a bookcase or cabinet that may impede the flow of air through the ventilation openings.
10. Heat — The appliance should be situated away from heat sources such as radiators, heat registers, stoves, or other appliances (including amplifiers) that produce heat.
11. Power Sources — The appliance should be connected to a power supply only of the type described in the operating instructions or as marked on the appliance.

12. Grounding or Polarization — The precautions that should be taken so that the grounding or polarization means of an appliance is not defeated.

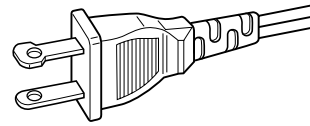

AC POLARIZED PLUG

13. Power-Cord Protection — Power-supply cords should be routed so that they are not likely to be walked on or pinched by items placed upon or against them, paying particular attention to cords at plugs, convenience receptacles, and the point where they exit from the appliance.
14. Cleaning — The appliance should be cleaned only as recommended by the manufacturer.
15. Power Lines— An outdoor antenna should be located away from power lines.
16. Outdoor Antenna Grounding — If an outside antenna is connected to the receiver, be sure the antenna system is grounded so as to provide some protection against voltage surges and built up static charges. Section 810 of the National Electrical Code, ANSI/NFPA No. 70-1984, provides information with respect to proper grounding of the mast and supporting structure, grounding of the lead-in wire to an antenna discharge unit, size of grounding conductors, location of antenna-discharge unit, connection to grounding electrodes, and requirements for the grounding electrode. See Fig. 1.
17. Nonuse Periods — The power cord of the appliance should be unplugged from the outlet when left unused for a long period of time.
18. Object and Liquid Entry — Care should be taken so that objects do not fall and liquids are not spilled into the enclosure through openings.
19. Damage Requiring Service — The appliance should be serviced by qualified service personnel when:
  - A. The power-supply cord or the plug has been damaged; or
  - B. Objects have fallen, or liquid has spilled into the appliance; or
  - C. The appliance has been exposed to rain; or
  - D. The appliance does not appear to operate normally or exhibits a marked change in performance; or
  - E. The appliance has been dropped, or the enclosure damaged.
20. Servicing — The user should not attempt to service the appliance beyond that described in the operating instructions. All other servicing should be referred to qualified service personnel.

**FIGURE 1**  
**EXAMPLE OF ANTENNA GROUNDING ACCORDING TO**  
**NATIONAL ELECTRICAL CODE INSTRUCTIONS**  
**CONTAINED IN ARTICLE 810 -"RADIO AND TELEVISION EQUIPMENT"**

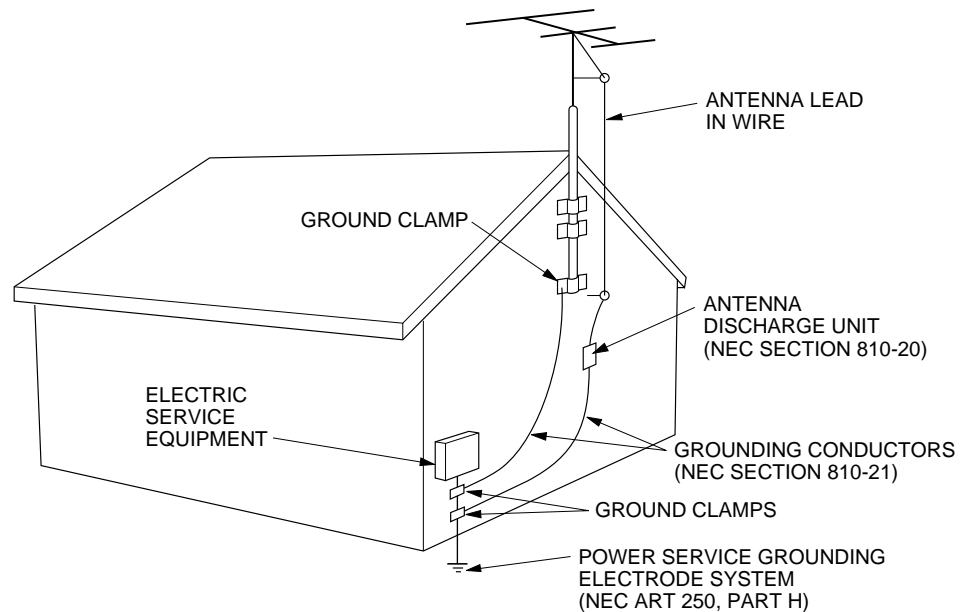

NEC - NATIONAL ELECTRICAL CODE

**NOTE TO CATV SYSTEM INSTALLER:**

This reminder is provided to call the CATV (Cable-TV) system installer's attention to Article 820-40 of the NEC, which provides guidelines for proper grounding and, in particular, specifies that the cable ground shall be connected to the grounding system of the building, as close to the point of cable entry as practical.

**NOTE:**

This equipment has been tested and found to comply with the limits for a Class B digital device, pursuant to Part 15 of the FCC Rules. These limits are designed to provide reasonable protection against harmful interference in a residential installation. This equipment generates, uses and can radiate radio frequency energy and, if not installed and used in accordance with the instructions, may cause harmful interference to radio communications. However, there is no guarantee that interference will not occur in a particular installation. If this equipment does cause harmful interference to radio or television reception, which can be determined by turning the equipment off and on,

the user is encouraged to try to correct the interference by one or more of the following measures:

- Reorient or relocate the receiving antenna.
- Increase the separation between the equipment and receiver.
- Connect the equipment into an outlet on a circuit different from that to which the receiver is connected.
- Consult the dealer or an experienced radio/TV technician for help.

**NOTE: Changes or modifications may cause this unit to fail to comply with Part 15 of the FCC Rules and may void the user's authority to operate the equipment.**

**This Class B digital apparatus complies with Canadian ICES-003.**

Cet appareil numérique de la Classe B est conforme à la norme NMB-003 du Canada.

## INTRODUCTION

Thank you for your purchase of the Marantz Professional PMD690 PC Card Recorder. The PMD690 is the next generation of portable digital recorders that bridge the gap between real-time audio recording and computers — while keeping the size and functionality of our renowned portable cassette and MiniDisc recorders.

The PMD690 has been designed as a field acquisition tool. This means that the unit itself is designed to record audio in a computer compatible file format. The audio files are then meant to be transferred to a computer for editing or transmission.

The recording medium of the PMD690, PCMCIA compatible PC Cards, allows plug-and-play compatibility with desktop and laptop computers. Flash PC Cards are based on flash memory technology that features no moving parts and is not affected by movement and temperature. Flash memory cards are available through most computer and digital photography products resellers. For a complete list of approved cards for the PMD690, please refer to the Marantz Professional website at [www.marantz.com](http://www.marantz.com).

The MP2 (MPEG1 layer2) file format that is supported by the PMD690 is a worldwide standard for compressed digital audio storage and transmission. Many playback and editing systems are available commercially and through the Internet. For more information on MP2 based playback and editing systems, please consult your dealer.

Also supported by the PMD690, PCM (Pulse Code Modulation) is the most widely used format for coding uncompressed digital audio. The PCM system is used on CD players, DAT recorders, and on computer editing programs that support Wave (.wav) files. Recording in the PCM format will provide the most universally accepted storage format but comes with the limitation that it uses a lot of memory very quickly.

## USING THIS MANUAL

Please read these operating instructions carefully. We recommend that you read the entire user guide before you connect or operate the unit.

After you have reviewed the contents this manual, we suggest that you make all system connections before you attempt to operate the unit.

## FOREWORD

This section must be read before any connection is made to the mains supply.

### WARNINGS

Do not expose the equipment to rain or moisture.

Do not remove the cover from the equipment.

Do not push anything inside the equipment through the ventilation holes.

## COPYRIGHT

Recording and playback of any material may require consent. For further information refer to the following:

- Copyright Act 1956
- Dramatic and Musical Performers Act 1958
- Performers Protection Acts 1963 and 1972
- any subsequent statutory enactments and orders

## PRECAUTIONS

The following precautions should be considered when operating the equipment.

When setting the equipment ensure that :

- the equipment will not be exposed to interference from an external source
- the equipment will not be exposed to excessive heat, cold, moisture or dust
- the equipment will not be exposed to direct sunlight
- the equipment will not be exposed to electrostatic discharges
- In addition, never place heavy objects on the equipment.
- If a foreign object or water does enter the equipment, contact your nearest dealer or service center.

## Features

- Stereo (2 channels) and monaural (1 channel) audio recording and playback
- Recording onto various types of approved PC Cards
  - Please refer to the Marantz Professional website at [www.marantz.com](http://www.marantz.com) for the complete list of approved cards
- Two different recording formats:
  - Compressed recording using MPEG1 Layer2 (MP2), mono and stereo
  - Uncompressed recording using 16-bit/48kHz Pulse Code Modulation (PCM)
- MS-DOS™ and Windows compatible file system
- Selectable file types:
  - Wave (.wav)
  - Broadcast Wave (.bwf)
  - Raw MP2 (.mp2)
- Manual, manual with limiter, and automatic (ALC) record level control
- An ANC (Ambient Noise Cancel) switch for reducing unwanted background noises
- Pre-Recording memory buffer that records 2 seconds prior to when recording is started
- Portions of multiple recordings can be played back in sequence using the EDL (Edit Decision List) system
- Three different ways to power the unit:
  - Included AC adaptor
  - 8 Alkaline AA batteries
  - Optional rechargeable Ni-Cad battery pack
- Built-in Time and Date generator marks each recording
- Remote input for pausing and un-pausing during recording or playback

---



---

## How to Use this Manual

---



---

This manual is divided into the 7 sections described below. To find out how to use a specific control, refer to the section "Index of Parts, Controls, and Display" on page I – IV.

### SETTING UP

This section describes how to set up the unit in preparation for recording and playback.

### PRESET MENU

This section provides information about the various preset menu options.

### GENERAL FUNCTIONS

This section provides information about the functions and operations that are common for recording and playback.

### RECORDING

This section describes the various input controls, record settings, and the basic recording procedure.

### PLAYBACK AND EDITING

This section describes the basic playback procedure and options, and details the editing options available to recorded tracks.

### THE EDL

This section describes the EDL (Edit Decision List) system and how to configure and manipulate EDL marks in a recording to create a custom playback sequence.

### ADDITIONAL INFORMATION

This section includes detailed information about error handling, the PC Card recording system, troubleshooting, specifications, and the "Index of Parts, Controls, and Display", which allows you to look up operations of specific controls.

---



---

## Contents

---



---

### SETTING UP

AC Adaptor and Batteries .....	3
Power On/Off .....	4
Setting the Date and Time .....	4
Understanding PC Card .....	5
Capacity of Files and Card .....	6
Connecting Microphones .....	7
Connecting Analog Components .....	7
Connecting Digital Components .....	8
Other Connections .....	8

### PRESET MENU

Preset Items .....	9
Recording Time .....	9
Preset Operation .....	9

### GENERAL FUNCTIONS

Low Battery Warning and Auto Power Off .....	12
Display Selections .....	12
Display Backlight .....	13
Key (Button) Lock .....	13

### RECORDING

Input Controls .....	14
Record Settings .....	15
Recording Operation .....	16

### PLAYBACK and EDITING

Playback .....	18
Auto Power Off .....	19
Track Editing .....	19

### THE EDL

EDL Marking .....	21
Searching for EDL Marks .....	22
Editing EDL Marks .....	23
EDL Playback .....	24

### ADDITIONAL INFORMATION

Error Messages .....	26
File Structure .....	26
Troubleshooting .....	27
Care and Maintenance .....	27
Specifications .....	28
Index of Parts, Controls, and Display .....	I ~ IV

## AC Adaptor and Batteries

### AC Adaptor

When recording for extended periods, or using this unit in a fixed environment, it is recommended to supply power to the unit via the included AC adaptor.

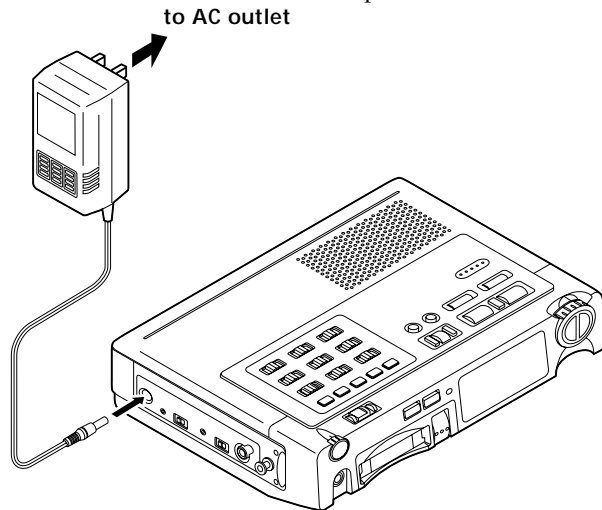

#### Note

- It is recommended to only use the Marantz Professional brand AC adaptor (model DA600) for use with the PMD690.

### Alkaline Batteries

The PMD690 can operate using 8 standard AA size alkaline batteries.

First load the batteries into the battery holder and then load the holder as shown in the following illustration.

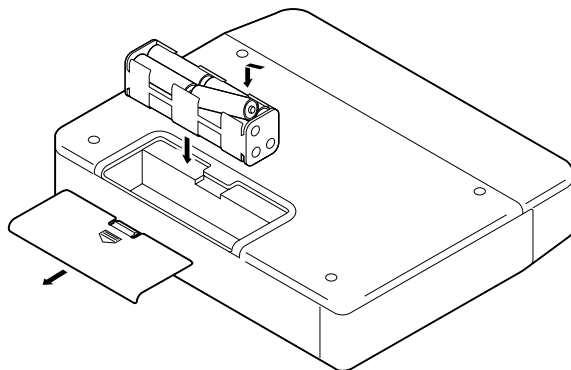

### Battery Replacement

When the battery alert indicator (⚡) appears steadily in the display, replace all batteries with new ones. For the complete description of the battery alert indicator, please refer to page 12.

Fresh alkaline batteries will provide 1-1/2 to 2-1/2 hours of record or playback time (display backlight off) depending on the type of batteries used.

Different brands of alkaline batteries provide very different levels of performance in the PMD690. For a list of the best performing alkaline batteries please see the Marantz Professional website at [www.marantz.com](http://www.marantz.com).

#### Notes

- When recording, to avoid problems caused by loss of battery power, it is recommended to always use new alkaline batteries.
- Use only AA size batteries for replacement.
- Be sure to insert the batteries with correct polarity (as illustrated on the battery holder).
- Remove the batteries if the unit will not be used for an extended period of time.
- Battery life may vary depending on the conditions under which the unit is operated (environmental temperature, humidity, speaker usage, etc.).

- If batteries leak, dispose of them immediately. Avoid touching the leaking material or letting it come into contact with clothing, etc. Clean the battery compartment thoroughly before installing new batteries.
- For optimum life and accurate battery display, make sure the battery ("bat") preset is set to "al". See page 9 for more information on the preset menu.

### Ni-Cad Rechargeable Battery (optional)

An optional Ni-Cad battery (model RB1100) is available for use with the PMD690.

Refer to the following illustration to load the battery.

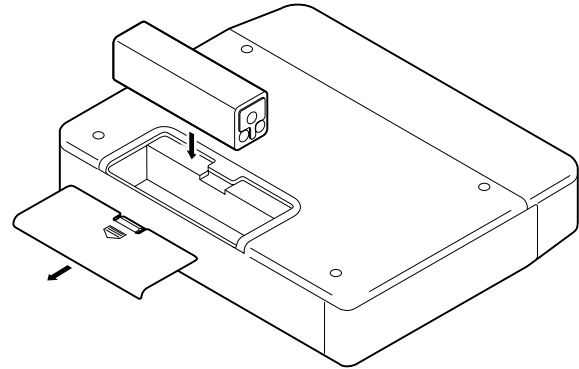

### Battery Replacement

When the battery alert indicator (⚡) appears steadily in the display, charge the battery or replace the rechargeable battery with a fully charged one.

A fully charged battery should provide 1-1/2 to 2 hours of record or playback time (backlight off).

### Charging Battery

The Ni-Cad battery is charged only when:

- The AC adaptor is connected
- The Ni-Cad battery is loaded correctly in the battery compartment
- The CHARGE slide switch is set to ON
- The power to the unit is off

While charging, the CHARGE LED will blink.

When the charge cycle is complete, the CHARGE LED will stay steadily on.

#### Notes

- The battery will not charge when the power to the unit is on.

### Charging Time

Approximately 3 hours.

#### Notes

- Make sure to fully charge the battery before first use.
- Battery life may vary depending on the conditions under which the unit is operated (environmental temperature, humidity, speaker usage, etc.).
- It is recommended to only use the Marantz Professional brand AC adaptor (model DA600) for use with the PMD690.
- For optimum life and accurate battery display, make sure the battery ("bat") preset is set to "nc". See page 9 for more information on the preset menu.
- When recording, to avoid problems caused by loss of battery power, it is recommended to always use a fully charged battery.
- Remove the battery if the unit will not be used for an extended period of time.
- If the charge LED does not blink when charging should be taking place, remove and then restore power.
- The battery power should be completely used before it is re-charged because Ni-Cad type batteries have a memory effect which will reduce the total power of the battery if it is only partially used and re-charged.

## Power On/Off

### Power On

Sliding the power switch to the right turns the power on. If a correctly formatted card is in the slot, the messages below will be displayed.

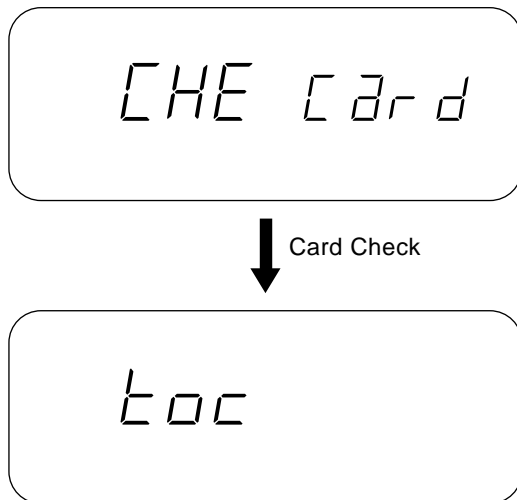

#### Note

- TOC stands for Table of Contents and it is a reference to the beginning of the card that contains the information on all the audio tracks on the card.

If the card in the slot has not been formatted to the specifications of the PMD690, the Un-Format display will appear as indicated below:



If there is no card in the slot, then the following message will be displayed:

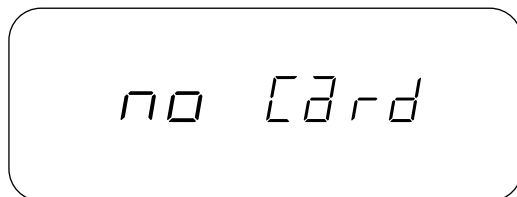

### Power Off

Sliding the power switch to the right while the power is on will turn the power off.

#### Note

- While the unit is recording or in the record-pause mode, the power switch is disabled.

## Setting the Date and Time

Before operating your PMD690, perform the following operations to set the current date and time. The current date and time are recorded automatically at the beginning of each recording.

- 1 With the power off, slide POWER to the right while holding down the DISPLAY (TIME/DATE) button. The unit turns on and enters the date/time setup mode.
- 2 Press ◀◀/▶▶ or ▶▶/▶▶ to set the month, then press PLAY/PAUSE (▶/||) to enter.
- 3 Press ◀◀/▶▶ or ▶▶/▶▶ to set the day, then press PLAY/PAUSE (▶/||) to enter.
- 4 Press ◀◀/▶▶ or ▶▶/▶▶ to set the year, then press PLAY/PAUSE (▶/||) to enter.
- 5 Press ◀◀/▶▶ or ▶▶/▶▶ to set the hour, then press PLAY/PAUSE (▶/||) to enter.
- 6 Press ◀◀/▶▶ or ▶▶/▶▶ to set the minute, then press PLAY/PAUSE (▶/||) to enter.
- 7 To save the input time/date information, press the DISPLAY (TIME/DATE) button. The seconds will start counting from 00 and the unit will enter the stop mode.
- 8 To return to the date setting display (step #2), press the PLAY/PAUSE (▶/||) instead of the DISPLAY (TIME/DATE) button.

#### Notes

- Pressing the STOP (■) button at any time during the time/date setting mode will cancel any changes and return the unit to the stop mode.
- The time is always displayed in 24-hour time. So for example, 23:59:59 is equivalent to 11:59:59 PM.
- The clock runs on an internal large capacitor. While the power is not applied, the clock runs for approximately one month.



## Understanding PC Cards

The PMD690 records digital audio directly to PCMCIA and ATA compatible PC Cards. The PC Card storage system allows direct plug-and-play compatibility with computers equipped with a PC Card slot.

PC Cards come in a variety of shapes and sizes. The PMD690 is compatible with all types as long as they are PCMCIA compatible (flash memory and hard disk cards).

Even though most PCMCIA compatible PC Card can be read by the PMD690, only certain types of cards can sustain the record speeds required. Therefore, only cards tested and approved by Marantz Professional should be used with the PMD690.

The recommended card list for the PMD690 can be found on the Marantz Professional website at [www.marantz.com](http://www.marantz.com).

### Inserting a Card

Push the PC Card into the PMD690 as follows.

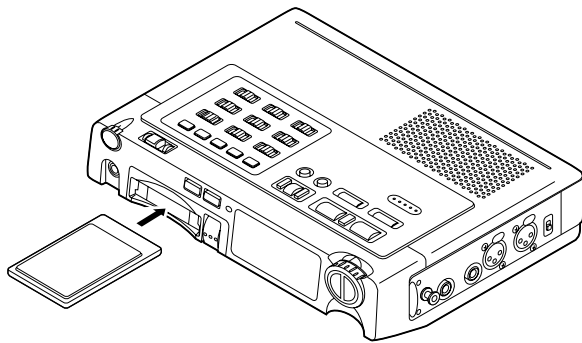

#### Note

- Make sure the card is inserted with the correct side facing up.

### Ejecting a Card

Push the EJECT button as indicated to eject the PC Card from the PMD690.

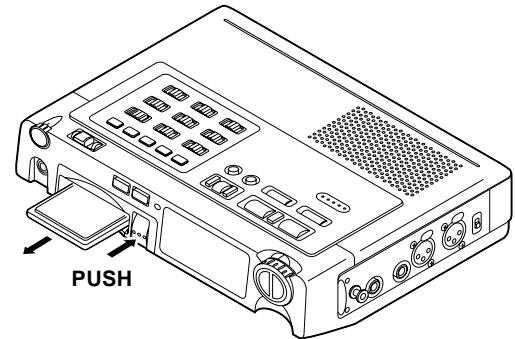

#### Notes

- The EJECT button is mechanical and ejects the PC Card regardless of the unit's power or operating status. Do not press EJECT while recording (when the REC indicator is lit). Though a secure file storage scheme is used, this may result in the loss of all data on the PC Card.
- Also do not eject the card when the unit is checking the card ("CHE card" display) or when the TOC is being read ("toc" display).

### Formatting a PC Card

Before using a PC Card for the first time, perform the following operations to format the PC Card so that it can be used to record audio. This operation completely erases any information stored on the card. Be sure to backup any important information before formatting.

#### Note

You can also use this operation to completely erase a previously used PC Card containing audio data you no longer need.

## Operation

- 1 Make sure the power is off.
- 2 Insert the PC Card to be formatted.
- 3 Slide the POWER switch to the right while holding down the ERASE (FORMAT) button.
- 4 The format message below will be displayed.



For card

- 5 After formatting the card and generating the EDL file, the "done" message below is displayed for 3 seconds.

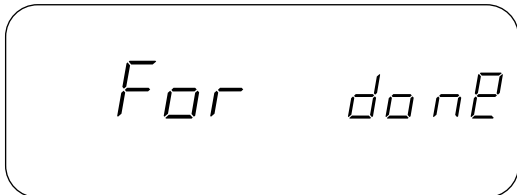

For done

- 6 The unit then enters the stop mode

### Notes

- Even if a PC Card was formatted in a Windows compatible PC, formatting by the PMD690 is necessary.
- After recording and erasing a card many times, it is recommended to format the card so that new recording can be stored in the optimum way.
- Do not eject the PC Card or turn this unit's power off while formatting is in progress.

- 7 When a card is in the PMD690 that has been correctly formatted or had all the tracks erased, the blank card message below will be displayed in the stop mode.



blank card

The blank card message indicates that the card contains no audio tracks and is ready to be recorded onto.

### Note

- The DISPLAY button can be used to check the amount of recording time available on the card based on the selected REC MODE.

## Care of PC Cards

Please refer to the documentation included with your PC card for proper care.

## Capacity of Files and Card

Due to limitations in the MS-DOS compatible file structure system, the maximum size of all the recorded tracks on a card is 1,200MB (MegaBytes) or 1.2GB (GigaBytes).

The maximum card size that can be read by the PMD690 is 2,150MB (MegaBytes) or 2.15GB (GigaBytes). Cards larger than 2.15GB may not work correctly in the PMD690.

## Connecting Microphones

Connect microphones as shown below.

You can connect two microphones for stereo to the MIC/LINE L and R (XLR) jacks.

Alternatively, you can connect just one microphone (for mono recording or dual level mono recording) to the MIC/LINE IN L jack.

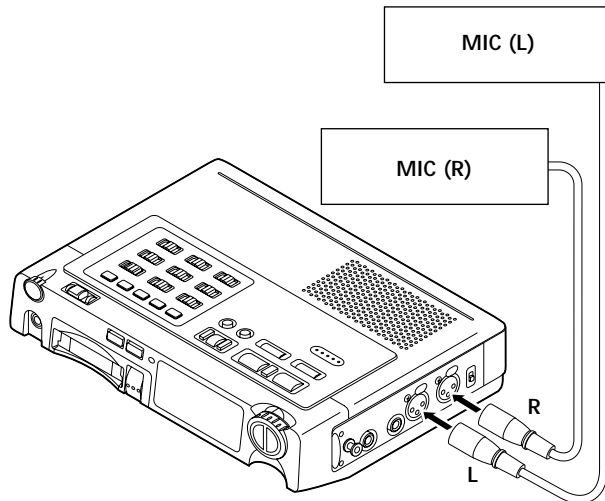

### Notes

- Take care not to connect or disconnect microphones while recording. This may result in unwanted sounds in the recording.

### Powering the microphone(s)

This unit can supply +48 V of phantom power to the connected microphone(s). If your microphone(s) require phantom power, set PHANTOM +48V to ON.

### Notes

- Phantom power is only applicable to condenser microphones. See the instruction manual of your microphones if phantom power is required.
- Do not use phantom power in combination with dynamic microphones to avoid damage to the unit or the microphones.
- You can also compensate for different microphones and/or environments. (See "ANC" and "MIC ATTENUATION" on page 14 for details.)

## Connecting Analog Components

The following illustrations show you how to connect analog audio components for recording or playback.

### To record from analog audio components

Connect the source component's analog line output jacks to the PMD690's MIC/LINE IN (XLR) jack.

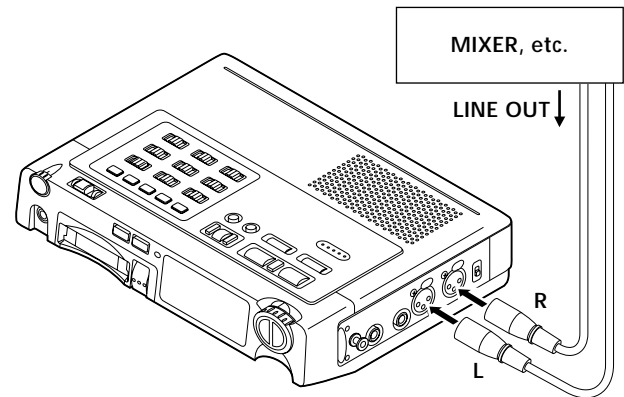

### To output analog audio signals to another audio component

Connect the LINE OUT (RCA) jack on the PMD690 to the analog input on the destination component.

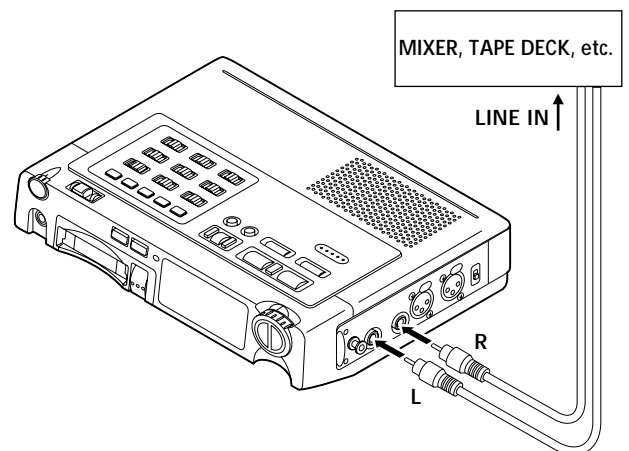

## Connecting Digital Components

The following illustrations show you how to connect digital audio components.

### To output digital audio signals to another audio component

Connect the DIGITAL OUT (RCA) jack on the PMD690 to the digital input jack on the destination component. Turn the output on by placing the switch (next to the output jack) in the ON position.

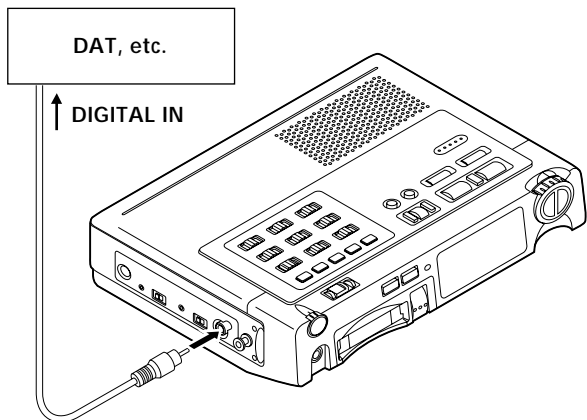

#### Notes

- Digital audio is only output during normal playback and EDL playback. Digital audio is not output during recording even if the output is turned on.
- When the digital output is not used, make sure to keep the DIGITAL OUT switch OFF to save battery life.
- Make sure the destination component accepts the SPDIF (or IEC-958-II) type digital audio format.
- Make sure the destination component accepts a sampling frequency of 48kHz or contains a digital sample rate converter.

## Other Connections

### Headphones

Connect headphones to the HEADPHONE output as indicated below. Both recording and playback can be monitored through connected headphones.

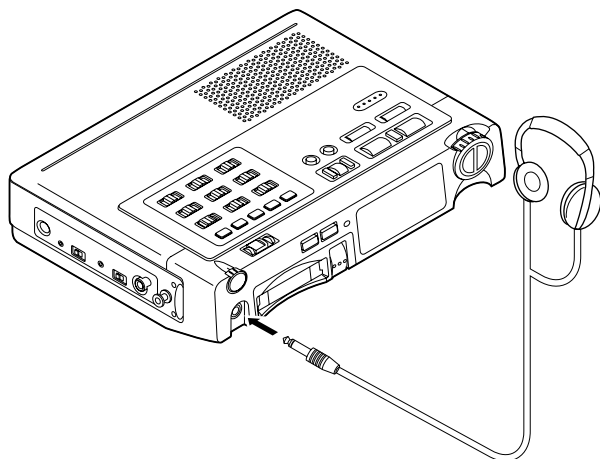

#### Notes

- Use the HP/SPK VOLUME knob to control the volume of the headphone.
- The sound from the internal speaker is muted automatically when headphones are connected.

## Remote Control

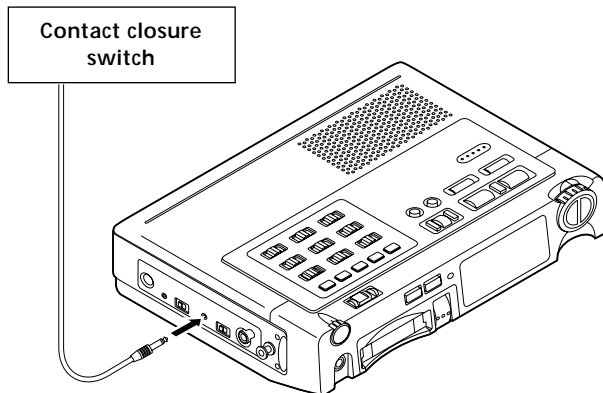

### Available Functions

The remote Pauses or Un-Pauses the unit during playback and recording.

### Polarity of the REMOTE jack

	Open	Close
Recording	Pause recording	Resume recording
Playback	Resume playback	Pause playback

#### REMOTE

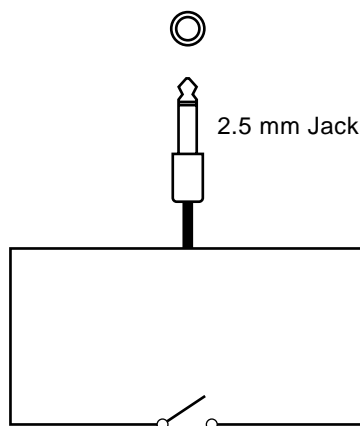

## Preset Items

The preset menu of the PMD690 allows many features and functions of the unit to be customized for individual requirements.

The following items can be accessed in the preset menu:

- Bitrates assigned to the SP/LP/MONO switch
- Sound detection level of the silent skip function
- Detection time of the silent skip function
- Alarm beep on or off
- Battery type used
- File format of the recorded tracks
- ID1
- ID2
- ID3

Preset	Display	Available Options	Default Setting
Bit rate of STEREO SP	br	PCM: 1536 kbps (PC2) <sup>1)</sup> MPEG: 384, 256 kbps <sup>1)</sup>	256 kbps
Bit rate of STEREO LP	br	MPEG: 192, 128, 96, 64 kbps <sup>1)</sup>	128 kbps
Bit rate of MONO	br	PCM: 768 kbps (PC1) <sup>1)</sup> , MPEG: 192, 128, 96, 64, 48, 32 kbps <sup>1)</sup>	64 kbps
Sound level for silent skip	SL	-50dB to -10dB, 5dB step	-40 dB
Silent time for silent skip	St	1 to 5 second	3 seconds
Alarm beep	aLa	on, off <sup>2)</sup>	on
Battery type	bat	Alkaline, Ni-Cad, Ni-MH,	Alkaline
File format	For	Wave (.wav) <sup>3)</sup> , MP2 (.mp2), Broadcast Wave (.bwf)	MP2
ID1,2,3	Id1 Id2 Id3	000000 to 999999	000000

**Note 1)**

Please refer to the following section.

**Note 2)**

On/off for alarm beep at auto power off and for low battery warning.  
See page 12 "Low Battery Warning and Auto Power Off", and page 19 "Auto Power Off".

**Note 3)**

Wave (.wav) format files that contain MP2 recorded information may not be suitable for some computer systems.

## Recording Time

The amount of memory required per hour of recording is as follows.

Bit Rate (kbps)	MB/Hour
32	16 MB
48	25 MB
64	33 MB
96	50 MB
128	67 MB
192	100 MB
256	136 MB
384	200 MB
768 (PC1, PCM Mono)	400 MB
1536 (PC2, PCM Stereo)	800 MB

## Preset Operation

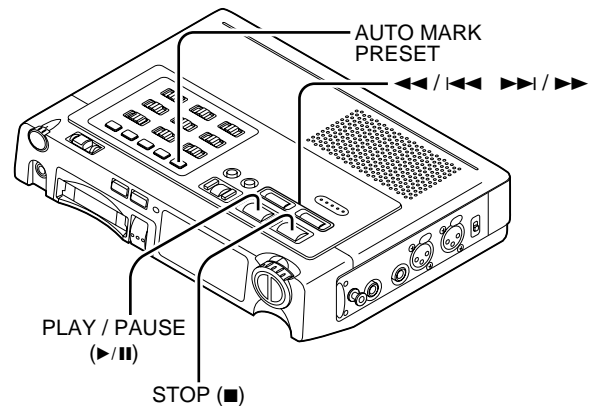

1. While power is off, press and hold the AUTO MARK (PRESET) button and then slide the power switch to the right.
2. The unit should enter the preset setting mode and "Preset" should be indicated in the display.
3. The unit will then automatically display (flashing) the first preset -- bitrate for the SP record mode.
4. Use ◀◀/|◀◀ and ▶▶/|▶▶ buttons select which preset item you would like to change. The order of the preset menu items is the same as indicated on a preset chart on this page.
5. Use the PLAY/PAUSE button to alternate between changing the preset item and the available options for the currently displayed preset (the preset item options will flash).
6. Use ◀◀/|◀◀ and ▶▶/|▶▶ buttons to then select which option you would like for the current preset item.
7. When finished making a change to a preset item, press the PLAY/PAUSE button to select another preset item to change (preset item will flash).
8. When finished setting all the presets, press the AUTO MARK (PRESET) button to save all the changes and exit the preset menu mode.
9. If you do not want to save the changes made to the preset menu, press the STOP button to exit without saving the changes.
10. After exiting the preset menu mode, the unit will return to normal operation in the stop mode.

**Note**

- The preset settings remain stored after the power is turned off.

# PRESET MENU

Example: Changing the bitrate preset

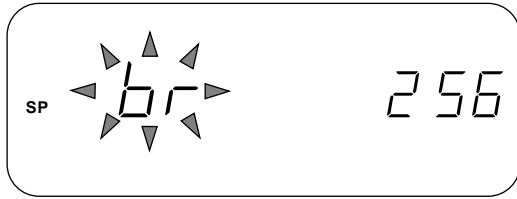

↓ Bit rate of STEREO SP (Short Play) REC MODE  
▶/||

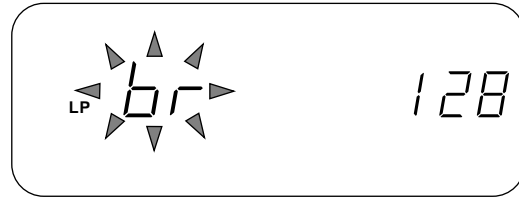

↕ Bit rate of STEREO LP (Long Play) REC MODE is 128 kbps.  
◀◀ / | ◀◀, ▶▶▶ / ▶▶▶

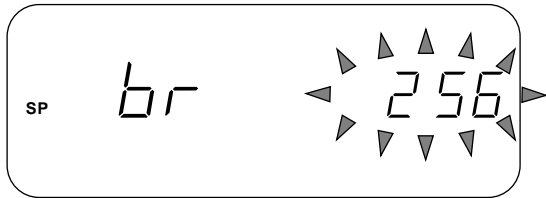

↕ Bit rate is 256 kbps in Stereo.  
◀◀ / | ◀◀, ▶▶▶ / ▶▶▶

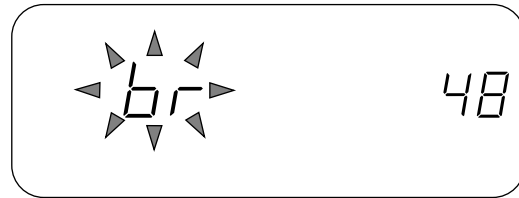

↓ Bit rate of MONO REC MODE.  
▶/||

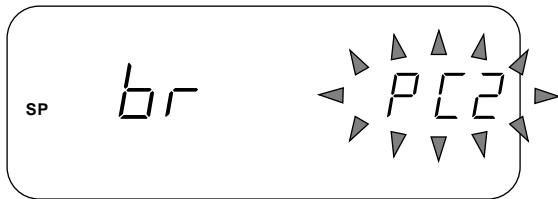

↓ PCM Stereo (PC 2: PCM 2 channels, 1536 kbps)  
▶/||

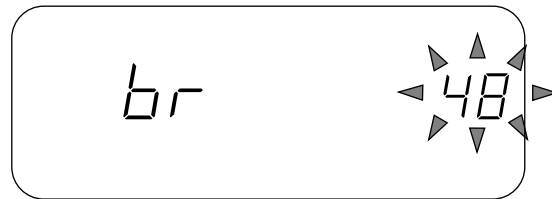

↕ Bit rate of MONO REC MODE is 48 kbps.  
◀◀ / | ◀◀, ▶▶▶ / ▶▶▶

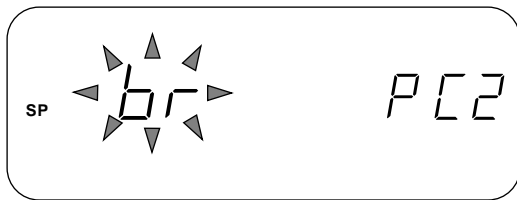

↕ Bit rate of SP REC MODE is PCM stereo  
◀◀ / | ◀◀, ▶▶▶ / ▶▶▶

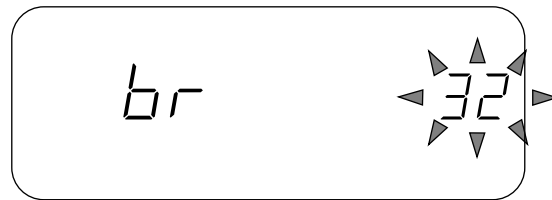

↕ Bit rate of MONO REC MODE is 32 kbps.  
◀◀ / | ◀◀, ▶▶▶ / ▶▶▶

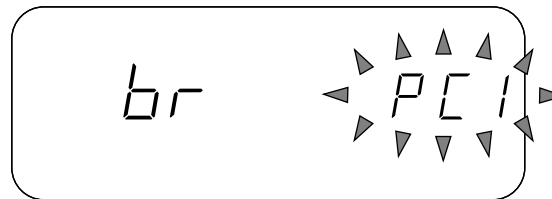

↓ Bit rate of MONO REC MODE is PCM. (PC1: PCM 1 channel, 768 kbps)  
▶/||

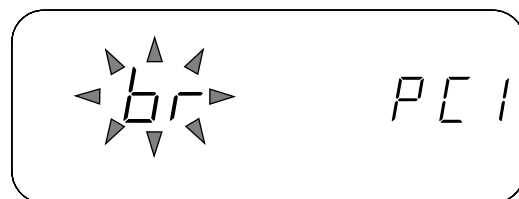

Bit rate of MONO REC MODE is set to PCM mono.

Example: Changing the battery type preset

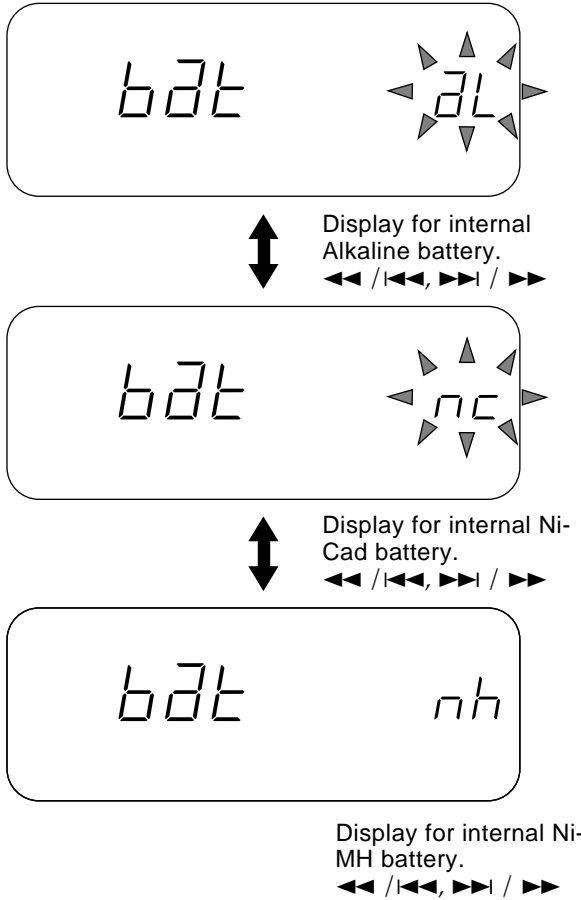

Example: Changing the file format preset

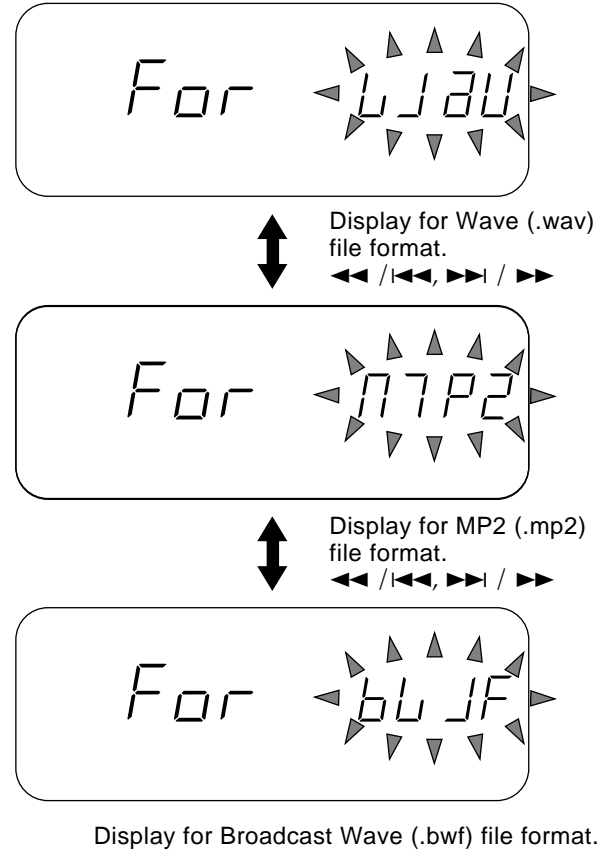

Note

Ni-Cad (RB1100) is option of PMD690.  
The Ni-MH battery preset ("nh") should be used in conjunction with the optional Marantz Ni-MH battery or if commercially available AA-sized Ni-MH batteries are used in conjunction with the alkaline battery holder.

ID Number Presets

The ID numbers are saved in the 'Extension Chunk' of the Broadcast WAVE (BWF) file format. The IDs are defined as follows:

- ID1 :Description
- ID2 :Originator
- ID3 :Originator Reference

Example:

If the IDs are used in a broadcast station situation:

- ID1 could be used for the ID of the broadcasting station
- ID2 could be used for the department code
- ID3 could be used for the badge number of the reporter

ID Number Setting Operation

- The PLAY/PAUSE button will cycle through each digit of the selected ID#.
- The ◀◀ / | ◀◀ and ▶▶ | ▶▶ buttons will increase or decrease the digit that is flashing.

## Low Battery Warning and Auto Power Off

The PMD690 has built-in power management and emergency shut-down system when batteries are used.

To make sure this system operates correctly, make sure the battery preset ("bat") in the preset menu is set correctly. Please refer to page 9 for more information on how to set the presets.

### 1st Warning

When the remaining battery time starts running low, a 1st warning will appear. The 1st warning is when the low battery indicator appears in the display as follows. After the 1st warning appears, the battery has approximately 5 to 10 minutes of total record or playback time remaining.

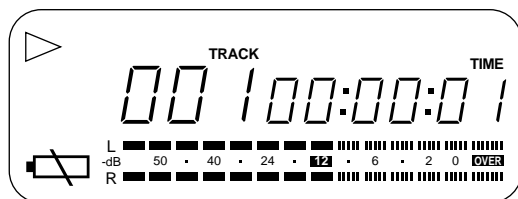

### 2nd Warning

When the remaining battery time becomes extremely low, the 2nd warning will appear. The 2nd warning is when the battery indicator begins to flash as indicated in the diagram below.

After the second warning appears, the battery has approximately 1 to 3 minutes of recording or playback time remaining.

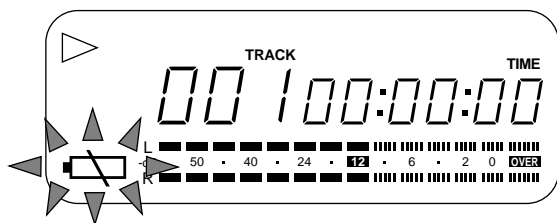

### Note

If the alarm preset ["alB"] is set ON, the PMD690 will audibly beep to alert that the batteries life is nearing an end.

When recording from microphone (INPUT switch position is at MIC), beep sounds only from headphone, not from speaker.

### Shut-Down

If the unit continues to operate after the 2nd warning appears, the unit will enter an automatic shut-down procedure before all power is lost. Recording or playback will stop and the unit will automatically power itself off.

## Display Selections

### Changing the Displayed Information

Pressing the DISPLAY (TIME/DATE) button will change the displayed information as follows.

### During Stop Mode

- ① Total Track #                      Total Track Time

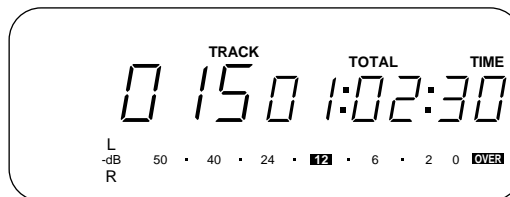

- ② Total Track #                      Total Remain Time  
(time available for recording at the selected bit rate)

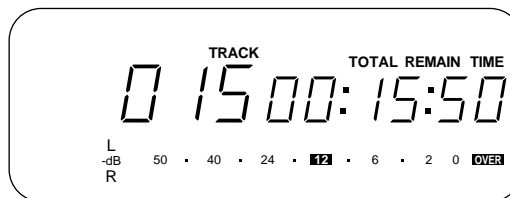

- ③ Current Time



### Note

- The time is always displayed in 24-hour time. So for example, 23:59:59 is equivalent to 11:59:59 PM.

- ④ Current Date (MM:DD:YY)



### Note

- The date is always displayed in Month, day, Year (MM:DD:YY) format.



### During Playback and Play-Pause

- ① Current Track #      Time elapsed on current playing track

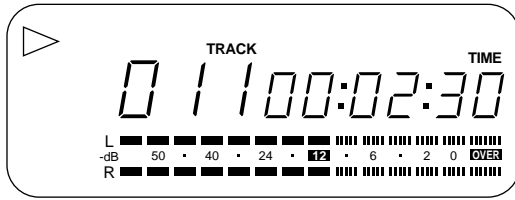

- ② Current Track #      Remaining time of current playing track

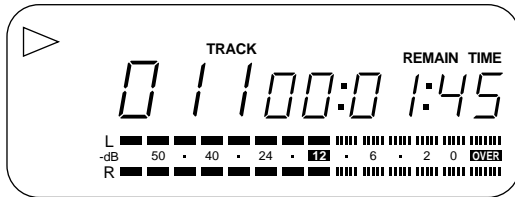

- ③ Current Track #      Accumulated time elapsed (Total time of tracks previous to the current track + time elapsed on current playing track)

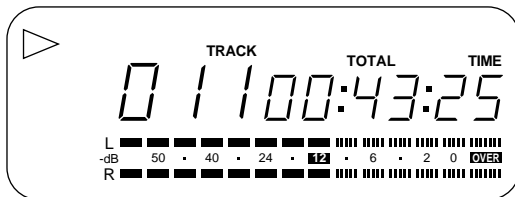

- ④ Current Track #      Total playback remain time (Total time of tracks after the current track + remain time of current playing track)

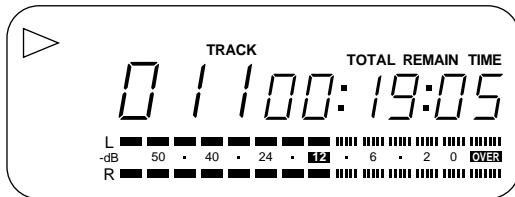

- ⑤ Recorded Mode of the Current track      Time when the current track was recorded  
(St: Stereo, M: Mono)

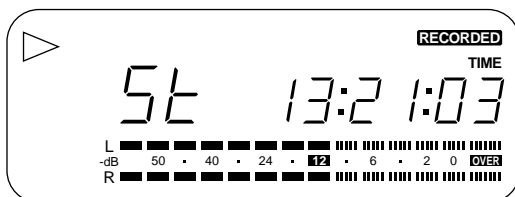

**Note**  
• The time is always displayed in 24-hour time. So for example, 13:21:03 is equivalent to 1:21:03 PM.

- ⑥ Recorded Bit Rate of the Current Track      Date when the current track was recorded

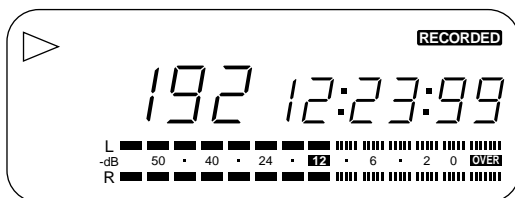

### During Recording and Record-Pause

- ① Current Track #      Recording elapsed time on current track

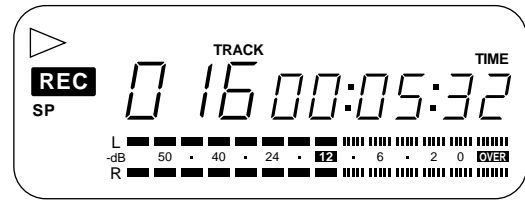

- ② Current Track #      Remaining recording time (Time available for recording)

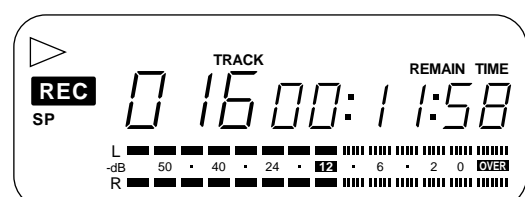

- ③ Current Track #      Accumulated recording time elapsed (Total time of tracks previous to the current track + recording time elapsed on the current track)

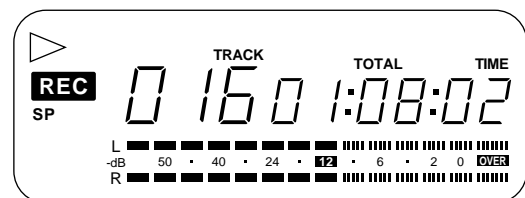

## Display Backlight

To Illuminate the Display:

- Press the LIGHT button:  
The display backlight will turn on for 3 seconds and then turn off.
- Press and hold the LIGHT button for more than 1 second:  
The display backlight will stay on until it is turned off by pressing the LIGHT button or if the power is turned off.

## Key (Button) Lock

The KEY LOCK switch sets the unit in the mode at the time the switch was set. This locking function can prevent accidental changes in a set mode or lock the unit in recording or playback.

While the Key Lock is on, the only switches and functions available are as follows:

- LIGHT
- POWER (except during recording)
- All the top panel slide switches except: PRE REC and REC MODE

If a locked button is pressed, the following message will be displayed.

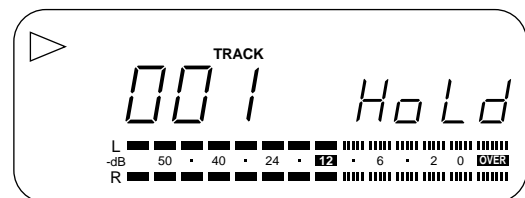

## Input Controls

### INPUT Selection

The PMD690 can record from a variety of inputs:

- XLR microphone connection (L/R, L)
- Internal microphone
- Line level source (L/R, L)

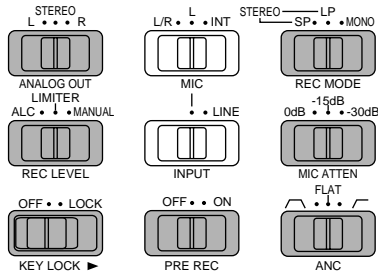

The INPUT switch offers selection of microphone (MIC) or line level (LINE) input.

#### Notes

- The MIC switch above the INPUT switch is only active when the INPUT switch is set to the middle (MIC) position.
- When REC MODE is STEREO (SP or LP) and INPUT is LINE, the input is stereo (L and R of the line inputs).
- When REC MODE is MONO and INPUT is LINE, the input is L channel of the line inputs.

### MIC ATTEN (Attenuation)

The MIC ATTEN switch adjusts the base input level for MIC L/R and MIC L inputs only.

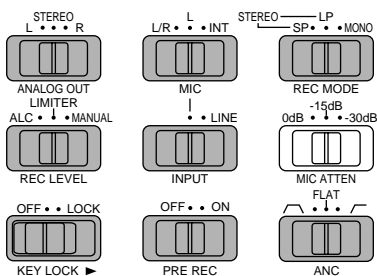

Adjusting the microphone attenuation allows microphones with higher sensitivity to be recorded and controlled the same way as microphones with lower sensitivity.

### ANC (Ambient Noise Cancel)

The ANC (Ambient Noise Cancel) switch is only applicable to microphone inputs but does not affect the line input.

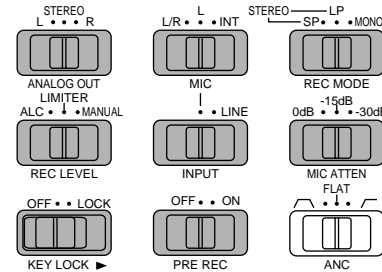

This ANC feature allows the recorder to filter out unwanted background noise. The available settings are as follows.

- Band-pass (  $\nabla$  ) : Cuts low frequency (150Hz and lower, ex : wind noise, proximity effect) and high frequency (3KHz and higher)
- Flat : No filtering
- Low-cut (  $\neg$  ) : Cuts low frequency (150Hz and lower, ex : wind noise, proximity effect)

### REC LEVEL Control

The PMD690 offers three ways to control the recording level: manual (MANUAL), manual with a limiter (LIMITER), and automatic (ALC).

- MANUAL: The recording level is controlled by the REC LEVEL knob.
- LIMITER: The recording level is controlled by the REC LEVEL knob but a limiting circuit in the PMD690 will not allow the input signal to overload (go past the -9dB mark on the level meter). The recover time is short so that the set record level is maintained as much as possible. The REC LED will dim when the Limiter is heavily limiting the input signal.
- ALC (Automatic record Level Control): The recording level in this mode is controlled exclusively by the PMD690 and the REC LEVEL knob is disabled. The recover time of the system is long so that the recording level does not constantly fluctuate.

### Setting the Record Level

- The optimum recording level is where the peak of the input sound just barely flickers past the -12dB point (highlighted in black in the display).
- The recording level should never reach the overload point in the level meter (OVER symbol highlighted in black). Reaching that point will result in digital noise which is very uncomfortable for the ear.

### Input Controls Summary

Input		Switch		
		MIC ATTEN	ANC	REC LEVEL
MIC	XLR microphone connector input	Effective	Effective	Effective
	Internal microphone Input	Not effective	Effective	Effective
Line Input		Not effective	Not effective	Effective

# Record Settings

## REC MODE

Three programmable record modes are available for each track that is recorded. See the Preset Menu section for information on how to change the value of each of the record modes.

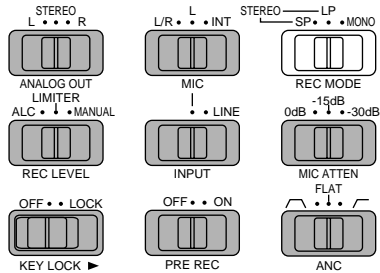

The three available modes are as follows.

- **MONO:** Monaural recording (1 track). Neither "SP" nor "LP" icon will be displayed when in the record-pause or record modes.
- **LP (Long Play, Stereo):** This setting offers lower sound quality than the SP mode but takes up less memory space. The "LP" icon will be displayed during the record-pause and record modes.
- **SP (Short Play, Stereo):** The setting with the highest sound quality but the shortest record time. The "SP" icon will be displayed during the record-pause and record modes.

## Dual LEVEL MONO

When the MIC switch is at L or at INT, and when the REC MODE switch is set to SP or LP, DUAL LEVEL MONO recording takes place. The L (left) channel is recorded at normal sound level, and R (right) channel at -15dB.

**Note**

DUAL LEVEL MONO works only for MIC input, not for LINE input.

## L/R MIX MONO

When the MIC switch is set to L/R and the REC MODE switch is set to MONO, the L and R inputs will be combined and recorded onto a single track.

The chart below indicates the relation between the MIC switch and the REC MODE switch.

MIC Switch \ REC MODE switch	L/R	L	INT
SP	Stereo recording	Dual Level Mono Recording	
LP			
MONO	L/R Mix Mono Recording	Mono Recording	

## PRE REC

The 2-second pre-record feature is active when the PRE REC switch is set to the ON position.

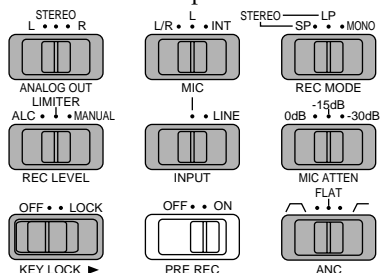

When pre-record is active, the unit will record 2 seconds of audio before the record button is pressed to start recording. The benefit of the pre-record function is that it can prevent missed or delayed starts of a recording.

**Notes**

- For the pre-record function to operate correctly, the PMD690 must be in the record-pause mode for at least 2 seconds. If the unit is in record-pause for less than 2 seconds, then the pre-record time will be shorter than 2 seconds.
- When recording is started with the pre-record function active, the elapsed recording time in the display will start at the 2 seconds mark.
- Pre-record is automatically activated when the Silent Skip feature is on.

## SILENT SKIP

The SILENT SKIP button activates the silent skip mode and the "S.SKIP" icon will be displayed.



The silent skip system operates during the record mode only and is based on the parameters set in the preset menu. Please refer to the Preset Menu section on page 9 for information on setting the operational parameters of the silent skip system.

When active during recording, the silent skip system will continually look for the preset sound level, for the preset amount of time. If the preset sound level is sensed for the preset time, the unit will enter the record-pause mode.

The silent skip system will then stay in the record-pause mode until a signal of approximately -30dB is input. The unit will then re-enter the record mode and will continue to record until the preset parameters of the silent skip system are met again.

**Notes**

- When first going into the record-pause mode from stop, recording must be started manually with the REC/MARK button. After recording is started, the silent skip system will control the recording.
- If the silent skip system pauses a recording, recording can be re-started manually by pressing the REC/MARK or PLAY/PAUSE buttons.
- The pre-record function is always active while the silent skip function is turned on. This is done to prevent audio from being cut-off when the system starts and stops.

## AUTO MARK

The AUTO MARK button activates the auto marking system and the "A.MARK" icon will be displayed.



When the auto mark feature is active, every time a recording is paused, manually or by the Silent Skip system, an EDL mark is placed at that point in the track. Please refer to the section titled "The EDL" on page 21 for information on the meaning and uses of the EDL marks.

**Notes**

- Auto mark can be switched on or off in any mode.
- An EDL mark is automatically placed at the beginning of each track, regardless if the auto mark function is on or off.
- Marks are automatically placed in the normal record mode and also in the silent skip record mode.
- The maximum number of EDL marks on a card is 255. If the card reaches 255 marks, the auto mark function will automatically turn off and the AUTO MARK button will not allow the function to be re-activated.
- If the maximum number of EDL marks (255) is reached, "FULL -P 255" will be indicated on the display for 3 seconds.
- If the maximum number of EDL marks (255) is reached, individual EDL marks or all the EDL marks can be erased. Please refer to the Editing EDL Marks section on page 23 for information about erasing EDL marks.

## Recording Operation

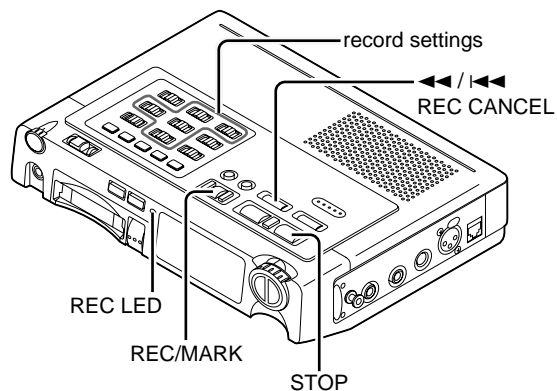

### Basic Procedure

1. Make sure all input selection and record settings are made correctly.
2. Press the RECORD/MARK button to enter the Record-Pause mode. The input signal will now appear in the level meter of the display and the REC LED and REC indicator in the display will flash.

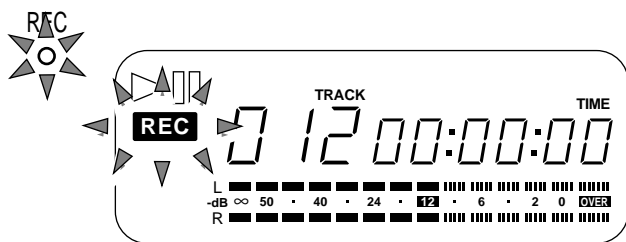

3. If the REC LEVEL switch is set to MANUAL or LIMITER, the REC LEVEL knob will be active and allow you make adjustments to the recording level based on the input source. Refer to page 14 for information on setting the recording level.
4. When ready to record, press the RECORD/MARK button to start recording. The REC LED and REC indicator in the display will stay steadily on and the current track number will quickly alternate with the next EDL mark number, showing that an EDL mark was placed at the beginning of the track.

REC  
○

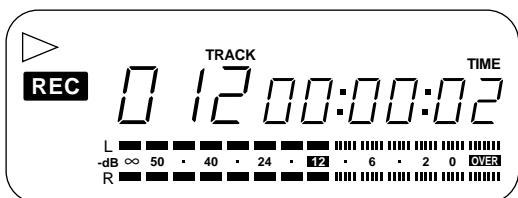

#### Note

- Pressing the REC/MARK button during recording will add an EDL mark at the point that the button was pressed.

5. To stop recording but then continue to record to the current track, recording must be paused and not stopped. Press the PLAY/PAUSE button to enter the record-pause mode and then press REC/MARK to resume recording.
6. When ready to stop recording and complete the current track, press the STOP button. The TOC will be updated and the unit will enter the stop mode.

#### Notes

- All record settings can be changed during recording except the REC MODE. If the REC MODE is changed during recording, the new setting takes effect for the next track.
- If the Auto Mark feature is active during recording, every time a track is paused an EDL mark is added.
- The REC LED will dim when the Limiter is heavily limiting the input signal.
- The minimum length of a track is 0.5 seconds. A track of less than 0.5 seconds will not be recorded on the card.

### Rec Cancel

The Rec Cancel function allows a recording that is in progress to be started over in case there is a problem or the information recorded so far is not what was intended. Performing this function will result in all the information recorded up to that point in the track to be discarded.

After performing the function, the unit will re-start at the beginning of the current track and wait for recording to be started again.

1. While recording press the ◀◀/▶▶ (REC CANCEL) button.

The "can" message will flash as follows in the display.

REC  
○

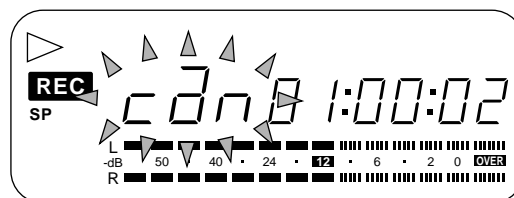

2. Press ◀◀/▶▶ (REC CANCEL) again within 3 seconds to perform the Rec Cancel function.
3. The PMD690 will discard the recording on the current track and re-enters the record-pause mode at the beginning of the track.
4. If the ◀◀/▶▶ button is not pressed within 3 seconds while the "can" message is flashing, recording will continue as normal.

#### Note

- Recording will continue while the "can" message is flashing.

## Source Monitor

For source monitor output and level meter, refer to the table below.

### Source monitor output according to ANALOG OUT switch (during Rec-Pause or Rec)

Recording Mode		Stereo			Dual Level Mono			Mono		
ANALOG OUT switch		L	Stereo	R	L	Stereo	R	L	Stereo	R
Output (Source Monitor Output)	Headphone (L channel)	L	L	R	L=R=Mono	Mono -15dB	Mono -15dB	L=R=Mono		
	Headphone (R channel)		R							
	Speaker	OFF								
	Line Out (L channel)	L			Mono			L=R=Mono		
	Line Out (R channel)	R			Mono -15dB					
	Digital Out	L/R			Mono/Mono -15dB			L=R=Mono		
Level meter	Upper	L			Mono			Mono		
	Lower	R			Mono -15dB			OFF		

## Full Cards

The following message will appear if the PC Card is filled during recording or if attempting to start recording with a full card.

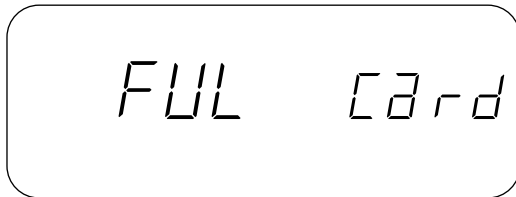

In order to re-use a full card, tracks need to be erased or the card needs to be re-formatted (erases all tracks).

## Maximum Number of Tracks

Each PC Card can hold a maximum of 255 tracks. When attempting to start recording when the maximum number of tracks is reached, the following message will be displayed.

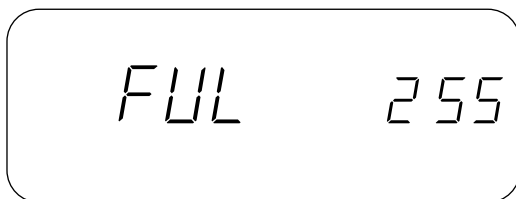

In order to continue to use a full card, tracks need to be erased or the card needs to be re-formatted (erases all tracks).

## Playback

The standard playback mode will play all the tracks on a card in order. Alternative playback options are the EDL playback mode, where the EDL marks in the tracks control playback, and the Repeat playback mode where either a single track is continually repeated or all the tracks on a card are continually repeated.

The played back audio signal is simultaneously output to the HEADPHONE jack, LINE OUT, DIGITAL OUT (if turned on), and speaker (if no headphones are connected). The HP/SPK VOLUME knob above the HEADPHONE jack controls the output volume through the headphones and speaker. All other outputs are a fixed level.

For output and levelmeter, refer to the table at the bottom of this page.

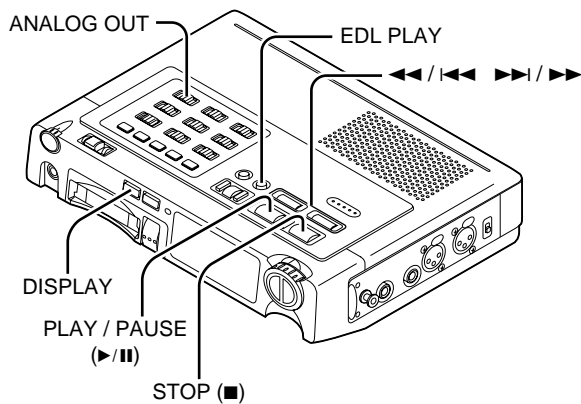

### Basic Procedure

1. From the stop mode, press the PLAY/PAUSE button to start playback from the first track on the card.
2. Playback can be paused at any point by pressing the PLAY/PAUSE button. Playback is resumed by pressing the PLAY/PAUSE button.
3. Press the DISPLAY (TIME/DATE) button to alternate between the various track information display options. Refer to the Display Selections section on page for more information.
4. Playback will continue until the all the tracks on the card have been played or the STOP button is pressed to stop playback.

### Starting Playback from a Selected Track

1. From the stop mode, press the ◀◀/|◀◀ or ▶▶/|▶▶ button until the desired playback track is indicated in the display.
2. Press the PLAY/PAUSE button to start playback.
3. Playback can be paused at any point by pressing the PLAY/PAUSE button. Playback is resumed by pressing the PLAY/PAUSE button.

4. Press the DISPLAY (TIME/DATE) button to alternate between the various track information display options. Refer to the Display Selections section on page 12 for more information.
5. Playback will continue until the all the remaining tracks on the card have been played or the STOP button is pressed to stop playback.

### Reverse and Forward Search

During playback, press and hold the ◀◀/|◀◀ or ▶▶/|▶▶ button to perform an audible search (4 times normal speed) in the reverse or forward direction. Release the ◀◀/|◀◀ or ▶▶/|▶▶ button to return to the normal playback speed.

#### Notes

- Reverse and forward searching will continue to the next or previous track if held down past the beginning or the end of a track.
- If Repeat or Repeat 1 is on, the searching will follow the track order of the Repeat mode.
- These functions are not available during EDL playback and EDL repeat playback modes.

### Fast Reverse and Forward Search

For very large tracks, the normal reverse and forward search speeds are too slow if certain points later in the track need to be reached. Therefore, a 30 and 250 times normal speed search is possible.

During playback, press the PLAY/PAUSE button to enter the pause mode in the desired track you want to search. Then press and hold the ◀◀/|◀◀ or ▶▶/|▶▶ button to start fast search in the reverse or forward direction. The search speed will be 30 times normal for 3 seconds and then become 250 times normal for the rest of the time the button is held. Release the ◀◀/|◀◀ or ▶▶/|▶▶ button to return to the pause mode.

#### Notes

- There is no sound output in either of the fast search speeds.
- Reverse and forward searching will continue to the next or previous track if held down past the beginning or the end of a track.
- If Repeat or Repeat 1 is on, the searching will follow the track order of the Repeat mode.
- These functions are not available during EDL playback and EDL repeat playback modes.

### Selecting Tracks

In the stop, play, or pause modes, tracks previous or next are selected by pressing the ◀◀/|◀◀ and ▶▶/|▶▶ buttons, corresponding the desired direction.

If the ◀◀/|◀◀ button is pressed while playing back a track or when paused at some point in a track, the beginning of the current track is selected. Quick subsequent presses of the ◀◀/|◀◀ button will then select previous tracks.

#### Note

- Erased tracks numbers are skipped when selecting tracks unless the Renumber function is performed. Please refer to page 20 for more information on the Renumber function.
- These functions are not available during EDL playback and EDL repeat playback modes.

### Repeat Play, Single Track Play

The PMD690 can be set to repeatedly playback a single track or all the tracks on a card. The PMD690 also can be set to play a single track and pause.

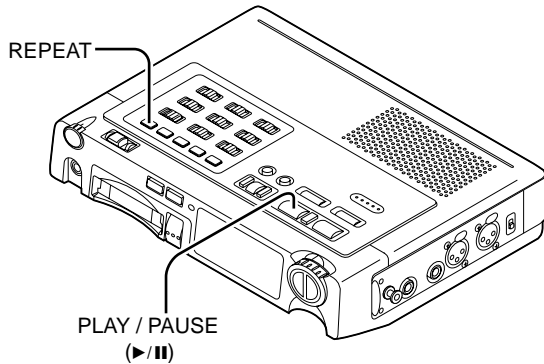

To enter the single track repeat mode, press the REPEAT button so that the "REPEAT 1" is indicated in the display as shown below.

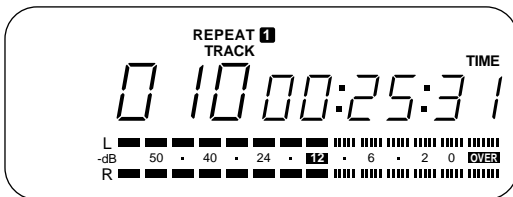

To enter the all track repeat mode, press the REPEAT button so that "REPEAT" is indicated in the display as shown below.

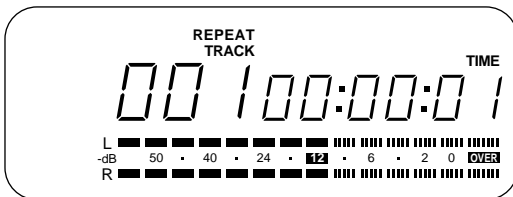

To enter single track play mode, press the REPEAT button so that the "1" is indicated in the display as shown below. After playing the track, the PMD690 pauses at the beginning of next track.

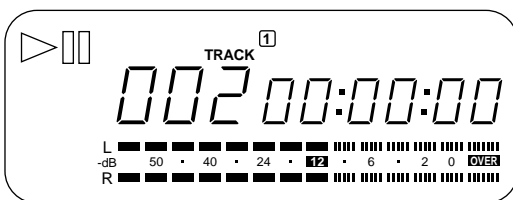

### Output Selection

The ANALOG OUTPUT switch is used to select the output through the headphones, speaker, and line output.

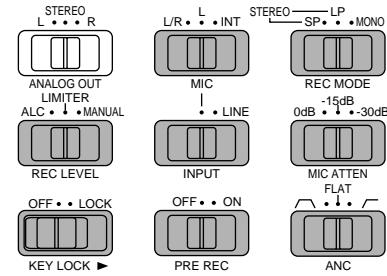

This switch has effect only on Stereo and Dual Mono recordings (not Mono recordings). The normal position is Stereo, which will playback the audio on card as it was recorded (left channel of the recording to the left channel of the headphone and line out and the right channel of the recording to the right channel of the headphone and line out).

If the L (left) or R (right) position is selected, that channel of the recording will be output to both the left and right channels of the headphones and line out jacks.

### Auto Power Off

If the PMD690 is not operated for 5 minutes during stop or play pause, the power is automatically shut off in order to conserve battery life. The alarm beep sounds for 30 seconds until the Auto Power Off.

If the alarm preset ["ALARM"] is set ON, the unit will beep to alert that the power is automatically shut off.

### Track Editing

The PMD690 allows only two ways to directly manipulate the recorded tracks on a card, Erase and Renumber.

Erasing a track will permanently delete a recorded track from a card. The track number of the deleted file is eliminated but a higher number track does not take its place. The deleted track number remains gone until the Renumber function is performed.

**Note**

- The next recorded track is always the last track on the card. Therefore, if a deleted track is the last track on a card or a deleted track is the last track on the card and other tracks directly previous have been deleted, then the next recorded track number will be a number of a track that has been deleted.

The Renumber function will re-order all the tracks on a card in a sequential order starting from number 1. For example, if a card has three tracks numbered 2, 4, and 6, the Renumber function will change the track numbers to 1, 2, and 3. So the old track 2 becomes track 1, the old track 4 becomes track 2, and the old track 6 becomes track 3.

## Track Erase



1. From the stop mode, use the ◀◀/|◀◀ and ▶▶/|▶▶ buttons to select the track that is to be deleted.
2. Press the ERASE (FORMAT) button. The "Erase" message will flash in the display as follows.

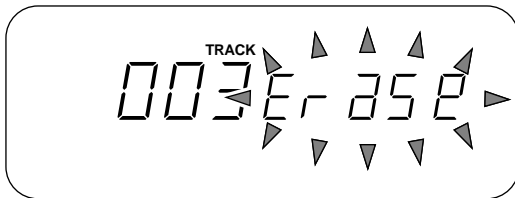

3. Press the ERASE button again to confirm the track erase. The "Erase" message will stay steadily on in the display as follows to indicate that the Erase function is executing.

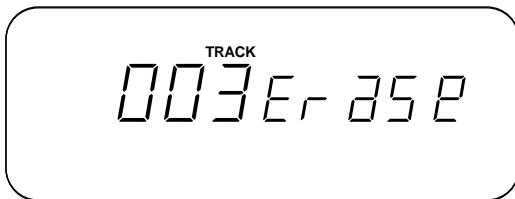

4. When the Erase function is finished, the "done" message is indicated in the display for 3 seconds as follows.

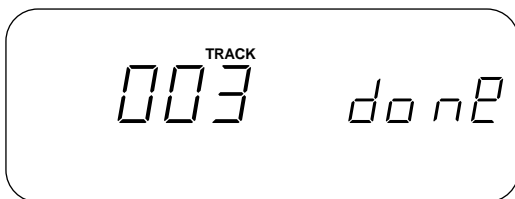

5. The unit will then return to the stop mode.

### Notes

- The STOP button can be used to cancel the Erase function before it is confirmed.
- Use the Format function to erase all the tracks on a card.

## Renumber



1. From the stop mode, press the RENUMBER button. The "re no" message will flash in the display as follows:

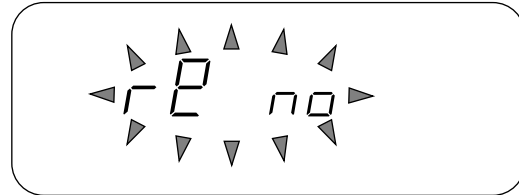

2. Press the RENUMBER button again to confirm the track renumbering. The "re no" message will stay steadily on in the display as follows to indicate that the Renumber function is executing.

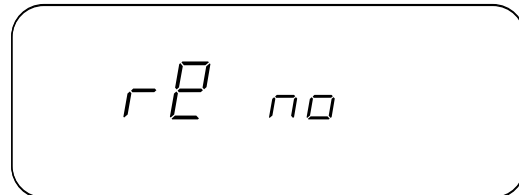

3. When the Renumber function is finished, the "re done" message is indicated in the display for 3 seconds as follows.

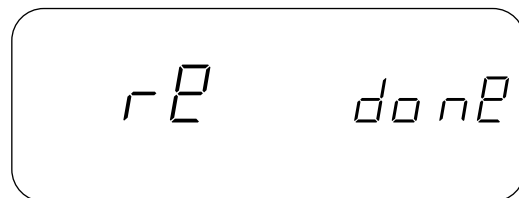

4. The unit will then return to the stop mode.

### Note

- The STOP button can be used to cancel the Renumber function before it is confirmed.



# EDL Marking

The EDL marking and playback system of the PMD690 allows either a custom playback sequence to be programmed or the audio between two specific points in the card to be repeatedly played back.

For the custom playback sequence, the process is completely linear, which means that the order of the programmed sequence must correspond to the order of the audio tracks on the card. So basically the EDL system allows portions of the audio data stored on the card to be skipped.

EDL marks are placed on the card in various ways.

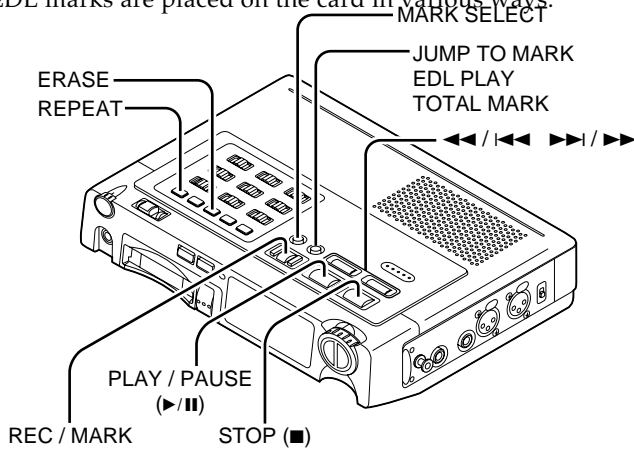

- During recording, marks are placed:
- At the beginning of each new track
  - When the REC/MARK button is pressed
  - When the AUTO MARK function is active and the PMD690 is placed in the record-pause mode manually or via the SILENT SKIP function

- During playback or play-pause, marks are placed:
- When the REC/MARK button is pressed

Each mark has the possibility to be defined as one of four types:

**Play Mark ("P")** – The basic indication for an EDL mark and, during EDL playback, a marker to indicate that the audio after the mark is to be played until the next EDL mark.

**Skip Mark ("S")** – During EDL playback, a marker to indicate that the audio after the mark is to be skipped until the next EDL mark.

**A Point Mark ("a")** – The start point for a repeating loop.

**B Point Mark ("b")** – The end point for a repeating loop.

All new EDL marks are initially placed as Play marks. After recording or playback is complete, the definition of all the EDL marks on the card can be changed. Refer to page 23 in this section for more information on how to change a mark type.

Every time an EDL mark is placed on a card, the total quantity of the EDL marks on the card is displayed for one second in the track number display area (see example below). This is meant to provide a reference of what number EDL mark is at that specific location and an indication of the remaining EDL marks on the card. The maximum number of EDL marks per card is 255.

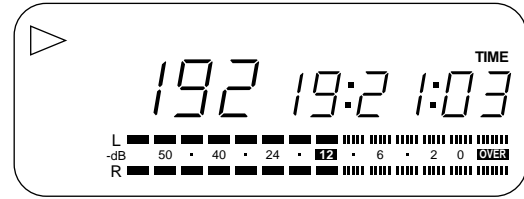

When a mark is placed, the total quantity of mark is displayed (total mark quantity = 192)

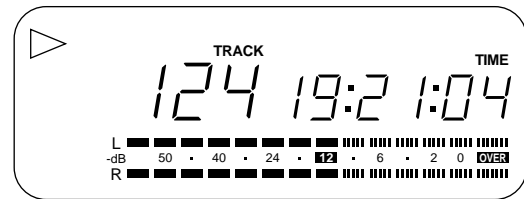

After one second, the display returns to the track number display (track number = 124)

When the maximum number of EDL marks has been placed, the following message will appear in the display.

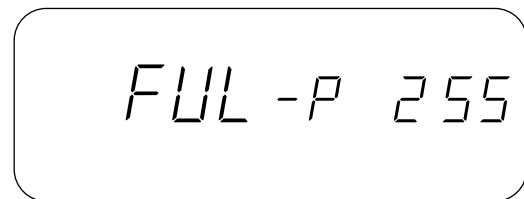

In order to place EDL marks after the above message is displayed, either individual or all the EDL marks on the card need to be erased. Refer to page 23 in this section for more information on performing the EDL mark erase functions.

**Notes**

- The EDL marks are stored as a separate EDL file on the card that is only readable by the PMD690. Do not attempt to edit or delete this file on a PC.
- If all available EDL marks have been placed, the Auto Mark function will automatically be turned off and will not be available again until there are available EDL marks on the card.
- There can be only one A and one B point on each card. If an A or B point exists on a card and a new A or B point is marked, the new A or B point replaces the old A or B point and the old A or B point becomes a P point.

## Auto Mark

The Auto Mark function automatically places an EDL mark on the card when the PMD690 enters the record-pause mode from the record mode. The record-pause mode is entered either manually via the PLAY/PAUSE button or in an automated way via the Silent Skip system.

The Auto Mark function can be turned on and off at any time. When Auto Mark is on, the "A.MARK" icon in the display will light as follows.

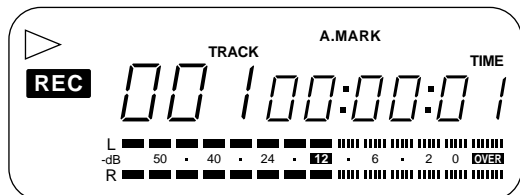

Please refer to the Record Settings section on page 15 for more information on the Auto Mark function.

## Searching for EDL Marks

The EDL marks on the card can be searched for in either the forward or reverse direction during STOP, PLAY, and PLAY PAUSE.

### Forward EDL Mark Search

EDL marks can be searched for in the forward direction by holding down the JUMP TO MARK button and pressing the ►►/►► button. Every time the ►►/►► button is pressed, the PMD690 will search for the next mark on the card. If forward search is performed while at the last EDL mark on the card, the PMD690 will start searching from the beginning of the card (EDL mark 1).

### Reverse EDL Mark Search

EDL marks can be searched for in the reverse direction by holding down the JUMP TO MARK button and pressing the ◀◀/◀◀ button. Every time the ◀◀/◀◀ button is pressed, the PMD690 will search for the previous mark on the card. If previous search is performed while at the first EDL mark on the card, the PMD690 will start searching from the end of the card (last EDL mark).

## Display of Located EDL Marks

When an EDL mark is located, the number of that particular EDL mark is displayed for one second in the track mark display area. Then the track number where the mark is located is displayed as the example below indicates.

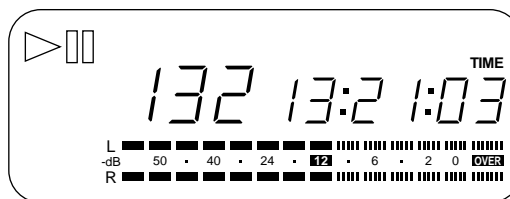

When a mark is located, the mark number accessed is displayed (mark number = 132)

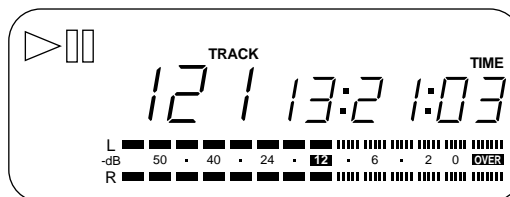

After one second, the track number of where the mark was placed is displayed (track number = 121)

## Displaying the Total Number Of EDL Marks

While in the stop mode, the total number of EDL marks on the card can be displayed by holding down the TOTAL MARK button and then pressing the REC/MARK button. The total number of EDL marks on the card will then be displayed for 3 seconds as indicated below.

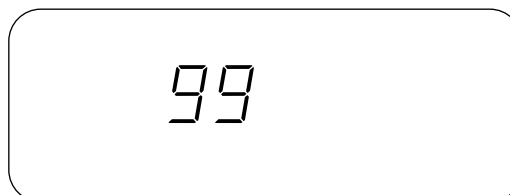

## Editing EDL Marks

After all the EDL marks are placed in the audio tracks of a card, they can be edited by changing the mark types, erasing specific marks, or erasing all the marks.

### Changing a Mark Type

Locate the EDL mark to be changed by using the mark search functions. When the desired EDL mark is located, press the MARK SELECT button to display the current mark type. Each subsequent press of the MARK SELECT button will then change the mark type in the following order.

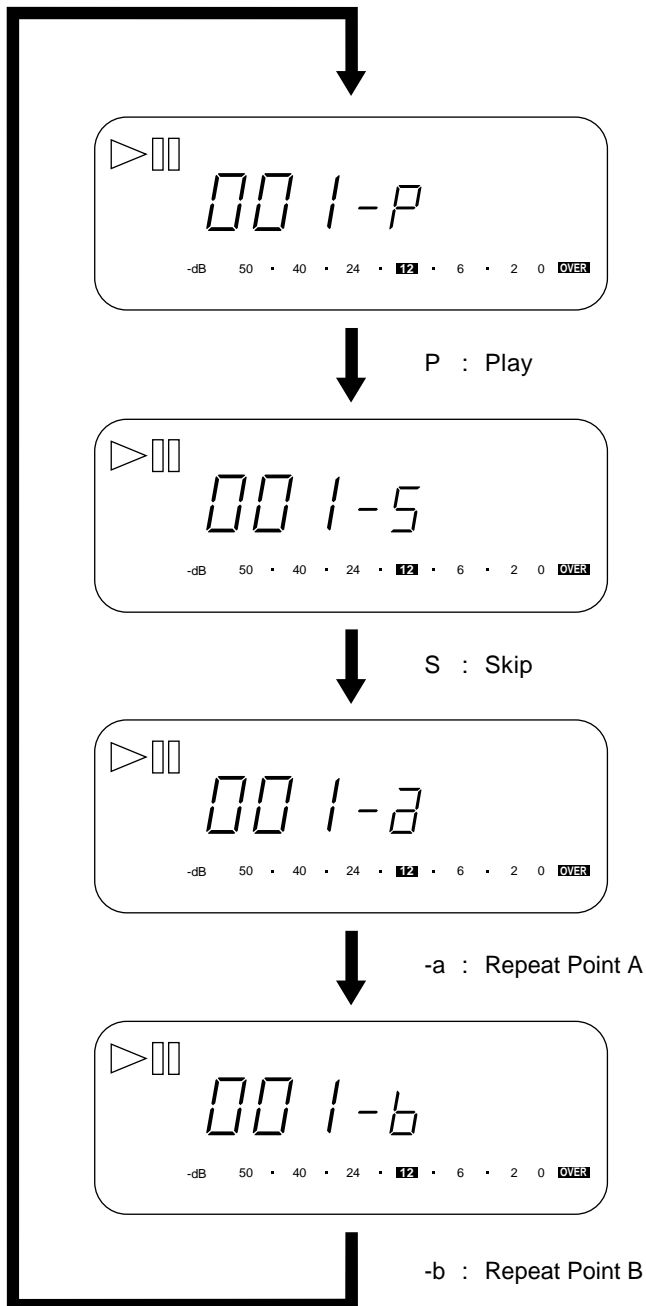

When the desired mark type is displayed, press the PLAY/PAUSE button to save the mark type. If you decide not to change the mark, press the STOP button to cancel the mark changing operation.

### Notes

- The mark type can also be automatically saved by searching for the next or previous mark on the card.
- There can be only one A and one B point on each card. If an A or B point exists on a card and a new A or B point is marked, the new A or B point replaces the old A or B point and the old A or B point becomes a P point.

### Erasing an EDL Mark



Locate the EDL mark to be erased by using the mark search functions. When the desired EDL mark is located, press the ERASE button so that the display flashes the mark type of the selected mark followed by the "Erase" message. Press the ERASE button again to confirm the Erase function (or press the STOP button to cancel). When the erase operation is complete, the "done" message will be displayed and then the unit will return to the point where the mark was in the pause mode.

The complete procedure is displayed as follows.

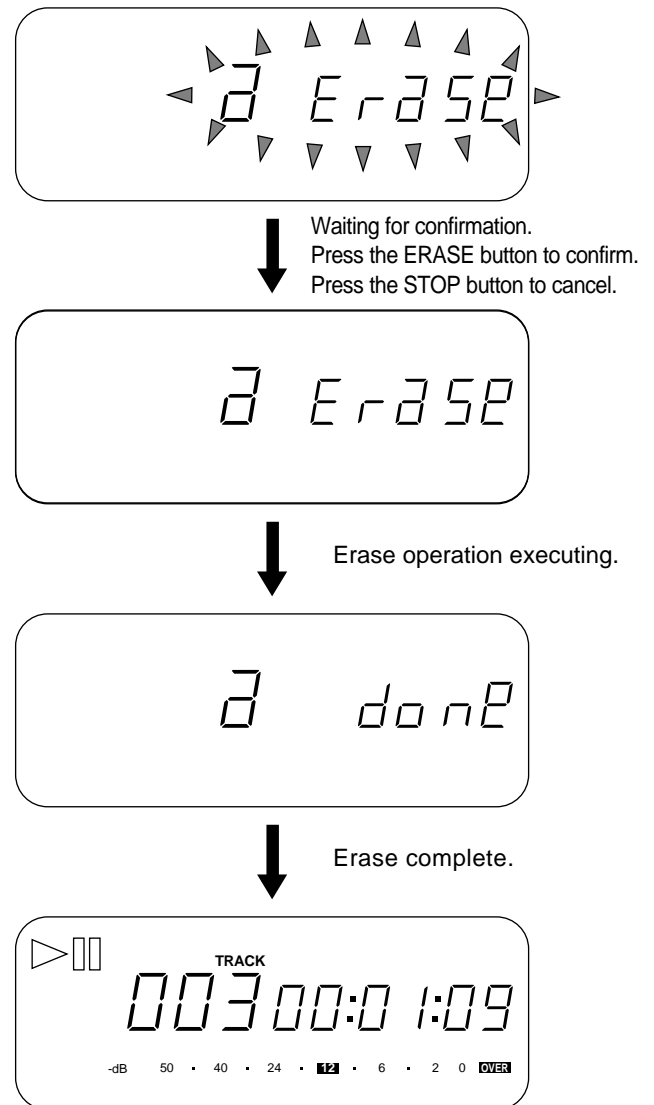

The PMD690 returns to the location of the erased mark.

### Note

- Erasing an EDL mark will automatically renumber all the EDL marks on the card. The result is similar to the track renumber function that is described on page 19 in the Track Editing section.

## Erasing all the EDL Marks

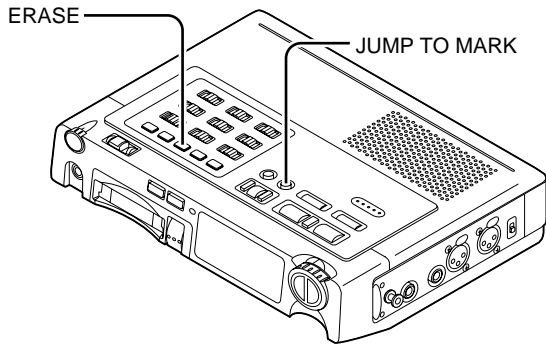

From the STOP mode, hold the JUMP TO MARK button and press the ERASE button so that the display flashes the "EdL Erase" message. Continue to hold the JUMP TO MARK button and press the ERASE button again to confirm the EDL Erase function (or press the STOP button to cancel). When the erase operation is complete, the "done" message will be displayed.

The complete procedure is displayed as follows.

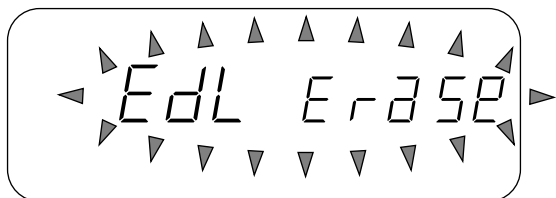

Waiting for confirmation. Press the ERASE button while holding down the JUMP TO MARK button to confirm. Press the STOP button to cancel.

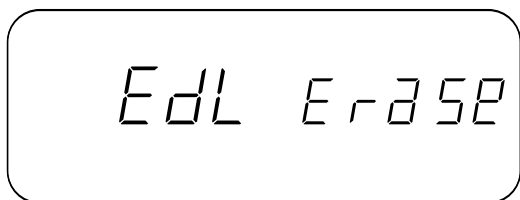

EDL Erase operation executing.

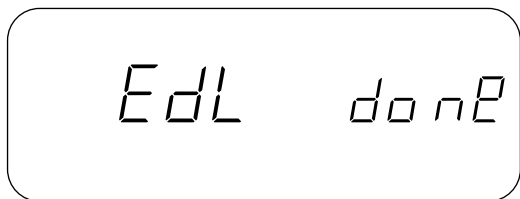

EDL Erase complete.

## EDL Playback

The EDL playback mode will start playing back from the current position but will observe the direction of the programmed EDL marks.

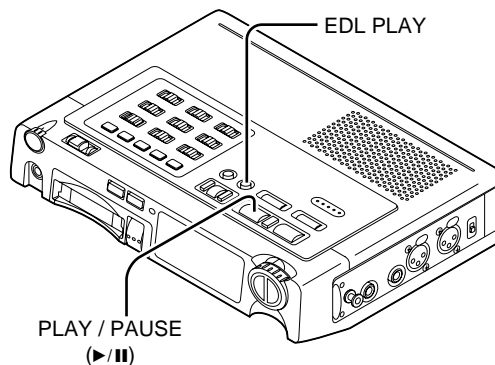

To start EDL playback, hold the EDL PLAY button and press the PLAY/PAUSE button. EDL playback will then start playing the audio on the card starting from the first track (unless it is skipped). An example of a programmed EDL playback is as follows.

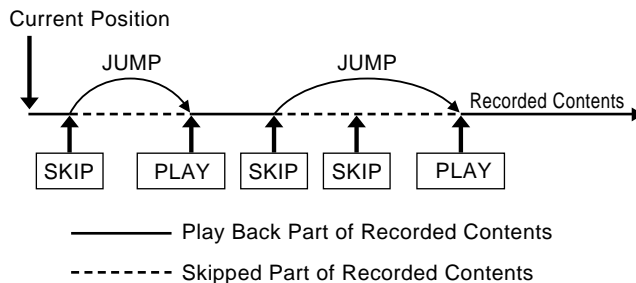

EDL playback can be paused at any time by pressing the PLAY/PAUSE button. Playback is resumed by again pressing the PLAY/PAUSE button.

To exit from EDL playback, hold the EDL playback and press the PLAY/PAUSE button during EDL playback or EDL play pause. The PMD690 will return to the normal playback mode, and starts playback from current position.

EDL playback can be stopped at any time by pressing the STOP button. The PMD690 will return to the normal stop mode after EDL playback is stopped.

### Notes

- If a Skip ("S") mark is the last mark on a card, then the audio after the mark until the end of the card is skipped.
- Searching and track selection via the ◀◀/▶▶ and ▶▶/◀◀ buttons is not available during EDL playback.
- If EDL playback is started but there are no EDL marks on the card, the following message will be displayed:

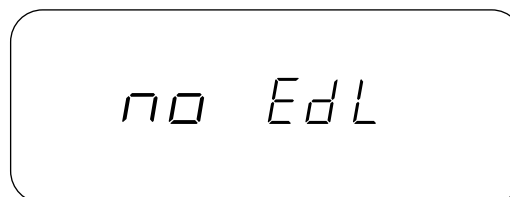

### EDL Repeat Playback

EDL repeat playback works the same way as normal EDL playback except that playback will start at the programmed A ("a") mark and continue until the programmed B ("b") mark; and then return to A mark to repeat the loop.



To start EDL repeat playback, hold the EDL PLAY button and press the PLAY/PAUSE button. Once playback starts, press the RPT/SGL button. EDL repeat playback will then start playing the audio on the card starting from the A ("a") mark and continuing until the B ("b") mark. An example of EDL repeat playback is as follows.

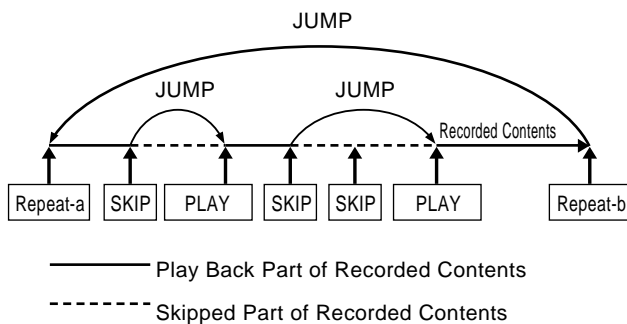

EDL repeat playback can be paused at any time by pressing the PLAY/PAUSE button. Playback is resumed by again pressing the PLAY/PAUSE button.

EDL repeat playback can be stopped at any time by pressing the STOP button. The PMD690 will return to the normal stop mode after EDL repeat playback is stopped.

#### Notes

- If a Skip ("S") mark is the last mark in the loop, then the audio after the mark until the end of the loop is skipped.
- There can be only one A and one B point on each card. If an A or B point exists on a card and a new A or B point is marked, the new A or B point replaces the old A or B point and the old A or B point becomes a P point.
- Searching and track selection via the <<</>>> and <<</>>> buttons is not available during EDL repeat playback.
- If EDL repeat playback is started but there is only one A or B mark on the card, the following message will be displayed:

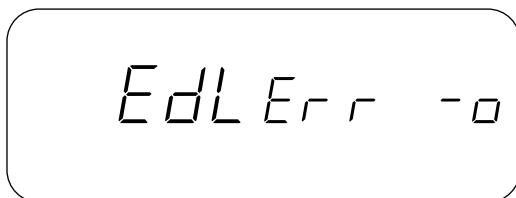

### EDL Playback and EDL Repeat Playback Display

During EDL playback and EDL repeat playback, the Play icon (▶) in the display will flash as follows:

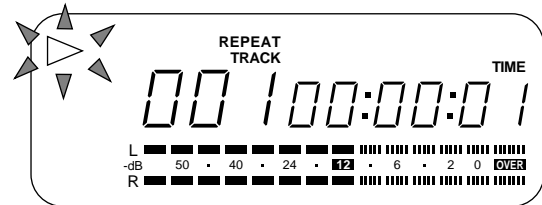

If EDL playback or EDL repeat playback is paused, both the Play (▶) and Pause (||) icons will flash in the display as follows:

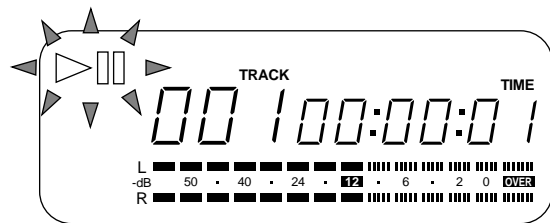

## Error Messages

The error message below will be displayed if the card is ejected during playback, recording, or editing. It will also be displayed upon power-up if power was suddenly lost during the previous recording, playback, or editing operation.

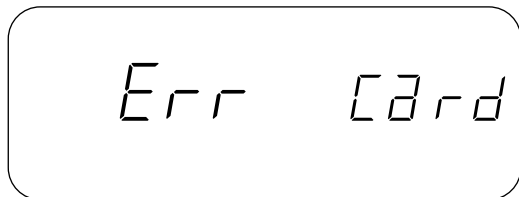

(Error Card)

After the card error message is displayed, the PMD690 will display the following message to indicate that the PMD690 is attempting to recover the data on the card.

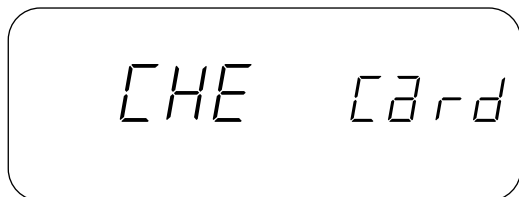

(CHEcking Card)

If the recovery is successful, the following message will be displayed and then the unit will enter the stop mode.

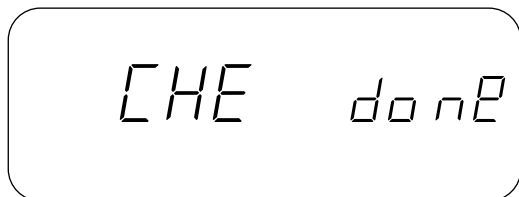

(CHEck done)

If the recovery is unsuccessful, the following message will be displayed to indicate that the data on the card is unrecoverable and that the card needs to be formatted to be used again.

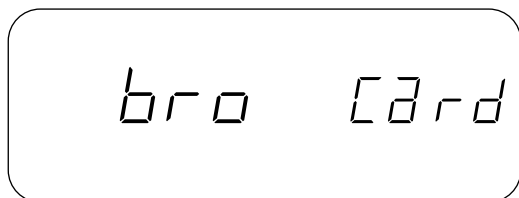

(broken Card)

## File Structure

### File Format

The PMD690 records files onto PC Cards in an MS-DOS™ and Windows™ compatible file format. Each track recorded on the card is stored in its own folder, which carries the same name as the track file. Below is an example of the file structure on a card.

FOLDER	TRACK FILE	PMD690 TRACK NUMBER
\ MZ000001	\ MZ000001.xxx	1
MZ000002	\ MZ000002.xxx	2
MZ000003	\ MZ000003.xxx	3
⋮	⋮	⋮
MZ000nnn	\ MZ000nnn.xxx	nnn

nnn: Last track number  
 xxx: BWF (Broadcast Wave format\*)  
 WAV (Wave format\*)  
 MP2 (MPEG1 layer 2 format\*)

\* File format is selected in the preset menu before recording. Refer to page 9 for more information on the different formats.

### Notes

- Files on a card recorded by the PMD690 that are modified by a PC will no longer be able to be read by the PMD690.
- Each PC Card formatted in the PMD690 will contain, in addition to the audio tracks, an EDL and TOC (mztoc.inf) file that can only be read by the PMD690. Do not attempt to edit or delete these files on a PC.

## Troubleshooting

If your unit fails to operate normally, check the symptoms and solutions described below. If the problem persists and cannot be corrected, please contact the Marantz Professional dealer from whom the product was purchased.

### The unit does not respond to operations.

- Make sure that fresh batteries are installed, or that the AC power adaptor is connected properly.
- Make sure the PC Card is fully inserted.
- Turn power OFF, then ON.

### The unit does not work normally.

- Check all settings.

### Playback is not possible.

- Check to make sure the PMD690 acknowledges track information on the PC Card.

### Audio is not output through the headphones or speaker.

- Check the HP/SPK VOLUME level.
- Check a different track or card to see if the problem is consistent with other tracks or cards.

### Audio is not output through the Digital Out.

- Check that the DIGITAL OUT ON/OFF switch is set to the ON position.
- Note that the Digital output is automatically disabled during recording.

### Recording is not possible.

- Check that less than 255 tracks are recorded on the card (255 tracks are the maximum number of recorded tracks).
- Check to make sure that the PMD690 acknowledges the PC Card.

### No signal is recorded from a microphone input.

- Check that the INPUT switch is set to the middle position (MIC) and that the MIC switch is set to the correct microphone selection.
- Check that the REC LEVEL switch is set to the correct position. In MANUAL and LIMITER modes, the REC LEVEL knob controls the recording level. During ALC, the recording level is controlled automatically by the PMD690.
- Check if the microphones you are using require phantom power (condensor microphones). If they do, make sure the phantom power switch on the right side of the PMD690 is in the ON position.

### Excessive noise.

- Check all connected cables for proper connection.

### File playback on a PC results in poor sound.

- Different PC sound cards and playback programs will result in different sound quality.
- The PMD690 records all the audio files with a sampling frequency of 48kHz. Some PC programs convert the files into 44.1kHz (using a sample rate converter) in order to play or edit the files, which may cause a degradation in the sound quality. Only high quality sample rate converters should be used.

### Files recorded on the PMD690 are not able to be read by a PC.

- Some PCs may not be able to understand MP2 files recorded with the Wave (.wav) file extension. If you happen to have files in this situation, rename the files using a PC so that the file extension is changed to MP2 (.mp2).
- Some playback and editing programs do not support the MP2 or Broadcast Wave (.bwf) formats. If you are having trouble playing or editing MP2 or Broadcast Wave files, consult the Marantz Professional website at [www.marantz.com](http://www.marantz.com) for links to programs that support MP2 and Broadcast Wave.

### The rechargeable battery is not charging.

- Check that the CHARGE switch is set to the ON position.
- Make sure the CHARGE LED is flashing during charging and then stays steadily on when charging is complete.
- Make sure the AC Adaptor is correctly plugged in and the power on the unit is turned off.

### Rechargeable battery life is very low.

- Make sure to fully charge and discharge the battery with each use. NiCad batteries have a memory effect, which means that the life of the battery will become much lower if the battery is only partially discharged (used) and then re-charged.
- If the battery has been heavily used or is old, it may need to be replaced with a new one. Contact your dealer directly to purchase a new battery.

## Care and Maintenance

### To clean the cabinet

Use a soft cloth slightly moistened with mild detergent solution.

## Specifications

### Digital audio system

#### System

Digital audio recorder

#### Usable Media

Approved PCMCIA PC Cards and HDD cards

#### Recording and reading method

MPEG1 Layer II compression

16 bit linear PCM

#### Recording Bit rate (Selectable by preset)

MONO

768 kbps (PCM), 192, 128, 96, 64, 48, 32 kbps (MPEG)

LP (Long Play mode, Stereo)

192, 128, 96, 64 kbps (MPEG, Joint Stereo)

SP (Standard Play mode, Stereo)

1536 kbps (PCM), 384, 256 kbps (MPEG, Joint Stereo)

The amount of memory required per hour of recording:

Bit Rate (kbps)	MB/Hour
32	16 MB
48	25 MB
64	33 MB
96	50 MB
128	67 MB
192	100 MB
256	136 MB
384	200 MB
768 (PC1, PCM Mono)	400 MB
1536 (PC2, PCM Stereo)	800 MB

#### Sampling frequency

48 kHz

#### Number of channels

2/1 (stereo/mono)

#### Frequency Response

22,000 Hz  $\pm$ 0.5 dB (at digital)

#### Signal-to-Noise Ratio (IEC-A weighted)

80 dB

#### Total Harmonic Distortion (at 0 VU)

0.03 %

#### Dynamic Range

85dB

### Inputs

#### MIC/LINE IN L/R

Type: XLR (1:GND, 2:HOT, 3:COLD)

Input Sensitivity (MIC): -68 dBu/9 kilohms

Input Sensitivity (LINE): -20 dBu/47 kilohms

### Outputs

#### LINE OUT L/R

Type: RCA jack

Standard level: 2 Vrms max./2 kilohms

#### DIGITAL OUT

Type: RCA jack

Output impedance: 75 ohms

Standard output level: 0.5 Vp-p

Sampling frequency: 48 kHz

Format: SPDIF (IEC-958 Type II)

### GENERAL

#### Headphone Output power

15 mW/32 ohms

#### Speaker Output Power

200 mW

#### Phantom Power

+48V, 5mA

#### Power Requirement

13 V, 1.0 A

#### Power Consumption

Recording: 5.2 W

Charging: 12 W

Power off: 10 mW

#### Dimensions (W x H x D)

264 x 52 x 185 mm

(10.4" x 2.0" x 7.3")

#### Weight

1.3 kg (2 lbs. 14 oz.)

#### Included Accessories

AC adaptor: 1

Battery holder: 1

Carrying Strap: 1

User Guide: 1

#### Optional Accessories

Ni-Cad Battery pack (RB1100PMD)

Carrying Case (CLC690PMD)

Specifications subject to change without notice.



# Index of Parts, Controls, and Display

## Top Panel

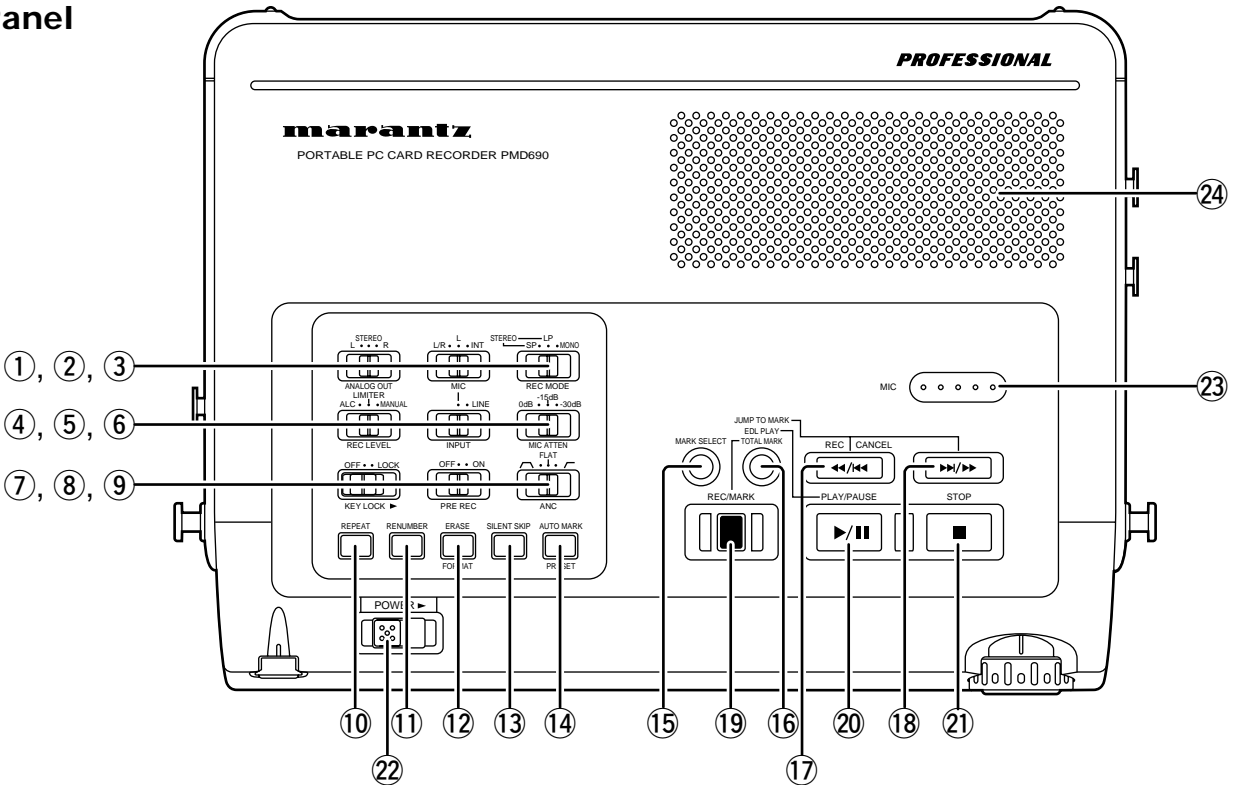

## Front Panel

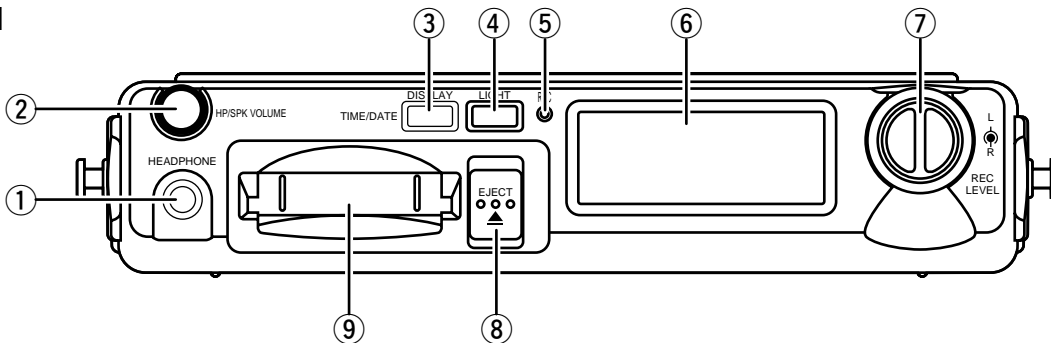

## Top Panel

- ① ANALOG OUT switch (page 17, 18)
- ② MIC switch (page 14)
- ③ REC MODE switch (page 15)
- ④ REC LEVEL switch (page 14)
- ⑤ INPUT switch (page 14)
- ⑥ MIC ATTENUATION switch (page 14)
- ⑦ KEY LOCK switch (page 13)
- ⑧ PRE REC switch (page 15)
- ⑨ Ambient Noise Cancel switch (page 14)
- ⑩ REPEAT button (page 19)
- ⑪ RENUMBER button (page 20)
- ⑫ ERASE, FORMAT button (page 6, 20)
- ⑬ SILENT SKIP button (page 15)
- ⑭ AUTO MARK, PRESET button (page 9, 15)
- ⑮ MARK SELECT button (page 23)
- ⑯ JUMP TO MARK, EDL PLAY, TOTAL MARK button (page 22, 24)
- ⑰ ◀◀ / |◀◀ REC CANCEL button (page 16, 18, 20)
- ⑱ ▶▶ / ▶▶▶ button (page 18, 20)
- ⑲ REC / MARK button (page 16, 21)
- ⑳ PLAY / PAUSE button (page 16, 18, 19)
- ㉑ STOP button (page 16, 18)
- ㉒ POWER key (page 4)
- ㉓ INT microphone (page 14)
- ㉔ SPEAKER (page 18)

## Front Panel

- ① HEADPHONE jack (page 8)
- ② HP / SPK VOLUME knob (page 18)
- ③ DISPLAY, TIME / DATE key (page 4, 12)
- ④ LIGHT key (page 13)
- ⑤ REC LED (page 14, 16)
- ⑥ Display (page 12, 13)
- ⑦ REC LEVEL knob (page 14)
- ⑧ EJECT button (page 5)
- ⑨ PC Card slot (page 5)

## Left Panel

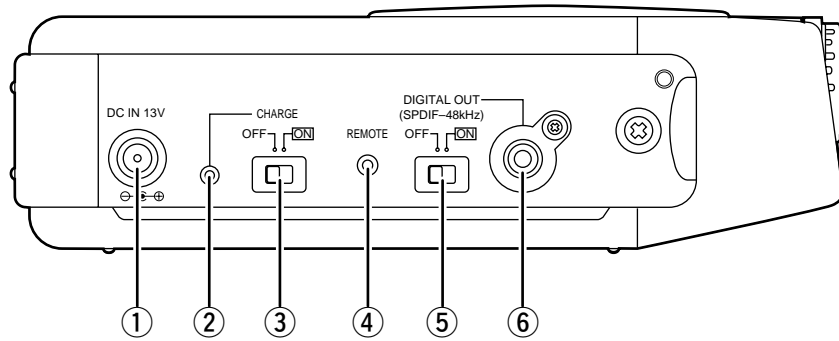

- ① DC IN 13V (page 3)
- ② CHARGE LED (page 3)
- ③ CHARGE switch (page 3)
- ④ REMOTE IN jack (page 8)
- ⑤ DIGITAL OUT switch (page 8)
- ⑥ DIGITAL OUT jack (page 8)

## Right Panel

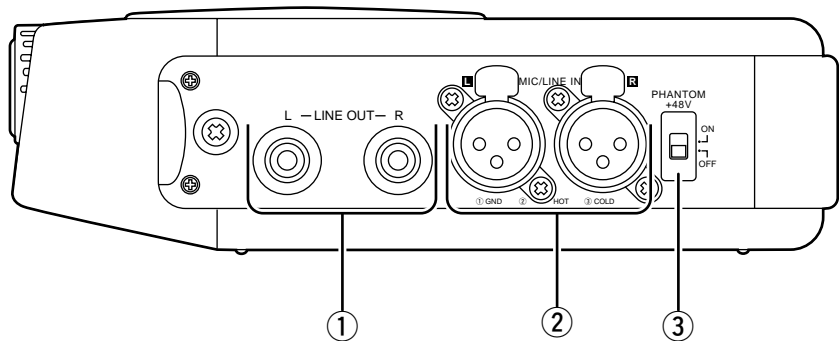

- ① LINE OUT jacks (page 7)
- ② MIC/LINE IN jacks (page 7)
- ③ PHANTOM +48V switch (page 7)

# Display

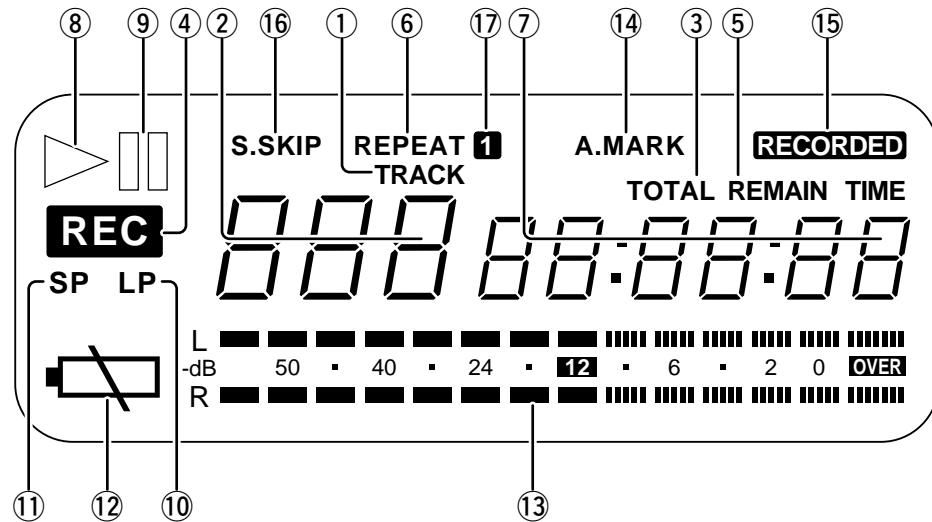

No	Item	Type	Explanation.
①	TRACK		Turns on while track number is displayed.
②	Track Number	7 Seg x 3 digits	Displays track number, mark number, mark quantity (001~255), error messages, mode messages.
③	TOTAL		Turns on while Total Time is displayed.
④	<b>REC</b>		Blinks while in Record-Pause, Steadily on while Recording.
⑤	REMAIN		Turns on while Remain Time is displayed.
⑥	REPEAT		Turns on while in the REPEAT, REPEAT 1, and EDL repeat playback modes.
⑦	Time	7Seg x 6 digits	Diplays time, date and messages.
⑧	PLAY		Blinks during the EDL playback, and record-pause modes. Steadily on while playing back and recording.
⑨	PAUSE		Turns on while in play-pause and record-pause modes.
⑩	LP		Turns on while in the Long Play mode recording mode.
⑪	SP		Turns on while in the Short Play mode recording mode.
⑫	Battery Indicator		Turns on when Battery is half consumed, blinks when battery is near end.
⑬	Level Meter	14dots	0dB=2V output.
⑭	A.MARK		Turns on while the Auto Mark function is active.
⑮	<b>RECORDED</b>		Turns on while recorded time or date is displayed.
⑯	S.SKIP		Turns on while the Silent Skip recording mode is active.
⑰	<b>1</b>		Turns on while in the REPEAT 1 playback mode or Single Track Play mode.

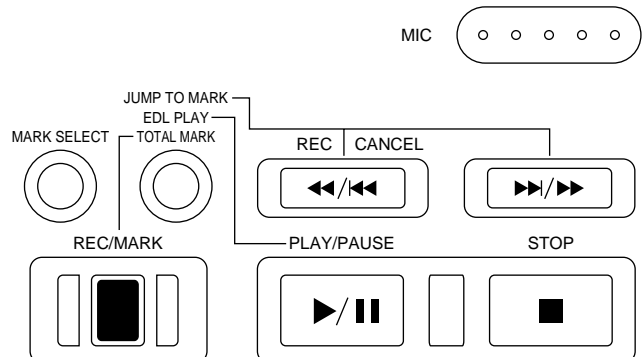
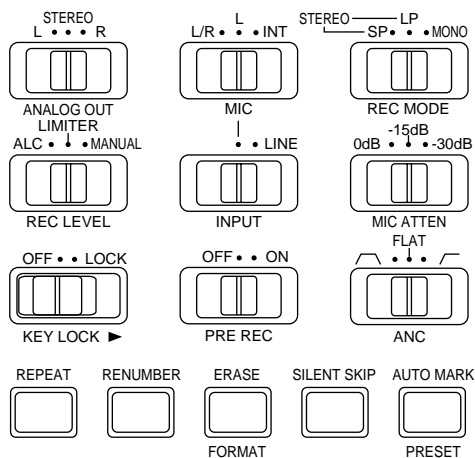

ENGLISH

FRANÇAIS

PORTUGUÊS

ESPAÑOL

**marantz**<sup>®</sup> is a registered trademark.



Printed in Japan

01 / 03 MITs 470S851250

## Free Manuals Download Website

<http://myh66.com>

<http://usermanuals.us>

<http://www.somanuals.com>

<http://www.4manuals.cc>

<http://www.manual-lib.com>

<http://www.404manual.com>

<http://www.luxmanual.com>

<http://aubethermostatmanual.com>

Golf course search by state

<http://golfingnear.com>

Email search by domain

<http://emailbydomain.com>

Auto manuals search

<http://auto.somanuals.com>

TV manuals search

<http://tv.somanuals.com>