

# marantz®

## Model VC5400 User Guide

---

5 Disc DVD Changer



## Safety Precautions



**CAUTION**  
RISK OF ELECTRIC SHOCK  
DO NOT OPEN



**CAUTION:** TO REDUCE THE RISK OF ELECTRIC SHOCK DO NOT REMOVE COVER (OR BACK) NO USER-SERVICEABLE PARTS INSIDE REFER SERVICING TO QUALIFIED SERVICE PERSONNEL.



This lightning flash with arrowhead symbol within an equilateral triangle is intended to alert the user to the presence of uninsulated dangerous voltage within the product's enclosure that may be of sufficient magnitude to constitute a risk of electric shock to persons.



The exclamation point within an equilateral triangle is intended to alert the user to the presence of important operating and maintenance (servicing) instructions in the literature accompanying the product.

**WARNING:** TO REDUCE THE RISK OF FIRE OR ELECTRIC SHOCK, DO NOT EXPOSE THIS PRODUCT TO RAIN OR MOISTURE.

**WARNING:** Do not install this equipment in a confined space such as a book case or similar unit.

CLASS 1 LASER PRODUCT  
KLASSE 1 LASER PRODUKT  
LUOKAN 1 LASER LAITE  
KLASS 1 LASER APPARAT  
CLASSE 1 PRODUIT LASER

### CAUTION:

This Digital Video Disc Player employs a Laser System.

To ensure proper use of this product, please read this owner's manual carefully and retain for future reference should the unit require maintenance, contact an authorized service location (see service procedure).

Use of controls, adjustments, or the performance of procedures other than those specified herein may result in hazardous radiation exposure.

To prevent direct exposure to laser beam, do not try to open the enclosure. Visible laser radiation when open. **DO NOT STARE INTO BEAM.**

**CAUTION:** The apparatus should not be exposed to water (dripping or splashing) and no objects filled with liquids, such as vases, should be placed on the apparatus.

**FCC WARNING:** This equipment may generate or use radio frequency energy. Changes or modifications to this equipment may cause harmful interference unless the modifications are expressly approved in the instruction manual. The user could lose the authority to operate this equipment if an unauthorized change or modification is made.

### REGULATORY INFORMATION: FCC Part 15

This product has been tested and found to comply with the limits for a Class B digital device, pursuant to Part 15 of the FCC Rules. These limits are designed to provide reasonable protection against harmful interference when the product is operated in a residential installation. This product generates, uses, and can radiate radio frequency energy and, if not installed and used in accordance with the instruction manual, may cause harmful interference to radio communications. However, there is no guarantee that interference will not occur in a particular installation. If this product does cause harmful interference to radio or television reception, which can be determined by turning the product off and on, the user is encouraged to try to correct the interference by one or more of the following measures:

- Reorient or relocate the receiving antenna.
- Increase the separation between the product and receiver.
- Connect the product into an outlet on a circuit different from that to which the receiver is connected.
- Consult the dealer or an experienced radio/TV technician for help.



### NOTES ON COPYRIGHTS:

It is forbidden by law to copy, broadcast, show, broadcast via cable, play in public, or rent copyrighted material without permission.

This product features the copy protection function developed by Macrovision. Copy protection signals are recorded on some discs. When recording and playing the pictures of these discs on a VCR, picture noise will appear.

This product incorporates copyright protection technology that is protected by method claims of certain U.S. patents and other intellectual property rights owned by Macrovision Corporation and other rights owners. Use of this copyright protection technology must be authorized by Macrovision Corporation, and is intended for home and other limited viewing uses only unless otherwise authorized by Macrovision Corporation. Reverse engineering or disassembly is prohibited.

**SERIAL NUMBER:** The serial number is found on the back of this unit. This number is unique to this unit and not available to others. You should record requested information here and retain this guide as a permanent record of your purchase.

Model No. \_\_\_\_\_

Serial No. \_\_\_\_\_

# IMPORTANT SAFETY INSTRUCTIONS

**CAUTION: PLEASE READ AND OBSERVE ALL WARNINGS AND INSTRUCTIONS IN THIS OWNER'S MANUAL AND THOSE MARKED ON THE PRODUCT. RETAIN THIS BOOKLET FOR FUTURE REFERENCE.**

This product has been designed and manufactured to assure personal safety. Improper use can result in electric shock or fire hazard. The safeguards incorporated in this product will protect you if you observe the following procedures for installation, use, and servicing.

This product does not contain any parts that can be repaired by the user.

**DO NOT REMOVE THE CABINET COVER, OR YOU MAY BE EXPOSED TO DANGEROUS VOLTAGE. REFER SERVICING TO QUALIFIED SERVICE PERSONNEL ONLY.**

- 1. Read these instructions.** - All these safety and operating instructions should be read before the product is operated.
- 2. Keep these instructions.** - The safety, operating and use instructions should be retained for future reference.
- 3. Heed all warnings.** - All warnings on the product and in the operating instructions should be adhered to.
- 4. Follow all instructions.** - All operating and use instructions should be followed.
- 5. Do not use this product near water.** - For example: near a bath tub, wash bowl, kitchen sink, laundry tub, in a wet basement; or near a swimming pool; and other areas located near water.
- 6. Clean only with dry cloth.** - Unplug this product from the wall outlet before cleaning. Do not use liquid cleaners.
- 7. Do not block any ventilation openings. Install in accordance with the manufacturer's instructions.** - Slots and openings in the cabinet are provided for ventilation and to ensure reliable operation of the product and to protect it from over-heating. The openings should never be blocked by placing the product on a bed, sofa, rug or other similar surface. This product should not be placed in a built-in installation such as a bookcase or rack unless proper ventilation is provided or the manufacturer's instructions have been adhered to.
- 8. Do not install near any heat sources such as radiators, heat registers, stoves, or other apparatus (including amplifiers) that produce heat.**
- 9. Do not defeat the safety purpose of the polarized or grounding-type plug.** A polarized plug has two blades with one wider than the other. A grounding type plug has two blades and a third grounding prong. The wide blade or the third prong are provided for your safety. If the provided plug does not fit into your outlet, consult an electrician for replacement of the obsolete outlet.
- 10. Protect the power cord from being walked on or pinched particularly at plugs, convenience receptacles, and the point where they exit from the product.**
- 11. Only use attachments/accessories specified by the manufacturer.**
- 12. Use only with the cart, stand, tripod, bracket, or table specified by the manufacturer, or sold with apparatus. When a cart is used, use caution when moving the cart/product combination to avoid injury from tip-over.**
- 13. Unplug this product during lightning storms or when unused for long periods of time.**
- 14. Refer all servicing to qualified service personnel. Servicing is required when the product has been damaged in any way, such as power-supply cord or plug is damaged, liquid has been spilled or objects have fallen into the product, the product has been exposed to rain or moisture, does not operate normally, or has been dropped.**



## Table of Contents

### Introduction

Safety Precautions .....	2
<b>IMPORTANT SAFETY INSTRUCTIONS</b> .....	<b>3</b>
<b>Table of Contents</b> .....	<b>4</b>
<b>Before Use</b> .....	<b>5-6</b>
Playable Discs .....	5
Precautions .....	6
Notes on Discs .....	6
About Symbols .....	6
<b>Front Panel and Display Window</b> .....	<b>7</b>
<b>Remote Control</b> .....	<b>8</b>
<b>Rear Panel</b> .....	<b>9</b>

### Preparation

<b>Connections</b> .....	<b>10-12</b>
Connecting to a TV .....	10
Connecting to Optional Equipment .....	11-12
<b>Before Operation</b> .....	<b>13-17</b>
General Explanation .....	13
On-Screen Display .....	13-14
Initial Settings .....	15-17
• <i>Initial Settings General Operation</i> .....	15
• <i>Language</i> .....	15
• <i>Picture</i> .....	15
• <i>Sound</i> .....	16
• <i>Others</i> .....	16
• <i>Parental Control</i> .....	17

### Operation

<b>Operation with DVD and Video CD</b> .....	<b>18-22</b>
Playing a DVD and Video CD .....	18
• Exchanging discs during playback .....	18
• Skipping discs .....	18
• Exchanging the disc and starting playback .....	18
General Features .....	19
• <i>Moving to another TITLE/GROUP</i> .....	19
• <i>Moving to another CHAPTER/TRACK</i> .....	19
• <i>Search</i> .....	19
• <i>Pause</i> .....	19
• <i>Still Picture and Frame-by-Frame Playback</i> .....	19
• <i>Slow Motion</i> .....	19
• <i>Random</i> .....	19
• <i>Repeat A-B</i> .....	20
• <i>Repeat</i> .....	20
• <i>Time Search</i> .....	20
• <i>3D Surround</i> .....	20
• <i>Zoom</i> .....	20
• <i>Marker Search</i> .....	21
Special DVD Features .....	21
• <i>Title Menu</i> .....	21
• <i>Disc Menu</i> .....	21
• <i>Camera Angle</i> .....	21
• <i>Changing the Audio Language</i> .....	21
• <i>Changing the Audio Channel</i> .....	21
• <i>Subtitles</i> .....	21
DVD Audio Discs .....	22
• <i>Moving to another GROUP</i> .....	22
• <i>Viewing another PAGE</i> .....	22

### Operation with Audio CD and MP3/WMA Disc . 23- 24

Playing an Audio CD and MP3/WMA Disc .....	23
Notes on MP3/WMA Recordings .....	23
• <i>Pause</i> .....	24
• <i>Moving to another Track</i> .....	24
• <i>Search</i> .....	24
• <i>Random with MP3/WMA Disc</i> .....	24
• <i>Repeat Track/ All/ Off</i> .....	24
• <i>Random with Audio CD</i> .....	24
• <i>Repeat A-B</i> .....	24
• <i>3D Surround</i> .....	24
• <i>Changing the Audio Channel</i> .....	24
• <i>Repeat Track/Disc/All/Off</i> .....	24

### Operation with JPEG Disc .....

Viewing a JPEG disc .....	25
• <i>Moving to another File</i> .....	25
• <i>Still Picture</i> .....	25
• <i>To flip the picture</i> .....	25
• <i>To rotate picture</i> .....	25
• <i>Notes on JPEG Recordings</i> .....	25

### Programmed Playback .....

Programmed Playback with Audio CD .....	26
Programmed Playback with MP3/WMA disc .....	26
Programmed Playback with Video CD .....	26
• <i>Repeat Programmed Tracks</i> .....	27
• <i>Erasing a Track from Program List</i> .....	27
• <i>Erasing the Complete Program List</i> .....	27

### Additional Information .....

Screen Saver .....	28
Video Mode Setting .....	28
HDCD Playback .....	28
Setting Remote control codes of DVD player .....	28

### Reference

<b>Troubleshooting</b> .....	<b>29</b>
<b>Speaker Settings</b> .....	<b>30</b>
<b>Language Code List</b> .....	<b>31</b>
<b>Country Code List</b> .....	<b>32</b>
<b>Specifications</b> .....	<b>33</b>

### About the symbols for instructions



Indicates hazards likely to cause harm to the unit itself or other material damage.



Indicates special operating features of this unit.



Indicates tips and hints for making the task easier.

## Before Use

### Playable Discs

	DVD video discs (8 cm / 12 cm disc)
	DVD audio discs (8 cm / 12 cm disc)
	Video CD (VCD) (8 cm / 12 cm disc)
	Audio CD (8 cm / 12 cm disc)

In addition, this unit can play a HDCD, DVD-R, DVD±RW, Kodak PICTURE CD, SVCD, and CD-R or CD-RW that contains audio titles, MP3, WMA or JPEG files.

### Notes

- Depending on the conditions of the recording equipment or the CD-R/RW (or DVD-R/±RW) disc itself, some CD-R/RW (or DVD-R/±RW) discs cannot be played on the unit.
- Do not attach any seal or label to either side (the labeled side or the recorded side) of a disc.
- Do not use irregularly shaped CDs (e.g., heart-shaped or octagonal). It may result in malfunctions.

### Notes on DVDs and Video CDs

Some playback operations of DVDs and Video CDs may be intentionally fixed by software manufacturers. As this unit plays DVDs and Video CDs according to disc content designed by the software manufacturer, some playback features of the unit may not be available or other functions may be added.

Refer also to the instructions supplied with the DVDs and Video CDs. Some DVDs made for business purposes may not be played on the unit.

### Regional code of the DVD player and DVDs

This DVD player is designed and manufactured for playback of region "1" encoded DVD software. The region code on the labels of some DVD discs indicates which type of player can play those discs. This unit can play only DVD discs labeled "1" or "ALL". If you try to play any other discs, the message "Check Regional Code" will appear on the TV screen. Some DVD discs may not have a region code label even though their playback is prohibited by area limits.



### Disc-related terms

#### Title (DVD video discs only)

The main film content or accompanying feature content or additional feature content, or music album.

Each title is assigned a title reference number enabling you to locate it easily.

#### Chapter (DVD video discs only)

Sections of a picture or a musical piece that are smaller than titles. A title is composed of one or several chapters. Each chapter is assigned a chapter number, enabling you to locate the chapter you want. Depending on the disc, chapters may not be recorded.

#### Group (DVD audio discs only)

The main audio content or accompanying feature content or additional feature content, or music album. Each group is assigned a group reference number enabling you to locate it easily.

#### Track (DVD audio discs, Video CD and audio CD only)

Sections of a picture or a musical piece on a video CD or an audio CD. Each track is assigned a track number, enabling you to locate the track you want.

#### Scene

On a video CD with PBC (Playback control) functions, moving pictures and still pictures are divided into sections called "Scenes". Each scene is displayed in the menu screen and assigned a scene number, enabling you to locate the scene you want.

A scene is composed of one or several tracks.

### Types of video CDs

There are two types of video CDs:

#### Video CDs equipped with PBC (Version 2.0)

PBC (Playback control) functions allow you to interact with the system via menus, search functions, or other typical computer-like operations. Moreover, still pictures of high resolution can be played if they are included in the disc.

#### Video CDs not equipped with PBC (Version 1.1)

Operated in the same way as audio CDs, these discs allow playback of video pictures as well as sound, but they are not equipped with PBC.

### HDCD (High Definition Compatible Digital®)

HDCD® (High Definition Compatible Digital®) is a recording system that has improved audio CD sound in dynamic range, sound field reproducibility and vocal acoustics.

This DVD player is equipped with an HDCD decoder. The HDCD indicator illuminates when playing an HDCD-encoded audio CD.

 , HDCD®, High Definition Compatible Digital® and Pacific Microsonics™ are either registered trademarks or trademarks of Pacific Microsonics, Inc. in the United States and/or other countries. HDCD system manufactured under license from Pacific Microsonics, Inc. This product is covered by one or more of the following patents: United States: 5,479,168, 5,638,074, 5,640,161, 5,808,574, 5,838,274, 5,854,600, 5,872,531 and 5,864,311. Australia: 669114. Other patents pending.

## Before Use (Continued)

### Precautions

#### Handling the unit

##### When shipping the unit

The original shipping carton and packing materials come in handy. For maximum protection, re-pack the unit as it was originally packed at the factory.

##### When setting up the unit

The picture and sound of a nearby TV, VCR, or radio may be distorted during playback. In this case, position the unit away from the TV, VCR, or radio, or turn off the unit after removing the disc.

##### To keep the exterior surfaces clean

Do not use volatile liquids, such as insecticide spray, near the unit. Do not leave rubber or plastic products in contact with the unit for a long period of time. They will leave marks on the surface.

#### Cleaning the unit

##### To clean the cabinet

Use a soft, dry cloth. If the surfaces are extremely dirty, use a soft cloth lightly moistened with a mild detergent solution. Do not use strong solvents such as alcohol, benzene, or thinner, as these might damage the surface of the unit.

##### To obtain a clear picture

The DVD player is a high-tech, precision device. If the optical pick-up lens and disc drive parts are dirty or worn, the picture quality will be poor. Regular inspection and maintenance are recommended after every 1,000 hours of use. (This depends on the operating environment.) For details, please contact your nearest dealer.

#### Remote Control Operation Range

Point the remote control at the remote sensor and press the buttons.

- **Distance:** About 16 ft (5 m) from the front of the remote sensor.
- **Angle:** About 30° in each direction of the front of the remote sensor.

#### Remote control battery installation

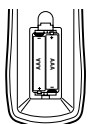

Detach the battery cover on the rear of the remote control, and insert two R03 (size AAA) batteries with + and - aligned correctly.



**Caution**  
Do not mix old and new batteries. Never mix different types of batteries (standard, alkaline, etc.).

### Notes on Discs

#### Handling discs

Do not touch the playback side of the disc. Hold the disc by the edges so that fingerprints will not get on the surface. Do not stick paper or tape on the disc.

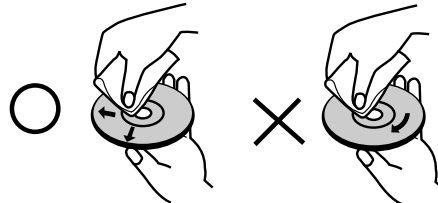

#### Storing discs

After playing, store the disc in its case. Do not expose the disc to direct sunlight or sources of heat, or leave it in a parked car exposed to direct sunlight, as there may be a considerable temperature increase inside the car.

#### Cleaning discs

Fingerprints and dust on the disc can cause poor picture quality and sound distortion. Before playing, clean the disc with a clean cloth. Wipe the disc from the center out.



Do not use strong solvents such as alcohol, benzene, thinner, commercially available cleaners, or anti-static spray intended for older vinyl records.









### About Symbols

#### About the symbol display

“” may appear on the TV screen during operation. This icon means the function explained in this owner's manual is not available on that specific DVD video disc.

#### About the disc symbols for instructions

A section whose title has one of the following symbol is applicable only to the disc represented by the symbol.

-  DVD Video discs
-  DVD Audio discs
-  Video CDs with the PBC (playback control) function.
-  Video CDs without the PBC (playback control) function.
-  Audio CDs.
-  MP3 discs.
-  WMA discs.
-  JPEG discs.

# Front Panel and Display Window

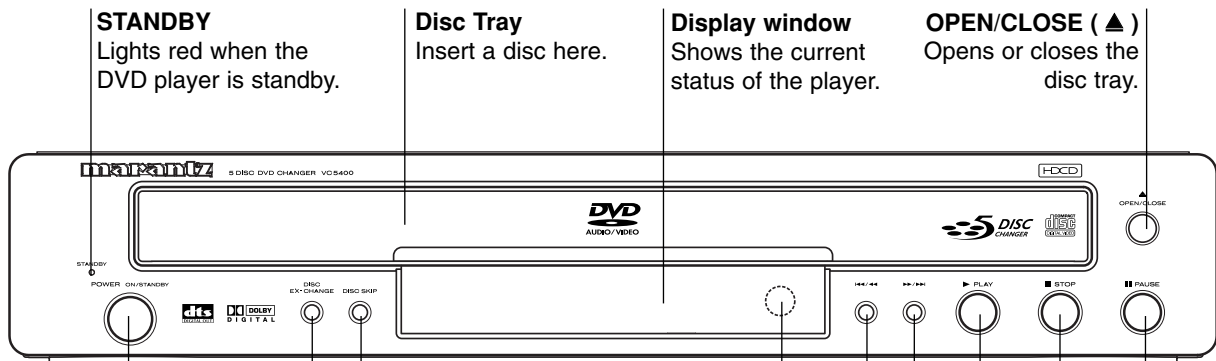

**ANGLE** Lights when multi angles are present.

A light will appear if a disc is in the disc tray. The current disc tray flashes.

- DVD** DVD video disc inserted
- DVDA** DVD audio disc inserted
- CD** Audio CD inserted
- VCD** Video CD inserted
- HD CD** HDCD disc inserted
- MP3** MP3 or WMA disc inserted

Indicates current player function: Playback, Pause, etc.

**TITLE** Indicates current title number

**CHP/TRK** Indicates current chapter or track number

Indicates total playing time/elapsed time

**PROG.** Programmed playback active

**RANDOM** RANDOM playback active

Indicates repeat mode

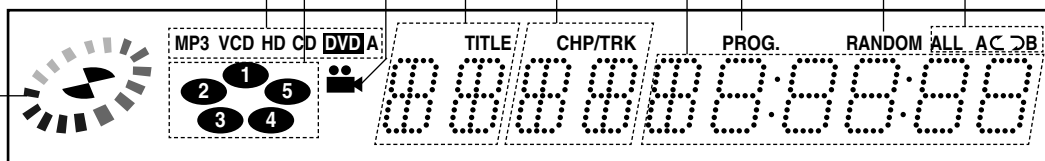

## Remote Control

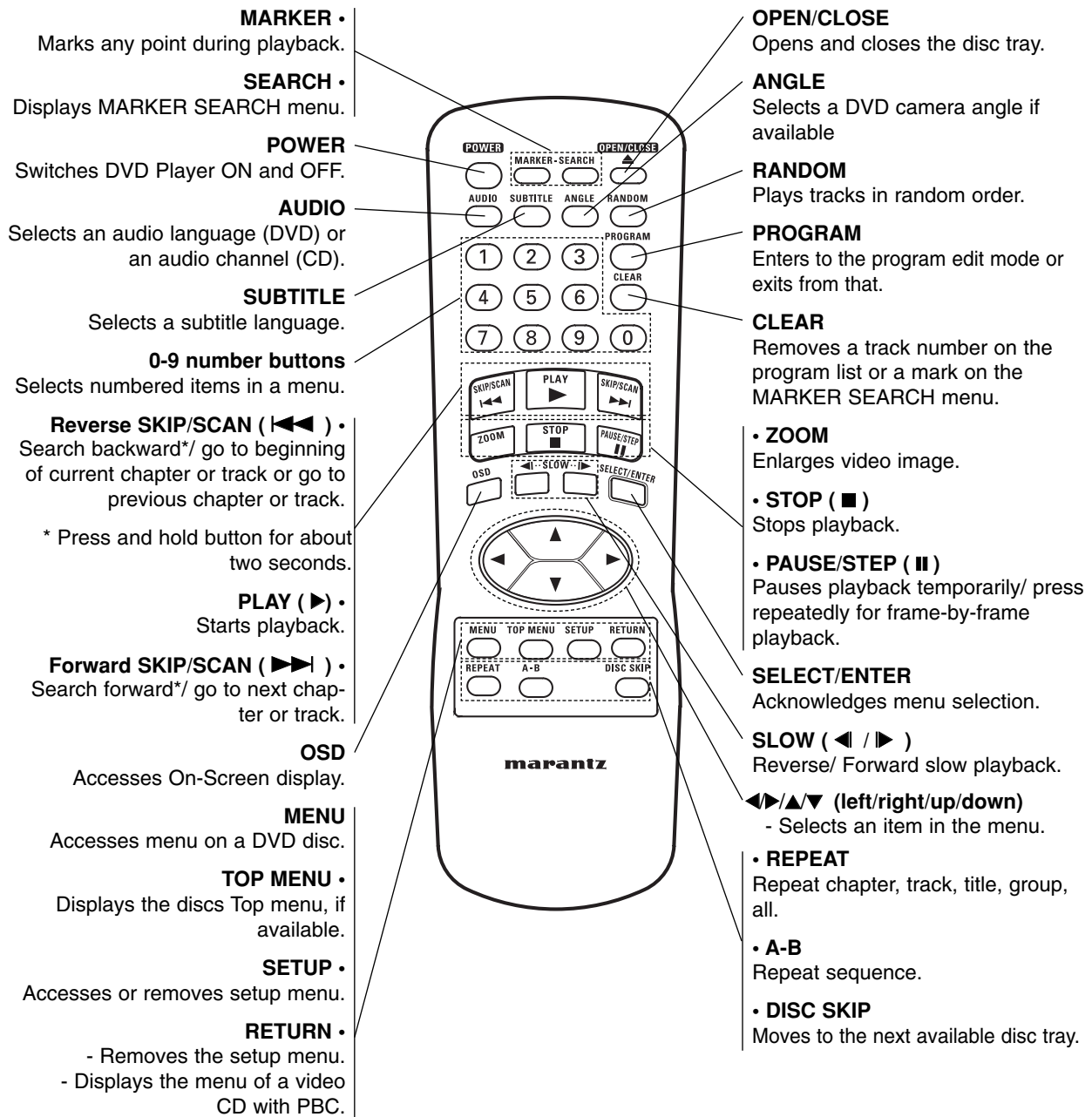

### Setting Remote control codes of Remote control

- This remote control supports two remote control codes: C004 and C044.
- When the unit is shipped from the factory, the remote control is set to C004.
- To set the remote control to C044, hold down both the STOP button and "2" number button on the remote control for at least five seconds.
- You can change the code of remote control only when NO DISC appears in the display window.
- To set the remote control back to C004, hold down both the STOP button and "1" number button on the remote control for at least five seconds.
- Also set the remote control codes of the player to the same setting as the remote control.  
(This setting is set to C004, when the unit is shipped from the factory.) (page 28)



## Rear Panel

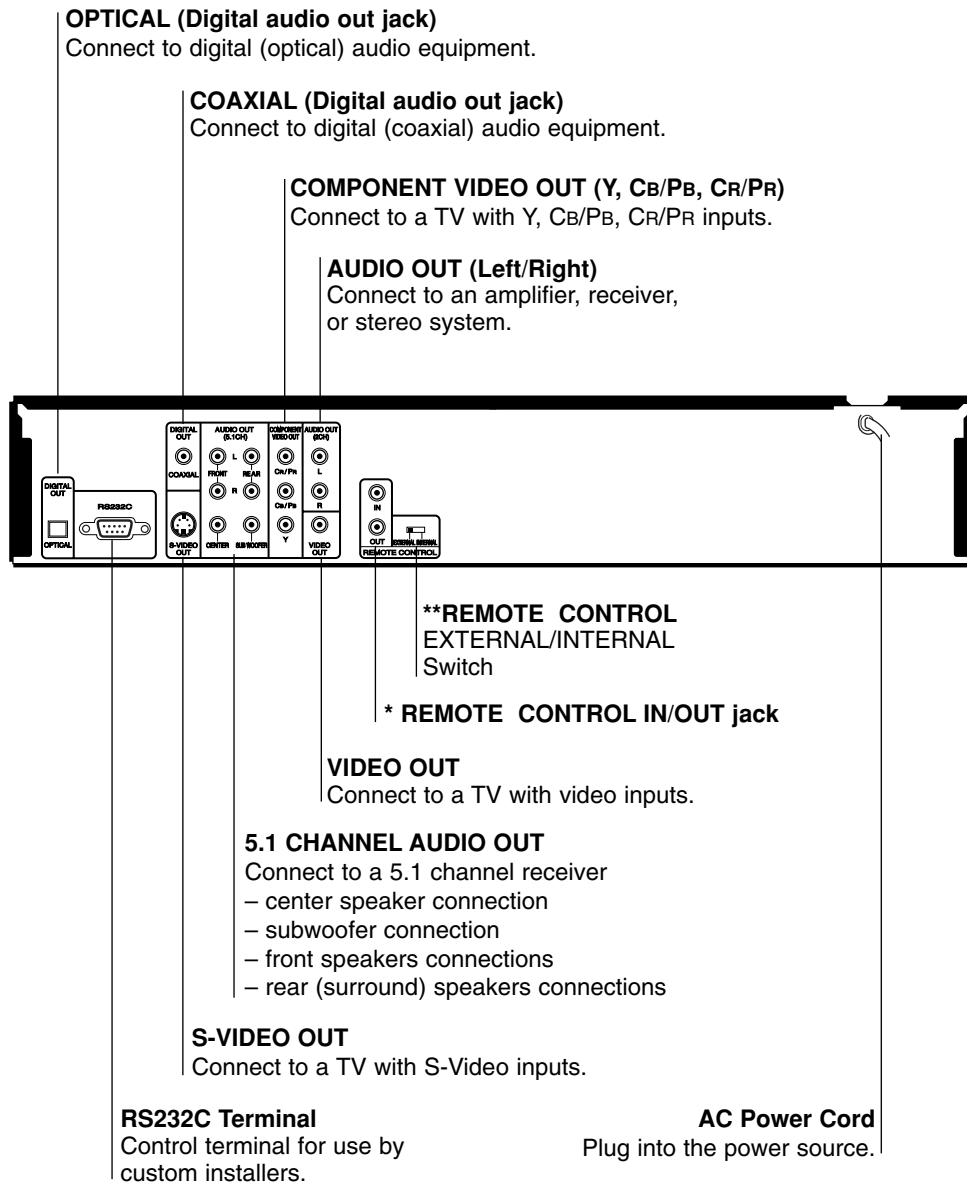

### \* REMOTE CONTROL IN/OUT jacks

By connecting this DVD player to another Marantz audio component using a supplied System Control cable, you can remotely operate the components as a single system.

- When connecting to component with a remote sensor, be sure to connect the “REMOTE CONTROL IN” jack of this DVD player to the “REMOTE CONTROL OUT” jack of the component with the remote sensor.
- When connecting to component which is not equipped with a remote sensor, be sure to connect the component to the “REMOTE CONTROL OUT” jack of this DVD player.

### \*\* Remote switch

- When using this DVD player independently, set this switch to “INTERNAL”. When using this DVD player in a system with a Marantz receiver equipped with a remote sensor, set the switch to “EXTERNAL”.

### ⚠ Caution

Do not touch the inner pins of the jacks on the rear panel. Electrostatic discharge may cause permanent damage to the unit.

## Connections

### Tips

- Depending on your TV and other equipment you wish to connect, there are various ways you could connect the player. Use only one of the connections described below.
- Please refer to the manuals of your TV, VCR, Stereo System or other devices as necessary to make the best connections.
- For better sound reproduction, connect the player's AUDIO OUT jacks to the audio in jacks of your amplifier, receiver, stereo or audio/video equipment. See "Connecting to Optional Equipment" on page 11-12.

### Caution

- Make sure the DVD Player is connected directly to the TV. Tune the TV to the correct video input channel.
- Do not connect the DVD Player's AUDIO OUT jack to the phono in jack (record deck) of your audio system.
- Do not connect your DVD Player via your VCR. The DVD image could be distorted by the copy protection system.

## Connecting to a TV

- Make one of the following connections, depending on the capabilities of your existing equipment.

### Video connection

- 1 Connect the VIDEO OUT jack on the DVD Player to the video in jack on the TV using the video cable (V).
- 2 Connect the Left and Right AUDIO OUT jacks of the DVD Player to the audio left/right in jacks on the TV (A) using the audio cables.

### S-Video connection

- 1 Connect the S-VIDEO OUT jack on the DVD Player to the S-Video in jack on the TV using the S-Video cable (S).
- 2 Connect the Left and Right AUDIO OUT jacks of the DVD Player to the audio left/right in jacks on the TV (A) using the audio cables.

### Component Video (Color Stream®) connection

- 1 Connect the COMPONENT VIDEO OUT jacks on the DVD Player to the corresponding in jacks on the TV using an Y, Cb/Pb, Cr/Pr cable (C).
- 2 Connect the Left and Right AUDIO OUT jacks of the DVD Player to the audio left/right in jacks on the TV (A) using the audio cables.

### Notes

- Refer to the owner's manual of your TV as well.
- Before you connect the DVD player to your TV, be sure to turn off the power and unplug both units from the wall outlet before making any connections.

### Progressive Scan (Color Stream® pro) connection

- If your television is a high-definition or "digital ready" television, you may take advantage of the DVD Player's progressive scan output for the highest video resolution possible.
- If your TV does not accept the Progressive Scan format, the picture will appear scrambled if you try Progressive Scan on the DVD Player.

- 1 Connect the COMPONENT VIDEO OUT jacks on the DVD Player to the corresponding in jacks on the TV using an optional Y, Cb/Pb, Cr/Pr cable (C).
- 2 Connect the Left and Right AUDIO OUT jacks of the DVD Player to the audio left/right in jacks on the TV (A) using the supplied audio cables.

### Notes

- Set the Progressive to "On" on the setup menu for progressive signal, see page 15.
- Progressive scan does not work with the analog video connections (yellow VIDEO OUT and S-VIDEO OUT jack). (See "Video mode setting", page 28)

### Rear of TV

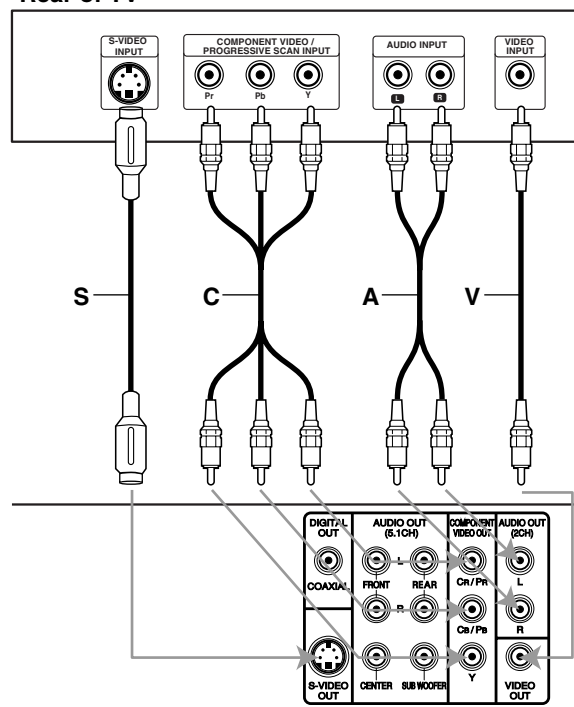

### Rear of DVD player

### Caution

- Do not set the Digital Audio Output of this DVD player to "Dolby Digital" unless you are connecting the DIGITAL OUT jack of this DVD player to an AV decoder that has the Dolby Digital decoding function. High volume sound may damage your hearing as well as the speakers.

## Connections (Continued)

### Connecting to Optional Equipment

#### Connecting to an amplifier equipped with two channel analog stereo or Dolby Pro Logic II/ Pro Logic

Connect the Left and Right AUDIO OUT jacks on the DVD Player to the audio left and right in jacks on your amplifier, receiver, or stereo system, using the audio cables (A).

#### Connecting to an amplifier equipped with two channel digital stereo (PCM) or to an Audio/ Video receiver equipped with a multi-channel decoder (Dolby Digital™, MPEG 2, or DTS)

- 1 Connect one of the DVD Player's DIGITAL AUDIO OUT jacks (OPTICAL **O** or COAXIAL **X**) to the corresponding in jack on your amplifier. Use an optional digital (optical **O** or coaxial **X**) audio cable.
- 2 You will need to activate the player's digital output. (See "Digital Audio Output" on page 16).

#### Digital Multi-channel sound

A digital multi-channel connection provides the best sound quality. For this you need a multi-channel Audio/Video receiver that supports one or more of the audio formats supported by your DVD Player (MPEG 2, Dolby Digital and DTS). Check the receiver manual and the logos on the front of the receiver.



#### Caution:

Due to the DTS Licensing agreement, the digital output will be in DTS digital out when DTS audio stream is selected.



#### Notes

- If the audio format of the digital output does not match the capabilities of your receiver, the receiver will produce a strong, distorted sound or no sound at all.
- Six Channel Digital Surround Sound via digital connection can only be obtained if your receiver is equipped with a Digital Multi-channel decoder.
- To see the audio format of the current DVD in the on-screen display, press AUDIO.

Rear of DVD player

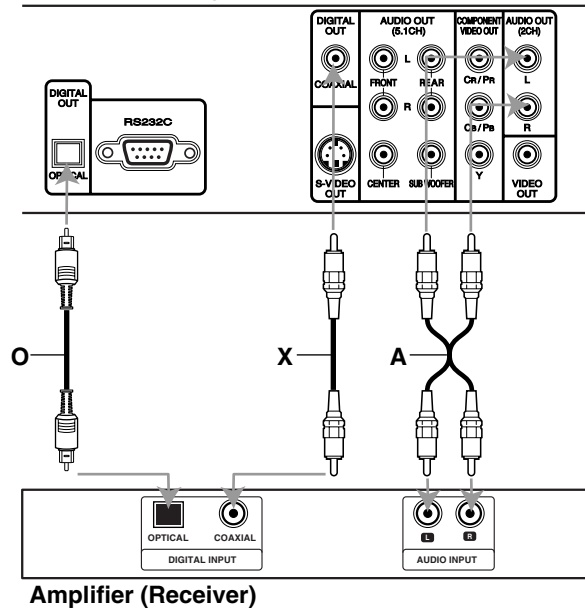

PREPARATION

## Connections (Continued)

### Connecting to Optional Equipment (Continued)

#### Analog connection to a multi-channel A/V receiver with 6 Channel connectors (Dolby Digital)

This DVD Player contains a multi-channel decoder. This enables playback of DVDs recorded in Multi-channel Surround without the need for an optional decoder.

- 1 Connect the CENTER and SUB WOOFER jacks for the Center speaker and the Subwoofer (C) to the corresponding jacks on your receiver.
- 2 Connect the Left and Right FRONT speaker jacks (F) to the corresponding jacks on your receiver.
- 3 Connect the Left and Right REAR speaker jacks (R) to the corresponding jacks on your receiver.
- 4 Make the appropriate Sound settings for Analog Output and Speaker Settings in the setup menu. See page 30.

#### Rear of DVD player

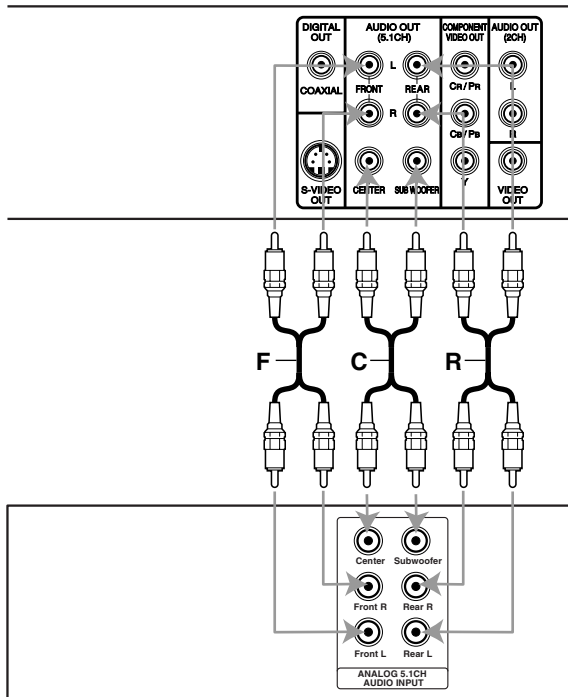

Amplifier (Receiver)

#### Notes

- Refer to the owner's manual of your audio system as well.
- Before you connect the DVD player to other equipment, be sure to turn off the power and unplug all of the equipment from the wall outlet before making any connections.
- If you place the DVD player near a tuner or radio, the radio broadcast sound might be distorted. In this case, move the DVD player away from the tuner and radio.
- The output sound of the DVD player has a wide dynamic range. Be sure to adjust the receiver's volume to a moderate listening level. Otherwise, the speakers may be damaged by a sudden high volume sound.
- Turn off the receiver before you connect or disconnect the DVD player's power cord. If you leave the receiver power on, the speakers may be damaged.
- When playing DTS-encoded discs (DVD video discs and audio CDs), excessive noise may be output from the analog stereo jacks.

To avoid possible damage to the audio system, you should take proper precautions when the AUDIO OUT jacks of the DVD video player is connected to an amplification system. To enjoy DTS Digital Surround playback, an external 5.1 channel DTS Digital Surround decoder system must be connected to the DIGITAL OUT jack of the DVD video player.

#### Caution

Do not set the Digital Audio Output of this DVD player to "Dolby Digital" unless you are connecting the DIGITAL OUT jack of this DVD player to an AV decoder that has the Dolby Digital decoding function. High volume sound may damage your hearing as well as the speakers.

## Before Operation

### General Explanation

This manual gives basic instructions for operating the DVD Player. Some DVDs require specific operation or allow only limited operation during playback. When this occurs, the symbol  appears on the TV screen, indicating that the operation is not permitted by the DVD Player or is not available on the disc.









### On-Screen Display

General playback status can be displayed on the TV screen. Some items can be changed on the menu.

#### On-screen display operation

- 1** Press OSD during playback.
- 2** Press **▲/▼** to select an item.  
The selected item will be highlighted.
- 3** Press **◀▶** to change the setting of an item.  
The number buttons can be also be used for setting numbers (e.g., title number). For some functions, press SELECT/ENTER to execute the setting.







### Temporary Feedback Field Icons

-  TITLE Repeat Title
-  CHAPT Repeat Chapter
-  GROUP Repeat Group (DVD audio discs only)
-  TRACK Repeat Track (non-PBC Video CDs and DVD audio discs only)
-  ALL Repeat All Tracks (non-PBC Video CDs only)
-  A B Repeat A-B
-  OFF Repeat Off
-  Resume play from this point
-  Action prohibited or not available

#### Notes

- Some discs may not provide all of the features on the on-screen display example shown below.
- If no button is pressed for 10 seconds, the on-screen display disappears.







#### DVD-V

Items		Function (Press <b>▲/▼</b> to select desired item)	Selection Method
Title Number	 1 / 3	Shows the current title number and total number of titles, and skips to the desired title number.	<b>◀ / ▶</b> , or Numbers, SELECT/ENTER
Chapter Number	 1 / 12	Shows the current chapter number and total number of chapters, and skips to the desired chapter number.	<b>◀ / ▶</b> , or Numbers, SELECT/ENTER
Time search	 0:20:09	Shows the elapsed playing time, and searches the point by the elapsed time directly.	Numbers, SELECT/ENTER
Audio language and Digital Audio Output mode	 1 ENG □□□ 5.1 CH	Shows the current audio soundtrack language, encoding method, and channel number, and changes the setting.	<b>◀ / ▶</b> , or AUDIO
Subtitle language	 OFF	Shows the current subtitles language, and changes the setting.	<b>◀ / ▶</b> , or SUBTITLE
Angle	 1 / 1	Shows the current angle number and total number of angles, and changes the angle number.	<b>◀ / ▶</b> , or ANGLE
Sound	 NORM.	Shows the current sound mode (NORMAL or 3D SURROUND), and changes the setting.	<b>◀ / ▶</b>





## Before Operation (Continued)

### On-Screen Display (Continued)

#### DVD-A

Items	Function (Press ▲/▼ to select desired item)	Selection Method
Group Number	 2 / 6 Shows the current group number and total number of groups, and skips to the desired group number.	◀ / ▶, or Numbers, SELECT/ENTER
Track Number	 1 / 12 Shows the current track number and total number of tracks, and skips to the desired track number.	◀ / ▶, or Numbers, SELECT/ENTER
Time search	 0:10:15 Shows the elapsed playing time.(Display only)	-
DVD Audio Output mode	 1 PPCM 5 CH Shows the current encoding method, and channel number, and changes the setting.	◀ / ▶, or AUDIO
Subtitle language	 OFF Shows the current subtitles language, and changes the setting.	◀ / ▶, or SUBTITLE
Page (or Angle)	 1 / 12 or  1 / 1 Shows the current page (or angle) number and total number of pages (or angle), and changes the page (or angle) number.	◀ / ▶, or ANGLE

#### VCD2.0 VCD1.1

Items	Function (Press ▲/▼ to select desired item)	Selection Method
Track Number	 1 / 4 Shows the current track number, total number of tracks and PBC On mode, and skip to the desired track number.	◀ / ▶, or Numbers, SELECT/ENTER
Time	 0:20:09 Shows the elapsed playing time (Display only)	-
Audio Channel	 STER. Shows the audio channel, and changes the audio channel.	◀ / ▶, or AUDIO
Sound	 NORM. Shows the current sound mode (NORMAL or 3D SURROUND), and changes the setting.	◀ / ▶

## Before Operation (Continued)

### Initial Settings

You can set your own Personal Preferences on the player.

#### Initial Settings General Operation

- 1 Press **SETUP**.  
The setup menu appears.



- 2 Press **▲/▼** to select the desired item.  
The screen will show the current setting for the selected item, as well as alternate setting(s).
- 3 While the desired item is selected, press **▶**, then **▲/▼** to select the desired setting.
- 4 Press **SELECT/ENTER** to confirm your selection.  
Some items require additional steps.
- 5 Press **SETUP**, **RETURN**, or **PLAY** to exit the setup menu.

### Language

#### Disc Language **DVD-V** **DVD-A**

Select a language for the disc's Menu, Audio, and Subtitle.

**Original** : The original language set for the disc is selected.  
**Other** : To select another language, press number buttons to enter the corresponding 4-digit number according to the language code list on page 31. If you enter the wrong language code, press **CLEAR**.



#### Menu Language

Select a language for the setup menu. This is the menu you see when you press **SETUP**.

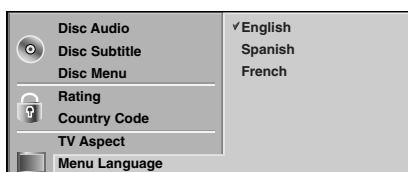

### Picture

#### TV Aspect **DVD-V** **DVD-A**

**4:3 Letterbox**: Select when a standard 4:3 TV is connected. Displays theatrical images with masking bars above and below the picture.

**4:3 Panscan**: Select when a conventional TV set is connected. The video material formatted in the Pan & Scan style is played back in that style (Both sides of the picture are cut off).

**16:9 Wide**: Select when a 16:9 wide TV is connected.

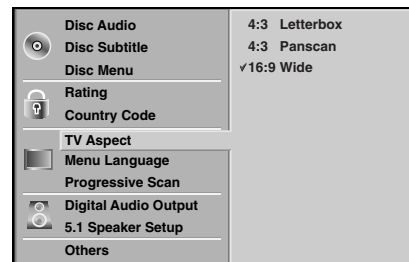

#### Progressive Scan **DVD-V** **DVD-A**

Progressive Scan Video provides the highest quality pictures with less flickering.

If you are using the **COMPONENT VIDEO OUT** jacks, but are connecting the DVD Player to a standard (analog) television, set Progressive Scan to Off.

If you are using the Component Video jacks for connection to a TV or monitor that is compatible with a progressive scan signal, set Progressive Scan to On.

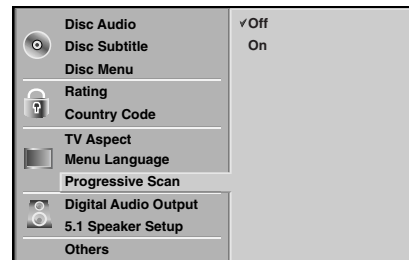

#### Caution

Once the setting for progressive scan output is entered, an image will only be visible on a progressive scan compatible TV or monitor. If you set Progressive Scan to On in error, you must reset the unit. Press **STOP** to stop any disc that is playing. Next, press **STOP** again and hold it for five seconds before releasing it. The video output will be restored to the standard setting, and a picture will once again be visible on a conventional analog TV or monitor.

## Before Operation (Continued)

### Sound

#### Digital Audio Output

Each DVD disc has a variety of audio output options. Set the player's Digital Audio Output according to the type of audio system you use.

**DOLBY DIGITAL/PCM:** Select "DOLBY DIGITAL/PCM" if you connected the DVD Player's DIGITAL OUT jack to a Dolby Digital decoder (or an amplifier or other equipment with a Dolby Digital decoder).

**Stream/PCM:** Select "Stream/PCM" if you connected the DVD Player's DIGITAL OUT jack to an amplifier or other equipment with a DTS decoder, Dolby Digital decoder or MPEG decoder.

**PCM:** Select when connected to a 2-channel digital stereo amplifier. The DVD player outputs sounds in the PCM 2ch format when you play a DVD video disc recorded on the Dolby Digital, HDCD, MPEG1, or MPEG2 recording system.

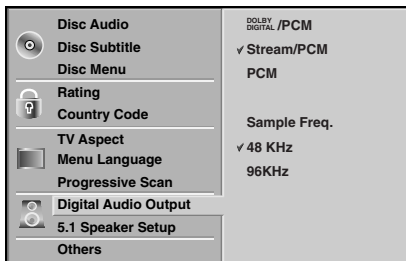

#### Sample Frequency

To change the Sample Frequency setting, first select the desired Digital Audio Output as indicated as above. If your receiver or amplifier is NOT capable of handling 96KHz signals, select 48KHz. When this choice is made, this unit will automatically convert any 96KHz signals to 48KHz so your system can decode them. If your receiver or amplifier is capable of handling 96KHz signals, select 96KHz. When this choice is made, this unit will pass each type of signal through without any further processing.

#### 5.1 Speaker settings **DVD-V** **DVD-A**

Select speaker settings, including volume balance and delay time, or test the speaker settings.

Speaker settings are only active on the Analog Multi-Channel Output. (See "Speaker Settings", page 30.)

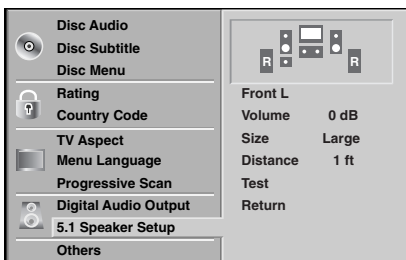

### Others

The DRC, Vocal, PBC and Auto Play settings can be changed.

- Press ▲/▼ to select the desired item and press SELECT/ENTER. The setting of the selected item is changed between On and Off.



#### Dynamic Range Control (DRC) **DVD-V**

With the DVD format, you can hear a program's soundtrack in the most accurate and realistic presentation possible, thanks to digital audio technology. However, you may wish to compress the dynamic range of the audio output (the difference between the loudest sounds and the quietest ones). Then, you may listen to a movie at a lower volume without losing clarity of sound. Set DRC to On for this effect.

#### Vocal **DVD-V**

Set Vocal to On only when a multi-channel karaoke DVD is playing. The karaoke channels on the disc will mix into normal stereo sound.

#### PBC **VCD2.0**

Set Playback Control (PBC) to On or Off.

**On:** Video CDs with PBC are played according to the PBC.

**Off:** Video CDs with PBC are played the same way as Audio CDs.

#### Auto Play **DVD-V**

You can set up the DVD Player so a DVD disc automatically starts playing whenever the DVD is inserted.

If Auto Play mode is set to On, this DVD player will search a title that playback time is long most and then play back the title automatically.

**On:** Auto Play function is activated.

**Off:** Auto Play function is not activated.

#### Note

The Auto Play function may not work for some DVDs.



## Before Operation (Continued)

### Parental Control

#### Rating **DVD-V**

Movies on DVDs may contain scenes not suitable for children. Therefore, discs may contain Parental Control information that applies to the complete disc or to certain scenes on the disc. These scenes are rated from 1 to 8, and alternatively, more suitable scenes are available for selection on some discs. Ratings are country-dependent. The Parental Control feature allows you to prevent discs from being played by your children or to have certain discs played with alternative scenes.

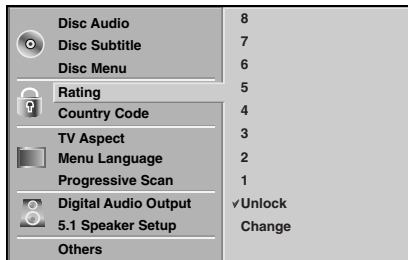

**1** Select "Rating" on the Setup menu using the ▲▼ buttons.

**2** While "Rating" is selected, press ►.

**3** When you have not entered a password yet. Enter a 4-digit password using the numbered buttons to create a personal 4-digit security password. then press SELECT/ENTER. Enter the 4-digit password again and press SELECT/ENTER to verify. **When you have already entered a password;** Enter a 4-digit password using the numbered buttons to confirm the personal 4-digit security password, then press SELECT/ENTER.

If you make a mistake before pressing SELECT/ENTER, press CLEAR and enter 4-digit security password again.

**4** Select a rating from 1 to 8 using the ▲▼ buttons. One (1) has the least playback restrictions. Eight (8) has the most playback restrictions.

**Unlock:** If you select Unlock, Parental Control is not active. The disc will play in full.

**Ratings 1 to 8:** Some discs contain scenes not suitable for children. If you set a rating for the player, all disc scenes with the same rating or lower will be played. Higher rated scenes will not be played unless an alternative scene is available on the disc. The alternative must have the same rating or a lower one. If no suitable alternative is found, playback will stop. You must enter the 4-digit password or change the rating level in order to play the disc.

**5** Press SELECT/ENTER to confirm your rating selection, then press SETUP to exit the menu.

#### Country Code **DVD-V**

Enter the code of a country/area whose standards were used to rate the DVD video disc, referring to the list (See "Country Code List", page 32.).

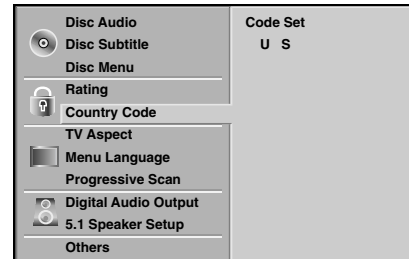

**1** Select Country Code using the ▲▼ buttons on the setup menu.

**2** While Country Code is selected, press ►.

**3** Follow step 3 of "Rating" on left.

**4** Select the first character using the ▲▼ buttons.

**5** Shift the cursor using ► button and select the second character using ▲▼ buttons.

**6** Press SELECT/ENTER to confirm your country code selection, then press SETUP to exit the menu.

#### Note

Confirmation of the 4-digit password is necessary when the code is changed (see "Changing the 4-digit code" below.).

#### Changing the 4-digit code

- 1 Follow Steps 1-2 as shown above to the left (Rating).
- 2 Enter the old code, then press SELECT/ENTER.
- 3 Select Change using ▲▼ buttons then press SELECT/ENTER.
- 4 Enter the new 4-digit code, then press SELECT/ENTER.
- 5 Enter exactly the same code a second time and verify by pressing SELECT/ENTER.
- 6 Press SETUP to exit the menu.

#### If you forget your 4-digit code

If you forget your password, to clear the current password, follow the procedure below.

- 1 Press SETUP to display the setup menu.
- 2 Use the Number buttons to enter the 6-digit number "210499".  
The 4-digit password is cleared. "P CLR" appears on the display for a moment.
- 3 Enter a new code as shown above to the left (Rating).

## Operation with DVD and Video CD

### Playing a DVD and Video CD

#### **T** Playback Setup **DVD-V** **DVD-A** **VCD2.0** **VCD1.1**

- Turn on the TV and select the video input source connected to the DVD player.
- Audio system: Turn on the audio system and select the input source connected to the DVD player.

#### **1** Press OPEN/CLOSE to open the disc tray.

#### **2** Load your chosen disc in the tray, with the playback side down.

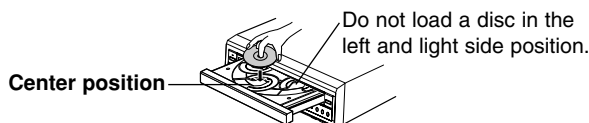

- Discs can be loaded one at a time by pressing DISC SKIP to rotate the carousel.

#### **3** Press OPEN/CLOSE to close the tray.

READING appears on the TV screen, and playback starts automatically. If playback does not start, press PLAY.

In some cases, the disc menu might appear instead.

#### **T** If a menu screen is displayed

The menu screen may be displayed first after loading a DVD or Video CD which offer a menu.

##### **DVD-V**

Use the ◀▶/▲▼ buttons to select the title/chapter you want to view, then press SELECT/ENTER to start playback.

Press TOP MENU or MENU to return to the menu screen.

##### **DVD-A**

Use the ◀▶/▲▼ buttons to select an option you want, then press SELECT/ENTER to view the option.

##### **VCD2.0**

- Use the number buttons to select the track you want to view.  
Press RETURN to return to the menu screen.
- Menu setting and the exact operating procedures for using the menu may differ depending on the disc. Follow the instructions on the each menu screen. You also may set PBC to Off under setup. See page 16.

#### **⚠ Caution**

- Do not touch the loading drawer and carousel while they are in motion, and do not attempt to rotate the carousel by hand; doing so could result in incorrect operation of the player and/or damage to the discs.

#### **N** Notes

- If Parental Control is set and the disc is not within the Rating settings (not authorized), the 4-digit code must be entered and/or the disc must be authorized (see "Parental Control", on page 17).
- DVDs may have a region code. Your player will not play discs that have a region code different from your player. The region code for this player is 1 (one).

### Exchanging discs during playback

- Press DISC EX-CHANGE on the front panel during playback to open the disc tray.
- Press DISC SKIP to rotate the disc trays to the desired position. The carousel will rotate clockwise by one disc increments.
- Exchange the discs and press DISC EX-CHANGE or OPEN/CLOSE to close the disc tray.

#### **N** Note

- The disc tray presently loaded in the play position can not be exchanged.

### Skipping discs

Press DISC SKIP during play or when playback is stopped.

#### **N** Notes

- When DISC SKIP is pressed, the disc tray rotates and playback begins from the beginning of the next disc.
- If there is no disc on the next disc tray, the following disc tray will be selected.
- When DISC SKIP is pressed during playback of disc 5, playback of disc 1 will start.

### Exchanging the disc and starting playback

1. Press OPEN/CLOSE during playback or when playback is stopped.  
Play stops (if pressed during playback), the disc tray opens and the disc that was in the play position comes to the front.
2. Exchange the disc.
3. Press OPEN/CLOSE or PLAY again.  
The tray closes and playback begins (with the disc that was in front).

#### After operation

When the unit is not in use, remove the disc and press POWER to turn off the DVD player.

#### **N** Notes

- Do not move the DVD player during playback. Doing so may damage the disc and the DVD player.
- Use the OPEN/CLOSE button on the remote control or DVD player to open and close the disc tray. Do not push the disc tray while it is moving. Doing so may cause the DVD player to malfunction.
- Do not push up the disc tray or put any objects other than discs on the disc tray. Doing so may cause the DVD video player to malfunction.
- Keep your fingers well clear of the disc tray as it is closing. Be especially careful with children's fingers around the closing disc tray as there is a risk of personal injury.

## Operation with DVD and Video CD

### General Features

#### Note

Unless stated otherwise, all operations described use the remote control. Some features may also be available on the Setup menu.

#### Moving to another TITLE/GROUP



When a disc has more than one title/group, you can move to another title/group as follows:

- Press OSD, then press the appropriate numbered button (0-9) to select a title/group number.

#### Moving to another CHAPTER/TRACK



When a title on a disc has more than one chapter or a disc has more than one track, you can move to another chapter/track as follows:

- Press SKIP/SCAN **◀◀** or **▶▶** briefly during playback to select the next chapter/track or to return to the beginning of the current chapter/track.
- Press **◀◀** twice briefly to step back to the previous chapter/track.
- To go directly to any chapter/track during DVD playback, press OSD. Then, press **▲/▼** to select the chapter/track icon. Then, enter the chapter/track number using the numbered buttons (0-9).

#### Note

For two-digit numbers, press the numbered buttons (0-9) in rapid succession.

#### Search **DVD-V** **DVD-A** **VCD2.0** **VCD1.1**

- 1 Press and hold SKIP/SCAN **◀◀** or **▶▶** for about two seconds during playback.  
The player will now go into SEARCH mode.
- 2 Press and hold SKIP/SCAN **◀◀** or **▶▶** repeatedly to select the required speed: **◀◀X2**, **◀◀X4**, **◀◀X16**, **◀◀X100** (backward) or **▶▶X2**, **▶▶X4**, **▶▶X16**, **▶▶X100** (forward).  
With a Video CD, the Search speed changes: **◀◀X2**, **◀◀X4**, **◀◀X8**, (backward) or **▶▶X2**, **▶▶X4**, **▶▶X8**, (forward).
- 3 To exit SEARCH mode, press PLAY.

#### Note

When using a DVD audio disc that includes pictures, this operation may be permitted in some picture segments.

#### Pause **DVD-V** **DVD-A** **VCD2.0** **VCD1.1**

- 1 Press PAUSE/STEP during playback.
- 2 To return to playback, press PLAY.

#### Still Picture and Frame-by-Frame playback



- 1 Press PAUSE/STEP during playback.  
The player will now go into PAUSE mode.
- 2 You can advance the picture frame-by-frame by pressing PAUSE/STEP repeatedly on the remote control.

#### Note

When using a DVD audio disc that includes pictures, this operation may be permitted in some picture segments.

#### Slow Motion **DVD-V** **DVD-A** **VCD2.0** **VCD1.1**

- 1 Press SLOW **◀** or **▶** during playback.  
The player will enter SLOW mode.
- 2 Use the SLOW **◀** or **▶** to select the required speed: **◀** 1/16, **◀** 1/8, **◀** 1/4 or **◀** 1/2 (backward), or **▶** 1/16, **▶** 1/8, **▶** 1/4 or **▶** 1/2 (forward).
- 3 To exit slow motion mode, press PLAY.

#### Notes

- Slow motion playback in reverse is not applicable for Video CD.
- When using a DVD audio disc that includes pictures, this operation may be permitted in some picture segments.

#### Random **Karaoke DVD** **VCD2.0** **VCD1.1**

- 1 Press RANDOM during playback or in stop mode.  
The unit automatically begins Random Playback and "RANDOM(1-3)" appears on the display window.
  - RANDOM1: Plays all the tracks on a single disc in random order and then stops.
  - RANDOM2: Plays all the tracks on current disc in random order and then plays all the tracks on each succeeding disc in random order and then stops.
  - RANDOM3: Plays 2 tracks randomly from a disc and then plays 2 tracks randomly from a different disc until all tracks on all discs have been played.
- 2 To return to normal playback, press RANDOM until "RANDOM" disappears on the display window.

#### Tips

By pressing SKIP/SCAN **▶▶** during Random playback, the unit selects another title (track) and resumes Random playback.

#### Notes

- This function only works with DVD Karaoke discs and video CD without PBC.
- DVD karaoke works only RANDOM 1 function.
- On a Video CD with PBC, you must set PBC to Off on the setup menu to use the Random function. See page 16.

## Operation with DVD and Video CD

### General Features (continued)

#### Repeat A-B

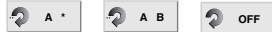

To repeat a sequence in a title or group:

- 1 Press A-B at your chosen starting point.  
“A \*” appears briefly on the TV screen.
- 2 Press A-B again at your chosen end point.  
“A B” appears briefly on the TV screen, and the repeat sequence begins (“A↔B” appears the display window).
- 3 To cancel the sequence, press A-B.

#### Repeat



##### DVD Video Discs - Repeat Chapter/Title/All/Off

- 1 To repeat the currently playing chapter, press REPEAT.  
The Repeat Chapter icon appears on the TV screen.
- 2 To repeat the title currently playing, press REPEAT a second time.  
The Repeat Title icon appears on the TV screen.
- 3 To repeat entire all disc contents, press REPEAT a third time.  
The Repeat All icon appears on the TV screen.
- 4 To exit Repeat mode, press REPEAT a fourth time.  
The Repeat Off icon appears on the TV screen.

##### DVD Audio Discs - Repeat Track/Group/All/Off

- 1 To repeat the currently playing track, press REPEAT.  
The Repeat Track icon appears on the TV screen.
- 2 To repeat the group currently playing, press REPEAT a second time.  
The Repeat Group icon appears on the TV screen.
- 3 To repeat entire all disc contents, press REPEAT a third time.  
The Repeat All icon appears on the TV screen.
- 4 To exit Repeat mode, press REPEAT a fourth time.  
The Repeat Off icon appears on the TV screen.

##### Video CDs - Repeat Track/Disc/All/Off

- 1 To repeat the track currently playing, press REPEAT.  
The Repeat Track icon appears on the TV screen.
- 2 To repeat the disc currently playing, press REPEAT a second time.  
The Repeat Disc icon appears on the TV screen.
- 3 To repeat entire all disc contents, press REPEAT a third time.  
The Repeat All icon appears on the TV screen.
- 4 To exit Repeat mode, press REPEAT a fourth time.  
The Repeat Off icon appears on the TV screen.

#### Note

On a Video CD with PBC, you must set PBC to Off on the setup menu to use the Repeat function. See page 16.

#### Time Search

The Time Search function allows you to start playing at any chosen time on the disc.

- 1 Press OSD during playback. The on-screen display appears on the screen.  
The Time Search box shows the elapsed playing time of the current disc.
- 2 Within 10 seconds, press ▲/▼ to select the Time Search icon in the on-screen display.  
The “-:-:-:-” appears in the Time Search box.
- 3 Within 10 seconds, use the number buttons to enter the required start time. Enter hours, minutes, and seconds from left to right in the box.  
If you enter the wrong numbers, press CLEAR to remove the numbers you entered. Then enter the correct numbers.
- 4 Within 10 seconds, press SELECT/ENTER to confirm the start time.  
Playback starts from the selected time on the disc. If you enter an invalid time, playback will continue from the current point.

#### 3D Surround

This unit can produce a 3D Surround effect, which simulates multi-channel audio playback from two conventional stereo speakers, instead of the five or more speakers normally required to listen to multi-channel audio from a home theater system.

- 1 Press OSD during playback.
- 2 Press ▲ or ▼ to select the sound option.  
The sound option will be highlighted.
- 3 Press ◀ or ▶ to select “3D SUR”.  
To turn off the 3D Surround effect, select “NORM”.

#### Zoom

The Zoom function allows you to enlarge the video image and to move through the enlarged image.

- 1 Press ZOOM during playback or still playback to activate the Zoom function.  
If you press ZOOM repeatedly, the magnification level increases up to six steps.
- 2 Use the ◀▶/▲▼ buttons to move through the zoomed picture.
- 3 Press CLEAR to resume normal playback or return to the paused image.

#### Note

The zoom function may not work for some DVDs.

## Operation with DVD and Video CD

### General Features (continued)

#### Marker Search **DVD-V** **VCD2.0** **VCD1.1**



You can start playback from a memorized point. Up to nine points can be memorized.

To enter a mark, follow these steps.

- 1 During disc playback, press **MARKER** when playback reaches the spot that you want to memorize.  
The Marker icon will appear on the TV screen briefly.
- 2 Repeat step 1 to enter up to nine Marker points on a disc.

#### To Recall a Marked Scene

- 1 During disc playback, press **SEARCH**.  
The **MARKER SEARCH** menu will appear on the screen.
- 2 Within 10 seconds, press **◀▶** to select a Marker number that you want to recall.
- 3 Press **SELECT/ENTER**.  
Playback will start from the Marked scene.
- 4 To remove the **MARKER SEARCH** menu, press **SEARCH**.

#### To clear a Marked Scene

- 1 During disc playback, press **SEARCH**.  
The **MARKER SEARCH** menu will appear on the screen.
- 2 Press **◀▶** to select the Marker number that you want to erase.
- 3 Press **CLEAR**.  
The Marker number will be erased from the list.
- 4 Repeat steps 2 and 3 to erase additional Marker numbers.
- 5 To remove the **MARKER SEARCH** menu, press **SEARCH**.

### Special DVD Features **DVD-V** **DVD-A**

#### Checking the contents of DVD discs: Menus

DVDs may offer menus that allow you to access special features. To use the disc menu, press **MENU**. Then, press the appropriate number button to select an option. Or, use the **◀▶/▲▼** buttons to highlight your selection, then press **SELECT/ENTER**.

#### Title Menu **DVD-V** **DVD-A**

- 1 Press **TOP MENU**.  
If the current title has a menu, the menu will appear on the screen. Otherwise, the disc menu may appear.
- 2 The menu can list camera angles, spoken language and subtitle options, and chapters for the title.
- 3 To remove the title menu, press **TOP MENU** again.

#### Disc Menu **DVD-V** **DVD-A**

- 1 Press **MENU**.  
The disc menu is displayed.
- 2 To remove the disc menu, press **MENU** again.

#### Camera Angle **DVD-V** **DVD-A**

If the disc contains scenes recorded at different camera angles, you can change to a different camera angle during playback.

- Press **ANGLE** repeatedly during playback to select a desired angle.  
The number of the current angle appears on the display.

#### Changing the Audio Language



Press **AUDIO** repeatedly during playback to hear a different audio language or audio track.

#### Changing the Audio Channel **VCD2.0** **VCD1.1**

Press **AUDIO** repeatedly during playback to hear a different audio channel (**STER.**, **LEFT** or **RIGHT**).

#### Subtitles **DVD-V** **DVD-A**

Press **SUBTITLE** repeatedly during playback to see the different subtitle languages.

#### Note

If appears, the feature is not available on the disc.

## Operation with DVD and Video CD

### DVD Audio Discs

DVD Audio is a new disc format building on the success of DVD to provide high quality, uncompressed, multi-channel audio for a new experience in audio quality. A DVD Audio disc can be identified by the DVD audio logo on the disc jacket or on the disc itself.

DVD Audio can provide higher quality stereo than Audio CDs with a sampling rate of up to 192kHz (compared to 44.1kHz for CDs). DVD Audio digital sound can be delivered with up to 24 bits of data (compared to 16 bits for a standard CD).

A typical DVD Audio disc contains up to seven times the data capacity of a CD. This additional space is used for music, either Advanced Resolution multi-channel sound quality that is closer to the artist's master recording or for longer recordings. Many DVD Audio discs contain on-screen text, such as artist biographies, playlists, or lyrics. Some DVD Audio discs contain photo galleries or video clips.

#### Note

To enjoy maximum sound quality and surround effect of DVD Audio, you must use 5.1 channel analog audio output (5.1CH AUDIO OUT jacks on the DVD Player). If you use the DIGITAL OUT (OPTICAL or COAXIAL) for your audio connection, the sound will only be similar to CD-quality sound even though you're playing a DVD Audio disc.

### Moving to another GROUP 1/6

Some DVD Audio discs divide content into different groups. Your player enables you to quickly access different groups during playback via the on-screen display.

- 1 Press OSD during playback on in stop mode.
- 2 Press ▲/▼ to select Group icon.
- 3 Press ◀▶ or the numbered buttons (0-9) to select a group number.

#### Note

Sometimes the author of the disc creates hidden content that can only be accessed by entering a password. If the lock icon appears on the TV screen, enter the password (sometimes you'll find it on the disc's jacket cover or on a web site). This password control isn't dictated by your DVD Player — it is a function of the disc. Since the authoring of DVD Audio Discs varies, some of the on-screen display choices might not be available for the disc you're playing.

### Viewing another PAGE 1/12

Since DVD Audio discs can hold a lot of content, there are various ways to see what's available on the disc.

- 1 Press OSD during playback.
- 2 Press ▲/▼ to select Page icon.
- 3 Press ◀▶ to select a page number.

What appears on the screen will vary from disc to disc because the information available depends upon the way the disc was created.

#### Note

Since the authoring of DVD Audio Discs varies, some of the on-screen display choices might not be available for the disc you're playing.

## Operation with Audio CD and MP3/WMA Disc

### Playing an Audio CD and MP3/WMA Disc

**CD** **MP3** **WMA**

The DVD Player can play MP3/WMA formatted recordings on CD-ROM, CD-R or CD-RW discs. Before playing MP3/WMA recordings, read the notes on MP3/WMA Recordings on right.

- 1 Insert a disc and close the tray.**  
**Audio CD;** Audio CD menu appears on the TV screen go to step 4.  
**MP3/WMA disc;** The MP3/WMA-JPEG choice menu appears on the TV screen. Go to step 2



- 2 Press ▲/▼ to select the MP3/WMA then press SELECT/ENTER.**  
The MP3/WMA menu appears on the TV screen. Press RETURN to move to the MP3/WMA-JPEG choice menu.

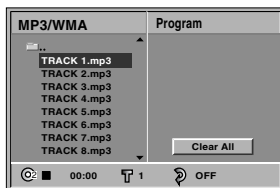

- 3 Press ▲/▼ to select a folder, and SELECT/ENTER.**  
A list of files in the folder appears.
- 4 Press ▲/▼ to select a track then press PLAY or SELECT/ENTER.**  
Playback starts.  
During playback, the current track's elapsed playing time will appear on the display window and menu. Playback will stop at the end of the disc.  
Press TOP MENU to move to the next page.  
Press MENU to move to the previous page.

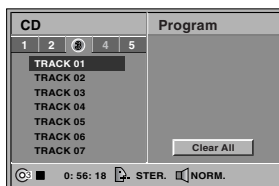

Audio CD menu

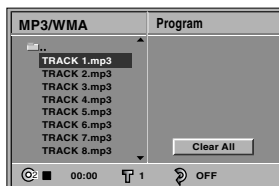

MP3/WMA menu



**Tip**  
If you are in a file list and want to return to the Folder list, use the ▲/▼ to highlight and press SELECT/ENTER to return to the previous menu screen.

- 5 To stop playback at any other time, press STOP.**

### Notes on MP3/WMA Recordings

#### About MP3

- An MP3 file is audio data compressed by using the MPEG1 audio layer-3 file-coding scheme. We call files that have the ".mp3" file extension "MP3 files".
- The player can not read an MP3 file that has a file extension other than ".mp3".

#### About WMA(Window Media Audio)

- An WMA file is a Microsoft audio compression technology.
- WMA(Windows Media Audio) offers double the audio compression of the MP3 format.

Microsoft, Windows Media, and the Windows Logo are trademarks or registered trademarks of Microsoft Corporation in both the United States and other countries



#### MP3/WMA Disc compatibility with this player is limited as follows:

1. Sampling Frequency / only at 44.1kHz (MP3), 22.05 - 44.1kHz (WMA)
2. Bit rate / within 32 - 320kbps (MP3), 32 - 128kbps (WMA)
3. CD-R physical format should be "ISO 9660"
4. If you record MP3/WMA files using the software which cannot create a FILE SYSTEM, for example "Direct-CD" etc., it is impossible to playback MP3/WMA files. We recommend that you use "Easy-CD Creator", which creates an ISO9660 file system.
5. A single session disc requires MP3/WMA files in the first track. If there is no MP3/WMA file in the 1st track, it cannot playback MP3/WMA files. If you wish to playback MP3/WMA files, format all the data in the disc or use a new one.
6. File names should be named using 8 letters or less and must incorporate ".mp3" or ".wma" extension e.g. "\*\*\*\*\*.MP3" or "\*\*\*\*\*.WMA".
7. Do not use special letters such as "/ : \* ? < >" etc.
8. Total number of files on the disc should be less than 650.

This DVD player requires discs/recordings to meet certain technical standards in order to achieve optimal playback quality. Pre-recorded DVDs are automatically set to these standards. There are many different types of recordable disc formats (including CD-R containing MP3 or WMA files). That require certain pre-existing conditions (see above) to insure compatible playback.

**Customers should also note that permission is required in order to download MP3/WMA files and music from the Internet. Our company has no right to grant such permission. Permission should always be sought from the copyright owner.**

#### Caution

- If you record a disc using a personal computer, even if it is recorded in a compatible format, there are cases in which it may not play because of the settings of the application software used to create the disc. (Check with the software publisher for more detailed information.)

## Operation with Audio CD and MP3/WMA Disc (Continued)

### Pause **CD** **MP3** **WMA**

- 1 Press PAUSE/STEP during playback.
- 2 To return to playback, press PLAY or press PAUSE/STEP again.

### Moving to another Track **CD** **MP3** **WMA**

- Press SKIP/SCAN **◀◀** or **▶▶** briefly during playback to go to the next track or to return to the beginning of the current track.
- Press SKIP/SCAN **◀◀** twice briefly to step back to the previous track.
- In case of audio CD, to go directly to any track, enter the track number using the numbered buttons (0-9) during playback.

### Search **CD** **MP3** **WMA**

- 1 Press and hold SKIP/SCAN **◀◀** or **▶▶** for about two seconds during playback.  
The player will now go into SEARCH mode.
- 2 Press and hold SKIP/SCAN **◀◀** or **▶▶** repeatedly to select the required speed: **◀◀X2**, **◀◀X4**, **◀◀X8** (backward) or **▶▶X2**, **▶▶X4**, **▶▶X8** (forward).  
Search speed and direction are indicated on the menu screen.
- 3 To exit SEARCH mode, press PLAY.

### Random with MP3/WMA Disc **MP3** **WMA**

- 1 Press RANDOM during playback or when playback is stopped.  
The unit automatically begins Random Playback and RANDOM or "RAND." appears on the display window and menu screen.
- 2 To return to normal playback, press RANDOM repeatedly until RANDOM or "RAND." disappears on the display window and menu screen.

### Repeat Track/All/Off **MP3** **WMA**

- 1 To repeat the track currently playing, press REPEAT.  
The Repeat icon and "TRACK" appears on the menu screen.
- 2 To repeat all tracks on a disc, press REPEAT a second time.  
The Repeat icon and "ALL" appears on the menu screen.
- 3 To cancel Repeat mode, press REPEAT a third time.  
The Repeat icon and "OFF" appears on the menu screen.

### Random with Audio CD **CD**

- 1 Press RANDOM during playback or in stop mode.  
The unit automatically begins Random Playback and "RANDOM(1-3)" appears on the display window.
  - RANDOM1: Plays all the tracks on a single disc in random order and then stops.
  - RANDOM2: Plays all the tracks on current disc in random order and then plays all the tracks on each succeeding disc in random order and then stops.
  - RANDOM3: Plays 2 tracks randomly from a disc and then plays 2 tracks randomly from a different disc until all tracks on all discs have been played.
- 2 To return to normal playback, press RANDOM until "RANDOM" disappears on the display window.

### Repeat A-B **CD**

To repeat a sequence.

- 1 During disc playback, press A-B at your chosen starting point.  
The Repeat icon and "A \*" appears on the menu screen.
- 2 Press A-B again at your chosen end point.  
The Repeat icon and "A B" appears on the menu screen, and the sequence begins to play repeatedly.
- 3 To exit the sequence and return to normal play, press A-B again.  
The Repeat icon and "OFF" appears on the menu screen.

### 3D Surround **CD**

This unit can produce a 3D Surround effect, which simulates multi-channel audio playback from two conventional stereo speakers, instead of the five or more speakers normally required to listen to multi-channel audio from a home theater system.

- 1 Press OSD during playback.
- 2 Use **◀** or **▶** to select the sound option.  
The sound option will be highlighted.
- 3 Use **▲** or **▼** to select "3D SUR".  
To turn off the 3D Surround effect, select "NORM".

### Changing the Audio Channel **CD**

Press AUDIO repeatedly during playback to hear a different audio channel (STER., LEFT, or RIGHT).

### Repeat Track/Disc/All/Off **CD**

1. To repeat the track currently playing, press REPEAT.  
The Repeat icon and "TRACK" appear on the menu screen.
2. To repeat all tracks on a disc, press REPEAT a second time.  
The Repeat icon and "DISC" appear on the menu screen.
3. To repeat entire all disc contents, press REPEAT third time.  
The Repeat icon and "All" appears on the menu screen.
4. To cancel Repeat mode, press REPEAT a fourth time.  
The Repeat icon and "OFF" appear on the menu screen.



## Operation with JPEG Disc

### Viewing a JPEG disc **JPEG**

This DVD Player can play discs with JPEG files and Kodak picture CD. Before playing JPEG recordings, read the notes on JPEG Recordings on right.

- 1 Insert a disc and close the tray.**  
The MP3/WMA-JPEG choice menu appears on the TV screen.



- 2 Press ▲/▼ to select the JPEG then press SELECT/ENTER.**  
The JPEG menu appears on the TV screen.

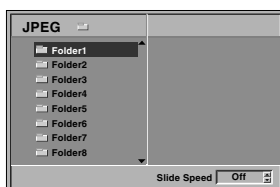

- 3 Press ▲/▼ to select a folder, and SELECT/ENTER.**  
A list of files in the folder appears.  
Press RETURN to move to the MP3/WMA-JPEG choice menu.

#### **T** Tip

If you are in a file list and want to return to the Folder list, use the ▲/▼ buttons on the remote to highlight “..” and press SELECT/ENTER to return to the previous menu screen.

- 4 If you want to view a particular file, press ▲/▼ to highlight a file and press SELECT/ENTER or PLAY.**

Viewing the file proceeding starts.  
During viewing a file, press RETURN to move to the previous menu (JPEG menu).  
Press TOP MENU to move to the next page.  
Press MENU to move to the previous page.

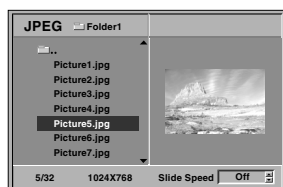

#### **T** Tip

There are three viewing Slide Speed options: Fast, Normal, Slow, and Off. Press ◀▶ to highlight the Slide Speed then press ▲/▼ to select the option you want to use, and press SELECT/ENTER.

- 5 To stop viewing at any other time, press STOP.**  
The JPEG menu appears.

### Moving to another File

Press SKIP/SCAN ◀◀ or ▶▶ once during viewing a picture to advance to the next file or to the previous file.

### Still Picture

- Press PAUSE/STEP during slide show.  
The player will now go into PAUSE mode.
- To return to the slide show, press PLAY or press PAUSE/STEP again.

### To flip the picture

Press ▲/▼ during showing a picture to flip the picture horizontally or a vertically.

### To rotate picture

Press ◀▶ during showing a picture to rotate the picture clockwise or counter clockwise.

### Notes on JPEG Recordings

- Depending upon the size and number of the JPEG files, it could take a long time for the DVD player to read the disc's contents. If you don't see an on-screen display after several minutes, some of the files are too big — reduce the resolution of the JPEG files to less than 2 mega pixels and burn another disc.
- Total number of files and folders on the disc should be less than 650.
- Some disc may be incompatible due to different recording format or condition of disc.
- When you are using software such as “Easy CD Creator” to burn the jpeg files into the CD-R, ensure that all the selected files have the “.jpg” extensions when copying into the CD layout.
- If the files have “.jpe” or “.jpeg” extensions, please rename them as “.jpg” files.
- File names without “.jpg” extension will not be able to be read by this DVD player. Even though the files are shown as JPEG image files in windows explorer.

#### **⚠** Caution

- If you record a disc using a personal computer, even if it is recorded in a compatible format, there are cases in which it may not play because of the settings of the application software used to create the disc. (Check with the software publisher for more detailed information.)

## Programmed Playback **CD** **VCD2.0** **VCD1.1** **MP3** **WMA**

The Program function enables you to store your favorite tracks from any disc in the player memory.

Program can contain 30 tracks.

### Programmed Playback with Audio CD

- 1 Press **PROGRAM** during playback or in the stop mode to enter the Program Edit mode.

The  mark will appear to the right of the word Program on the right side of the menu screen.

#### Note

Press **PROGRAM** to exit the Program Edit mode.

The  mark will disappear.

- 2 Move to the Disc number selection column by pressing **▲** repeatedly.
- 3 Select an audio disc number using **◀▶**.
- 4 Select a track, then press **SELECT/ENTER** to place the selected track on the Program list.

#### Note

You must select a disc number of audio CD.

If selected track is other kind of disc (DVD or MP3 etc.), the track skips during programmed playback.

- 5 Repeat steps 2-4 to place additional tracks on the Program list.

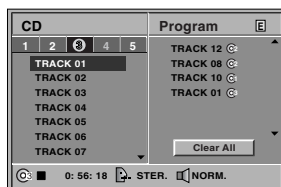

Audio CD menu

- 6 Press **▶**.  
The programmed track you selected last is highlighted on the program list.
- 7 Press **▲/▼** to select the track you want to start playing.  
Press **TOP MENU** to move to the next page.  
Press **MENU** to move to the previous page.
- 8 Press **PLAY** to start.  
Playback begins in the order in which you programmed the tracks and "PROG." appears on the menu screen. Playback stops after all of the tracks on the Program list have played once.
- 9 To resume normal playback from programmed playback, select a track of CD list and then press **SELECT/ENTER**.  
"PROG." indicator disappears on the menu screen.

### Programmed Playback with MP3/WMA disc

- 1 Follow step 1 of "Programmed Playback with Audio CD" on left.
- 2 Select a track, then press **SELECT/ENTER** to place the selected track on the Program list.
- 3 Repeat step 2 to place additional tracks on the Program list.

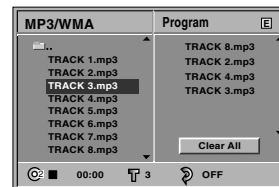

MP3/WMA menu

- 4 Follow steps 6-9 of "Programmed Playback with Audio CD" on left.

### Programmed Playback with Video CD

#### Note

On a Video CD with PBC, you must set PBC to Off on the setup menu to use the Program function. See page 16.

- 1 Insert Video CD and close the tray.
- 2 Press **PROGRAM** while playback is stopped.  
The VCD Program menu will appear.

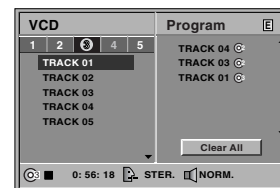

Video CD menu

#### Note

Press **RETURN** or **PROGRAM** to exit the Program menu.

- 3 Follow steps 2-8 of "Programmed Playback with Audio CD" on left.
- 4 To resume normal playback from programmed playback, press **PROGRAM**.  
"PROG." indicator disappears in the display window.

### Repeat Programmed Tracks

- To repeat the track currently playing, press REPEAT.  
The Repeat icon and "TRACK" appears on the menu screen.
- To repeat all tracks on the program list, press REPEAT a second time.  
The Repeat icon and "ALL" appears on the menu screen.
- To cancel Repeat mode, press REPEAT a third time.  
The Repeat icon and "OFF" appears on the menu screen.

### Erasing a Track from Program List

- 1 Press PROGRAM during playback (Audio CD and MP3/WMA disc only) or in the stop mode to enter the Program Edit mode.  
The  mark will appear.
- 2 Press ► to move to the Program list.
- 3 Use ▲▼ to select the track that you wish to erase from the Program list.
- 4 Press CLEAR.  
The track will be erased from the Program list.

### Erasing the Complete Program List

- 1 Follow steps 1-2 of "Erasing a Track from Program List" as above.
- 2 Use ▲▼ to select "Clear All", then press SELECT/ENTER.  
The complete Program for the disc will be erased.  
The programs are also cleared when the disc is removed.

## Additional Information

### Screen Saver

The screen saver picture appears when you leave the DVD Player in stop mode for about five minutes. After the Screen Saver has been engaged for about five minutes, the DVD Player will automatically turn itself off.

### Video Mode Setting

DVD-V DVD-A VCD2.0 VCD1.1

- With certain discs, the playback picture may be flickering or Dot Crawl is shown on straight lines. That means Vertical interpolation or De-interlace is not perfectly matched with the disc. In this case, the picture quality may be improved by changing the video mode.
- To change the video mode, press and hold OSD about 3 seconds during disc playback. The new video mode number selected is displayed on the TV screen. Check whether the video quality has improved. If not, repeat the above procedure until picture quality is improved.
- Video mode change sequence:  
MODE1 → MODE2 → MODE3 → MODE1
- If you turn off the power, the video mode will be back to initial state (MODE1).

### Detailed Descriptions for Video Modes

**MODE1:** The source material of the DVD video (film material or video material) is determined from disc information.

**MODE2:** Suitable for playing film based content or video based material recorded by the progressive scan method.

**MODE3:** Suitable for playing video based content with comparatively little motion.

### Note

The video mode setting only works when the Progressive Scan mode is set to "On" in the Setup menu.

### HDCD Playback

HDCD is a process that increases the fidelity of both specially encoded HDCD discs and standard CD audio discs. When an HDCD-encoded disc is playing, the special decoder is automatically activated and the HDCD Indicator lights. No user intervention is required. To enjoy the benefits of HDCD, your DVD Player must be connected to your A/V receiver via the Analog Audio Outputs. However, if your A/V receiver or surround processor is equipped with built-in HDCD decoding, you may also use a Coaxial or Optical digital audio connection so that the HDCD processing is done there. (see "Sound", page 16)

### Setting Remote control codes of DVD player

- This DVD player support two remote control codes : C004 and C044.
- When the unit is shipped from the factory, the remote code is set to C004.
- To set the code of the player to C044, press PAUSE then input "9872" using number buttons.
- To set the code of the player to C004, press PAUSE then input "9871" using number buttons.
- You can change the code of the player only when NO DISC appears in the display window.
- Changed Remote control codes is displayed in the Display window.
- Set the remote control codes of the Remote control to the same setting (page 8).

### Notes

- This setting can not be used if a disc is playing.
- If a DVD has been loaded, be sure to press STOP twice before proceeding.

## Troubleshooting

Check the following guide for the possible cause of a problem before contacting service.

Symptom	Cause	Correction
No power.	<ul style="list-style-type: none"> <li>The power cord is disconnected.</li> </ul>	<ul style="list-style-type: none"> <li>Plug the power cord into the wall outlet securely.</li> </ul>
The power is on, but the DVD player does not work.	<ul style="list-style-type: none"> <li>No disc is inserted.</li> </ul>	<ul style="list-style-type: none"> <li>Insert a disc. (Check that the DVD or, audio CD indicator in the display window is lit.)</li> </ul>
No picture.	<ul style="list-style-type: none"> <li>The TV is not set to receive DVD signal output.</li> </ul>	<ul style="list-style-type: none"> <li>Select the appropriate video input mode on the TV so the picture from the DVD player appears on the TV screen.</li> </ul>
	<ul style="list-style-type: none"> <li>The video cable is not connected securely.</li> </ul>	<ul style="list-style-type: none"> <li>Connect the video cable securely.</li> </ul>
	<ul style="list-style-type: none"> <li>The connected TV power is turned off.</li> </ul>	<ul style="list-style-type: none"> <li>Turn on the TV.</li> </ul>
No sound.	<ul style="list-style-type: none"> <li>The equipment connected with the audio cable is not set to receive DVD signal output.</li> </ul>	<ul style="list-style-type: none"> <li>Select the correct input mode of the audio receiver so you can listen to the sound from the DVD player.</li> </ul>
	<ul style="list-style-type: none"> <li>The audio cables are not connected securely.</li> </ul>	<ul style="list-style-type: none"> <li>Connect the audio cable securely.</li> </ul>
	<ul style="list-style-type: none"> <li>The power of the equipment connected with the audio cable is turned off.</li> </ul>	<ul style="list-style-type: none"> <li>Turn on the equipment connected with the audio cable.</li> </ul>
	<ul style="list-style-type: none"> <li>The Digital Audio Output is set to the wrong position.</li> </ul>	<ul style="list-style-type: none"> <li>Set the Digital Audio Output to the correct position, then turn on the DVD player again by pressing POWER.</li> </ul>
The playback picture is poor.	<ul style="list-style-type: none"> <li>The disc is dirty.</li> </ul>	<ul style="list-style-type: none"> <li>Clean the disc.</li> </ul>
The DVD player does not start playback.	<ul style="list-style-type: none"> <li>No disc is inserted.</li> </ul>	<ul style="list-style-type: none"> <li>Insert a disc. (Check that the DVD, or audio CD indicator in the DVD display is lit.)</li> </ul>
	<ul style="list-style-type: none"> <li>An unplayable disc is inserted.</li> </ul>	<ul style="list-style-type: none"> <li>Insert a playable disc. (Check the disc type, color system, and Regional code.)</li> </ul>
	<ul style="list-style-type: none"> <li>The disc is placed upside down.</li> </ul>	<ul style="list-style-type: none"> <li>Place the disc with the playback side down.</li> </ul>
	<ul style="list-style-type: none"> <li>The disc is not placed within the guide.</li> </ul>	<ul style="list-style-type: none"> <li>Place the disc on the disc tray correctly inside the guide.</li> </ul>
	<ul style="list-style-type: none"> <li>The disc is dirty.</li> </ul>	<ul style="list-style-type: none"> <li>Clean the disc.</li> </ul>
	<ul style="list-style-type: none"> <li>The Rating level is set.</li> </ul>	<ul style="list-style-type: none"> <li>Cancel the Rating function or change the rating level.</li> </ul>
The remote control does not work properly.	<ul style="list-style-type: none"> <li>The remote control is not pointed at the remote sensor of the DVD player.</li> </ul>	<ul style="list-style-type: none"> <li>Point the remote control at the remote sensor of the DVD player.</li> </ul>
	<ul style="list-style-type: none"> <li>The remote control is too far from the DVD player.</li> </ul>	<ul style="list-style-type: none"> <li>Operate the remote control within 16 ft (5 m).</li> </ul>
	<ul style="list-style-type: none"> <li>There is an obstacle in the path of the remote control and the DVD player.</li> </ul>	<ul style="list-style-type: none"> <li>Remove the obstacle.</li> </ul>
	<ul style="list-style-type: none"> <li>The batteries in the remote control are exhausted.</li> </ul>	<ul style="list-style-type: none"> <li>Replace the batteries with new ones.</li> </ul>
	<ul style="list-style-type: none"> <li>Remote control code is different between the DVD player and Remote control.</li> </ul>	<ul style="list-style-type: none"> <li>Set the remote control codes of both DVD player and Remote control to the same setting.</li> </ul>

## Speaker Settings

Make the following settings for the built-in 5.1 channel surround decoder.

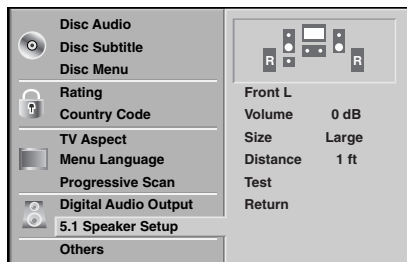

- 1** Select “5.1 Speaker Setup” using the ▲/▼ buttons on the setup menu.
- 2** While “5.1 Speaker Setup” is selected, press ► button.
- 3** Press ◀/▶ buttons to select the desired speaker.
- 4** Adjust options by using ◀▶/▲▼ buttons.

### Speaker selection

Select a speaker that you want to adjust. (Front speakers (Left), Front speakers (Right), Center Speaker, Rear speakers (Left), Rear speakers (Right), or Subwoofer)

### Volume

Press ◀/▶ to adjust the output level of the selected speaker. (-10dB - 0dB)

### Size

- Press ◀/▶ to set a mode. (Large, Small or None)
- If you have connected the system to a speaker with a low frequency of 100Hz or below, select “Large.”
- If you have connected the system to a speaker without a low frequency of 100Hz or below, select “Small.” If you have not connected a subwoofer, always select “Large” for Front speaker (L/R).
- When you do not have a certain speaker connected, select “None.”
- Front L/R speaker’s size can be set to “Large” or “Small.”
- If Front L/R speaker’s size is set to “Small,” Rear and Center speaker’s size can be set to “Small” or “None.”
- Subwoofer’s size can be set only to “Large” or “None”.

### Distance

If you connected speakers to your DVD Player, setting the Distance lets the speakers know how far the sound has to travel to reach your set listening point. This allows the sound from each speaker to reach the listener at the same time. (1 ft = 30.48 cm)

### Test

Press SELECT/ENTER to test the signals of each speaker. Adjust the volume to match the volume of test signals memorized in the system.

- Front Left (L) → Center → Front Right (R)  
→ Rear Right (R) → Rear Left (L)

### Return

Press SELECT/ENTER to return to the previous menu.

## Language Code List

Enter the appropriate code number for the initial settings "Disc Audio", "Disc Subtitle" and/or "Disc Menu" (See page 15).

Code	Language	Code	Language	Code	Language	Code	Language
6566	Abkhazian	7074	Fiji	7678	Lingala	8373	Singhalese
6565	Afar	7073	Finnish	7684	Lithuanian	8375	Slovak
6570	Afrikaans	7082	French	7775	Macedonian	8376	Slovenian
8381	Albanian	7089	Frisian	7771	Malagasy	8379	Somali
6577	Ameharic	7176	Galician	7783	Malay	6983	Spanish
6582	Arabic	7565	Georgian	7776	Malayalam	8385	Sudanese
7289	Armenian	6869	German	7784	Maltese	8387	Swahili
6583	Assamese	6976	Greek	7773	Maori	8386	Swedish
6588	Aymara	7576	Greenlandic	7782	Marathi	8476	Tagalog
6590	Azerbaijani	7178	Guarani	7779	Moldavian	8471	Tajik
6665	Bashkir	7185	Gujarati	7778	Mongolian	8465	Tamil
6985	Basque	7265	Hausa	7865	Nauru	8484	Tatar
6678	Bengali; Bangla	7387	Hebrew	7869	Nepali	8469	Telugu
6890	Bhutani	7273	Hindi	7879	Norwegian	8472	Thai
6672	Bihari	7285	Hungarian	7982	Oriya	6679	Tibetan
6682	Breton	7383	Icelandic	8065	Panjabi	8473	Tigrinya
6671	Bulgarian	7378	Indonesian	8083	Pashto, Pushto	8479	Tonga
7789	Burmese	7365	Interlingua	7065	Persian	8482	Turkish
6669	Byelorussian	7165	Irish	8076	Polish	8475	Turkmen
7577	Cambodian	7384	Italian	8084	Portuguese	8487	Twi
6765	Catalan	7465	Japanese	8185	Quechua	8575	Ukrainian
9072	Chinese	7487	Javanese	8277	Rhaeto-Romance	8582	Urdu
6779	Corsican	7578	Kannada	8279	Rumanian	8590	Uzbek
7282	Croatian	7583	Kashmiri	8285	Russian	8673	Vietnamese
6783	Czech	7575	Kazakh	8377	Samoan	8679	Volapük
6865	Danish	7589	Kirghiz	8365	Sanskrit	6789	Welsh
7876	Dutch	7579	Korean	7168	Scots Gaelic	8779	Wolof
6978	English	7585	Kurdish	8382	Serbian	8872	Xhosa
6979	Esperanto	7679	Laothian	8372	Serbo-Croatian	7473	Yiddish
6984	Estonian	7665	Latin	8378	Shona	8979	Yoruba
7079	Faroese	7686	Latvian, Lettish	8368	Sindhi	9085	Zulu

## Country Code List

Enter the appropriate code number for the initial setting "Country Code" (See page 17).

Code	Country	Code	Country	Code	Country	Code	Country
AD	Andorra	ER	Eritrea	LC	Saint Lucia	SC	Seychelles
AE	United Arab Emirates	ES	Spain	LI	Liechtenstein	SD	Sudan
AF	Afghanistan	ET	Ethiopia	LK	Sri Lanka	SE	Sweden
AG	Antigua and Barbuda	FI	Finland	LR	Liberia	SG	Singapore
AI	Anguilla	FJ	Fiji	LS	Lesotho	SH	Saint Helena
AL	Albania	FK	Falkland Islands	LT	Lithuania	SI	Slovenia
AM	Armenia	FM	Micronesia	LU	Luxembourg	SJ	Svalbard and Jan Mayen Islands
AN	Netherlands Antilles	FO	Faroe Islands	LV	Latvia	SK	Slovak Republic
AO	Angola	FR	France	LY	Libya	SL	Sierra Leone
AQ	Antarctica	FX	France (European Territory)	MA	Morocco	SM	San Marino
AR	Argentina	GA	Gabon	MC	Monaco	SN	Senegal
AS	American Samoa	GB	Great Britain	MD	Moldavia	SO	Somalia
AT	Austria	GD	Grenada	MG	Madagascar	SR	Suriname
AU	Australia	GE	Georgia	MH	Marshall Islands	ST	Saint Tome and Principe
AW	Aruba	GF	French Guyana	MK	Macedonia	SU	Former USSR
AZ	Azerbaijan	GH	Ghana	ML	Mali	SV	El Salvador
BA	Bosnia-Herzegovina	GI	Gibraltar	MM	Myanmar	SY	Syria
BB	Barbados	GL	Greenland	MN	Mongolia	SZ	Swaziland
BD	Bangladesh	GM	Gambia	MO	Macau	TC	Turks and Caicos Islands
BE	Belgium	GN	Guinea	MP	Northern Mariana Islands	TD	Chad
BF	Burkina Faso	GP	Guadeloupe (French)	MQ	Martinique (French)	TF	French Southern Territories
BG	Bulgaria	GQ	Equatorial Guinea	MR	Mauritania	TG	Togo
BH	Bahrain	GR	Greece	MS	Montserrat	TH	Thailand
BI	Burundi	GS	S. Georgia & S. Sandwich Isls.	MT	Malta	TJ	Tadjikistan
BJ	Benin	GT	Guatemala	MU	Mauritius	TK	Tokelau
BM	Bermuda	GU	Guam (USA)	MV	Maldives	TM	Turkmenistan
BN	Brunei Darussalam	GW	Guinea Bissau	MX	Mexico	TN	Tunisia
BO	Bolivia	GY	Guyana	MY	Malaysia	TO	Tonga
BR	Brazil	HK	Hong Kong	MZ	Mozambique	TP	East Timor
BS	Bahamas	HM	Heard and McDonald Islands	NA	Namibia	TR	Turkey
BT	Bhutan	HN	Honduras	NC	New Caledonia (French)	TT	Trinidad and Tobago
BV	Bouvet Island	HR	Croatia	NE	Niger	TV	Tuvalu
BW	Botswana	HT	Haiti	NF	Norfolk Island	TW	Taiwan
BY	Belarus	HU	Hungary	NG	Nigeria	TZ	Tanzania
BZ	Belize	ID	Indonesia	NI	Nicaragua	UA	Ukraine
CA	Canada	IE	Ireland	NL	Netherlands	UG	Uganda
CC	Cocos (Keeling) Islands	IL	Israel	NO	Norway	UK	United Kingdom
CF	Central African Republic	IN	India	NP	Nepal	UM	USA Minor Outlying Islands
CG	Congo	IO	British Indian Ocean Territory	NR	Nauru	US	United States
CH	Switzerland	IQ	Iraq	NU	Niue	UY	Uruguay
CI	Ivory Coast	IR	Iran	NZ	New Zealand	UZ	Uzbekistan
CK	Cook Islands	IS	Iceland	OM	Oman	VA	Vatican City State
CL	Chile	IT	Italy	PA	Panama	VC	Saint Vincent & Grenadines
CM	Cameroon	JM	Jamaica	PE	Peru	VE	Venezuela
CN	China	JO	Jordan	PF	Polynesia (French)	VG	Virgin Islands (British)
CO	Colombia	JP	Japan	PG	Papua New Guinea	VI	Virgin Islands (USA)
CR	Costa Rica	KE	Kenya	PH	Philippines	VN	Vietnam
CS	Former Czechoslovakia	KG	Kyrgyzstan	PK	Pakistan	VU	Vanuatu
CU	Cuba	KH	Cambodia	PL	Poland	WF	Wallis and Futuna Islands
CV	Cape Verde	KI	Kiribati	PM	Saint Pierre and Miquelon	WS	Samoa
CX	Christmas Island	KM	Comoros	PN	Pitcairn Island	YE	Yemen
CY	Cyprus	KN	Saint Kitts & Nevis Anguilla	PR	Puerto Rico	YT	Mayotte
CZ	Czech Republic	KP	North Korea	PT	Portugal	YU	Yugoslavia
DE	Germany	KR	South Korea	PW	Palau	ZA	South Africa
DJ	Djibouti	KW	Kuwait	PY	Paraguay	ZM	Zambia
DK	Denmark	KY	Cayman Islands	QA	Qatar	ZR	Zaire
DM	Dominica	KZ	Kazakhstan	RE	Reunion (French)	ZW	Zimbabwe
DO	Dominican Republic	LA	Laos	RO	Romania		
DZ	Algeria	LB	Lebanon	RU	Russian Federation		
EC	Ecuador			RW	Rwanda		
EE	Estonia			SA	Saudi Arabia		
EG	Egypt			SB	Solomon Islands		
EH	Western Sahara						



## Specifications

### General

Power requirements	AC 120V , 60 Hz
Power consumption	14W
Dimensions (approx.)	17.3 X 3.2 X 16.2 inches (440 X 80 X 410 mm) (w x h x d)
Mass (approx.)	11.2 lbs (5.1 kg)
Operating temperature	5°C to 35°C (41°F to 95°F)
Operating humidity	5 % to 90 %

### System

Laser	Semiconductor laser, wavelength 650 nm
Signal system	NTSC
Frequency response	DVD (DVD Audio 192 kHz): 8 Hz to 88 kHz DVD (PCM 96 kHz): 8 Hz to 44 kHz DVD (PCM 48 kHz): 8 Hz to 22 kHz CD: 8 Hz to 20 kHz
Signal-to-noise ratio	More than 100dB (ANALOG OUT connectors only)
Harmonic distortion	Less than 0.008%
Dynamic range	More than 100 dB (DVD) More than 95 dB (CD)

### Outputs

Video output	1 Vp-p 75 Ω, negative sync, RCA jack x 1
S-Video output	(Y) 1.0 V (p-p), 75 Ω, negative sync, Mini DIN 4-pin x 1 (C) 0.3 V (p-p) 75 Ω
Component Video output	(Y) 1.0 V (p-p), 75 Ω, negative sync, RCA jack x 1 (Cb/Pb)/(Cr/Pr) 0.7 V (p-p), 75 Ω, RCA jack x 2
Audio output (coaxial)	0.5 V (p-p), 75 Ω, RCA jack x 1
Audio output (optical)	Optical connector x 1
Audio output (analog 2ch)	2.0 Vrms , 600 Ω, RCA jack (L, R) x 1
Audio output (analog 5.1ch)	2.0 Vrms , 600 Ω, RCA jack x 6

### Accessories

Video cable	1
Audio cable	1
Remote cable	1
Remote control unit (RC5400VC)	1
Batteries (AAA size)	2
Warranty card (for USA)	1
Warranty card (for CANADA)	1
User Guide	1

- Design and specifications are subject to change without notice.

Manufactured under license from Dolby Laboratories. "Dolby", "Pro Logic", "MLP Lossless", and the double-D symbol are trademarks of Dolby Laboratories.

"DTS" and "DTS Digital Out" are trademarks of Digital Theater Systems, Inc.

**www.marantz.com**

You can find your nearest authorized distributor or dealer on our website.

---

<b>JAPAN</b>	Marantz Japan, Inc.	35-1 Sagami Ohno 7-Chome, Sagamihara-shi, Kanagawa 228-8505, Japan
<b>U.S.A.</b>	Marantz America, Inc.	1100 Maplewood Drive, Itasca, IL 60143, U.S.A.
<b>EUROPE</b>	Marantz Europe B.V.	P.O. Box 8744, 5605 LS Eindhoven, The Netherlands

---

**marantz**<sup>®</sup> is a registered trademark.



P/NO: 3834RS0062R

Printed in China

03/2003 MIT-Ig 31AW851250

## Free Manuals Download Website

<http://myh66.com>

<http://usermanuals.us>

<http://www.somanuals.com>

<http://www.4manuals.cc>

<http://www.manual-lib.com>

<http://www.404manual.com>

<http://www.luxmanual.com>

<http://aubethermostatmanual.com>

Golf course search by state

<http://golfingnear.com>

Email search by domain

<http://emailbydomain.com>

Auto manuals search

<http://auto.somanuals.com>

TV manuals search

<http://tv.somanuals.com>