

CASSETTE HINDED TYPE AIR CONDITIONER INDOOR UNIT



INSTRUCTION MANUAL

Household MRV
Ceiling Concealed Type Room Air Conditioner

AE092FCAHA
AE182FCAHA

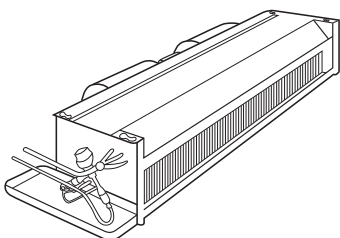

TABLE OF CONTENTS

Before application

Cautions -----	1-2
Part description-----	3-4
Safety precautions-----	5-7

Operating instructions

AUTO, FAN operation -----	8
COOL, DRY, HEAT operation-----	9
TIMER ON/OFF function-----	10
TIMER ON-OFF function-----	11
SLEEP function-----	12

Maintenance

Troubleshooting-----	13-15
Notice to users-----	16

Indoor unit installation

Installation instruction -----	17-18
Installation procedure-----	19-31
Installation check and trial run-----	32

No. 0010570925

A

- please read this manual carefully before use.
- Please keep it attentively.

CAUTIONS

Disposal of the old air conditioner

Before disposing an old air conditioner that goes out of use, please make sure it's inoperative and safe. Unplug the air conditioner in order to avoid the risk of child entrapment.

It must be noticed that air conditioner system contains refrigerants, which require specialized waste disposal. The valuable materials contained in a air conditioner can be recycled. Contact your local waste disposal center for proper disposal of an old air conditioner and contact your local authority or your dealer if you have any question. Please ensure that the pipework of your air conditioner does not get damaged prior to being picked up by the relevant waste disposal center, and contribute to environmental awareness by insisting on an appropriate, anti-pollution method of disposal.

Disposal of the packaging of your new air conditioner

All the packaging materials employed in the package of your new air conditioner may be disposed without any danger to the environment.

The cardboard box may be broken or cut into smaller pieces and given to a waste paper disposal service. The wrapping bag made of polyethylene and the polyethylene foam pads contain no fluorochloric hydrocarbon.

All these valuable materials may be taken to a waste collecting center and used again after adequate recycling.

Consult your local authorities for the name and address of the waste materials collecting centers and waste paper disposal services nearest to your house.

Safety Instructions and Warnings

Before starting the air conditioner, read the information given in the User's Guide carefully. The User's Guide contains very important observations relating to the assembly, operation and maintenance of the air conditioner.

The manufacturer does not accept responsibility for any damages that may arise due to non-observation of the following instruction.

- Damaged air conditioners are not to be put into operation. In case of doubt, consult your supplier.
- Use of the air conditioner is to be carried out in strict compliance with the relative instructions set forth in the User's Guide.
- Installation shall be done by professional people, don't install unit by yourself.
- For the purpose of safety, the air conditioner must be properly grounded in accordance with specifications.
- Always remember to unplug the air conditioner before opening inlet grill. Never unplug your air conditioner by pulling on the power cord. Always grip plug firmly and pull straight out from the outlet.

CAUTIONS

- All electrical repairs must be carried out by qualified electricians. Inadequate repairs may result in a major source of danger for the user of the air conditioner.
- Do not damage any parts of the air conditioner that carry refrigerant by piercing or perforating the air conditioner's tubes with sharp or pointed items, crushing or twisting any tubes, or scraping the coatings off the surfaces. If the refrigerant spurts out and gets into eyes, it may result in serious eye injuries.
- Do not obstruct or cover the ventilation grille of the air conditioner. Do not put fingers or any other things into the inlet/outlet and swing louver.
- Do not allow children to play with the air conditioner. In no case should children be allowed to sit on the outdoor unit.

Specifications

The refrigerating circuit is leak-proof.

The machine is adaptive in following situation

1. Applicable ambient temperature range:

Cooling	Indoor	Maximum: D.B / W.B 32°C/ 23°C Minimum: D.B / W.B 18°C/ 14°C
	Outdoor	Maximum: D.B 43°C/ 26°C Minimum: D.B 15°C
Heating	Indoor	Maximum: D.B 27°C Minimum: D.B 20°C
	Outdoor	Maximum: D.B / W.B 24°C/ 18°C Minimum: D.B / W.B -7°C/ -8°C

2. If the supply cord is damaged, it must be replaced by the manufacturer or its service agent or a similar qualified person.
3. If the fuse on PC board is broken please change it with the type of T. 3.15A /250VAC.

4. The wiring method should be in line with the local wiring standard.
5. The power cable and connecting cable are self-provided.
All the cables shall have got the European authentication certificate.
6. The breaker of the air conditioner should be all-pole switch; and the distance between its two contacts should be no less 3mm. Such means for disconnection must be incorporated in the fixed wiring.
7. The waste battery shall be disposed properly.
8. The indoor unit installation height is at least 2.5m.

AE092FCAHA
AE182FCAHA

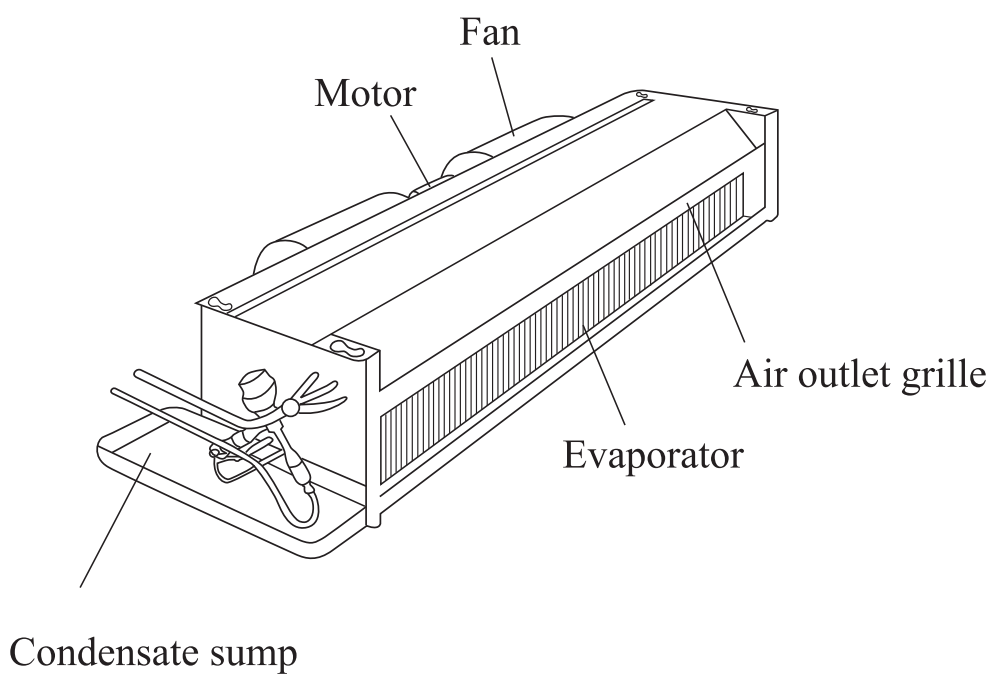

Part description

Remote controller

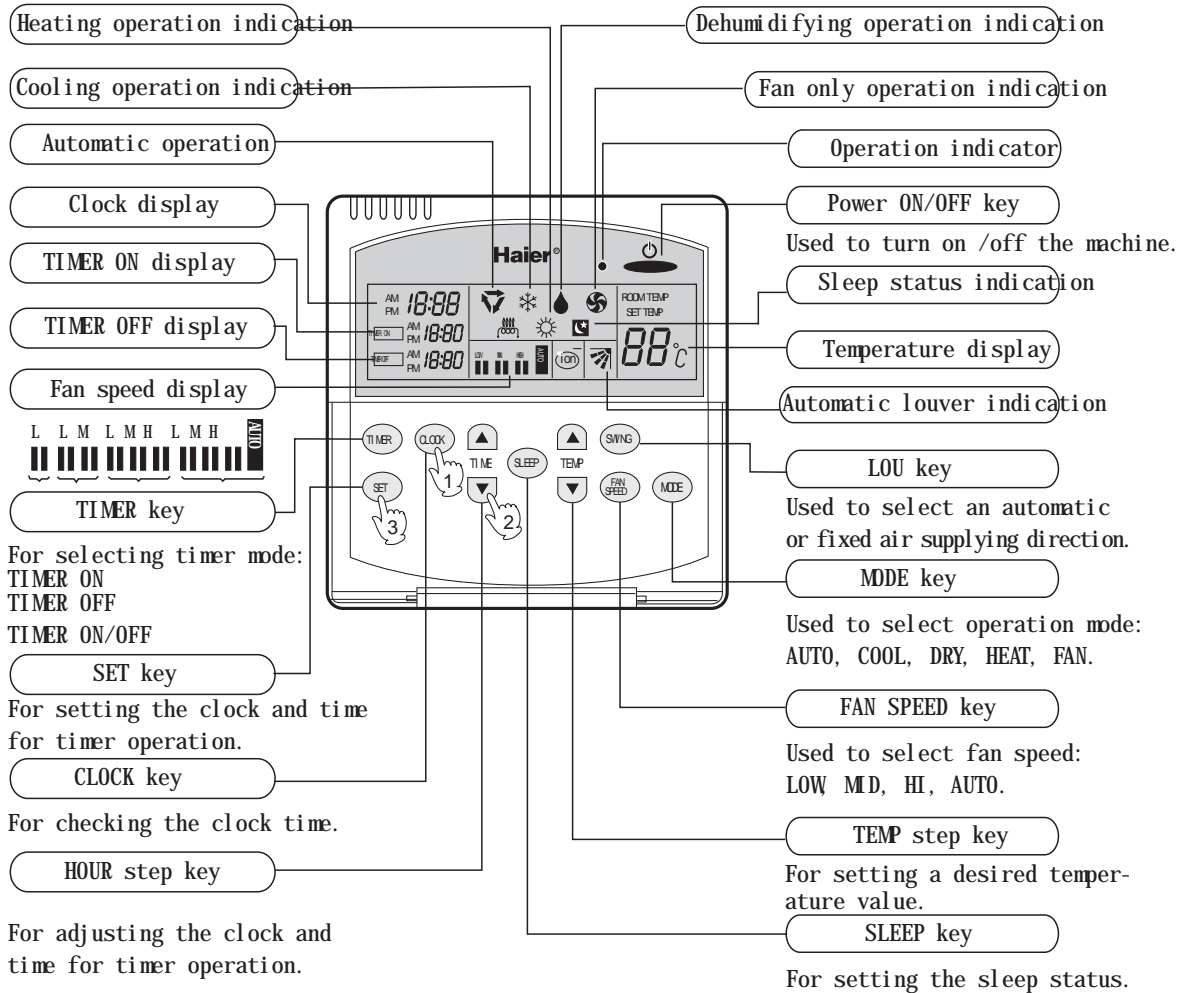

Note: This model of air conditioner doesn't provide the air sending direction adjustment function and thus the "LOU" key is disengaged while the automatic air direction indication may be displayed. This remote controller hasn't electric-aided heating indication as well as anion generation function and indication.





Clock Set

When unit is started for the first time, clock should be adjusted as follows:

1. Press "CLOCK" key, "AM" or "PM" flashes at the clock display area.
2. Press the HOUR "▲" or "▼" key to set correct time. Each press will increase or decrease the time by 1 min. If the key is kept depressed, time will change quickly.
3. After time setting is confirmed, press "SET" key, "AM" or "PM" stop flashing, while clock starts working.

Important Points of Safety





The following four important points of safety and suggestions should be paid great attention:

-  **Warning:** Misuse may cause fatal result such as death or serious injury etc.
-  **Attention:** Misuse may cause human injury or damage of machine, in some case fatal results.
-  : Content marked with this 'forbidden' sign should be absolutely forbidden, otherwise may cause damage of machine and human injury of the user.
-  : Content marked with this 'compulsory' sign should be executed compulsively, otherwise may cause damage of machine and human injury of the user.







Comply with the following important points of safety.



Put these important points of attention and suggestions nearby and convenient for reference in need.

Hand over this instruction manual to new user if you resell this machine.













 Warning	
Warning for installation	<p>1 Entrusted Installation Installation of the machine should be entrusted to certified person of after service. Unauthorized installation may cause water leakage, electric shock or fire hazard for improper operation. </p> <p>1 To prevent leakage of refrigerant, let certified person of after service do it.</p> <p>Leakage of refrigerant over certain consistence may result in shortage of oxygen. Enough precautions MUST be done to avoid oxygen shortage in case of refrigerant leaking if the room where the air-conditioner is installed is small. </p>
	<p>1 The power supply must be fitted with earth line to ensure valid earthing of the air-conditioner. No or incomplete earthing connection may cause the risk of electric shock. </p> <p>1 Test run After indoor units are installed,all cassettes hinded models should be tested.when the units are confirmed to be normal,other fitments can be installed. </p>

Important Points of Safety

 Warning		
Warning for use	<p>1 Avoid your body being blown directly by cold wind for long period, otherwise your health may be affected. </p> <p>1 Don't extend your fingers or any other article into the inlet or outlet during operation of the machine for touching revolving fans may cause human injury or damage of machine. </p>	<p>1 If something abnormal (e.g.: burnt smell etc.) occurs, stop running the machine, shut down the manual power switch and contact after service. Continuous operation in disorder may cause fire hazard or electric shock etc. </p>
Warning for move and repair	<p>1 When you have to disassemble and reinstall the machine, entrust it to after service. Improper installation may cause fire hazard, electric shock or damage of machine. </p>	<p>1 Unauthorized alteration or repair work is strictly forbidden. Improper alteration or maintenance may cause fire hazard, electric shock or water leakage. Repair work should be entrusted to certified person of after service. </p>

 Attention		
Attention points for installation	<p>1 Ensure the drainage hose work normally during installation. Improper installation of drainage can cause water leakage and damp articles. </p> <p>1 DO NOT install the machine in place where flammable gas releases easily to avoid fire hazard.</p>	<p>1 Ensure electric leakage breaker being installed. Electric leakage breaker MUST be installed, otherwise electric shock may be caused. </p> <p>1 If the power supply cord is damaged, call a certified electrician of the manufacturer or other maintenance department to replace it.</p>

Important Points of Safety

Attention		
Attention points for use	<p>* Ensure ventilation of the room if the machine is used with burning facilities. Deficient ventilation can cause oxygen shortage.</p> 	<p>* DONÍ T lay any burning facilities in place where winds produced by the machine can reach. Incomplete combustion of burning facility may be caused otherwise.</p> 
	<p>* Check whether installation bench of the machine is damaged after a long period of use. Machine on damaged bench may fall down and cause human injury or other damage.</p> 	<p>* DONÍ T clean the machine with water. Electric shock may occur otherwise.</p> 
	<p>* In place where winds produced by the machine can reach, doní t lay any animals or plants which may be hurt otherwise.</p> 	<p>* DONÍ T put flammable spray articles nearby or spray them to the machine. Fire hazard may occur otherwise.</p> 
	<p>* Doní t put vases containing water or other else on the unit assembly. Otherwise, the machine may be immersed internally and result in bad electric insulation causing electric shock.</p> 	<p>* DONÍ T operate switch with wet hand. Electric shock may occur otherwise.</p> 
	<p>* The is machine CANNOT be used for the purpose of preserving food, animals, plants, precision instruments and artwork etc., which may be destroyed otherwise.</p> 	<p>* Stop operation and shut down manual power switch before cleaning and maintenance.</p> 
	<p>* DONÍ T replace fuse with material other than fuse of proper capacity. Replacing fuse with metal wire or copper etc. can cause fire hazard or other faults.</p> 	<p>* The power supply MUST be of rated voltage and connected with special electrical supply circuit.</p> 

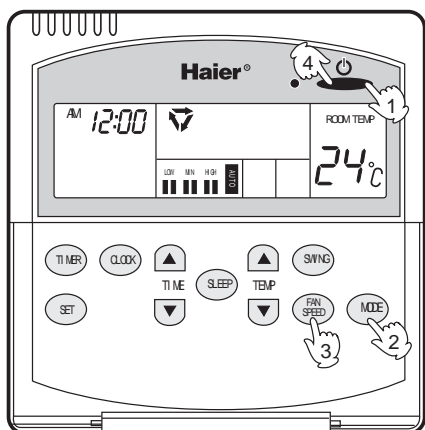

1 Unit start

Press the "ON/OFF" key to turn on the unit.
The LCD on the remote controller displays the previous operating conditions (excluding previous timer, sleep and louver conditions).
The remote controller operation indicator turns on.

2 Select operation mode

Press the "MODE" key to alter the working mode. Each pressing will change the operation mode in the following sequence:



The air conditioner will operate with the displayed tuning mode.

Select AUTO or FAN operation mode, the display will show "AUTO" or "FAN".

3 Fan speed adjustment

Press the "FAN SPEED" key to change the fan speed. Every pressing will change the fan speed in the following sequence:

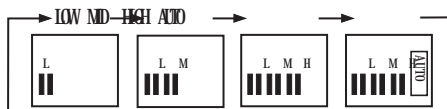

The air conditioner will run at the displayed fan speed.
Note: AUTO fan speed is unavailable in FAN operation mode.

4 Unit stop

Press the "ON/OFF" key to turn off the unit.
The remote controller LCD displays only the clock and room temperature.

Hints:

The remote controller possesses a memory function which could remember the setting conditions in each operation mode. Upon next time of operation, you need only to select the mode and the air conditioner will automatically operate with the previous settings without further adjustment. (Except for the timer, sleep and louver conditions).

Operating instructions

COOL, DRY, HEAT operation

Recommended operation mode:

Please use cooling mode in summer and heating mode in winter.
Please use DRY mode in spring or autumn humid climate.

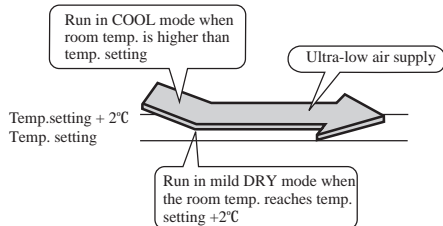
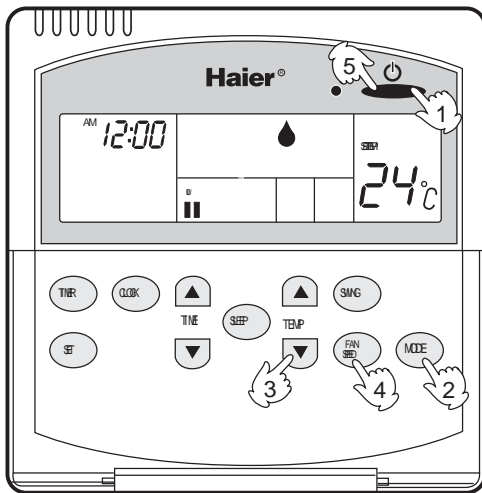

1 Unit start

Press the "ON/OFF" key to turn on the unit.
The ON/OFF remote control displays the previous operating conditions (including previous timer, sleep and louver conditions).
The remote control operation indicator turns on.

2 Select operation mode

Press the "MODE" key to alter the working mode.
Each pressing will change the operation mode in the following sequence:



The air conditioner will operate with the displayed running mode.
Select your desired operation mode by the display stop at the corresponding indication.

3 Select a desired temperature

Press the TEMP setting keys.
Every time pressing the "▲" key, the temperature setting will increase by 1°C.
Every time pressing the "▼" key, the temperature setting will decrease by 1°C.
Set a suitable temperature value.

4 Fan speed selection

Press the "FAN SPEED" key to change the fan speed.
Each pressing will change the fan speed in the following sequence:



The air conditioner will run at the fan speed displayed on the LCD.

In HEAT operation, after unit is turned on, the air conditioner will send out hot air after a short while in order to prevent cold draft.

In DRY operation, when the room temperature decreases to 2°C above temperature setting, the air conditioner will run at low fan speed regardless of the fan speed setting.

5 Unit stop

Press "ON/OFF" key to turn off the unit.

Hints:

The remote controller could remember the setting conditions in each operation mode. Upon next time turning on the unit, you need only to press the "ON/OFF" key and the air conditioner will automatically operate with the previous settings. (Except for the timer, sleep and louver conditions).

Operating instructions

TIMER ON/OFF function

Please adjust the clock before using timer function. You may set the air conditioner automatically turn on or turn off when you wake in the early morning, come off work or after you fall asleep.

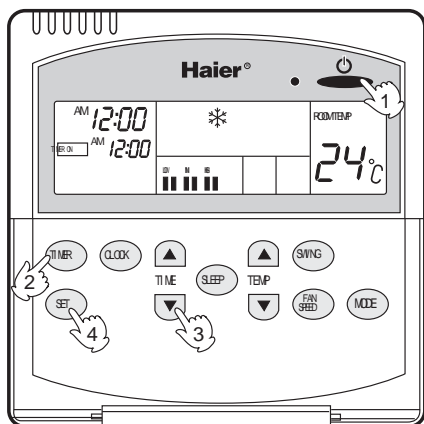

1. Set the operation mode after the unit is turned on.

The operation indicator on the remote controller turns on, and the LCD screen displays the operation mode.

2. Setting the timer mode

Press the "TIMER" key to change timer mode. Each pressing will change the timer mode indication as follows:



Determine a timer mode according to your need subsequently (TIMER ON or TIMER OFF).

The display of TIMER "ON" or TIMER "OFF" now flashes.

3. Set time

Press "TIMER SETTING" step keys.

Every time pressing the "▲" key will increment the time setting by 10 min, while kept pressing will increase quickly.

Every time pressing the "▼" key will decrement the time setting by 10 min, while kept pressing will decrease quickly.

The LCD on the remote controller displays the time setting, which could be freely adjusted within 24 hours.

4. Confirm the setting

After completion of time adjustment, press the "SET" key to confirm the time.

TIMER "ON" or TIMER "OFF" doesn't flash now.

The time display is: Unit starts or stops at x hour x min. (TIMER ON or TIMER OFF).

■ Cancel TIMER mode

Just press "TIMER" key several times until TIMER mode indication disappears.

Hints:

Time should be setting again after a power failure.

The remote controller possesses memory function, when use TIMER mode next time, just press the "SET" key after mode selecting if time setting is the same as previous one.

Operating instructions

TIMER ON-OFF operation

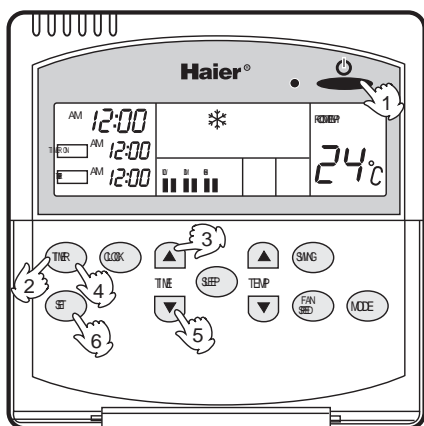

1. After unit starts, select your desired operation mode.

The operation indicator turns on and the operation mode is displayed on the LCD screen.

2. Timer mode selection

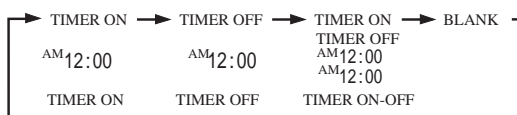

Select **TIMER ON-OFF** mode. **TIMER "ON"** flashes now.

3. Time setting for **TIMER ON**

Press "TIMER SETTING" step keys.

Every time pressing the "▲" key, time setting will increment by 10 min, if kept pressed, it will increase rapidly.

Every time pressing the "▼" key, time setting will decrement by 10 min, if kept pressed, it will decrease rapidly.

The remote controller LCD displays the time setting which could be freely adjusted within 24 hours.

4. Time confirming for **TIMER ON**

After time setting, press the "SET" key to confirm the time.

"TIMER ON" doesn't flash any longer while "TIMER OFF" starts to flash.

Time displayed: Unit starts at x hour x min.

5. Time setting for **TIMER OFF**

Press "TIMER SETTING" step keys, then follow the same procedure in Time setting for **TIMER "ON"**.

6. Time confirming for **TIMER OFF**

After time setting, press "SET" key to confirm.

TIMER "OFF" does not flash any longer.

Time displayed: Unit stops at x hour x min.

■ To cancel **TIMER** mode

- 1 Just press "TIMER" key several times until **TIMER** mode indication disappears.
- 1 According to the time setting sequence of **TIMER ON** and **TIMER OFF**, either Start-Stop or Stop-Start can be achieved.

Operating instructions

SLEEP function

Using SLEEP function

Before using this function, the time must be checked and set. After the unit starts, set the operation status, then press "SLEEP" key.

Before going to bed, you can press the "SLEEP" key on the remote controller and the air conditioner will operate in comfortable SLEEP mode and bring you a sound sleep.

Operation Mode

In COOL/DRY mode

1 hour after SLEEP mode starts, temp. will become 1* higher than temp. setting. After another 1 hour, temp. rises by 1* further. The unit will continue to run for further 6 hours and then automatically stops. The controlled temperature is higher than temperature setting so that room temperature wont be too low for your sleep.

In HEAT mode (unavailable for cool only models)

1 hour after SLEEP mode starts, temp. will become 2* lower than temp. setting. After another 1 hour, temp. decreases by 1* further. This temperature will be maintained for 3 hours before rising by 1*. The unit will continue to run for further 3 hours and then stops automatically. The controlled temperature is lower than temperature setting so that room temperature wont be too high for your sleep.

In AUTO mode

The unit operates in corresponding SLEEP mode adapted to the automatically selected operation mode.

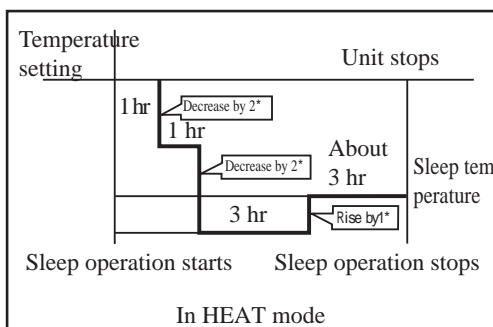
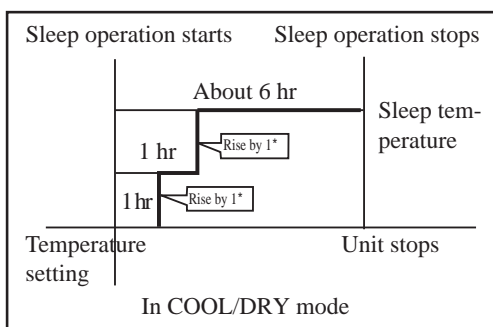
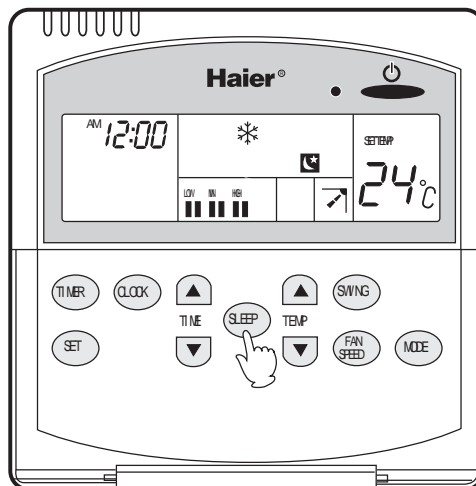

In FAN mode

SLEEP function is not available.



Troubleshooting



The following cases are not troubles.

<p>Water flow sound is heard.</p> <p>"Hua-Hua"</p> 	<p>During operation, the air conditioner may sometimes exhibit a sound of "clatter" or "rumble". This is the common sound of refrigerant flow but not a trouble.</p>
<p>A sound of "Pi-Pa" is generated.</p>	<p>This is caused by the thermal expansion or cold shrinkage of plastics.</p>
<p>Smells are given off.</p>	<p>Sometimes there are smells in the air flow from the indoor unit. This is caused by the smell of cigarettes or paint coatings inside the unit.</p>
<p>During operation, mist or steam are blown out.</p>	<p>During COOL or DRY operation, the unit may blow out a thin mist. This is the condensate water mist caused by sudden cooling of the indoor air blown out from the indoor unit.</p>
<p>During COOL operation, it automatically changes to FAN mode.</p>	<p>In order to prevent frost accumulation on the heat exchanger in the indoor unit, sometimes it will automatically transfers to FAN mode, but soon will return to COOL mode.</p>
<p>The system couldnt be re-started immediately after turning off.The unit can 't start?</p> 	<p>This is due to the systems self-protection function, which prevents it from restarting in 3 min after stops.</p>  <p>Please wait for 3 min.</p>

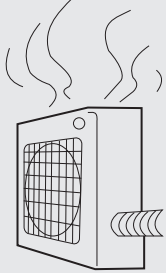
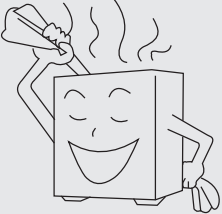
Troubleshooting

<p>During DRY operation, there is no air sent out or fan speed cant be changed.</p>	<p>In DRY operation, when the room temperature reaches 2* higher than temp. setting,the unit will run at "LOW"fan speed regardless of fan speed setting.</p>
<p>In HEAT mode, the outdoor unit generates water or steam.</p> 	<p>This occurs during removal of the frost (in defrosting operation) on the radiator of outdoor unit.</p>  <p>Defrost operation</p>
<p>In HEAT mode, the indoor fan still keeps running even the unit operation stops.</p>	<p>After the unit stops, the indoor fan will continue to run for a while to eliminate residual heat.</p>

Before asking for after-service to an authorized service center, please check your air conditioner for the following items



The system couldnt start		
<p>Is power on/off switched on?</p>  <p>The power on/off switch is not at position of "ON".</p>	<p>Is the power supply line normal?</p>  <p>Power failure?</p>	<p>Is current leakage breaker triggered?</p> <p>Please do immediately cut off power supply and contact the authorized service center.</p>

When fault occurs

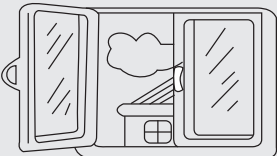
Poor cooling or heating

<p>Is the operation controller adjusted as required?</p>	<p>Are there any obstructs before the air inlet or outlet?</p>	<p>Is there any door or window left open?</p> 
--	--	--

Poor cooling

<p>Is there any other heat source in the room?</p> 	<p>Is there any direct sunlight into the room?</p> 	<p>Are there too many people in the room?</p> 
--	--	--

If, after the above checks and the corresponding corrective actions, the system remains abnormal operation, or the following facts appear, please turn off the air conditioner and then contact the local authorized service center.

- 1 Frequent open of fuse or breaker.
- 1 There is water leakage during COOL or DRY operation.
- 1 The operation is abnormal or abnormal sound is heard.

Notice to users

Notice to users

- 1 To ensure proper operation of the system, the user shall follow this instruction manual to install the unit.
- 1 When handling the air conditioner, please be care not to scratch the case surface.
- 1 This instruction manual describes the installation method aided with the installation tools specified by Qingdao Haier Air Conditioner Electronics Com., Ltd.
- 1 The maximum length of connection pipe is 50 m, and the maximum difference between levels of indoor unit and outdoor unit shall be 30 m.
- 1 Please keep the installation instruction manual well for reference in maintenance or changing installation position.
After installed, please follow the operational instruction manual to use the air conditioner properly.

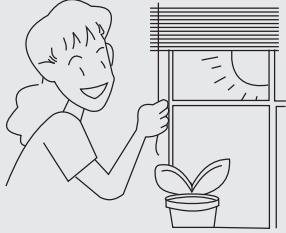
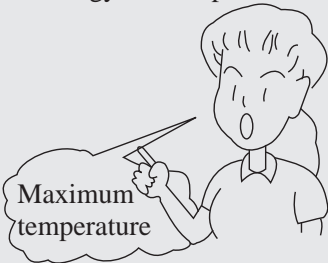
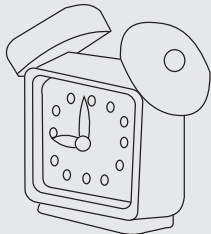
Information about application	
<p>Adjust your desired air flow direction</p> 	<p>Avoid direct sunlight and gas flow</p> 
<p>Keep appropriate room temperature Too cool or too warm wont benefit to your health, but causes an increased energy consumption.</p> 	<p>Effectively use the timer Using TIMER mode you can enjoy a comfortable room temperature when wake up or come back home.</p> 

Caution: After installation, please confirm no refrigerant leaks.

Installation precautions

- Before installing, do read this "Safety precautions" carefully to guarantee the proper installation.
- The below attentive matters are divided into "⚠ Warning" and "⚠ Note" two parts. When the wrong installation occur, it is very possible death and severe injury and other serious accidents will happen. For those items are listed in "⚠ Warning" part. But even the items listed in "⚠ Note" part can also cause serious accidents. Above all, both the two parts are very important contents related to safety, so they must be obeyed.
- After finishing the installation work, do test run to verify everything is normal. After that please explain the using and maintenance methods to the user. Additionally, give this installation manual and operation manual to the user and ask them to keep it properly.

⚠ Warning

- The distributing shop, where you bought the air conditioner, or the specified shops shall do the installation work. If you do the installation work by yourself, the improper installation will cause water leakage, electric shock fire and other accidents.
- The installation work shall be in line with what the installation manual specified. If installation is not proper, water leakage, electric shock, fire and other accidents will occur.
- Install the air conditioner to a place where can definitely stand its weight. Places not firm enough will cause drop down of unit resulting in body hurt.
- The installation work shall be preventive to typhoon and earthquake. If the installation work is not met with the requirements, overturn of the unit will occur resulting in accidents.
- The wiring work shall be done by a qualified person and referred to the "technical standard of electric equipment", "indoor wiring regulation" and what the manual specified. Do use special circuit. If the capacity of the circuit is not enough or bad work, electric shock, fire and other accidents will happen.
- Using the specified cable to do wiring work and connecting firmly and properly. Fix the connecting part of the terminals to prevent it from the external force. Improper connection and fixing will cause heating and fire etc. accidents.
- Wiring shall be kept in correct shape avoiding extrusion. After installation, the electric box cover and the external panel shall not nip the wire. Improper installation will cause heating and fire etc. accidents.
- When setting or moving the air conditioner do not let the air and things alike get into the refrigeration system except the specified refrigerant (R22). If air and other things enter, abnormal high pressure will occur, which easily cause break and body injuries etc. Accidents.
- When installing, do use the accessories or specified parts. If not using the parts specified by our company, water leakage, electric shock, fire and refrigerant leakage will occur.
- Do not lead the drain pipe to drain where the sulfur gas may be involved. Otherwise, the poisonous gas will enter into the indoor.
- During installation, if refrigerant leakage occurs, do the ventilation work immediately. As soon as the refrigerant gas meets fire, poisonous gas will be produced. If the refrigerant gas enters into room and meet the air blowing heater, heater or stove etc. fire source, the poisonous gas may be produced. After installation, confirm there is no leakage of refrigerant.
- Do not install the unit in a place where the combustible gas may be leaked. In any case the combustible gas leaks and accumulated around the unit, fire accident will occur.
- Do heat insulation work to the refrigerant gas pipes and liquid pipes to reach the purpose of heat preservation. If the heat insulation measure is not sufficient, water generated by condensing dew will drip leading to wet the floor and indoor articles.

⚠ Note

- Do grounding work. Do not connect the grounding wire to gas pipe, tap, lighting rod or telephone line. Improper grounding will cause electric shock.
- After electric installation, power on them to do electric leakage test.

Installation precautions

Attention

This description does not address to all possible cases. For new requirement and query, please consult the regional sales center of Haier Air Conditioner General Co., Ltd.

Warning

This instruction manual must be read carefully before beginning of installation, improper installation may cause accidents and thus bring about machine damage and personal casualty.

Installing tools

- | | | |
|--------------------------------|------------------|------------------------------------|
| 1. Screw driver | 6. Pipe cutter | 10. Leakage detector or soap water |
| 2. Hacksaw | 7. Pipe expander | 11. Measuring tape |
| 3. Driller of 70mm diameter | 8. Knife | 12. Scraper |
| 4. Spanner (diameter 17, 27mm) | 9. Pinchers | 13. Refrigeration oil |
| 5. Spanner (14, 17, 19, 27mm) | | |

Installation procedure

Electrical requirements

- 1 The power supply shall be connected from the outdoor side. (For models with electric-aided heating function, the power supply to the indoor unit shall be connected at the indoor side. The power cord size is $3 \times (1.25-1.5) \text{mm}^2$, type of YZW).
- 1 A separate power circuit shall be supplied and connected by a qualified electrician according to the wiring rules specified in the corresponding national standard.
- 1 A current leakage breaker must be installed.
- 1 The connection method of power cord is "Y" type. If the power flexible cord is damaged, it shall be replaced by the manufacturer or its service department or similar qualified technician so as to avoid risks.
- 1 Power cord plug: L should be connected to the live wire, N should be connected to the neutral wire and \ominus to the ground wire.
- 1 Connection wire size: $3 \times (1.25-1.5) \text{mm}^2$, type of YZW.
- 1 Signal transmission wire size: $2 \times (0.75-1.25) \text{mm}^2$ (shielded wire).
- 1 Power cord, connection wire and signal wire shall be provided by the user.

Pipe expansion dimensions as follows:

Specification	Pipe diameter φ	Size A (mm)
Liquid pipe	6.35 mm (1/4")	0.8 ~ 1.5
Liquid pipe	9.52 mm (3/8")	1.0 ~ 1.8
Gas pipe	12.7 mm (1/2")	1.2 ~ 2.0
Gas pipe	15.88 mm (5/8")	1.4 ~ 2.2

Pipe cutting and expanding

If the pipe is too long or the flare is damaged, it needs to be cut or expanded.

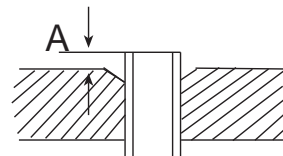

Pipe expander

1. Pipe cutting
2. Removing burrs

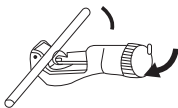

3. Insertion nut
4. Pipe expansion



Correct	Incorrect				
	Slope	Damage	Bur	Partial	Overlong

Installation procedure

Choosing the installation location

Caution

- Please do not install the unit in places where flammable gases may be leaked. In case that gas is leaked and accumulated around the unit, it may cause dangers of fire etc.

The indoor unit shall be installed at locations where cold and hot air could evenly circulated. The following locations should be avoided:

- 1 Places with rich saline matters (seaside regions).
- 1 Places with plenty of gas sulfides (mainly in warm spring areas where the copper tube and braze weld is prone to corrosion).
- 1 Locations with much oil (including mechanical oil) and steam.
- 1 Locations using organic solvents.
- 1 Places where there are machines generating HF electromagnetic waves.
- 1 Positions adjacent to door or window in contact with high-humidity external air. (Easy to generate dew).
- 1 Locations frequently using special aerosols.

Indoor unit

1. Select suitable places the outlet air can be sent to the entire room, and convenient to lay out the connection pipe, connection wire and the drainage pipe to outdoor.
2. The ceiling structure must be strong enough to support the unit weight.
3. The connecting pipe, drain pipe and connection wire shall be able to go through the building wall to connect between the indoor and outdoor units.
4. The connecting pipe between the indoor and outdoor units as well as the drain pipe shall be as short as possible. (See Figure 1)
5. If its necessary to adjust the filling amount of the refrigerant, please refer to the installation manual attached with the outdoor unit.
6. The connecting flange should be provided by the user himself.

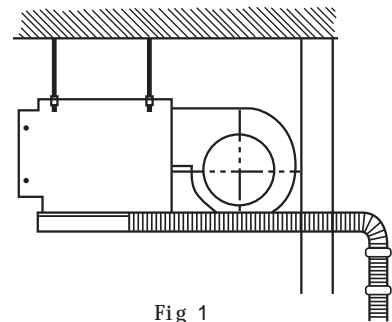

Important

An access port must be provided during installation of indoor unit for maintenance.

Warning

- | | |
|---|--|
| 1 The unit shall be installed at locations enough to support the unit. If not, the air conditioner may fall down and cause personal injury. | 1 The unit shall be installed according to the specifications to resist to strong wind and earthquake. Improper installation may cause dangers of unit falling down etc. |
|---|--|

After selecting the unit installation location, proceed the following steps:

1. Drill a hole in the wall and insert the connecting pipe and wire through a PVC wall-through tube purchased locally. The wall hole shall be with a outward down slope of at least 1/100. (See Figure 2)
2. Before drilling check that there is no pipe or reinforcing bar just behind the drilling position. Drilling shall avoid at positions with electric wire or pipe.
3. Mount the unit on a strong and horizontal building roof. If the base is not firm, it will cause noise, vibration or leakage (see Figure 6).
4. Support the unit firmly.
5. Change the form of the connection pipe, connection wire and drain pipe so that they can go through the wall hole easily.

Figure showing installation dimensions: (unit:mm)

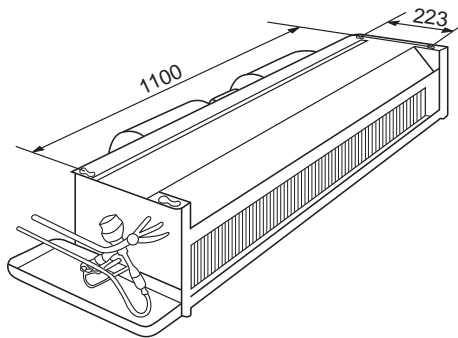

AE182FCAHA

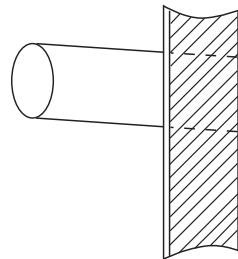
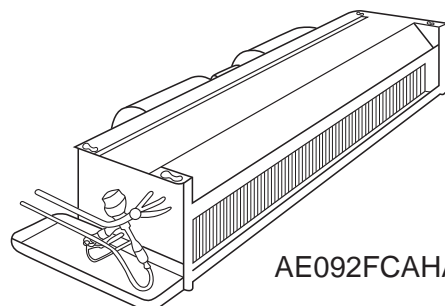

Fig 2



AE092FCAHA

Installation procedure

Installation of indoor unit

- 1 When installing the cassette hind type indoor unit, a specially designed return air bellows shall be installed, as shown in Figure 3, Figure 4.
- 1 The distance between the air duct outlet and the air conditioner air outlet shall not exceed 0.5 m.

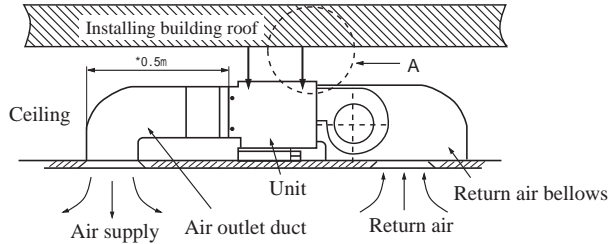

Detail A Figure 3

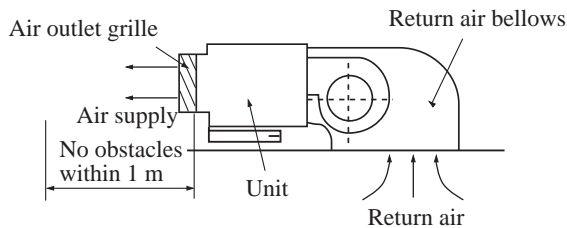

Figure 4

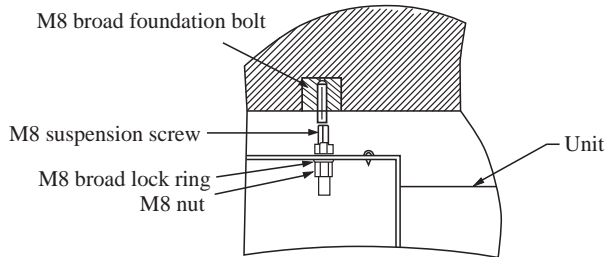

Figure 5

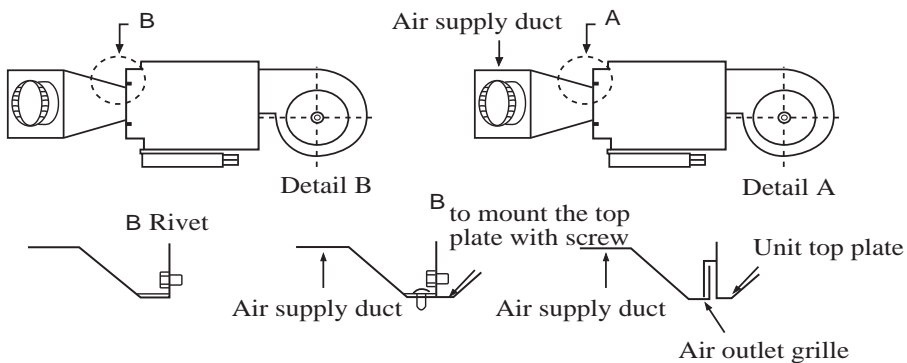

Figure 6

Installation procedure

Installation of indoor unit

Installing the suspension screw:

Use M8 or M10 suspension screws (4, prepared in the field) (when the suspension screw height exceeds 0.9 m, M10 size is the only choice). These screws shall be installed as follows with space adapting to air conditioner overall dimensions according to the original building structures.

Wooden structure

A square wood shall be supported by the beams and then set the suspension screws.

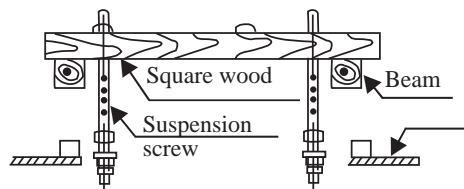

New concrete slab

To set with embedded parts, foundation bolts etc.



Knife embedded part



Guide plate embedded part

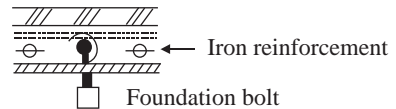

Pipe suspension foundation bolt

Original concrete slab

Use hole hinge, hole plunger or hole bolt.

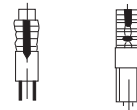

Steel reinforcement structure

Use steel angle or new support steel angle directly.

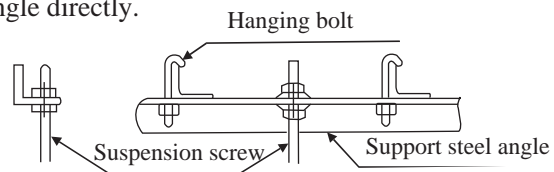

Hanging of the indoor unit

- 1 Fasten the nut on the suspension screw and then hang the suspension screw in the T slot of the suspension part of the unit.
- 1 Aided with a level meter, adjust level of the unit within 5 mm².

Installation procedure

Installation of remote controller

Installation of the remote controller

1. Remove the back cover of the remote controller

Firstly detach the remote controller back cover at the bottom, then detach at the top. The whole back cover of the remote controller could be removed.

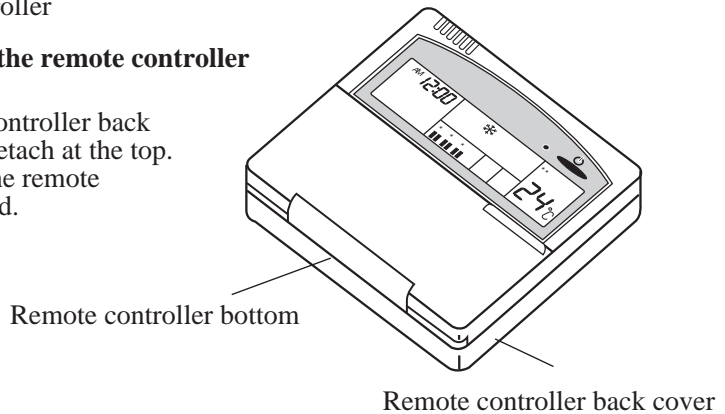

2. Mount the back cover of the remote controller

Drill 3 holes in the wall corresponding to the positions of 3 screw holes in the back cover of the remote controller, subsequently plug a cork into each wall hole. Align the 3 screw holes in the back cover of the remote controller with the corks and then fasten the back cover onto the wall with wooden screws.

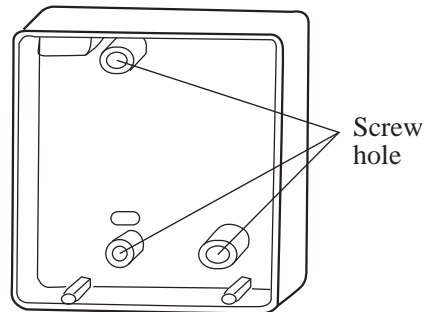

3. Installing the remote controller

Pull the lead cable of the remote controller out of the wire hole in the back cover to a suitable length before fit the remote controller with the back cover at the bottom, and then close at the top.

4. Connecting the lead wires

Connect the lead out terminals of the remote controller with the lead terminals of the indoor unit using remote controller connecting wire.

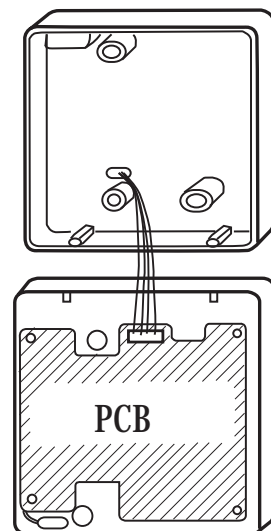

Installation procedure

Drain pipe

⚠ Caution

- In order to drain water normally, the drain pipe shall be processed as specified in the installation manual and shall be thermal insulated to avoid dew generation. Improper hose connection may cause indoor water leakage.

Requirements

- The indoor drain pipe shall be thermal insulated.
- The connection part between the drain pipe and the indoor unit shall be insulated so as to prevent dew generation.
- The drain pipe shall be slant downwards (greater than 1/100). The middle part shall not be of S type elbow, otherwise abnormal sound will be produced.
- The horizontal length of the drain pipe shall be less than 20 m. In case of long pipe, supports shall be provided every 1.5 ~ 2m to prevent wavy form.
- Central piping shall be laid out according to the following figure.
- Take care not to apply external force onto the drain pipe connection part.

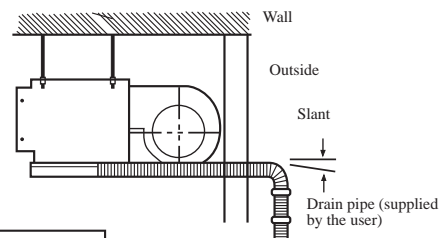
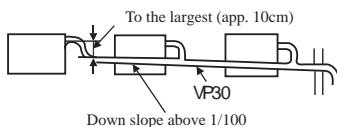
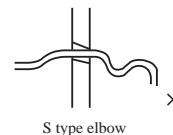
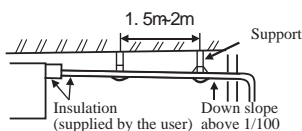

Pipe and insulation material

Pipe	Rigid PVC pipe VP31.5mm (internal diameter)
Insulation	Foamed PE with thickness above 10mm

Hose

Drain pipe size: $\varnothing 19.05\text{mm}^2$ (3/4") PVC pipe

The hose is used for adjusting the off-center and angle of the rigid PVC pipe.

- Directly stretch the hose to install without making any deformation.
- The soft end of the hose must be fastened with a hose clamp.
- Please apply the hose on horizontal part

Insulation treatment:

- Wrap the hose and its clamp until to the indoor unit without any clearance with insulating material, as shown in the figure.

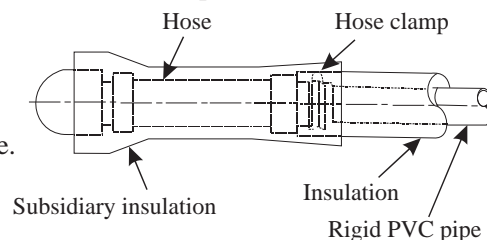

Drain confirmation

During trial run, check that there is no leakage at the pipe connection part during water draining even in winter.

⚠ Caution

- 1 In installation, if there is refrigerant gas leakage, please take ventilation measures immediately. The refrigerant gas will generate poisonous gas upon contacting fire.
- 1 After installation, please verify that there is no refrigerant leakage. The leaked refrigerant gas will produce poisonous gas when meeting fire source such as heater and furnace etc.

Allowable pipe length and drop

These parameters differ according to the outdoor unit. See the instruction manual attached with the outdoor unit for details.

Pipe material and size

Pipe material	Phosphorus deoxidized copper seamless pipe (TP ₂) for air conditioner		
Model		AE092FCAHA	AE182FCAHA
Pipe size (mm)	Gas side	∅ 15.88	∅ 12.70
	Liquid side	∅ 9.52	∅ 6.35

Supplementary refrigerant

The refrigerant supplementation shall be as specified in the installation instructions attached with the outdoor unit. The added refrigerant shall be R407C.

The adding procedure shall be aided with a measuring meter for a specified amount of supplemented refrigerant

Requirement

- 1 Overfilling or underfilling of refrigerant will cause compressor fault. The amount of the added refrigerant shall be as specified in the instructions.

Connection of refrigerant pipe

Conduct flared connection work to connect all refrigerant pipes.

- 1 The connection of indoor unit pipes must use double spanners.
- 1 The installing torque shall be as given in the following table.

Connecting pipe O.D.(mm)	Installing torque (N-m)	Increased installing torque (N-m)
∅ 6.35	11.8 (1.2kgf-m)	13.7 (1.4 kgf-m)
∅ 9.52	24.5 (2.5kgf-m)	29.4 (3.0 kgf-m)
∅ 12.70	49.0 (5.0 kgf-m)	53.9 (5.5 kgf-m)
∅ 15.88	78.4 (8.0 kgf-m)	98.0 (10.0 kgf-m)

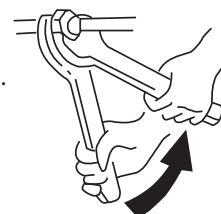

Double-spanner operation

Vacuum pumping

With a vacuum pump, create vacuum from the stop valve of the outdoor unit.

- 1 Emptying with refrigerant sealed in the outdoor unit is absolutely forbidden.

Open all valves

Open all the valves on the outdoor unit.

Gas leakage detection

Check with a leakage detector or soap water that if there is gas leakage at the pipe connections and bonnets.

Insulation treatment



Conduct insulation treatment on both the gas side and liquid side of pipes respectively.

During cooling operation, both the liquid and gas sides are cold and thus shall be insulated so as to avoid dew generation.

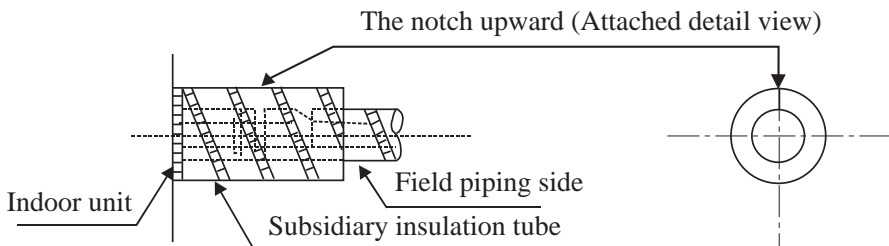
- 1 The insulating material at gas side shall be resistant to a temperature above 120*.
- 1 The indoor unit pipe connection part shall be insulated.



! Warning

- 1 The electric wiring work shall be conducted by qualified electricians according to the installation instructions. A separate power circuit shall be used. Insufficient power cord amperage or improper wiring will cause danger of electric shock or fire. 
- 1 During wiring connection, the power cord shall be of the specified cable and reliably fastened so that external forces applied to the cable wouldnt transfer to the terminals. Improper connection or fastening will cause danger of heating, fire etc. The power cord must be fitted with a grounding wire. 
- 1 Grounding shall be made as specified. Unreliable grounding will cause electric shock. The grounding wire shall not be connected to the gas pipeline, water pipeline, thunder arrestor and telephone wire 

Caution

- 
- 1 A current leakage breaker shall be installed, otherwise it electric shock would happen easily.
 - 1 If the power cord is damaged, it must be replaced by the manufacturer or its service center or similar personnel to avoid risks. The power supply to the indoor unit shall be laid in complying with the operational instruction manual.
 - 1 The electric wiring shall avoid contacting with the high temperature part of the piping so as to prevent the cable insulation melts and cause dangers.
 - 1 After connected on the terminal block, the wires shall be bent to U form and then fastened with wire clip.
 - 1 The control wiring and refrigerant piping may be laid and fastened together.
 - 1 Before completion of vacuum pumping of the refrigerant pipe system, do not electrify the indoor unit.
 - 1 The power cord of the indoor unit and connection wiring between indoor and outdoor units shall be laid out according to the operational instruction manual of the indoor unit.
 - 1 The connection of the power cord shall comply with the local regulations.

Wiring connection method : (the wiring diagram is attached inside the machine)

1) Ring terminal connection method

If there is a ring at the end of the connection wire, the wire connection method is as shown in the right figure. Remove the terminal screw and insert it through the ring at the connection wire end, then connect to the terminal board and fasten the screw.

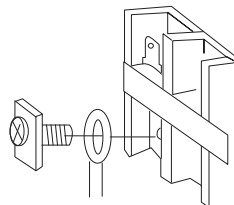

Connection method for ring terminal

2) Straight terminal connection method

If there isn't a ring at the end of the connection wire, the connection method shall be: loosen the terminal screw, insert the connection wire end completely into the terminal board and fasten the screw. Pull the connection wire outwards slightly to confirm it is clamped tightly.

3) Clamping method of the connection wire

After wire connection is finished, the connection wire must be pressed tightly with wire clips, which shall apply to the outer sheath of the connection wire.

Wire connection for built-in indoor unit

- 1 Insert from outside the connection wire and signal transmission wire through the wall hole with pipeline already arranged.
- 1 Pull out the front ends of connection wire and signal wire and make a circle on the signal wire.
- 1 Connect the connection wire according to the connection method and indoor and outdoor wiring diagram.
- 1 Pull the connecting conductor outwards slightly to confirm it is clamped tightly.
- 1 Connect the plug for connecting the signal wire with the plug of the signal wire connected from the indoor unit.
- 1 After wire connection is finished, install wire clips using the same method for connection wire clamping.

Note: When connecting the indoor unit and the outdoor unit, please do not connect the wires with the same color terminals.

Notes:

- 1 Before connecting the conductors between indoor unit and outdoor unit, check for the number on the indoor and outdoor units connecting terminals. Connect the terminals with the same color and number with a wire.
- 1 Wrong connection would damage the controller of the air conditioner or the machine could not operate.
- 1 Do not connect the connection wire and signal wire with the same cable. They shall be connected respectively to ensure system normal operation.

Field setting

Field setting the unit number

In order to realize central control of the MRV air conditioning system, its necessary to set the indoor unit number (control address).

Indoor unit number setting

Indoor unit number setting switch and confirmation of the settings.

There is a 4-position dial switch for setting the indoor unit number on the computer board of the indoor unit.

Setting way is as follows:

Before connecting the power supply, please set the indoor unit number manually according to the following table

Matrix of the dial switch and indoor unit number

Position 1	Position 2	Position 3	Representing unit number
0	0	0	1
1	0	0	2
0	1	0	3
1	1	0	4
0	0	1	5
1	0	1	6

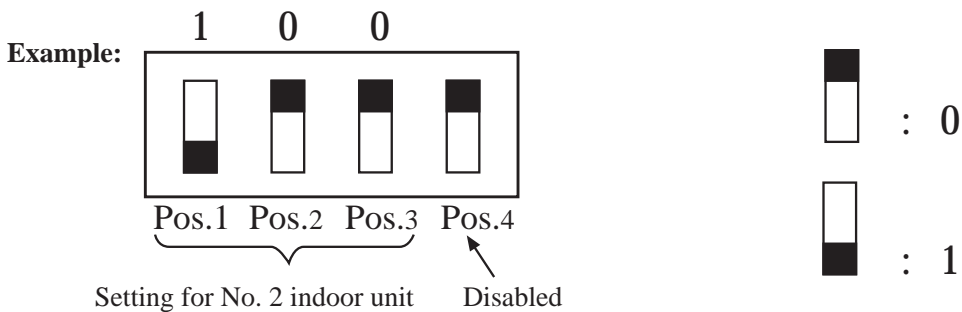

List of troubles

List of displayed troubles on the remote controller

Trouble description	Displayed code
Ambient temperature sensor fault	E1
Indoor unit gas pipe temperature sensor abnormal	E2
Indoor unit and outdoor unit signal transmission abnormal	E3
Faulty communication between indoor unit 846 chip and 808 chip	E5
Indoor unit liquid pipe temperature sensor trouble	E6
Indoor unit and remote controller communication abnormal	E7
Trouble with outdoor unit	E9

List of indicated troubles with outdoor unit (when the remote controller indicates E9, you may check the indoor unit main board LED1 or outdoor unit main board LED1 (AU242FHAHA), outdoor unit main board LED (ALARMA or ALARMB) (AU422FIAHA*AU422FIAIA).

Trouble description	LED flash times
Outdoor unit defrost temperature sensor abnormal	1
Outdoor unit ambient temperature sensor abnormal	2
Compressor suction temperature sensor abnormal	3
Compressor discharge temperature sensor abnormal	4
Outdoor unit AC overcurrent protection	6
Outdoor unit DC undervoltage protection	7
Outdoor unit power module overcurrent protection	9
Trouble with outdoor unit EEPROM	10
Compressor discharge gas too hot protection	11
Abnormal communication between outdoor unit 857 chip and 808 chip	12
Outdoor unit system pressure too high protection	13

Installation check and trial operation

Check if the drain pipe and connection wires are arranged properly.

The drain pipe shall be put below. The connection wire shall be put above. Be sure to wrap the drain pipe (especially the indoor part and the part inside the machine) with thermal insulating materials.

The drain pipe shall be made into slope. Avoid bulging up or down or phenomena shown right figure in the run.

Installation check

- * Do the supply voltage meet the requirement?
- * Could the drainage water completely discharged to outdoor
- * Are the power cord and the indoor/outdoor connection wire connected properly?
Are the wires pressed firmly?
- * Is there any gas leakage at the pipe joints?
- * Is the noise too big?

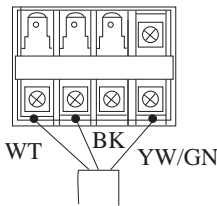

- * Do the terminal numbers of the indoor/outdoor connection wire coincide with each other?
Is the pipe connection part thermally insulated?
Is the indoor unit mounted firmly and reliably?

Trial operation

The installation serviceman must conduct a trial operation and check:

- * Does the temperature regulator work normally?
- * Does the installation location selection meet the related requirements?

Wrap with the protective plastic tape

Wrap the connection pipe, the drain pipe and the connection wire together with PVC tape.

Caution:

The connection pipe must be wrapped individually with insulating material from down to up.

Free Manuals Download Website

<http://myh66.com>

<http://usermanuals.us>

<http://www.somanuals.com>

<http://www.4manuals.cc>

<http://www.manual-lib.com>

<http://www.404manual.com>

<http://www.luxmanual.com>

<http://aubethermostatmanual.com>

Golf course search by state

<http://golfingnear.com>

Email search by domain

<http://emailbydomain.com>

Auto manuals search

<http://auto.somanuals.com>

TV manuals search

<http://tv.somanuals.com>