

CEILING CONCEALED TYPE AIR CONDITIONER INDOOR UNIT



H-MRV

Ceiling Concealed Type Room Air Conditioner

INSTRUCTION MANUAL

AE072FCAKA AE122FCAKA AE182FCAKA
AE092FCAKA AE142FCAKA AE212FCAKA
AE242FCAKA

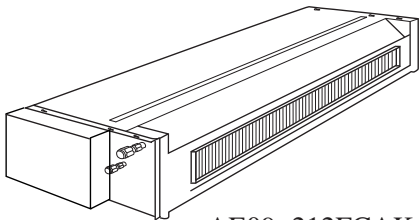

AE09~212FCAKA

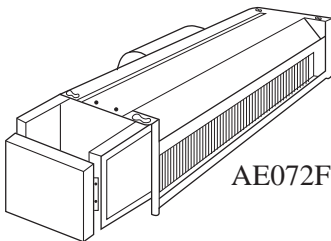

AE072FCAKA

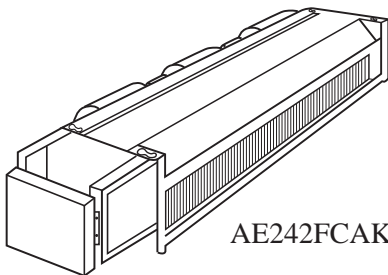

AE242FCAKA

Contents

Before Application

Cautions	1-2
Part Description	3-8
Important Points of Safety	9-11

Operating Instructions

AUTO,COOL, DRY,HEAT Operation	12
TIME Operation	13-14
Sleep Function	15
Health Function	16

Maintenance

Trouble Shooting	17-18
When Fault Occurs	19
Notice to Users	20

Indoor Unit Installation

Installation Precautions	21-22
Installation Procedure	23-33
Malfunction	34-35
Installation Check and Trial Run	36

No. 0010573331

- Please read this manual carefully before use.
- Please keep it attentively for future use.

Cautions

Disposal of the old air conditioner

Before disposing an old air conditioner that goes out of use, please make sure it's inoperative and safe. Unplug the air conditioner in order to avoid the risk of child entrapment.

It must be noticed that air conditioner system contains refrigerants, which require specialized waste disposal. The valuable materials contained in a air conditioner can be recycled. Contact your local waste disposal center for proper disposal of an old air conditioner and contact your local authority or your dealer if you have any question. Please ensure that the pipework of your air conditioner does not get damaged prior to being picked up by the relevant waste disposal center, and contribute to environmental awareness by insisting on an appropriate, anti-pollution method of disposal.

Disposal of the packaging of your new air conditioner

All the packaging materials employed in the package of your new air conditioner may be disposed without any danger to the environment.

The cardboard box may be broken or cut into smaller pieces and given to a waste paper disposal service. The wrapping bag made of polyethylene and the polyethylene foam pads contain no fluorochloric hydrocarbon.

All these valuable materials may be taken to a waste collecting center and used again after adequate recycling.

Consult your local authorities for the name and address of the waste materials collecting centers and waste paper disposal services nearest to your house.

Safety Instructions and Warnings

Before starting the air conditioner, read the information given in the User's Guide carefully. The User's Guide contains very important observations relating to the assembly, operation and maintenance of the air conditioner.

The manufacturer does not accept responsibility for any damages that may arise due to non-observation of the following instruction.

- Damaged air conditioners are not to be put into operation. In case of doubt, consult your supplier.
- Use of the air conditioner is to be carried out in strict compliance with the relative instructions set forth in the User's Guide.
- Installation shall be done by professional people, don't install unit by yourself.
- For the purpose of safety, the air conditioner must be properly grounded in accordance with specifications.
- Always remember to unplug the air conditioner before opening inlet grill. Never unplug your air conditioner by pulling on the power cord. Always grip plug firmly and pull straight out from the outlet.

Cautions

- All electrical repairs must be carried out by qualified electricians. Inadequate repairs may result in a major source of danger for the user of the air conditioner.
 - Do not damage any parts of the air conditioner that carry refrigerant by piercing or perforating the air conditioner's tubes with sharp or pointed items, crushing or twisting any tubes, or scraping the coatings off the surfaces. If the refrigerant spurts out and gets into eyes, it may result in serious eye injuries.
 - Do not obstruct or cover the ventilation grille of the air conditioner. Do not put fingers or any other things into the inlet/outlet and swing louver.
 - Do not allow children to play with the air conditioner. In no case should children be allowed to sit on the outdoor unit.
2. If the supply cord is damaged, it must be replaced by the manufacturer or its service agent or a similar qualified person.
 3. If the fuse on PC board is broken please change it with the type of T. 3.15A /250VAC.
 4. The wiring method should be in line with the local wiring standard.
 5. The power cable and connecting cable are self-provided.
All the cables shall have got the European authentication certificate.
 6. The breaker of the air conditioner should be all-pole switch; and the distance between its two contacts should be no less 3mm. Such means for disconnection must be incorporation in the fixed wiring.
 7. The waste battery shall be disposed properly.
 8. The indoor unit installation height is at least 2.5m.

Specifications

The refrigerating circuit is leak-proof.

The machine is adaptive in following situation

1. Applicable ambient temperature range:

			Rated	Maximum	Minimum
Cooling	Indoor	DB °C	27	32	18
		WB °C	19	23	14
	outdoor	DB °C	35	43	-5
		WB °C	24	26	--
Heating	Indoor	DB °C	20	27	15
		WB °C	14.5	--	--
	outdoor	DB °C	7	24	-15
		WB °C	6	18	--

Part Description

Indoor unit

AE072FCAKA

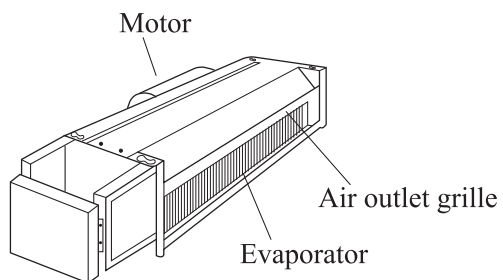

AE242FCAKA

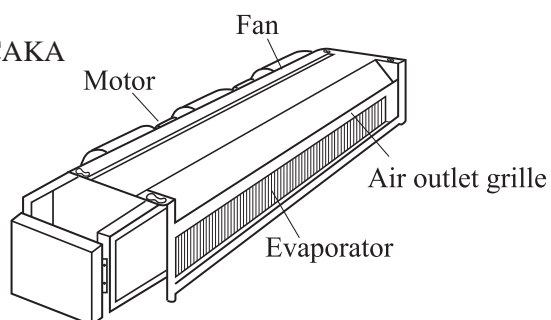

AE092FCAKA , AE122FCAKA , AE142FCAKA , AE182FCAKA , AE212FCAKA have the Return air box (see the following picture) when shipping from the factory and they are back-side return air. During the installation, also can be changed to Down-side Return air according to the user's need.

AE09~212FCAKA

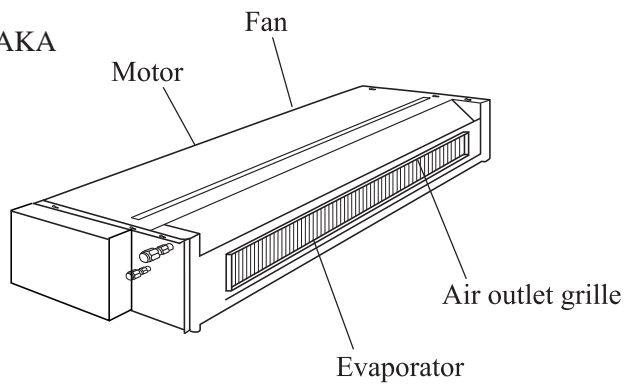

Part Description

Indoor unit

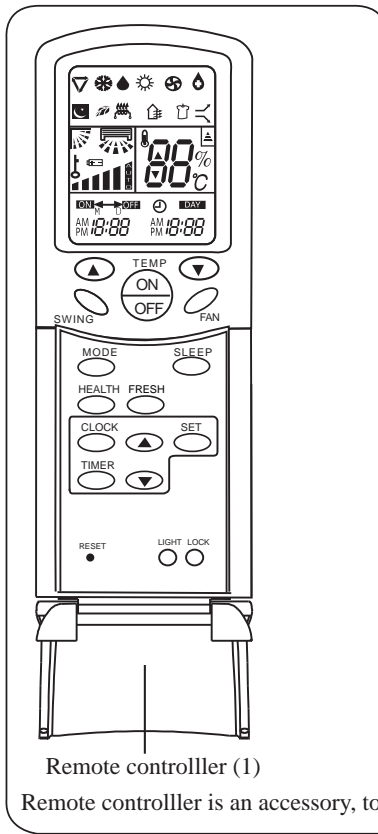

Left picture is a wired remote controller, which can be used on AE072FCAKA(wired control), AE092FCAKA (wired control), AE122FCAKA(wired control), AE142FCAKA(wired control),AE182FCAKA(wired control),AE212FCAKA(wired control), AE242FCAKA (wired control). The remote controller can be purchased extrally.

Wired remote Controller using method:

1. Use one wired remote controller. See fig (1)
2. Also can buy a remote controller extrally, realize wired remote control + remote control dual control modes.

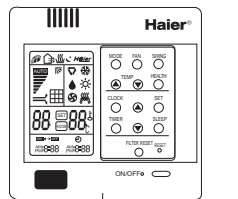

fig(1)

The right figure is a remote controller, which can be used on AE072FCAKA(remote control), AE092FCAKA(remote control), AE122FCAKA(remote control), AE142FCAKA (remote control),AE182FCAKA(remote control), AE212FCAKA(remote control), AE242FCAKA(remote control) and the matching remote control receiver

Remote control receiver using method :

Use remote controller control the remote control window of the remote control receiver.

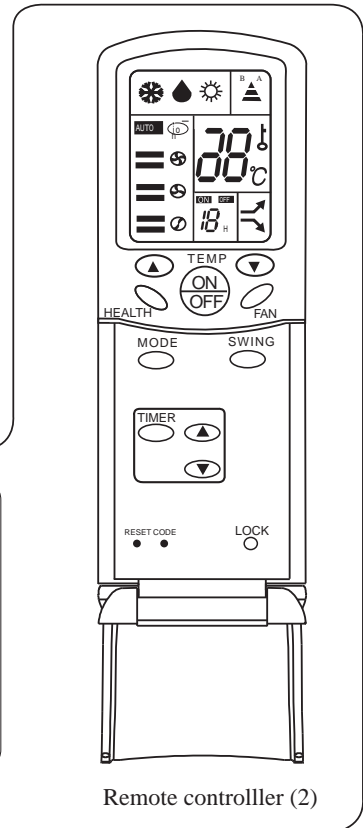
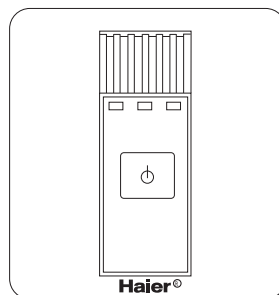

fig(2)

Part Description

Indoor unit

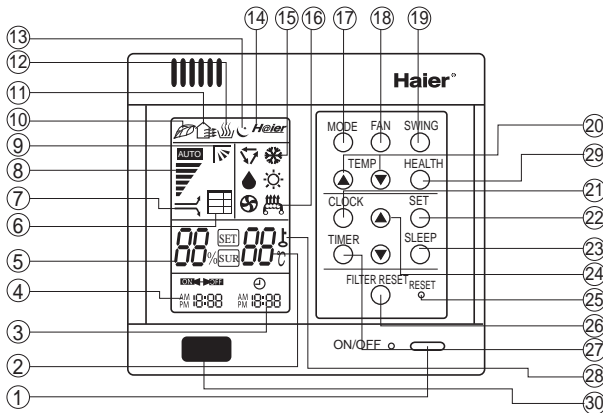

1.ON/OFF button

Used to turn on/off unit

2.Temperature display

3.Clock display

4.Timer ON/OFF display

5.Humidity display

6.Air filter cleaning display

When there is too much dust collected on the air inlet, the wire controller will show this display to remind the user to clean the air inlet. After cleaning and installation, just press the air filter reset button.

7.Super/Soft operation display

8.Fan speed display



9.Auto Swing display

10.Health state display

11.Fresh air state display

12.Humidifying state display

13.Sleep state display

14.Network control display

15.Working mode display

Working mode	Auto operation	Cooling operation	Dehumidifying operation	Heating operation	Fan operation
Wire controller					

16.Electric heating display

17.Operation mode button

Used to set working mode: Auto, Cooling, Dehumidifying, Heating, Fan

18.Fan speed button

Used to set fan speed: Low Fan, Med Fan, High Fan, Auto

19.Swing button

Used to set Auto Swing or Fixed air sending direction

20.Temperature Setting button

Used to set temperature, temperature range: 16°C~30°C

21.Clock button

Used to calibrate the time of timer and clock

22.Setting button

Used to confirm the time of timer and clock

23.Sleep button

Used to set Sleep state

24.Time Adjusting button

Used to adjust the time of timer and clock

25.Reset button

When the wire controller appears abnormal condition, use a sharp-pointed article to press this button to make the wire controller resume normal

26.Air Filter Reset button

After cleaning the air inlet, press this button, the unit can start to operate

27.Timer button

Used to set the mode of timer

28.Lock state display

29.Health

Used to control the generating oxygen function and negative ion-function

30.Remote control window

Used to receive the remote control signal

Note:

- This model does not have the following related display and function (5)(6)(7)(9)(11)(12)(14)(16)(26)
- The outdoor unit no oxygen-bar function or no negative ion unit no (10)(19) health function display.

Calibration of clock

When turning on the unit for the first time, the clock should be calibrated. The method of calibration is:

- Press \hat{C} Clock button, the Clock display $\hat{A}M\hat{P}$ will flash.
- Press \blacktriangle or \blacktriangledown to adjust time. For each press, the time will increase or decrease 1 *minute. If depressing the button, the time will increase or decrease rapidly.
- After confirming the time, press \hat{S} Set button, $\hat{A}M\hat{P}$ or $\hat{P}M\hat{P}$ will stop flashing, the clock will begin to work.

Part Description

Indoor unit

Remote LCD display contents and key name and each key function introduction

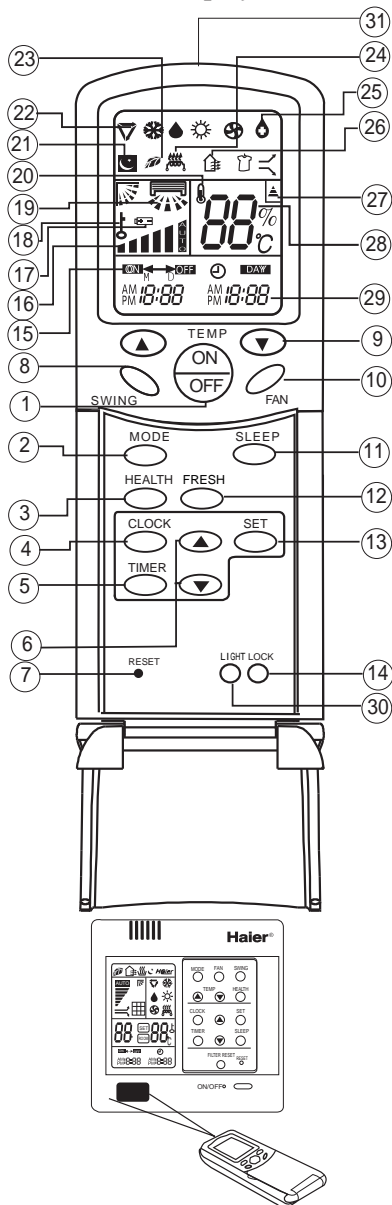

1.ON/OFF button

Used to turn on/off unit
Note: Wired remote controller his key have compl cooling running function.

2.Operation mode button

Used to set working mode: Auto, Cooling, Dehumidifying, Heating, Fan

3.Health

Used to control the generating oxygen function and negative ion-function

4.Clock button

Used to calibrate the time of timer and clock

5.Timer button

Used to set the mode of timer

6.Time Adjusting button

7.Reset button
When the wire controller appears abnormal condition, use a sharp-pointed article to press this button to make the wire controller resume normal

8.Swing button

Used to set Auto Swing or Fixed air sending direction

9.Temperature Setting button

Used to set temperature, temperature range: 16°C~30°C

10.Fan speed button

Used to set fan speed: Low Fan, Med Fan, High Fan, Auto

11.Sleep button

12.Fresh air

Used to set fresh air function

13.Setting button

Used to confirm the time of timer and clock

14.Lock button

Used to lock the operating key and LCD contents

15.Timer ON/OFF display

16.Fan speed display



17.Battery energy display

18.Clock display

19.Auto Swing display

20.Humidifying state display

21.Sleep mode display

22.Working mode display

Working mode	Remote controller
Auto operation	▼
Cooling operation	❄️
Dehumidifying operation	💧
Heating operation	☀️
Fan operation	🌀

23.Health state display

Display when the health running

24.Electric heating display

25.Comfort running display

26.Fresh air state display

27.Signal launch display

28.Temperature display

Used to display the setting temperature and room temp.

29.Lock state display

30.Light button

Used to realize control board VFD light stable,light weaker, light shut off etc.

31.Signal launch head

Remote controller (Operation of remote controller)

Make sure that the remote controller is used within 7 meters from receiver window of the wire controller and there are no obstructions in between.

The remote controller or wire controller should be handled with care.

When operating the remote controller in an area where electronically controlled lights are installed or wireless handsets are used, move closer to the indoor unit as the function of the remote controller might be affected by signals from this equipment.

Note:

- 1.This unit no the above function and display (8)(12)(17)(19)(20)(24)(25)(26)(30)
- 2.The outdoor unit no oxygen-bar function of no (3)(23) functions fo non-negative ion unit.
- 3.When using remote controller, first point it to the receiving window of wire controller, and then operate remote controller.A tick tone will be uttered to indicate a right acceptance.
- 4.All the buttons except the sleeping button is no effective after wire controller received lock signal from remote controller.

Part Description

Indoor unit

Remote LCD display contents and key name and each key function introduction

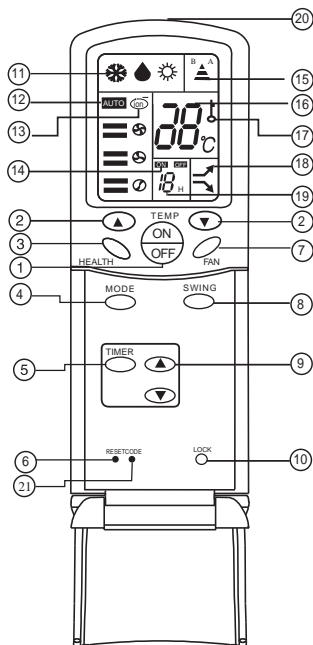

1.ON/OFF button

Used to turn on/off unit

2.Temperature Setting button

Used to set temperature, temperature range: 16°C~30°C

3.Health

Used to control the generating oxygen function and negative ion-function

4.Operation mode button

Used to set working mode: Cooling, Dehumidifying, Heating

5.Timer button

Used to set the mode of timer

6.Reset button

When the remote controller appears abnormal condition, use a sharp-pointed article to press this button to make the wire controller resume normal

7.Fan speed button

Used to set fan speed

8.Swing button

Used to set Auto Swing or Fixed air sending direction

9.Time Adjusting button

10.Lock button

Press on time lock all the key sand press another time cancel the lock.

11.Working mode display

12.Fan speed display

Used to display the fan speed. After setting "AUTO" function,air speed can auto change according to the temp. difference between the room temp. and setting temp.

13.Health running display

Used to display healthy running.

14.Timer ON/OFF display

Display Timing mode.
"Blank" No Timing
"OFF" Timing off
"ON" Timing on

15.Signal display

Sending out signal to the remote receiver.

16.Temperature display

Display the setting temp. value.

17.Lock display

Display the key have been locked.

18.Super/Soft operation display

19.Timing time display

Display timing open time or timing close time

20.Signal launch head

Use to send signal to the indoor unit receive window.

21.Code

Select remote control receive code(H-MRV Remote control type use A code)

- Make sure that the remote controller is used within 7 meters from receiver window of the wire controller and there are no obstructions in between.
- The remote controller or wire controller should be handled with care.
- When operating the remote controller in an area where electronically controlled lights are installed or wireless handsets are used, move closer to the indoor unit as the function of the remote controller might be affected by signals from this equipment.

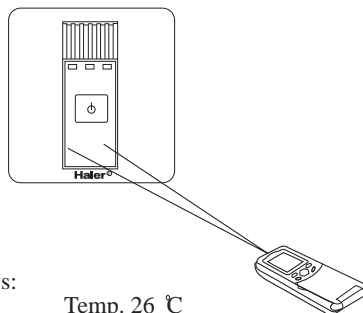

Note:

1.After change the battery, working condition resume as follows:

Working mode:cooling

Timing mode: normal

Temp. 26 °C

Air speed: Auto

2.The units used in this manual no (8) (18) functions. The health key can only control the negative generator.

Clock set

When unit is started for the first time, clock should be adjusted as follows:

- Press CLOCK button, "AM" or "PM" flashes.
- Press ▲ or ▼ to set correct time. Each press will increase or decrease 1min. If the button is kept depressed, time will change quickly.
- After time setting is confirmed, press SET, "AM" and "PM" stop flashing, while clock starts working.

Battery loading

Batteries are fitted as follows:

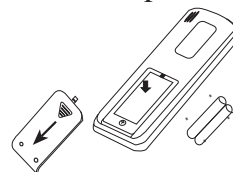

Remove the battery compartment lid

Slightly press and disengage the battery compartment lid marked with  and then hold the remote controller by the upper section and then remove the battery compartment lid by pressing in the direction of the arrow as shown in the figure above.

Loading the battery

Ensure that batteries are correctly placed in the compartment as required for positive and negative terminals.

Replacing the battery compartment lid

The battery compartment lid is reinstalled in the reverse sequence.

Display review

Press the button to see if batteries are properly fitted. If no display appears, refit the batteries.

Caution:

If the remote controller does not operate as designed after fitting new batteries of the same type, press the Reset button (marked ) with a pointed article.

Note:

It is recommended that the batteries be removed from the compartment if the remote controller is not used for an extended period.

The remote controller is programmed for automatic test of operation mode after the batteries are replaced. When the test is conducted, all icons will appear on the screen and then disappear if the batteries are properly fitted.

When the display become weak, this display no power in the battery, please change the battery.

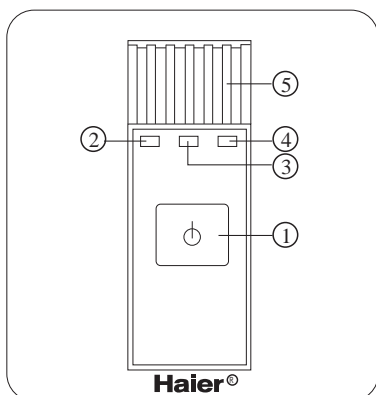

①. Emergency switch

②. Power lamp

After open the unit, this lamp bright when the unite enter health running, the lamp change from orange to blue lamp.

③. Timing lamp

When the unit been setting Timing running, this lamp bright.

④. Running lamp





When the compressor working, this lamp bright.

⑤. Indoor temp. sensor

Test the room temperature.

Important Points of Safety





The following four important points of safety and suggestions should be paid great attention:

-  **Warning:** Misuse may cause fatal result such as death or serious injury etc.
-  **Attention:** Misuse may cause human injury or damage of machine, in some case fatal results.
-  : Content marked with this 'forbidden' sign should be absolutely forbidden, otherwise may cause damage of machine and human injury of the user.
-  : Content marked with this 'compulsory' sign should be executed compulsively, otherwise may cause damage of machine and human injury of the user.







Comply with the following important points of safety.



Put these important points of attention and suggestions nearby and convenient for reference in need.

Hand over this instruction manual to new user if you resell this machine.











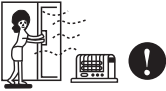

 Warning	
Warning for installation	<ul style="list-style-type: none"> ● Entrusted Installation Installation of the machine should be entrusted to certified person of after service. Unauthorized installation may cause water leakage, electric shock or fire hazard for improper operation.  ● To prevent leakage of refrigerant, let certified person of after service do it. ● Leakage of refrigerant over certain consistence may result in shortage of oxygen. Enough precautions MUST be done to avoid oxygen shortage in case of refrigerant leaking if the room where the air-conditioner is installed is small. 
	<ul style="list-style-type: none"> ● The power supply must be fitted with earth line to ensure valid earthing of the air-conditioner. No or incomplete earthing connection may cause the risk of electric shock.  ● Test run After indoor units are installed, all cassettes hinded models should be tested. when the units are confirmed to be normal, other fitments can be installed. 

Important Points of Safety

 Warning	
Warning for use	<ul style="list-style-type: none"> ● Avoid your body being blown directly by cold wind for long period, otherwise your health may be affected.  ● Don't extend your fingers or any other article into the inlet or outlet during operation of the machine for touching revolving fans may cause human injury or damage of machine. 
Warning for move and repair	<ul style="list-style-type: none"> ● If something abnormal (e.g.: burnt smell etc.) occurs, stop running the machine, shut down the manual power switch and contact after service. Continuous operation in disorder may cause fire hazard or electric shock etc.  ● When you have to disassemble and reinstall the machine, entrust it to after service. Improper installation may cause fire hazard, electric shock or damage of machine.  ● Unauthorized alteration or repair work is strictly forbidden. Improper alteration or maintenance may cause fire hazard, electric shock or water leakage. Repair work should be entrusted to certified person of after service. 

 Attention	
Attention points for installation	<ul style="list-style-type: none"> ● Ensure the drainage hose work normally during installation. Improper installation of drainage can cause water leakage and damp articles.  ● DO NOT install the machine in place where flammable gas releases easily to avoid fire hazard. ● Ensure electric leakage breaker being installed. Electric leakage breaker MUST be installed, otherwise electric shock may be caused.  ● If the power supply cord is damaged, call a certified electrician of the manufacturer or other maintenance department to replace it.

Important Points of Safety

⚠ Attention	
Attention points for use	<ul style="list-style-type: none"> * Ensure ventilation of the room if the machine is used with burning facilities. Deficient ventilation can cause oxygen shortage. <div style="text-align: right;"></div> * Check whether installation bench of the machine is damaged after a long period of use. Machine on damaged bench may fall down and cause human injury or other damage. <div style="text-align: right;"></div> * In place where winds produced by the machine can reach, don't lay any animals or plants which may be hurt otherwise. <div style="text-align: right;"></div> * Don't put vases containing water or other else on the unit assembly. Otherwise, the machine may be immersed internally and result in bad electric insulation causing electric shock. <div style="text-align: right;"></div> * The is machine CANNOT be used for the purpose of preserving food, animals, plants, precision instruments and artwork etc., which may be destroyed otherwise. <div style="text-align: right;"></div> * DON'T replace fuse with material other than fuse of proper capacity. Replacing fuse with metal wire or copper etc. can cause fire hazard or other faults. <div style="text-align: right;"></div>
	<ul style="list-style-type: none"> * DON'T lay any burning facilities in place where winds produced by the machine can reach. Incomplete combustion of burning facility may be caused otherwise. <div style="text-align: right;"></div> * DON'T clean the machine with water. Electric shock may occur otherwise. <div style="text-align: right;"></div> * DON'T put flammable spray articles nearby or spray them to the machine. Fire hazard may occur otherwise. <div style="text-align: right;"></div> * DON'T operate switch with wet hand. Electric shock may occur otherwise. <div style="text-align: right;"></div> * Stop operation and shut down manual power switch before cleaning and maintenance. <div style="text-align: right;"></div> * The power supply MUST be of rated voltage and connected with special electrical supply circuit. <div style="text-align: right;"></div>

Operating Instructions

AUTO RUN, COOL, HEAT and DRY operation

Recommendations

- Use COOL in summer.
- Use HEAT in winter.
- Use DRY in spring, autumn and in damp climate.

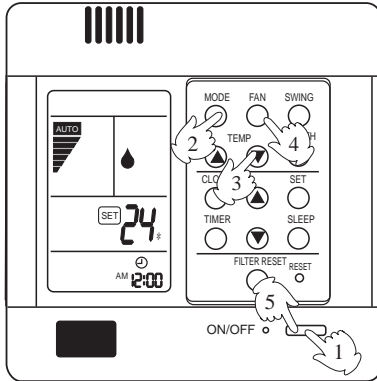

(1) Unit start

Press ON/OFF button, unit starts.

Previous operation status appears on display (Not Timer setting). Power indicator lights up.

(2) Select operation mode

Press MODE button. For each press, operation mode changes as follows:



Unit will run in operation mode displayed on LCD. Stop display at your desired mode.

(3) Select temp. setting

Press TEMP button

- ▲ Every time the button is pressed, temp. setting increases 1°C.
If button is kept depressed, temp. setting will increase quickly.
- ▼ Every time the button is pressed, temp. setting decreases 1°C.
If button is kept depressed, temp. setting will decrease quickly.

Unit will start running to reach the temp. setting on LCD.

(4) Fan speed selection

- Auto running: During the Auto running mode, air conditioning running and can auto-select the cooling, heating, fan mode according to the room temperature.
- Fan running: The AC only have air supply running no cooling and heating running at the condition, AC can't have auto air supply running, and can't display the setting temperature value on the LCD.
- During the heating running, after start the AC, in order to prevent cooled air, AC can stop for a while before send heat air.
- During the dehumidification running, when the room temp. setting temp., not setting condition according to the air speed.

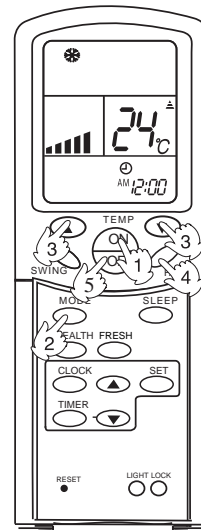

Press FAN button. For each press, fan speed changes as follows:

Wire controller



Remote controller



Unit runs at the speed displayed on LCD. In HEAT mode, warm air will blow out after a short period of time due to cold-draft prevention function. In DRY mode, when room temp. becomes 2°C higher than temp. setting, unit will run intermittently at LOW speed regardless of FAN setting.

(5) Unit stop

Press ON/OFF button.

Only time and room temp remains on LCD.

All indicators go out.

Vertical flap closes automatically.

Hints

Wire controller can memorize each operation status. When starting it next time, just press ON/OFF button and unit will run in previous status.

Operating Instructions

TIMER Operation

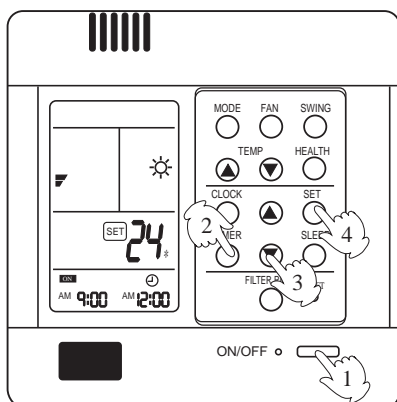

Set Clock correctly before starting Timer operation.

You can let unit start or stop automatically at following time: Before you wake up in the morning, or get back from outside or after you fall asleep at night.

TIMER ON/OFF

(1) After unit start, select your desired operation mode.

Operation mode will be displayed on LCD.
Power indicator lights up.

(2) TIMER mode selection

Press TIMER button to change TIMER mode.
Every time the button is pressed, display changes as follows:



Select your desired TIMER mode (ON or OFF)

To cancel TIMER mode

Just press TIMER button several times until TIMER mode disappears.

- According to the setting timing open, close sequence, can realize first open then close the unit or first close then open the unit.

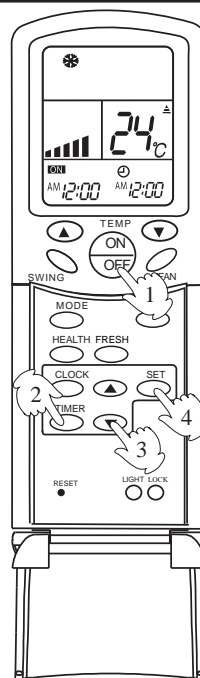

(3) Timer setting

Press TIME ▲ / ▼ button.

- ▲ Every time the button is pressed, time increases 10min.
If button is kept depressed, time will change quickly.
- ▼ Every time the button is pressed, time decreases 10min.
If button is kept depressed, time will change quickly.
Time will be shown on LCD. It can be adjusted within 24hours.

(4) Confirming your setting

After setting correct time, press SET button to confirm "ON" or "OFF" stops flashing.

Time displayed: Unit starts or stops at x hour x min (ON or OFF).

Timer mode indicator lights up.

- Hints:**
- Wire controller possesses memory function, when use TIMER mode next time, just press SET button after mode selecting if timer setting is the same as previous one.
 - Wire remote controller or remote controller can memorize each working condition. Next time open the unit, only need to press the ON/OFF key, the AC can work according to last time working condition. (Timing, Sleeping and Swing mode not included.)
 - From Timing close to timing open, can setting sleep mode.
 - Please close health function first before setting Timer, then you can do the TIMER ON operation. Please do not use the health function when in TIMER ON state.

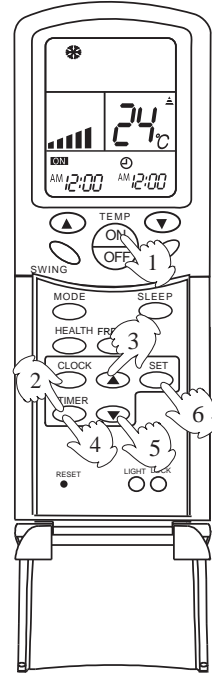
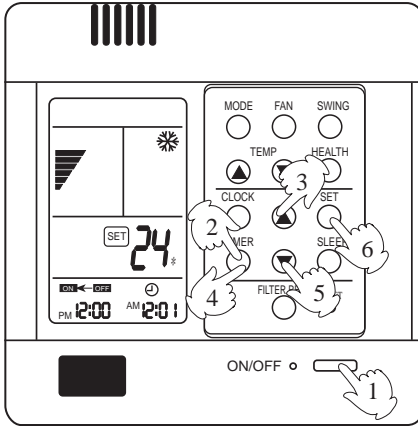

TIMER ON-OFF

(1) After unit start, select your desired operation mode

Operation mode will be displayed on LCD.
Power indicator lights up.

(2) Press TIMER button to change TIMER mode

Every time the button is pressed, display changes as follows:



Select ON/OFF.

(3) Time setting for TIMER ON

Press TIME button.

▲ Every time the button is pressed, time increases 10min.

If button is kept depressed, time will change quickly.

▼ Every time the button is pressed, time decreases 10min.

If button is kept depressed, time will change quickly.

Time will be shown on LCD.

It can be adjusted within 24hours.

AM refers to morning and PM to afternoon.

To cancel TIMER mode

- Just press TIMER button several times until TIMER mode disappears.
- According to the Time setting sequence of TIMER ON or TIMER OFF, either Start-Stop or Stop-Start can be achieved.

(4) Time confirming for TIMER ON

After time setting, press TIMER button to confirm.
"ON" stops blinking, While "OFF" starts blinking.

Time displayed: Unit starts at Xhour X min.

(5) Time setting for TIMER OFF

Follow the same procedures in "Time setting for TIMER ON".

(6) Time confirming for TIMER OFF

After time setting, press SET button to confirm
"OFF" stops flashing.

Time displayed: Unit stops at X hour X min.

Operating Instructions

Sleep Function

Note: Before using this function, must adjust the clock, or the sleep function will be disordered.

Comfortable Sleep

At night, before going to bed you can press down the SLEEP button on the controller and the air-conditioner will run by the comfortable sleeping mode to make you sleep more comfortable.

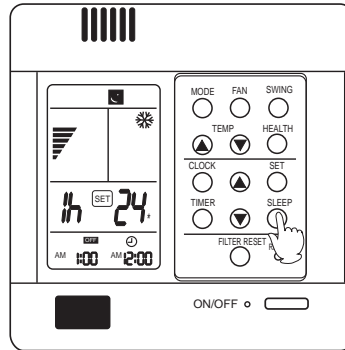

Press SLEEP button once to make the air conditioner have the previous-set sleep time (first power-on is "1h"), the sleep symbol will appear. Press time button ▲/▼, you can choose the time in 1~8 hours. Each press of ▲/▼, the time increases/reduces 1 hour and "xh" appears in the humidity setting part, "OFF" appears in "TIMER OFF" display part and timer-off time; press SLEEP button again to cancel sleep function, the sleep symbol disappears.

In cooling, dehumidifying mode

One hour after sleeping operation start, the temp. is 1°C higher than the setting one. After another hour the temp. rises 1°C and then run continuously for another 6hrs' and then close. The actual temp. is higher than the setting one which is to prevent from being too cool to your sleep.

In heating mode

One hour after start up, the temp. decrease 2°C lower than the setting one. After another hour decrease by more 2°C.

The temperature will automatically rise by 1°C after another 3hrs' operation, and then automatically close after 3hrs' continuous operation. The actual temperature is lower than the setting one which is to prevent from being too hot to your sleep.

Note:

- In AUTO mode, unit will run in SLEEP function according to the operation mode.
- After setting SLEEP function, it is forbidden to calibrate clock.
- If the set sleep-time does not reach 8 hours, the unit will stop operation automatically after set time is complete.
- Set "TIMER-OFF" function first, then set SLEEP, and the sleep-set is performance; set TIMER-ON function first, the sleep function can only be set before TIMER-ON; if set the SLEEP function first, the TIMER function can not be set.
- After setting sleep function, not allowed to adjust the clock. Can't use the remote controller operate the AC. If so, please cancel the sleep function first.
- After setting sleep function, can't set the timing function.

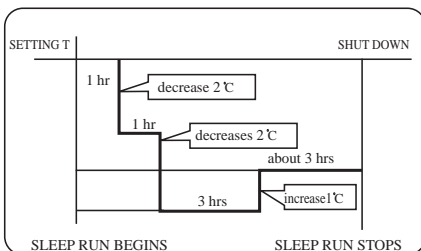

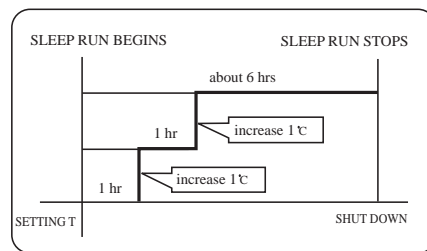

Heat mode

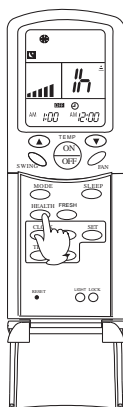
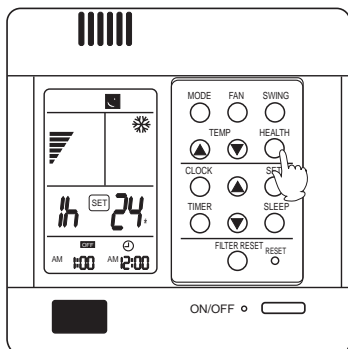

Cooling mode



1. How to use the health function (only for units with this function)

After set the right function mode, press health button, remote controller or wire controller displays , oxygen pump or negative ion generator starts up to apply oxygen or negative ion to indoor unit. Press the button again, the sign  disappeared and negative ion generator stops working. After all health function of the indoor unit being fully canceled, oxygen pump stopped.

CAUTION:

When the temperature of the outdoor unit is lower than 4°C, oxygen pump is automatically stopped, if press health button just then, oxygen pump could not start up. But if the air conditioner has the negative ion function simultaneous, when press the health button, negative ion function could still be operated. When the temperature of the outdoor unit is higher than 6°C, oxygen pump could automatically resume to oxygen-make function.

- On the "Health" mode, if you want setting timing open mode, should close the health first: On the timing open mode, please don't use health function.

Power Failure Compensation (to be applied for a necessary situation) :

After the power failure compensation is set, if power failure suddenly occurs while the air conditioner is working, it will resume the previous working state when the power is supplied again.

Setting Method: When the remote controller is on (excluding timer mode and fan mode), press the "Sleeping" button on the remote controller 10 times within 5 seconds, and after the buzzer rings 4 times, the air conditioner will enter the state of power failure compensation.

Cancel Method: Press the "Sleeping" button on the remote controller 10 times within 5 seconds, and after the buzzer rings 2 timer, the power failure compensation mode will be cancelled.

Notes: When a power failure suddenly occurs during the air conditioner is working after the power failure compensation is set, if the air conditioner will not be used for a long time, please cut off the power supply to prevent its operation from being resumed after the power is supplied again, or press the "Switch On/Off" button after the power comes again. If the controller no sleep key, use the "swing" key instead the "sleeping" on setting the auto restart function.

Concerning MRV Auto Restart function for H-MRV models

Haier Auto Restart function when the unit power drops down suddenly, the unit microprocessor will store the previous working condition and when the power is on again, the unit will run as this memory.

Auto Restart function is designed basically on the MRV whole system, but it is suitable for each indoor unit individually.

If some of indoor units power cut down, but the outdoor unit and the other indoor units still work, maybe problems will happen such as freezing at cooling mode and overload protection at heating mode on those indoor units without power.

Reason

When one or some indoor units power drops down and the other indoor units are still work, the indoor units without the power, will keep the previous working condition before the power is off. And expansion valve keeps open at a kind of opening rate condition as the previous requirement, so there is refrigerant flowing in the exchanger, but the indoor fan stops working. If the units work at cooling mode, the indoor units without the power will maybe make freezing. If the unit works at heating mode, maybe the outdoor unit compressor will stop because of the pressure or temperature protection. This is our design basically on Auto Restart function currently.

Haier, Herewith, solemnly informs our customers, installers, distributors, etc. **when making installation, please make sure when the power is shut down whether artificially or accidentally, the whole system including outdoor unit and all the indoor units must be off. If you do not make the installation as our indication, Haier will not be responsible for any problem resulting from this.**



User Caution

About the remote control operation, above only take wired remote controller and remote controller (1) as a example about the remote controller (2) and remote receiver use method, it is the same remote controller (1), please use refer to above method.

No sleep function when use remote (2) and remote receiver.

Trouble Shooting



The following cases are not troubles.

<p>Water flow sound is heard.</p> <p>"Hua-Hua"</p> 	<p>During operation, the air conditioner may sometimes exhibit a sound of "clatter" or "rumble". This is the common sound of refrigerant flow but not a trouble.</p>
<p>A sound of "Pi-Pa" is generated.</p>	<p>This is caused by the thermal expansion or cold shrinkage of plastics.</p>
<p>Smells are given off.</p>	<p>Sometimes there are smells in the air flow from the indoor unit. This is caused by the smell of cigarettes or paint coatings inside the unit.</p>
<p>During operation, mist or steam are blown out.</p>	<p>During COOL or DRY operation, the unit may blow out a thin mist. This is the condensate water mist caused by sudden cooling of the indoor air blown out from the indoor unit.</p>
<p>During COOL operation, it automatically changes to FAN mode.</p>	<p>In order to prevent frost accumulation on the heat exchanger in the indoor unit, sometimes it will automatically transfers to FAN mode, but soon will return to COOL mode.</p>
<p>The system couldnt be re-started immediately after turning off.The unit can ' t start?</p> 	<p>This is due to the systems self-protection function, which prevents it from restarting in 3 min after stops.</p> 

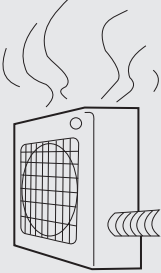
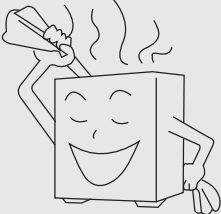
Trouble Shooting

<p>During DRY operation, there is no air sent out or fan speed cant be changed.</p>	<p>In DRY operation,when the room temperature reaches 2°C higher than temp. setting,the unit will run at"low"fan speed regardless of fan speed setting.</p>
<p>In HEAT mode, the outdoor unit generates water or steam.</p> 	<p>This occurs during removal of the frost (in defrosting operation) on the radiator of outdoor unit.</p>  <p>Defrost operation</p>
<p>In HEAT mode, the indoor fan still keeps running even the unit operation stops.</p>	<p>After the unit stops, the indoor fan will continue to run for a while to eliminate residual heat.</p>

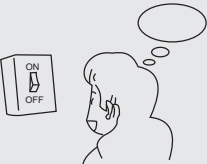
Before asking for after-service to an authorized service center, please check your air conditioner for the following items



The system couldnt start		
<p>Is power on/off switched on?</p>  <p>The power on/off switch is not at position of "ON" .</p>	<p>Is the power supply line normal?</p>  <p>Power failure?</p>	<p>Is current leakage breaker triggered?</p> <p>Please do immediately cut off power supply and contact the authorized service center.</p>

When Fault Occurs

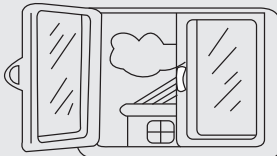
Poor cooling or heating

<p>Is the operation controller adjusted as required?</p>	<p>Are there any obstructs before the air inlet or outlet?</p>	<p>Is there any door or window left open?</p> 
--	--	--

Poor cooling

<p>Is there any other heat source in the room?</p> 	<p>Is there any direct sunlight into the room?</p> 	<p>Are there too many people in the room?</p> 
--	--	--

If, after the above checks and the corresponding corrective actions, the system remains abnormal operation, or the following facts appear, please turn off the air conditioner and then contact the local authorized service center.

- Frequent open of fuse or breaker.
- There is water leakage during COOL or DRY operation.
- The operation is abnormal or abnormal sound is heard.

Notice to Users

Notice to users

- To ensure proper operation of the system, the user shall follow this instruction manual to install the unit.
- When handling the air conditioner, please be care not to scratch the case surface.
This instruction manual describes the installation method aided with the installation tools specified by manufacturer .
- The maximum length of connection pipe is 50 m, and the maximum difference between levels of indoor unit and outdoor unit shall be 30 m.
- Please keep the installation instruction manual well for reference in maintenance or changing installation position.
- After installed, please follow the operational instruction manual to use the air conditioner properly.

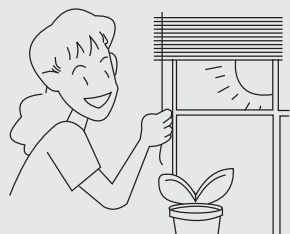
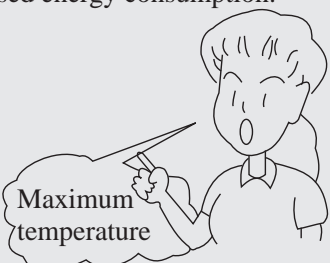
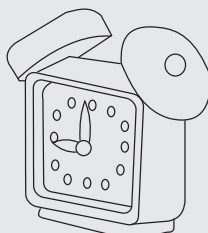
Information about application	
<p>Adjust your desired air flow direction</p> 	<p>Avoid direct sunlight and gas flow</p> 
<p>Keep appropriate room temperature Too cool or too warm wont benefit to your health, but causes an increased energy consumption.</p> 	<p>Effectively use the timer Using TIMER mode you can enjoy a comfortable room temperature when wake up or come back home.</p> 

Caution: After installation, please confirm no refrigerant leaks.

Installation Precautions

- Before installing, do read this "Safety precautions" carefully to guarantee the proper installation.
- The below attentive matters are divided into "⚠ Warning" and "⚠ Note" two parts. When the wrong installation occur, it is very possible death and severe injury and other serious accidents will happen. For those items are listed in "⚠ Warning" part. But even the items listed in "⚠ Note" part can also cause serious accidents. Above all, both the two parts are very important contents related to safety, so they must be obeyed.
- After finishing the installation work, do test run to verify everything is normal. After that please explain the using and maintenance methods to the user. Additionally, give this installation manual and operation manual to the user and ask them to keep it properly.

⚠ Warning

- The distributing shop, where you bought the air conditioner, or the specified shops shall do the installation work. If you do the installation work by yourself, the improper installation will cause water leakage, electric shock fire and other accidents.
- The installation work shall be in line with what the installation manual specified. If installation is not proper, water leakage, electric shock, fire and other accidents will occur.
- Install the air conditioner to a place where can definitely stand its weight. Places not firm enough will cause drop down of unit resulting in body hurt.
- The installation work shall be preventive to typhoon and earthquake. If the installation work is not met with the requirements, overturn of the unit will occur resulting in accidents.
- The wiring work shall be done by a qualified person and referred to the "technical standard of electric equipment", "indoor wiring regulation" and what the manual specified. Do use special circuit. If the capacity of the circuit is not enough or bad work, electric shock, fire and other accidents will happen.
- Using the specified cable to do wiring work and connecting firmly and properly. Fix the connecting part of the terminals to prevent it from the external force. Improper connection and fixing will cause heating and fire etc. accidents.
- Wiring shall be kept in correct shape avoiding extrusion. After installation, the electric box cover and the external panel shall not nip the wire. Improper installation will cause heating and fire etc. accidents.
- When setting or moving the air conditioner do not let the air and things alike get into the refrigeration system except the specified refrigerant (R22). If air and other things enter, abnormal high pressure will occur, which easily cause break and body injuries etc. Accidents.
- When installing, do use the accessories or specified parts. If not using the parts specified by our company, water leakage, electric shock, fire and refrigerant leakage will occur.
- Do not lead the drainpipe to drain where the sulfur gas may be involved. Otherwise, the poisonous gas will enter into the indoor.
- During installation, if refrigerant leakage occurs, do the ventilation work immediately. As soon as the refrigerant gas meets fire, poisonous gas will be produce. If the refrigerant gas enters into room and meet the air blowing heater, heater or stove etc. fire source, the poisonous gas may be produced. After installation, confirm there is no leakage of refrigerant.
- Do not install the unit in a place where the combustible gas may be leaked. In any case the combustible gas leaks and accumulated around the unit, fire accident will occur.
- Do heat insulation work to the refrigerant gas pipes and liquid pipes to reach the purpose of heat preservation. If the heat insulation measure is not sufficient, water generated by condensing dew will drip leading to wet the floor and indoor articles.

⚠ Note

- Do grounding work. Do not connect the grounding wire to gas pipe, tap, lighting rod or telephone line. Improper grounding will cause electric shock.
- After electric installation, power on them to do electric leakage test.

Installation Precautions

⚠ Attention

This description does not address to all possible cases. For new requirement and query, please consult the regional sales center of Haier Air Conditioner General Co., Ltd.

⚠ Warning

This instruction manual must be read carefully before beginning of installation, improper installation may cause accidents and thus bring about machine damage and personal casualty.

Installing tools

- | | | |
|--------------------------------|------------------|------------------------------------|
| 1. Screw driver | 6. Pipe cutter | 10. Leakage detector or soap water |
| 2. Hacksaw | 7. Pipe expander | 11. Measuring tape |
| 3. Driller of 70mm diameter | 8. Knife | 12. Scraper |
| 4. Spanner (diameter 17, 27mm) | 9. Pinchers | 13. Refrigeration oil |
| 5. Spanner (14, 17, 19, 27mm) | | |

Electrical requirements

- The power supply shall be connected from the outdoor side. (For models with electric-aided heating function, the power supply to the indoor unit shall be connected at the indoor side. The power cord size is 3 G(1.0-1.5)mm², type of H05RN-F).
- A separate power circuit shall be supplied and connected by a qualified electrician according to the wiring rules specified in the corresponding national standard.
- A current leakage breaker must be installed.
- The connection method of power cord is " Y " type. If the power flexible cord is damaged, it shall be replaced by the manufacturer or its service department or similar qualified technician so as to avoid risks.
- Power cord plug: L should be connected to the live wire, N should be connected to the neutral wire and ⊕ to the ground wire.
- Connection wire size: 3 G (1.0-1.5) mm², type of H05RN-F.
- Signal transmission wire size:H05RN-F 2 x (0.75-1.5) mm² (shielded wire).
- Power cord, connection wire and signal wire shall be provided by the user.

Indoor unit

1. Select suitable places the outlet air can be sent to the entire room, and convenient to lay out the connection pipe, connection wire and the drainage pipe to outdoor.
2. The ceiling structure must be strong enough to support the unit weight.
3. The connecting pipe, drain pipe and connection wire shall be able to go though the building wall to connect between the indoor and outdoor units.
4. The connecting pipe between the indoor and outdoor units as well as the drain pipe shall be as short as possible. (See Figure 1)
5. If its necessary to adjust the filling amount of the refrigerant, please refer to the installation manual attached with the outdoor unit.
6. The connecting flange should be provided by the user himself.
7. The indoor unit have 2 drainage outlet, one outlet be jamed with rubber cap, during installation only use another outlet (In/Out liquid pipe side). When necessary, use the two outlet at the same time.
8. Not place the TV., equipment, facility, piano etc, expensive goods below the AC, prevent the water dropping down from the AC and lead to damage to the goods.

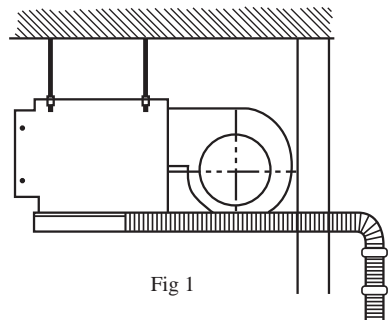

Installation Procedure

After selecting the unit installation location, proceed the following steps:

1. Drill a hole in the wall and insert the connecting pipe and wire through a PVC wall-through tube purchased locally. The wall hole shall be with a outward down slope of at least 1/100. (See Figure 2)
2. Before drilling check that there is no pipe or reinforcing bar just behind the drilling position. Drilling shall avoid at positions with electric wire or pipe.
3. Mount the unit on a strong and horizontal building roof. If the base is not firm, it will cause noise, vibration or leakage (see Figure 6).
4. Support the unit firmly.
5. Change the form of the connection pipe, connection wire and drain pipe so that they can go through the wall hole easily.

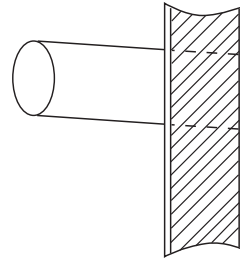
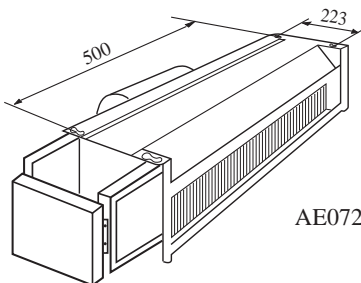
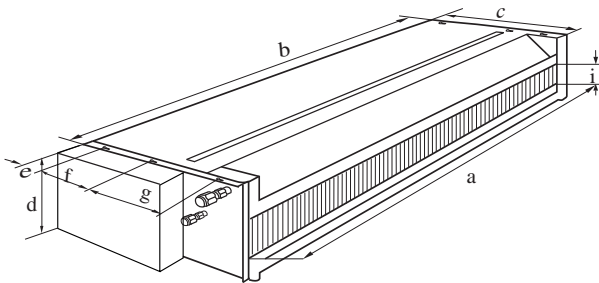

Fig 2

Figure showing installation dimensions: (unit:mm)

Model	a	b	c	d	e	f	g	i
AE092FCAKA	615	648	452	225	55	125	225	100
AE122FCAKA AE142FCAKA	770	804	452	225	55	125	225	100
AE182FCAKA AE212FCAKA	990	1024	452	225	55	125	225	100



AE072FCAKA

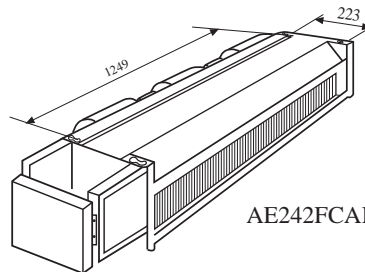

AE242FCAKA

Notes

1. For electrical heating unit, the air outlet not allowed directly connecting with canvas etc. easy catching fire goods.
2. This series' indoor unit are all middle static pressure(30 Pa external static pressure).
3. An access port must be provided during installation of indoor unit for maintenance.

Installation Procedure

Installation of indoor unit

- When installing the ceiling concealed type indoor unit, a specially designed return air bellows shall be installed, as shown in Figure 3, Figure 4.

Figure 3

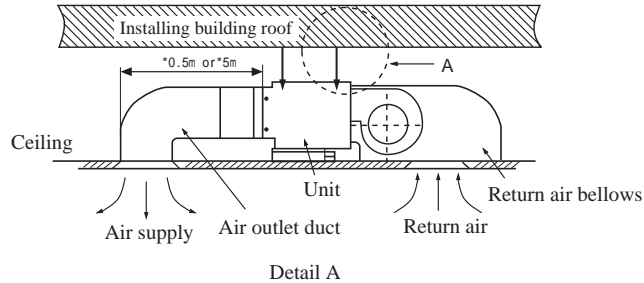

Detail A

Figure 4

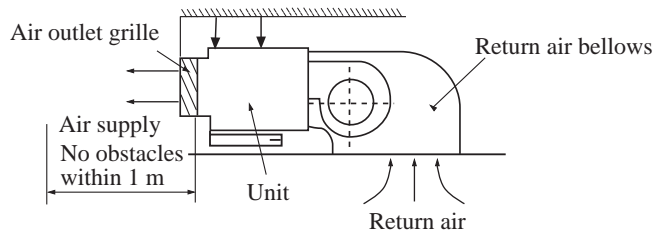

- Each air return and supply duct should fix to the floor precast slab by using an iron stand. Use glue to seal the interface closely. Recommend the distance between the air return duct and the wall is more than 150mm.
- The distance between air duct outlet and air conditioner outlet is according to the length of actually installed air duct and in service behavior of the static pressure terminal: Installation sketch map for long and short air duct is showed below, when connect to short air duct, using low static terminal (terminal color is write), the distance between air duct outlet and air conditioner outlet is no more than 0.5m; when connect to long air duct, using middle static terminal (terminal color is red), the distance between air duct outlet and air conditioner outlet could be within 5m at this point.

Figure 5

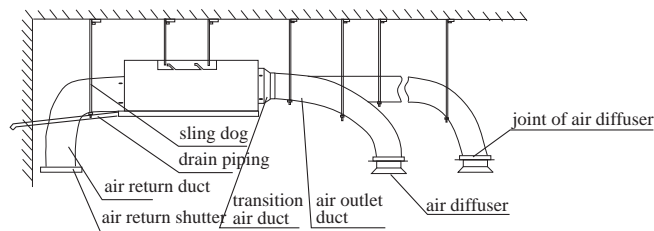

- Drain piping of condensed water should keep a downhill grade of 1% or more. Use insulating pipe to cover the drain piping of condensed water to keep warmth.
- As figure shown, suspend and install the unit.

Figure 6

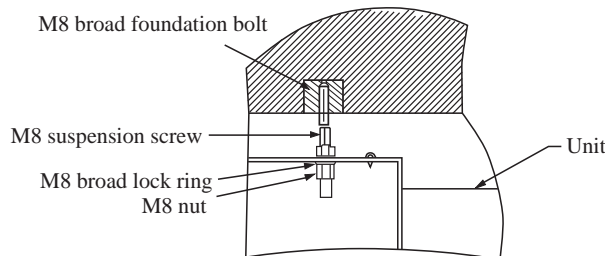
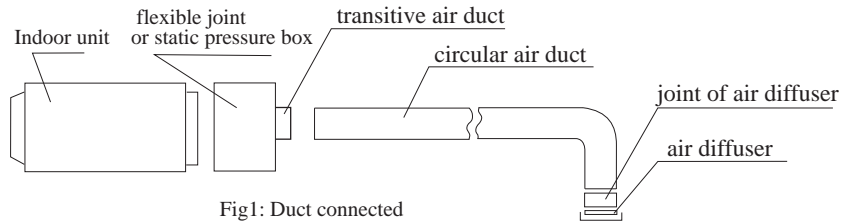

Figure 5

Installation for air duct of indoor unit

1. Installation for air supply duct

- This type of unit uses circular air duct with its caliber of 180mm.
- An additional transitive air duct is necessary for the circular air duct to connect to the air supply inlet. It should be also connected to its respective air diffuser separately. See Fig.1. Adjust the wind speed of each air diffuser outlet to keep in line on the whole, so as to meet a demand of the air conditioner in the room.



2. Installation for air return duct

- Use rivets to connect the air return duct to the air return inlet of the indoor unit. The other end connects to the air return shutter. as shown in Fig.2.

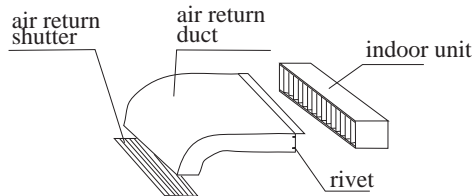

3. Air duct insulation

- Insulation layer is needed for air supply and return duct. First, paste a glue nail to the air duct, and then attach the insulating cotton that has a tinfoil layer and use the glue nail cover to fix. Finally, seal the air duct interface with tinfoil adhesive tape closely. as shown in Fig3.



Installing the suspension screw:

Use M8 or M10 suspension screws (4, prepared in the field) (when the suspension screw height exceeds 0.9 m, M10 size is the only choice). These screws shall be installed as follows with space adapting to air conditioner overall dimensions according to the original building structures.

Wooden structure

A square wood shall be supported by the beams and then set the suspension screws.

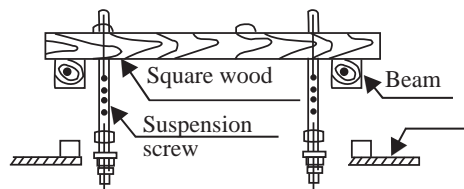

New concrete slab

To set with embedded parts, foundation bolts etc.



Knife embedded part



Guide plate embedded part

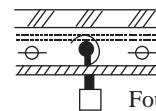

Iron reinforcement
Foundation bolt

Pipe suspension foundation bolt

Original concrete slab

Use hole hinge, hole plunger or hole bolt.

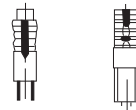

Steel reinforcement structure

Use steel angle or new support steel angle directly.

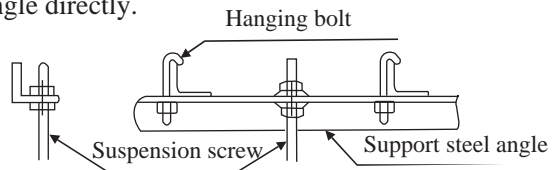

Hanging of the indoor unit

- 1 Fasten the nut on the suspension screw and then hang the suspension screw in the T slot of the suspension part of the unit.
- 1 Aided with a level meter, adjust level of the unit within 5 mm.

Installation Procedure

Installation of remote controller

1. Remove upper cover of wire controller

Remove upper part of wire controller by press.

PCB is mounted on lower part of wire controller, be careful not to damage it.

2. Install the wired remote controller

Please drill two holes on the wall according to the back cover screw hole position of the wire remote controller, then strike the wood block to the holes respectively, then align the 2 screw hole of the wire controller back cover to the wood block, fasten the wire remote controller to the wall use wood screws.

3. Switch setting

The switches setting as follows: 1.ON 2.OFF 3.ON 4.OFF

Note

Try as far as possible a flat surface for installation. Don't use excessive force when tightening screws, or lower part might get deformed.

4. Connecting method as the following chart

No	Symbol	colour	contents
1	A	White or Green	12V
2	B	Red	Gnd
3	C	Yellow	COM
4	D	—	—

- Use shielded wires for telecommunication between wire controller and indoor unit; indoor unit and outdoor unit. Ground the shield on one side. Otherwise misoperation because of noise may occur.
- Signal wire is self-provided by user.

5. Replace the upper cover of wire controller

Be careful not to hold down the wiring.

- Hint**
1. Power supply switch and signal wire should be prepared by the user.
 2. Don't touch PCB with hand.

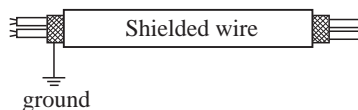
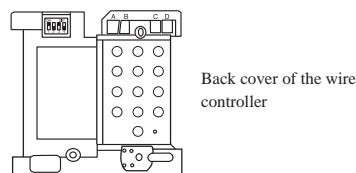
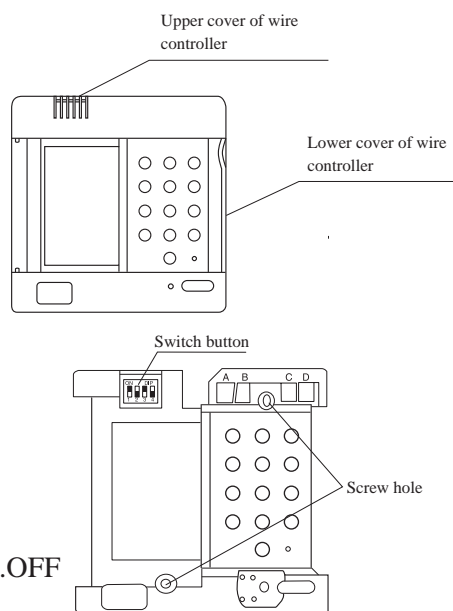

Installation Procedure

Installing the Receiver and MP3 equipment MP3

Installation of receive display

Because of the temperature sensitive device, do not install the receive display at straight sunlight place, either in front of air outlet grill, for it is effected greatly from cool air and heat air, the receive display is at least 20mm distance to the air outlet grill.

Since there is light sensitive device which receives wireless remote signal, so do not installed behind the window curtain or other obstacles, in order not to obstruct the signal.

Must fix the remote control wire far from strong electricity (such as the wiring of electric light, air conditioner, etc.) and weak electricity (such as the wiring of telephone, interphone, etc.).

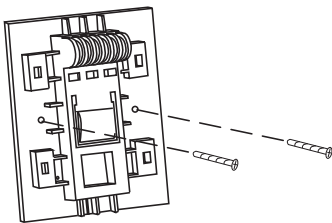

1. Fix the receive display with screws on the selected place

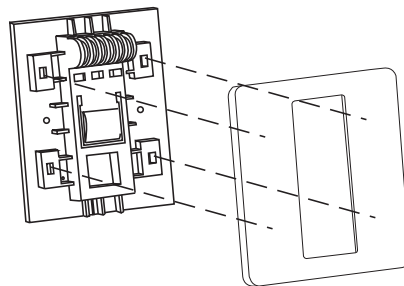

2. Place the panel onto the fixed frame, pay attention that the four claws must be placed into the corresponding four poles on the frame

Connecting wiring method of receiver :

- Refer the indoor unit wiring diagram .
- safety cautions see the electrical wiring part .

Installation Procedure

Drain pipe

⚠ Caution

- In order to drain water normally, the drain pipe shall be processed as specified in the installation manual and shall be thermal insulated to avoid dew generation. Improper hose connection may cause indoor water leakage.

Requirements

- The indoor drain pipe shall be thermal insulated.
- The connection part between the drain pipe and the indoor unit shall be insulated so as to prevent dew generation.
- The drain pipe shall be slant downwards (greater than 1/100). The middle part shall not be of S type elbow, otherwise abnormal sound will be produced.
- The horizontal length of the drain pipe shall be less than 20 m. In case of long pipe, supports shall be provided every 1.5 ~ 2m to prevent wavy form.
- Central piping shall be laid out according to the following figure.
- Take care not to apply external force onto the drain pipe connection part.

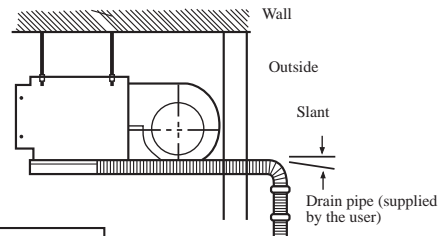
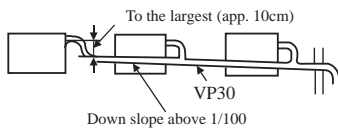
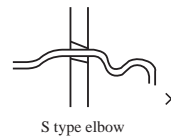
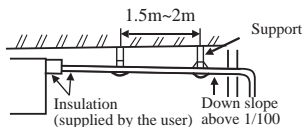

Pipe and insulation material

Pipe	Rigid PVC pipe VP31.5mm (internal diameter)
Insulation	Foamed PE with thickness above 7mm

Hose

Drain pipe size: $\varnothing 19.05\text{mm}^2$ (3/4") PVC pipe

The hose is used for adjusting the off-center and angle of the rigid PVC pipe.

- Directly stretch the hose to install without making any deformation.
- The soft end of the hose must be fastened with a hose clamp.
- Please apply the hose on horizontal part

Insulation treatment:

- Wrap the hose and its clamp until to the indoor unit without any clearance with insulating material, as shown in the figure.

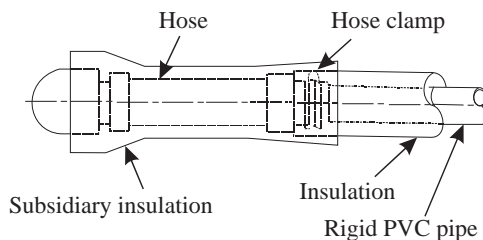

Drain confirmation

During trial run, check that there is no leakage at the pipe connection part during water draining even in winter.

Installation Procedure

Refrigerant piping

Allowable pipe length and drop

These parameters differ according to the outdoor unit. See the instruction manual attached with the outdoor unit for details.

Pipe material and size

Pipe material	Phosphorus deoxidized copper seamless pipe (TP ₂ M) for air conditioner			
Model		AE072FCAKA AE092FCAKA	AE122FCAKA AE142FCAKA	AE182FCAKA AE212FCAKA AE242FCAKA
Pipe size (mm)	Gas side	∅ 9.52	∅ 12.70	∅ 15.88
	Liquid side	∅ 6.35	∅ 6.35	∅ 9.52

Supplementary refrigerant

The refrigerant supplementation shall be as specified in the installation instructions attached with the outdoor unit. The added refrigerant shall be R22.

The adding procedure shall be aided with a measuring meter for a specified amount of supplemented refrigerant

Requirement

Overfilling or underfilling of refrigerant will cause compressor fault. The amount of the added refrigerant shall be as specified in the instructions.

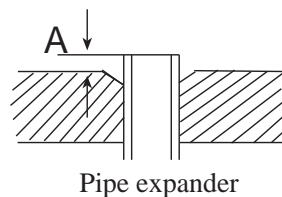

Connection of refrigerant pipe

Conduct flared connection work to connect all refrigerant pipes.

Pipe cutting and expanding

If the pipe is too long or the flare is damaged, it needs to be cut or expanded.

Pipe expansion dimensions as follows:





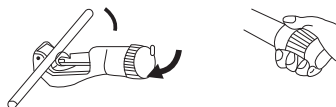

Pipe diameter ∅	Size A (mm)
6.35 mm (1/4")	0.8 ~ 1.5
9.52 mm (3/8")	1.0 ~ 1.8
12.7 mm (1/2")	1.2 ~ 2.0
15.88 mm (5/8")	1.4 ~ 2.2

1. Pipe cutting
2. Removing burrs



3. Insertion nut
4. Pipe expansion



Correct	Incorrect				
					
	Slope	Damage	Bur	Partial	Overlong

- The connection of indoor unit pipes must use double spanners.
- The installing torque shall be as given in the following table.

Connecting pipe O.D.(mm)	Installing torque (N-m)	Increased installing torque (N-m)
∅ 6.35	11.8 (1.2kgf-m)	13.7 (1.4 kgf-m)
∅ 9.52	24.5 (2.5kgf-m)	29.4 (3.0 kgf-m)
∅ 12.70	49.0 (5.0 kgf-m)	53.9 (5.5 kgf-m)
∅ 15.88	78.4 (8.0 kgf-m)	98.0 (10.0 kgf-m)

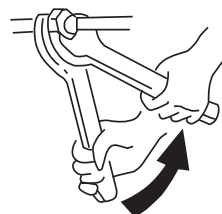

Double-spanner operation

Vacuum pumping

With a vacuum pump, create vacuum from the stop valve of the outdoor unit.

- 1 Emptying with refrigerant sealed in the outdoor unit is absolutely forbidden.

Open all valves

Open all the valves on the outdoor unit.

Gas leakage detection

Check with a leakage detector or soap water that if there is gas leakage at the pipe connections and bonnets.

Insulation treatment

Conduct insulation treatment on both the gas side and liquid side of pipes respectively.

During cooling operation, both the liquid and gas sides are cold and thus shall be insulated so as to avoid dew generation.

- 1 The insulating material at gas side shall be resistant to a temperature above 120*.
- 1 The indoor unit pipe connection part shall be insulated.

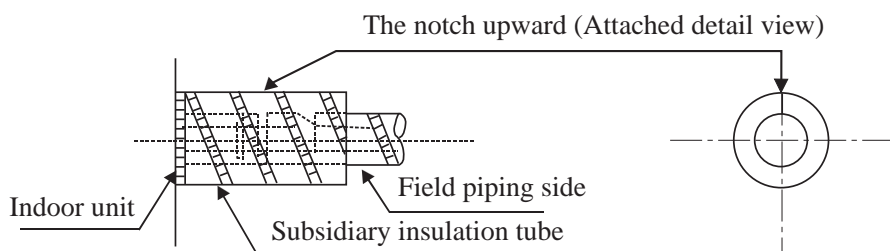

⚠ Warning



- The electric wiring work shall be conducted by qualified electricians according to the installation instructions. A separate power circuit shall be used. Insufficient power cord amperage or improper wiring will cause danger of electric shock or fire.
- During wiring connection, the power cord shall be of the specified cable and reliably fastened so that external forces applied to the cable wouldnt transfer to the terminals. Improper connection or fastening will cause danger of heating, fire etc. The power cord must be fitted with a grounding wire.
- Grounding shall be made as specified. Unreliable grounding will cause electric shock. The grounding wire shall not be connected to the gas pipeline, water pipeline, thunder arrestor and telephone wire

⚠ Caution



- A current leakage breaker shall be installed, otherwise it electric shock would happen easily.
- If the power cord is damaged, it must be replaced by the manufacturer or its service center or similar personnel to avoid risks. The power supply to the indoor unit shall be laid in complying with the operational instruction manual.
- The electric wiring shall avoid contacting with the high temperature part of the piping so as to prevent the cable insulation melts and cause dangers.
- After connected on the terminal block, the wires shall be bent to U form and then fastened with wire clip.
- The control wiring and refrigerant piping may be laid and fastened together.
- Before completion of vacuum pumping of the refrigerant pipe system, do not electrify the indoor unit.
- The power cord of the indoor unit and connection wiring between indoor and outdoor units shall be laid out according to the operational instruction manual of the indoor unit.
- The connection of the power cord shall comply with the local regulations.
- The power supply wiring connection should meet the local regulation.

Wiring connection method : (the wiring diagram is attached inside the machine)

1) Ring terminal connection method

If there is a ring at the end of the connection wire, the wire connection method is as shown in the right figure. Remove the terminal screw and insert it through the ring at the connection wire end, then connect to the terminal board and fasten the screw.

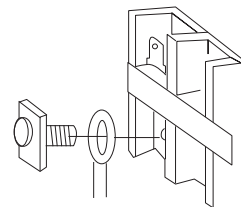

Connection method for ring terminal

2) Straight terminal connection method

If there isnt a ring at the end of the connection wire, the connection method shall be: loosen the terminal screw, insert the connection wire end completely into the terminal board and fasten the screw. Pull the connection wire outwards slightly to confirm it is clamped tightly.

3) Clamping method of the connection wire

After wire connection is finished, the connection wire must be pressed tightly with wire clips, which shall apply to the outer sheath of the connection wire.

Wire connection for built-in indoor unit

- Insert from outside the connection wire and signal transmission wire through the wall hole with pipeline already arranged.
- Pull out the front ends of connection wire and signal wire and make a circle on the signal wire.
- Connect the connection wire according to the connection method and indoor and outdoor wiring diagram.
- Pull the connecting conductor outwards slightly to confirm it is clamped tightly.
- Connect the plug for connecting the signal wire with the plug of the signal wire connected from the indoor unit.
- After wire connection is finished, install wire clips using the same method for connection wire clamping.

Note: When connecting the indoor unit and the outdoor unit, please do connect the wires with the same color terminals.

Notes:

- Before connecting the conductors between indoor unit and outdoor unit, check for the number on the indoor and outdoor units connecting terminals. Connect the terminals with the same color and number with a wire.
- Wrong connection would damage the controller of the air conditioner or the machine couldnt operate.
- Do not connect the connection wire and signal wire with the same cable. They shall be connected respectively to ensure system normal operation.

Field setting

Field setting the unit number

In order to realize central control of the MRV air conditioning system, its necessary to set the indoor unit number (control address).

Indoor unit number setting

Indoor unit number setting switch and confirmation of the settings.

There is a 4-position dial switch for setting the indoor unit number on the computer board of the indoor unit.

Setting way is as follows:

Before connecting the power supply, please set the indoor unit number manually according to the following table

Matrix of the dial switch and indoor unit number

Position 1	Position 2	Position 3	Representing unit number
0	0	0	1
1	0	0	2
0	1	0	3
1	1	0	4
0	0	1	5
1	0	1	6

Example:

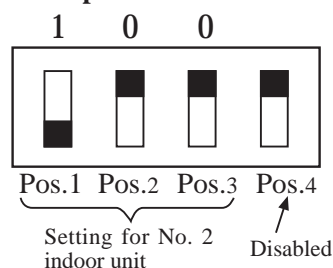

Malfunction

Indoor unit malfunction display code

Indoor unit malfunction	Display code
Float switch or water motor abnormal	E0
Outdoor unit abnormal	E1
Setting running mode is different with outdoor running mode	E2
Liquid temperature sensor is abnormal	E3
Gas temperature sensor is abnormal	E4
The communication between indoor 846 chip and communication chip is abnormal	E5
The communication with electronic expansion box is abnormal	E7
The communication between the wire remote controller and indoor unit control board is abnormal	E8
The communication between indoor and outdoor unit is abnormal	E9
Water temp. sensor is abnormal	EB

Outdoor unit malfunction display code

(When the wire remote controller display E1, can check the indoor unit control board LED1 or the outdoor unit control board LED1 Outdoor unit control board LED (ALARMA or ALARMB)).

Outdoor unit malfunction	LED flashing times
Outdoor unit defrost temp. sensor is abnormal	flashing once
Outdoor unit environment temp. sensor is abnormal	flashing twice
Outdoor unit suction temp. sensor is abnormal	flashing 3 times
Outdoor unit discharge temp. sensor is abnormal	flashing 4times
Outdoor unit AC over-current protection	flashing 6times
Outdoor unit DC voltage is insufficient protection	flashing 7times
IPM protection	flashing 9times
Outdoor unit EEPROM abnormal	flashing 10times
Compressor Discharge temperature overheat protection	flashing 11times
The communication between outdoor unit 857 and communication chip is abnormal	flashing 12times
Outdoor unit system over-high pressure protection	flashing 13 times

Malfuction

Remote controller Timer and Operation indicator malfunction code

When the unit running, Timer indicator flash stand for indoor unit malfunction
operation indicator flashing stand for outdoor unit malfunction

1. Indoor unit malfunction

Timer indicator Flashing times	Indoor unit malfunction
Flashing once	The liquid tube temperature sensor is abnormal
Flashing twice	The gas tube temperature sensor is abnormal
Flashing 3 times	The environment temperature sensor is abnormal
Flashing 4 times	The communication with outdoor unit is abnormal
Flashing 5 times	The ommunication with the electronic expansion valve control board is abnormal
Flashing 6 times	The communication between indoor 846 and communication chip is abnormal
Flashing 8 times	PMV strong electricity board is abnormal
Flashing 10 times	Indoor unit PG fan motor is abnormal
Flashing 11 times	Indoor unit water overflow or float switch is abnormal
Flashing 12 times	Indoor unit EEPROM data is abnormal
Flashing 13 times	Indoor unit is overload
Flashing 14 times	The communication between indoor unit and wire remote controller is abnormal

2.Outdoor unit malfunction

Operation indicator flashing times	Outdoor unit Trouble contents
Flashing once	Outdoor unit defrost temp. sensor is abnormal
Flashing twice	Outdoor unit environment temp. sensor is abnormal
Flashing 3 times	ction temperature sensor is abnormal
Flashing 4 times	Outdoor unit discharging temperature sensor is abnormal
Flashing 5 times	Outdoor unit evapor ating temperature sensor is abnormal
Flashing 6 times	Outdoor unit AC over-current protection
Flashing 7 times	Outdoor unit DC voltage is insufficient protection
Flashing 9 times	IPM protection
Flashing 10 times	Outdoor unit EEPROM is abnormal
Flashing 11 times	Compressor discharging temperature overheat protection
Flashing 12 times	The communication between the 857&communication chip is abnormal
Flashing 13 times	Outdoor unit high pressure protection
Flashing 14 times	High pressure sensor PD is abnormal
Flashing 15 times	Low pressure sensor PS is abnormal

Installation check and trial operation

Check if the drain pipe and connection wires are arranged properly.

The drain pipe shall be put below. The connection wire shall be put above. Be sure to wrap the drain pipe (especially the indoor part and the part inside the machine) with thermal insulating materials.

The drain pipe shall be made into slope. Avoid bulging up or down or phenomena shown right figure in the run.

Installation check

- | | |
|---|--|
| <input type="checkbox"/> Are the power cord and the indoor/outdoor connection wire connected properly?
Are the wires pressed firmly? | <input type="checkbox"/> Is there any gas leakage at the pipe joints? |
| <input type="checkbox"/> Do the supply voltage meet the requirement? | <input type="checkbox"/> Is the noise too big? |
| | <input type="checkbox"/> Could the drainage water completely discharged to outdoor |

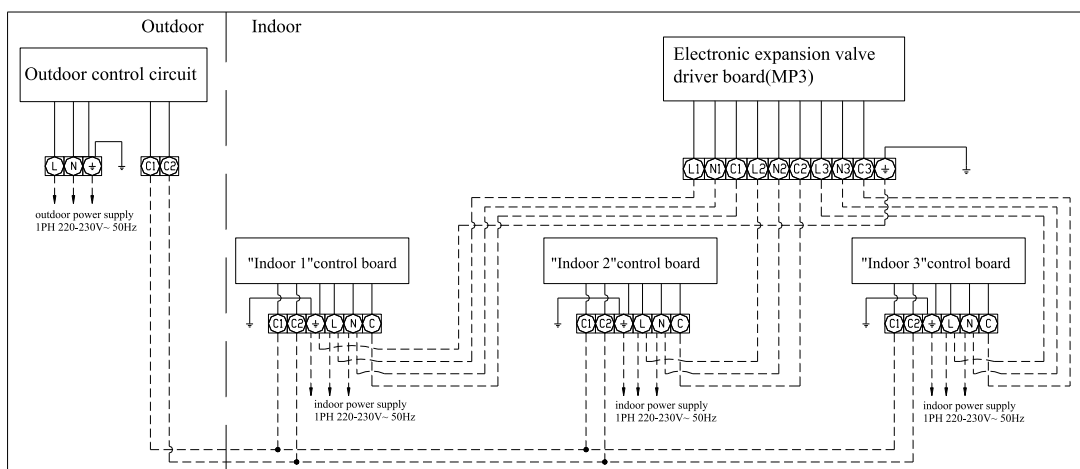

- NOTE
- 1.The power supply and communication wiring of indoor electronic expansion valve must be connected with their corresponding indoor unit.And their phase sequence must correspond with the remarks strictly respectively, or will cause control board of indoor unit and electronic expansion valve box abnormal or damaged.
 - 2.Because the power supply of MP3 control board is joined from "indoor 1","indoor 1" must be always electrified in running mode, or will cause performance abnormal.
 - 3.Parameter of connection wiring: 3 x (1-1.5)mm²;
communication wiring: 2 x (0.5-1.5)mm²shielded wiring ;
MP3 wiring and indoor wiring: 4 x (0.5-1.5)mm²,3x(0.5-1.5)mm².

- Do the terminal numbers of the indoor/outdoor connection wire coincide with each other?
Is the pipe connection part thermally insulated?
Is the indoor unit mounted firmly and reliably?

Trial operation

The installation serviceman must conduct a trial operation and check:

- Does the temperature regulator work normally?
 Does the installation location selection meet the related requirements?

Wrap with the protective plastic tape

Wrap the connection pipe, the drain pipe and the connection wire together with PVC tape.

Caution:

The connection pipe must be wrapped individually with insulating material from down to up.

Free Manuals Download Website

<http://myh66.com>

<http://usermanuals.us>

<http://www.somanuals.com>

<http://www.4manuals.cc>

<http://www.manual-lib.com>

<http://www.404manual.com>

<http://www.luxmanual.com>

<http://aubethermostatmanual.com>

Golf course search by state

<http://golfingnear.com>

Email search by domain

<http://emailbydomain.com>

Auto manuals search

<http://auto.somanuals.com>

TV manuals search

<http://tv.somanuals.com>